



LG Electronics Inc.



Washing Machine

OWNER'S MANUAL

**MODELS : WT-R1071TP
WT-R1371TP
WT-R1172TP
WT-R1372TP**

Please read this manual carefully before operating your washing machine.

Retain it for future reference.

Record model name and serial number of the washing machine.

Quote this information to your dealer if you require service.

Product Features



The Turbo Drum DD washing machine does not operate with the lid open. If the lid is opened during wash, rinse and spin cycles, the machine will stop automatically.

Fuzzy Logic Control

- A built-in load sensor automatically detects and measures the laundry load and a microprocessor optimizes washing conditions such as ideal water consumption and washing time.
- Advanced technology is built into the Electronic Control System which ensures the best washing result.



Turbo Drum DD washing

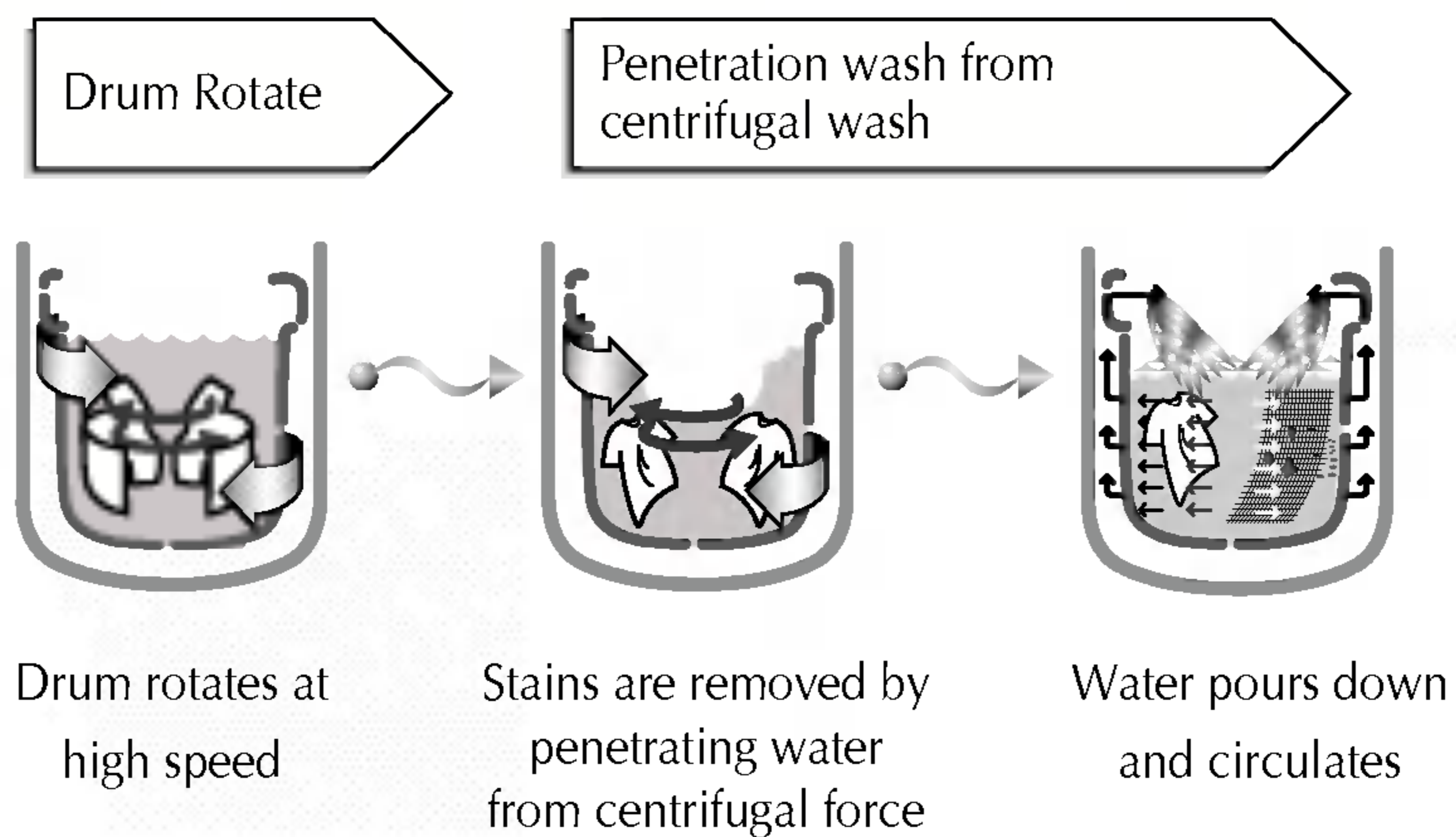

Low Noise Direct Drive System

- The advanced Brushless DC motor rotates the Tub directly without belt and clutch, thereby reducing the noise of the washer.
- The washing machine adjusts to optimum speed according to the type of clothing in the load.



Fully Stainless Steel Washing Tub

- Indentations on the stainless steel washing tub combined with the movement of the water whirls gently rub the laundry and improving washing efficiency.

C ontents

Read this manual

Inside you will find many helpful hints on how to use and maintain your washer properly. Just a little preventive care on your part can save you a great deal of time and money over the life of your washer. You will find many answers to common problems in the Troubleshooting section. If you review our chart of Troubleshooting Tips first, you may not need to call for service at all.

Introduction	Important Safety Information	4
	Identification of Parts	5
Before Starting to Wash	Preparation Before Washing	6
	Water Level Temperature	7
	Use of Detergent, Bleach and Softener	8
	Function of each Button	10
Washing Programs	Delicate Wash	12
	Wool Wash	12
	Normal wash	12
	Speedy Wash	12
	Jean Wash	12
	Soak Wash	12
Additional Function Options	Option Washing Method	14
	Delay Start Wash	15
	Other Useful Functions	16
Installation	Placing and Leveling	17
	Connecting Water Supply Hose	18
	Connecting Drain Hose	19
	Grounding Method	20
Care and Maintenance	Cleaning	21
Troubleshooting	Troubleshooting	23
Specification	Specification	26

Important Safety Information

READ ALL INSTRUCTIONS BEFORE USE

⚠ WARNING! For your safety, the information in this manual must be followed to minimize the risk of fire or explosion, electric shock, or to prevent property damage, personal injury, or loss of life.

WATER HEATER SAFETY

Under certain conditions hydrogen gas may be produced in a water heater that has not been used for two weeks or more. Hydrogen gas can be explosive under these circumstances.

If the hot water has not been used for two weeks or more, prevent the possibility of damage or injury by turning on all hot water faucets and allowing them to run for several minutes. Do this before using any electrical appliance which is connected to the hot water system. This simple procedure will allow any built-up hydrogen gas to escape. Since the gas is flammable, do not smoke or use an open flame or appliance during this process.

PROPER INSTALLATION

- Install or store where it will not be exposed to temperatures below freezing or exposed to the weather.
- Properly ground washer to conform with all governing codes and ordinances.
- The base opening must not be obstructed by carpeting when the washing machine is installed on a carpeted floor.
- The appliance must be positioned so that the plug is accessible.

YOUR LAUNDRY AREA

- Keep the area underneath and around your appliances free of combustible materials such as lint, paper, rags, chemicals, etc.
- Close supervision is necessary if this appliance is used by or near children. Do not allow children to play on, with, or inside this or any other appliance.
- Keep the washing machine away from fire or heat source.

WHEN USING THE WASHER

- Use this appliance only for its intended purpose as described in this Owner's Manual.
 - Never reach into washer while it is moving. Wait until the machine has completely stopped before opening the lid.
 - Do not mix chlorine bleach with ammonia or acids such as vinegar and/or rust remover. Mixing different chemicals can produce a toxic gas which may cause death.
 - Do not wash or dry articles that have been cleaned in, washed in, soaked in, or spotted with combustible or explosive substances (such as wax, oil, paint, gasoline, degreasers, dry-cleaning solvents, kerosene, etc.) which may ignite or explode. Do not add these substances to the wash water. Do not use or place these substances around your washer or dryer during operation.
 - The laundry process can reduce the flame retardancy of fabrics. To avoid such a result, carefully follow the garment manufacturer's wash and care instructions.
 - To minimize the possibility of electric shock, unplug this appliance from the power supply or disconnect the washer at the household distribution panel by removing the fuse or switching off the circuit breaker before attempting any maintenance or cleaning.
- NOTE:** Pressing Power button to turn off does **NOT** disconnect the appliance from the power supply.
- Never attempt to operate this appliance if it is damaged, malfunctioning, partially disassembled, or has missing or broken parts,
 - Young children should be supervised to ensure that they do not play with the appliance.

WHEN NOT IN USE

- Turn off water faucets to relieve pressure on hoses and valves and to minimize leakage if a break or rupture should occur. Check the condition of the fill hoses; they may need replacement after 5 years.
- Do not attempt to repair or replace any part of this appliance unless specifically recommended in this Owner's Manual, or in published user-repair instructions that you understand and have the skills to carry out.
- Before discarding a washer, or removing it from service, remove the washer lid to prevent children from hiding inside.
- Do not tamper with controls.

Read and follow this Safety Information carefully.

SAVE THESE INSTRUCTIONS

Identification of Parts

Body

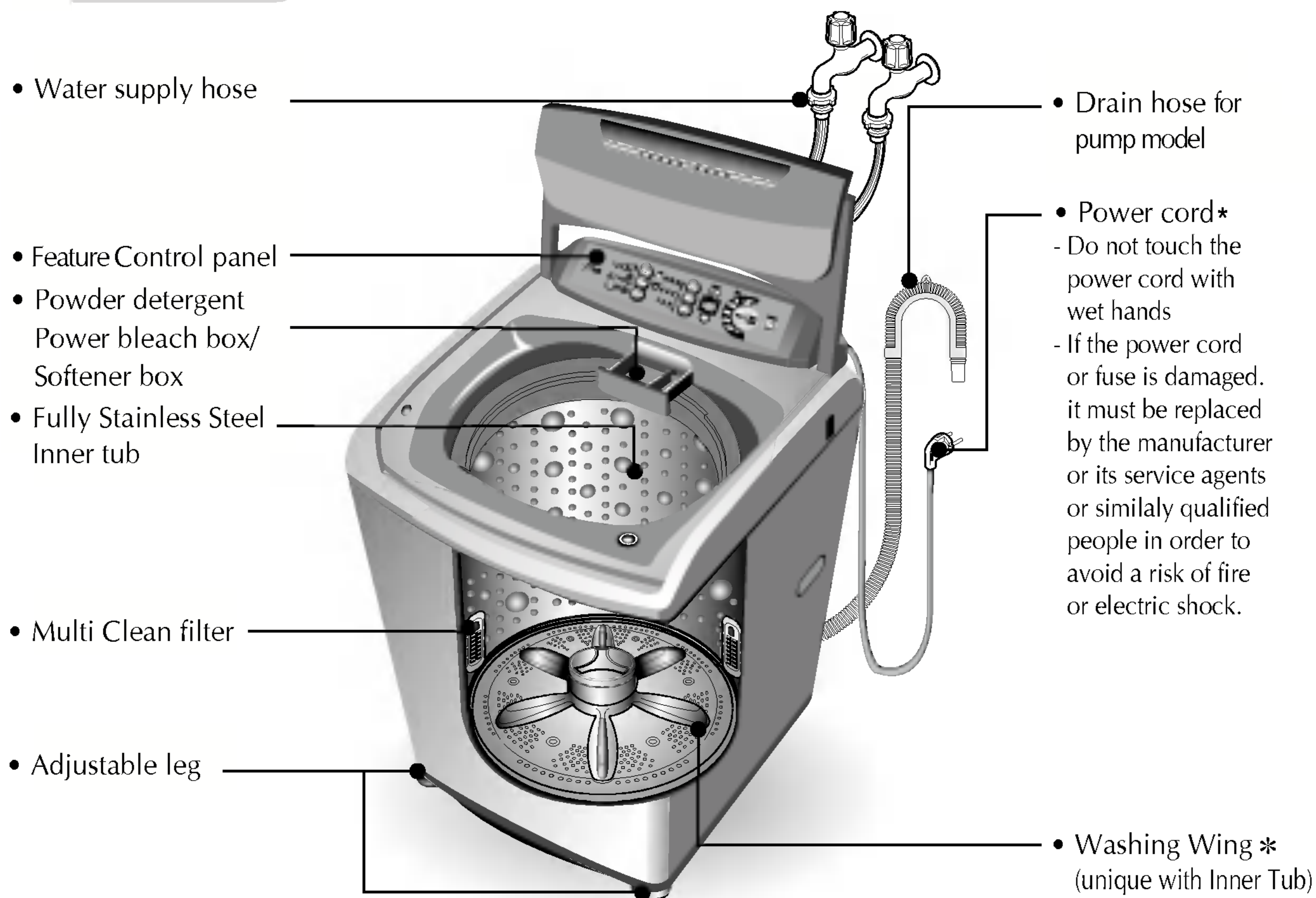

Accessories

Water supply hoses

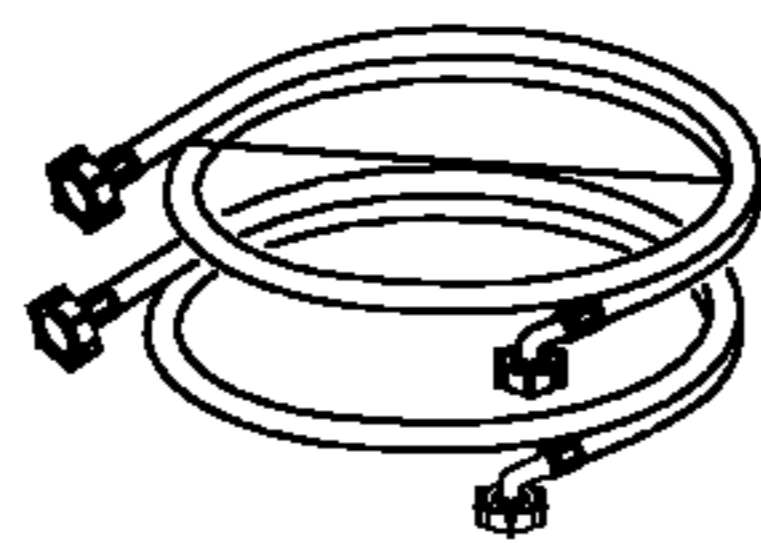

1 Each for cold and hot water

Drain hose

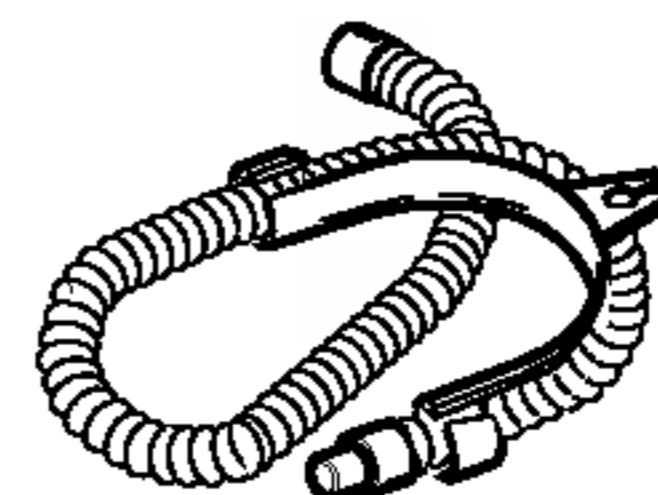

Note

“*” Part can be different according to the model.

Preparation Before Washing

CARE LABELS.

* Look for a care label on your clothes. This will tell you about the fabric content of your garment and how it should be washed.

Sort clothes into loads that can be washed with the same wash cycle, water temperature and spin speed.

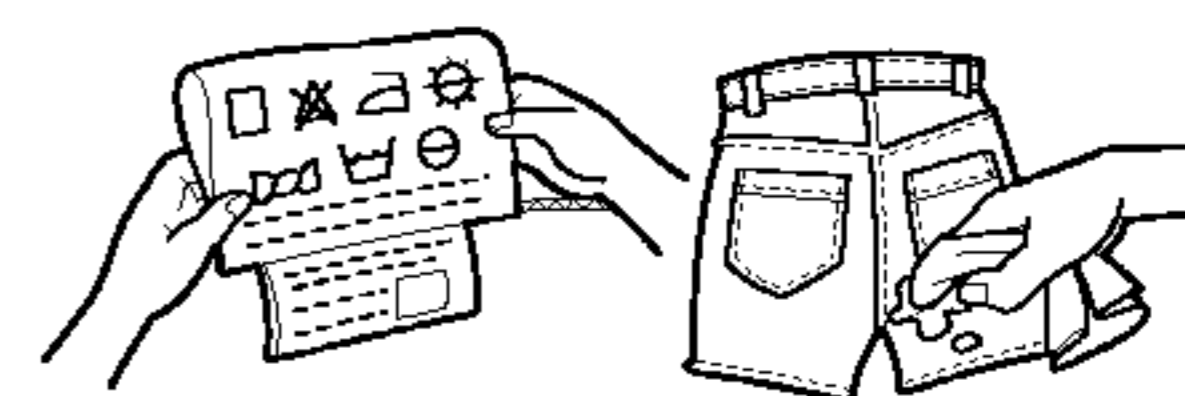

SORTING

To get the best results, different fabrics need to be washed in different ways.

- **SOIL** (Heavy, Normal, Light) Separate clothes according to the type and amount of soil
- **COLOR** (Whites, Lights, Darks) Separate white fabrics from colored fabrics.
- **LINT** (Lint producers, Collectors) Separate lint producers and lint collectors.

Lint Producers
Lint Collectors

Terry cloth, Chenille, Towel, diaper
Synthetics, Corduroy, Permanent Press, Socks

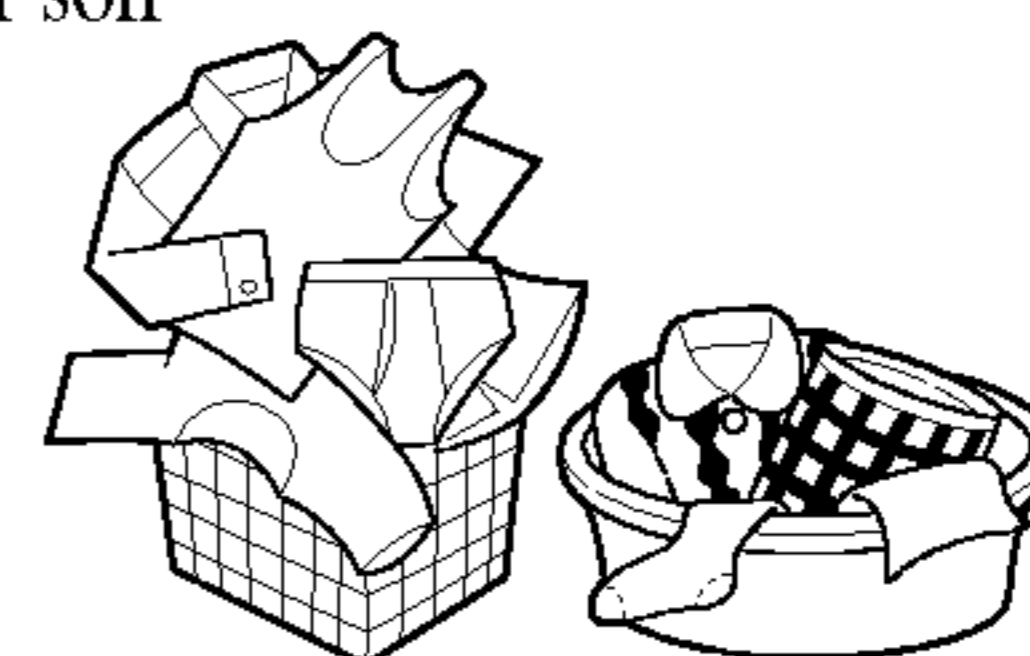

CHECK BEFORE LOADING

- **Check all pockets to make sure that they are empty.** Things such as nails, hairclips, matches, pens, coins and keys can damage both your washer and your clothes.
- **Fasten zippers, hook and strings** to make sure that these items don't snag on other clothes.
- **Mend any torn garments or loose buttons.** Tears or holes may become larger during washing.
- Remove any **loose brassiere wires** as they can damage your washer and clothes.
- **Pretreat any dirt and stains.**
- Make sure the clothes are washable in water.
- Check the washing instructions on your clothes.

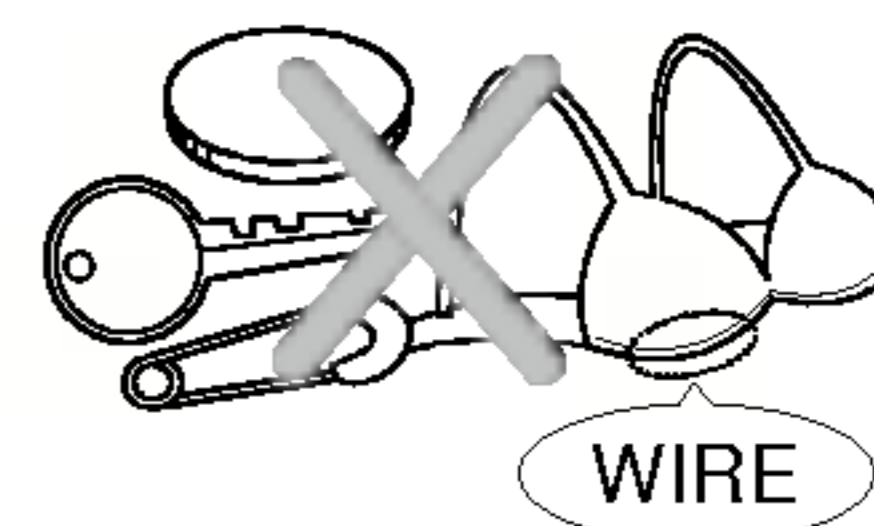

LOADING

Do not wash fabrics containing flammable materials (waxes, cleaning fluids, etc.).

Load Size

The water level should just cover the clothes. Adjust the load size accordingly. Loosely load clothes no higher than the top row of holes in the washer tub. To add items after washer has started, press Start button and submerge additional items. Close the lid and press Start button again to restart.

Light and Large-sized clothing

Clothes including downs and woollens are light weight, large and float easily. So use a nylon net and wash them in a small amount of water.

If the laundry floats during the wash cycle, it may become damaged. Use dissolved detergent to prevent the detergent from clumping.

Long laundry items

Use nylon nets for long, delicate items.

For laundry with long strings or long length, a net will prevent tangling during washing.

Fasten any zippers or hooks on items before washing.

※ Nylon net is not supplied by LG.

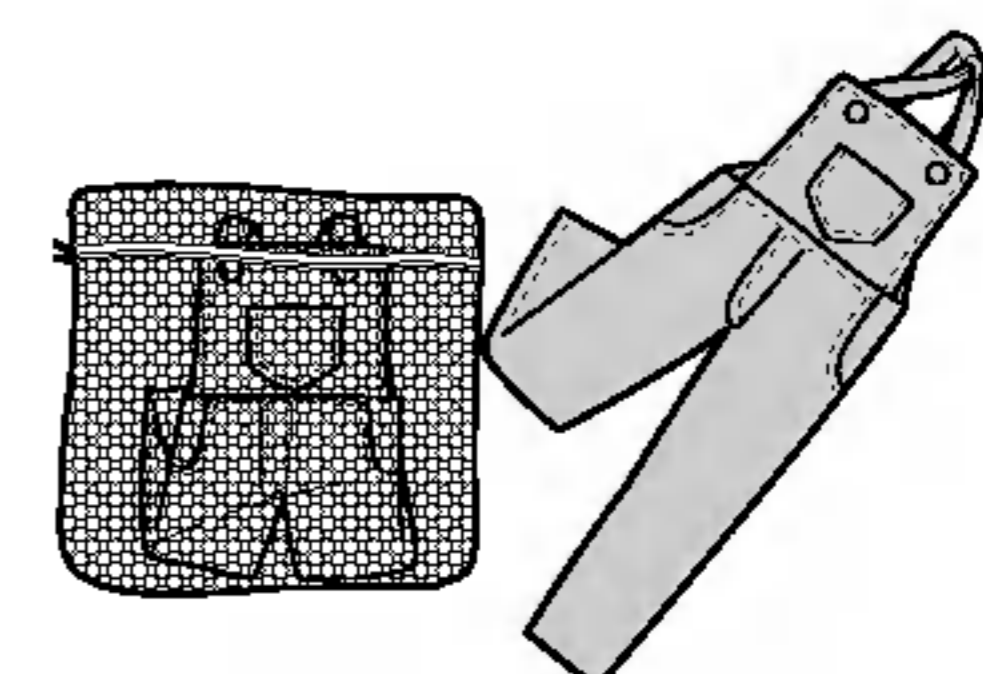
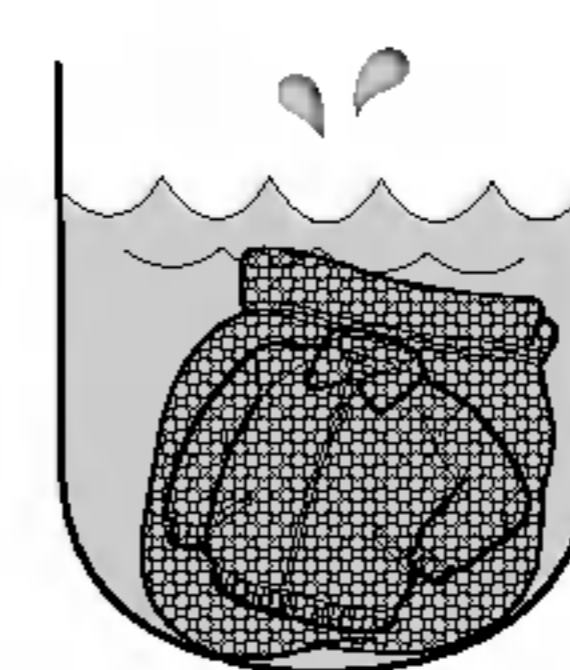

Water Level Temperature

WATER LEVEL

- This machine detects the quantity of laundry automatically, then sets the water level and proper amount of detergent.
- When you select a wash program, the water level and amount of detergent (to be used) will be shown on the control panel.
- When the water level is automatically detected, it may differ depending on the quantity of laundry even though the same water level is indicated on the control panel.

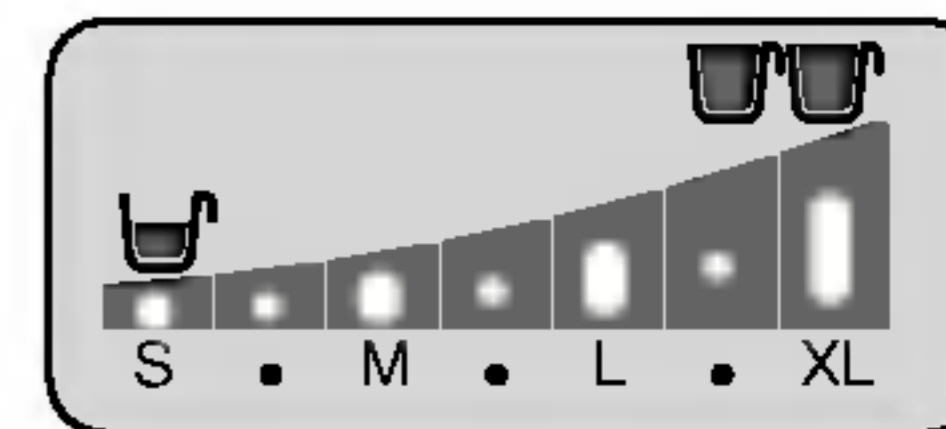

Note

- When a **Wash, Wash/Rinse** or **Rinse** only option is selected, after the wash is completed the water will not be drained off.
- If you wish to drain the water, press the **SPIN** button and wait until the water in the tub has drained completely. Then press the **START/PAUSE** button .
- **If you do not specify the water level**, then Medium will be automatically selected.
- If Rinse only is selected, the process will start from Water Supply.
- The washing machine may occasionally add water while pulsator is rotating. This is to maintain the water level due to the release of air trapped in the garments.

WATER TEMPERATURE

- You can change the water temperature by pressing the **WATER TEMP** button. (Option depending on model).

The temperature of the water impacts the effectiveness of all laundry additives and therefore, the cleaning results. We recommend temperatures of:

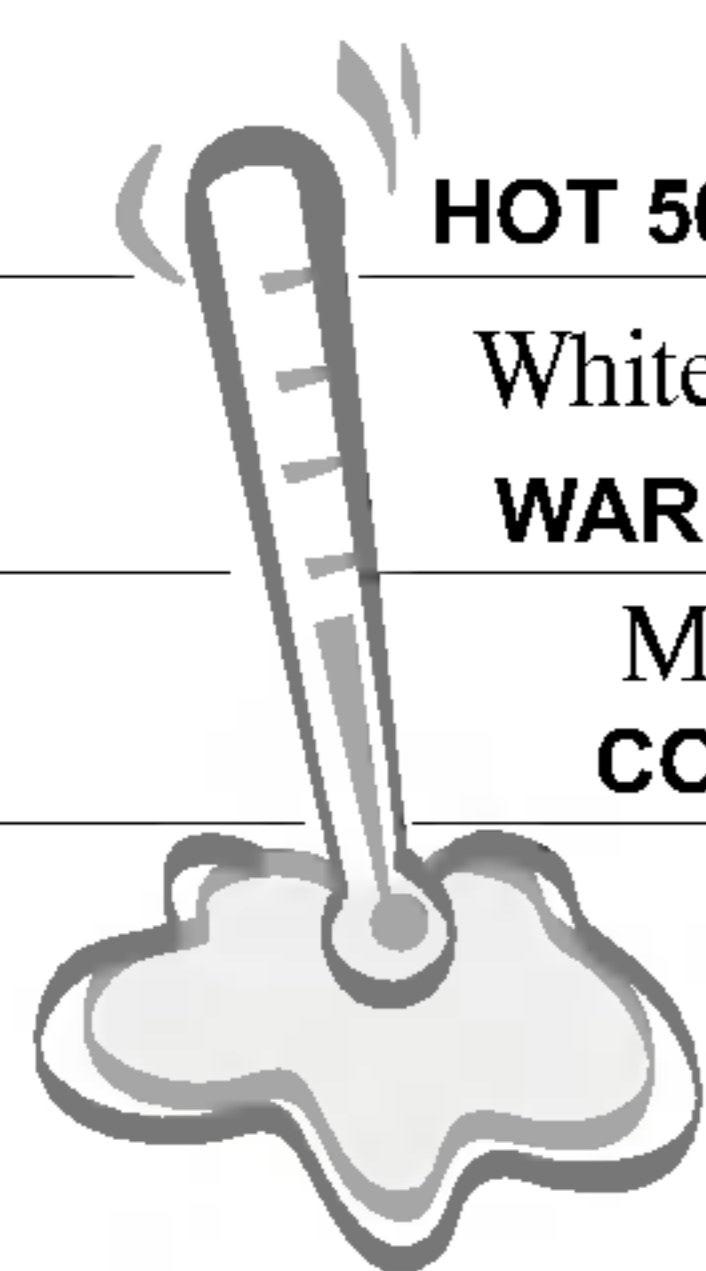

HOT 50~60°C(120~140°F)

White items, diapers, underclothing and heavily soiled, colorfast items.

WARM 30~40°C(85~105°F)

Most items.

COLD * 18~24°C(65~75°F)

Only very bright colors with light soil.

* When washing in cold water additional steps may be needed:

- Adjust detergent amount and pre-dissolve detergent in warm water
- Pretreat spots and stains
- Soak heavily soiled items
- Use appropriate bleach
- Temperature below 18°C (65°F) will not activate laundry additives and may cause lint, residue, poor cleaning, etc. In addition, detergent manufacturers and care labels define cold water as 26~29°C(80~85°F).
- **If the temperature of the water in the tub is too cold for your hands, the detergent will not activate and clean effectively.**

Use of Detergent

CHOOSING THE RIGHT DETERGENT

- We recommend the use of domestic detergent, (powder, liquid or concentrated). Soap flakes or granulated soap powders should not be used in your washing machine. When washing woolens remember to use a detergent suitable for washing woolens.

AMOUNT OF DETERGENT

Follow the detergent package directions. Using too little detergent is a common cause of laundry problems. Use more detergent if you have hard water, large loads, greasy or oily soils or lower water temperature.

The correct amount of detergent will vary depending on the amount of soil in your clothes (Jeans and work clothes may need more detergent, while bath towels usually need less).

For liquid and concentrated detergents, follow the recommendations of the detergent manufacturer.

Note

To check you are using the correct amount of detergent, lift the lid of your machine about half-way through the wash. There should be a thin layer of foam over the surface of the water. Lots of foam may look good, but it does not contribute to cleaning your clothes. No foam means not enough detergent has been used; soil and lint can settle back on the clothes or the washing machine.

Attention

If excessive detergent is used, the rinse will not be as clean and efficient. Also, it could cause environmental pollution, so use it accordingly.

ADDING THE DETERGENT

- Some detergents **MUST** be fully dissolved before adding to your machine to get the best wash results. Check the instructions on the detergent packet.

If you use powder detergent it is essential that the required amount be fully dissolved in very hot water before being added to warm or hot water for the actual wash.

Pre-dissolving detergent in warm water when washing in cold water can improve its performance.

- Open the DETERGENT Box and deposit the appropriate amount of detergent .

Powder Detergent / Powder Bleach dispenser.

Where you
deposit the
detergent

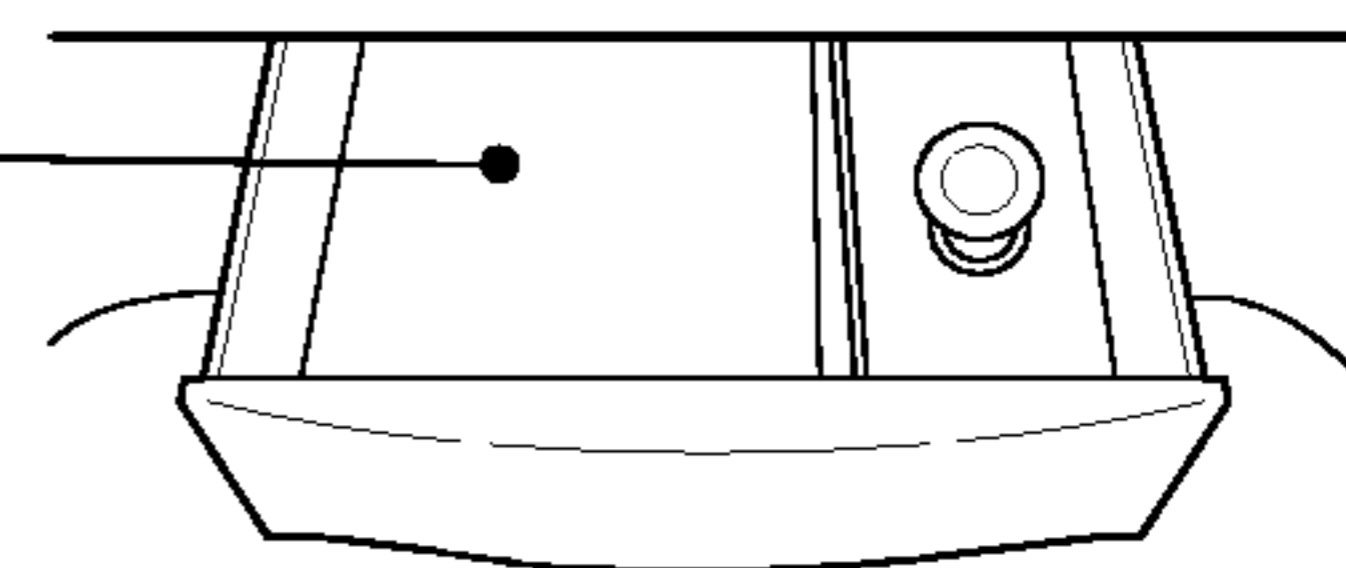

Use of Softener and Bleach

Using Softener

AVAILABLE FABRIC SOFTENER TYPE

- Do not use concentrated fabric softener. This may cause some problems in automatic dispensing.
- For more details refer to the softener products instructions for use.

DEPOSITING FABRIC SOFTENER



- Don't use softener with detergent. Use softener in last rinse water
- When using dispenser, dilute softener(30ml) with fresh water(30ml)
- When filling dispenser, do not splash or overfill. It may stain clothes.
- Never pour fabric softener directly on clothes. It may stain them
- If spotting occurs, wet and hand rub dishwashing liquid (or mild bar soap) and rewash.

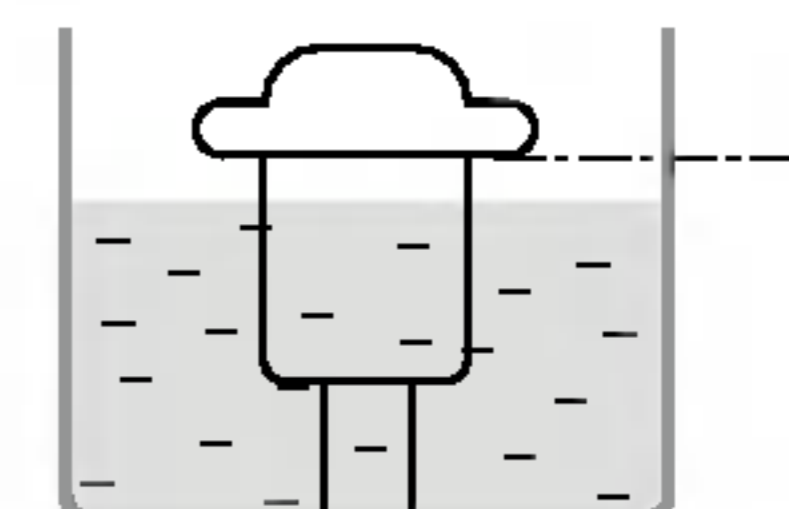

※ If the softener is over filled, it can overflow

Note

Fabric Softener will be dispensed automatically during the final rinse.

Using Bleach Check fabric care labels for special instructions.

AVAILABLE BLEACH TYPE

- Use oxygenated bleach.
- Do not use liquid bleach.
- For more details refer to the products instruction for use.

DEPOSITING BLEACH

- Separate the laundry to be bleached.
- Measure powdered bleach carefully, following instructions on the box.
- Before starting the washer, pour measured amount of bleach directly into bleach dispenser.

Attention

- Never pour undiluted liquid bleach directly onto clothes or into the wash basket. This may affect colors or damage clothing.
- Do not mix chlorine bleach with ammonia or acids such as vinegar and/or rust remover. Mixing can produce a toxic gas which may cause death.
- Do not pour liquid bleach into bleach dispenser.

Function of each Button

Stain Level

- Default is MEDIUM. By pressing button [HEAVY ► LIGHT ► MEDIUM] mode repeats.
- Available all cycle
- Available during washing.

Water levels

- Use to select water levels.
- Available during washing.
- For appropriate quantity of detergent follow the detergent manufacturer's instruction.

Display Wash Process

- On : will do
- Blink : doing
- Off : Done

Silent

- Use it at night to wash quietly.
- When selected "Silent" lights are on and the other cycle's light are all off.

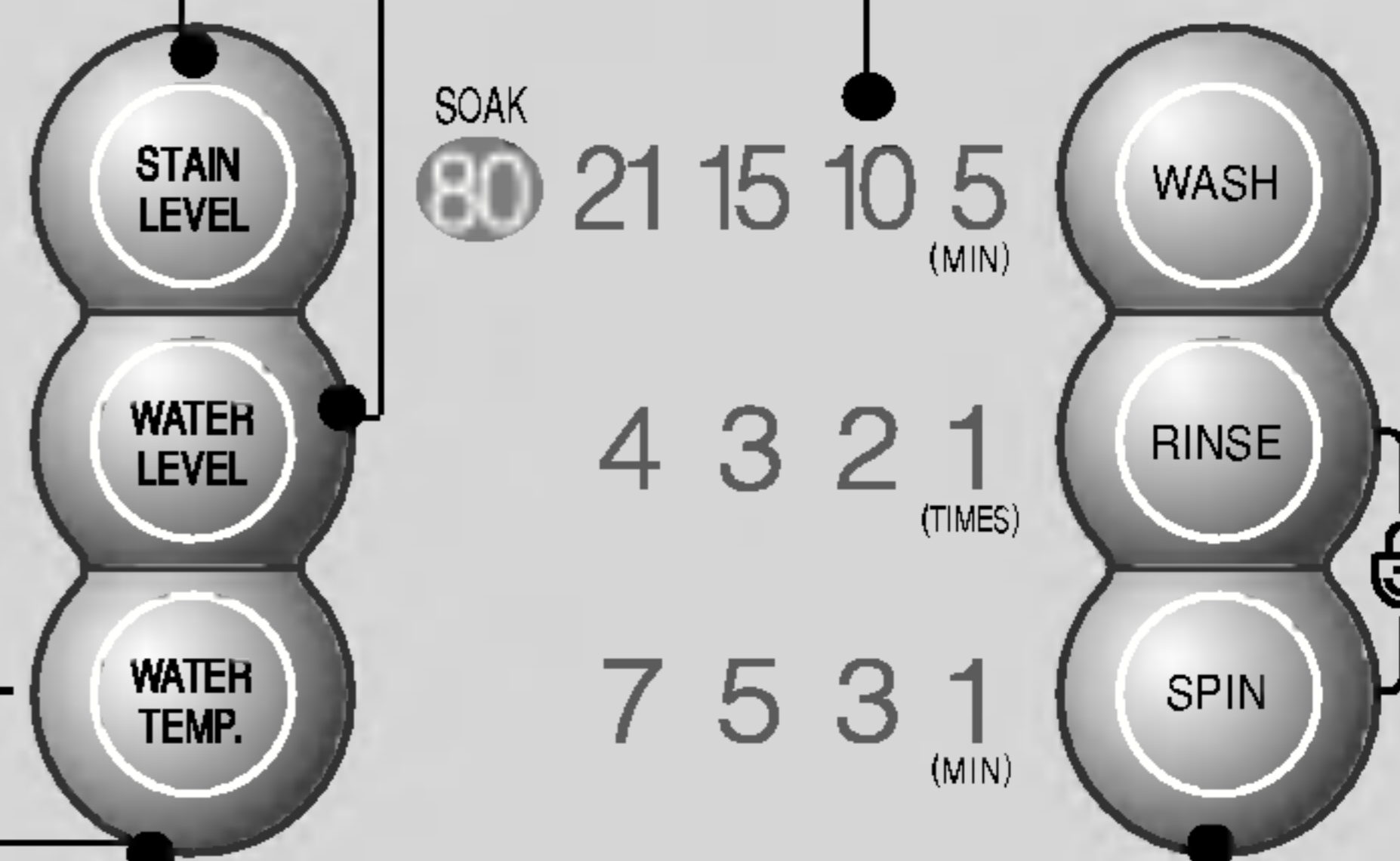
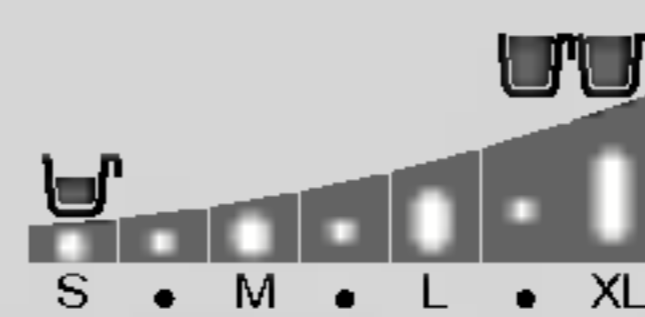

Water temperature

- Use to select proper water temperature while running.
- Available during washing.
- Only cold water for "WOOL" & "DELICATE"

Wash, Rinse, Spin, Button

- Use to change washing time, the number of rinse, spin time.
- To change washing time, the number of rinse, spin time during wash, do it after pressing "START/PAUSE" button.
- Soak is used to remove old or hardened dirt more effectively. You can change wash time after soak(80min.)
- Choose 1min Spin to avoid wrinkle

Note

The control panel may differ according to different models

Motor Speed Indicator

- The light circulates according to motor speed.

Display Delay Time,

- Used to indicate the time left of all processes or delay.
- In case of abnormal operation the following indications are displayed
 - PE : Abnormal water sensor (No Sensing Water Levels)
 - CE : Overload
 - LE : Abnormal motor (No Spin)
 - UE : Unbalanced load

Start Pause Button

- Use it to start or pause.
By pressing the button [Start ▶ Pause] are repeated.

Abnormal Operation Display

- In case of abnormal operation problem will be light and a buzzer will sound.

Power

- Use it to turn on and off.
By pressing the button [On ▶ Off] are repeated.
- Electrical power automatically turns off 10sec, after the washing cycle finishes with “boo~” sound.
- Electric power automatically turn off after 10min. in ‘Pause’ condition.

Child lock function

Use to lock or unlock the control buttons to prevent setting from being changed by a child.
To lock, push the RINSE, and SPIN buttons simultaneously and to unlock push them one more time during the washing process.

Delay

- Use this function for delayed washing.
- Use it to set the delayed time.
- Not available for delicate.
- Available from 3~24Hr







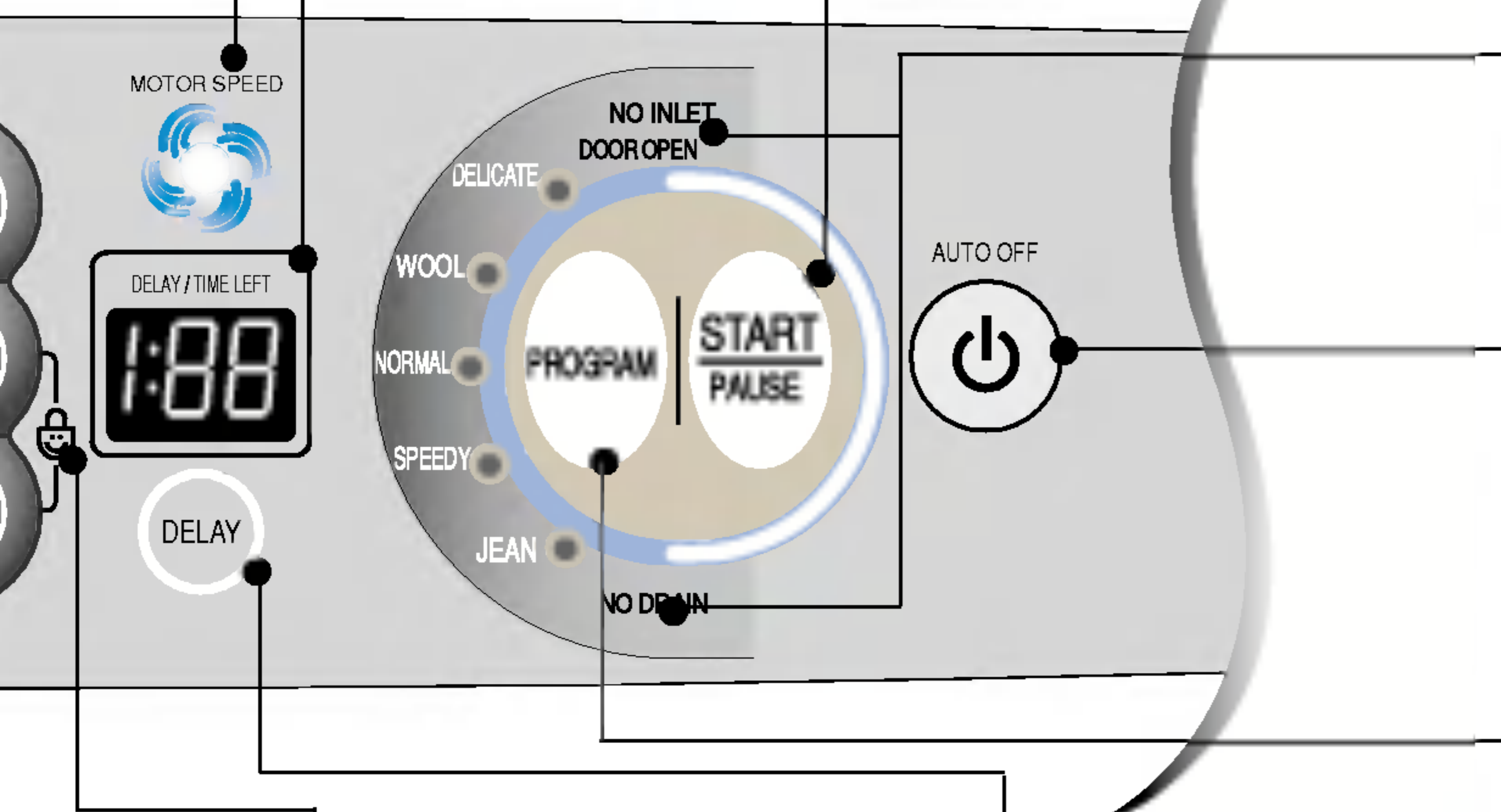





















Program

- Use it to select washing programs.
- By pressing the button, it cycles [NORMAL ▶ SPEEDY ▶ JEAN DELICATE ▶ WOOL]



















(refer to p12)













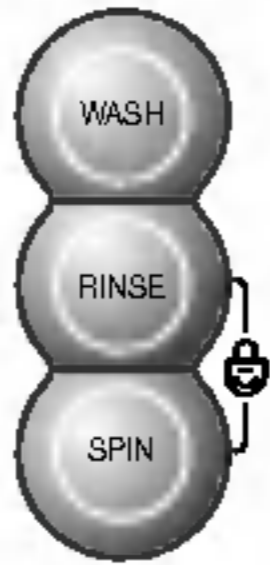





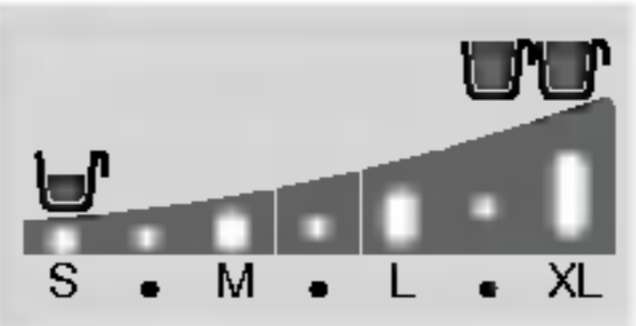

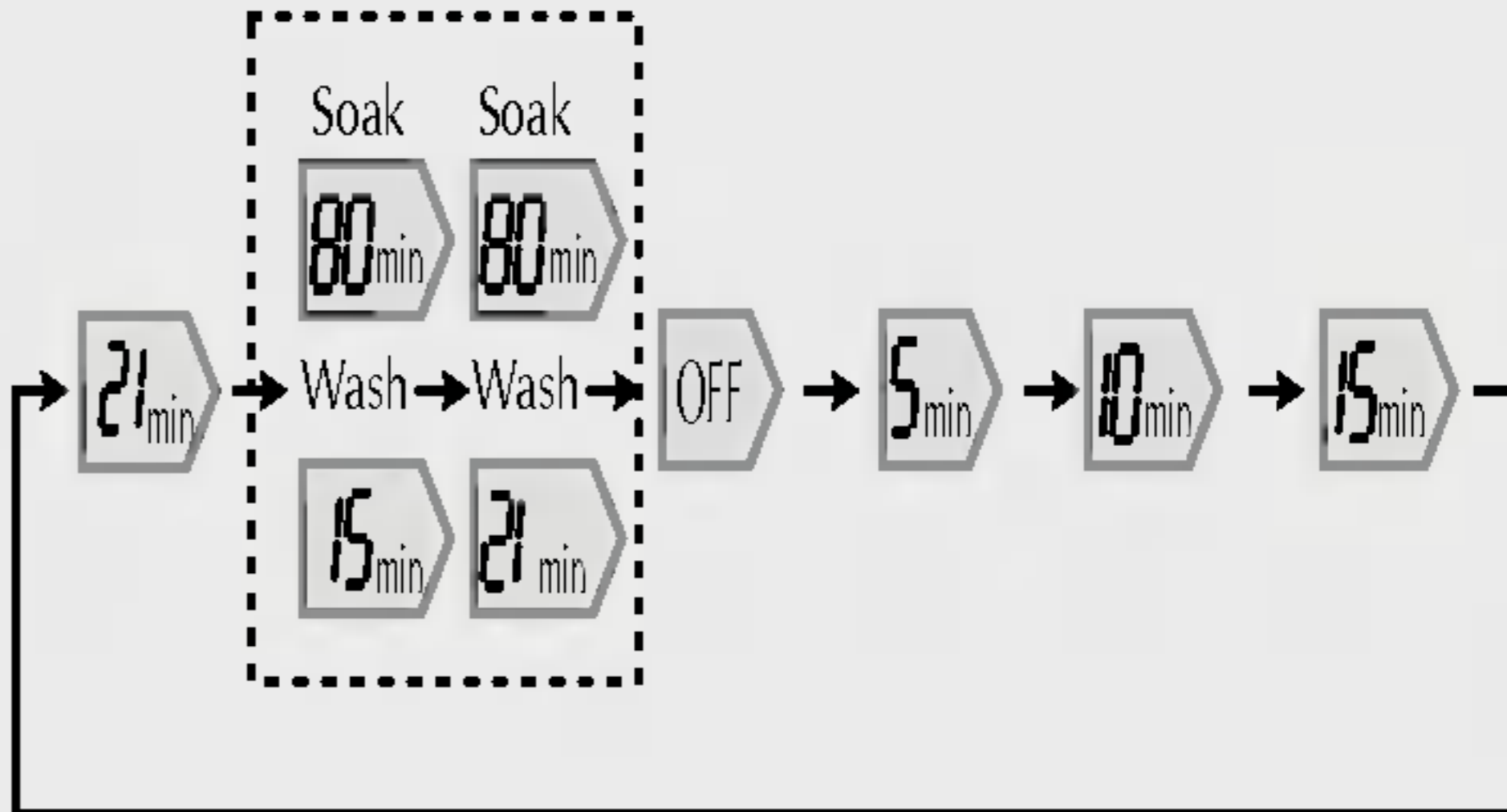



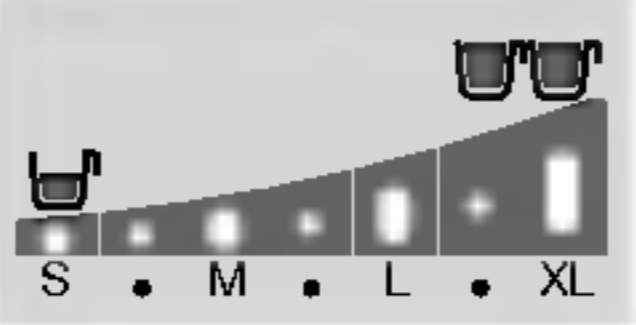

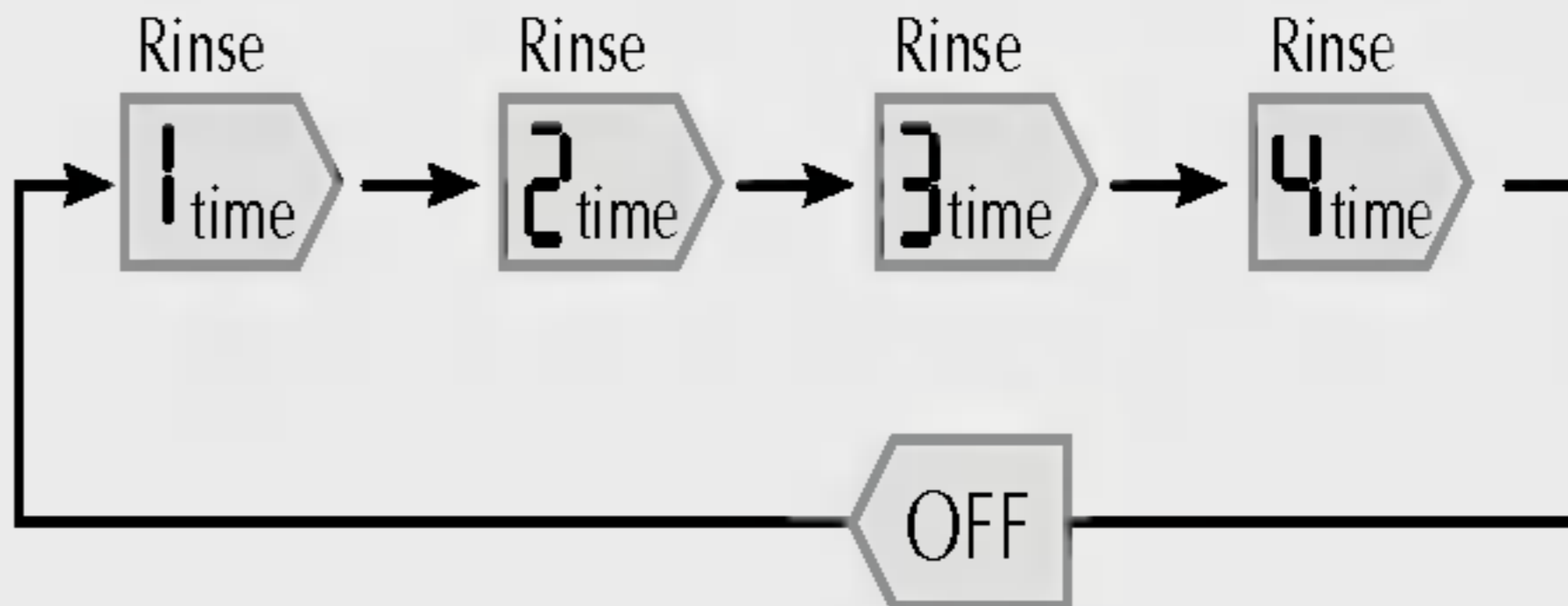
Washing Programs

Washing Programs		Add the laundry			
<p>DELICATE Wash</p> <p>Use this program for washing delicate fabrics such as lingerie. Before washing your woolens check the care label for the washing instructions. (wash only "water washable" clothes)</p>			 • Select the DELICATE program on the Control panel.		
<p>WOOL</p> <p>Use this program for washing woolens. (wash only "water washable" clothes)</p>			 • Select the WOOL program on the Control panel.		
<p>Normal Washing</p> <p>Used for normal loads, this mode automatically selects the most appropriate conditions and completes the sequence in one operation. The built-in sensor detects the size of the load and the ideal wash power and wash, rinse and spin times are set accordingly</p>				 • The inner-tub rotates for 10 seconds to detect the laundry load. • Then the Water Levels and the amount of detergent to be used will be shown and water will be supplied.	
<p>SPEEDY</p> <p>Use this mode when washing lightly soiled clothes for a short time.</p>			 • Select the SPEEDY program on the Control panel.		
<p>Jean Wash</p> <p>Use jeans program when washing heavy, thick, and extremely dirty laundry such as jeans and work outfits.</p>			 • Select the Jean program on the Control panel.		
<p>Soak Wash</p> <p>Use this mode for washing heavily dirty laundry by soaking in water for some time to remove proteins and fats.</p>			 • Select the desired program (Not available for " WOOL " & " DELICATE " program).	 • 'DELAY' light is blinking and left time is displayed. • Press 'WASH' button until 'Soak 80' lights on. • Wash time except soak is changeable to 15, 21 by pressing 'WASH' button • Select No. of rinse and spin time by pressing button.	

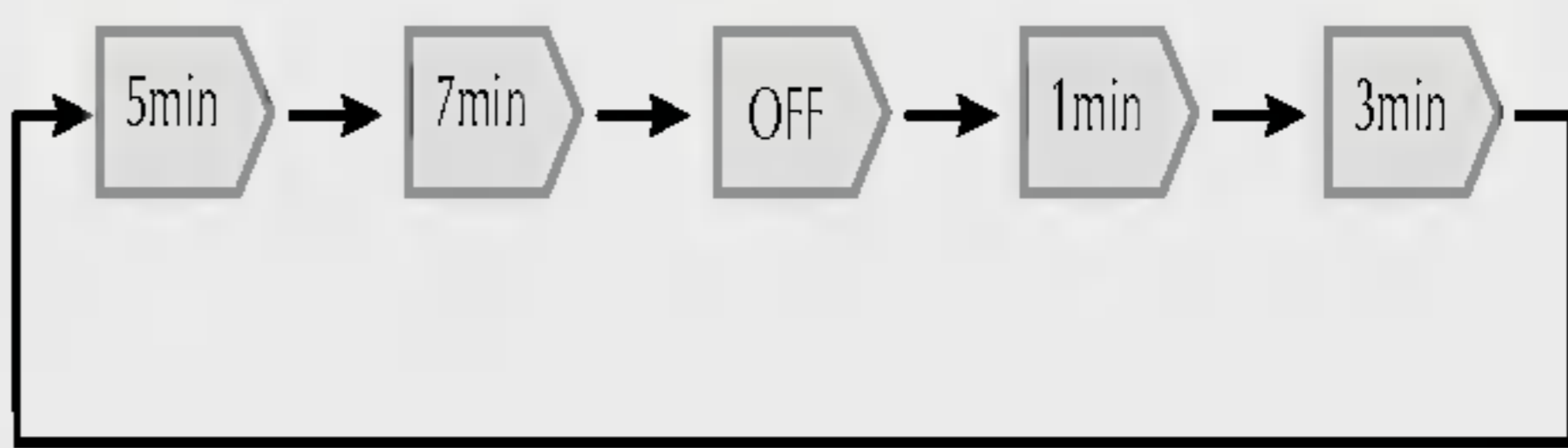
※ It is normal to wash lower water level before the main wash.

Add the detergent	Close the lid	Finish	Caution & Note
		 · When the wash program ends, the buzzer will ring for 10 seconds before the Power goes off automatically.	<ul style="list-style-type: none"> · When setting the water level manually, do not set to MEDIUM to prevent damage to laundry. · Washing with hot water may damage the laundry (Water is set to cold automatically). Ensure that the load is under 3.5kg. · In order to avoid damage to laundry, the spin cycle may appear slow. This also avoids wrinkles and clothing may still contain some water. This is normal. · Soak Wash cannot be selected for the Wool and Delicate Wash program.
 <ul style="list-style-type: none"> · Use appropriate neutral detergent for the laundry · When washing woolens use a mild detergent recommended for washing wool. 			
 <ul style="list-style-type: none"> · For adding the appropriate quantity of detergent follow the detergent manufacturer's instruction. 	 Water will be supplied 2 min. after the start of the wash to supplement the water the laundry has absorbed.	 When the wash program ends, the buzzer will ring for 10 seconds before the Power goes off automatically.	<ul style="list-style-type: none"> · If water is already in the tub, or wet laundry is placed into the tub water will be added to the optimal level before washing starts.. · With lightweight bulky loads, water level can be set to low. · Changes to water temperature (hot/cold) and wash level are possible during operation. (refer to p 10)
			
			<ul style="list-style-type: none"> · Water may splash out when washing light laundry such as a cashmere blanket or bed sheet with water set at high level.
		 <ul style="list-style-type: none"> · Electrical power is automatically off in 10sec. after buzzer sounds. 	<ul style="list-style-type: none"> · Soak time is 80min

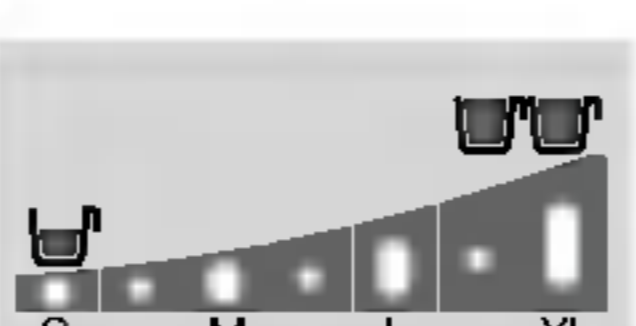
Option Washing Method

			 · Select water levels Add detergent.		By pressing button
Wash only		 · Select WASH time.	 	 · Close the lid Press Start/ Pause button.	
Rinse only		 · Select No. of RINSE .	 	 · Close the lid Press Start/ Pause button.	
Spin only		 · Select SPIN	 · Close the lid	 · Press Start/ Pause button.	
Rinse Spin only		 · Select No. of RINSE and SPIN time.	 	 · Close the lid Press Start/ Pause button.	

Delay Start Wash

Delay Start (Reservation) Wash is used to delay the finishing time of the operation. The hours to be delayed can be set by the user accordingly. The time on the display is the finishing time, not the start time.

- 1 Press the **POWER** button to turn power on.



- 2 Press the **PROGRAM** button to select the washing program.



- Select the program for laundry on the Control panel. This method will not work in Wool Delicate Program.

- 3 Press the **DELAY** button to set the time when the delayed washing is to be completed.



- The time changes 3~24 hours.
- The time on the display is the finishing time, not the start time.

- 4 Add the detergent.

- The appropriate quantity of detergent marked next to the water level of **WATER-DETERGENT**.
- When the lid is open the machine will not operate, and an alarm signal will remind you to close the lid

- 5 Add the laundry and press the **START/PAUSE** button.



- When you press the **START/PAUSE** button the light will blink.

- 6 Close the lid.

- Water will be supplied for 2 minutes after the start of the wash to supplement the water the laundry has absorbed.

Finish

The washing will be finished according to the delayed time.

Note

- If the lid is open, the machine will not work, and an alarm & will sound and panel will display "DOOR OPEN" to remind you to close the lid.
- To select washing program, spinning time, water level or hot/cold manually, press the **Delay Start** button and select the desired option. Then press the **START/PAUSE** button.
- When the laundry cannot be taken out immediately after the wash program ends, it is better to omit the spinning program. (The laundry will be wrinkled if left for a long time after spinning.)

Other Useful Functions

Child Lock Function

If you want to lock all the keys to prevent all settings from being changed by a child, you can use the child lock option.

How to Lock

1 Press the **POWER** button.



- Turn Power on.

2 Press the **START/PAUSE** button to start washing.



- After all washing conditions are set according to the manual.

3 Press both the **RINSE button** and the **SPIN button** simultaneously.

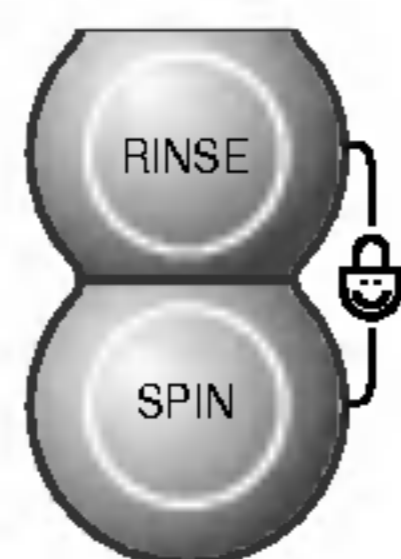

- During the wash program, all the buttons are locked until washing is completed or until the child-lock function is deactivated manually.

How to Unlock

If you want to unlock during wash, press both the **RINSE** and the **SPIN button** simultaneously again.

Note

- In child-Lock mode, the LED display continuously repeats "CL" and remaining time.

Placing and Leveling

Please ensure that transit restraint has been removed before operating your machine.

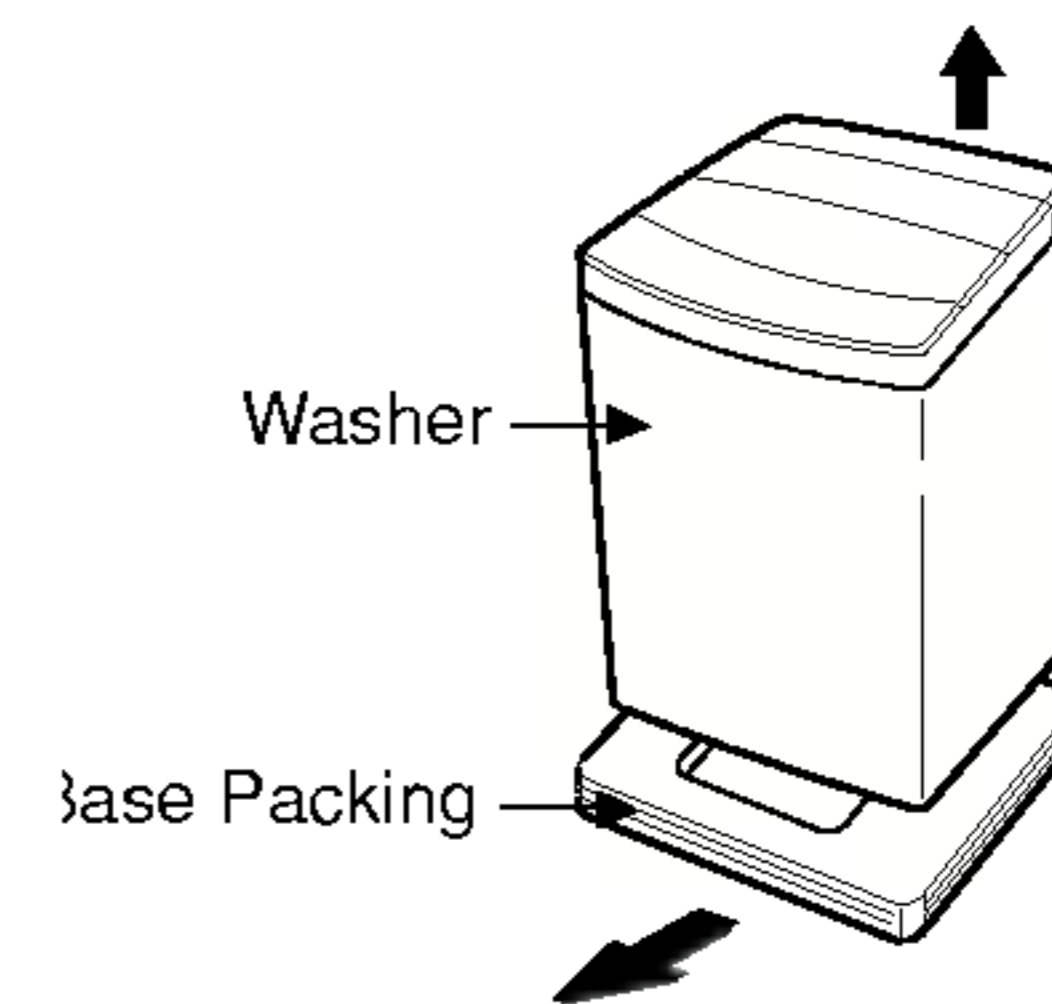

1 Place the machine on a flat and firm surface which allows proper clearance.

We suggest a minimum clearance of 2cm right side and left sides of the machine for ease of installation.

At the rear, a minimum clearance of 10cm is suggested.

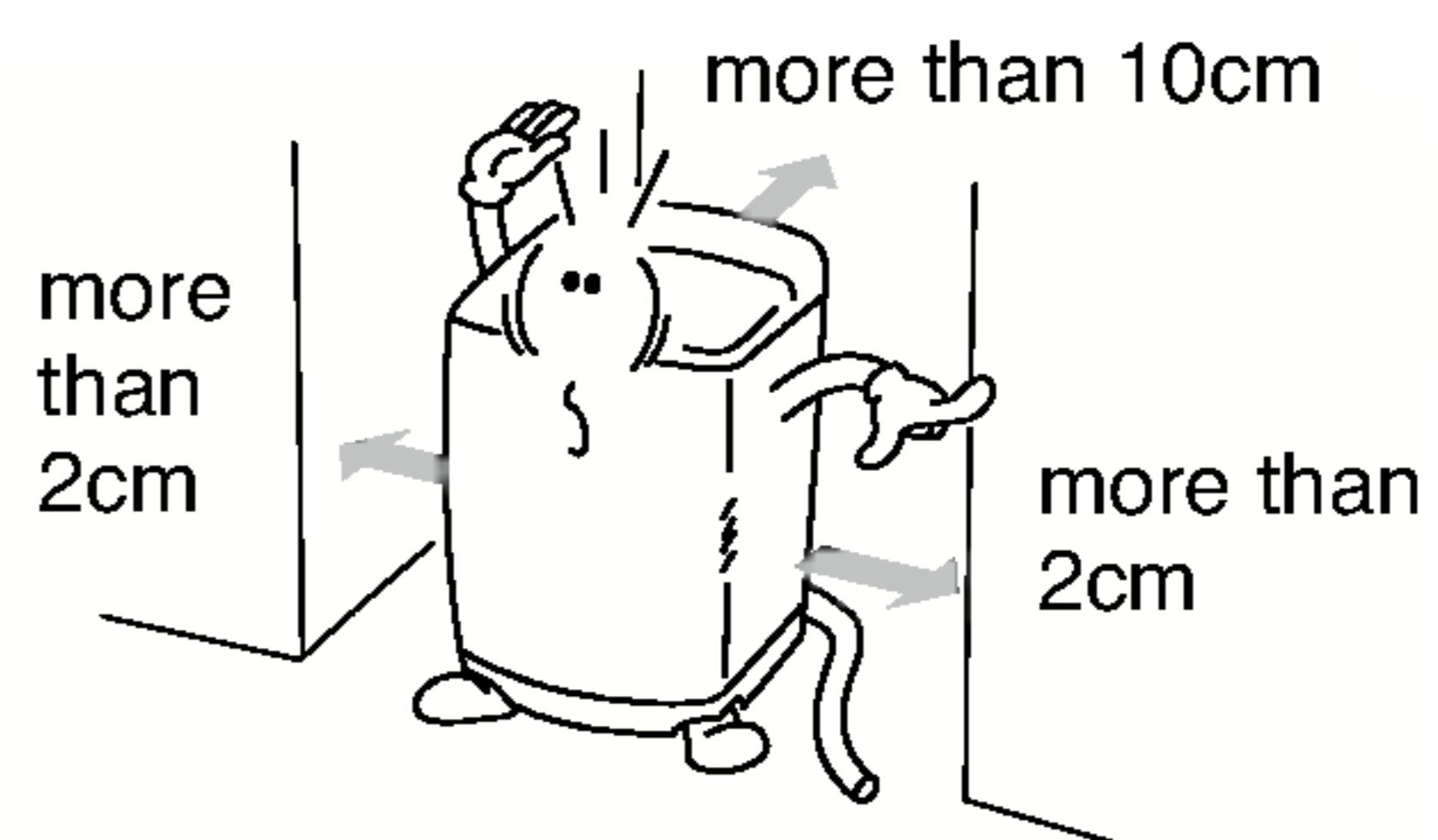
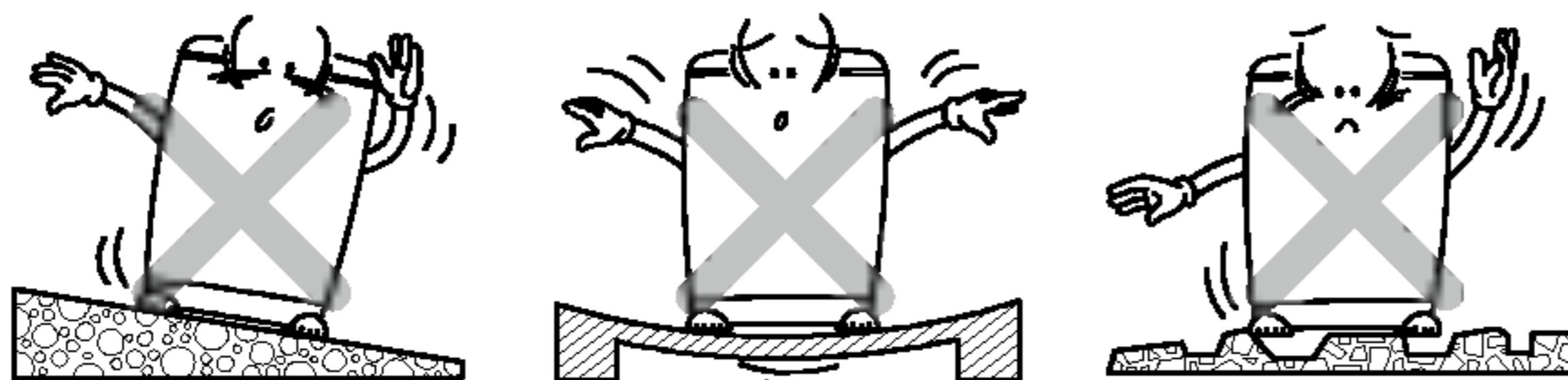

2 Check that the machine is level

Open the lid and look from above to see if the drum sits as shown.

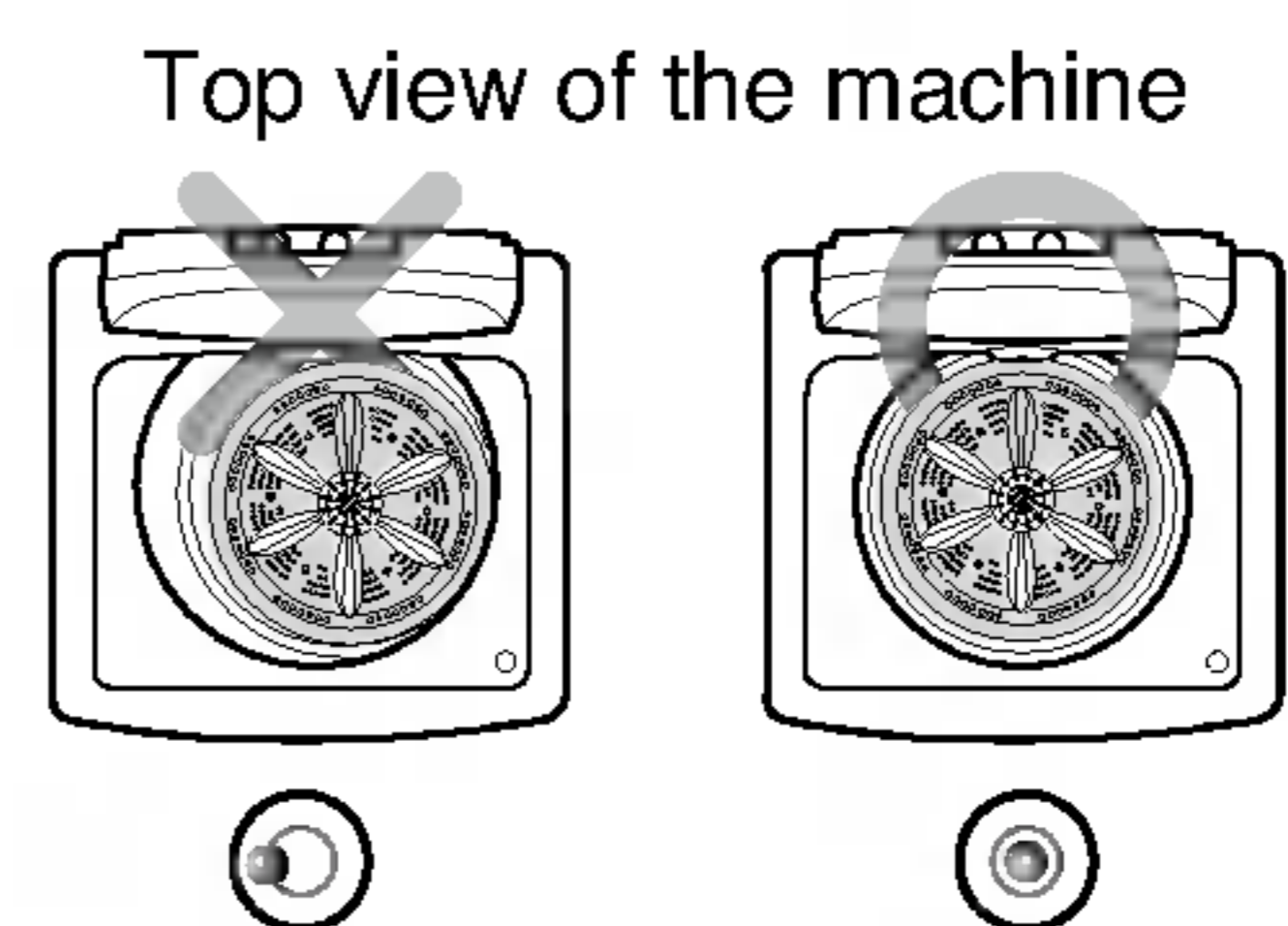

3 Leveling the machine

Lift the front of the washing machine and twist the Adjustable Leg until the washing machine is placed evenly.

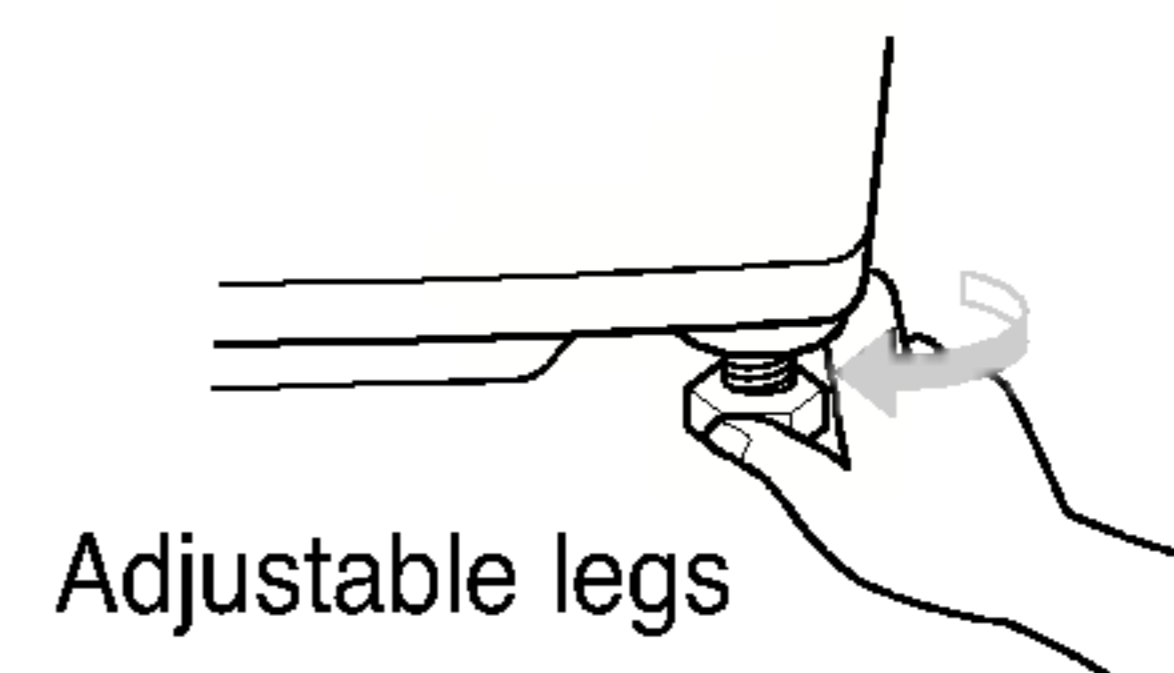

Caution

If the power is supplied from a cord extension set or generator, the cord extension set or electrical portable outlet device should be positioned so that it is not exposed to splashing or ingress of moisture.

Connecting Water Supply Hose

- Before connecting the Water Supply Hose to the water tap, check the hose type and then choose the correct instruction.

Note that the Water Supply Hose supplied may vary from country to country, Make sure to connect the blue inlet hose to the cold water tap, and the orange inlet hose to the hot water tap.

- Washing machine is to be connected to the water mains using new hose sets and that old hose sets should not be reused.

Connecting Water Supply Hose to water tap

Normal Type

(Normal tap without thread & screw type inlet hose.)

Untighten the screw (option)

Untighten the screw of the connector so that the tap can be placed in the middle.

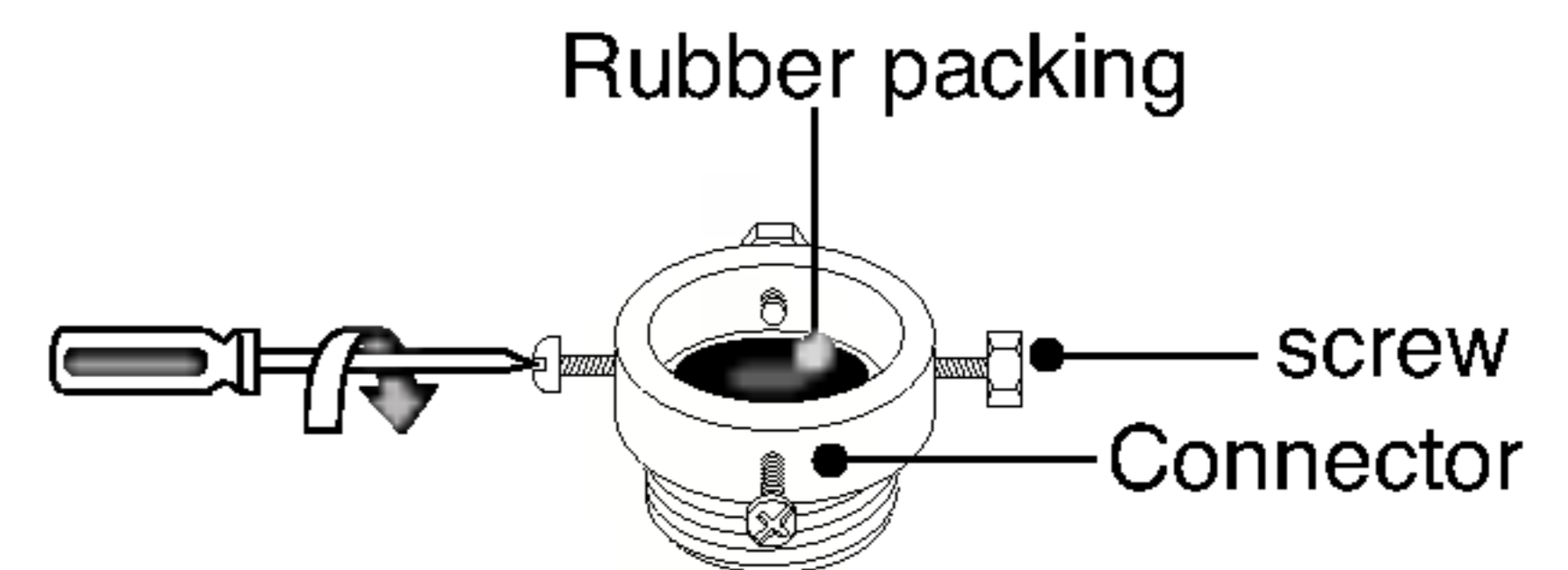

Fixing the connector to the tap (option)

Push the upper connector up till the rubber packing is in tight contact with the tap. Then tighten the 4 screws.

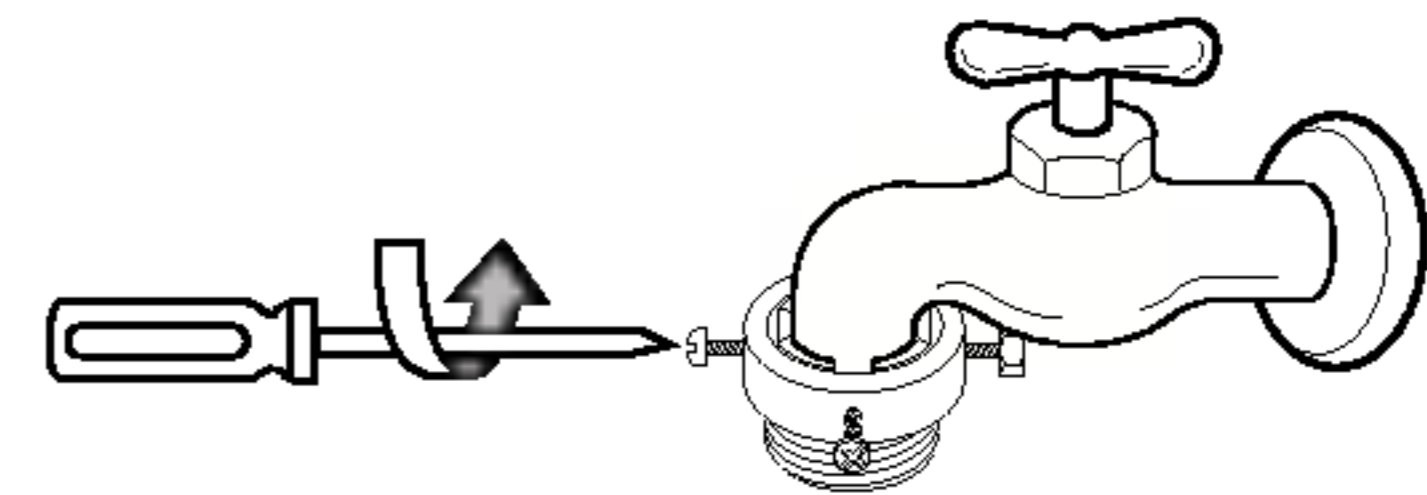

1

Attach the water supply hose ensuring it connects securely to the connector or the water tap

Push the water supply hose vertically upwards so that the rubber seal within the hose can adhere completely to the tap.

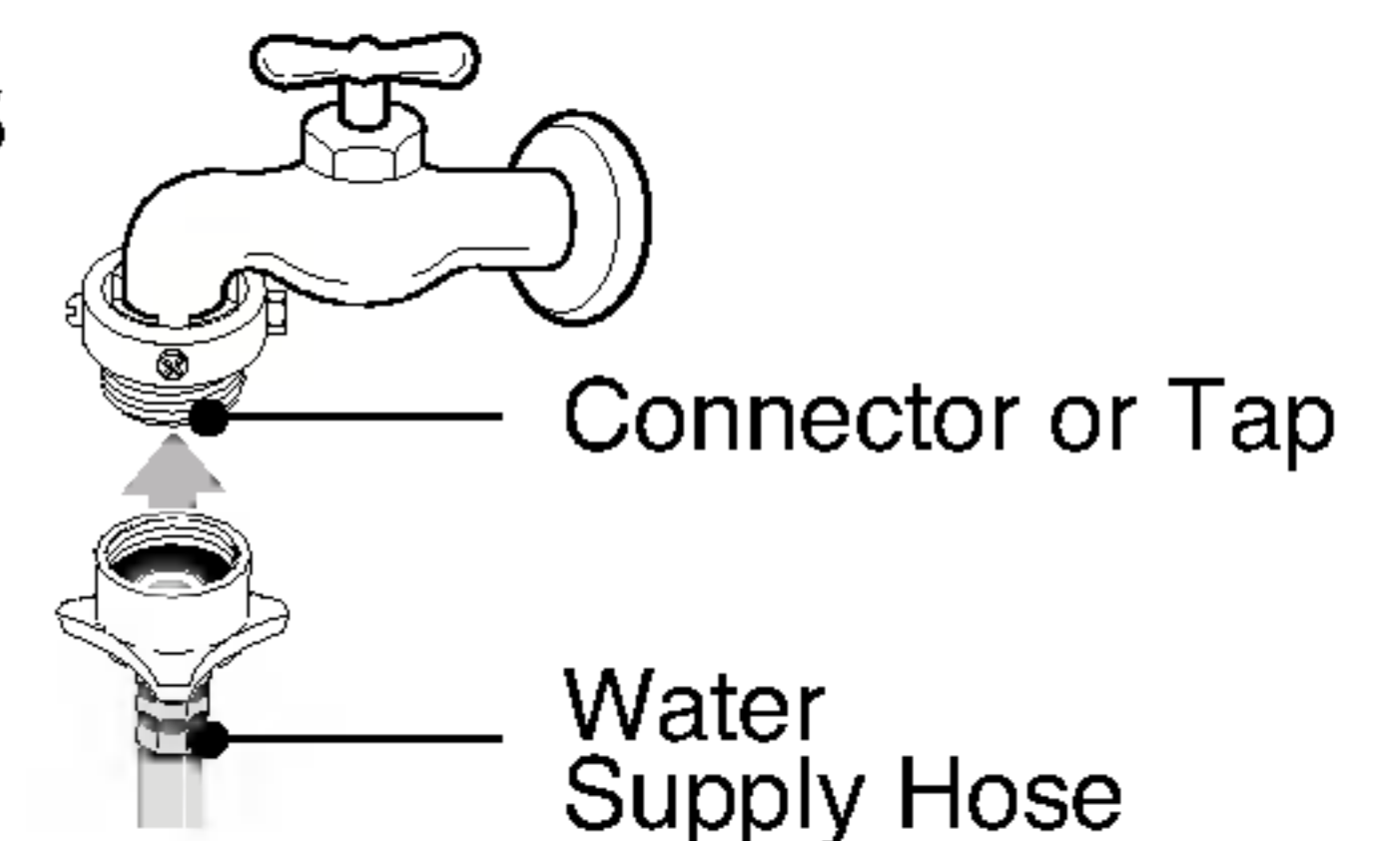

2

Tighten the connection between the water supply hose

Attach the water supply hose to the connector and then tighten it by screwing it to the right.

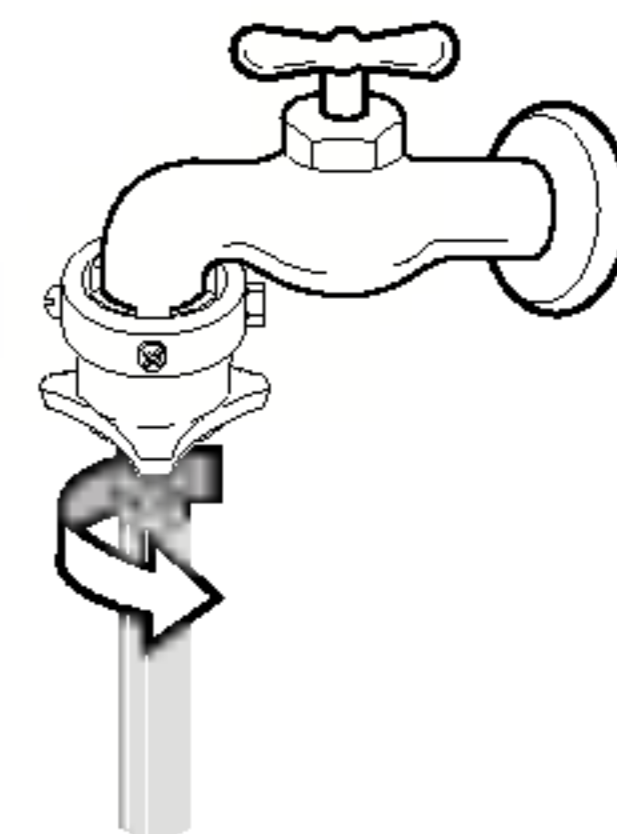

3

Check the connection of water supply hose and the connector

After connecting the hose, open the tap to check for any water leakage.

In case of water leakage, close the tap and start again from step 1

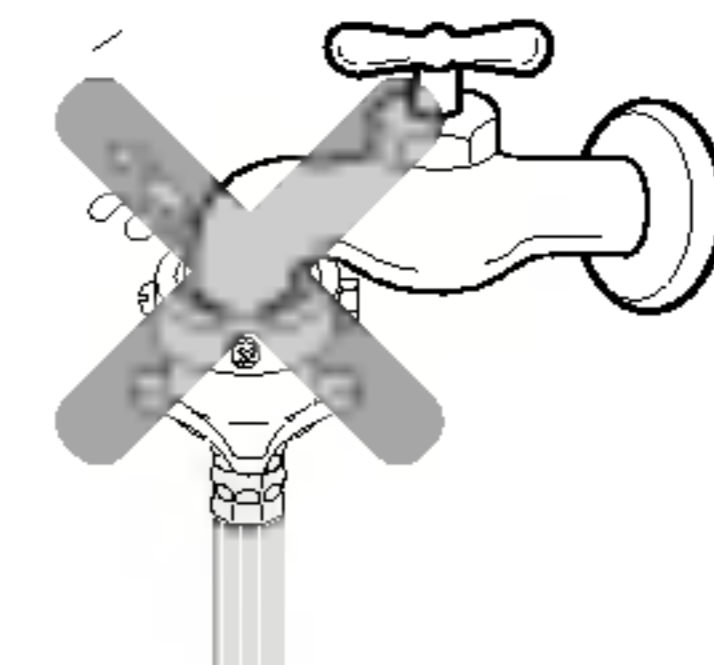

Connecting Water Supply Hose to the machine

Connect the water supply hose to inlet valve of the washing machine, and then lock it by turning the hose connecting part.

Check to see if there is a rubber seal inside the connector.

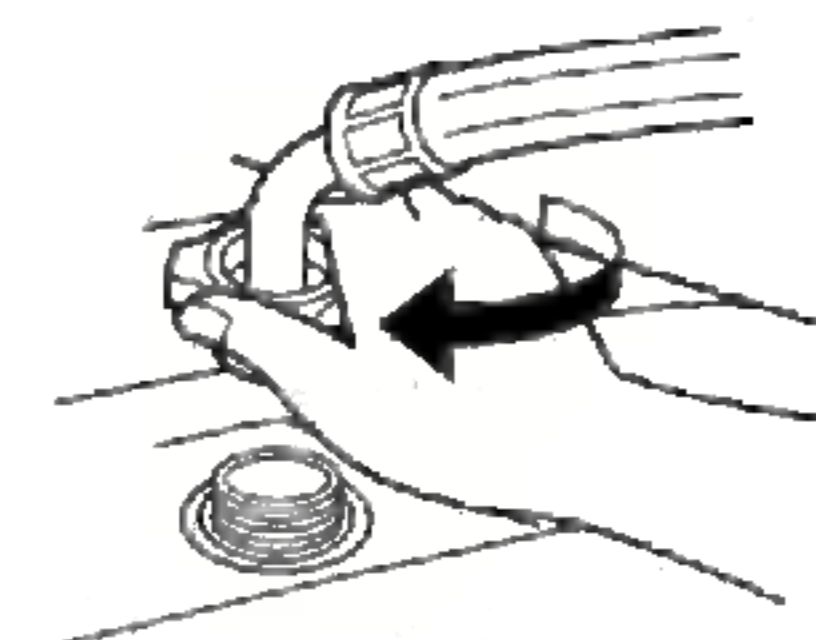

Hose connector

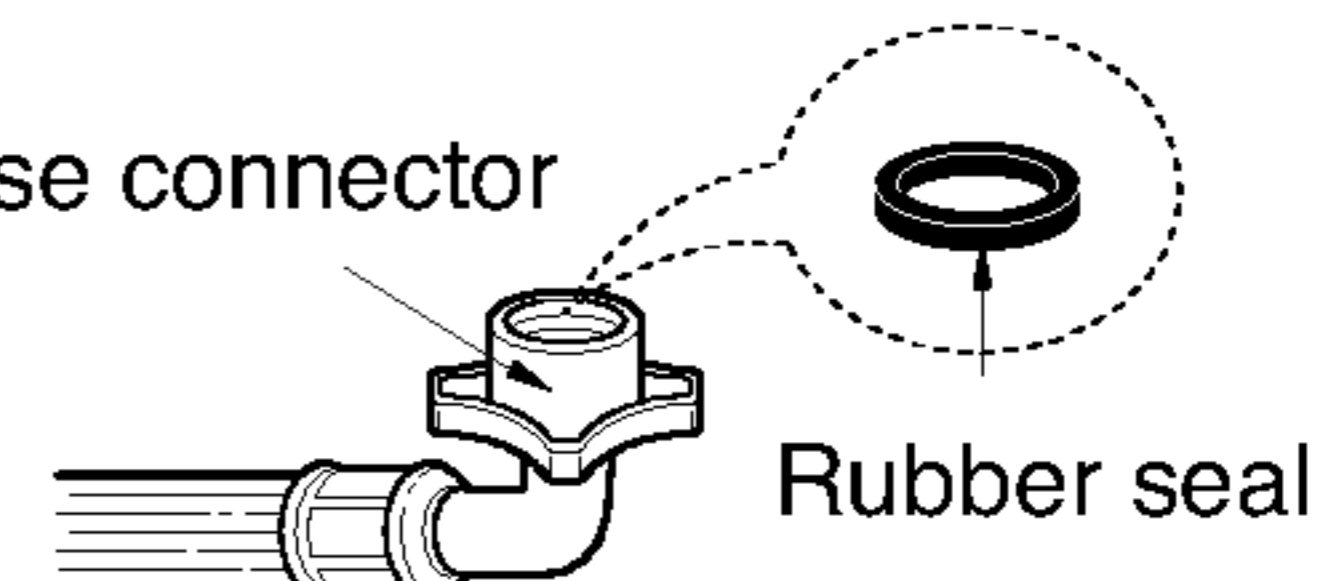

Rubber seal

Connecting Drain Hose

Before connecting Drain Hose, check your Drain Hose model and choose the correct instructions.

Pump Model

- 1 Fit the machine end of the drain hose to the outlet of the drain pump and tighten the clamp.

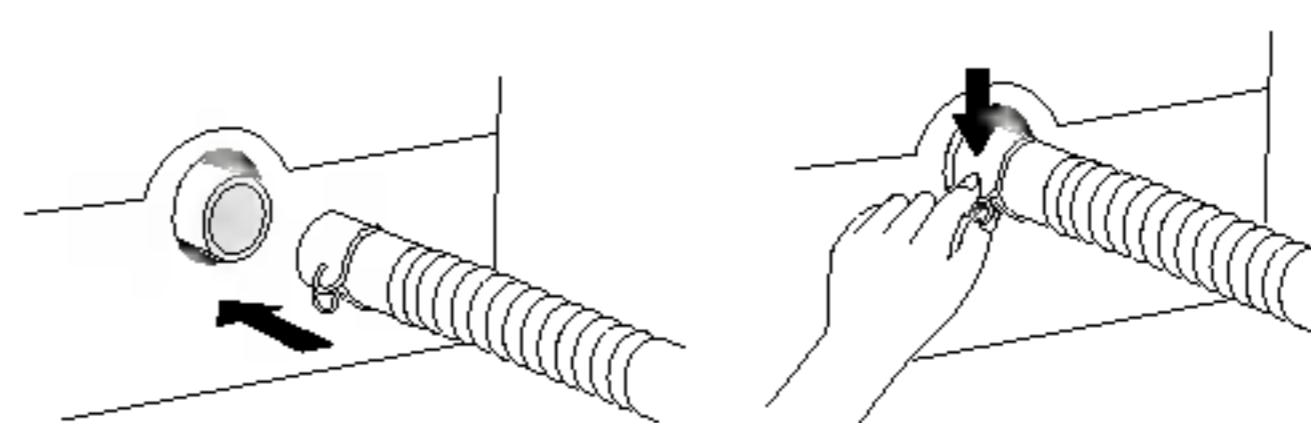

- 2 Put the other end of the drain hose over the standpipe or wash tub.

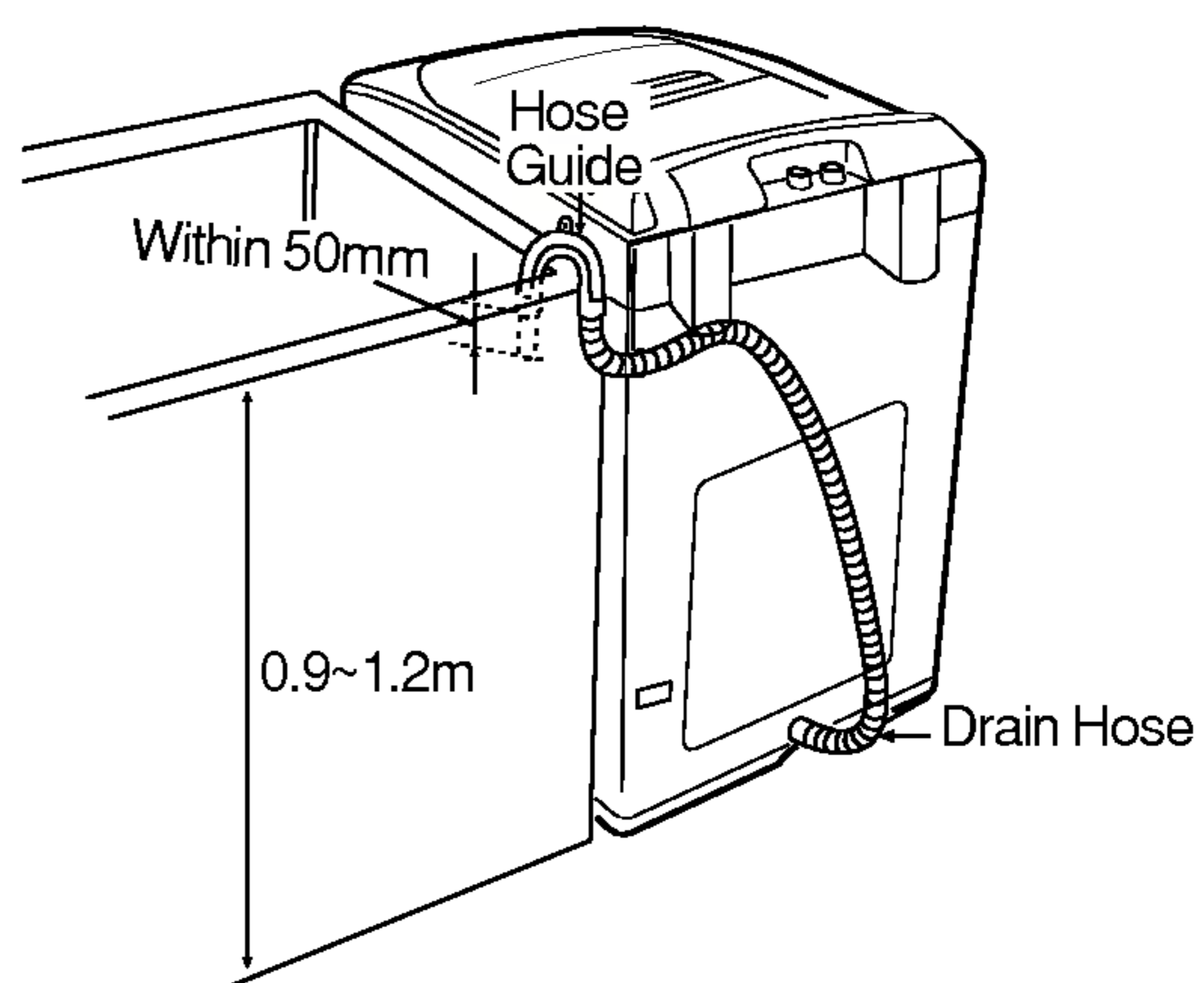

Note

- To prevent siphoning, the drain hose should not extend more than 50mm from the end of the hose guide.
- The discharge height should be approximately 0.9 ~ 1.2m from the floor.

Grounding Method

Earth wire should be connected.

If the earth wire is not connected, there is possible a danger of electric shock caused by the current leakage.

Grounding Instructions

This appliance must be grounded. In the event of malfunction or breakdown, grounding will reduce the risk of electric shock by providing a path of least resistance for electric current. This appliance is equipped with a cord having an equipment-grounding conductor and grounding plug. The plug must be plugged into an appropriate outlet that is properly installed and grounded in accordance with all local codes and ordinance.

Grounding Instruction with Ground insert space Terminal

If the AC current outlet has a ground terminal, then separate grounding is not required. Note that AC power outlet configurations may differ from country to country

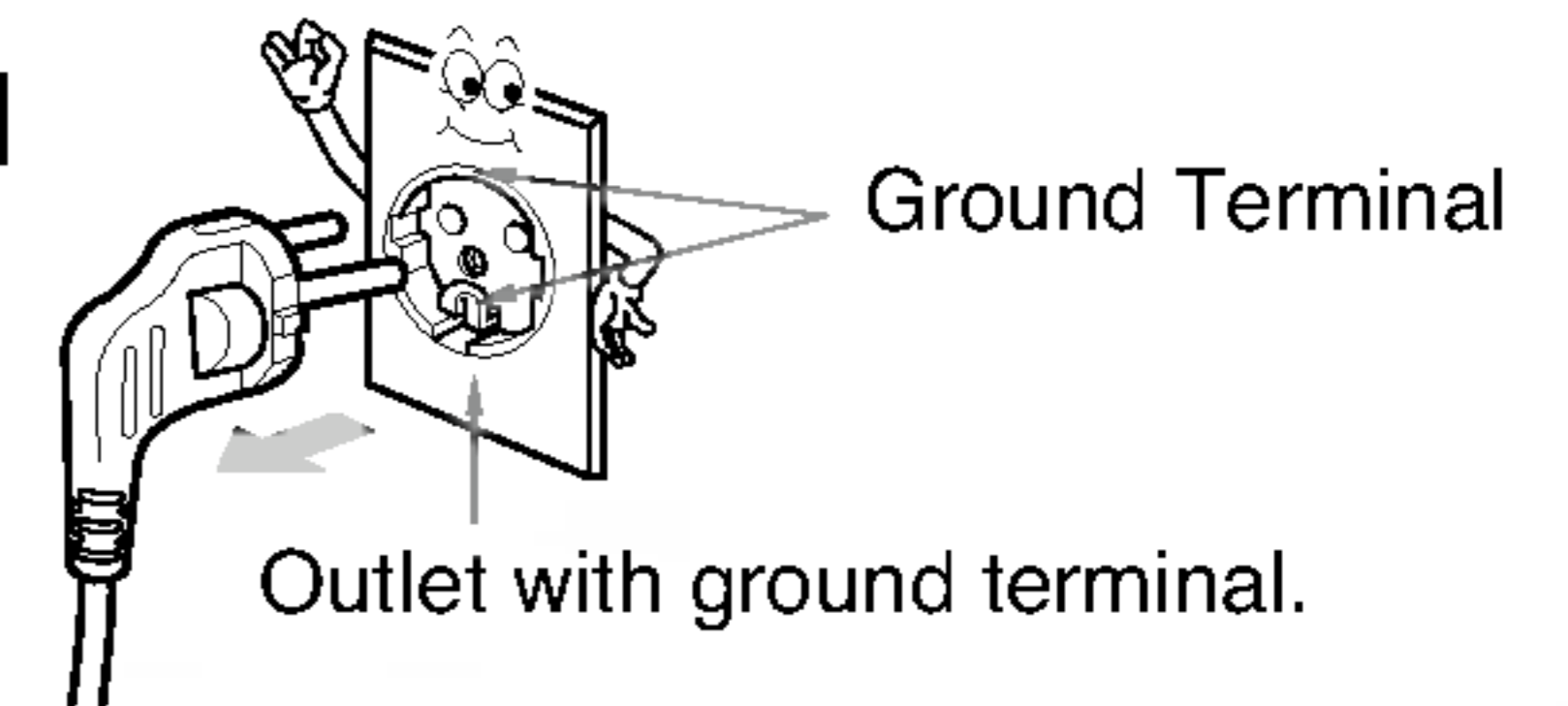

Caution

CAUTION concerning the Power Cord

Most appliances recommend they be placed upon a dedicated circuit; that is, a single outlet circuit which powers only that appliance and has no additional outlets or branch circuits. Check the specification page of this owner's manual to be certain. Do not overload wall outlets. Overloaded wall outlets, loose or damaged wall outlets, extension cords, frayed power cords, or damaged or cracked wire insulation are dangerous. Any of these conditions could result in electric shock or fire. Periodically examine the cord of your appliance, and if its appearance indicates damage or deterioration, unplug it, discontinue use of the appliance, and have the cord replaced with an exact replacement part by an authorized servicer. Protect the power cord from physical or mechanical abuse, such as being twisted, kinked, pinched, closed in a door, or walked upon. Pay particular attention to plugs, wall outlets, and the point where the cord exits the appliance.

Other Grounding Instructions

Burying Copper Plate

Connect the Ground Wire to a Ground Copper Plate and bury it more than 75cm in the ground.

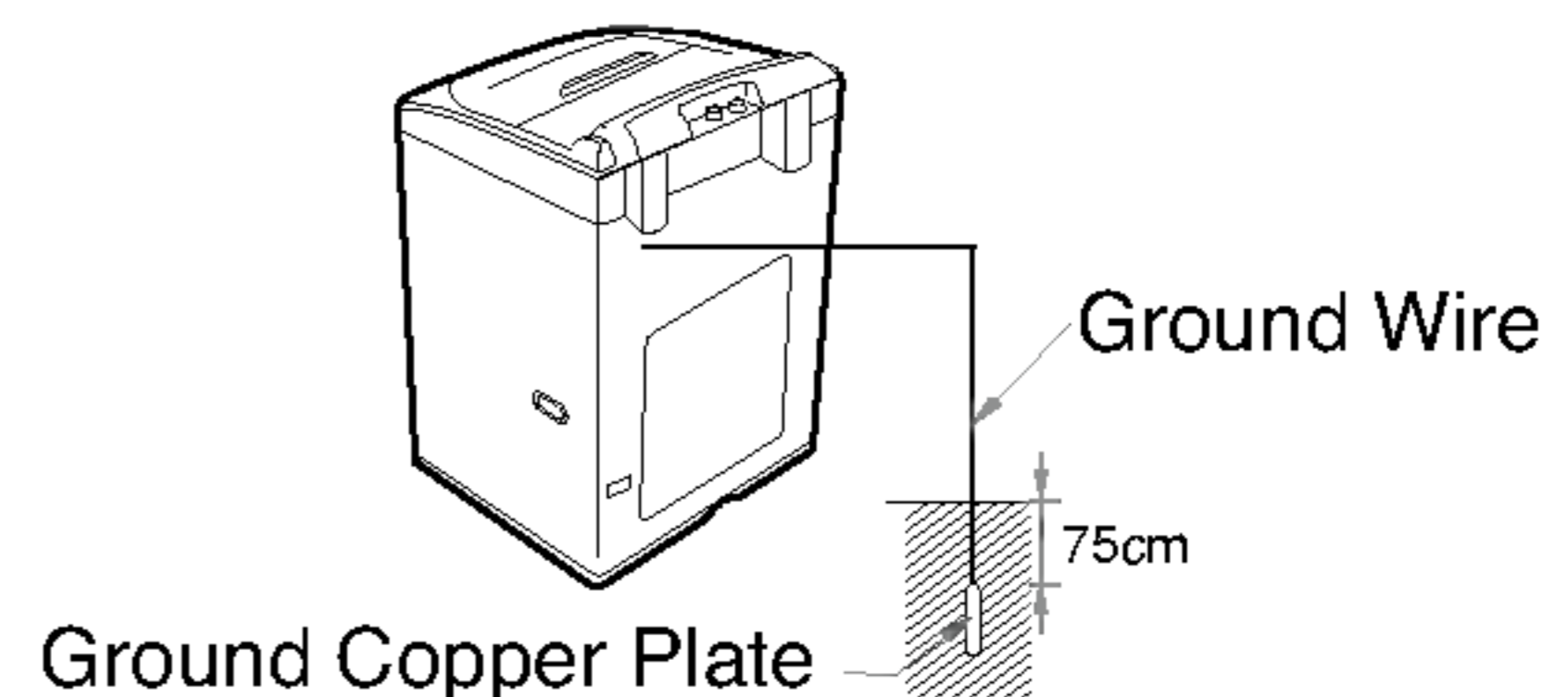

Using Ground Wire

Connect the ground Wire to the socket provided exclusively for Grounding.

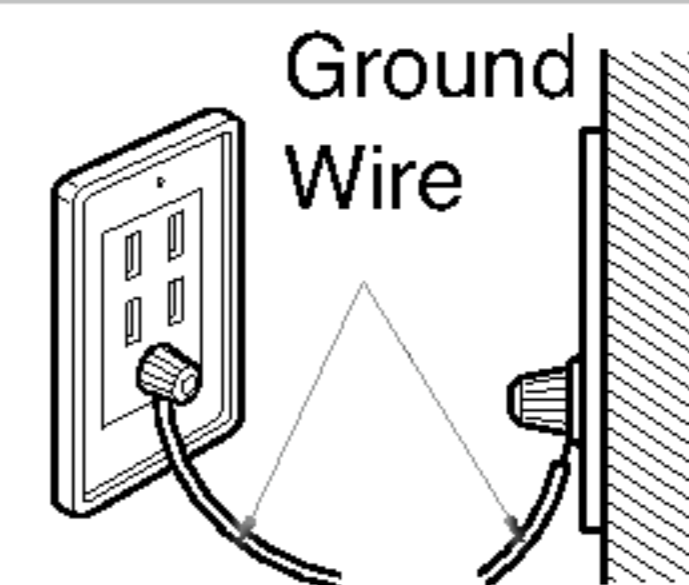

Using Short Circuit Breaker

If grounding methods described above are not possible, a separate circuit breaker should be employed and installed by a qualified electrician

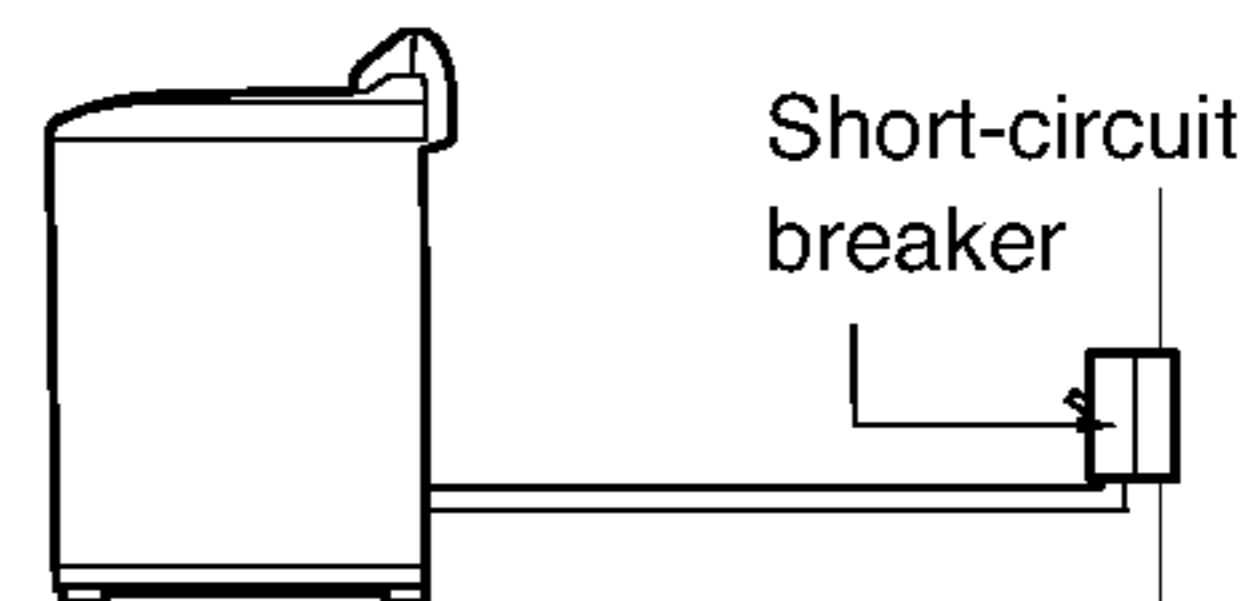

Caution

- To prevent a possible explosion, do not connect ground to a gas pipe
- Do not connect ground to telephone wires or lightning rods. This may be dangerous during electrical storms
- Connecting ground to plastic has no effect
- Ground wires should be connected when an extension cord is used.

⚠ WARNING! Improper connection of the equipment-grounding conductor can result in risk of electric shock. Check with a qualified electrician or serviceman if you are in doubt as to whether the appliance is properly grounded. Do not modify the plug provided with the appliance - if it does not fit the outlet, have a proper outlet installed by a qualified.

Cleaning

To Clean the Filter in the Inlet Valve

When water supply into the tub is not clean or the filter is clogged with particles (Such as sand), clean the filter in the inlet valve occasionally. (The figure of power cord and water tap may vary according to the country)

1

Close the tap before turning off the power.
Select both hot/cold and then press the [START/PAUSE] button to remove water from the machine completely.

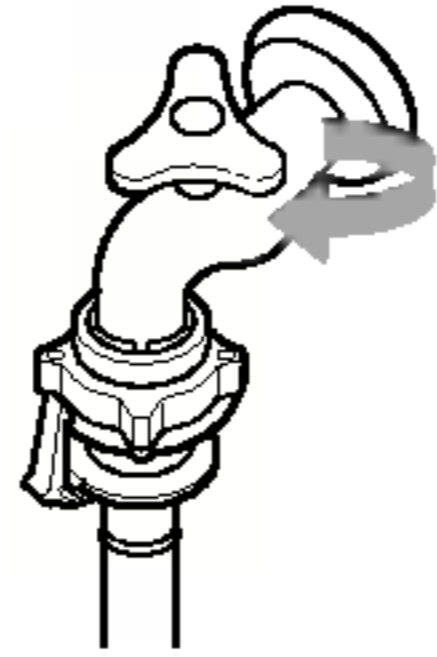

2

Turn off the power before pulling out the cord.

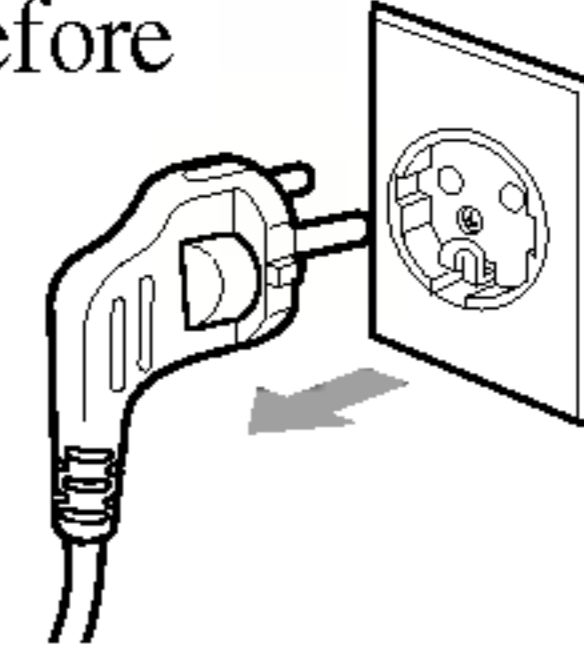

3

After removing the water supply hose pull out the filter. Then use a brush to clean the filter.

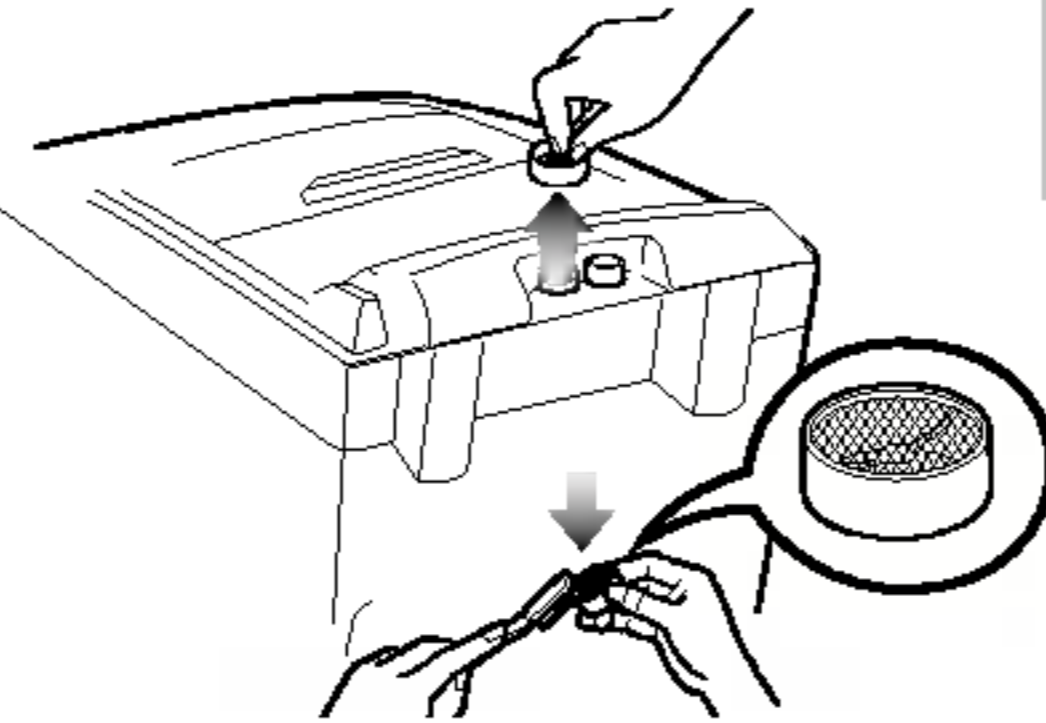

4

Replace the filter after cleaning it.

Caution

- Before cleaning the filter, the impurities in the water supply hose should be removed.

How to clean Multi clean Filter

1

Push the upper part of multi-clean filter down and pull forward.

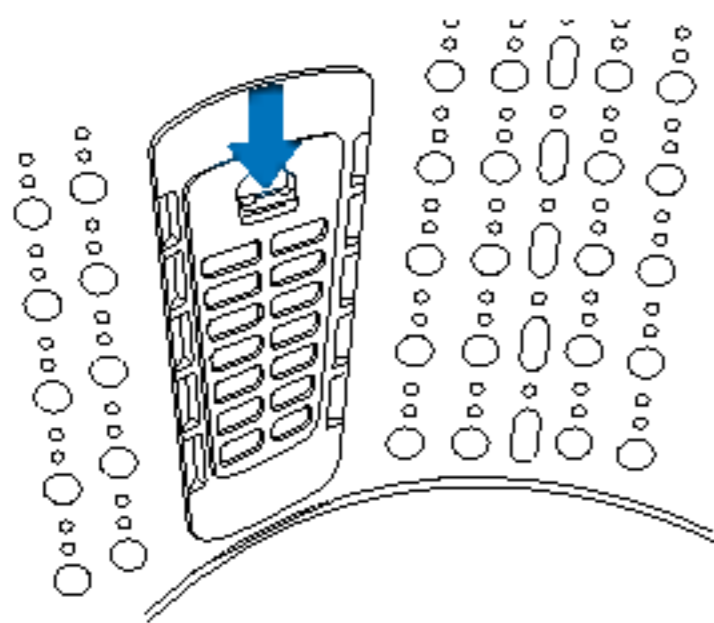

2

Open the lid and remove lint and then wash out.

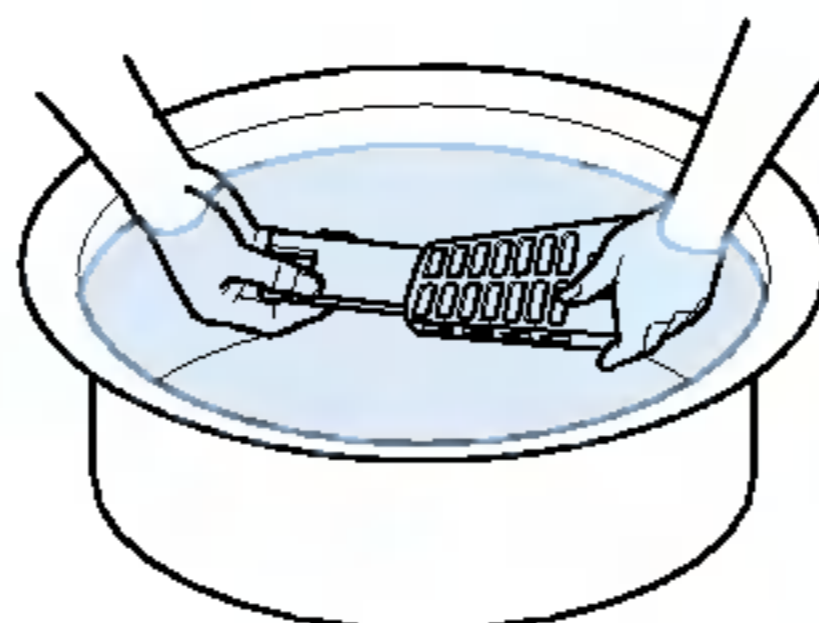

3

Close the lid and at first get it back to tub. First insert the lower part of filter to washer tub and pull it down until a click sounds.

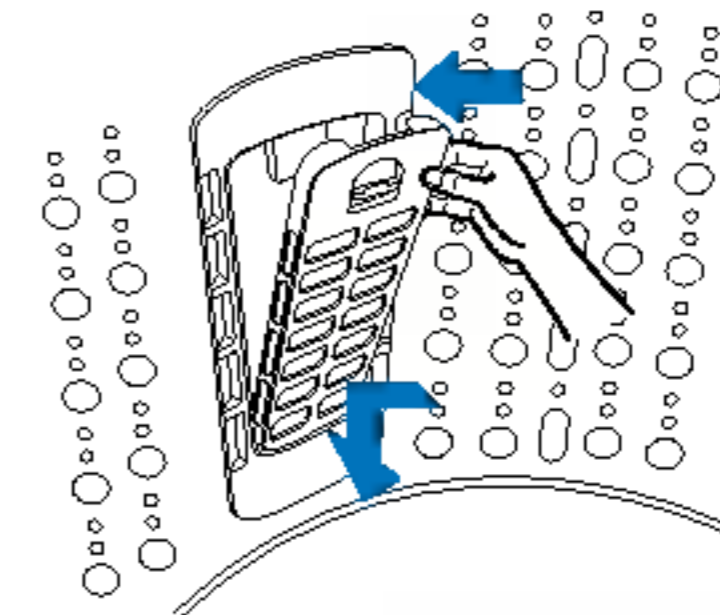

- Without multi clean filter, laundry may get damaged.

- Clean multi clean filter as often as possible. (Foreign objects accumulation may cause smell and filtering performance will be worsened.)
- In order to reduce lint generation,
 - laundry which creates lint easily should get turned inside out.
 - Wash load sorted by color.

To Clean the Pump casing (for pump model)

1

Place a towel on the floor under the drain pump cap. Excess water may flow out.

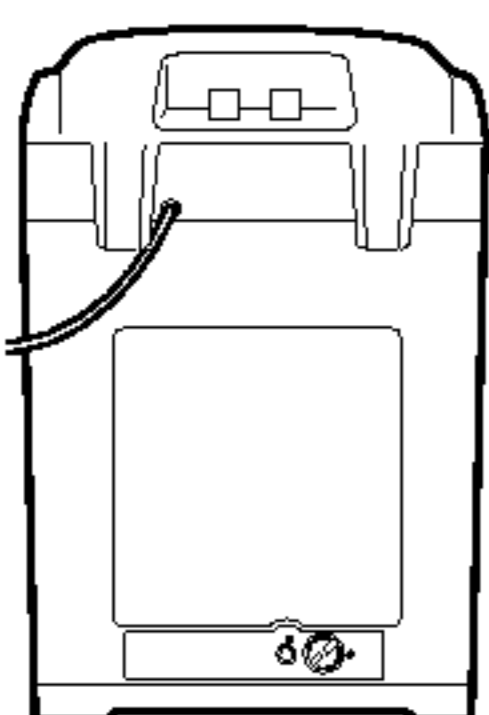

2

Turn the cap counter-clockwise and pull it out.

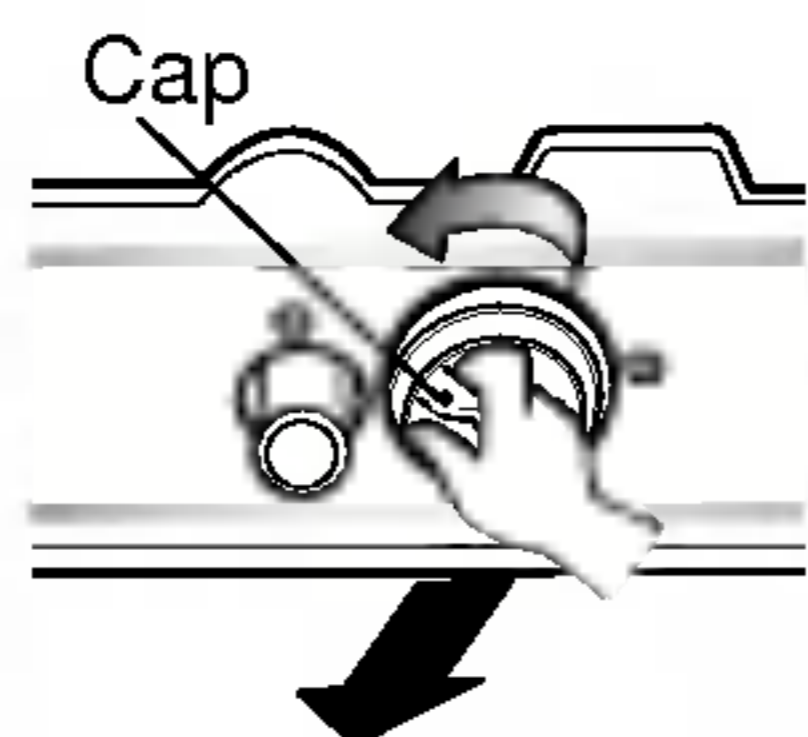

3

Remove any foreign objects and fluff inside pump casing and from the filter.

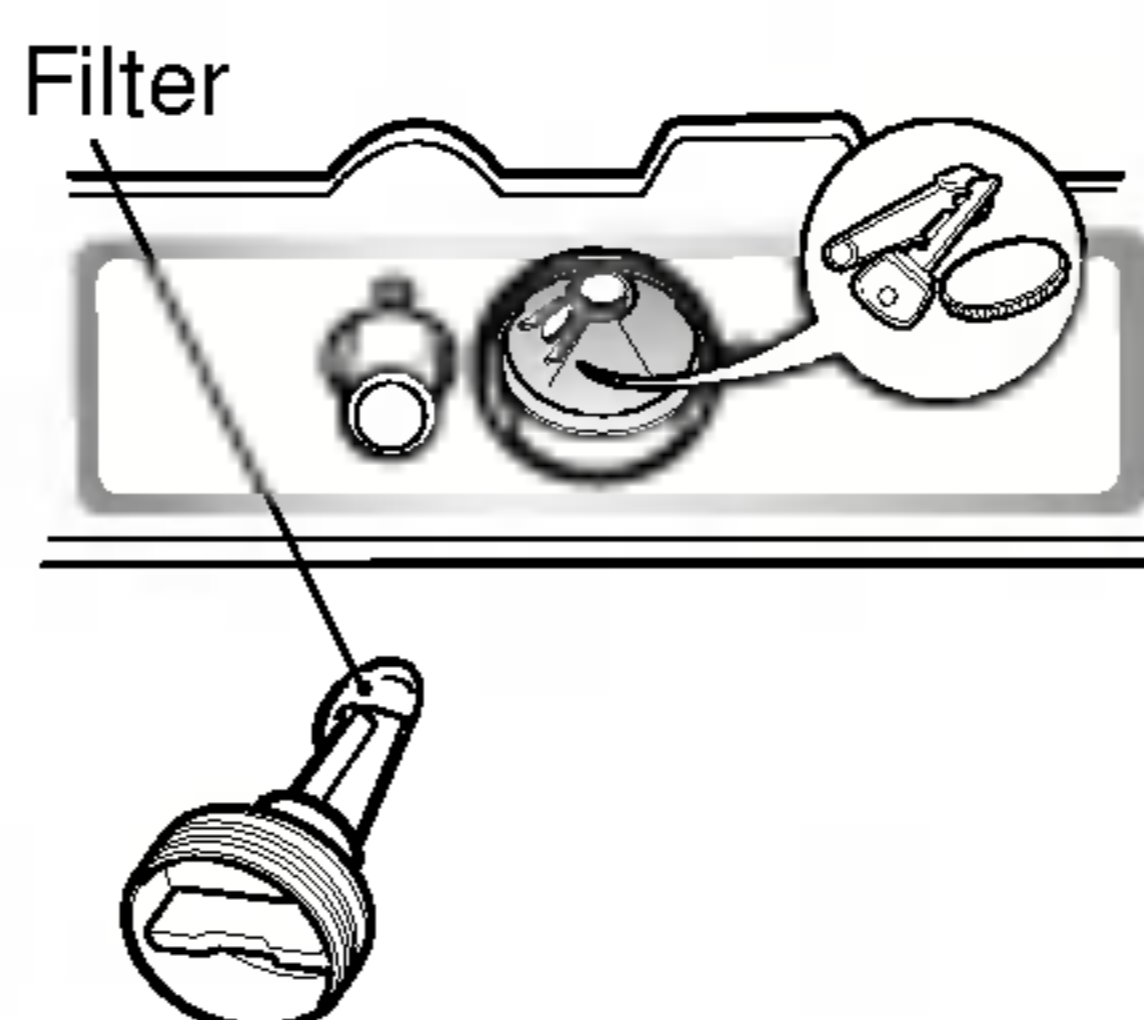

4

Replace the cap. Insert the filter along the guide ribs inside the pump casing. Filter must face the guide ribs inside pump casing and securely turn the cap clockwise.

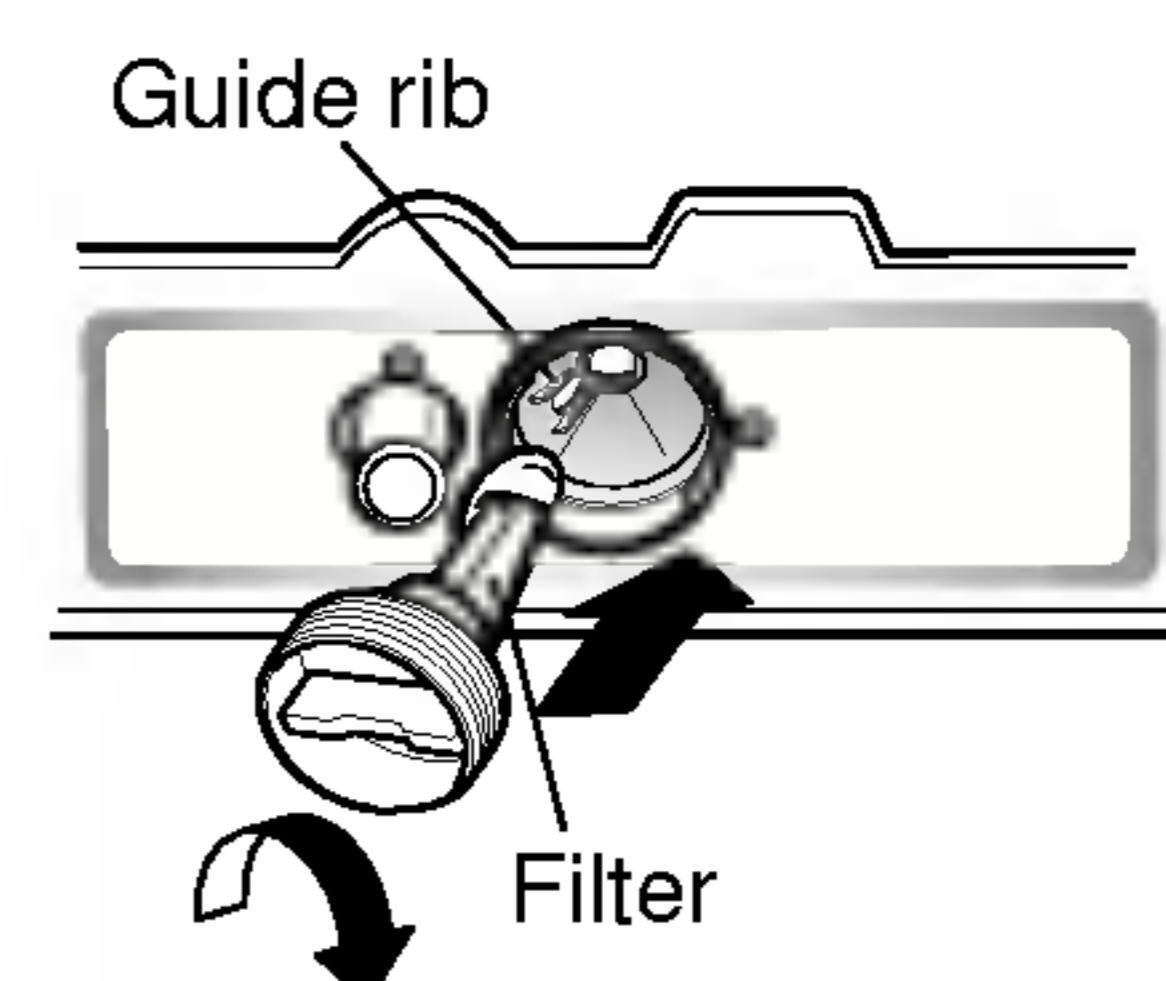

Caution

- Check if water leaks after reassembling. (The Rubber ring is in the cap)

Cleaning

WHEN THERE IS A FEAR OF FREEZING

- 1 Close the water taps and remove the water supply hose.
- 2 Remove the water which remains in the water supply.
- 3 Lower the drain hose and drain the water in the bowl and the drain hose by spinning.

IF FROZEN

- 1 Remove the water supply hose, and immerse it in hot water at approx.. 40 °C.
- 2 Pour approx.. 2 litres of hot water at approx.. 40 °C, into the bowl and let it stand for 10 minutes.
- 3 Connect the water supply hose to the water tap and confirm that the washing machine performs the supply and drainage of water.

- Wash Inner-tub** Leave the lid open after washing to allow moisture to evaporate. If you want to clean the inner-tub use a clean soft cloth dampened with liquid detergent, then rinse. (Do not use harsh or gritty cleaners.)
- Inlet Hoses** Hoses connecting washer to faucet should be replaced every 5 years.
- Exterior** Immediately wipe off any spills. Wipe with damp cloth. Try not to hit surface with sharp objects.
- Long Vacations** Be sure water supply is shut off at faucets. Drain all water from hoses if weather will be below freezing.

SCRUD

Scrud is the name given to the waxy build-up that can occur within any washer when the fabric softener comes into contact with detergent. This build-up is not brought about by a fault in the machine.

If scrud is allowed to build-up in the machine it can result in stains on your clothes or an unpleasant smell in your washer.

If you wish to use fabric softener we recommend.

- Using fabric the dispenser, do not splash or overfill.
- Clean dispenser as soon as the cycle has finished.
- Clean your machine regularly
- Cold water washing increases the chance of this build-up occurring. We recommend a warm or hot wash at regular intervals e.g. approx. every 5th wash.
- Fabric softener of thinner consistency is less likely to leave residue on the dispenser and contribute to a build-up

CLEANING THE INSIDE OF YOUR WASHER

- Fill your machine with hot water. Add about two cups of a powder detergent that contains phosphate.
- Let it rotate for several minutes.
- Stop the machine, drain the machine and run the machine through a regular cycle.
We do not recommend that you wash clothes during this procedure.

Troubleshooting

Look for your problem below, then check the things we suggest. More often than not, this will give you the answer to your problem. And you'll be able to carry on without having to telephone your service center.

WASH PROBLEM

Problem	Possible Causes	What To Do
Lint or residue on clothes	<p>Incorrect sorting</p> <p>Washing too long</p> <p>Natural By-product When Washing Certain Items</p>	<ul style="list-style-type: none"> • Separate lint producers from lint collectors. • Wash small loads for a shorter time than larger loads. • Some lint is normal. Using the dryer should remove any lint not removed by the washer.
Detergent on clothes	Detergent not dissolving	<ul style="list-style-type: none"> • Use warmer water temperature. • Try pre-dissolving the detergent in warm water • Try a liquid detergent.
Black spots on clothes	<p>Incorrect use of fabric softener</p> <p>Dye transfer</p> <p>Not enough detergent used</p> <p>A buildup caused by the interaction of fabric softener and detergent can flake off and marks clothes.</p>	<ul style="list-style-type: none"> • When filling dispenser, do not splash or overfill. • Never pour fabric softener directly on clothes. • Pre-treat stain and rewash. • Sort whites or lightly colored items from dark colors. <ul style="list-style-type: none"> - Wash and dry non-colorfast clothes separately • Using insufficient detergent for the amount of soil on the clothes, can result in black marks on clothes • Cleaning the inside of your washing machine
Fabric damage (Snags, holes, tears, rips or excessive wear)	<p>Pins, snaps, hooks, sharp buttons, belt buckles, zippers, and sharp objects left in pockets</p> <p>Chemical Damage</p> <p>a. Chlorine Bleach</p> <p>b. Battery Acid</p> <p>c. Hydrogen Peroxide</p> <p>d. Skin & Hair Care Products</p> <p>Non-chemical Damage</p> <p>a. Age & Normal Use</p> <p>b. Poor Construction</p> <p>c. Overloading</p> <p>d. Mice & Insects</p> <p>e. Sunlight</p>	<p>Fasten snaps, hooks, buttons, and zippers.</p> <p>Remove any loose brassiere wires.</p> <p>Remove objects in pockets and sharp buttons.</p> <p>Turn knits (which snag easily) inside out.</p> <p>Dilute bleach or use the dispenser (See User's Guide)</p> <p>Use caution around battery acids, skin and hair care products - these can remove color and cause holes or tears in fabrics.</p> <p>Check construction carefully when purchasing</p> <p>Mend any damage before laundering</p>



Troubleshooting

WASH PROBLEM

Problem	Possible Causes	What To Do
The laundry comes out dirty	Water temperature is too cold.	<ul style="list-style-type: none"> • Use warmer water temperature
	Water temperature is not correct	<ul style="list-style-type: none"> • Select the wash temperature according to soil type. • For example, blood and mud are better washed in cold water, while oily soils wash better in warmer water.
	Stain is not pre-treated	<ul style="list-style-type: none"> • Brush a little detergent dissolved in water onto stains like collars and cuffs to help shift dirt. • Wash stains as soon as possible. The longer they are left the harder they are to remove.
	Washer is overloaded	<ul style="list-style-type: none"> • Wash smaller loads at a time.
	Incorrect sorting	<ul style="list-style-type: none"> • White clothes are better washed separately. Separate light and heavily soiled items, as clothes can pick up soil from dirty wash water. • Loads made up of articles of varying sizes will wash better (e.g. full loads of sheets may not wash that well).
	Insufficient detergent	<ul style="list-style-type: none"> • Not enough detergent for load size or amount of soil. Hard water requires more detergent than soft water.
Pilling	Result of normal wear on poly-cotton blends and fuzzy fabrics	<ul style="list-style-type: none"> • While this is not caused by the washer, you can slow the pilling process by washing garments inside out.
Grayed or yellowed clothes	Not enough detergent	Use more detergent (especially with larger loads).
	Water is not hot enough	Make sure water heater is delivering water at 120°F~140°F. (48°C~60°C.).
	Washer is overloaded	Select load size to match clothes load.
	Dye transfer	Sort clothes by color. If fabric label states wash separately, unstable dyes may be indicated.

Troubleshooting

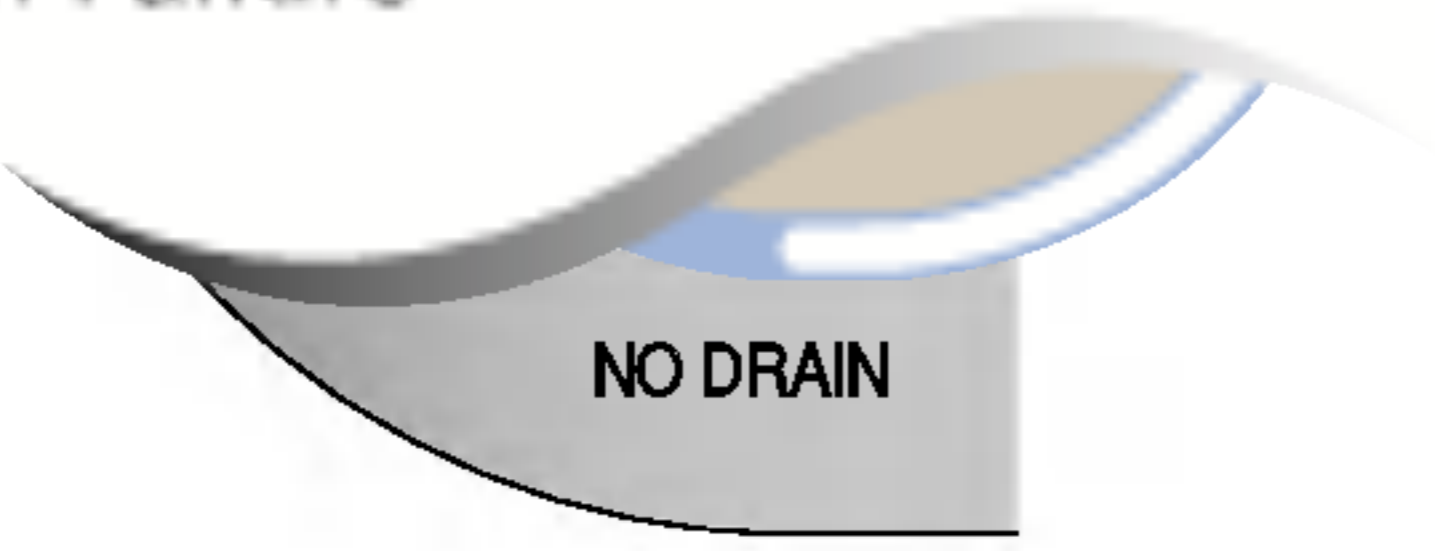
Before calling for service check the problem against the list belows.

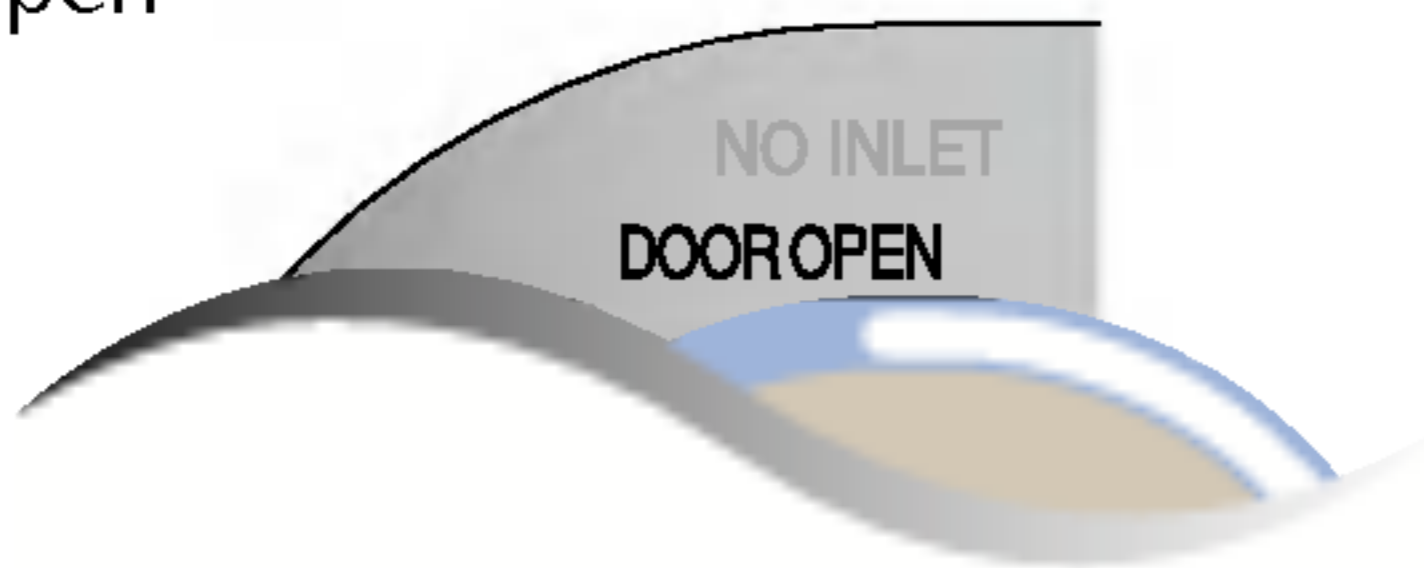
Symptom	Error Message	Check up
Water Supply Failure		<ul style="list-style-type: none"> • Is the water tap shut off? • Is the water supply cut off ? • Is the tap or water supply hose frozen ? • Is the water pressure low or is the filter of the inlet valve clogged with impurities? • Is Hot/Cold selected to Hot when the hose connected is Cold? • Is the Cold hose connected to Hot?
Drain/Spin Failure		<ul style="list-style-type: none"> • Is the drain hose positioned correctly? • Is the drain hose bent or placed too high? • Is the internal part of the hose or drain pump (only pump model) clogged with impurities? • Is the laundry evenly balanced? • Is the washing machine placed on a flat surface?
Drain Failure		<ul style="list-style-type: none"> • Is the drain hose positioned correctly? • Is the drain hose bent or placed too high? • Is the internal part of the hose or drain pump (only pump model) clogged with impurities?
Spin Failure		<ul style="list-style-type: none"> • Is the laundry evenly balanced? • Is the washing machine placed on a flat surface?
Door(Lid) Open		<ul style="list-style-type: none"> • Is the lid closed?

- Ask for help at the LG Electronic branch of the Service Center

Abnormal level sensing.



Power failure



Overflow failure



Abnormal motor



S pecification

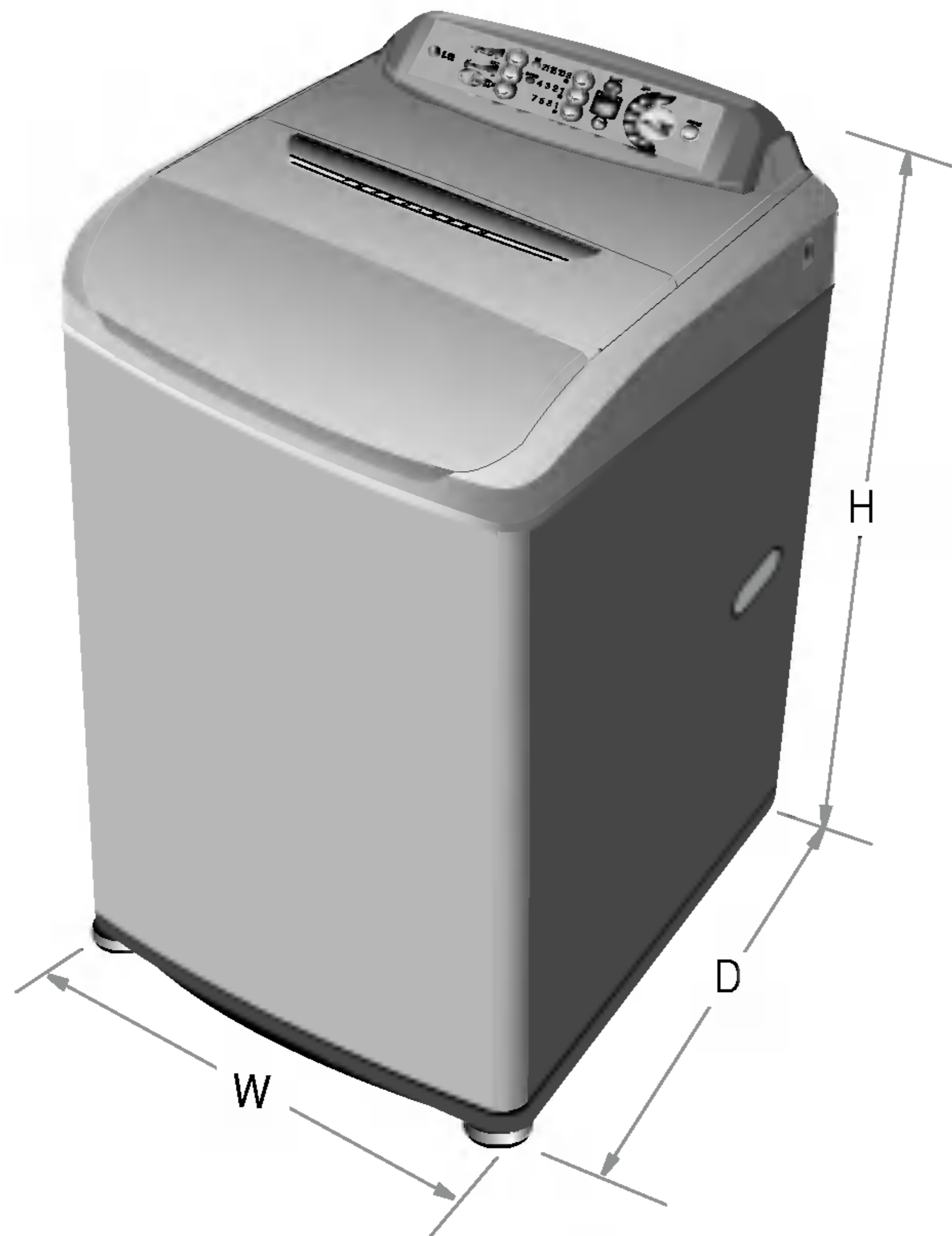

Model	WT-R1071TP/R1172TP	WT-R1371TP/R1372TP
Weight	48 kg	49 kg
Size	632(W) x 693(D) x1039(H)	
Water tap pressure	30 -800 kPa (0.3 -8.0 kgf /cm ²)	

※ The appearance and specifications may be varied without notice to raise the units quality.

■ Serial Number

How to read Serial Number.

:There is attached a Serial Number label on back side of this product.

Example) **805KW00001**

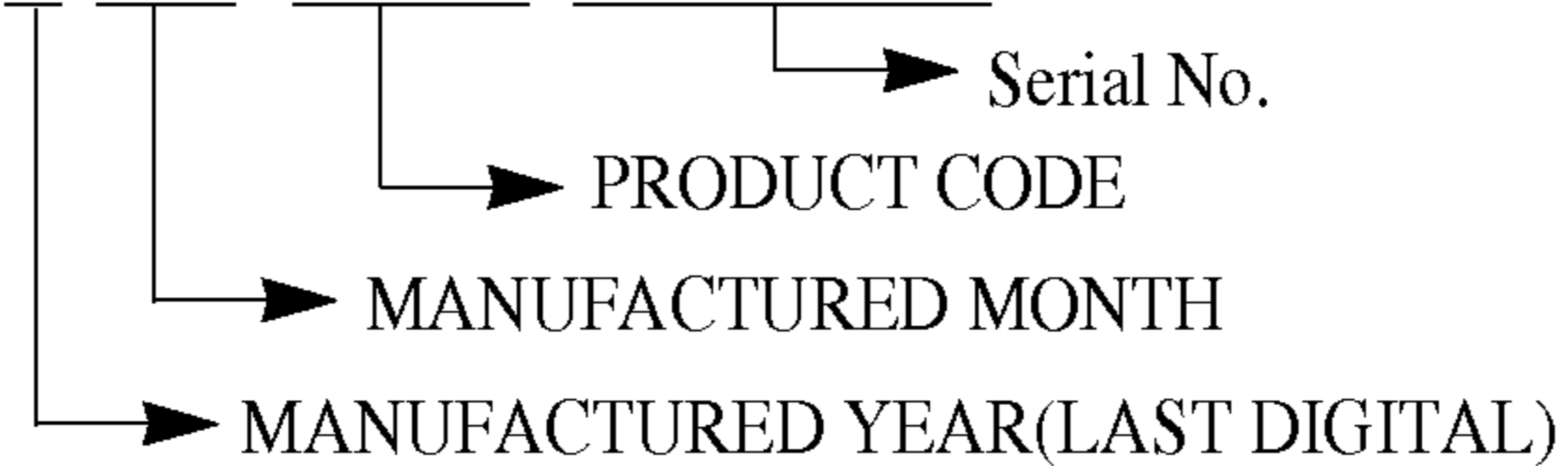

التركيب والاستواء

١ ضع جهاز الغسالة على أرض مستوية وثابتة ومكان مناسب للتهوية .

من الموصى به ترك مسافة ٢ سم على الأقل في الجانبين اليمين واليسار من الجهاز للتركيب السهل. بالنسبة للخلف، اترك مسافة ١٠ سم على الأقل.

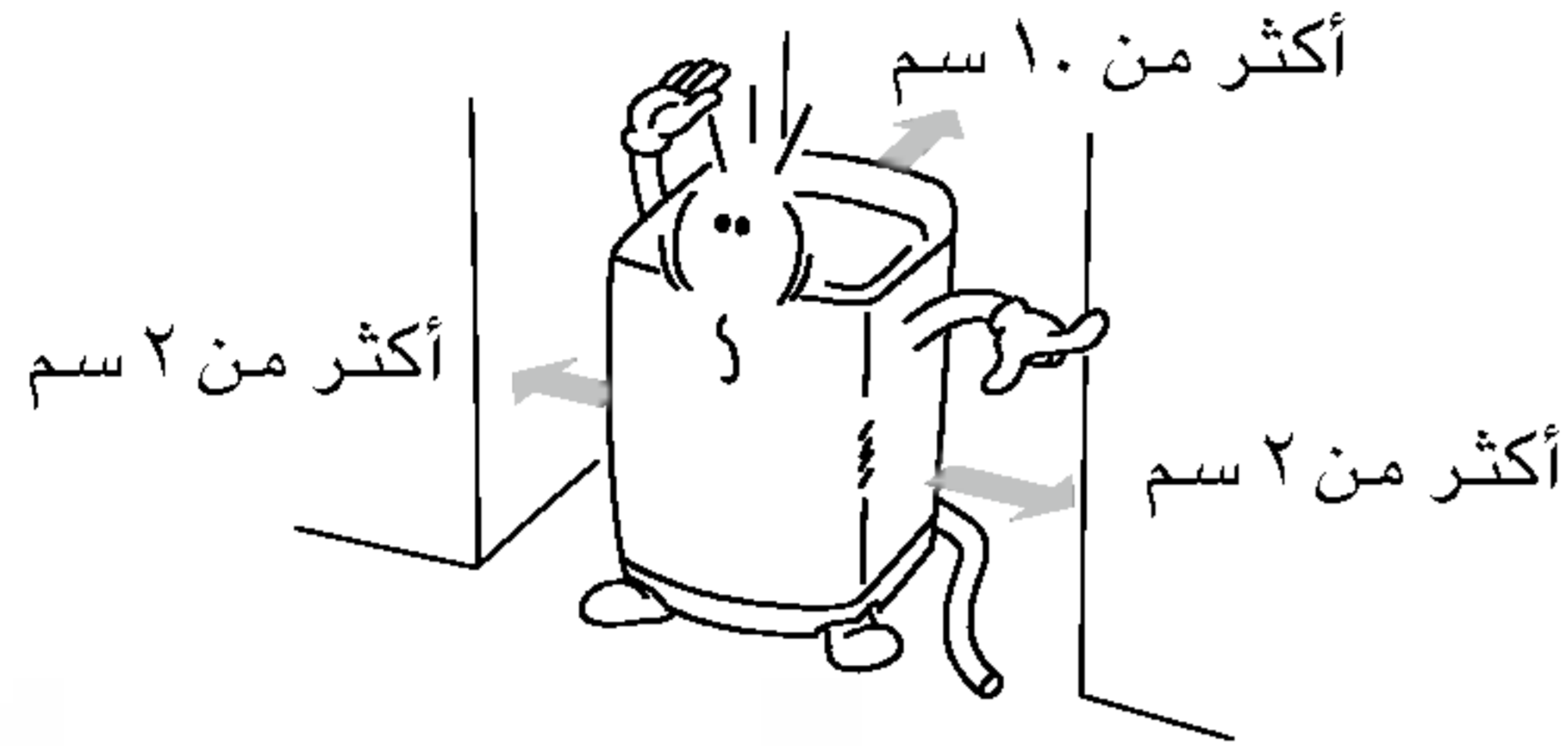

تحذير

إذا رُكِّبَ جهاز الغسالة على أرض غير مستوية وضعيفة أو مائلة ، قد يحدث الاهتزاز والخطأ في التجفيف أو يعرض "SPIN Er." لا بد من تركيب الجهاز على أرض ثابتة ومستوية لمنع حدوث الخطأ في التجفيف.

٢ تأكد من استواء الجهاز .

افتح الغطاء وانظر إلى الجهاز من الأعلى للتأكد مما يكون مبيّنا في الشكل. تأكد من أن مؤشر الاستواء بالفقاعة موضوع في الوسط.

المنظر العلوي للجهاز

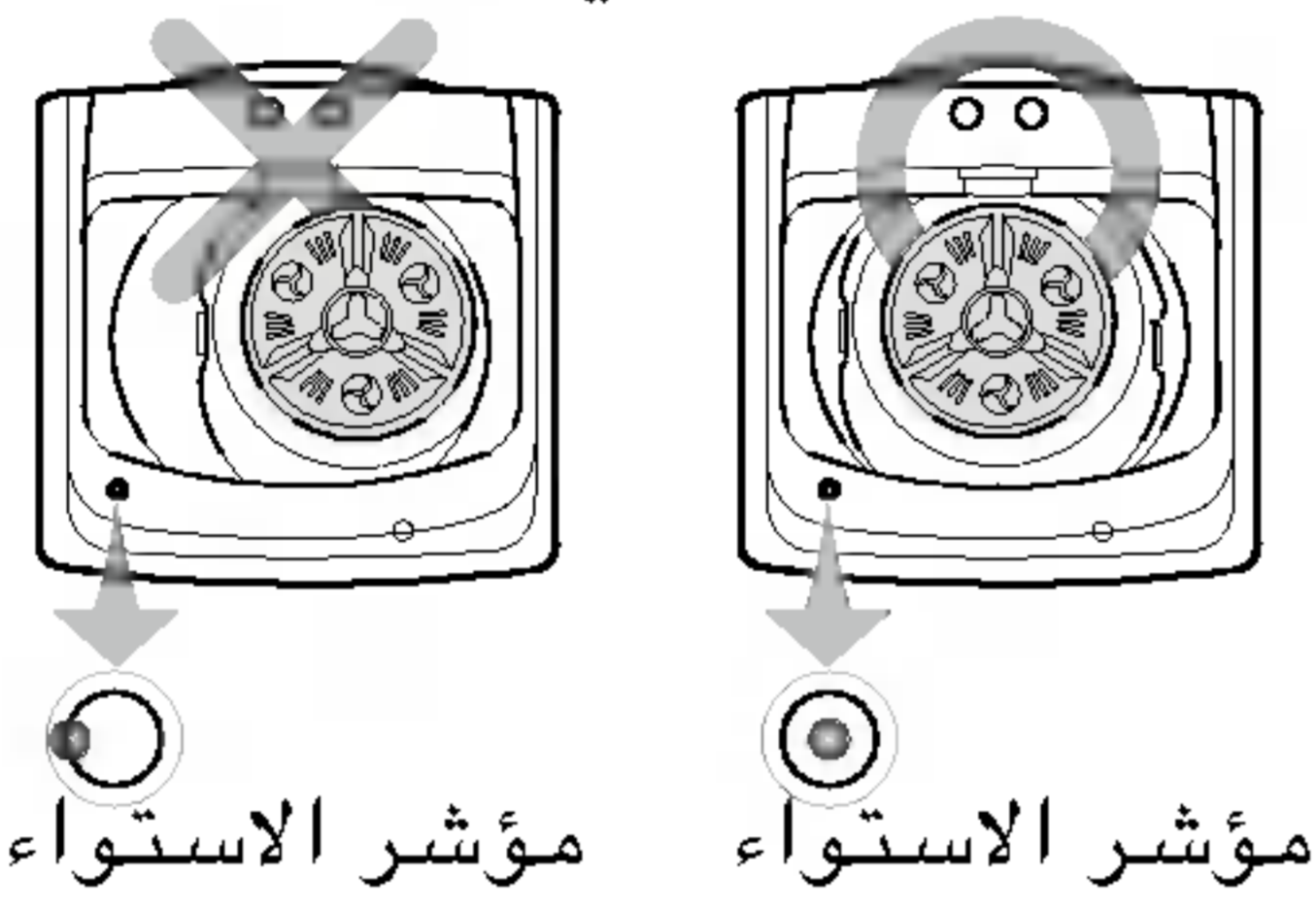

مؤشر الاستواء

مؤشر الاستواء

٣ ضبط استواء الجهاز

ارفع الجزء الأمامي من جهاز الغسالة ودور الأرجل القابلة للتعديل حتى تقع الفقاعة في الوسط.



الأرجل القابلة للتعديل

تحذير

إذا تم توريد الطاقة الكهربائية من سلك جهاز إضافي أو مولد، لا بد من وضع سلك الجهاز الإضافي أو مخرج التيار القابل للنقل بحيث لا يتعرض للرطوبة.

تحذير

تنبيهات عن تناول سلك التيار

من الموصى به أن مطعم الأجهزة موصولة إلى مخرج تيار مستقل؛ إنه مخرج تيار فردي يوصل الطاقة إلى الجهاز فقط وليس له أي مخرج إضافي أو فرعي. تأكد من صفحة المواصفات من دليل المالك هذا للتأكد.

لا توصل إلى مخرج التيار الجداري حملا زائدا. ومن الأخطار الحمل الزائد في مخرج التيار الجداري، رخو مخرج الجدار التياراتي أو تضرره، أسلاك التيار الإضافية، أسلاك التيار البالية، أو تضرر أو شق في عزل الأسلاك. وأي من هذه قد يؤدي إلى إحداث صدمات كهربائية أو حريق.

افحص سلك التيار للجهاز دوريا وإذا حدث ضرر أو تشويه في الجهاز، انزع قابس الجهاز من مخرج التيار، ووقف الجهاز عن التشغيل واستبدل سلك التيار بسلك صحيح من قبل الفني المختص المؤهل. احم سلك التيار من التشغيل الخاطئ الفيزيائي أو الميكانيكي، مثل اللي والتجعيد، الثقب والاستخدام قريبا من الباب أو على الجدران.

خذ عناية خاصة عن القابس ومخرج التيار الجداري ونقطة في الجهاز يخرج منها سلك التيار .

تنظيف

لتنظيف المصفاة في صمام المدخل إذا لم تكن المصفاة نظيفة أو كانت مسدودة بالجزيئات (مثل رمل) عند إمداد الماء الى الحوض ، نظّف المصفاة في صمام الدخول أحياناً.

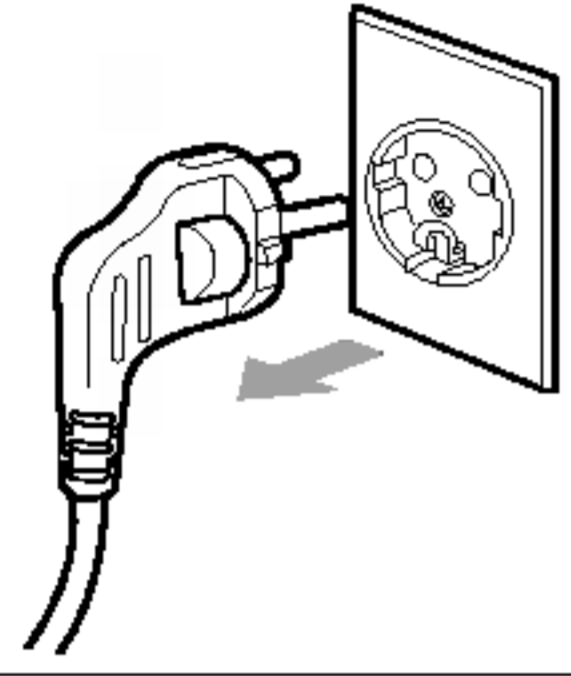

١ اطفأ الطاقة على الجهاز قبل نزع سلك التيار.

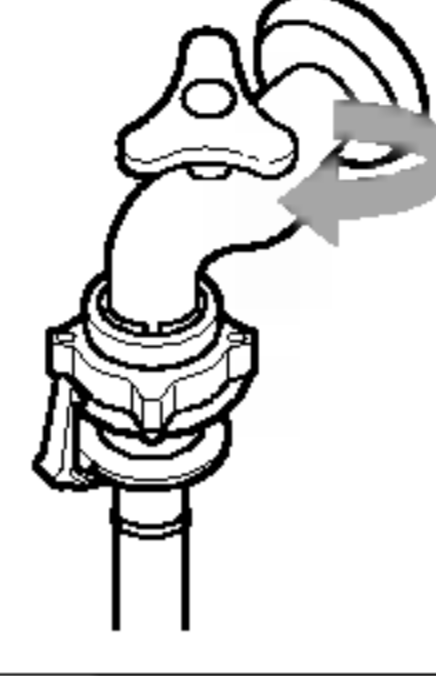

٢ اغلق الحنفية قبل إطفاء الطاقة. اختر الماء الحار/الماء البارد ثم اضغط على زر (التشغيل/التوقف المؤقت) لإزالة الماء من الجهاز تماماً.

٣ بعد نزع خرطوم إمداد الماء، اسحب المصفاة.

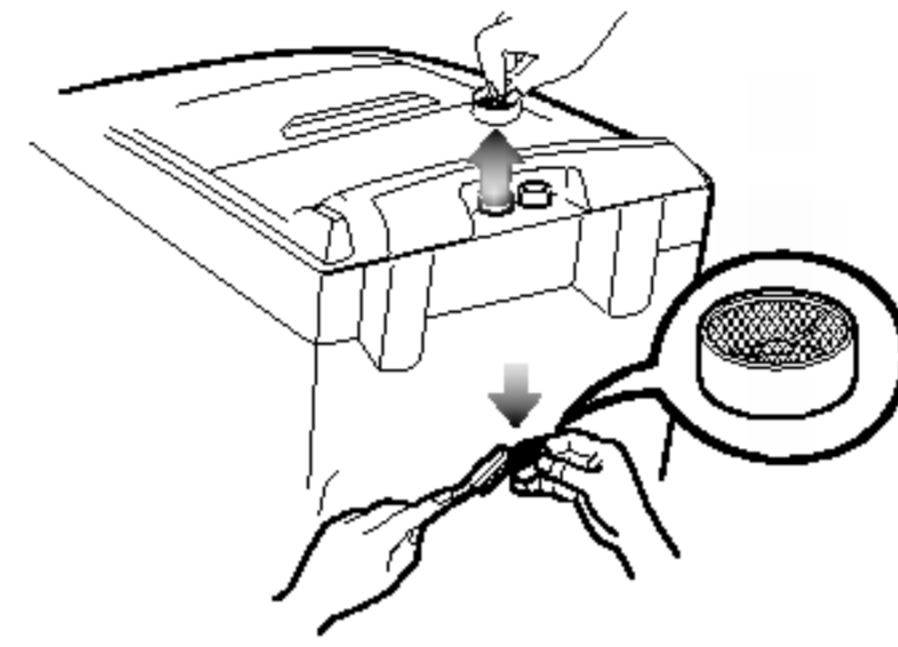

٤ ثم استخدم فرشاة لتنظيف المصفاة.

تحذير

* قبل تنظيف المصفاة، لا بد من إزالة الجزيئات المتسخة في خرطوم إمداد الماء.

كيفية تنظيف مصفاة التنظيف المتعددة

١ ادفع الجزء الأعلى من مصفاة التنظيف المتعددة واسحبه الى الأمام.

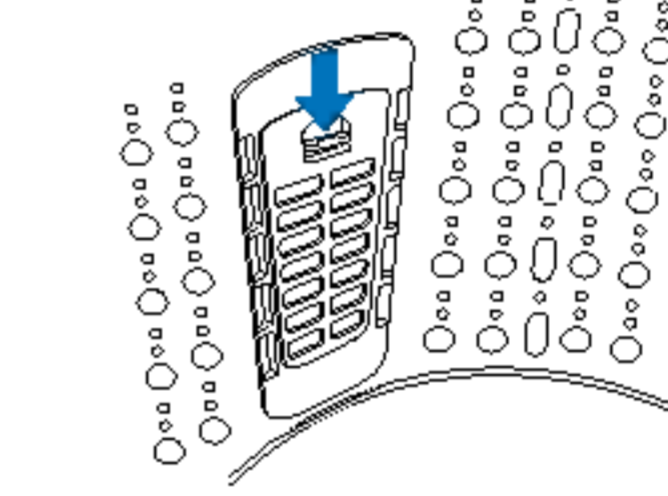

٢ افتح الغطاء وازل النسييل ثم اغسله.

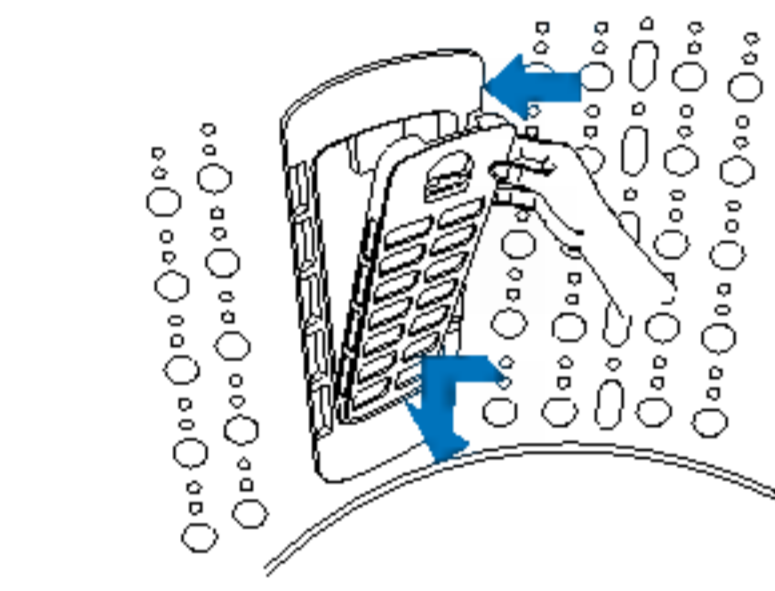
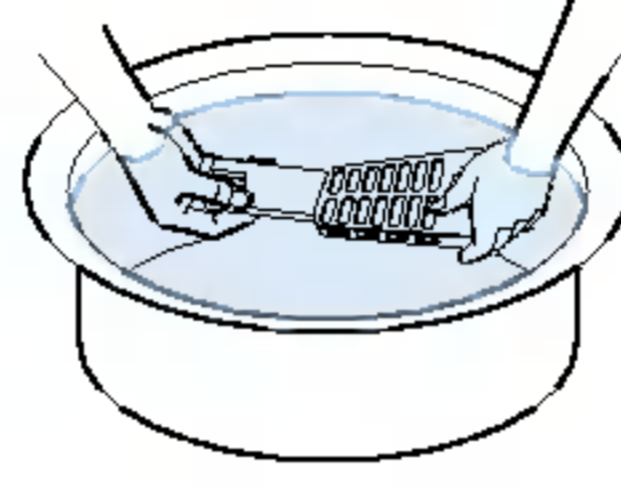

* بدون مصفاة التنظيف المتعددة ، الملابس قد تتسخ.

* نظّف مصفاة التنظيف المتعددة على فترة قصيرة على قدر إمكان.
* من أجل خفض توليد النسييل.
- الملابس التي تصنع النسييل بسهولة لا بد من تقليلها عند الغسيل.
- اغسل الملابس بعد تصنيفها حسب اللون.

لتنظيف كيس المضخة (بالنسبة للموديل بالمضخة)

١ ضع منشفة على الأرض تحت غطاء مضخة التصريف. وقد يجري اللماء الفائض.

٢ دوّر الغطاء باتجاه عقرب الساعة واسحبه الى الخارج.

٣ انزع أيشاء غريبة والزغب من داخل كيس المضخة ومن المصفاة.

٤ استبدل الغطاء. وادخل المصفاة تبعاً لخطوط الدليل داخل كيس المضخة. ولا بد من توجيه المصفاة الى خطوط الدليل داخل كيس المضخة ودوّر الغطاء باتجاه عقرب الساعة بإحكام.

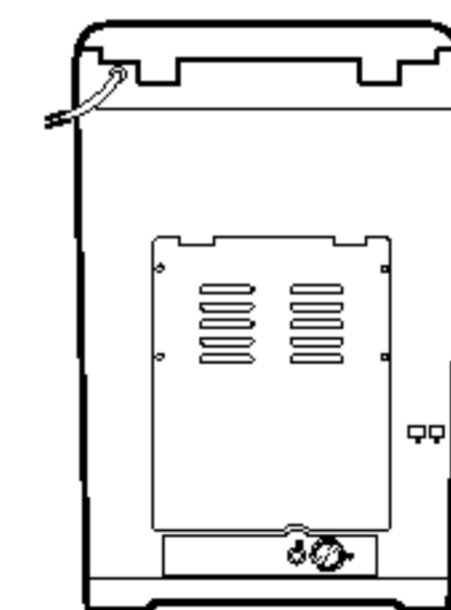
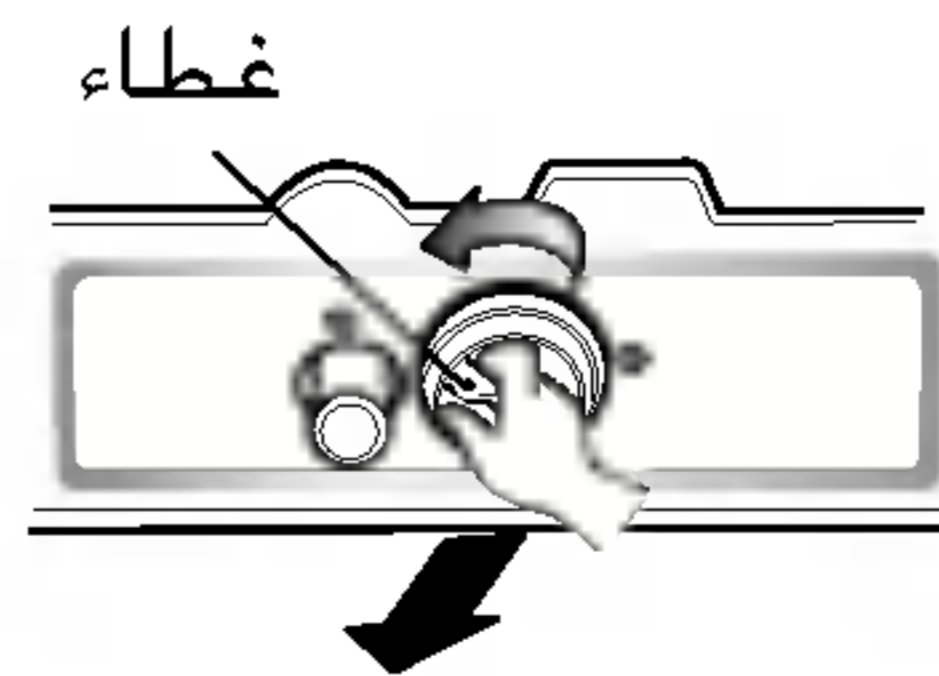
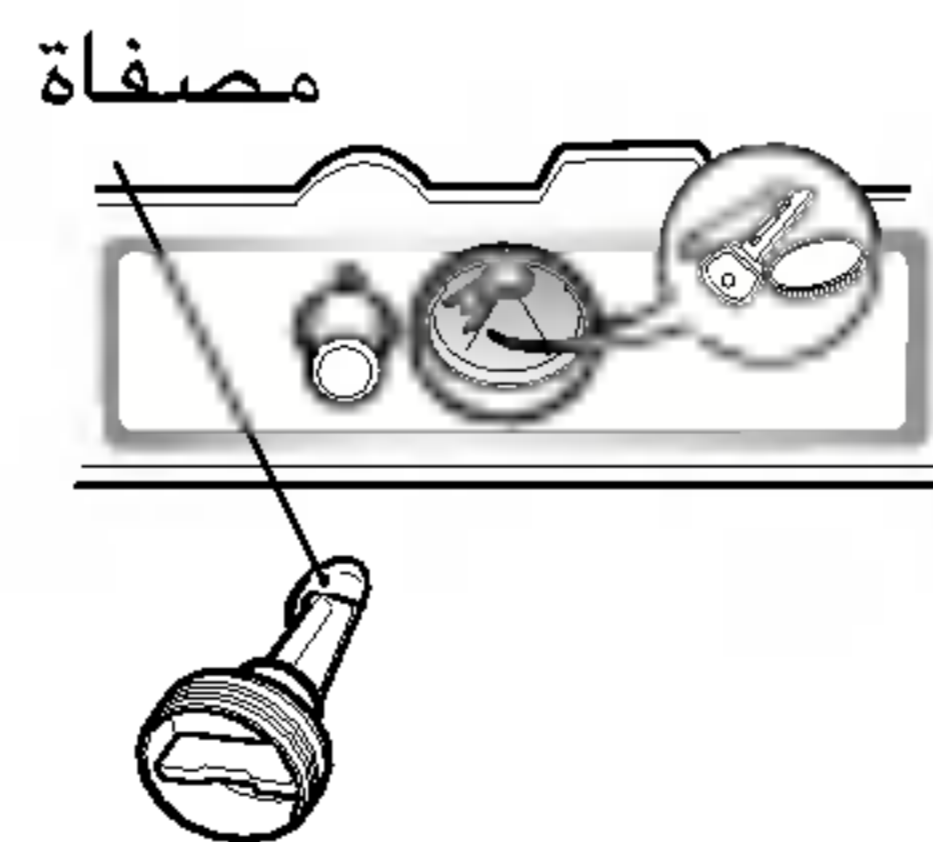

تحذير

تأكد من عدم تسرب الماء بعد إعادة التجميع. (الحلقة المطاطية موجودة في الغطاء)