

Table of Contents

ENGLISH

Installation and Connection

Safety Precautions	A1
Accessories	A4
Using the Remote Control	A5
To arrange cables in order - Optional	A12
Connecting the Speakers - Optional	A13
Name and Function of the Parts	A14
Connecting the Monitor	A15
Connecting the Monitor	A15
Connecting the VCR/DVD	A17
Connecting the HDTV/DVD	A19
Connecting to DVI-D(HDCP) from the VCR/DVD/Set-top Box	A20
Connecting the TV	A21

Input Selection and Tracking

Selecting and Adjusting the Screen	A22
How to adjust the OSD(On Screen Display) Screen	A25
Set/Selects the channel when using the TV (Optional)	A26
Adjusting Screen Color	A28
Adjusting the audio function	A29
Adjusting the timer function	A30
Selecting the Options	A31
Adjusting Screen CLOCK/PHASE and Position	A33
Adjusting PIP/POP/PBP Mode (Multiple Screen) Functions	A34
Controlling the Multiple Monitors (RS-232C protocol)	A36
IR Codes	A47

Miscellaneous

Troubleshooting	A49
Specifications	A52



is a trademark of SRS Labs, Inc.
technology is incorporated under license from SRS Labs, Inc.

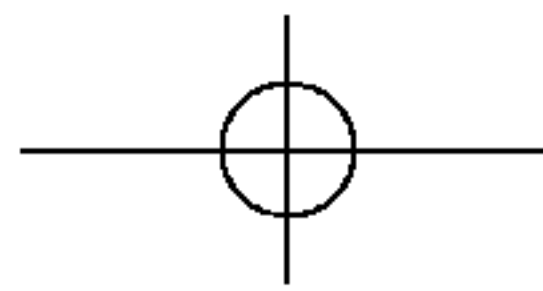

Safety Precautions

Please read these safety precautions carefully before using the monitor.

⚠ Warning If you ignore the warning message, you may be seriously injured or there is a possibility of accident or death.

⚠ Caution If you ignore the caution message, you may be slightly injured or the product may be damaged

● Precautions in installing the Monitor

⚠ Warning

- **Keep away from heat sources like electrical heaters.**
 - Electrical shock, fire, malfunction or deformation may occur.
- **Keep the packing anti-moisture material or vinyl packing out of the reach of children.**
 - Anti-moisture material is harmful if swallowed. If swallowed by mistake, force the patient to vomit and visit the nearest hospital. Additionally, vinyl packing can cause suffocation. Keep it out of the reach of children.
- **Do not put heavy objects on the monitor or sit upon it.**
 - If the monitor collapses or is dropped, you may be injured. Children must pay particular attention.
- **Do not leave the power or signal cable unattended on the pathway.**
 - The passerby can falter, which can cause electrical shock, fire, product breakdown or injury.
- **Install the monitor in a neat and dry place.**
 - Dust or moisture can cause electrical shock, fire or product damage.
- **If you can smell smoke or other odors or hear a strange sound unplug the power cord and contact the service center.**
 - If you continue to use without taking proper measures, electrical shock or fire can occur.
- **If you dropped the monitor or the case is broken, turn off the monitor and unplug the power cord.**
 - If you continue to use without taking proper measures, electrical shock or fire can occur. Contact the service center.
- **Do not drop metallic objects such as coins, hair pins, chopsticks or wire into the monitor, or inflammable objects such as paper and matches. Children must pay particular attention.**
 - Electrical shock, fire or injury can occur. If a foreign object is dropped into the monitor, unplug the power cord and contact the service center.

⚠ Caution

- **Make sure the monitor ventilation hole is not blocked. Install the monitor in a suitably wide place (more than 10cm from the wall)**
 - If you install the monitor too close to the wall, it may be deformed or fire can break out due to internal heat.
- **Do not block the ventilation hole of the monitor by a tablecloth or curtain.**
 - The monitor can be deformed or fire can break out due to overheating inside the monitor.
- **Install the monitor on a flat and stable place that has no risk of dropping the monitor.**
 - If the monitor is dropped, you may be injured or the monitor may be broken.
- **Install the monitor where no EMI occurs.**
- **Keep the monitor away from direct sunlight.**
 - The monitor can be damaged.

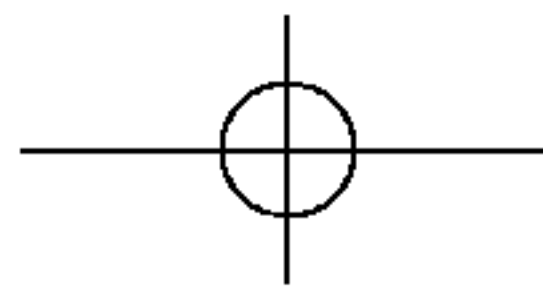

● Electrical Power Related Precautions

⚠ Warning

- **Make sure to connect the power cable to the grounded current.**
 - You may be electrocuted or injured.
- **Use the rated voltage only.**
 - The monitor can be damaged, or you may be electrocuted.
- **During a thunder or lightning storm, unplug the power cable or signal cable.**
 - You may be electrocuted or a fire can break out.
- **Do not connect several extension cords, electrical appliances or electrical heaters to a single outlet. Use a power bar with a grounding terminal designed for exclusive use with the computer.**
 - A fire can break out due to overheating.
- **Do not touch the power plug with wet hands. Additionally, if the cord pin is wet or covered with dust, dry the power plug completely or wipe dust off.**
 - You may be electrocuted due to excess moisture.
- **If you don't intend to use the monitor for a long time, unplug the power cable from the monitor.**
 - Covering dust can cause a fire, or insulation deterioration can cause electric leakage, electric shock or fire.
- **Fix the power cable completely.**
 - If the power cable is not fixed completely, a fire can break out.
- **Hold the plug when pulling out the power cable. Do not bend the power cord with excessive force or put heavy objects on the power cord.**
 - The power line can be damaged, which may cause electric shock or fire.
- **Do not insert a conductor (like a metal chopstick) into one end of the power cable while the other end is connected to the input terminal on the wall. Additionally, do not touch the power cable right after plugging into the wall input terminal.**
 - You may be electrocuted.

⚠ Caution

- **Do not unplug the power cord while the monitor is in use.**
 - Electrical shock can damage the monitor.

● Precautions in Moving the Monitor

⚠ Warning

- **Make sure to turn off the monitor.**
 - You may be electrocuted or the monitor can be damaged.
- **Make sure to remove all cables before moving the monitor.**
 - You may be electrocuted or the monitor can be damaged.

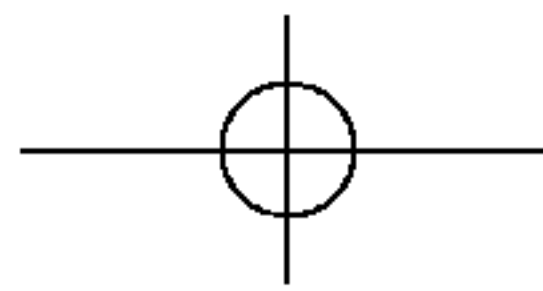

Safety Precautions

Caution

- **Do not shock the monitor when moving it.**
 - You may be electrocuted or the monitor can be damaged
- **Do not dispose the product-packing box. Use it when you move.**
- **Make the panel face forward and hold it with both hands to move.**
 - If you drop the monitor, the damaged monitor can cause electric shock or fire. Contact with the service center for repair.

Precautions in Using the Monitor

Warning

- **Do not disassemble, repair or modify the monitor at your own discretion.**
 - Fire or electric shock accident can occur.
 - Contact the service center for check, calibration or repair.
- **Do not spray water on the monitor or scrub with an inflammable substance (thinner or benzene). Fire or electric shock accident can occur**
- **Keep the monitor away from water.**
 - Fire or electric shock accident can occur.

Caution

- **Do not put or store inflammable substances near the monitor.**
 - There is a danger of explosion or fire due careless handling of the inflammable substances.
- **When cleaning the brown tube surface, unplug the power cord and scrub with soft cloth to prevent scratching. Do not clean with a wet cloth.**
 - The water can sink into the monitor, which can cause electric shock or serious malfunction.
- **Take a rest from time to time to protect your vision.**
- **Keep the monitor clean at all times.**
- **Take a comfortable and natural position when working with a monitor to relax the muscles.**
- **Take a regular break when working with a monitor for a long time.**
- **Do not press strongly upon the panel with a hand or sharp object such as nail, pencil or pen, or make a scratch on it.**
- **Keep proper distance from the monitor.**
 - Your vision may be impaired if you look at the monitor too closely.
- **Set the appropriate resolution and clock by referring to the User's Manual.**
 - Your vision can be impaired.
- **Use authorized detergent only when cleaning the monitor. (Do not use benzene, thinner or alcohol.)**
 - Monitor can be deformed.

On Disposal

- The fluorescent lamp used in this product contains a small amount of mercury.
- Do not dispose of this product with general household waste.
 - Disposal of this product must be carried out in accordance to the regulations of your local authority.

Accessories

Please check the accessories in the product package.

* The monitor and the accessories can be different from the figures shown here.

ENGLISH

Desktop Stand Type



Free Mount Type



OR

Monitor

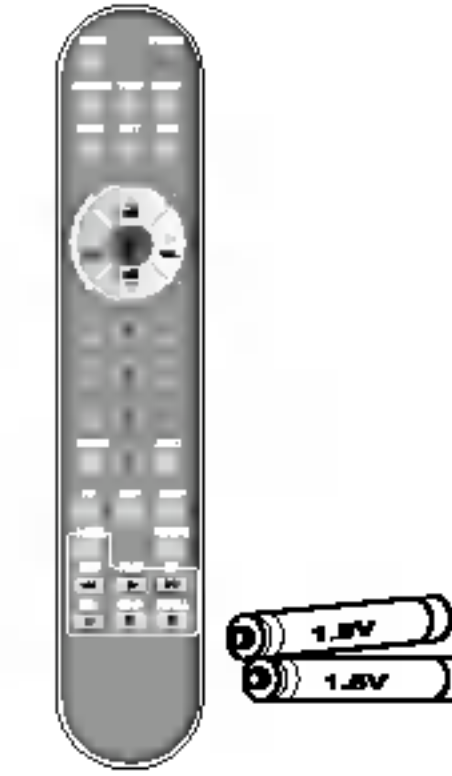

Remote Control/
Batteries

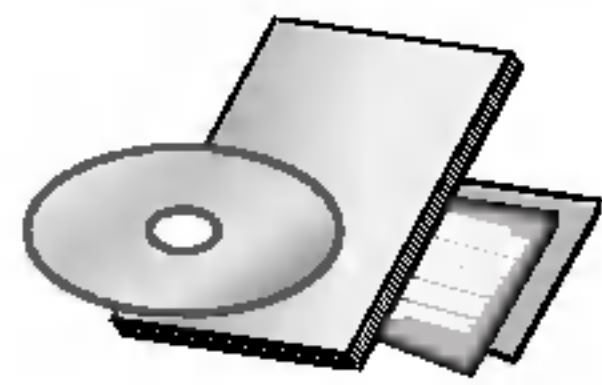

User's Guide/
Driver CD/Cards

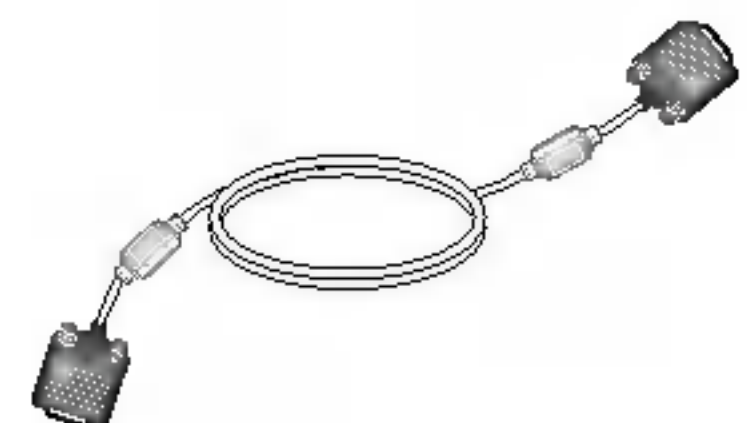

15-pin D-Sub Signal
Cable

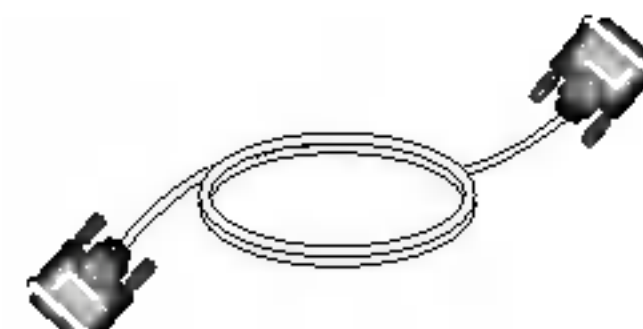

DVI-D Signal Cable

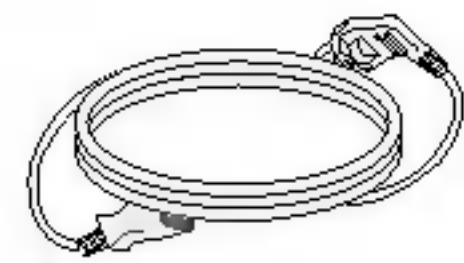

Power Cord

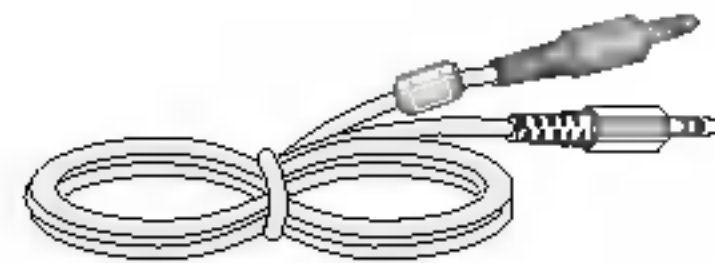

Audio Cable (PC)

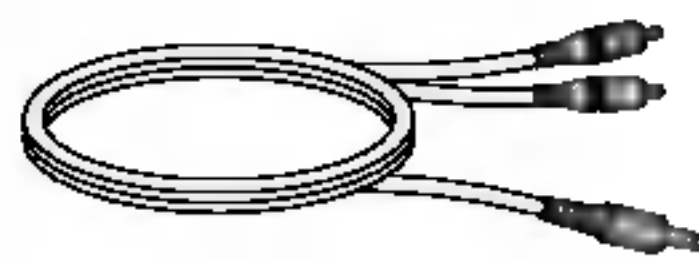

RCA-PC
Audio Cable

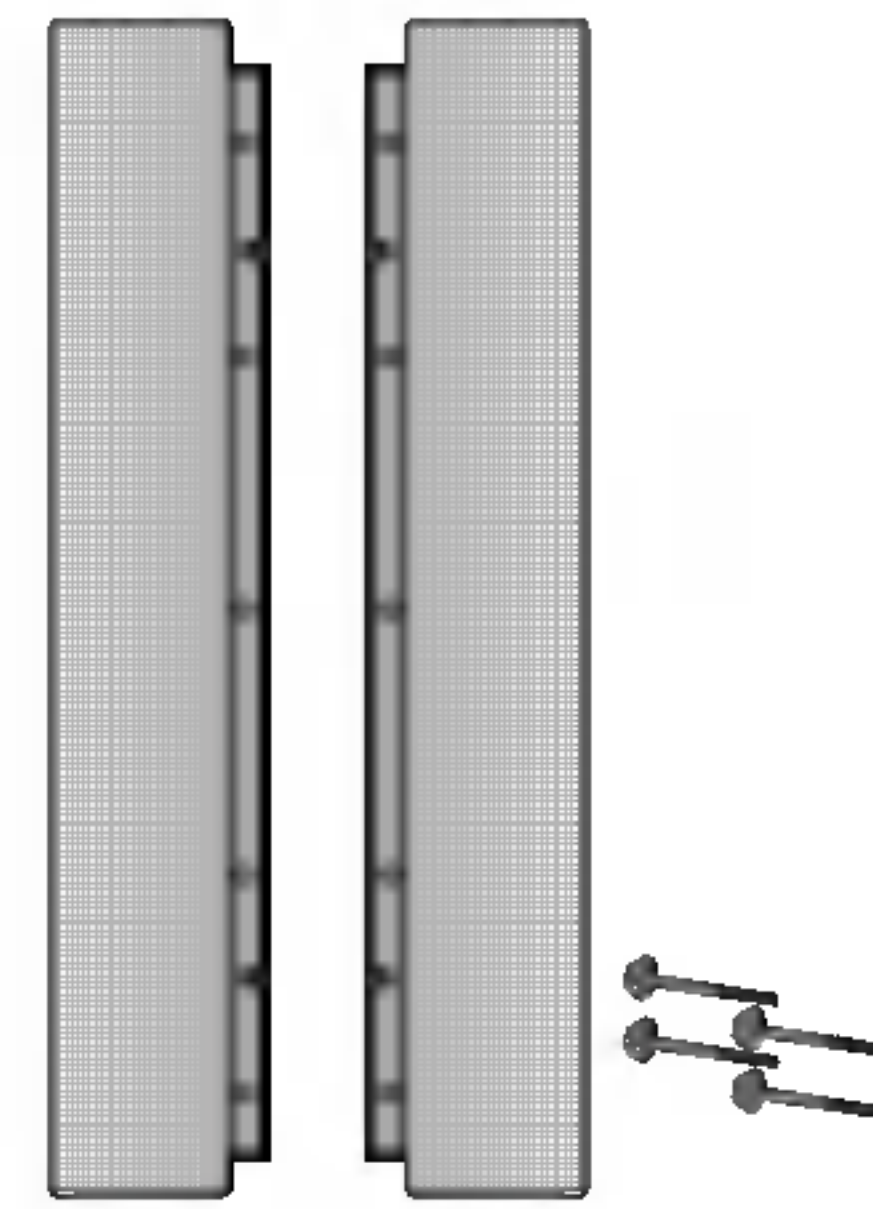

Speaker kit / Screws
(Applicable only for models
that support the speakers)

Optional

Wall-mount Rack

Please refer to the enclosed "Installation Guide" when installing the wall-mount rack.

Inserting batteries into remote control.

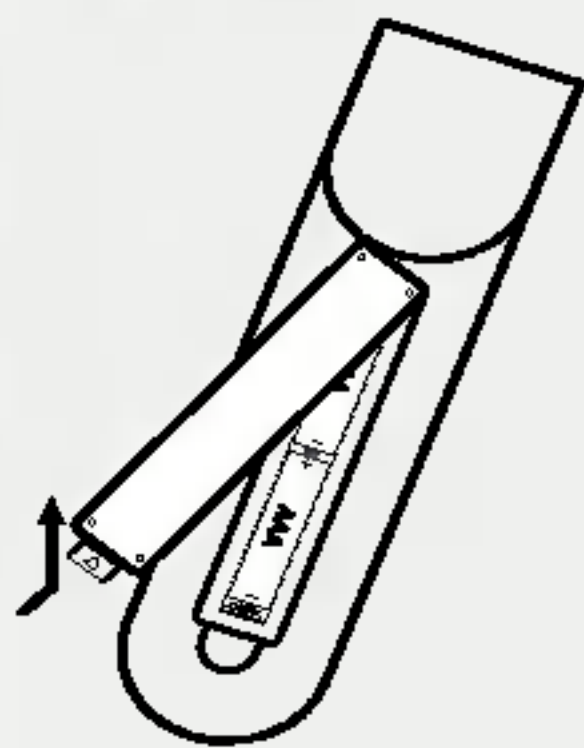

1. Take out the battery cap.
2. Insert the battery with correct polarity (+/-).
3. Close the battery cap.
 - You can use a remote controller 7 meter distance and 30 degree (left/right) within the receiving unit scope.
 - Dispose of used batteries in the recycle bin to prevent environmental pollution.

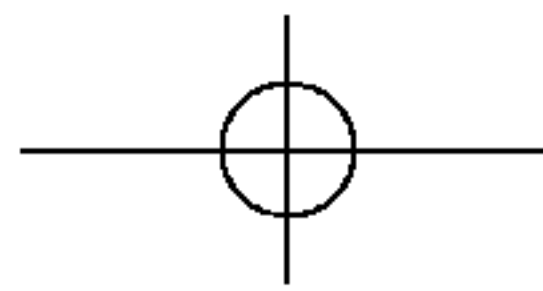

Using the Remote Control

● Name of the Remote Controller Buttons Remote Control

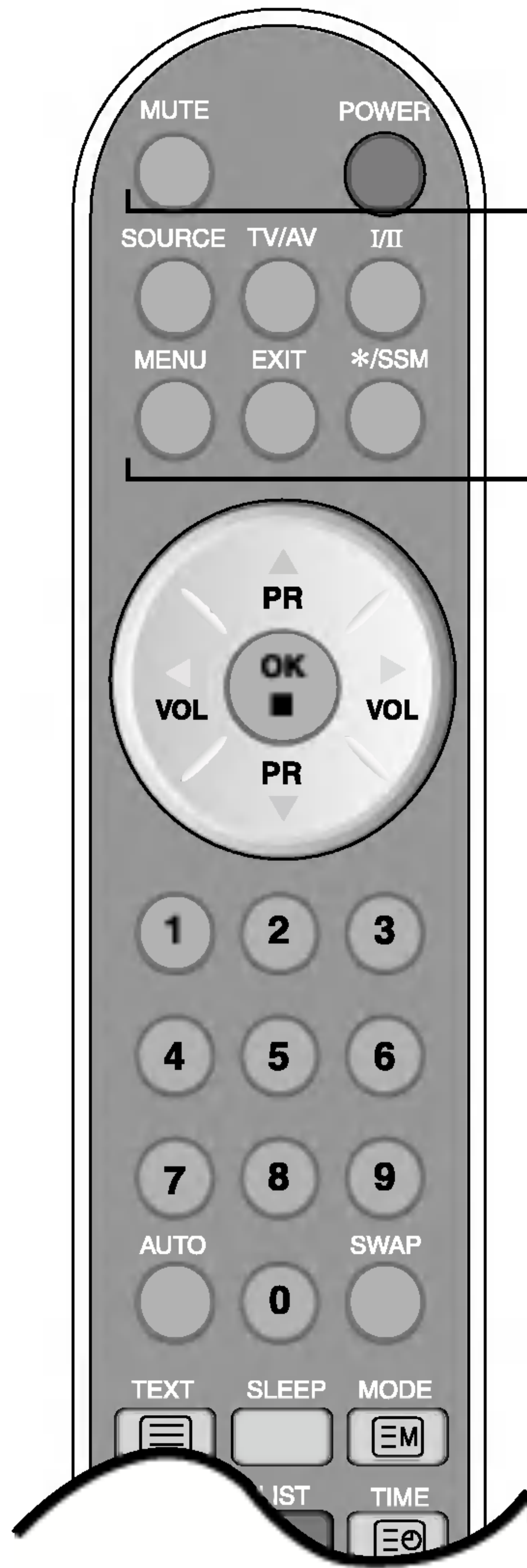

MUTE
POWER

MENU
Use this button to enter the On Screen Display menu.

EXIT
Use this button to exit the On Screen Display menu.

***/SSM (Sound Status Memory)**
Use this button to select the sound tone.

Press repeatedly to select **FLAT, MUSIC, MOVIE, SPEECH, USER** sound tone.

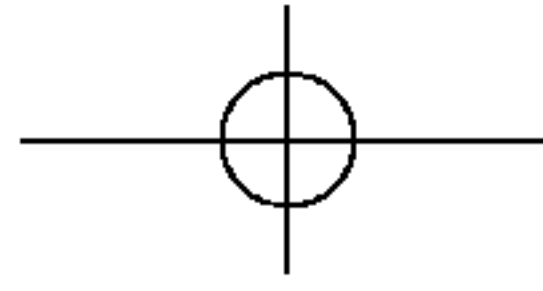

● Name of the Remote Controller Buttons

Remote Control

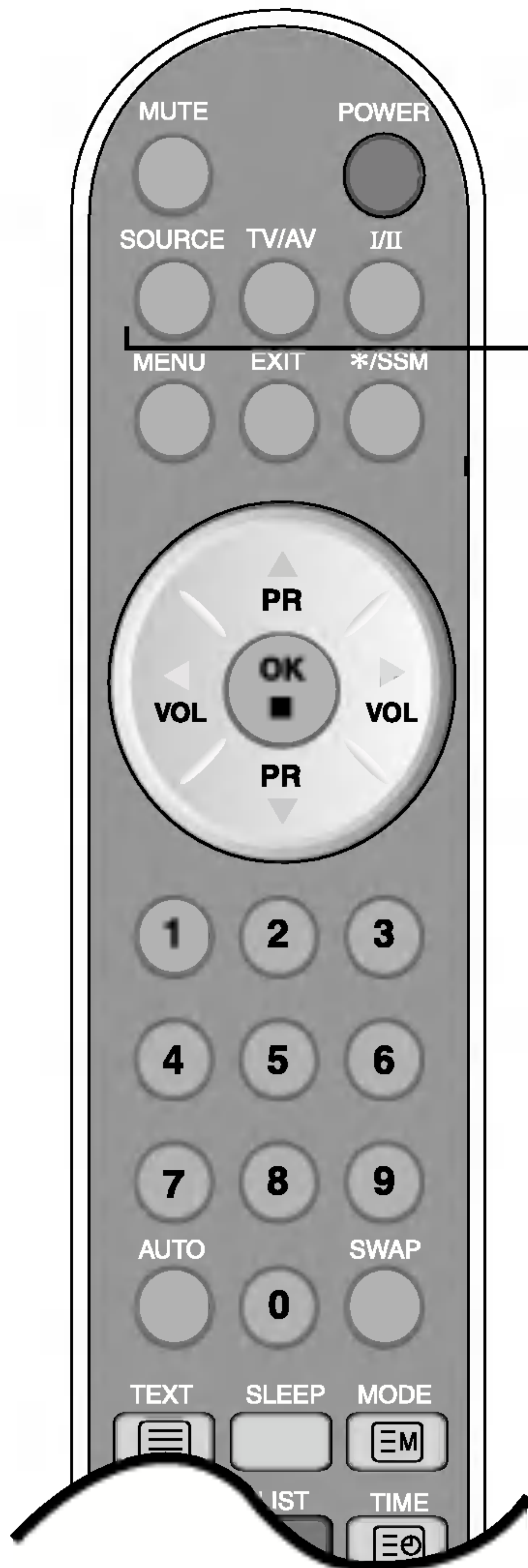

SOURCE

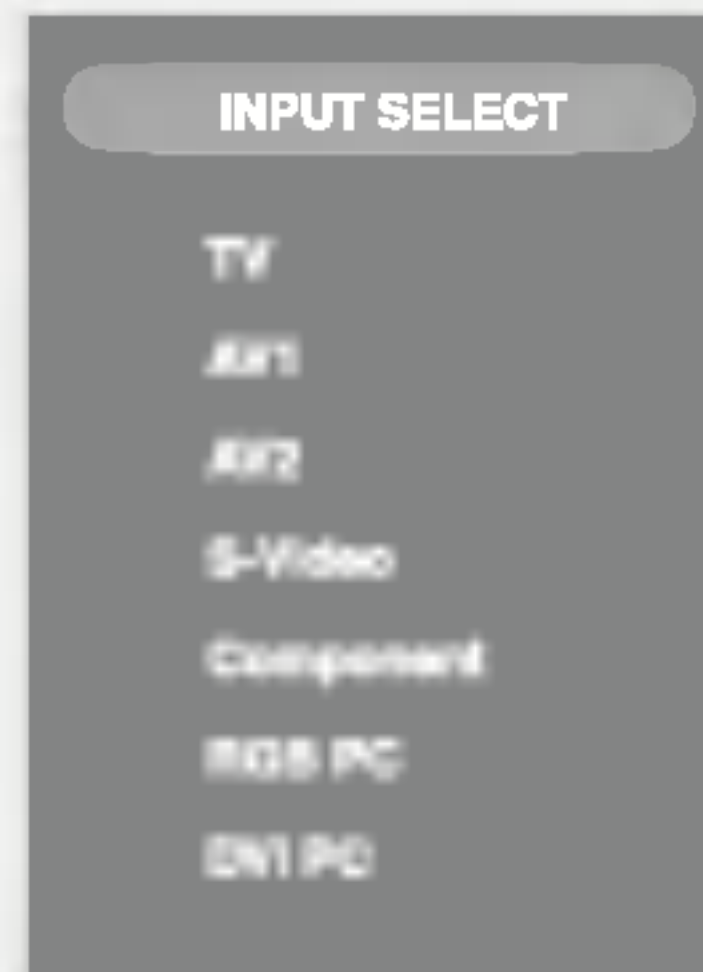

If you press the button once, the following Input Signal Window will appear. Select the signal type you want using the ▼▲ button.

TV/AV : TV/AV button

TV > AV1 > AV2 > S-Video > Component

I/II : Bilingual choice and sound mode selection (TV only)

Press this button

- to switch from **Stereo** to **Mono** sound in case of stereo transmission, or from **Nicam Stereo** to **Nicam Mono**, in case of digital transmission.
- to switch from **Nicam Dual I** to **Nicam Dual II** or **Nicam Dual I+II** in case of Nicam Dual transmission.
- to choose between **Dual I**, **Dual II** or **Dual I+II** in case of bilingual transmission :
 - Dual I** sends the primary broadcast language to the loudspeakers ;
 - Dual II** sends the secondary broadcast language to the loudspeakers ;
 - Dual I+II** sends a separate language to each loudspeakers.

Sound output selection (AV, RGB, DVI only)

In **AV**, **RGB**, **DVI** mode, you can select output sound for the left and right loudspeakers.

Repeatedly press the I/II button to select the sound output.

- L+R : Audio signal from audio L input is sent to the left loud speaker and audio signal from audio R input is sent to the right loud speaker.
- L+L : Audio signal from audio L input is sent to left and right loud-speakers.
- R+R : Audio signal from audio R input is sent to left and right loud-speakers.

■ **NOTE** : In case of weak stereo sound signals, with stereo or Nicam stereo transmission, select mono reception.

ENGLISH

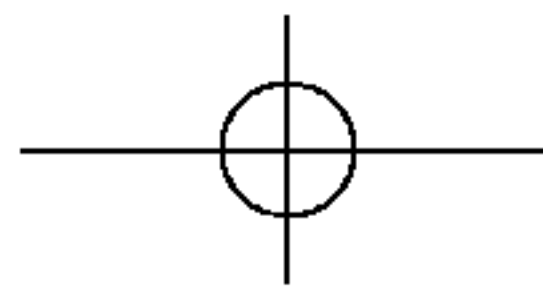

Using the Remote Control

Remote Control

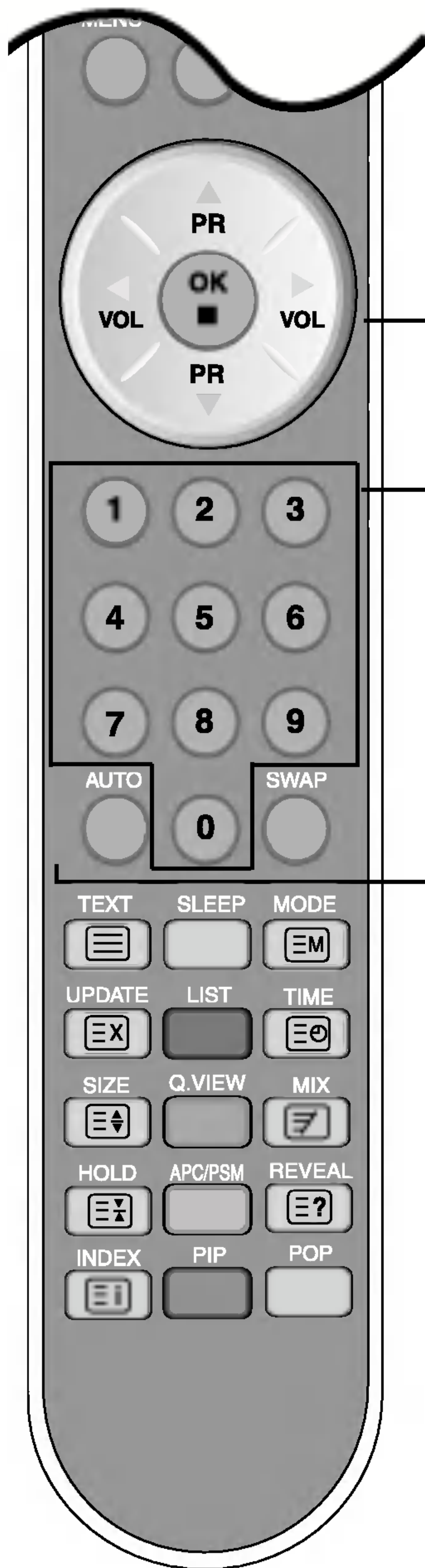

PR (▲ ▼) Buttons
VOL (◀ ▶) Buttons
OK Button

Number buttons

AUTO Button

- This function is to automatically search the available channels. It is available to the TV signal inputs only.
- This function is to automatically adjust your display image to the ideal settings for the current screen resolution size (display mode). It is available to the PC analog signal input only.

SWAP function

To switch the main-screen and sub-screen in PIP/POP/PBP mode.

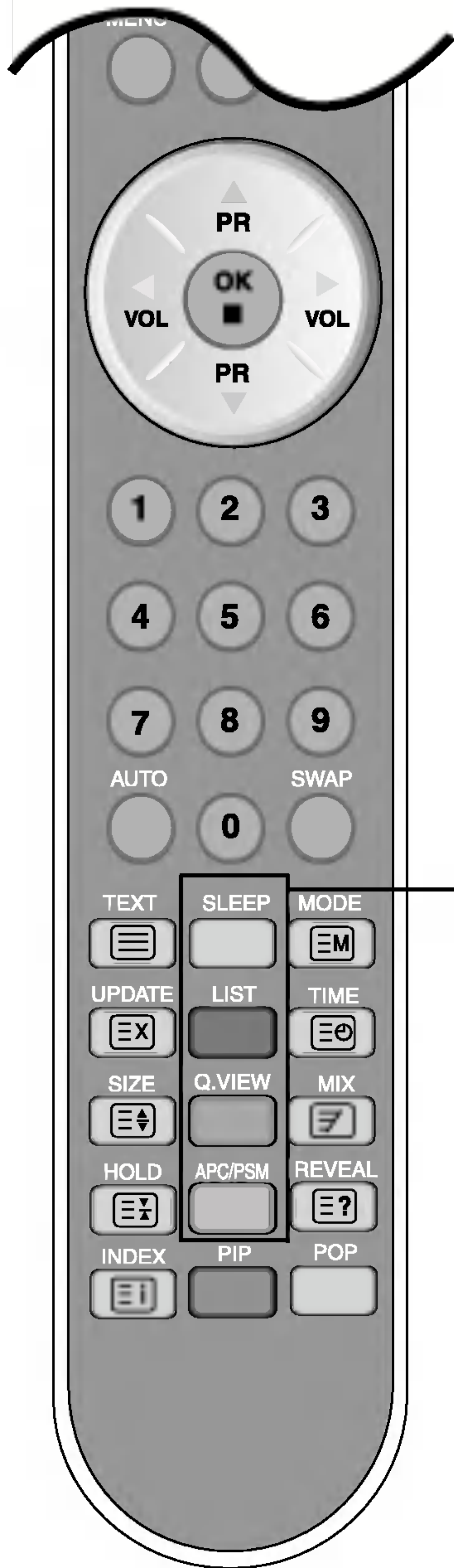

SLEEP : SLEEP Timer

You can set a time period after which the **TV / AV1 / AV2 / S-Video / Component** should switch itself to standby. Press the key repeatedly to select the number of minutes.

LIST : Programme list

To display the programme list (0~ 99).



Note: TV channels displayed in blue have been setup to be skipped in the Programme Edit menu

Q.VIEW : QUICK VIEW Button (See page A27)

- * Favourite Program On : Rotate Favourite channel.
- * Favourite Program Off : To display the previously selected TV channel.

APC / PSM

Press repeatedly to select **Dynamic, Standard, Mild, Game** or **User** picture mode. This function is not supported in PC mode.

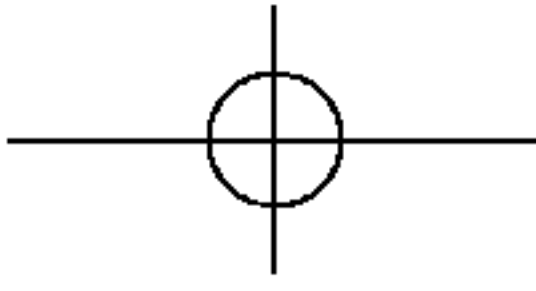

Using the Remote Control

Remote Control - PIP/POP/PBP function

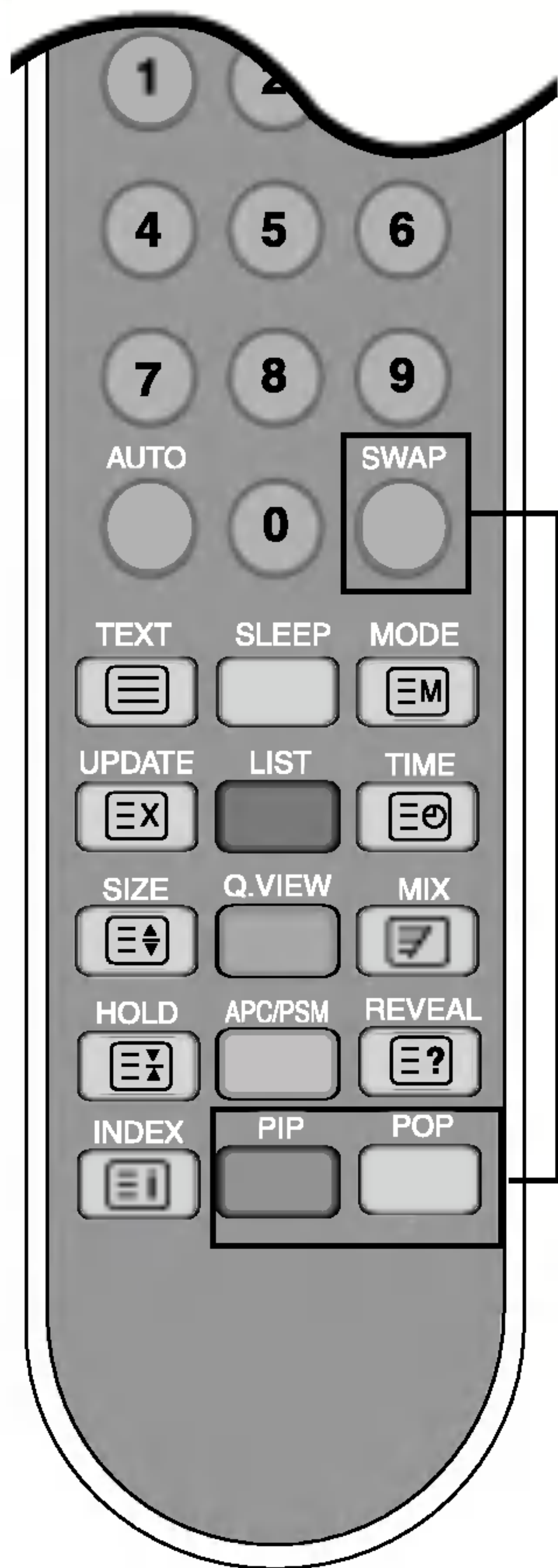

1. PIP (Picture in Picture)

The sub-screen is changed in the order shown below.
: SMALL -> MEDIUM -> LARGE -> OFF

2. POP (Picture out Picture) Button

The sub-screen moves to the next mode whenever you press this button.
: POP ON -> PBP(FULL) -> PBP(4:3) -> OFF



3. SWAP Button

You can swap the main screen and the sub-screen when the PIP/POP/PBP function is used.

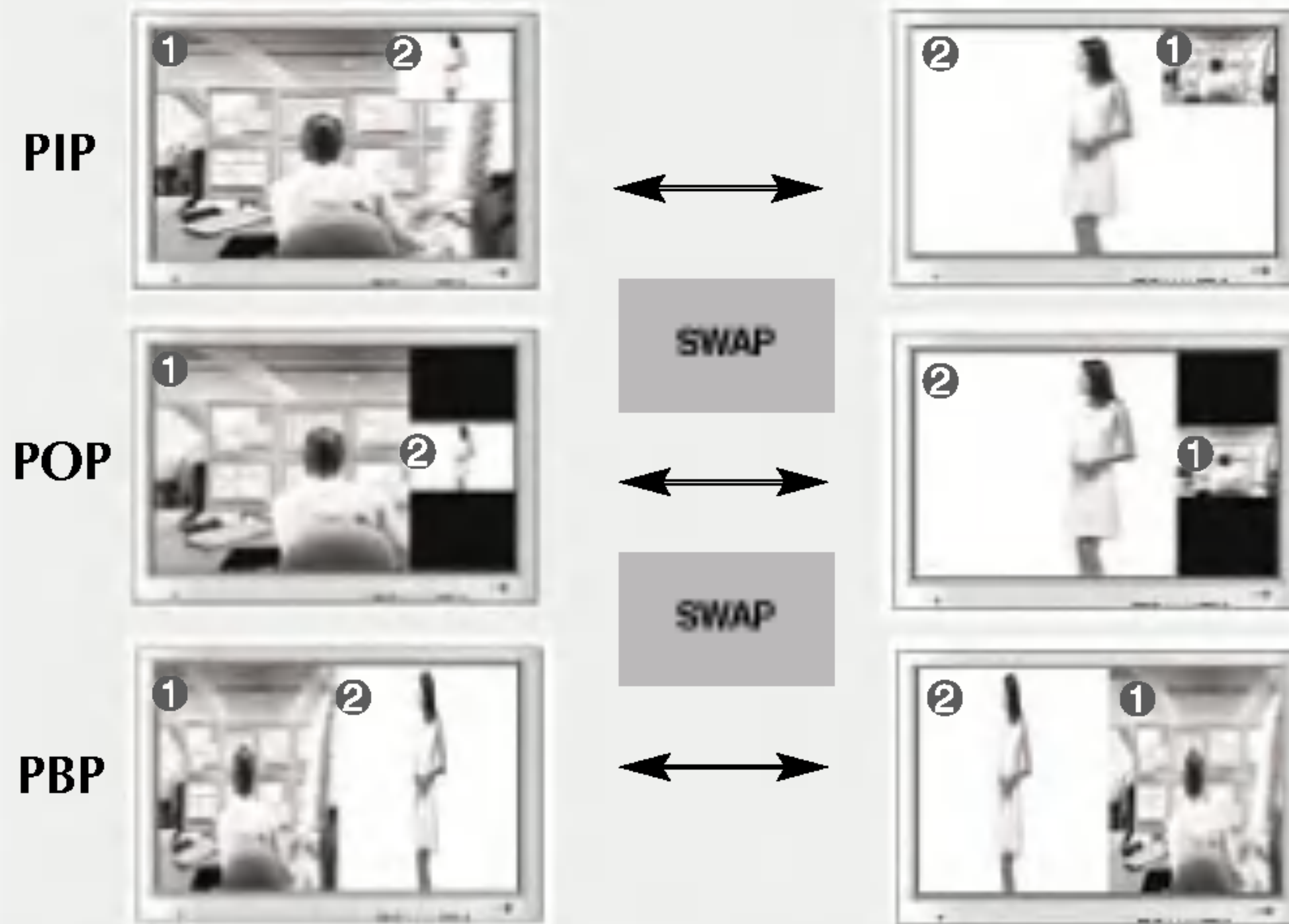

<Table of PIP/POP/PBP Function Support>

Main Screen / Sub-Screen	TV	AV1	AV2	S-Video	COMPONENT	RGB PC	DVI PC
TV	X	X	X	X	X	●	●
AV1	X	X	X	X	X	●	●
AV2	X	X	X	X	X	●	●
S-Video	X	X	X	X	X	●	●
COMPONENT	X	X	X	X	X	●	●
RGB PC	●	●	●	●	●	X	●
DVI PC	●	●	●	●	●	●	X

When 'Input Signal 1' comes on in the main screen, only 'Input Signal 2' can be displayed on the sub-screen. On the contrary, if the main screen displays 'Input Signal 2', the sub-screen can display 'Input Signal 1' only. You can swap 'Input Signal 1' and 'Input Signal 2' using the SWAP button.

*PIP function is not supported in 480i, 576i and 1080i modes.

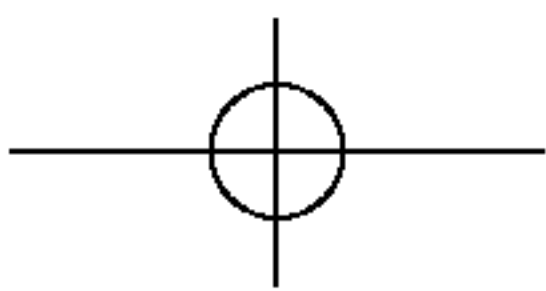

Remote Control - Using the Teletext function

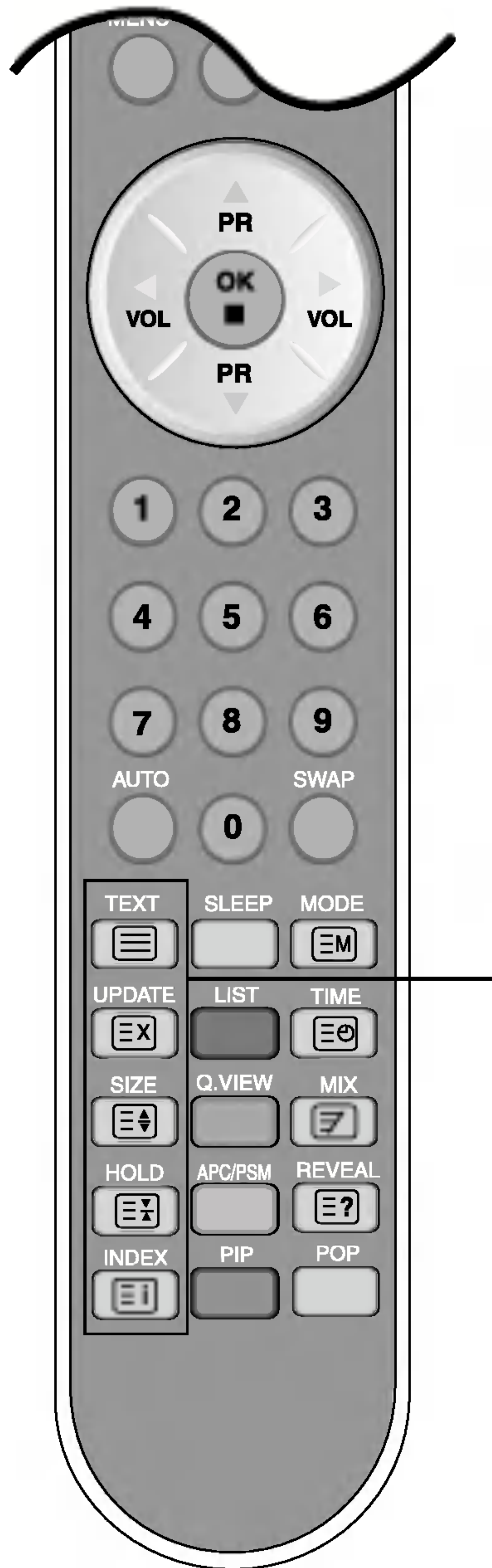

TEXT

To select the teletext on or off. The main index page or the last selected page appears on the screen together with an information headline and an option line at the bottom of the screen.

UPDATE

Press the button to appear the TV programme. At the top of screen indicates that you are still in the teletext mode. Before interrupting teletext, you may select a page number. When the page has been found, the information line appears briefly on your screen. Press the button again to reappear teletext.

SIZE

Press the button repeatedly to display the upper part, the lower part and then to return to the normal page size.

HOLD

Press the button to stop the automatically rotating of the subpages. Press the button again to continue the automatic rotating again.

INDEX

To display the main index.

Using the Remote Control

Remote Control - Using the Teletext function

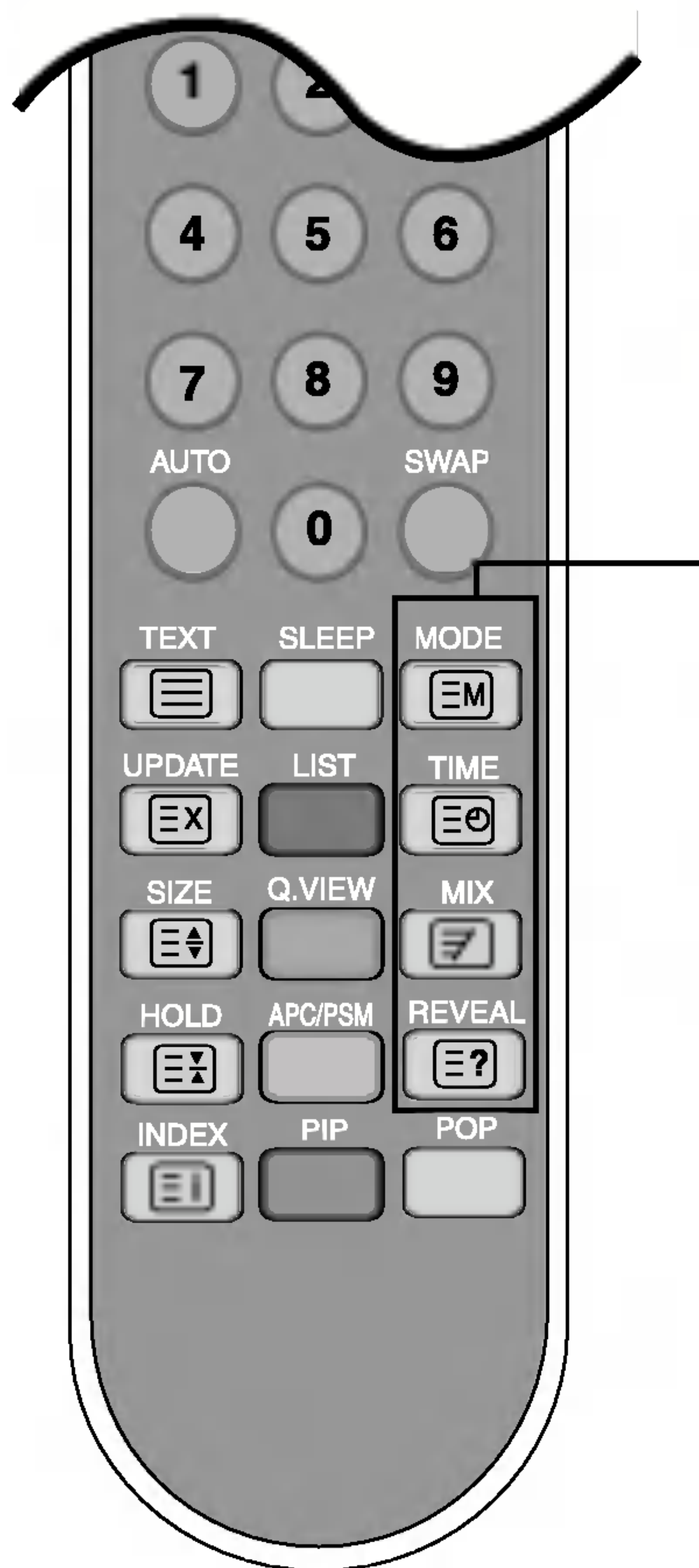

MODE

The mode will be switched in the Teletext mode.

TIME

press this button to select a sub page number. The sub page number is displayed at the bottom of the screen. To hold or change the sub page, press the RED/GREEN, ▲▼ or NUMBER buttons. Press again to exit this function.

MIX

Display the teletext pages superimposed on the TV picture. To switch the TV picture off press this button again.

REVEAL

Press the button to reveal/conceal the hidden information, such as solutions to riddles and puzzles. Press this button again to remove the information from the display.

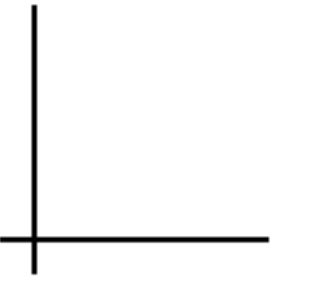
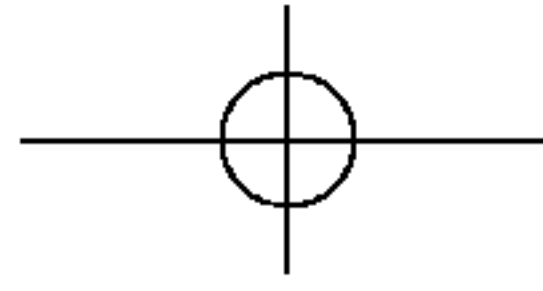

To arrange cables in order - Optional

* Applicable only for models that support the stand

1. Disassemble the **stand cover**. The cover may be easily disassembled by pressing down on the base as shown in the figure.

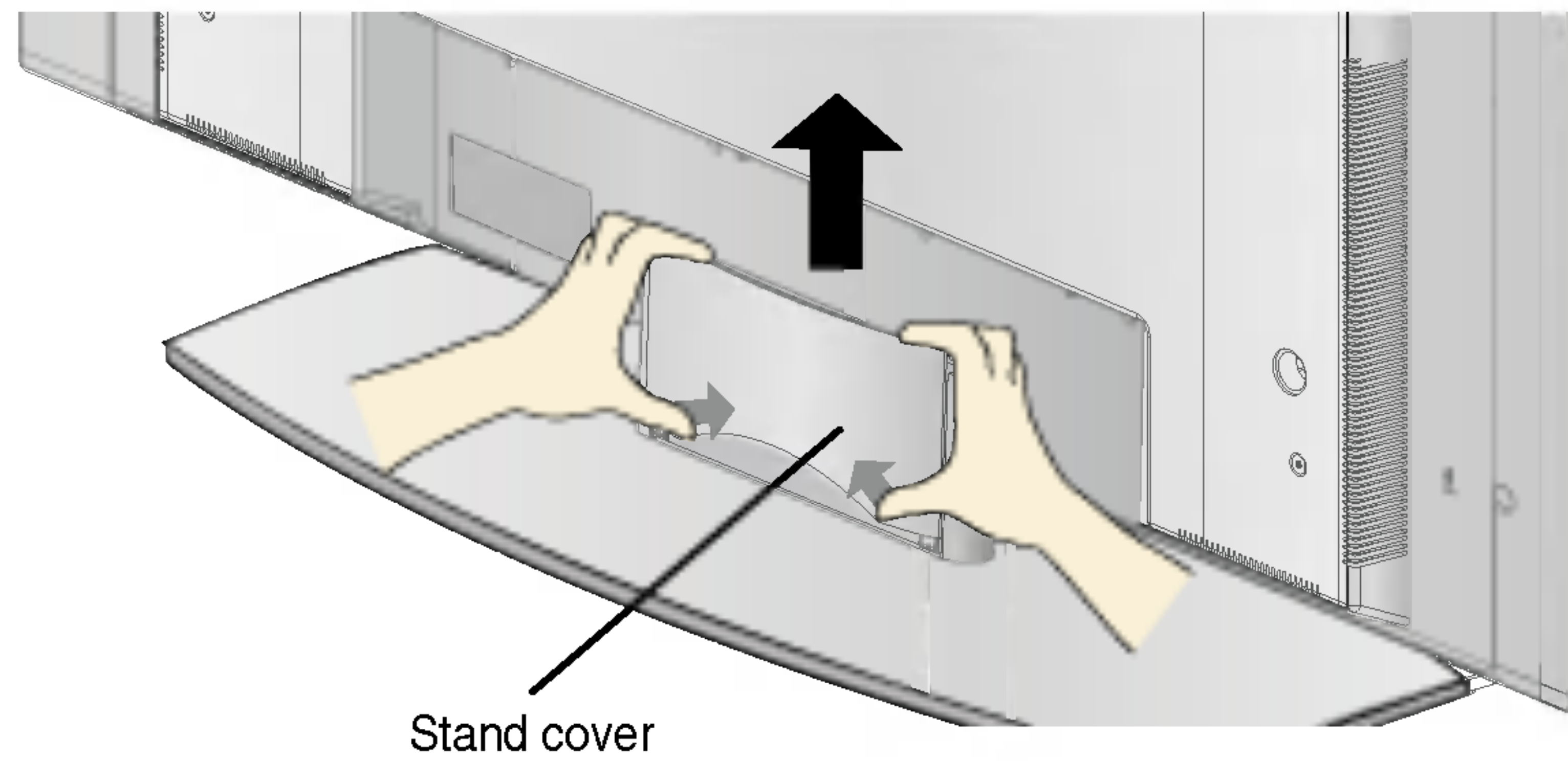

2. After connecting the cables, correctly position the stand cover into the holes on the stand. If securely connected, you will hear the latch click into place.

ENGLISH

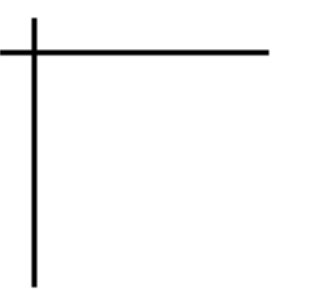
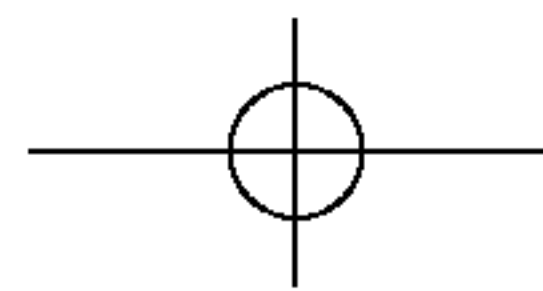
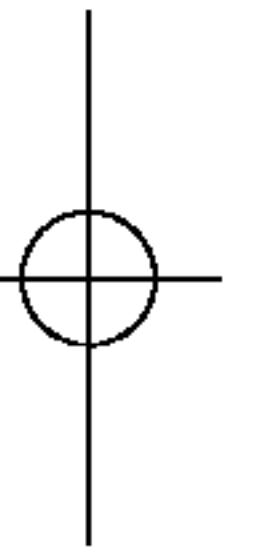
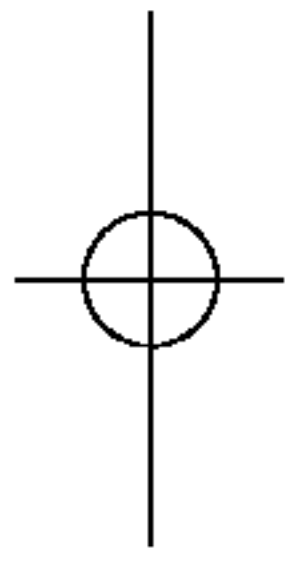

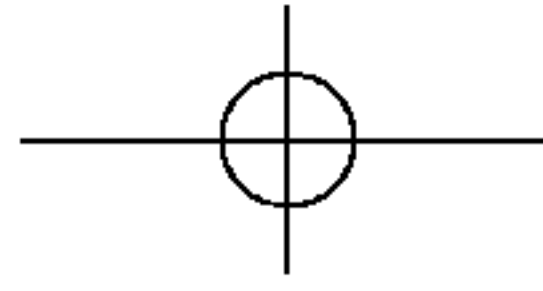

Connecting the Speakers - Optional

* Applicable only for models that support the speakers

Use the screws to secure the speakers on the rear side of the monitor as shown in the below figure.

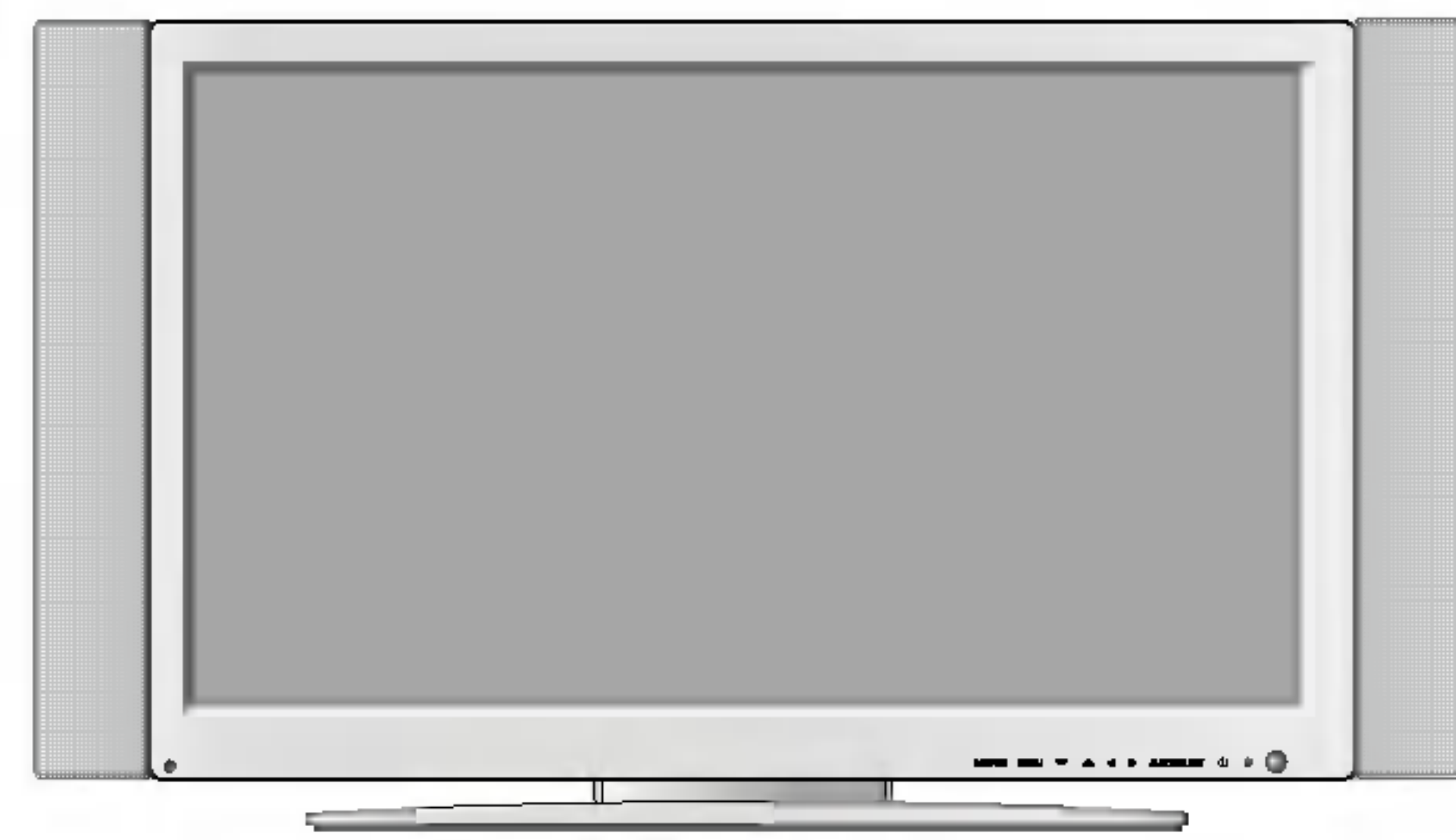
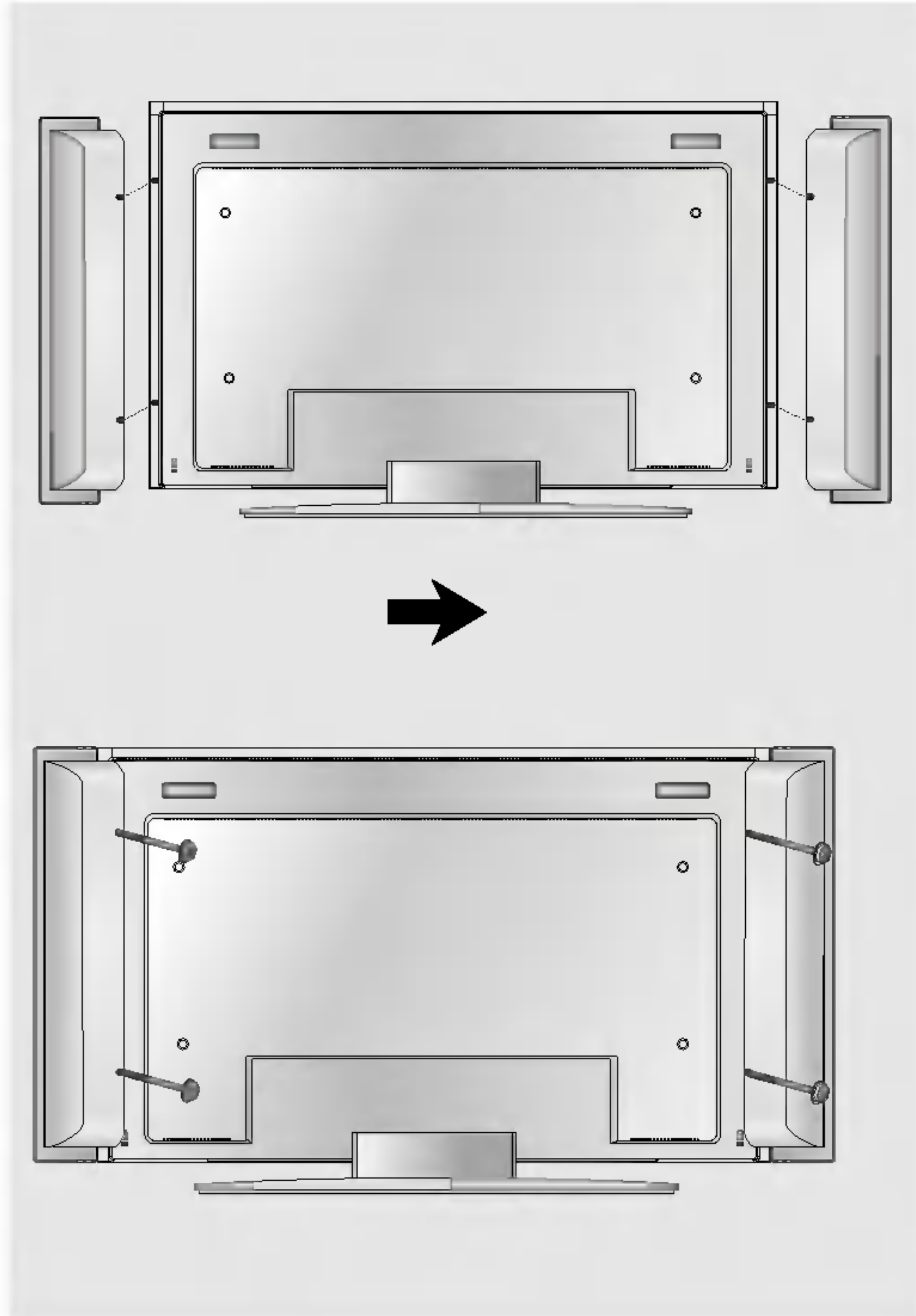

When the speaker is installed.

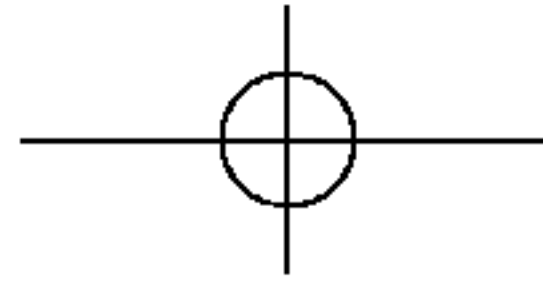

Name and Function of the Parts

Rear View

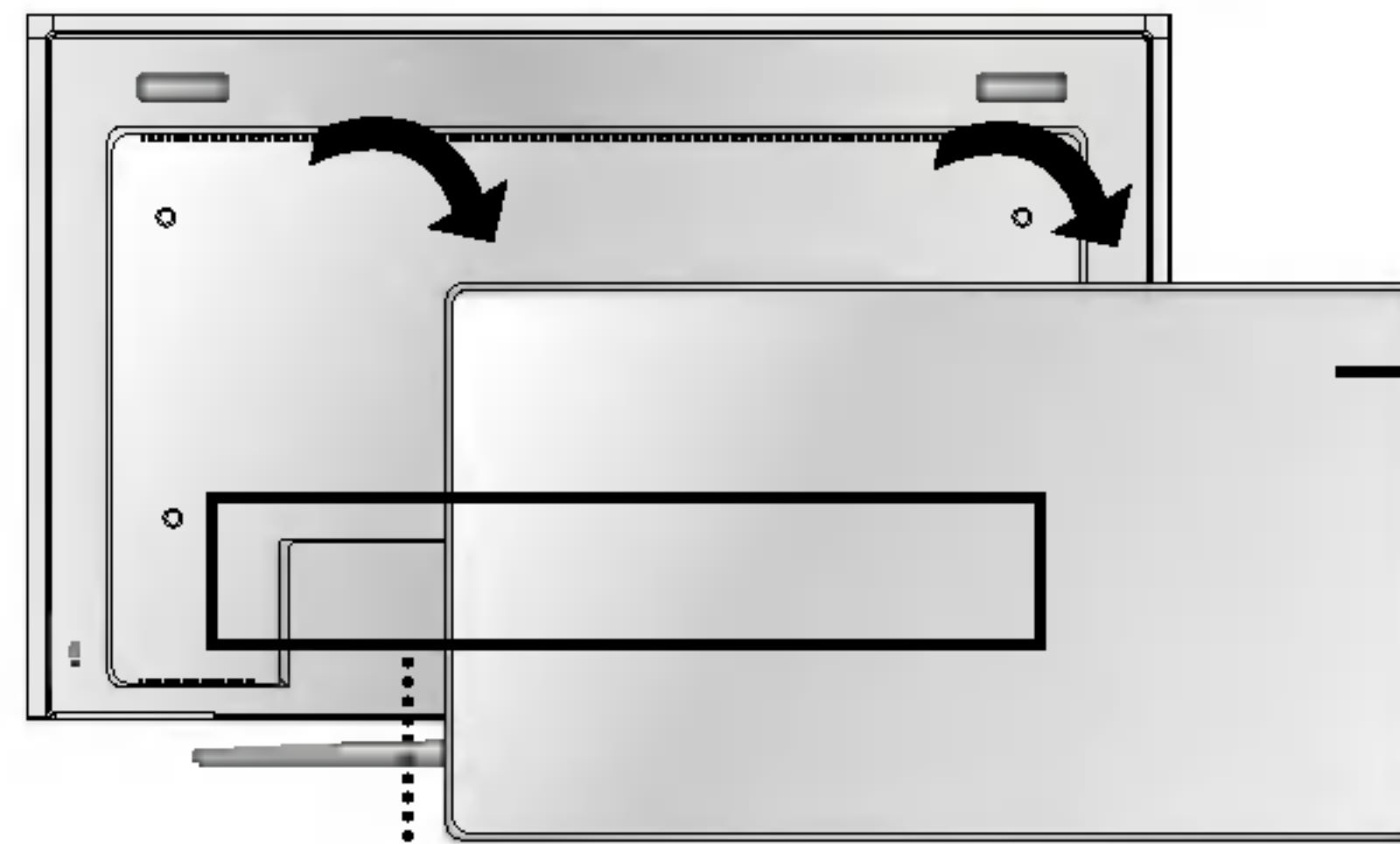

Back Cap
- Open the back cap before you install the monitor.

ENGLISH

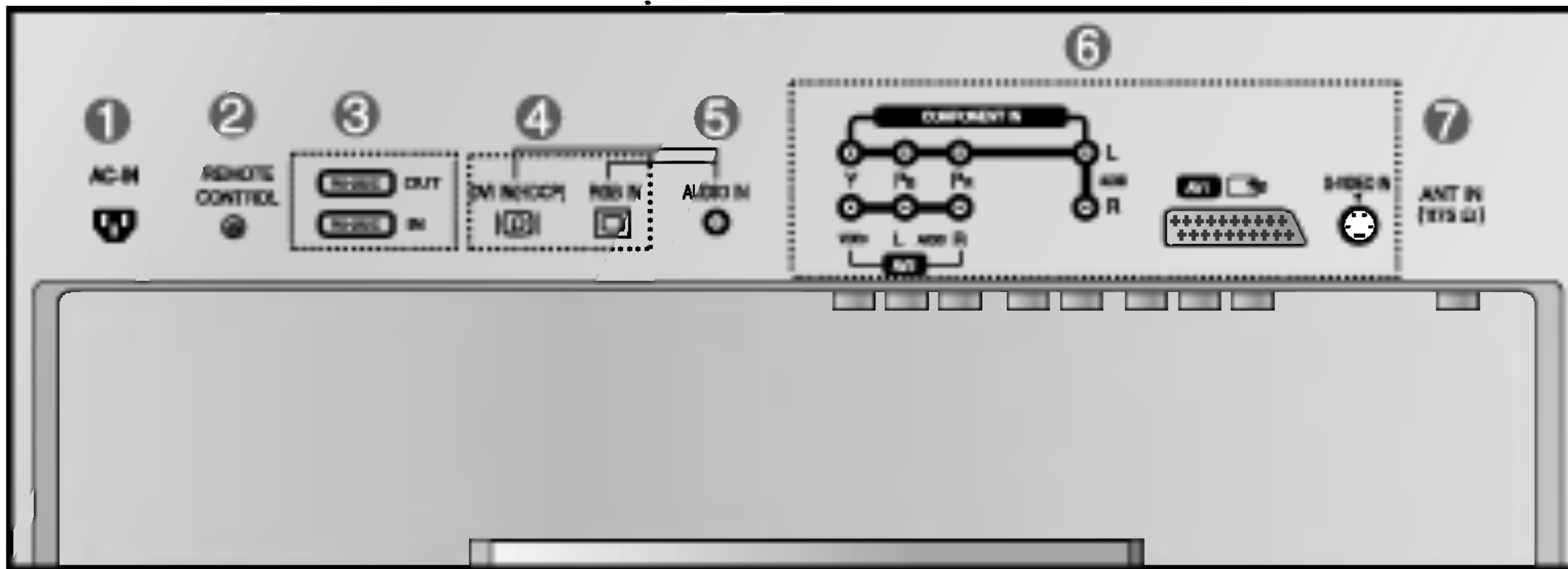

- ① Power Connector : Connect the power cord
- ② Wired Remote Control Port
- ③ RS-232C Serial Ports
- ④ PC Signal Inputs
- ⑤ PC Sound Jack
: Connect the audio cable to the *LINE OUT jack of the PC sound card.
- ⑥ AV Input Ports
- ⑦ TV Tuner Jack : Connect the antenna.

***LINE OUT**

A terminal used to connect to the speaker including a built-in amplifier (Amp). Make sure that the connecting terminal of the PC sound card is checked before connecting. If the Audio Out of PC sound card has only Speaker Out, reduce the PC volume.

If the Audio Out of the PC sound card supports both Speaker Out and Line Out, convert to Line Out using the card jumper of the program (Refer to the Sound Card Manual).

Connecting the Monitor

1 First of all, see if the computer, monitor and the peripherals are turned off. Then, connect the signal input cable.

- (A)** When connecting with the DVI signal input cable.
- (B)** When connecting with the DSub signal input cable. (IBM compatible PC)
- (C)** When connecting with the DSub signal input cable. (Macintosh)

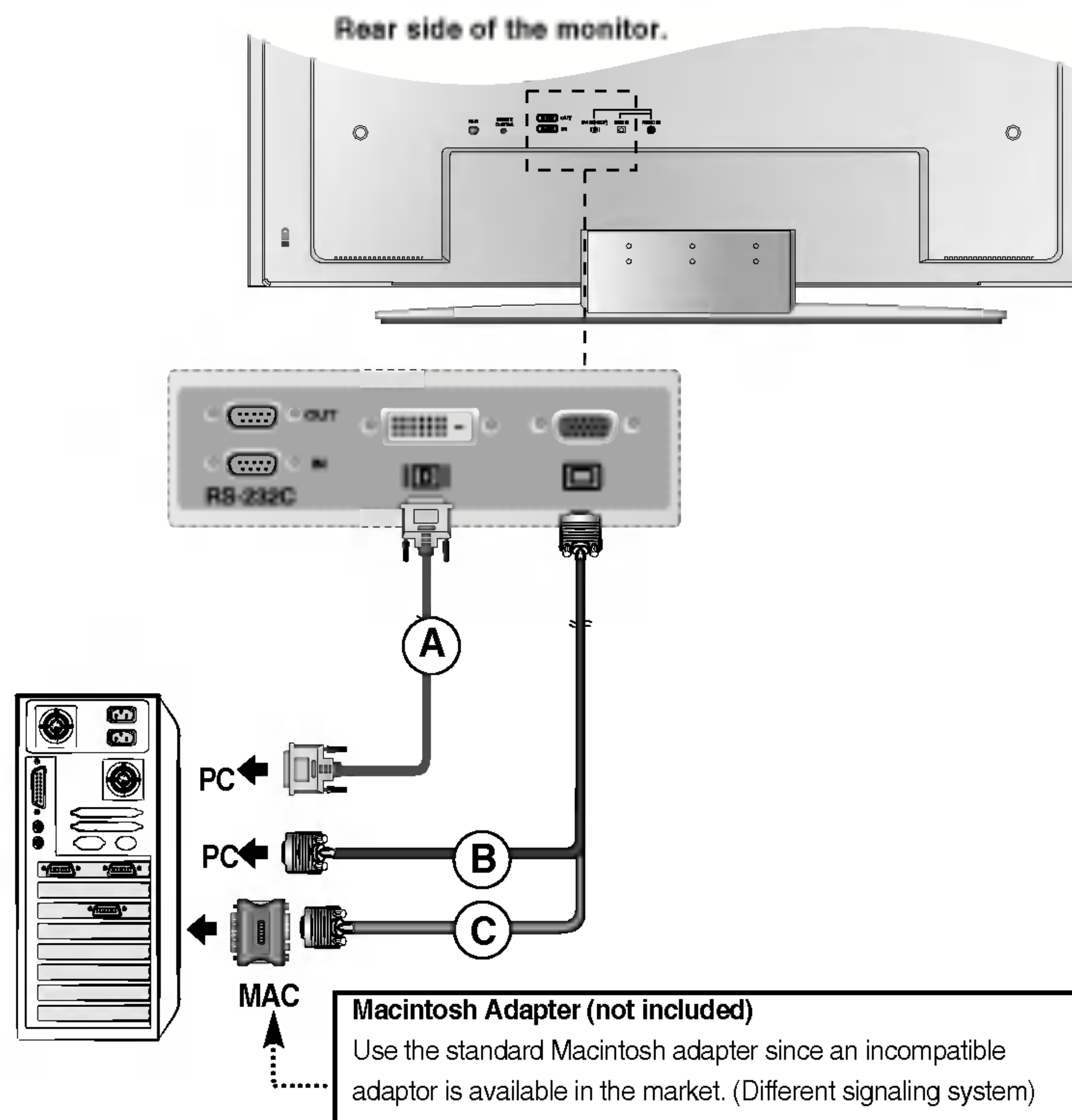

2 Connect the power cord.

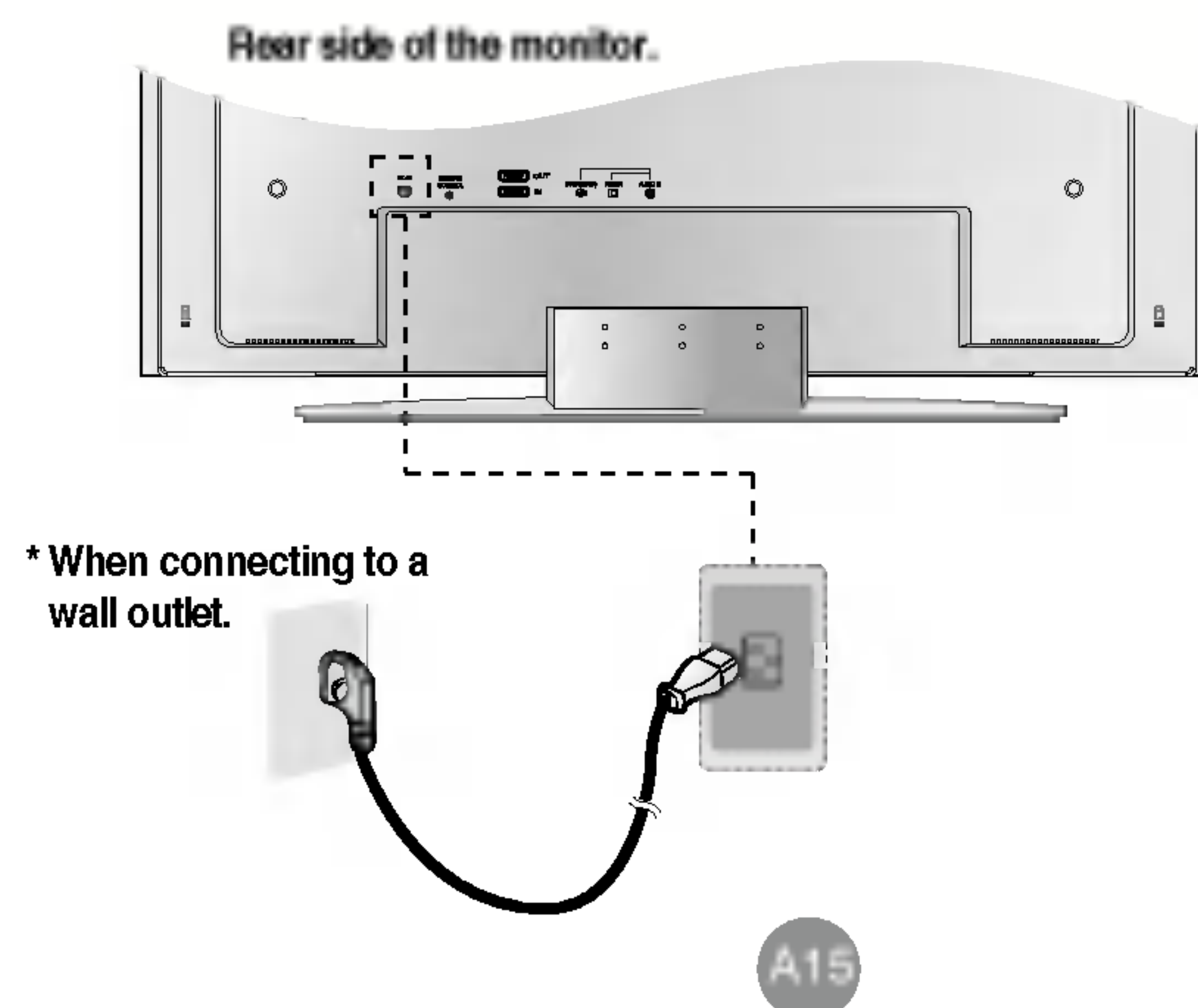

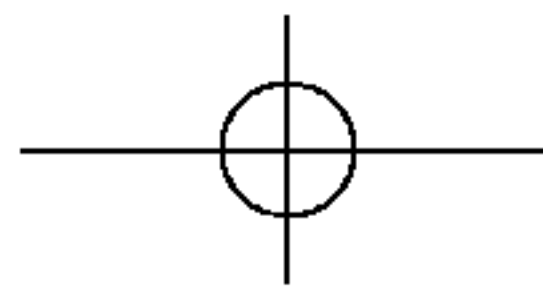

- 3** **A** Turn on power by pressing the power button on the monitor.

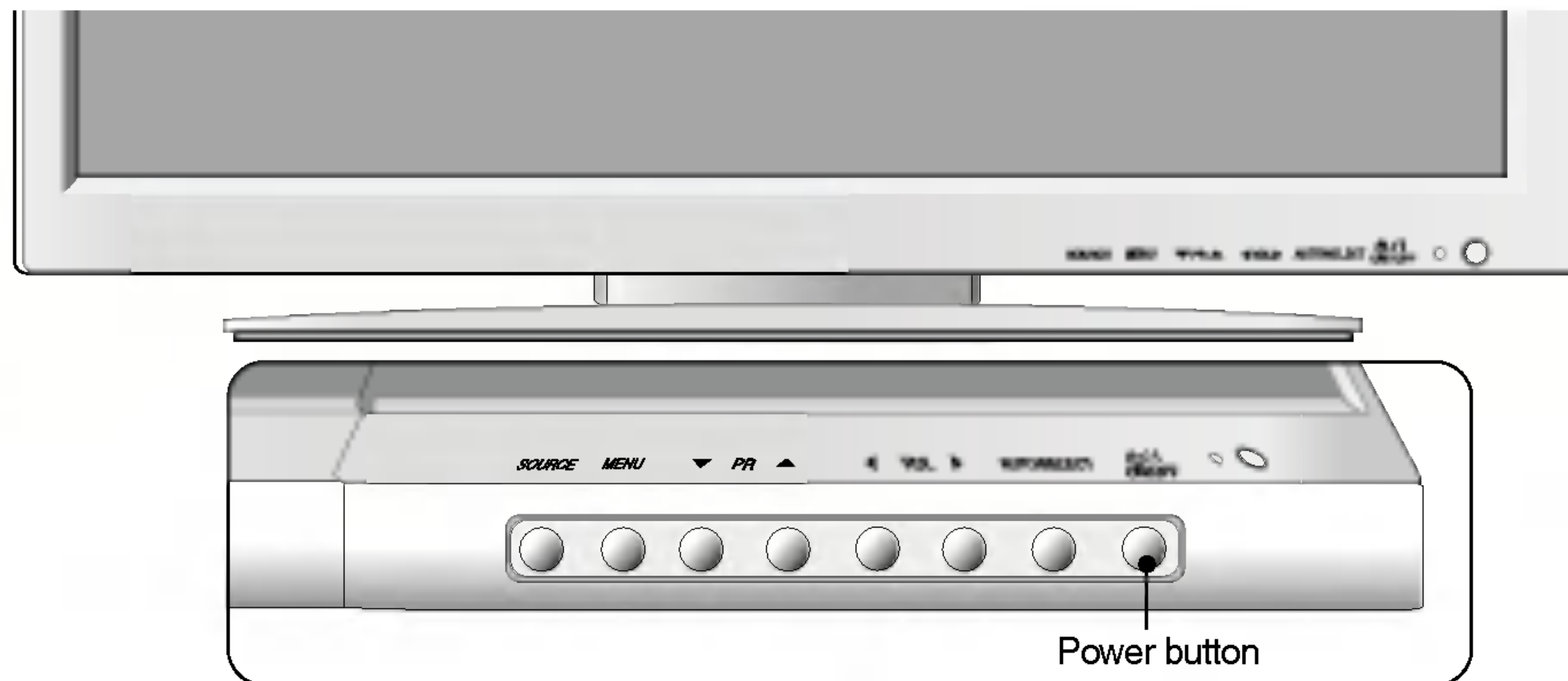

- B** Turn on the PC.

- 4** Select an input signal.
Press the **SOURCE** button on the remote controller to select the input signal.
Or, press the **SOURCE** button at the front side of the monitor.

SOURCE → ▼▲ → **OK or SELECT**

- A** When connecting with a DVI-D signal input cable.
• Select **DVI PC**: DVI-D digital signal.
- B** When connecting with a D-Sub signal input cable.
• Select **RGB PC**: 15-pin D-Sub analog signal.

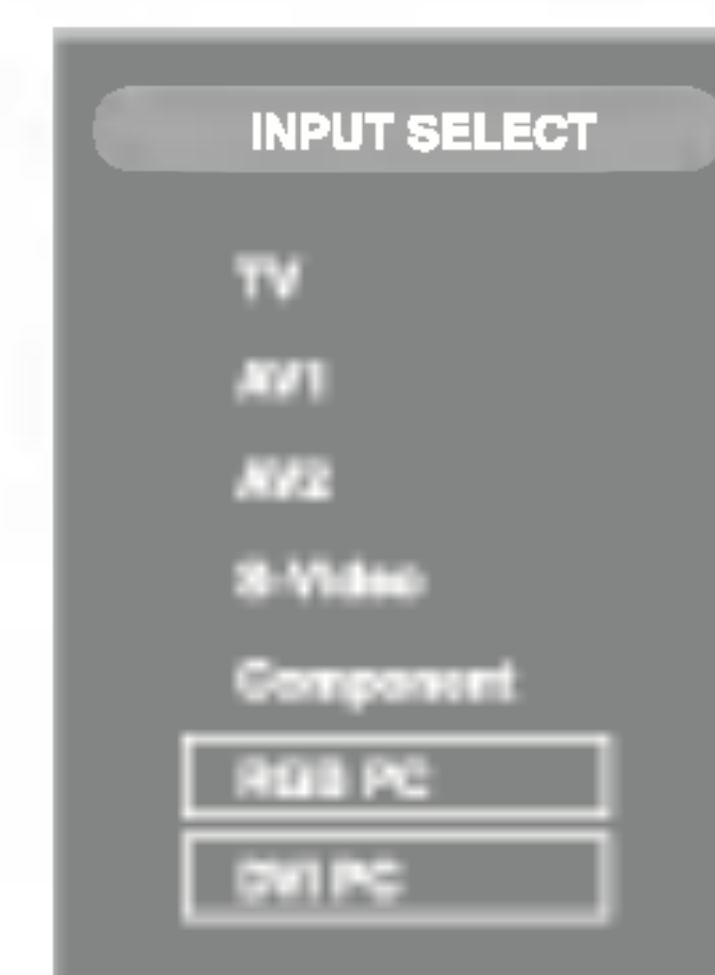

Note

- How to connect to two computers.**
Connect the signal cables (DVI and D-Sub) to each computer.
Press the SOURCE button in a remote controller to select the computer to use.
- Directly connect to a grounded power outlet on the wall or a power bar with a ground wire.**

Connecting the VCR/DVD

- 1** Connect the video cable as shown in the below figure and then connect the power cord (See page A15).

- (A)** When connecting with a RCA cable.
- Connect the input terminal with a proper color match.
(Video – Yellow, Sound (left) – White, Sound (right) – Red)

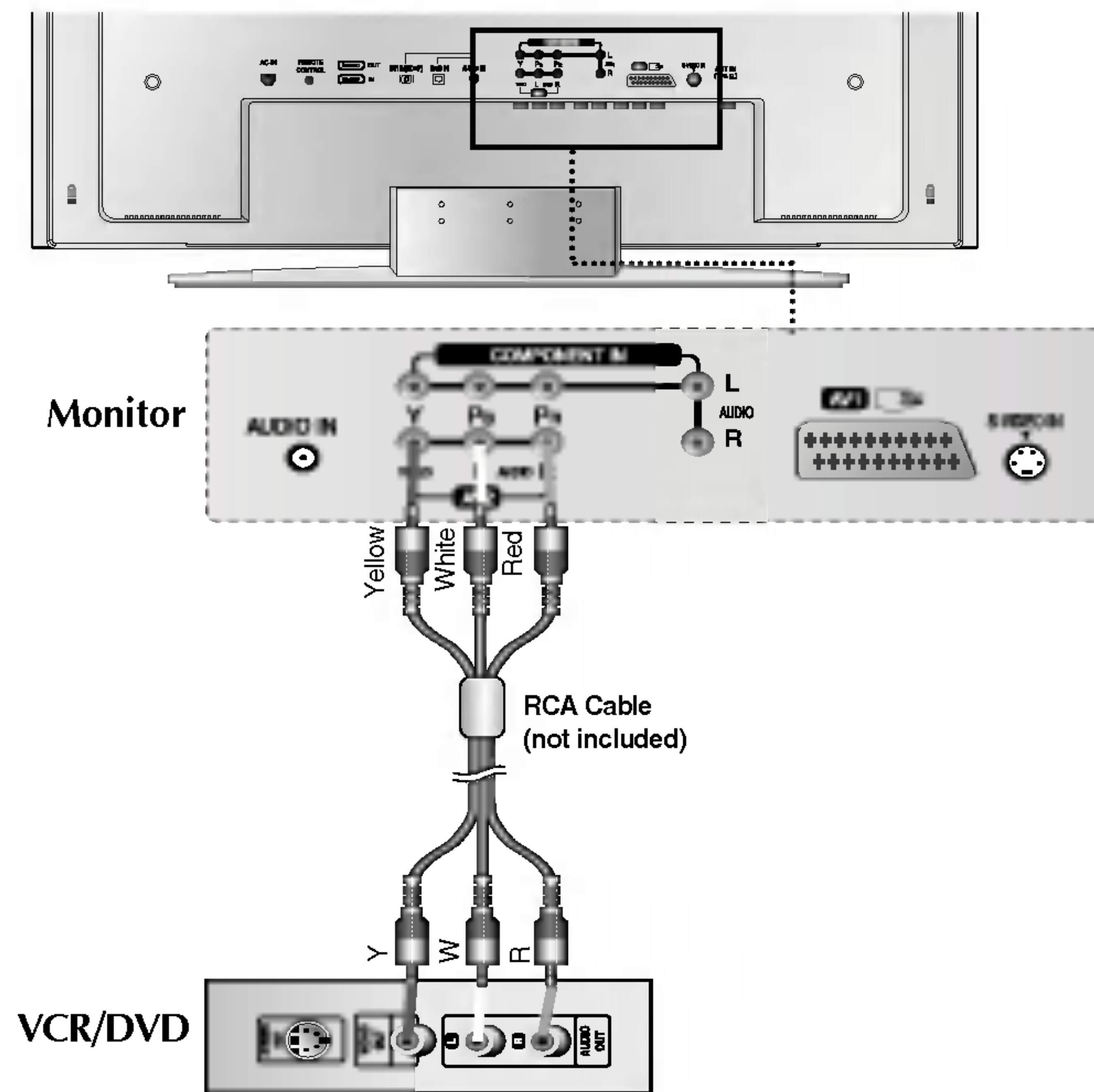

- (B)** When connecting with a S-Video cable.
- Connect to the S-Video input terminal to watch high image quality movies.

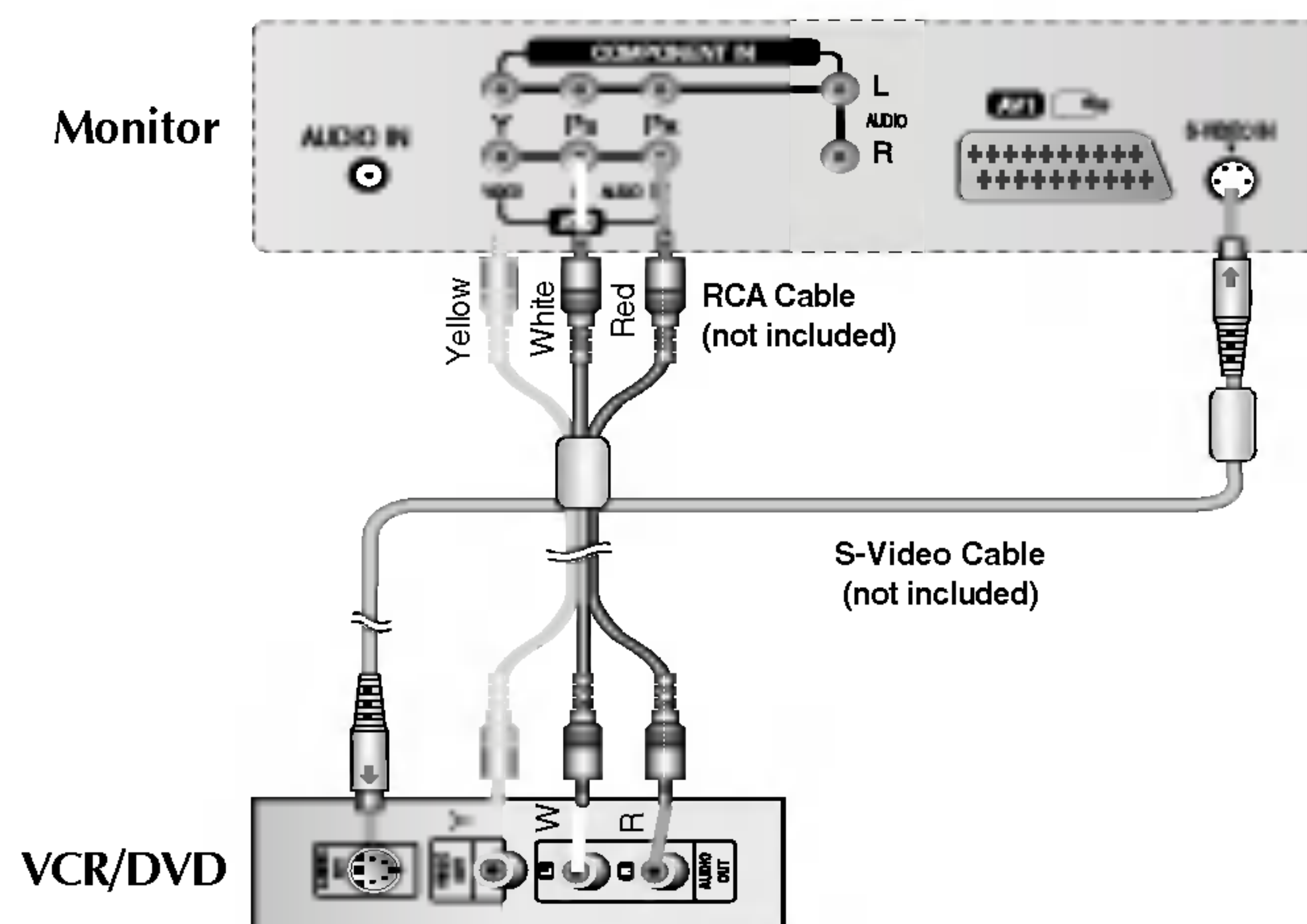

③ When connecting with a SCART cable.

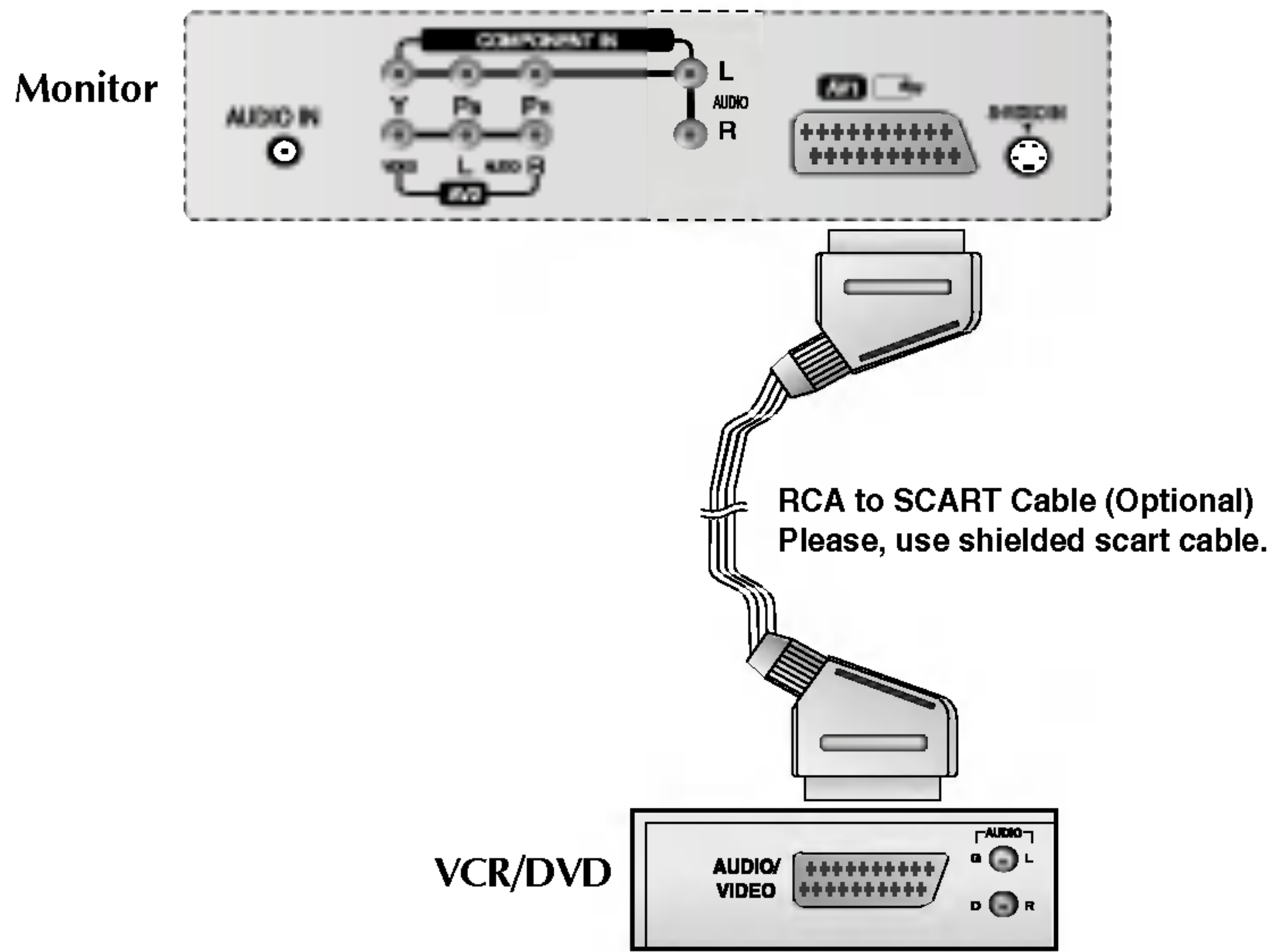

② Select an input signal.
 Press the **SOURCE** button on the remote controller to select the input signal.
 Or, press the **SOURCE** button at the front side of the monitor.

SOURCE → ▼▲ → **OK or SELECT**

- A** When connecting with an RCA cable.
• Select **AV2**.
- B** When connecting with an S-Video cable.
• Select **S-Video**.
- C** When connecting with a SCART cable.
• Select **AV1**.



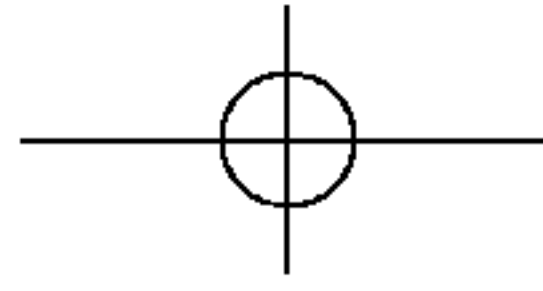

Connecting the HDTV/DVD

- 1** Connect the video/audio cable as shown in the below figure and then, connect the power cord (See page A15).
 - Connect the input terminal with a proper color match.

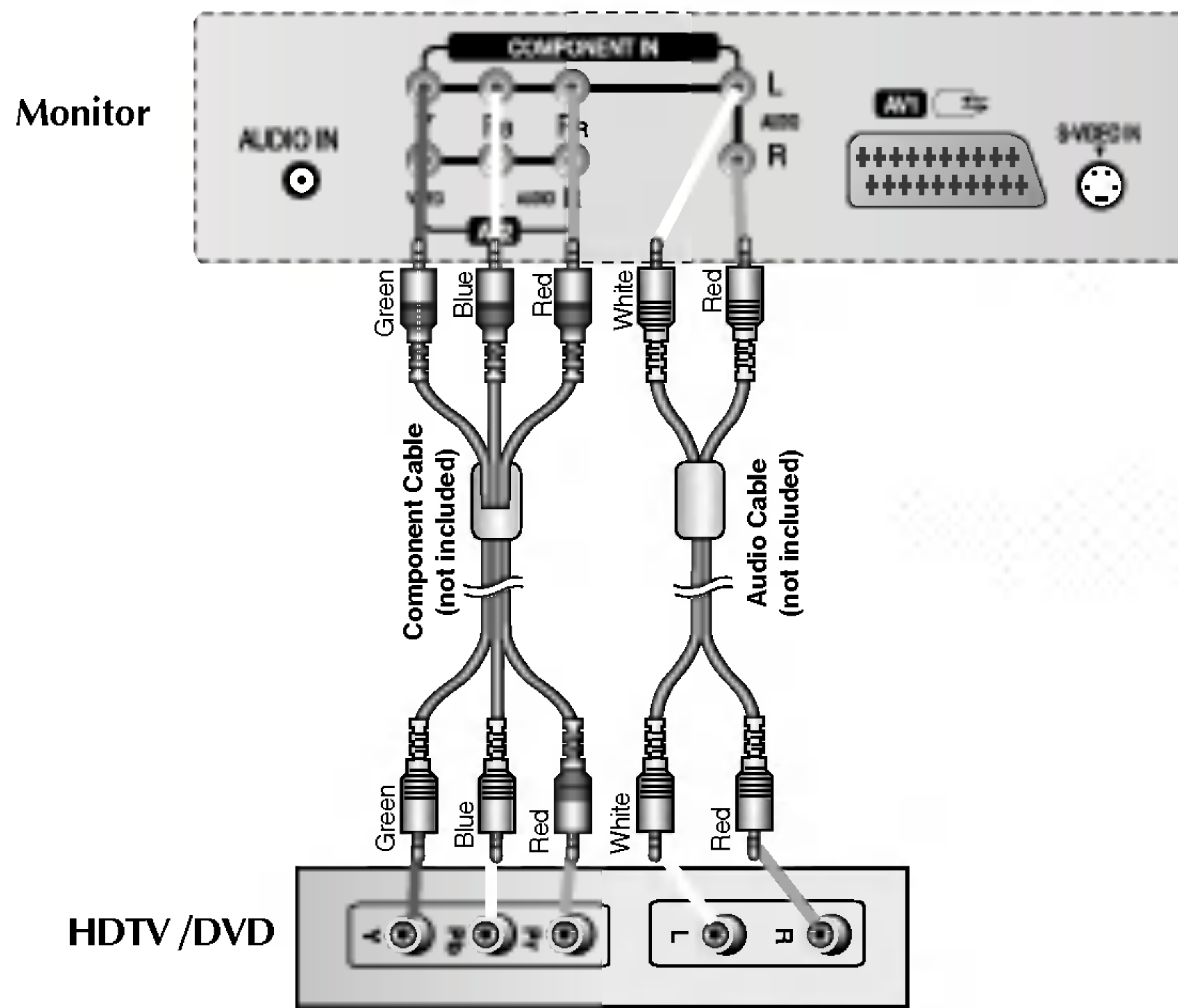

- 2** Select an input signal.
 Press the SOURCE button on the remote controller to select the input signal.
 Or, press the SOURCE button at the front side of the monitor.

SOURCE → ▼▲ → **OK or SELECT**

- Select Component.

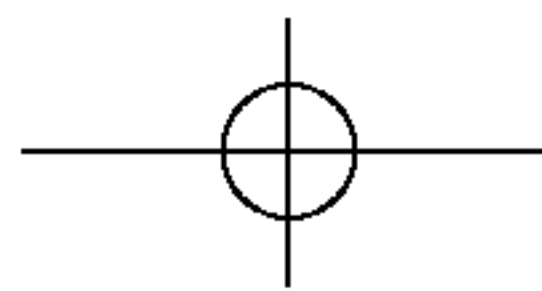

Connecting to DVI-D(HDCP) from the VCR/DVD/Set-top Box

ENGLISH

- 1 Connect the video/audio cable as shown in the below figure and then connect the power cord (See page A15).

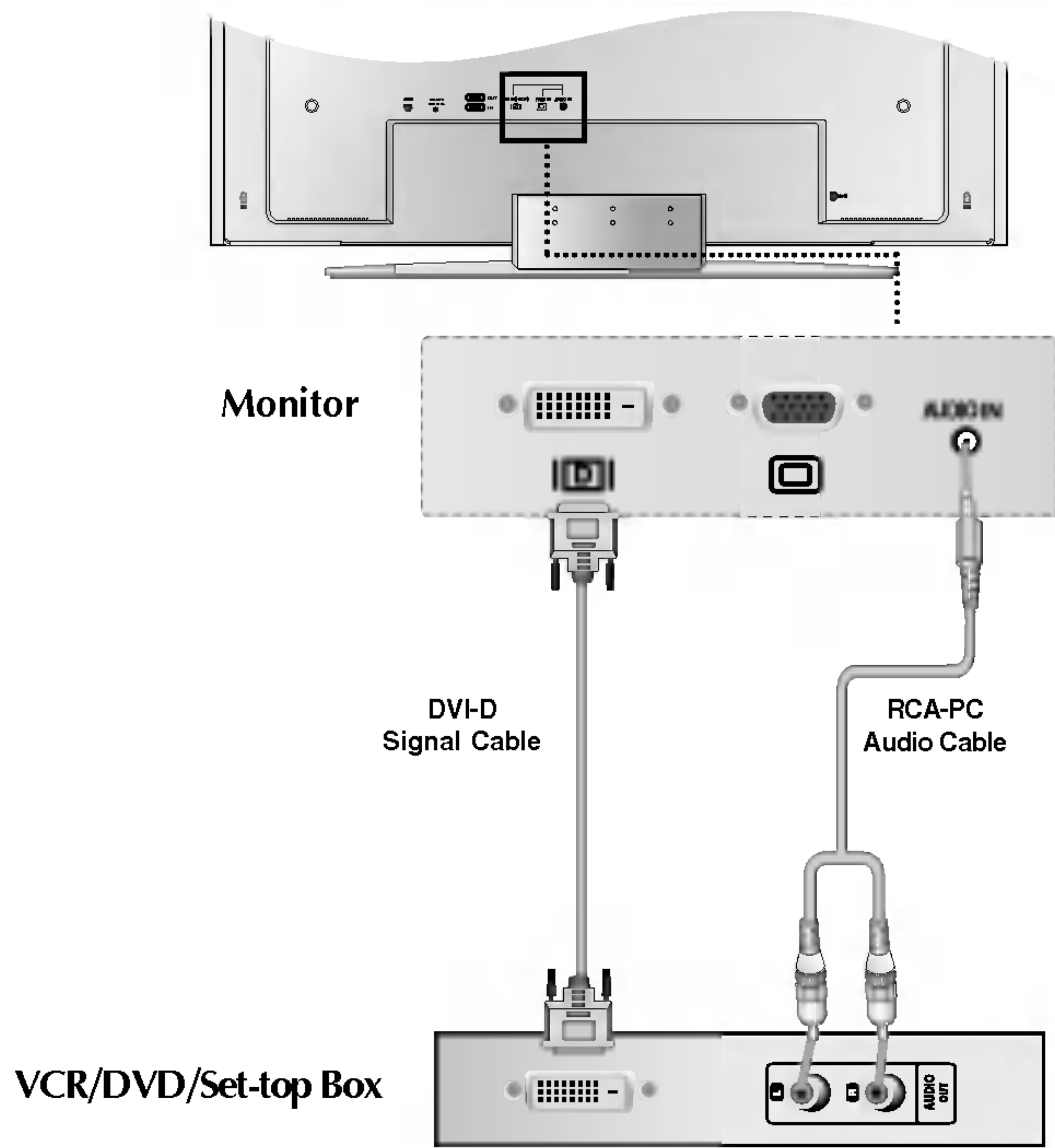

- 2 Select an input signal.
Press the SOURCE button on the remote controller to select the input signal.
Or, press the SOURCE button at the front side of the monitor.

SOURCE → ▼▲ → **OK or SELECT**

- Select DVI PC.

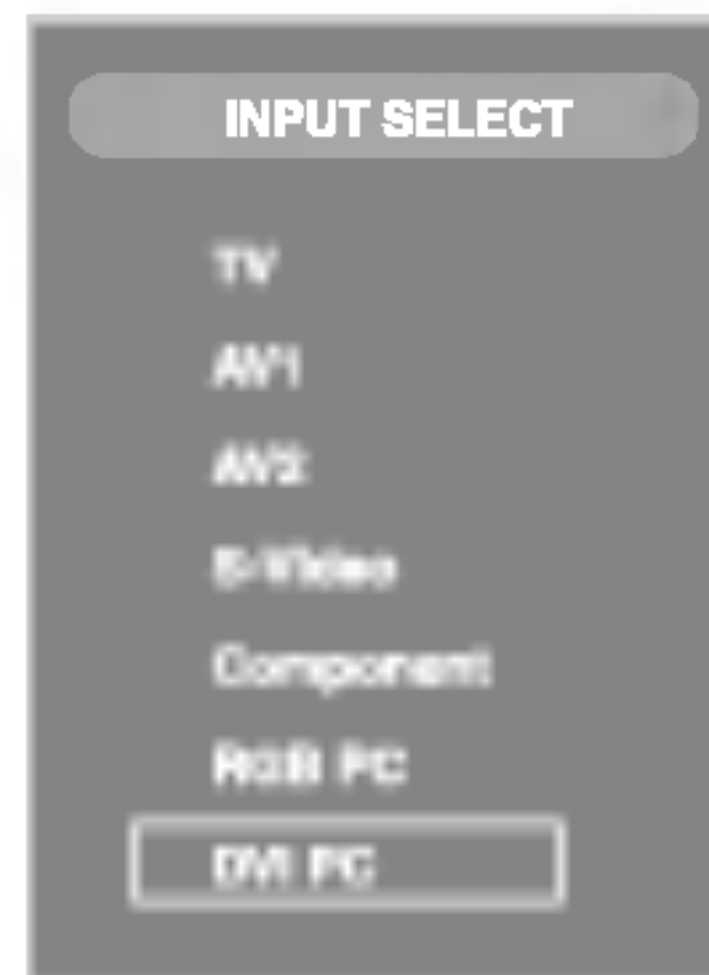

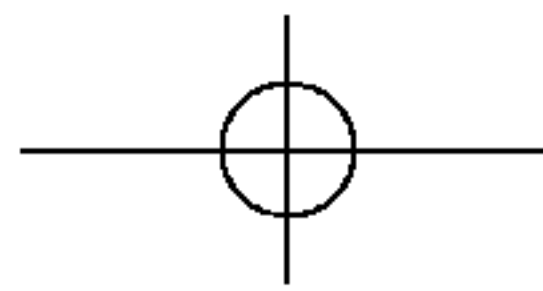

Connecting the TV

- 1 See if the antenna cable is connected at the rear side of the monitor and then, connect the power cord (see page A15).

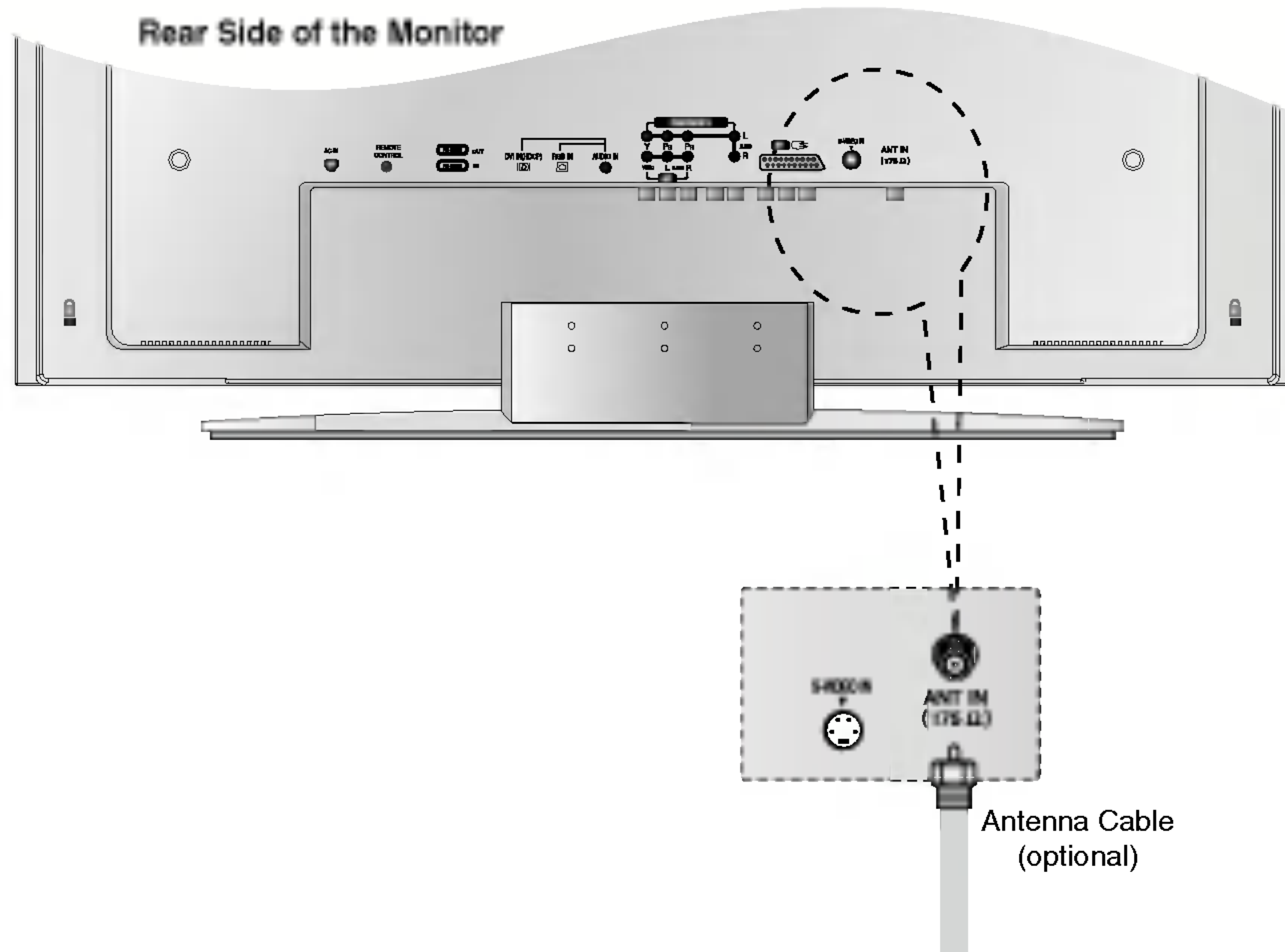

- 2 Select an input signal.
Press the SOURCE button on the remote controller to select the input signal.
Or, press the SOURCE button at the front side of the monitor.

SOURCE → ▼▲ → **OK or SELECT**

- Select TV.

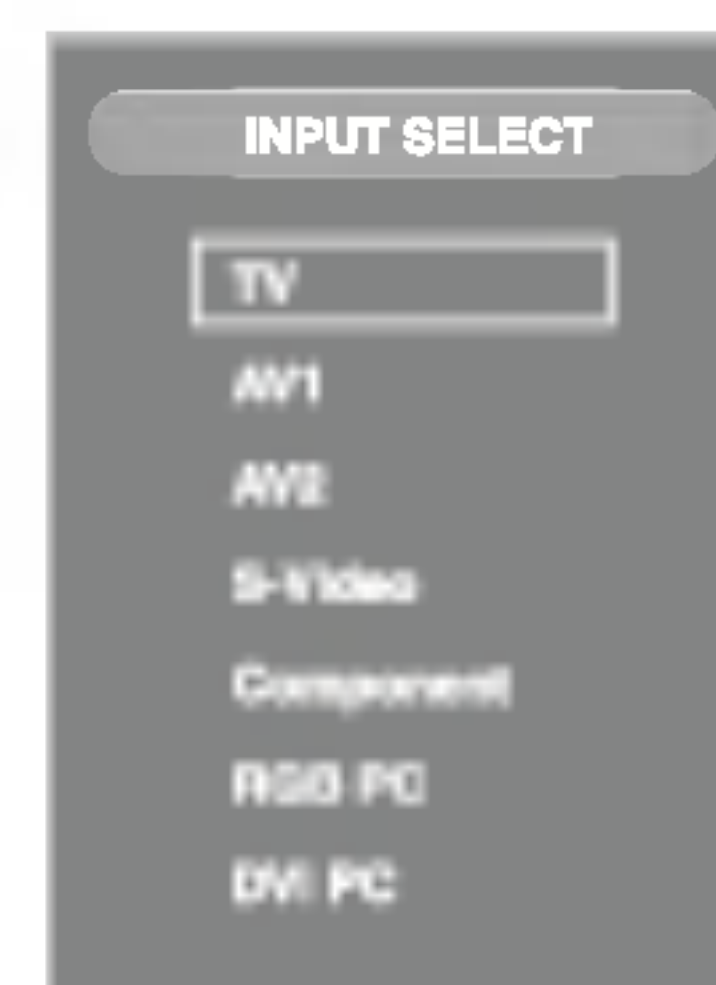

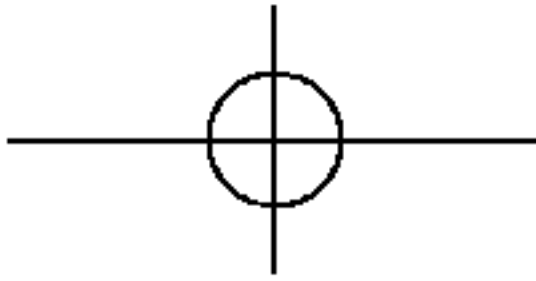

Selecting and Adjusting the Screen

Name of the Buttons in the Screen Adjustment Unit

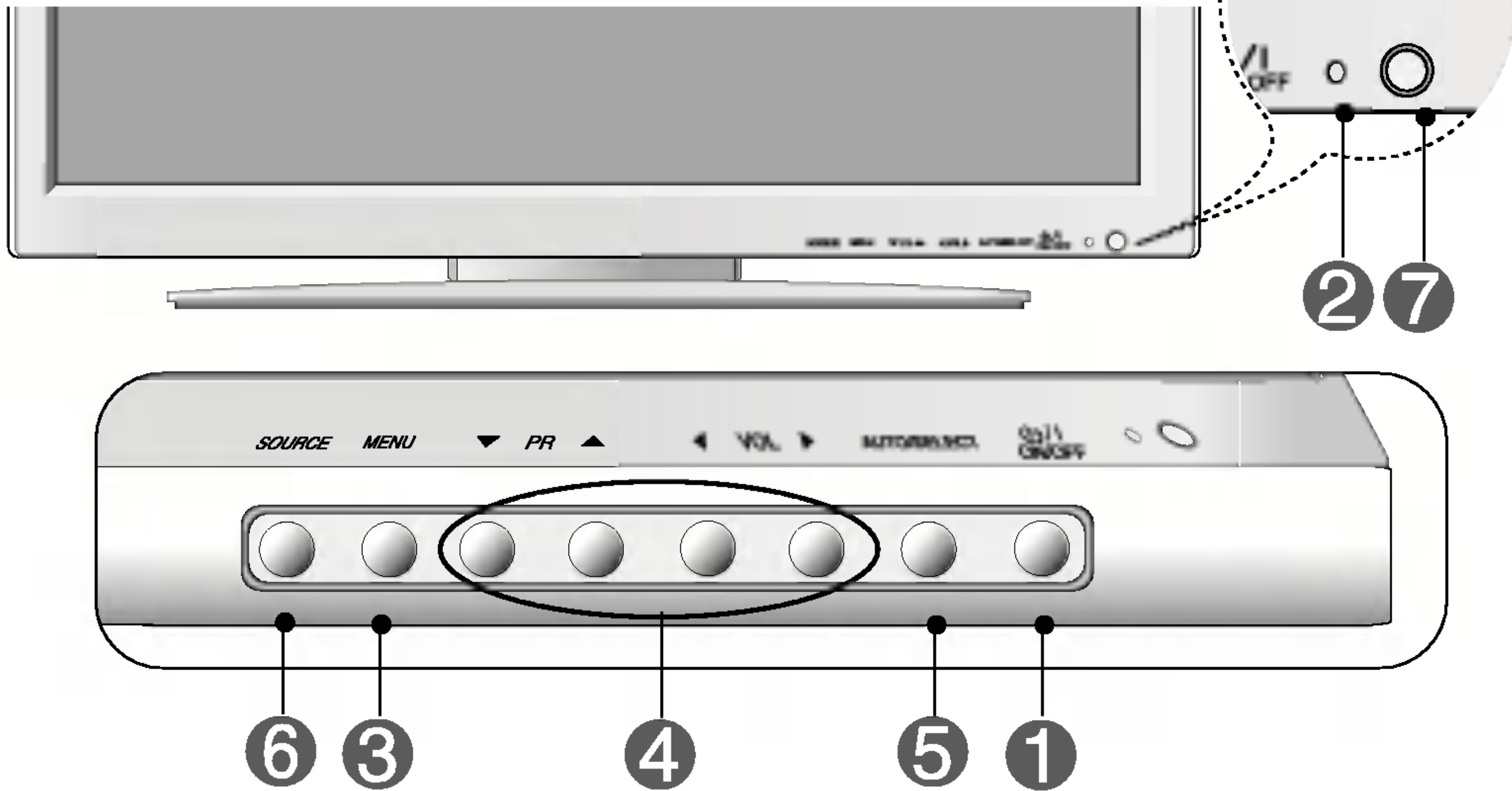

ENGLISH

- 1 Power Button**

 - Press this button to turn on the power.
Press this button again to turn it off.

 - 2 Power Indicator**

 - This Indicator lights up green when the display operates normally (on mode). If the display is in sleep (Energy Saving) mode, this indicator color changes to amber.

 - 3 MENU Button**

 - Use this button to show/hide the OSD (On Screen Display) menu screen.

 - 4 OSD Select / Adjust Button**

 - Use this button to select an icon or adjust the setting in the OSD screen.
- ▼▲
 - Use this button to directly control brightness and contrast of the PC signal (RGB PC / DVI PC).
- ◀▶
 - Adjust the volume.

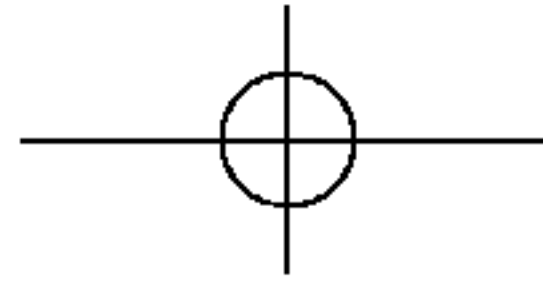

Selecting and Adjusting the Screen

● Name of the Buttons in the Screen Adjustment Unit

5 **AUTO/SELECT Button** [For PC Analog signal]



[Other signals]

- The current signal and mode information will be displayed.

6 **SOURCE Button** **SOURCE** → ▼▲ → **AUTO/SELECT**

- Select the input signal

TV	Television
AV1	SCART
AV2	Composite Video
S-Video	Separate Video
Component	HDTV/DVD
RGB PC	15-pin D-Sub analog signal
DVI PC	DVI digital signal

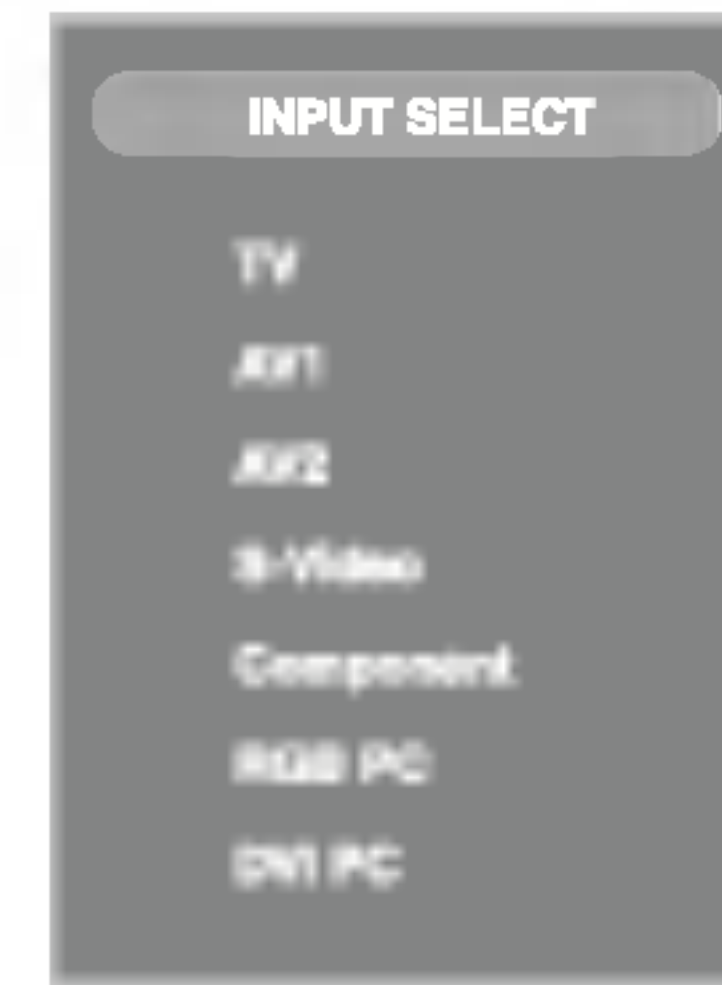



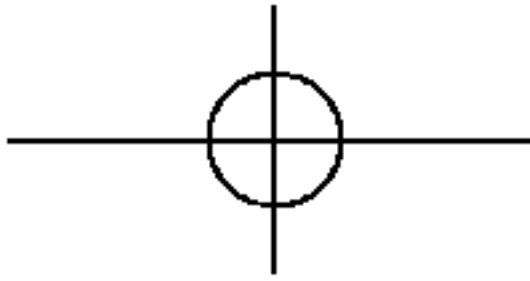



7 ● • The unit that receives the signal from the remote control.



OSD Menu

ENGLISH

Icon	Function Description
 STATION	Set/Selects the channel. (available only when watching TV)
 PICTURE	Adjusts screen brightness, contrast and color that you prefer.
 SOUND	Adjusts the audio function.
 TIMER	Adjusts the timer function.
 SPECIAL	Adjusts the screen status according to the circumstances.
 SCREEN	Adjusts the screen video.
 PIP/POP/PBP	Adjusts PIP/POP/PBP mode function.



Note

OSD(On Screen Display)

The OSD function enables you to adjust the screen status conveniently since it provides graphical presentation.

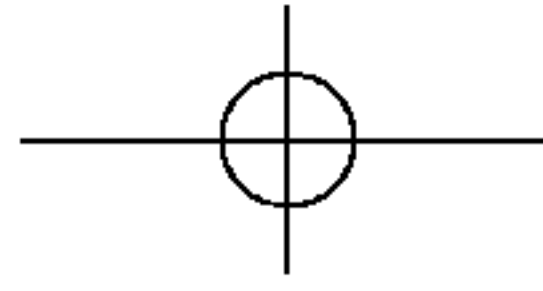

Selecting and Adjusting the Screen

● How to adjust the OSD (On Screen Display) screen

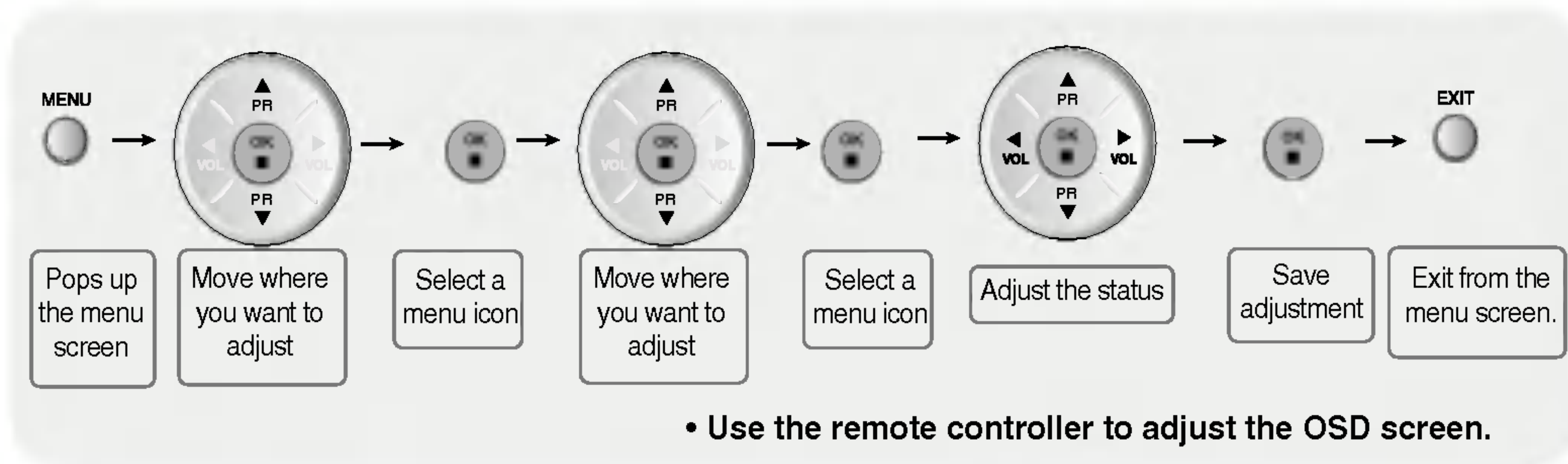

1 Press the **MENU** Button, then the main menu of the OSD appears.

2 To access a control, use the **▼ ▲** Buttons.

3 When the icon you want becomes highlighted, press the **OK** Button.

4 Use the **▼ ▲ ◀ ▶** Buttons to adjust the item to the desired level.

5 Accept the changes by pressing the **OK** Button.

6 Exit the OSD by pressing the **EXIT** Button.

● How to adjust the screen automatically

You need to adjust the screen display when connecting the monitor to a new computer or changing the mode. Refer to the following section to set an optimal monitor screen.

Auto in progress

Press the **AUTO/SELECT** button (**AUTO** button in a remote controller) in the PC analog signal. Then, an optimal screen status will be selected that fits into the current mode.

If adjustment is not satisfactory, you need to adjust screen position, clock and phase in the OSD menu.

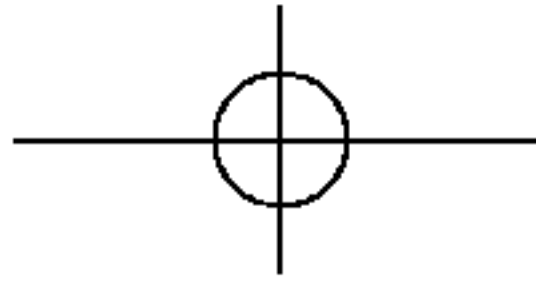

Set/Selects the channel when using the TV (Optional)

ENGLISH

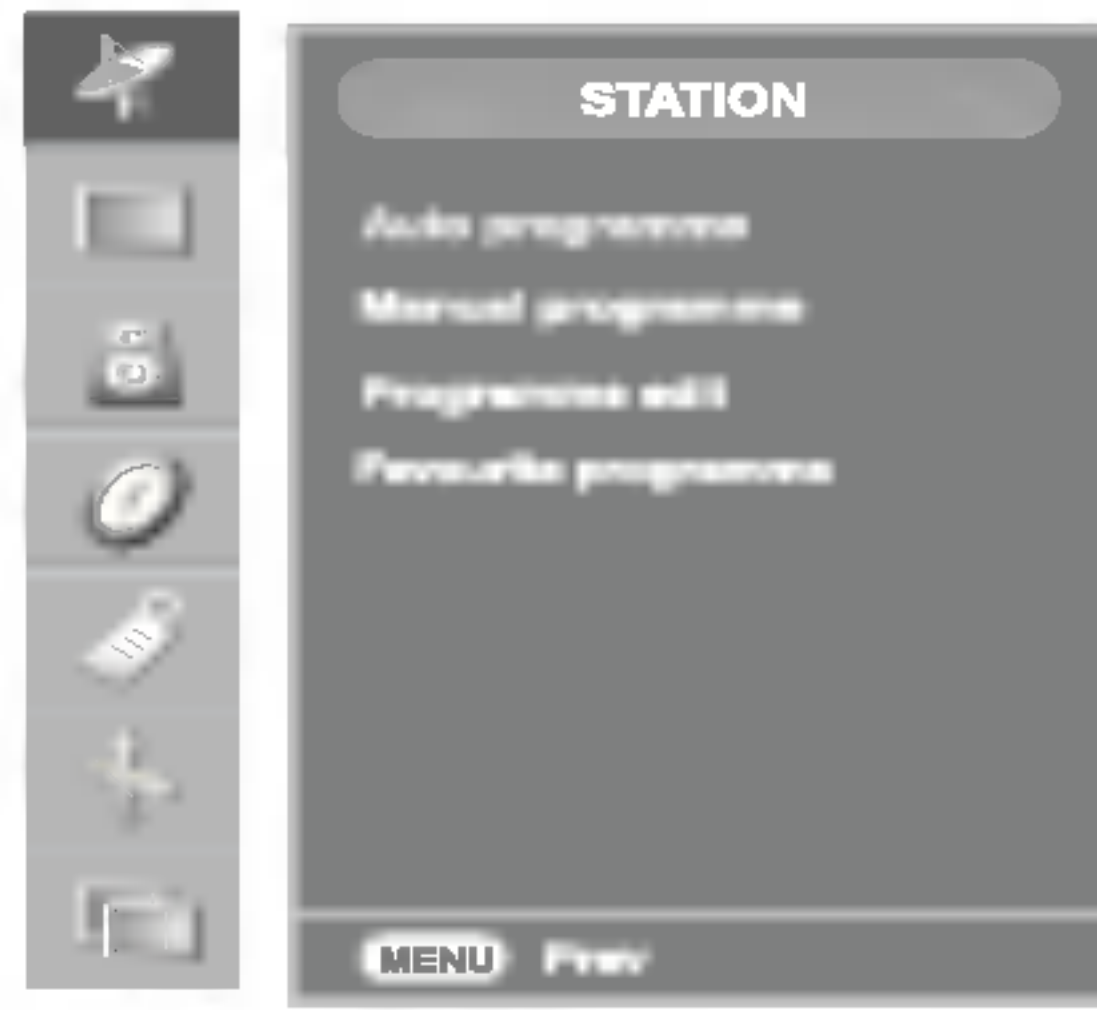

Auto programme



System

Press the ▼▲ buttons to select the TV system of the country or part of the world from where you want to receive the TV channels. If you want to receive 'SECAM L' channel, change the SYSTEM menu to 'L' before launching an automatic search.

Storage from

To select a programme number or enter the programme number with the number buttons from where you want to start searching for new channels. If you want to keep the channels 1 to 10 stored earlier, enter programme number 11. Your TV search for new channels from number 11 onwards.

Start

Press OK button to start automatic programming. all available TV channels are searched for and stored automatically. To stop auto programming, press the MENU or EXIT button. When auto programming is completed, the programme list menu appears.

Manual programme



To change the channel.

System

Press the ▼▲ buttons to select the TV system of the country or part of the world from where you want to receive the TV channels.

Storage

Press the ▼▲ buttons to select the channel number or enter the programme number with the number buttons in where you want to store channel.

Channel

Press the ▼▲ buttons to select C-CH for aerial channels or S-CH for cable channels. If you know the C-(01~69) or S-channel number(01~47), enter it directly with the digit buttons 0 to 9.
To select the channel reception type. : V/UHF / CABLE

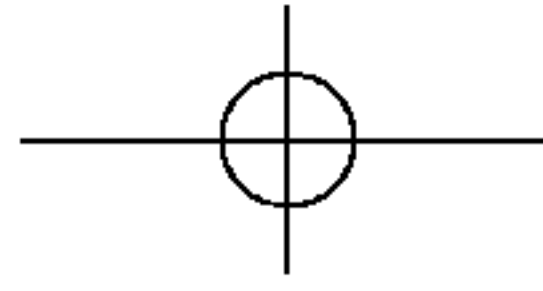

Selecting and Adjusting the Screen



Set/Selects the channel when using the TV (Optional)

- Name** To see the assigned channel name.
It is possible to change the name stored in the memory or to assign a name to a TV channel which has not yet been entered. A name with up to 5 letters or numbers can be given to the programme numbers 0 to 99.
Press the ◀ ▶ buttons to move cursor to be changed. -> Press the buttons to select a character.(space, number 0~9, and alphabet A~Z) -> Press the **AUTO/SELECT** button (or **OK** button on the remote control).
- Fine tune** In case of poor reception, you can improve the reception by fine tuning.
Use the ◀ ▶ buttons to fine tune for the best picture and sound.
- Search** Use the ◀ ▶ buttons to search next channel backward or forward direction.

Programme edit

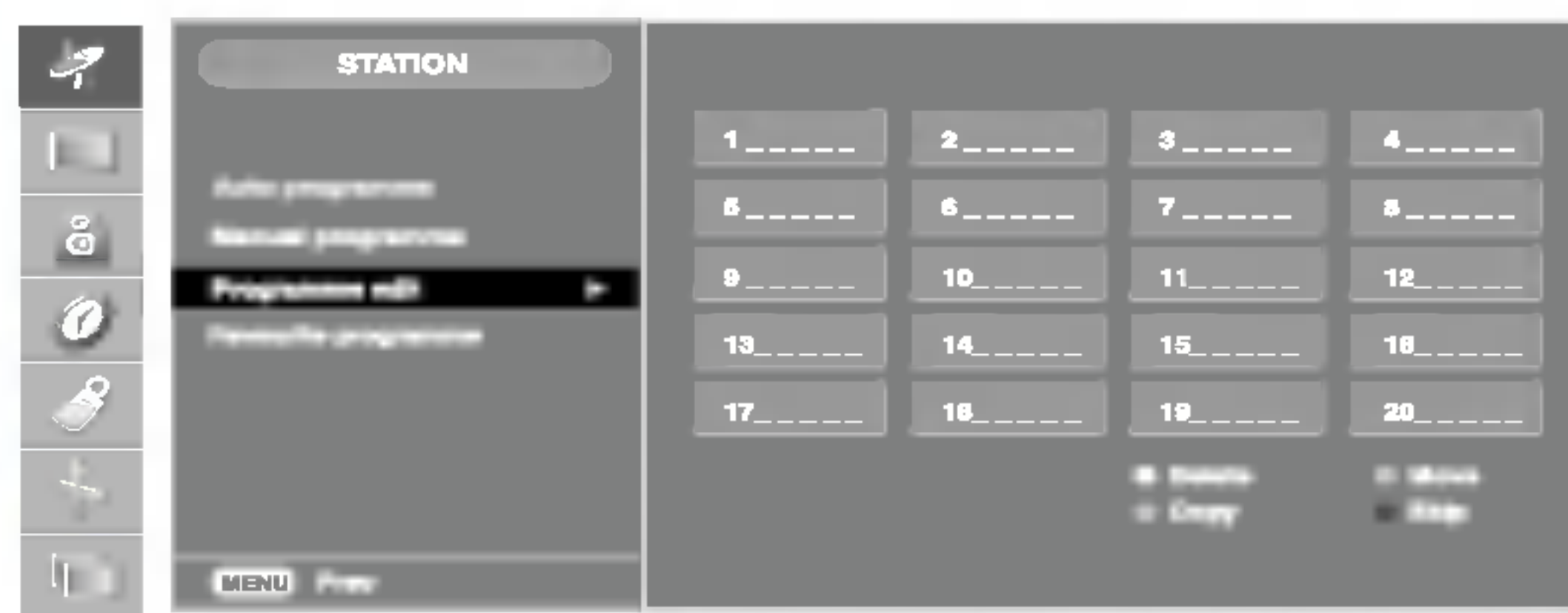

To adjust the **Edit** submenu function, Press the **OK** --> ◀ ▶ button on the remote control

- Delete** Press the ▼▲◀▶ buttons to select a TV channel to be deleted.
-> Press the red key on the remote control -> The selected TV channel number is deleted, all the following channels are shifted up one position.
- Copy** Press the ▼▲◀▶ buttons to select a TV channel to be copied. -> Press the green key on the remote control. All the following channel numbers are shifted down one position.
- Move** Press the ▼▲◀▶ buttons to select a channel number to be moved. -> Press the yellow key on the remote control. -> Press the ▼▲◀▶ buttons to move the TV channel to the desired channel number. -> Press the yellow key again to release this function.
- Skip** Press the ▼▲◀▶ buttons to select a channel number to be skipped. -> Press the blue key on the remote control. The skipped TV channel is displayed in blue.

Favourite programme

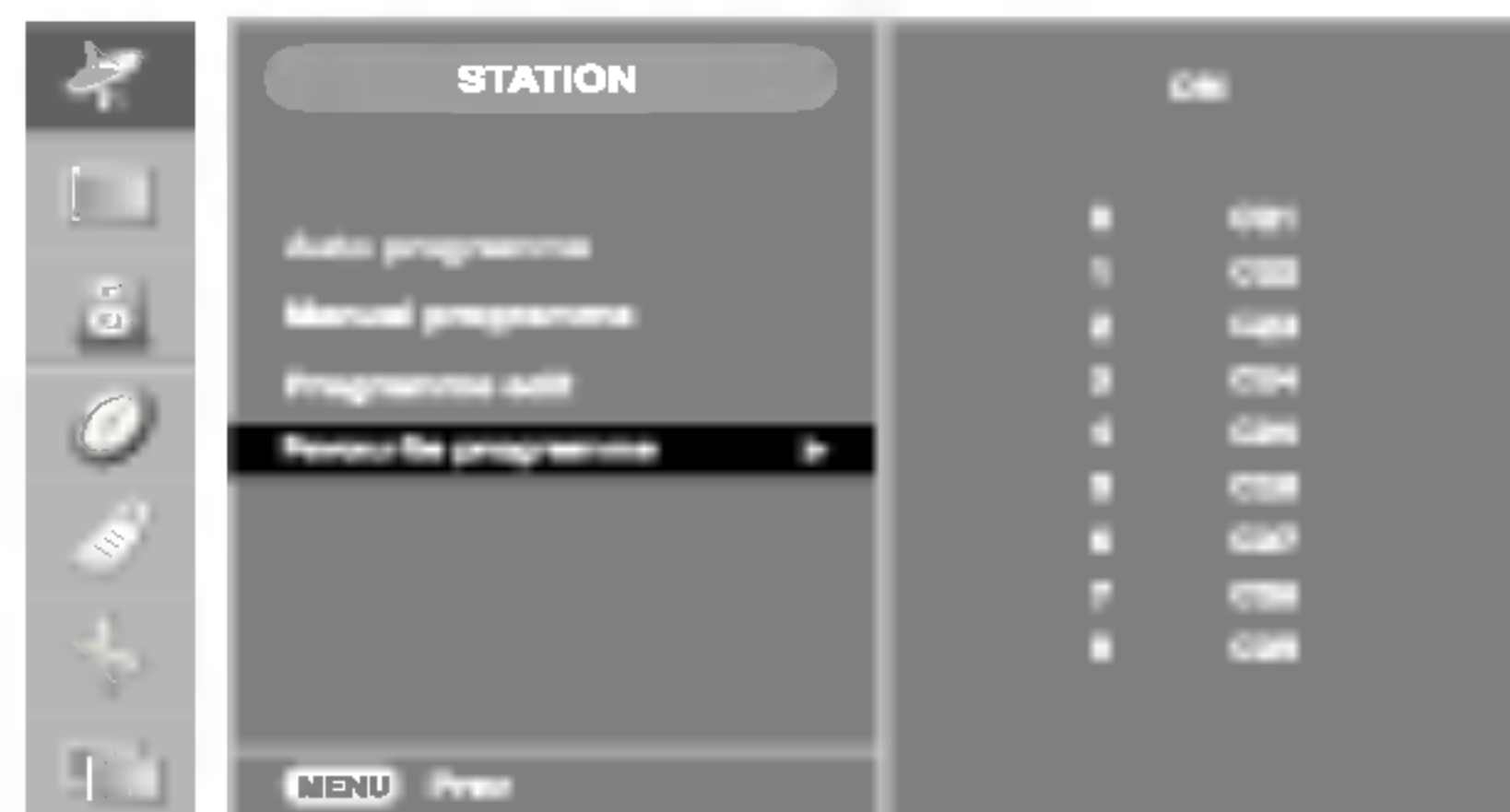

This function lets you select your favourite programmes directly. (8 channel)
Press the ▼▲◀▶ buttons to select a channel number.

* **Q.VIEW** button(remote control) :
Rotate Favourite channel

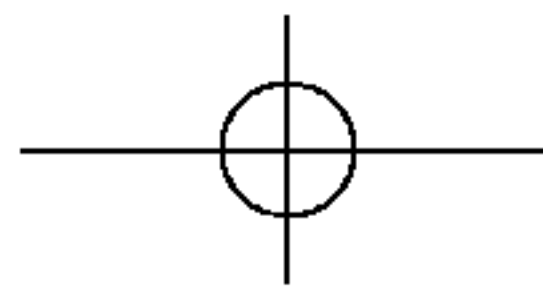

Adjusting Screen Color

ENGLISH

PSM



TV/ AV1/ AV2/ S-Video/ Component input only

The PSM function automatically adjusts the screen image quality depending on the AV/TV usage environment.

- **Dynamic** : Select this option to display with a sharp image.
- **Standard** : The most general and natural screen display status.
- **Mild** : Select this option to display with a mild image.
- **Game** : Select this option to enjoy dynamic image when playing a game.
- **User** : Select this option to use the user-defined settings.



Contrast
To adjust the contrast of the screen.

Brightness
To adjust the brightness of the screen.

Color
To adjust the color to desired level.

Sharpness
To adjust the cleanliness of the screen.

Tint
To adjust the tint to desired level.
This function is available only in NTSC broadcasting mode.

ACC



Selecting a factory setting color set.

- **Warm** : Slightly reddish white.
- **Normal** : Slightly bluish white.
- **Cool** : Slightly purplish white.



Note

If the PSM setting in the PICTURE menu is set to Dynamic, Standard, Mild or Game the subsequent menus will be automatically set.

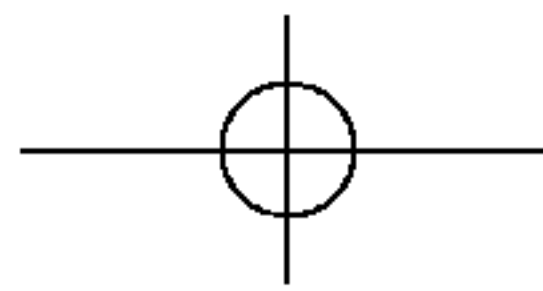

Selecting and Adjusting the Screen

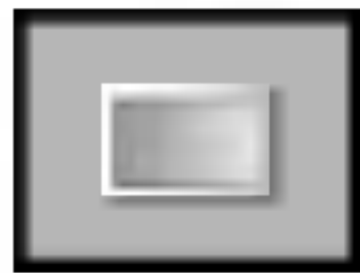

Adjusting Screen Color

CSM



RGB PC / DVI PC input only

- **6500K/9300K**
Selecting a factory setting color set.
6500K: Slightly reddish white.
9300K: Slightly bluish white.
- **User** : Select this option to use the user-defined settings.



Contrast

To adjust the contrast of the screen.

Brightness

To adjust the brightness of the screen.

Red / Green / Blue

Set your own color levels.



Adjusting the audio function

SSM



The best sound tone quality will be selected automatically depending on the video type that you're currently watching.

- **Flat**
The most commanding and natural audio.
- **Music**
Select this option to enjoy the original sound when listening to the music.
- **Movie**
Select this option to enjoy sublime sound.
- **Speech**
Select this option to watch sports broadcasting.
- **User**
Select this option to use the user-defined audio settings.

Balance Use this function to balance sound from the left and right speakers.

AVL To adjust uneven sound volumes across all channels or signals automatically to the most appropriate level. To use this feature, select ON.

SRS WOW Set the SRS WOW menu on.
The SRS WOW function plays back the mono or stereo sound input with the dynamic surround effects. It will provide rich and profound sound tone. If you set the SRS WOW on, user audio setting can not be adjusted.



Note

When connected to your computer and the 'SSM' setting in the audio menu is one of Flat, Music, Movie or Speech, the available menus are Balance, AVL and SRS WOW .

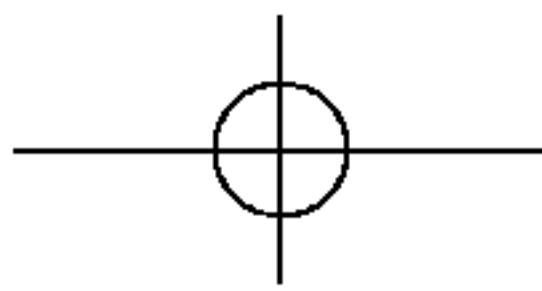

Adjusting the timer function

ENGLISH

Clock



If the time is on the clock is incorrect, reset the clock manually.

- 1) Press the **MENU** button and then use **▼▲** button to select the **TIMER** menu.
- 2) Press the **▶** button and then use **▼▲** button to select the **Clock** menu.
- 3) Press the **▶** button and then use **▼▲** button to set the hour(01~12).
- 4) Press the **▶** button and then use **▼▲** button to set the minutes(00~59).
- 5) Press the **▶** button and then use **▼▲** button to set the morning(AM) or afternoon(PM).

Off / On Timer

Setting is available, however, operation is only allowed upon TV input
The off timer automatically switches the set to standby at the pre-set time.

- 1) Press the **MENU** button and then use **▼▲** button to select the **TIMER** menu.
- 2) Press the **▶** button and then use **▼▲** button to select **Off Timer** or **On Timer**.
- 3) Press the **▶** button and then use **▼▲** button to set the hour(01~12).
- 4) Press the **▶** button and then use **▼▲** button to set the minutes(00~59).
- 5) Press the **▶** button and then use **▼▲** button to set the morning(AM) or afternoon(PM).
- 6) Press the **▶** button and then use **▼▲** button to select **On** or **Off**.
- 7) Only **On Timer** function; Press the **▶** button and then **▼▲** button to set the channel at turn-on. Then, press the **▶** button and then use **▼▲** button to set the turn-on sound level.

Auto Off

Setting is available, however, operation is only allowed upon TV input

If **Auto Off** is active and there is no input signal, the TV switches to Standby mode automatically after 10 minutes.

- 1) Press the **MENU** button and then use **▼▲** button to select the **Auto Off** menu.
- 2) Press the **▶** button and then use **▼▲** button to select **On** or **Off**.



Note

- In the event of power interruption (disconnection or power failure), the clock must be reset.
- Two hours after the set is switched on by the on time function it will automatically switch back to standby mode unless a button has been pressed.
- Once the on or off time is set, these functions operate daily at the preset time.
- Off Timer function overrides On Timer function if they are set to the same time.
- The set must be in standby mode for the On timer to work.

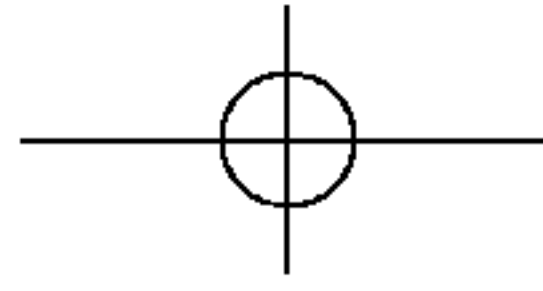

Selecting and Adjusting the Screen



Selecting the options



Input



If you press the button once, the following Input Signal Window will appear. Select the signal type you want using the ▼▲ button.

Child Lock

Use the ▼▲ buttons to select **On** or **Off**. The Set can be set up so that it can only be used with the remote control. This feature can prevent unauthorized viewing.

In order to lock the OSD screen adjustment, set the **Child Lock** tab to the 'On' position. In order to unlock it, do the following :

- 1) Push the **MENU** button on the remote control and set **Child Lock** to the 'Off' position.

Language

To choose the language in which the control names are displayed.

Power Indicator

Use this function to set the power indicator on the front side of the monitor to **On** or **Off**. If you set **Off**, it will go off. If you set **On** at any time, the power indicator will automatically be turned on.

Transparency

To adjust the transparency of the OSD menu screen.

Zoom

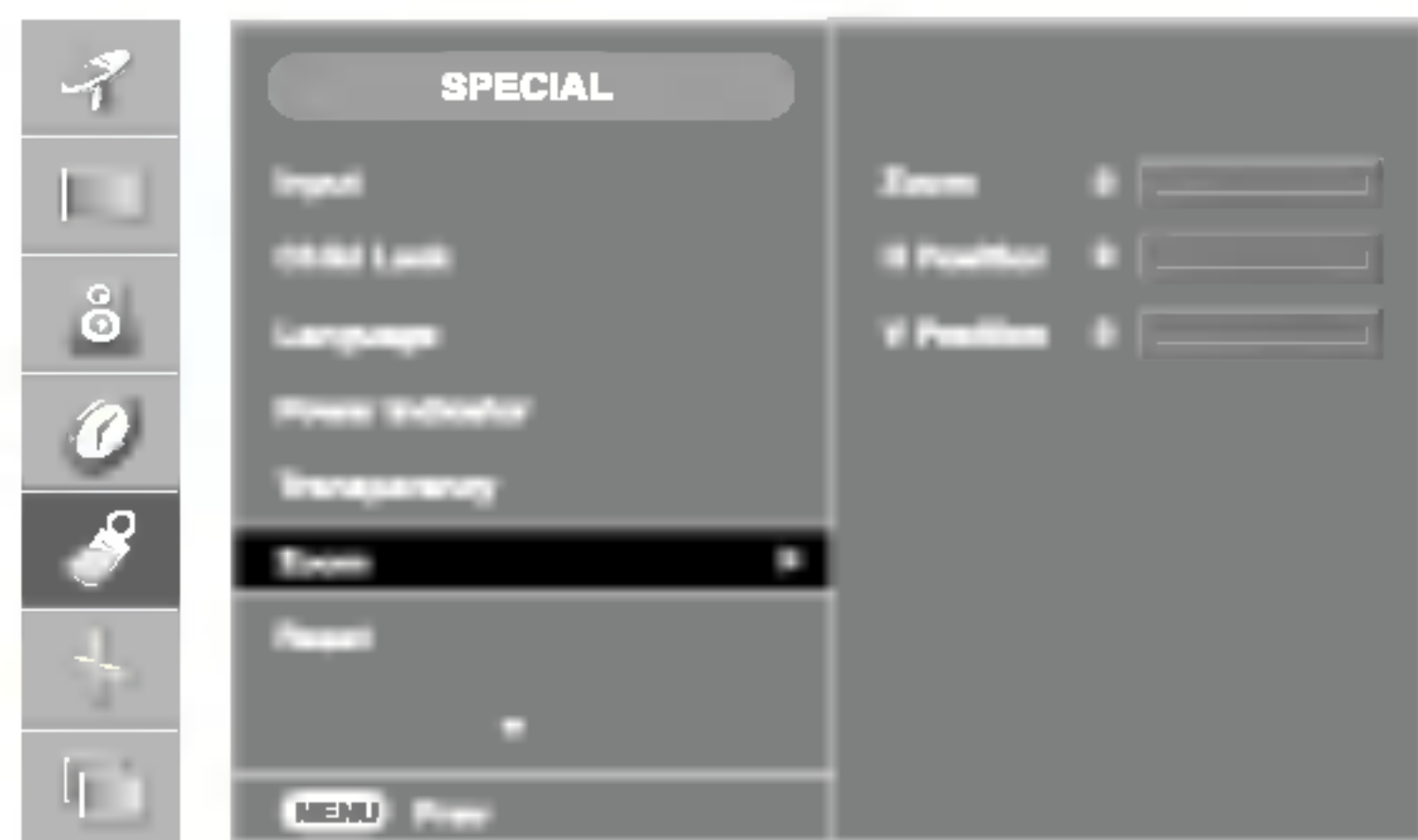

Use this function to zoom in the screen. When you turn the monitor off and on again, the default screen size will be restored. Press the ► button to display the submenu for Zoom.

* If the zooming value is set to '0', vertical and horizontal positioning cannot be adjusted.

* The variable range can differ according to the type of the input signal.

Reset

Use this function to reset the monitor to the factory default. However, language selection will not be initialized.



Note

the **Zoom** menu will be disabled if the screen size is not Full or PIP/POP/PBP is in use.

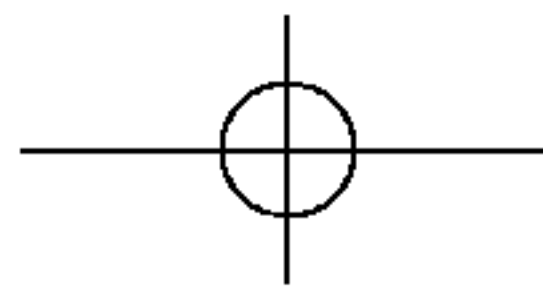

Selecting the options

ENGLISH

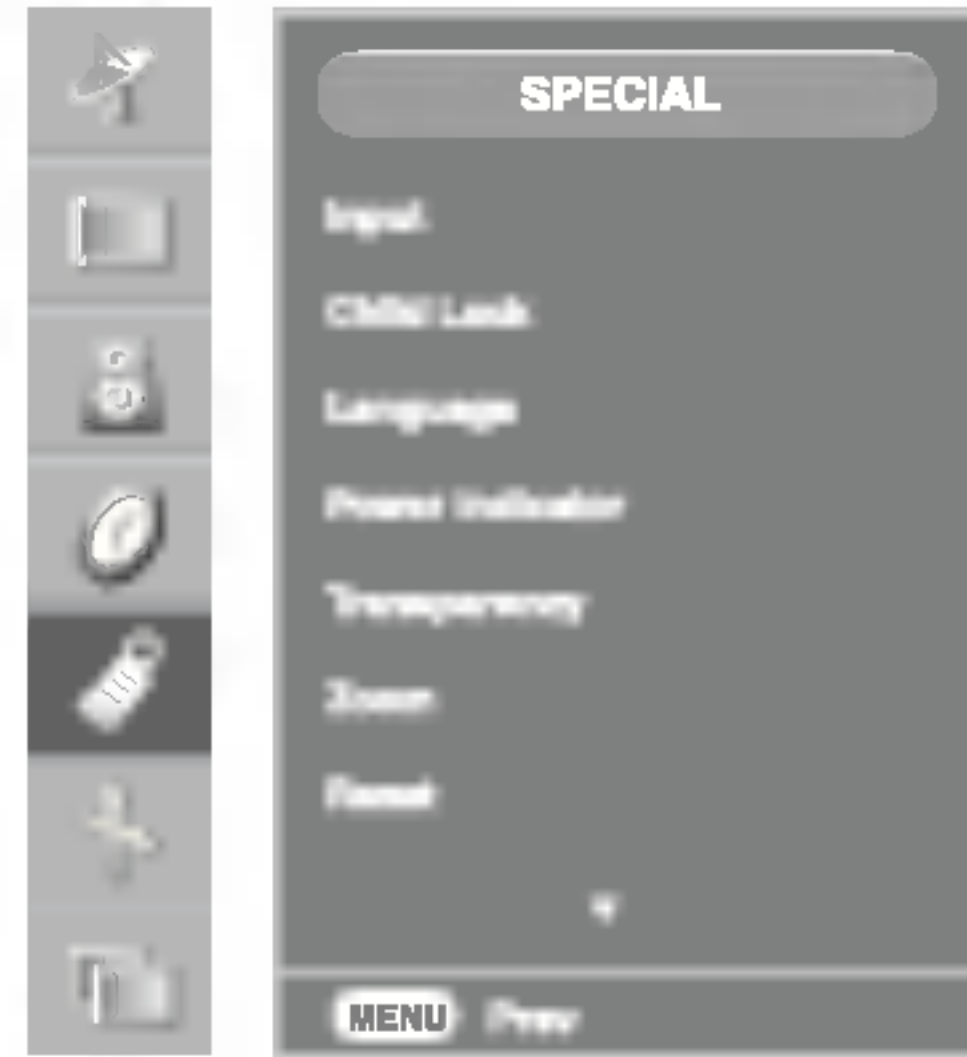

Set ID



You can assign a unique **Set ID NO** (name assignment) to each monitor when several monitors are connected for display. Specify the number (0~99) using the ▼▲ button and exit. Use the assigned **Set ID** to individually control each monitor using the Monitor Control Program.

Logo Display Lamp

Use this function to set the Logo Display Lamp on the front side of the monitor to **On** or **Off**. If you set **On**, the lamp will automatically be turned on.

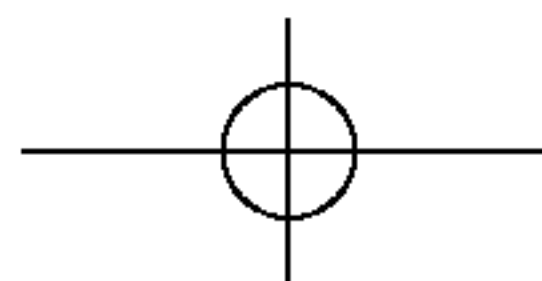
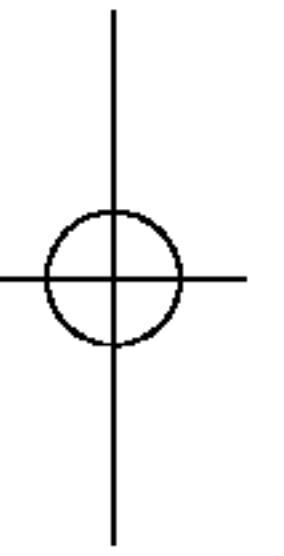
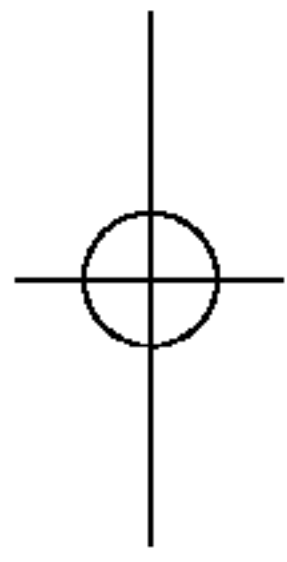

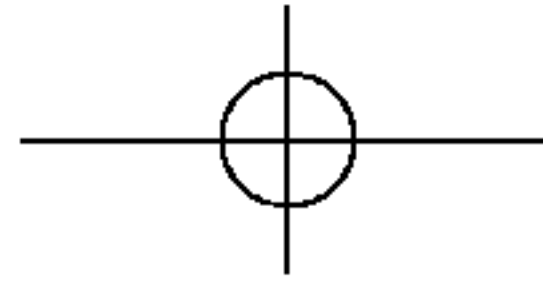

Selecting and Adjusting the Screen



Adjusting Screen CLOCK/PHASE and Position

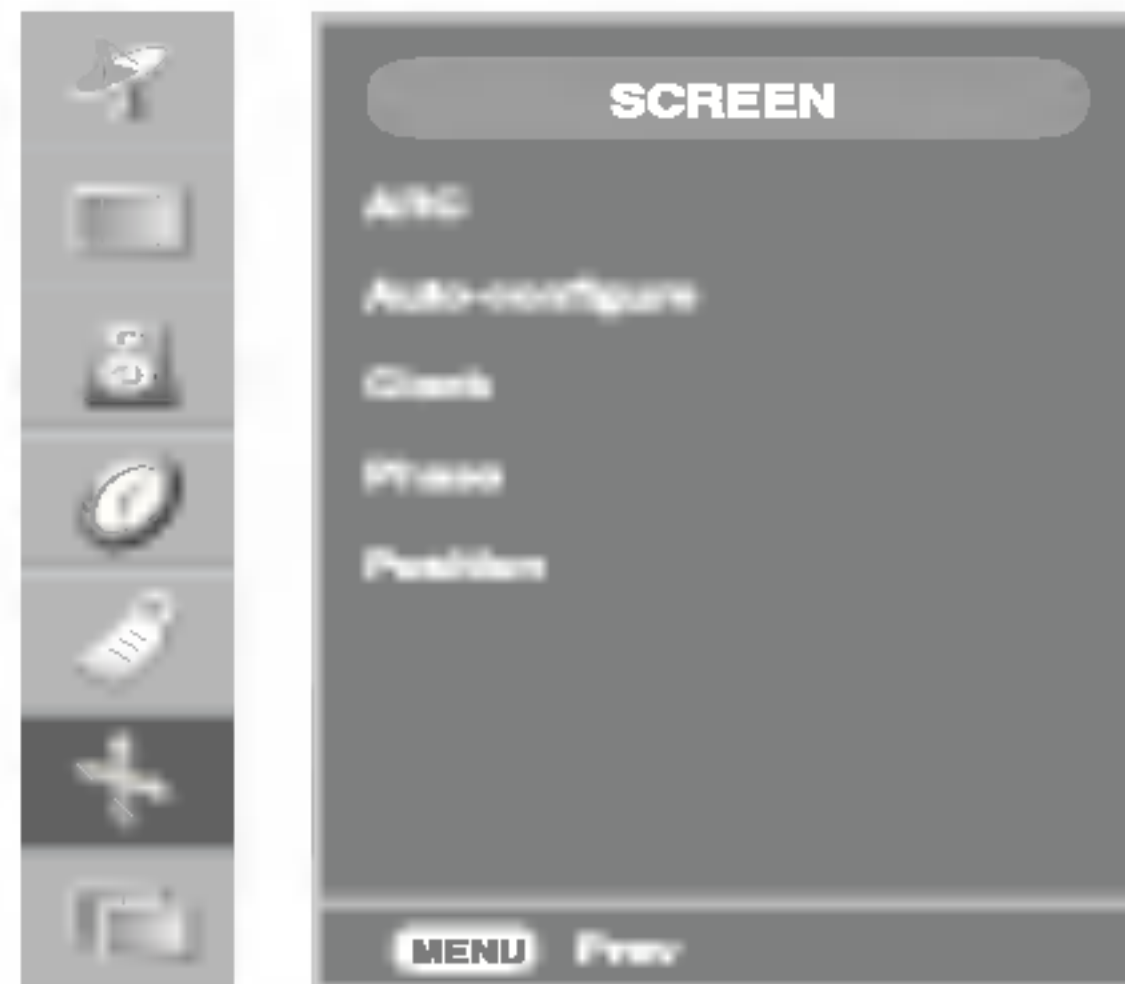

ARC

To select the image size of the screen.

<TV / AV1 / AV2 / S-Video / Component input only>

<RGB PC / DVI PC input only>



* When the **component** input signal is 720p or 1080i, the spectacle function is not supported.

Auto-configure

This button is for the automatic adjustment of the screen position, clock and phase. This function is suitable for analogue signal input only(RGB PC input only).

Clock

To minimize any vertical bars or stripes visible on the screen background. The horizontal screen size will also change. This function is suitable for analogue signal input only(RGB PC input only).

Phase

To adjust the focus of the display. This item allows you to remove any horizontal noise and clear or sharpen the image of characters. This function is suitable for analogue signal input only(RGB PC input only).

Position

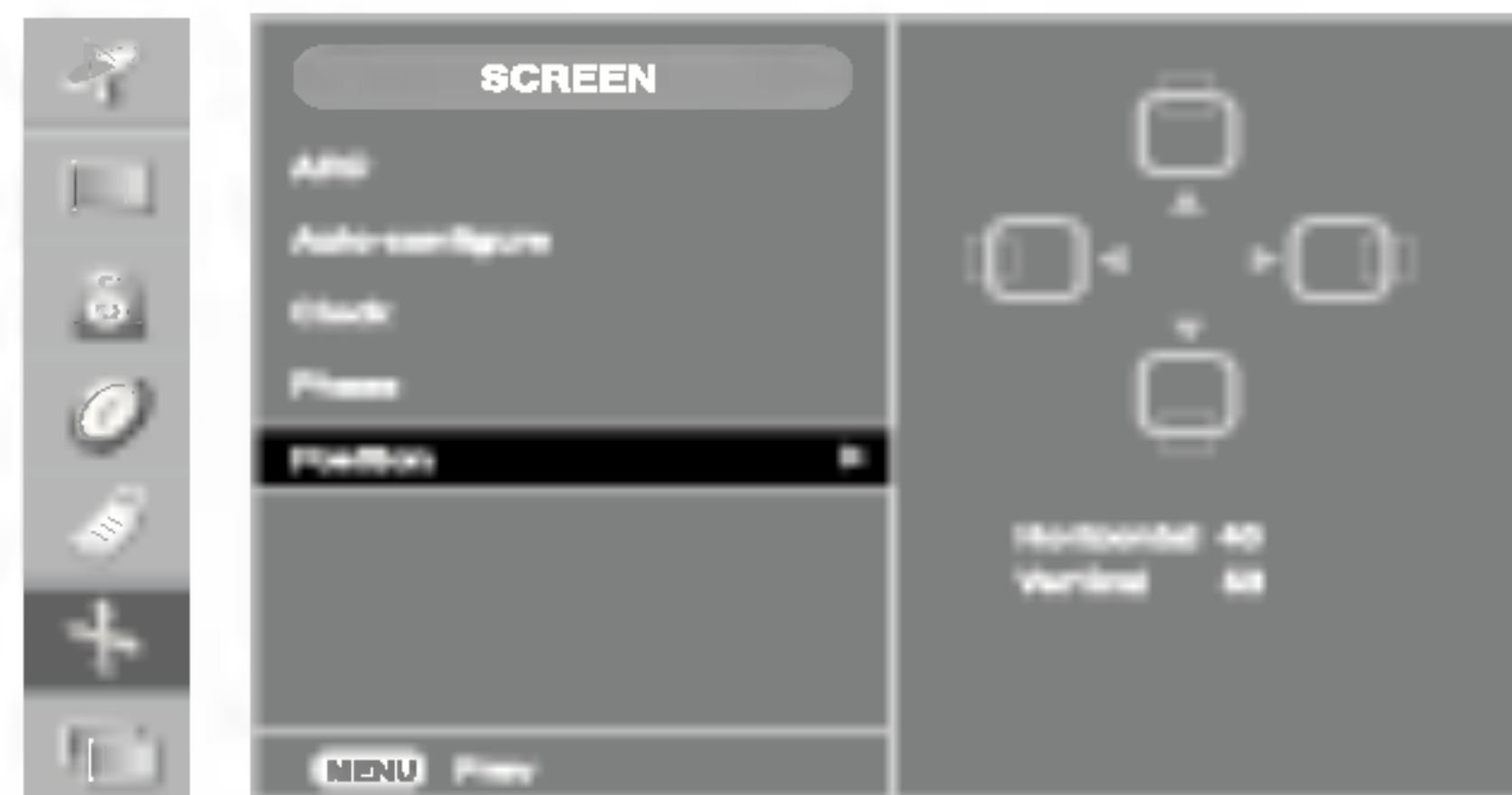

To adjust position of the screen (RGB PC input only).

Press the **▶** button to display the submenu for position.

- ◀ Left Moving the screen position horizontally.
- ▶ Right
- ▲ Up Moving the screen position vertically.
- ▼ Down

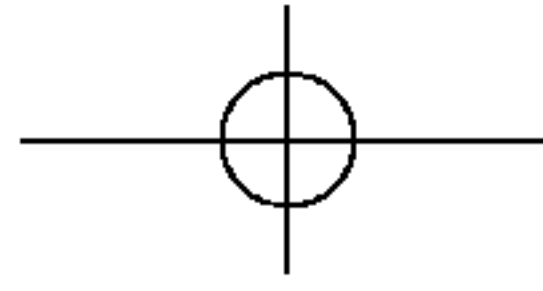

Adjusting PIP/POP/PBP Mode (Multiple Screen) Functions

ENGLISH



On/Off



PIP
After selecting **PIP** in the **PIP On/Off** menu, the following menu items can be adjusted.



POP
After selecting **POP** in the **POP On/Off** menu, the following menu items can be adjusted.



PBP
After selecting **PBP** in the **PBP On/Off** menu, the following menu items can be adjusted.

- Source** To select an input signal for PIP/POP/PBP.
- Size** To adjust the size of the PIP/POP/PBP screen. (PIP : Small, Medium, Large / PBP : Full, 4:3)
- Image** To adjust the image of the PIP/POP/PBP screen; Press the **▶** button to display the submenu for PIP/POP/PBP image. Use the **◀ ▶** buttons to adjust the item to the desired level. The items of the sub-menu may vary depending on the type of the source.



- **Contrast**
Adjust PIP/POP/PBP screen contrast.
- **Brightness**
Adjust PIP/POP/PBP screen brightness.
- **Color**
Adjust the PIP/POP/PBP screen color.
- **Tint**
To adjust the tint to desired level.
This function is available only in NTSC broadcasting mode.

* The sub-menu can differ according to the type of the input signal.

- Sound** To turn the PIP/POP/PBP sound on/off.

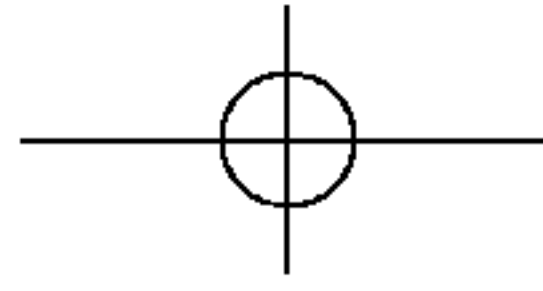

Selecting and Adjusting the Screen



Adjusting PIP/POP/PBP Mode (Multiple Screen) Functions

Position

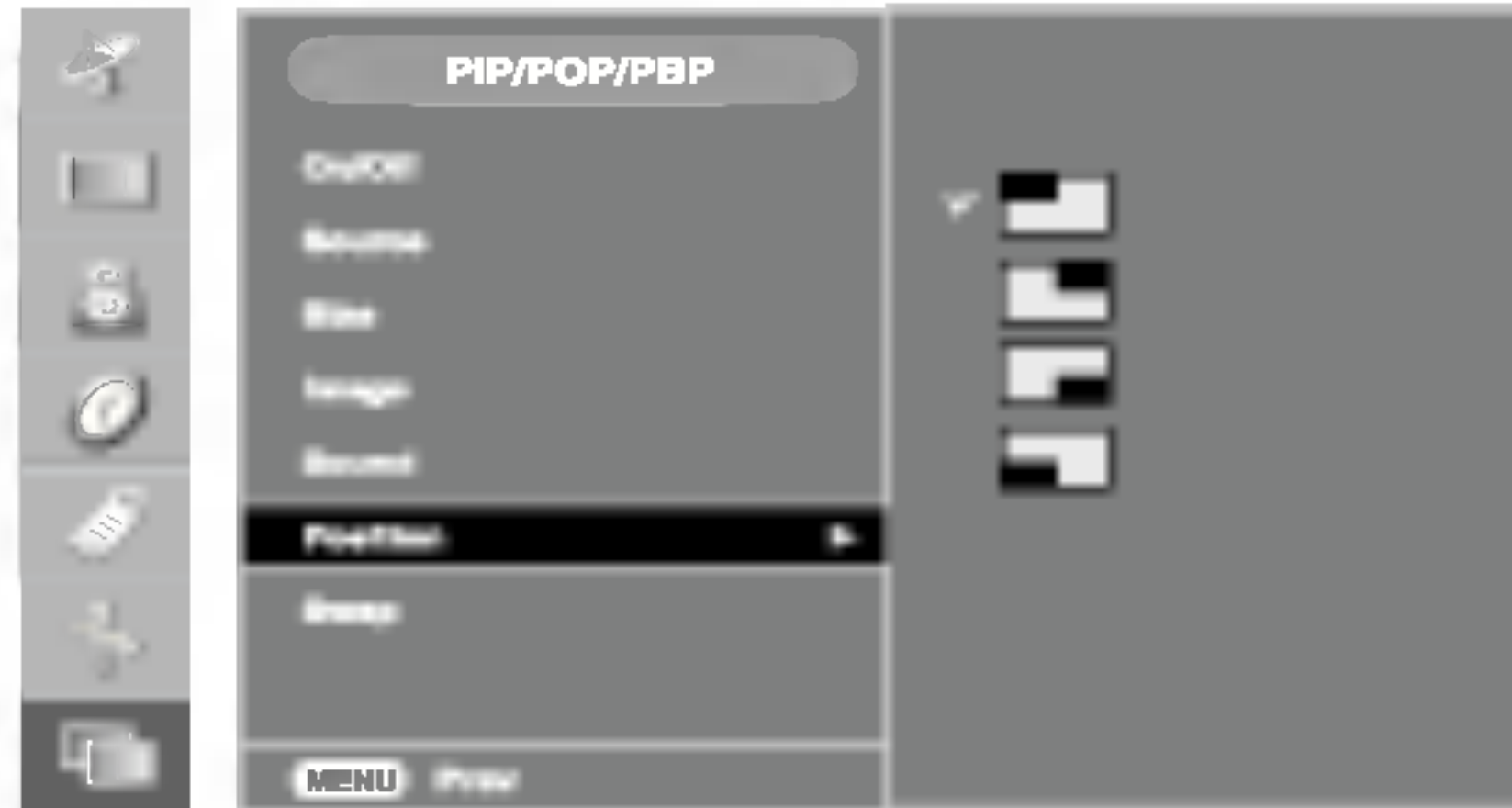

To adjust the position to PIP screen.

Swap



To switch the main-screen and sub-screen in PIP/POP/PBP mode.

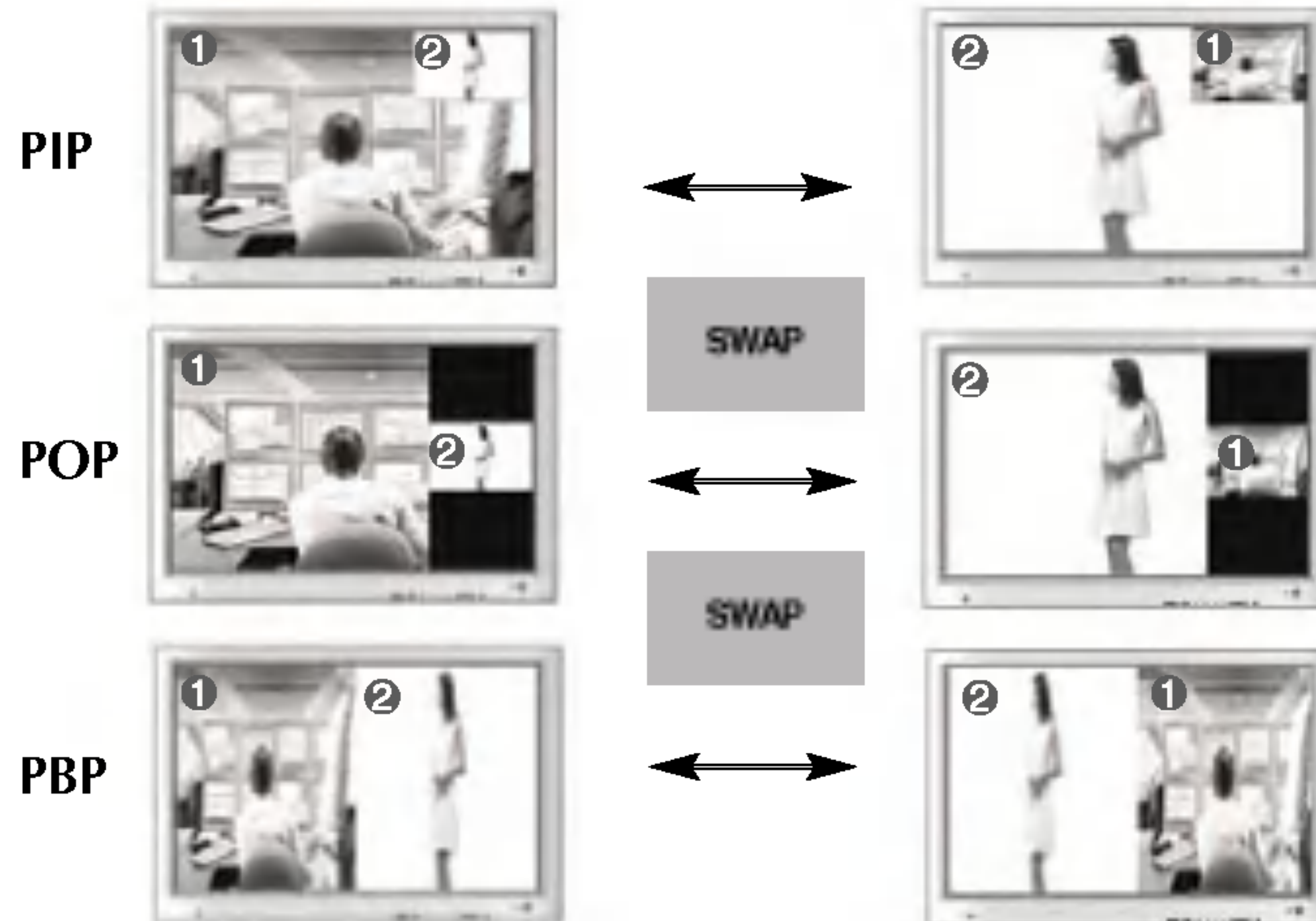

Controlling the Multiple Monitors (RS-232C protocol)

Use this method to connect several monitors to a single PC.
You can control several monitors at a time by connecting them to a single PC.

ENGLISH

● Connecting the cable

Connect the RS-232C cable as shown in the picture.

* The RS-232C protocol is used for communication between the PC and monitor. You can turn the monitor on/off, select an input source or adjust the OSD menu from your PC.

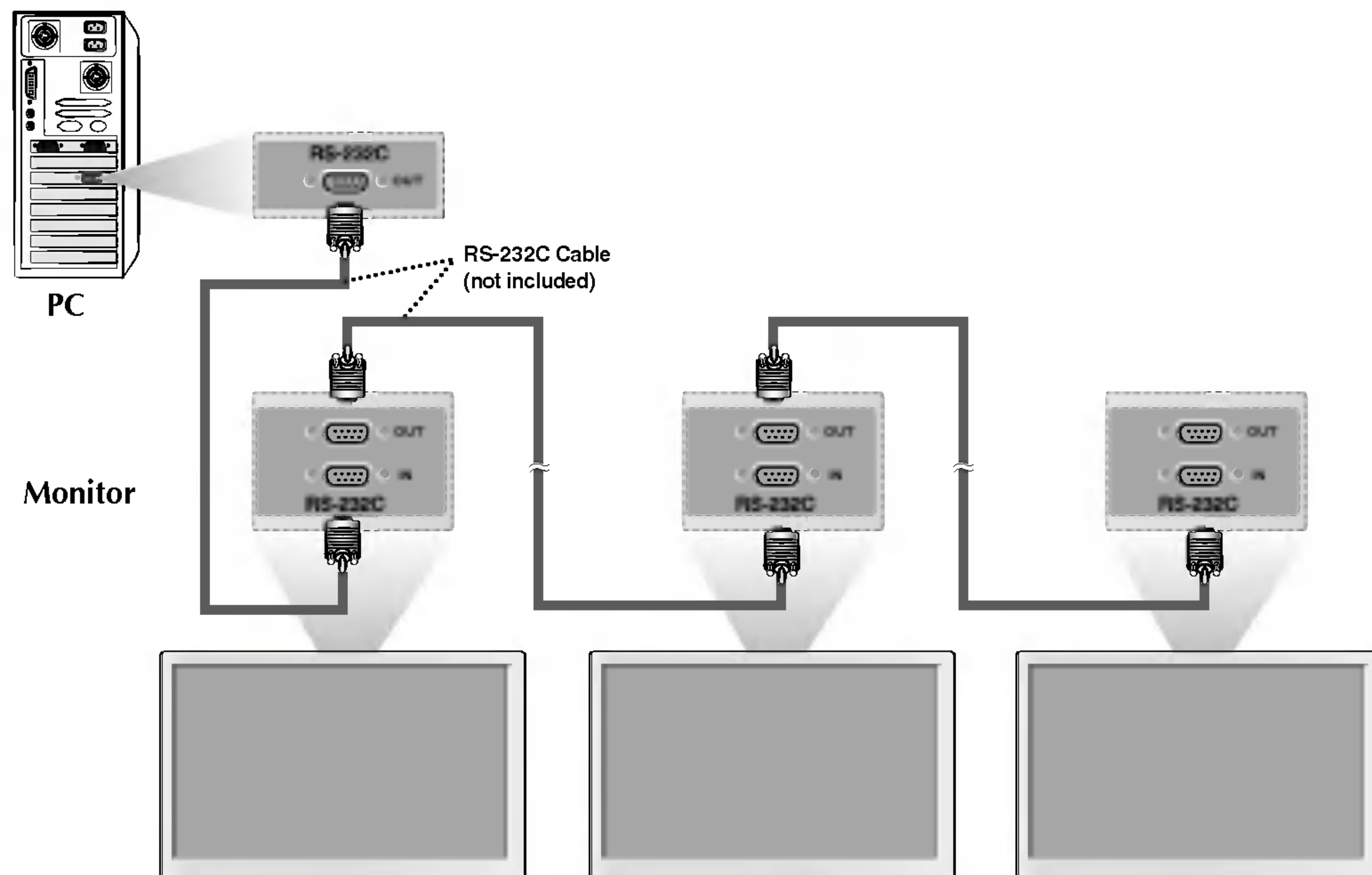

● Communication Parameter

- ▶ Baud Rate : 9600bps (UART)
- ▶ Data Length : 8bits
- ▶ Parity Bit : None
- ▶ Stop Bit : 1bit
- ▶ Flow Control : None
- ▶ Communication Code : ASCII code

Controlling the Multiple Monitors (RS-232C protocol)

Command Reference List

	COMMAND 1	COMMAND 2	DATA (Hexa)
01. Power	k	a	00H - 01H
02. Input Select	k	b	00H - 08H
03. Aspect Ratio	k	c	01H - 06H
04. Screen Mute	k	d	00H - 01H
05. Volume Mute	k	e	00H - 01H
06. Volume Control	k	f	00H - 64H
07. Contrast	k	g	00H - 64H
08. Brightness	k	h	00H - 64H
09. Color	k	i	00H - 64H
10. Tint	k	j	00H - 64H
11. Sharpness	k	k	00H - 64H
12. OSD Select	k	l	00H - 01H
13. Remote Lock On/Off	k	m	00H - 01H
14. PIP/PBP/POP On/Off	k	n	00H - 03H
15. PIP Position	k	q	00H - 03H
16. Balance	k	t	00H - 64H
17. ACC	k	u	00H - 03H
18. PIP/PBP/POP SOURCE	k	y	00H - 08H
19. Auto Configure	j	u	01H
20. Tune Command	m	a	01H - 7DH
21. Key	m	c	Key Code

Transmission / Receiving Protocol

Transmission

[Command1][Command2][][Set ID][][Data][Cr]

- * [Command 1]: First command. (j or k)
- * [Command 2]: Second command.
- * [Set ID]: You can adjust the set ID to choose desired monitor
ID number in Special menu. Adjustment range is 0 ~ 99.
When selecting Set ID '0', every connected
TV set is controlled. Set ID is indicated as decimal
(0~99) on menu and as Hexa decimal (0x0~0x64)
on transmission/receiving protocol.
- * [DATA]: To transmit command data.
Transmit 'FF' data to read status of command.
- * [Cr]: Carriage Return
ASCII code '0x0D'
- * []: ASCII code Space (0x20)

● Transmission / Receiving Protocol

OK Acknowledgement

[Command2][][Set ID][][OK][Data][x]

* The Monitor transmits ACK (acknowledgement) based on this format when receiving normal data. At this time, if the data is data read mode, it indicates present status data. If the data is data write mode, it returns the data of the PC computer.

Error Acknowledgement

[Command2][][Set ID][][NG][Data][x]

* The Monitor transmits ACK (acknowledgement) based on this format when receiving abnormal data from non-viable functions or communication errors.

Data 1: Illegal Code

2: Not supported function

3: Wait more time

01. Power On(Command : a)

▶ To control Power On/Off of the Set.

Transmission

[k][a][][Set ID][][Data][Cr]

Data 0 : Power Off 1 : Power On

Acknowledgement

[a][][Set ID][][OK][Data][x]

▶ To show the status of Power On/Off.

Transmission

[k][a][][Set ID][][FF][Cr]

Data 0 : Power Off 1 : Power On

Acknowledgement

[a][][Set ID][][OK][Data][x]

* The Monitor transmits ACK (acknowledgement) based on this format when receiving normal data. At this time, if the data is data read mode, it indicates present status data. If the data is data write mode, it returns the data of the PC computer.

Controlling the Multiple Monitors (RS-232C protocol)

● Transmission / Receiving Protocol

02. Input Select(Command : b) (Main Picture Input)

- ▶ To select input source for the Set.
You can also select an input source using the SOURCE button on the remote control.

Transmission

```
[k][b][ ][Set ID][ ][Data][Cr]
```

Data 0 : TV 5 : AV2
 2 : AV1 6 : RGB PC
 3 : S-Video 8 : DVI PC
 4 : Component

Acknowledgement

```
[b][ ][Set ID][ ][OK][Data][x]
```

03. Aspect Ratio(Command : c) (Main picture format)

- ▶ To adjust the screen format.
You can also adjust the screen format using the ARC (Aspect Ratio Control) button on remote control or in the Screen menu.

Transmission

```
[k][c][ ][Set ID][ ][Data][Cr]
```

Data 1 : 4:3
 2 : Full
 3 : Spectacle
 4 : Zoom1
 5 : Zoom2
 6 : 1:1(PC)

Acknowledgement

```
[c][ ][Set ID][ ][OK][Data][x]
```

● Transmission / Receiving Protocol

04. Screen Mute(Command : d)

- ▶ To select screen mute on/off.

Transmission

```
[k][d][ ][Set ID][ ][Data][Cr]
```

Data 0 : Screen mute off (Picture on)
1 : Screen mute on (Picture off)

Acknowledgement

```
[d][ ][Set ID][ ][OK][Data][x]
```

05. Volume Mute(Command : e)

- ▶ To control On/Off of the Volume Mute.

Transmission

```
[k][e][ ][Set ID][ ][Data][Cr]
```

Data 0 : Volume Mute On (Volume Off)
1 : Volume Mute Off (Volume On)

Acknowledgement

```
[e][ ][Set ID][ ][OK][Data][x]
```

Data 0 : Volume Mute On (Volume Off)
1 : Volume Mute Off (Volume On)

06. Volume Control(Command : f)

- ▶ To adjust Volume .

Transmission

```
[k][f][ ][Set ID][ ][Data][Cr]
```

Data Min : 00H ~ Max : 64H
(Hexadecimal code)

Acknowledgement

```
[f][ ][Set ID][ ][OK][Data][x]
```

Data Min : 00H ~ Max : 64H

Controlling the Multiple Monitors (RS-232C protocol)

● Transmission / Receiving Protocol

07. Contrast(Command : g)

- ▶ To adjust screen contrast.
You can also adjust the contrast in the Picture menu.

Transmission

[k][g][][Set ID][][Data][Cr]

Data Min : 00H ~ Max : 64H

- Refer to 'Real data mapping' as shown below.

Acknowledgement

[g][][Set ID][][OK][Data][x]

* Real data mapping

0 : Step 0
⋮
A : Step 10
⋮
F : Step 15
10 : Step 16
⋮
64 : Step 100

08. Brightness(Command : h)

- ▶ To adjust screen brightness.
You can also adjust the brightness in the Picture menu.

Transmission

[k][h][][Set ID][][Data][Cr]

Data Min : 00H ~ Max : 64H

- Refer to 'Real data mapping' as shown below.

Acknowledgement

[h][][Set ID][][OK][Data][x]

* Real data mapping

0 : Step
⋮
A : Step 10
⋮
F : Step 15
10 : Step 16
⋮
64 : Step 100

● Transmission / Receiving Protocol

09. Color(Command : i) (TV, AV only)

- ▶ To adjust the screen color.
You can also adjust the color in the Picture menu.

Transmission

[k][i][][Set ID][][Data][Cr]

Data Min : 00H ~ Max : 64H
(Hexadecimal code)

Acknowledgement

[i][][Set ID][][OK][Data][x]

Data Min : 00H ~ Max : 64H

10. Tint(Command : j) (TV, AV-NTSC only)

- ▶ To adjust the screen tint.
You can also adjust the tint in the Picture menu.

Transmission

[k][j][][Set ID][][Data][Cr]

Data Red: 00H ~ Green: 64H
(Hexadecimal code)

Acknowledgement

[j][][Set ID][][OK][Data][x]

Data Red: 00H ~ Green: 64H

* Tint : -50 ~ +50

11. Sharpness(Command : k) (TV, AV only)

- ▶ To adjust the screen Sharpness.
You can also adjust the sharpness in the Picture menu.

Transmission

[k][k][][Set ID][][Data][Cr]

Data Min : 00H ~ Max : 64H
(Hexadecimal code)

Acknowledgement

[k][][Set ID][][OK][Data][x]

Data Min : 00H ~ Max : 64H

Controlling the Multiple Monitors (RS-232C protocol)

● Transmission / Receiving Protocol

12. OSD Select (Command : l)

▶ To control OSD on/off to the set.

Transmission

```
[k][l][ ][Set ID][ ][Data][Cr]
```

Data 0 : OSD Off 1 : OSD On

Acknowledgement

```
[l][ ][Set ID][ ][OK][Data][x]
```

Data 0 : OSD Off 1 : OSD On

13. Remote Lock On/Off(Command : m)

▶ To control Remote Lock on/off to the set.

Transmission

```
[k][m][ ][Set ID][ ][Data][Cr]
```

Data 0 : Remote Lock Off 1 : Remote Lock On

Acknowledgement

```
[m][ ][Set ID][ ][OK][Data][x]
```

Data 0 : Remote Lock Off 1 : Remote Lock On

14. PIP/PBP/POP On/Off(Command : n)

▶ To control PIP/PBP/POP On/Off of the Set.

Transmission

```
[k][n][ ][Set ID][ ][Data][Cr]
```

Data 0 : OFF

1 : PIP

2 : PBP

3 : POP

Acknowledgement

```
[n][ ][Set ID][ ][OK][Data][x]
```

Data 0 : OFF

1 : PIP

2 : PBP

3 : POP

● Transmission / Receiving Protocol

15. PIP Position(Command : q)

▶ To adjust PIP position.

Transmission

```
[k][q][ ][Set ID][ ][Data][Cr]
```

Data 0 : Bottom of the right side on screen

1 : Bottom of the left side on screen

2 : Top of the left side on screen

3 : Top of the right side on screen

Acknowledgement

```
[q][ ][Set ID][ ][OK][Data][x]
```

Data 0 : Bottom of the right side on screen

1 : Bottom of the left side on screen

2 : Top of the left side on screen

3 : Top of the right side on screen

16. Balance(Command : t)

▶ To adjust the sound Balance.

Transmission

```
[k][t][ ][Set ID][ ][Data][Cr]
```

Data Min : 00H ~ Max : 64H

(Hexadecimal code)

Acknowledgement

```
[t][ ][Set ID][ ][OK][Data][x]
```

Data Min : 00H ~ Max : 64H

* Balance : -50 ~ +50

Controlling the Multiple Monitors (RS-232C protocol)

● Transmission / Receiving Protocol

17. ACC(Command : u)

▶ To adjust the screen color temperature.

Transmission

[k][u][][Set ID][][Data][Cr]

Data 0 : Normal (9300K) 2 : Warm (6500K)
 1 : Cool 3 : User
 PC : 0, 2, 3 AV : 0, 1, 2

Acknowledgement

[u][][Set ID][][OK][Data][X]

Data 0 : Normal (9300K) 2 : Warm (6500K)
 1 : Cool 3 : User
 PC : 0, 2, 3 AV : 0, 1, 2

18. PIP/PBP/POP SOURCE(Command : y)

▶ To select the sub-screen source.

Transmission

[k][y][][Set ID][][Data][Cr]

Data 0 : TV 5 : AV2
 2 : AV1 6 : RGB PC
 3 : S-Video 8 : DVI PC
 4 : Component

Acknowledgement

[y][][Set ID][][OK][Data][X]

Data 0 : TV 5 : AV2
 2 : AV1 6 : RGB PC
 3 : S-Video 8 : DVI PC
 4 : Component

19. Auto Configure(Command : j u)

▶ To adjust picture position and minimize image shaking automatically. it works only in RGB(PC) mode.

Transmission

[j][u][][Set ID][][Data][Cr]

Data 1 : To Set

Acknowledgement

[u][][Set ID][][OK][Data][X]

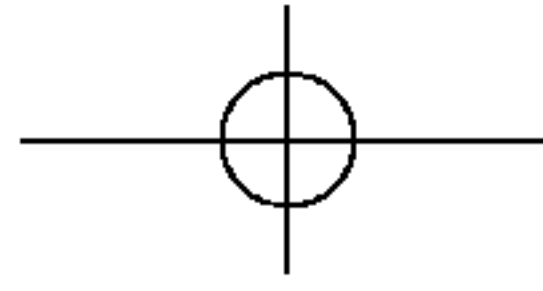

● Transmission / Receiving Protocol

20. Tune command(Command : m a)

▶ Tune channel to following physical number.

Transmission

[m][a][][Set ID][][Data][][Cr]

Data 1 : Channel Number

Acknowledgement

[a][][Set ID][][OK][Data][X]

Data 1 : Channel Number

21.Key(Command : m c)

▶ To send IR remote key code.

Transmission

[m][c][][Set ID][][Data][Cr]

Data Key code : Refer to page 48.

Acknowledgement

[c][][Set ID][][OK][Data][X]

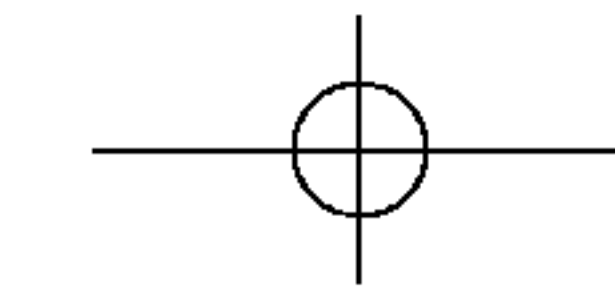

IR Codes

How to connect

- ▶ Connect your wired remote control to Remote Control port on the Monitor.

Remote Control IR Codes

- ▶ Output waveform
single pulse, modulated with 37.917KHz signal at 455KHz

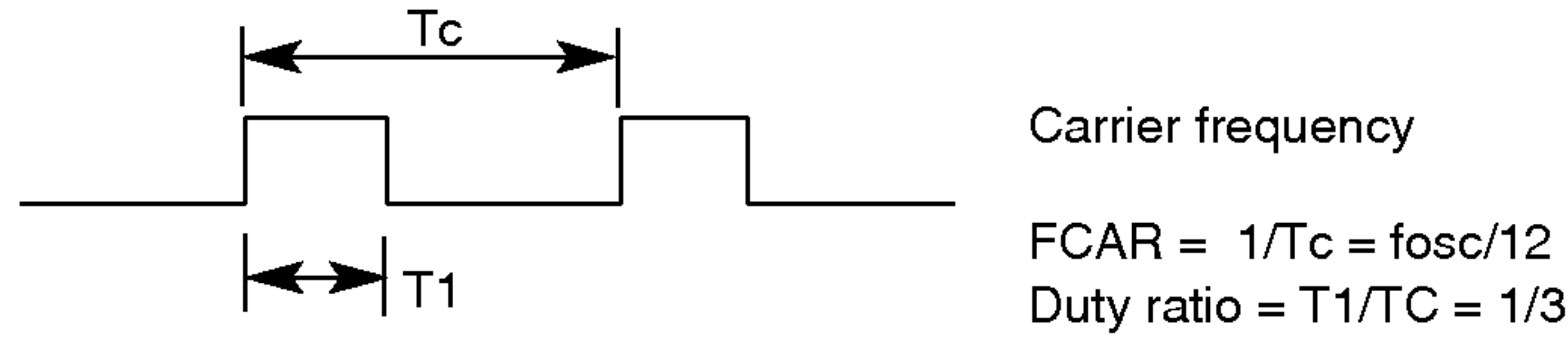

- ▶ Configuration of frame

- 1st frame

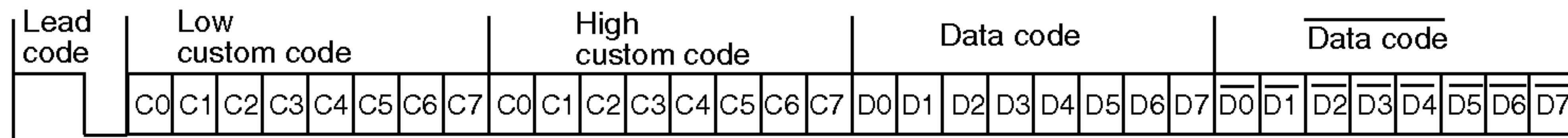

- Repeat frame

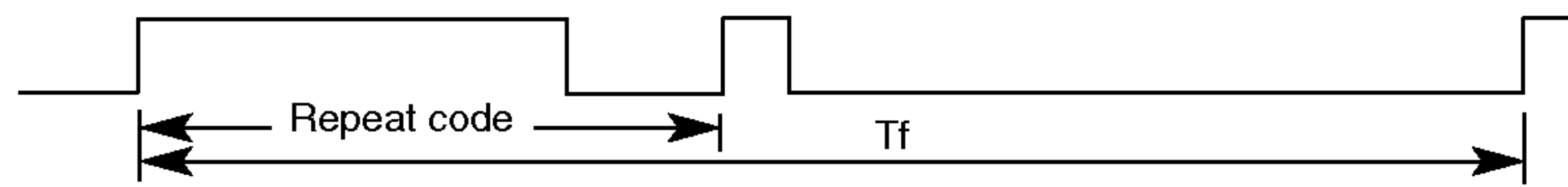

- Lead code

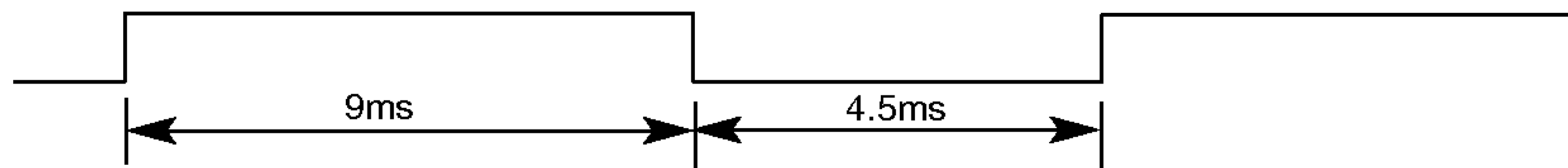

- Repeat code

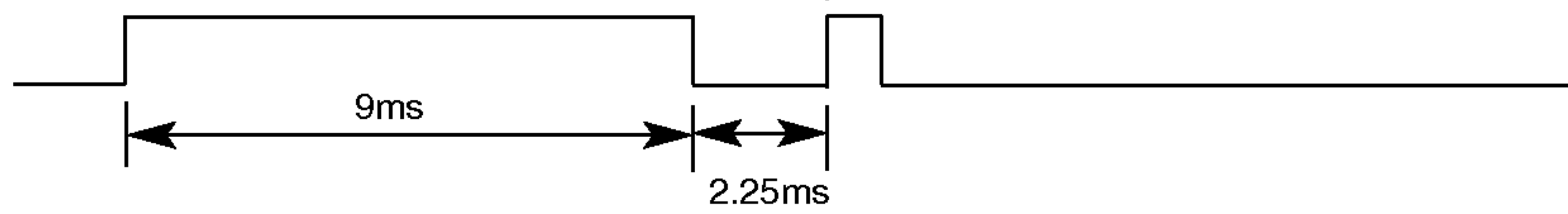

- ▶ Bit description

- Bit "0"

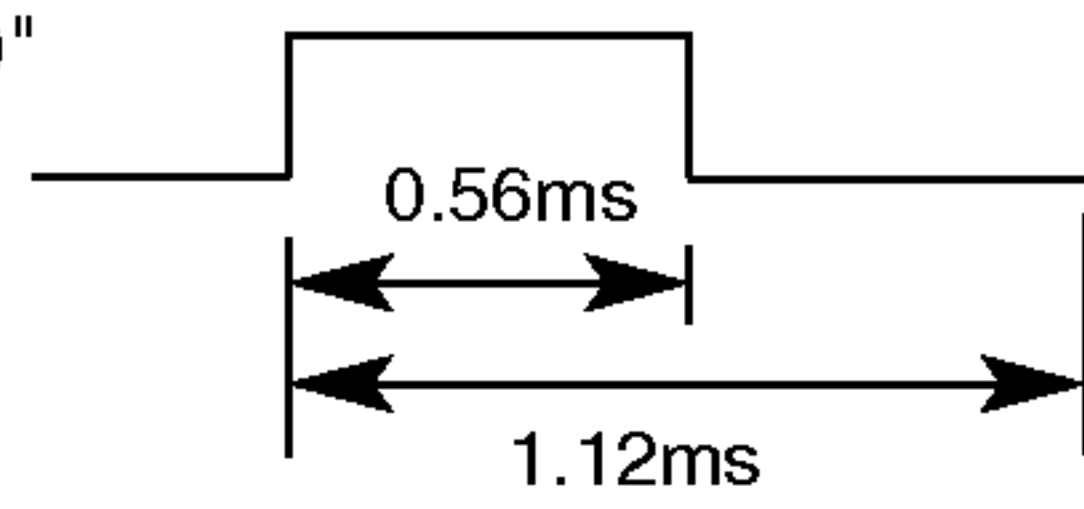

- Bit "1"

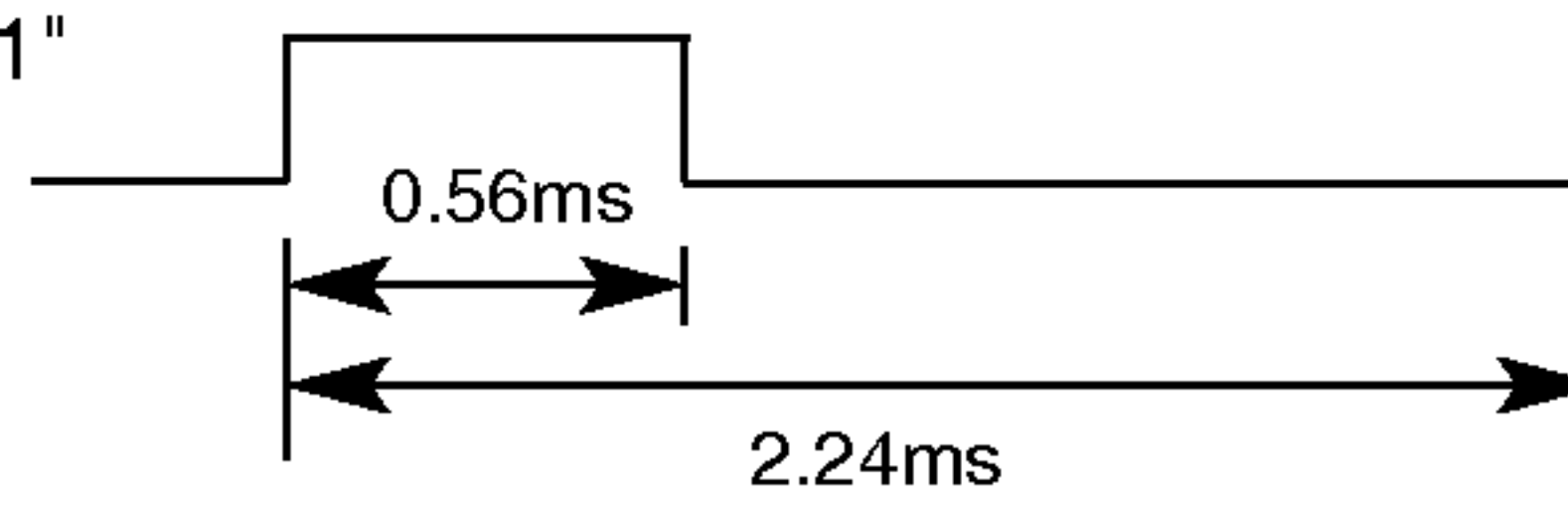

- ▶ Frame interval : Tf

- The waveform is transmitted as long as a key is depressed.

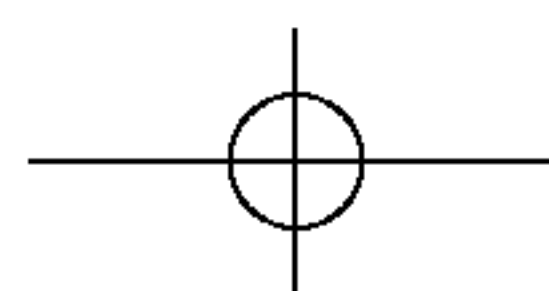
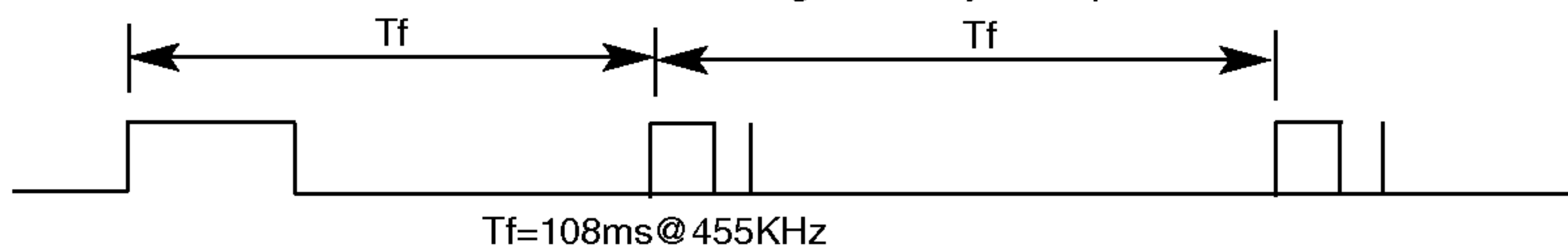

Code(Hexa)	Function	Note
00	PR(▲)	R/C Button
01	PR(▼)	R/C Button
02	VOL(▶)	R/C Button
03	VOL(◀)	R/C Button
08	POWER ON/OFF	R/C Button(Power On/Off)
C4	POWER ON	Discrete IR Code(Only Power On)
C5	POWER OFF	Discrete IR Code(Only Power Off)
09	MUTE	R/C Button
10	Number Key 0	R/C Button
11	Number Key 1	R/C Button
12	Number Key 2	R/C Button
13	Number Key 3	R/C Button
14	Number Key 4	R/C Button
15	Number Key 5	R/C Button
16	Number Key 6	R/C Button
17	Number Key 7	R/C Button
18	Number Key 8	R/C Button
19	Number Key 9	R/C Button
0B	TV/AV	R/C Button
98	SOURCE	R/C Button
D6	TV	Discrete IR Code(Input TV Selection)
5A	AV1	Discrete IR Code(Input AV1 Selection)
D8	S-Video	Discrete IR Code(Input S-Video Selection)
BF	Component	Discrete IR Code(Input Component Selection)
D0	AV2	Discrete IR Code(Input AV2 Selection)
C6	DVI	Discrete IR Code(Input DVI Selection)
D5	RGB	Discrete IR Code(Input RGB Selection)
0E	SLEEP	R/C Button
43	MENU	R/C Button
44	OK	R/C Button
60	PIP	R/C Button
63	SWAP	R/C Button
79	ARC	R/C Button
76	ARC(4:3)	Discrete IR Code(Only 4:3 mode)
77	ARC(Full)	Discrete IR Code(Only Full mode)
AF	ARC(ZOOM)	Discrete IR Code(Only Zoom mode)
54	AUTO PROGRAM	R/C Button
39	CAPTION	R/C Button
99	AUTO CONFIG	Discrete IR Code

Troubleshooting

No image is displayed

- | | |
|---|--|
| <input type="checkbox"/> Is the monitor power cord connected? | <ul style="list-style-type: none"> • See if the power cord is properly connected to the outlet. |
| <input type="checkbox"/> Is the power indicator light on? | <ul style="list-style-type: none"> • See if the power switch is turned on. |
| <input type="checkbox"/> Power is on, power indicator is green but the screen appears extremely dark. | <ul style="list-style-type: none"> • Adjust brightness (☉) and contrast (●) again. |
| <input type="checkbox"/> Is the power indicator amber? | <ul style="list-style-type: none"> • If the monitor is in power saving mode, move the mouse or press any key. |
| <input type="checkbox"/> Does the 'Out of range' message appear? | <ul style="list-style-type: none"> • The signal from the PC (video card) is out of the vertical or horizontal frequency range of the monitor. Adjust the frequency range by referring to the Specifications in this manual.
 * Maximum resolution
 RGB PC : 1600 x 1200 @60Hz
 DVI PC : 1360 x 768 @60Hz |
| <input type="checkbox"/> Does the 'Check signal cable' message appear? | <ul style="list-style-type: none"> • The signal cable between PC and monitor is not connected. Check the signal cable. • Press the 'SOURCE' menu in the remote controller to check the input signal. |

'Unknown Monitor' message appears when the monitor is connected.

- | | |
|--|---|
| <input type="checkbox"/> Did you install the driver? | <ul style="list-style-type: none"> • Install the monitor driver, which is provided with the monitor, or download it from the web site. (http://www.lge.com) • See if the plug&play function is supported by referring to the video card user manual. |
|--|---|

'Controls locked' message appears.

- | | |
|---|---|
| <input type="checkbox"/> The 'Controls locked' message appears when pressing the Menu button. | <ul style="list-style-type: none"> • The control locking function prevents unintentional OSD setting change due to careless usage. To unlock the controls, simultaneously press the Menu button and ► button for 5 seconds. (You cannot set this function using the remote controller buttons. You can set this function in the monitor only.) |
|---|---|



Note

* **Vertical frequency:** To enable the user to watch the monitor display, screen image should be changed tens of times every second like a fluorescent lamp. The vertical frequency or refresh rate is the times of image display per second. The unit is Hz.

* **Horizontal frequency:** The horizontal interval is the time to display one vertical line. When 1 is divided by the horizontal interval, the number of horizontal lines displayed every second can be tabulated as the horizontal frequency. The unit is kHz.

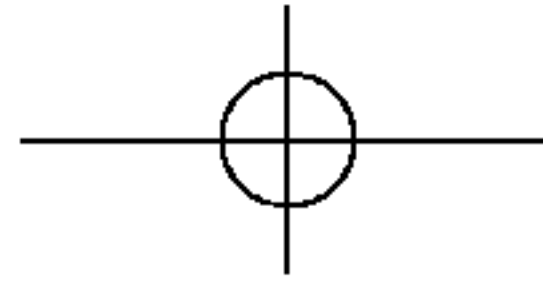

The screen image looks abnormal.

- | | |
|---|--|
| <p><input type="checkbox"/> Is the screen position wrong?</p> | <ul style="list-style-type: none"> • D-Sub analog signal – Press the “AUTO” button in the remote controller to automatically select the optimal screen status that fits into the current mode. If adjustment is not satisfactory, use the Position OSD menu. • See if the video card resolution and frequency are supported by the monitor. If the frequency is out of range, set to the recommended resolution in the Control Panel – Display – Setting menu. |
| <p><input type="checkbox"/> Do thin lines appear on the background screen?</p> | <ul style="list-style-type: none"> • D-Sub analog signal – Press the “AUTO” button in the remote controller to automatically select an optimal screen status that fits into the current mode. If adjustment is not satisfactory, use the Clock OSD menu. |
| <p><input type="checkbox"/> Horizontal noise appears or the characters look blurred.</p> | <ul style="list-style-type: none"> • D-Sub analog signal – Press the “AUTO” button in the remote controller to automatically select an optimal screen status that fits into the current mode. If adjustment is not satisfactory, use the Phase OSD menu. |
| <p><input type="checkbox"/> Unable to adjust the horizontal/vertical position in the Zoom menu.</p> | <ul style="list-style-type: none"> • See if the Zoom value is set to 0. If it is, you cannot adjust the H/V Position value. |
| <p><input type="checkbox"/> Screen size is automatically adjusted when connected to the PC.</p> | <ul style="list-style-type: none"> • If the screen size is not full when connected to the PC, execute the PIP/POP/PBP to change to full screen mode. |
| <p><input type="checkbox"/> Brightness differs in the main and sub screen when connected to the PC.</p> | <ul style="list-style-type: none"> • You cannot adjust brightness and tint in the PIP/POP/PBP Screen menu for the sub-screen among PIP/POP/PBP menus. Therefore, brightness can be different for the sub-screen. |
| <p><input type="checkbox"/> The screen is displayed abnormally.</p> | <ul style="list-style-type: none"> • The proper input signal is not connected to the signal port. Connect the signal cable that matches with the source input signal. |
| <p><input type="checkbox"/> No sound appears in the TV channel display window.</p> | <ul style="list-style-type: none"> • See if the TV sound is set to mono. If it is, the sound will not be displayed. |

ENGLISH

After-image appears on the monitor.

- | | |
|---|--|
| <p><input type="checkbox"/> After-image appears when the monitor is turned off.</p> | <ul style="list-style-type: none"> • If you use a fixed image for a long time, the pixels may be damaged quickly. Use the screensaver function. |
|---|--|

Troubleshooting

The audio function does not work.

- | | |
|--|--|
| <input type="checkbox"/> No sound? | <ul style="list-style-type: none"> • See if the audio cable is connected properly. • Adjust the volume. • See if the sound is set properly. |
| <input type="checkbox"/> No sound is available when the PIP/POP/PBP mode is engaged. | <ul style="list-style-type: none"> • See if the Sound is set to On in the PIP/POP/PBP menu. |
| <input type="checkbox"/> Sound is too dull. | <ul style="list-style-type: none"> • Select the appropriate equalize sound. |
| <input type="checkbox"/> Sound is too low. | <ul style="list-style-type: none"> • Adjust the volume. |

The TV function does not work.

- | | |
|---|--|
| <input type="checkbox"/> The TV signal is not being received. | <ul style="list-style-type: none"> • See if you have selected the proper channel mode. • Use the automatic channel setup function. • See if the TV antenna is properly connected. |
|---|--|

The screen size function in the OSD menu does not work.

- | | |
|--|--|
| <input type="checkbox"/> The screen size function in the OSD menu does not work. | <ul style="list-style-type: none"> • See if the PIP/POP/PBP function is in use. If the PIP/POP/PBP function is in use, the screen size function may not work. |
|--|--|

Screen color is abnormal.

- | | |
|--|---|
| <input type="checkbox"/> Screen has poor color resolution (16 colors). | <ul style="list-style-type: none"> • Set the number of colors to more than 24 bits (true color)
Select Control Panel – Display – Settings – Color Table menu in Windows. |
| <input type="checkbox"/> Screen color is unstable or mono-colored. | <ul style="list-style-type: none"> • Check the connection status of the signal cable.
Or, re-insert the PC video card. |
| <input type="checkbox"/> Do black spots appear on the screen? | <ul style="list-style-type: none"> • Several pixels (red, green, white or black color) may appear on the screen, which can be attributable to the unique characteristics of the LCD panel. It is not a malfunction of the LCD. |

Specifications

The product specifications can change without prior notice for product improvement.

ENGLISH

LCD Panel

[L3200T]	32 inches (80.04 cm) TFT (Thin Film Transistor) LCD (Liquid Crystal Display) Panel Visible diagonal size: 80.04 cm 0.5025 mm (Pixel Pitch)
[L3700T]	37 inches (94.03 cm) TFT (Thin Film Transistor) LCD (Liquid Crystal Display) Panel Visible diagonal size: 94.03 cm 0.6000 mm (Pixel Pitch)
[L4200T]	42 inches (106.68 cm) TFT (Thin Film Transistor) LCD (Liquid Crystal Display) Panel Anti-Glare coating Visible diagonal size: 106.68 cm 0.681 mm (Pixel Pitch)

Power

[L3200T]	Rated Voltage AC 100-240V~ 50/60Hz 2.0A Power Consumption On Mode : 160W Sleep Mode : ≤ 4W Off Mode : ≤ 2W
[L3700T]	Rated Voltage AC 100-240V~ 50/60Hz 2.4A Power Consumption On Mode : 220W Sleep Mode : ≤ 4W Off Mode : ≤ 3W
[L4200T]	Rated Voltage AC 100-240V~ 50/60Hz 2.8A Power Consumption On Mode : 300W Sleep Mode : ≤ 4W Off Mode : ≤ 3W

NOTE

- Information in this document is subject to change without notice.

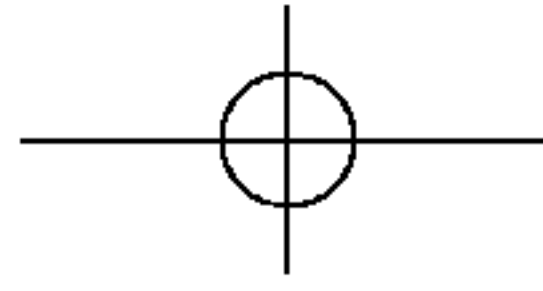

Specifications

The product specifications can change without prior notice for product improvement.

Dimensions & Weight

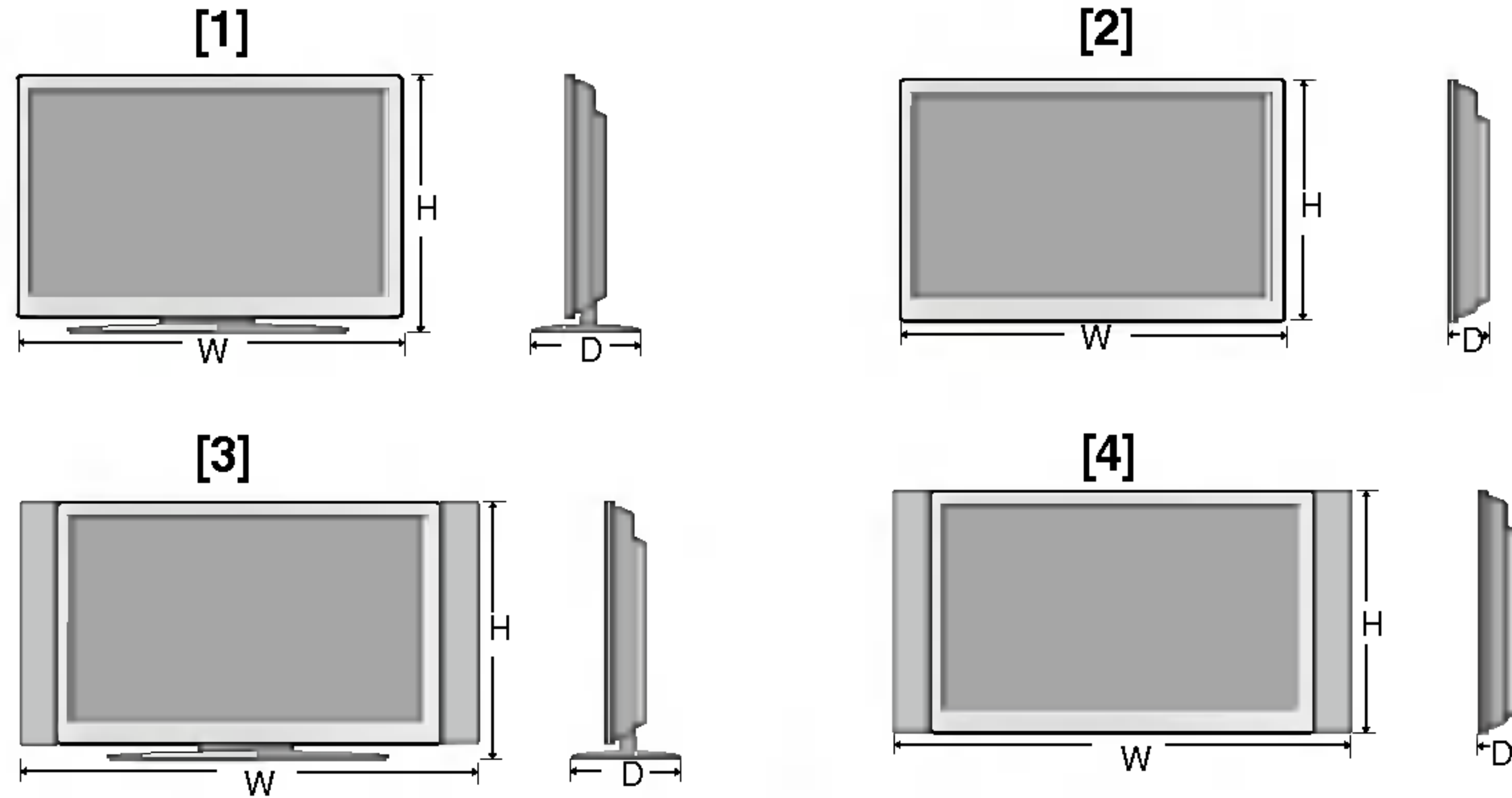

Width x Height x Depth

[L3200T]

[1] 80.30 cm (31.61 inches) x 54.00cm (21.26 inches) x 18.00 cm (7.09 inches)

[2] 80.30 cm (31.61 inches) x 49.30 cm (19.4 inches) x 9.99 cm (3.93 inches)

[3] 96.40 cm (37.95 inches) x 54.00cm (21.26 inches) x 18.00 cm (7.09 inches)

[4] 96.40 cm (37.95 inches) x 49.30 cm (19.4 inches) x 9.99 cm (3.93 inches)

[L3700T]

[1] 92.80 cm (36.54 inches) x 61.90 cm (24.37 inches) x 22.77 cm (8.96 inches)

[2] 92.80 cm (36.54 inches) x 57.12 cm (22.49 inches) x 12.00 cm (4.72 inches)

[3] 112.9 cm (44.45 inches) x 61.90 cm (24.37 inches) x 22.77 cm (8.96 inches)

[4] 112.9 cm (44.45 inches) x 57.12 cm (22.49 inches) x 12.00 cm (4.72 inches)

[L4200T]

[1] 105.7 cm (41.61 inches) x 70.20 cm (27.64 inches) x 29.45 cm (11.59 inches)

[2] 105.7 cm (41.61 inches) x 65.30 cm (25.71 inches) x 11.91 cm (4.69 inches)

[3] 125.9 cm (49.57 inches) x 70.20 cm (27.64 inches) x 29.45 cm (11.59 inches)

[4] 125.9 cm (49.57 inches) x 65.30 cm (25.71 inches) x 11.91 cm (4.69 inches)

Net

[L3200T]

[1] 19.4 kg (42.77 lbs)

[2] 16.0 kg (35.27 lbs)

[3] 21.1 kg (46.52 lbs)

[4] 17.7 kg (39.02 lbs)

[L3700T]

[1] 31.1 kg (68.56 lbs)

[2] 29.0 kg (63.93 lbs)

[3] 39.1 kg (86.20 lbs)

[4] 35.1 kg (77.38 lbs)

[L4200T]

[1] 41.4 kg (91.27 lbs)

[2] 37.0 kg (81.57 lbs)

[3] 44.0 kg (97.00 lbs)

[4] 39.6 kg (87.30 lbs)

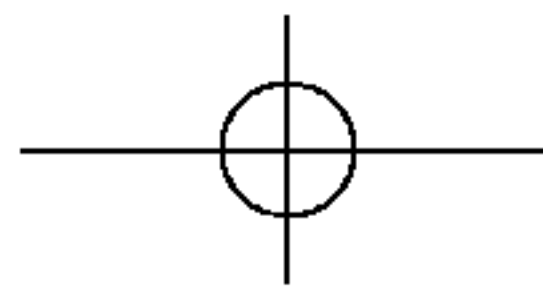

The product specifications can change without prior notice for product improvement.

ENGLISH

Video Signal	Max. Resolution	RGB PC : 1600 X 1200 @60Hz DVI PC : 1360 X 768 @60Hz – It may not be supported depending on the OS or video card type.
	Recommended Resolution	RGB PC : WXGA 1360 X 768 @60Hz DVI PC : WXGA 1360 X 768 @60Hz – It may not be supported depending on the OS or video card type.
	Horizontal Frequency	RGB PC : 30 - 83 kHz DVI PC : 30 - 72 kHz
	Vertical Frequency	56 - 85 Hz
	Synchronization Type	Separate/Composite/SOG (Sync On Green)/Digital
Input Connector	15-pin D-sub type, DVI-D (digital), S-Video, Composite Video, HDTV, DVD	
Environmental Conditions	Operational Condition	Temperature: 10°C ~ 35°C , Humidity: 10% ~ 80%
	Storage Condition	Temperature: -20°C ~ 60°C , Humidity: 5% ~ 95%

* Applicable only for models that support the speakers

Audio	RMS Audio Output	10W+10W(R+L)
	Input Sensitivity	0.7Vrms
	Speaker Impedance	8Ω

NOTE

- Information in this document is subject to change without notice.

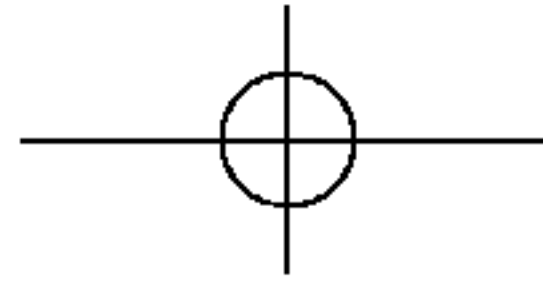

Specifications

● PC Mode – Preset Mode

Preset mode			Horizontal Frequency (kHz)	Vertical Frequency (Hz)	Preset mode			Horizontal Frequency (kHz)	Vertical Frequency (Hz)
1	VGA	640 x 350	31.469	70	11	VESA	1024 x 768	60.123	75
2	VGA	720 x 400	31.468	70	12	VESA	1024 x 768	68.68	85
3	VGA	640 x 480	31.469	60	13	VESA	1280 x 720	44.772	60
4	VESA	640 x 480	37.500	75	14	VESA	1360 x 768	47.72	60
5	VESA	640 x 480	43.269	85	15	VESA	1280 x 1024	63.981	60
6	VESA	800 x 600	37.879	60	16	VESA	1280 x 1024	79.98	75
7	VESA	800 x 600	46.875	75	17	VESA	1600 x 1200	75.00	60
8	VESA	800 x 600	53.674	85	RGB PC : Mode 1 ~ Mode 17 DVI PC : Mode 1 ~ Mode 15				
9	MAC	832 x 624	49.725	75					
10	VESA	1024 x 768	48.363	60					

● Power Indicator

Mode	Monitor
On Mode	Green
Sleep Mode	Amber
Off Mode	-

VESA wall mounting

Connected to another object (stand type and wall-mounted type.) This monitor accepts a VESA-compliant mounting interface pad.- **(optional)**
 For further information, refer to the VESA Wall Mounting Instruction Guide.

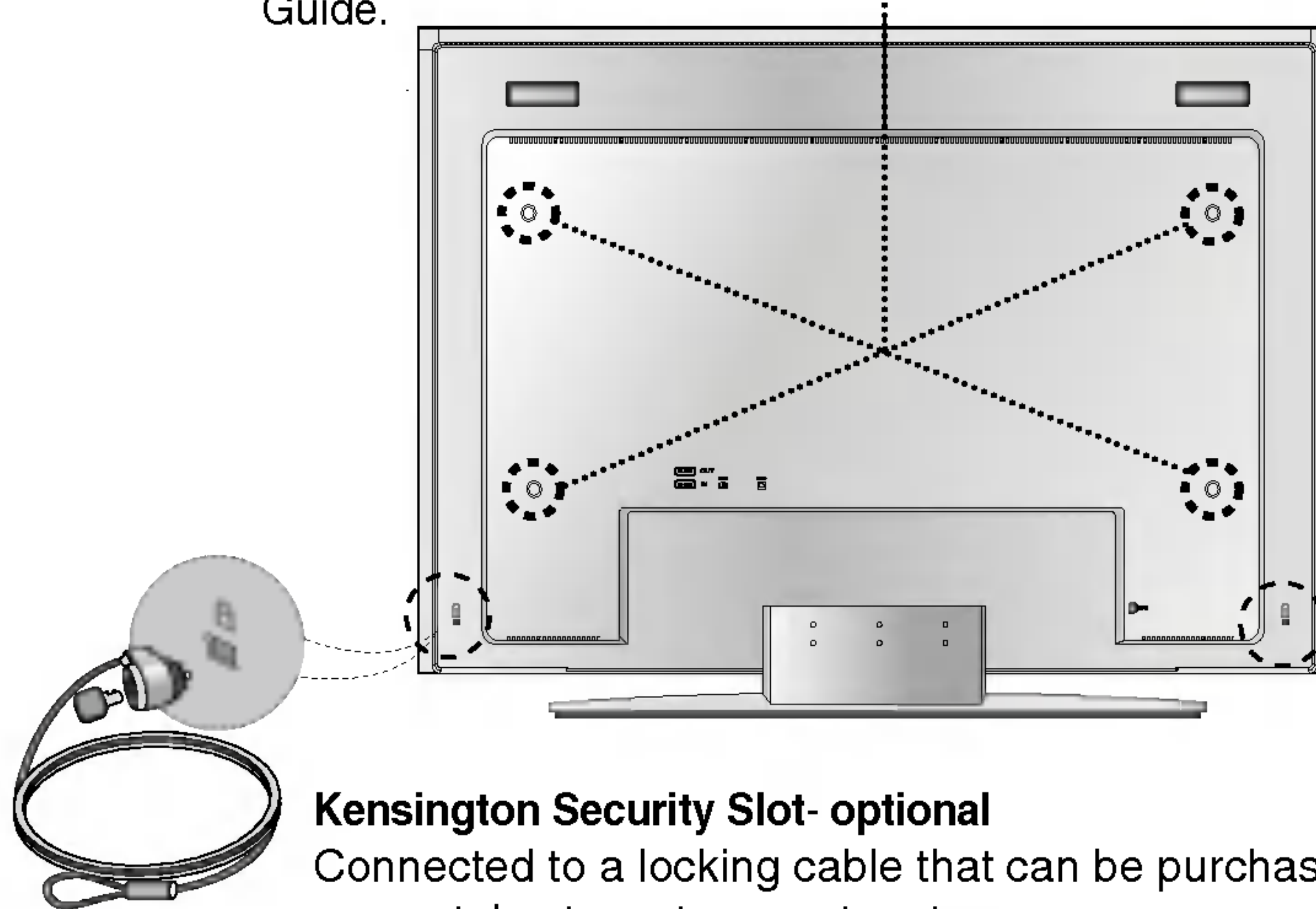

Kensington Security Slot- optional

Connected to a locking cable that can be purchased separately at most computer stores