



LCD TV

OWNER'S MANUAL

MODEL: 26LZ5RV



Please read **Information Manual** included together before reading this manual and operating your set.

Retain it for future reference.

Record model number and serial number of the set.

See the label attached on the back cover and quote

this information to your dealer when you require service.

P/NO : 3828TUL266F(0505-REV00)
Printed in Korea

Accessories

Ensure that the following accessories are included with your TV. If any accessory is missing, please contact the dealer from where you purchased the product.

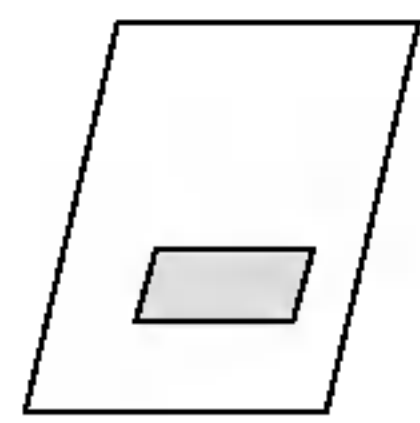

Owner's Manual

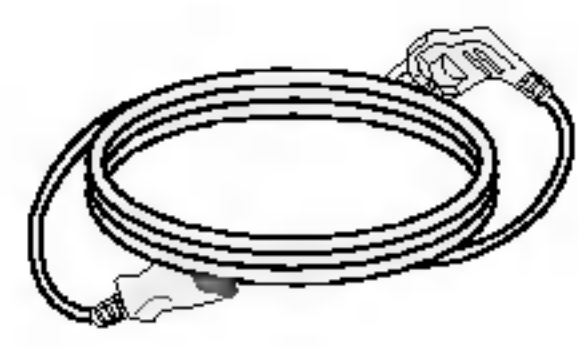

Power Cord

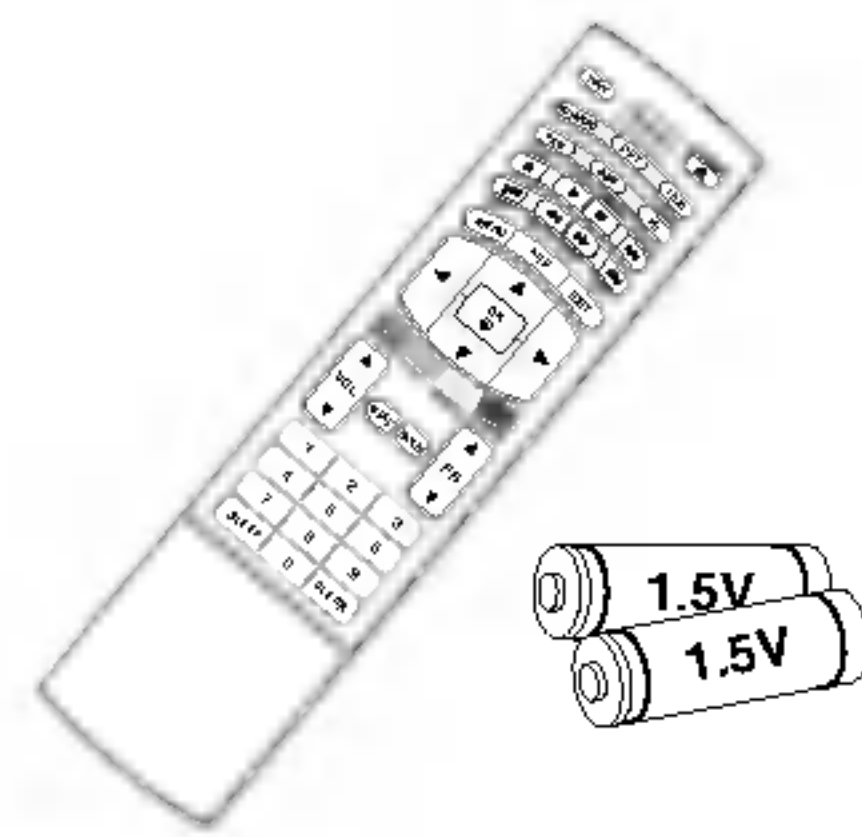

Remote Control / Batteries

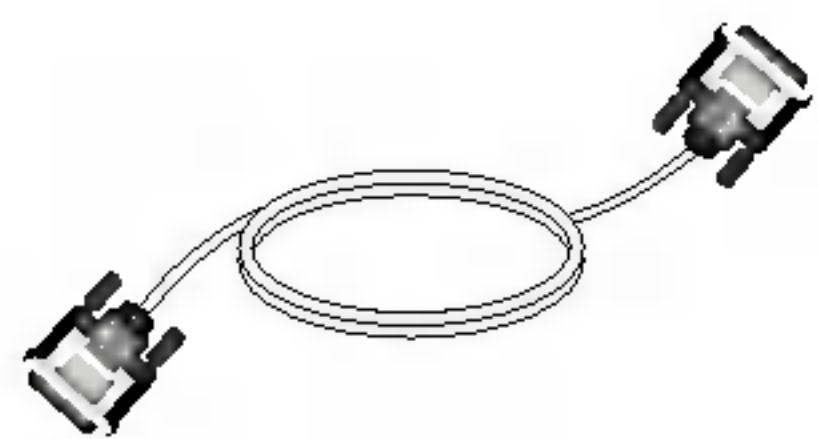

DVI-D cable (PC)

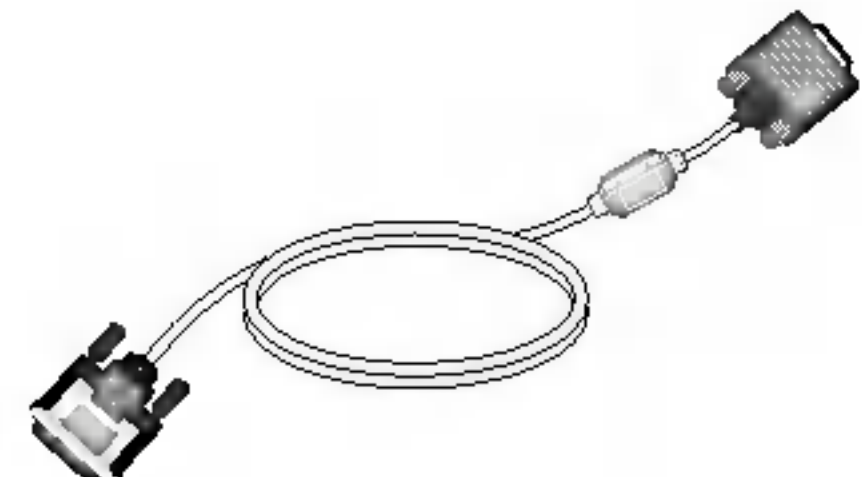

DVI to D-Sub cable (PC)

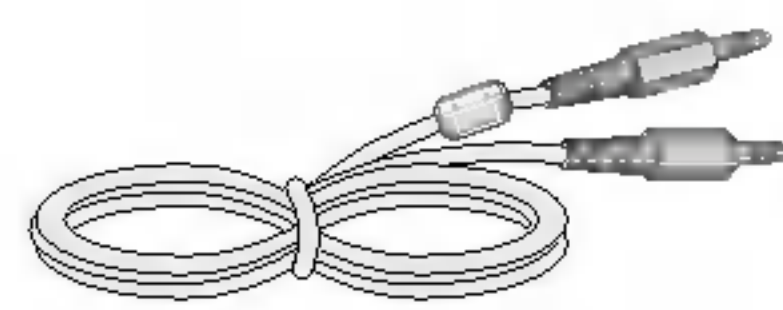

Audio cable (PC)



Twister Holder

Contents

Introduction

- 2 Accessories
- 5 **Controls**
- 6 **Connection Options**
- 7 **Remote Control**

Installation

- 10 **Basic Connection**
- 11 **External Equipment Connections**
 - 11 Antenna Connection
 - 12 VCR Setup
 - 13 External AV Source Setup
 - 14 External DVD Setup
 - 15 DVD Output Setup
 - 16 PC Setup
 - 17 Power Cord Connection

Operation

Basic operation

- 18 **TV**
- 18 Turning On/Off the TV
- 18 Volume Adjustment
- 18 Programme selection
- 18 On screen language selection
- 19 How to adjust the OSD screen

Setting up TV stations

- 20 Auto programme tuning
- 21 Manual programme tuning
- 22 Assigning a station name
- 23 Programme edit
- 24 Favourite programme
- 24 Calling the programme table

Picture adjustment

- 25 PSM (Picture Status Memory)
- 25 Manual Picture adjustment
- 26 Picture format (ARC)

Sound adjustment

- 27 SSM (Sound Status Memory)
- 27 Equalizer Adjustments
- 28 AVL (Auto Volume Leveler)
- 28 Sound Balance
- 29 **///**

Time menu

- 30 Time
- 30 On/Off Time
- 31 Auto off
- 31 Sleep timer

Setup menu

- 32 Input source
- 32 Auto AV switching
- 33 Child lock

PC menu

- 34 Auto Configure
- 34 H-Position / V-Position
- 35 Clock / Phase
- 35 Reset

Contents

Operation	Teletext	36	Switch on/off	
		36	SIMPLE text	
		36	TOP text (option)	
		37	FASTEXT	
		37	Special teletext functions	
			
		DVD		
		38 Notes on Discs		
		40 Language		
		40	Menu Language	
	40	Disc Audio / Disc Subtitle / Disc Menu		
	41 Display			
	41	Progressive Scan		
	42 Audio			
	42	Dolby Digital / DTS / MPEG		
	42	Sample Freq. (Frequency)		
	43	DRC (Dynamic Range Control)		
	43	Vocal		
	44 Lock			
	44	Rating		
	45	Password (Security Code)		
	45	Area Code		
	46 OTHERS			
	46	PBC		
	46	AUTO PLAY		
	47	DivX(R) VOD		
.....				
	48 Playing a DVD or Video CD			
	48	Basic Playback / Stop Playback / Pause Playback (Still mode)		
	48	Still Picture and Frame-by-Frame Playback / Fast Forward/Backward		
	49	Slow Motion		
	49	Moving to another CHAPTER/TRACK		
	49	Repeat Playback		
	50	Disc Menu / Title Menu		
	51	On-Screen Display		
	52	A-B Repeat Playback / Random Playback / Camera Angle		
	53	Subtitles / Marker Search / Zoom		
	54 Playing an Audio CD or MP3/WMA Disc			
	54	Pause Playback (Still mode)		
	54	Fast Forward/Backward		
	54	Moving to another Track		
	55	Repeat Playback / A-B Repeat Playback / Random Playback / 3D Surround		
	56 Programmed Playback			
	57 Viewing a JPEG Disc			
	58 Viewing a DVD VR format Disc			
	59 Playing a DivX Movie Disc			
.....				
Reference	60 Troubleshooting Checklist			
	62 Language Codes			
	62 Area Codes			
	63 IR Codes			
	65 External Control Device Setup ; RS-232C			

Introduction

Controls

- This is a simplified representation of front panel.
- Here shown may be somewhat different from your TV.

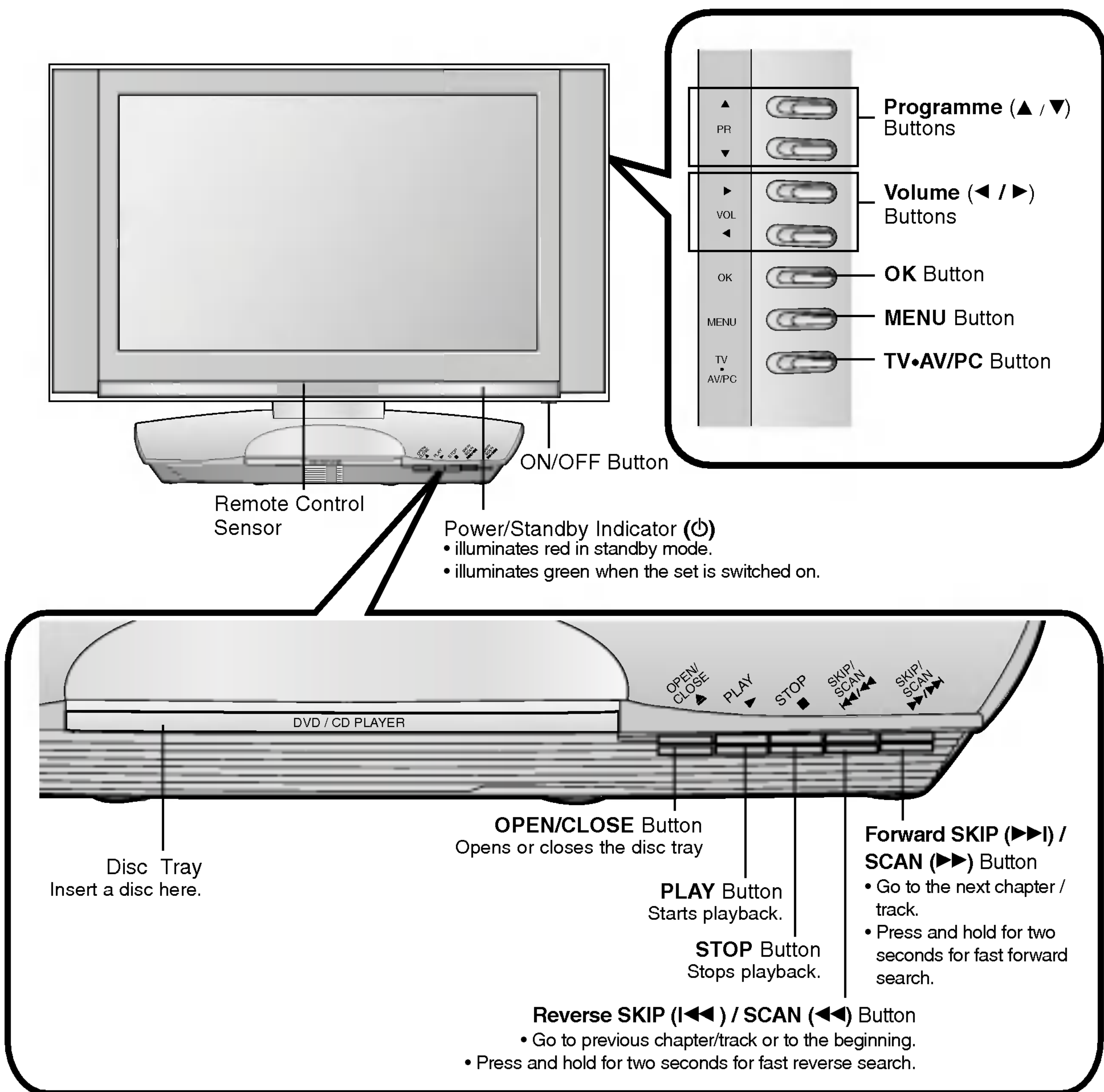

Introduction

Connection Options

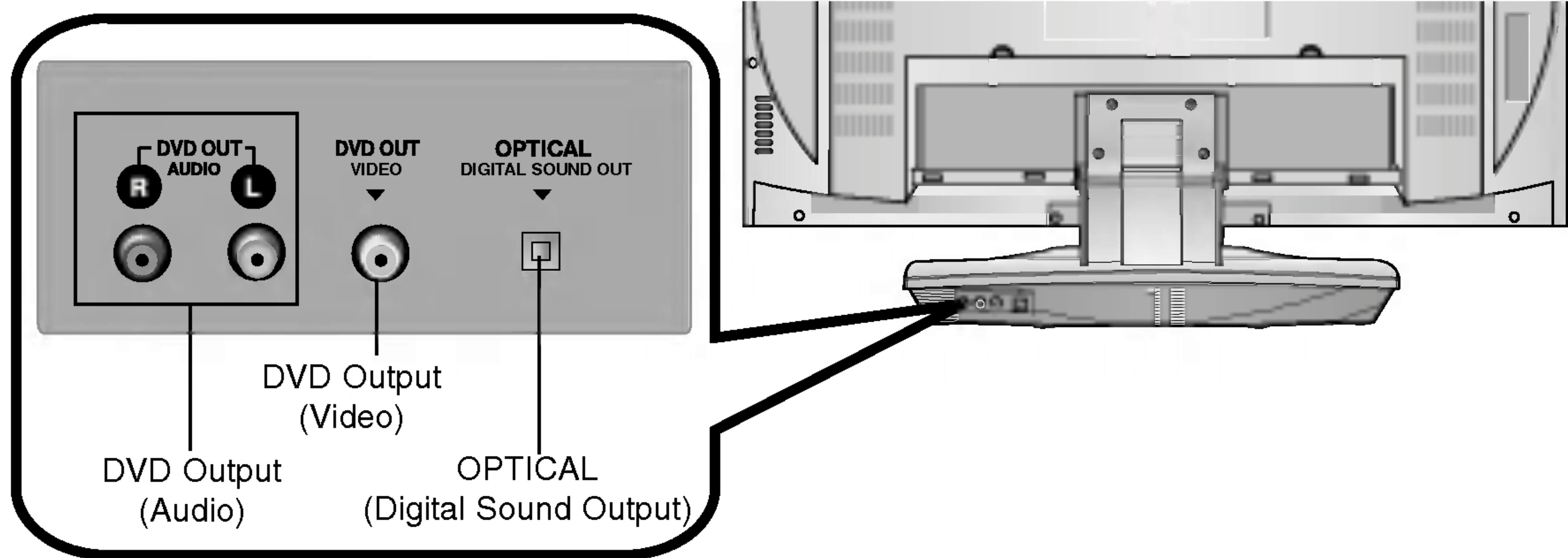
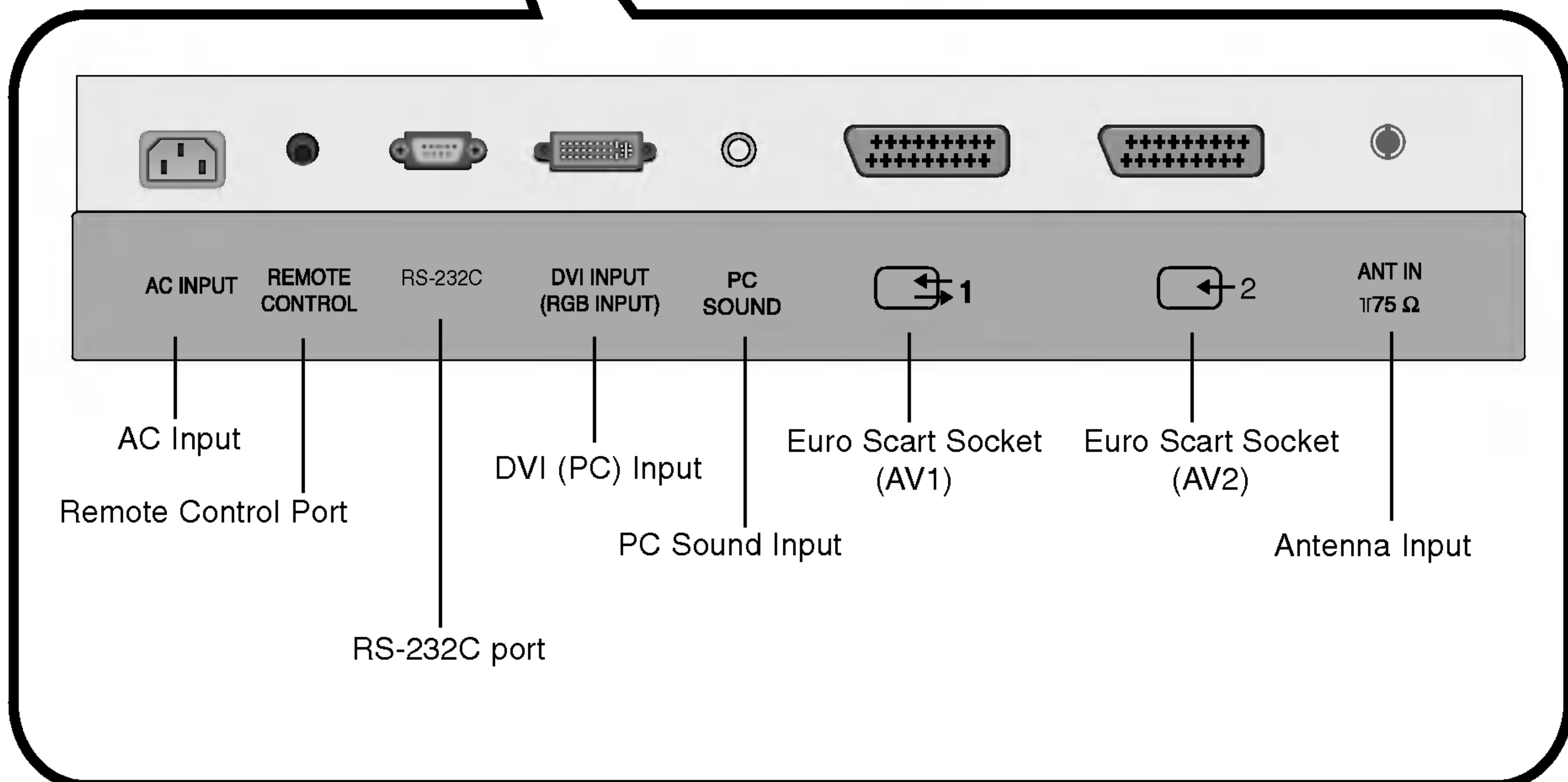
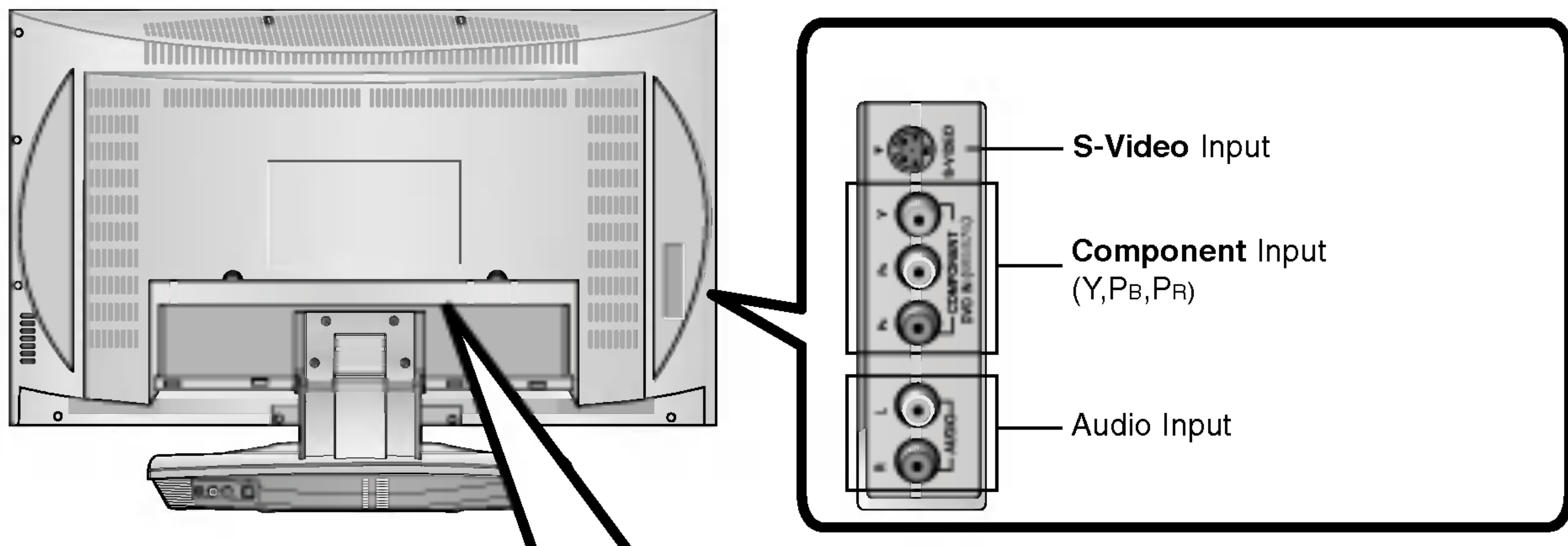

Remote Control

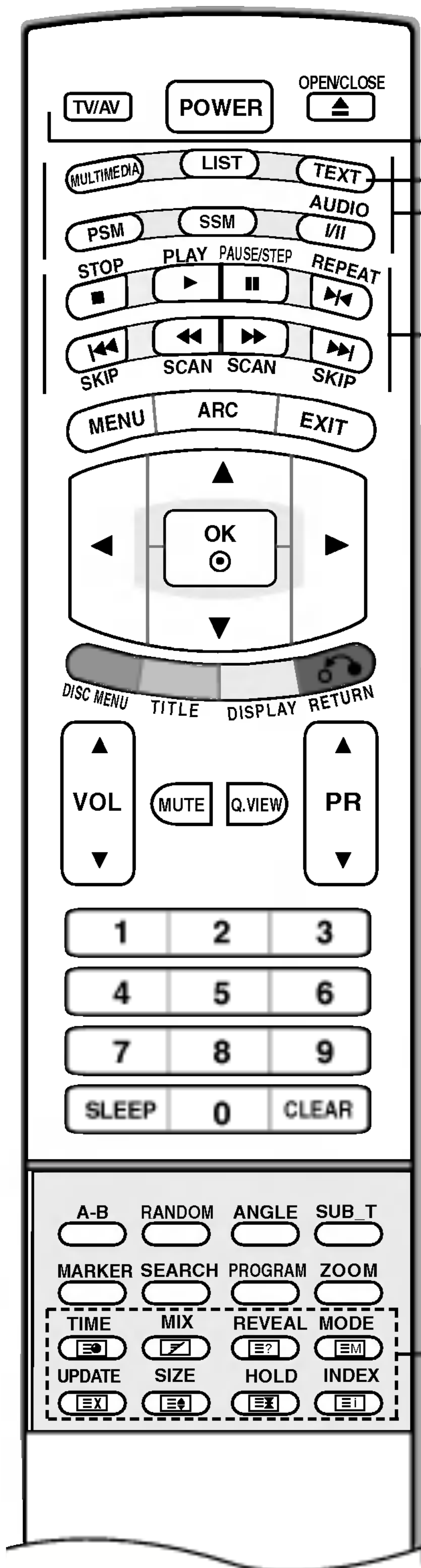

POWER

Switches the set **On** from standby or **Off** to standby.

TV/AV

- Selects: **TV**, **AV1**, **AV2**, **S-video**, **DVD**, **Component**, or **PC** mode.
- Clears the menu from the screen.
- Switches the set **On** from standby.

OPEN/CLOSE

Opens or closes the disc tray.

MULTIMEDIA

- Selects: **TV**, **DVD**, **Component**, or **PC** mode.
- Clears the menu from the screen.
- Switches the set **On** from standby.

LIST

Displays the programme table.

1 TELETEXT buttons

These buttons are used for teletext. For further details, see the 'Teletext' section. (Refer to p.36)

PSM (Picture Status Memory)

Recalls your preferred picture setting. (Refer to p.25)

SSM (Sound Status Memory)

Recalls your preferred sound setting. (Refer to p.27)

I/AUDIO

- Selects the sound output.
- Changes the AUDIO status during DVD playback.

DVD buttons

■ STOP

Stops playback.

▶ PLAY

Starts playback.

|| PAUSE / STEP

Pauses playback temporarily.

◀◀ SCAN / ▶▶ SCAN

Search backward or forward.

I◀◀ SKIP

Returns to beginning of current chapter/track or go to previous chapter/track.

▶▶I SKIP

Go to next chapter or track.

▶I◀ REPEAT

For further details, see the 'DVD Operation' section. (Refer to p.48)

Introduction

Remote Control

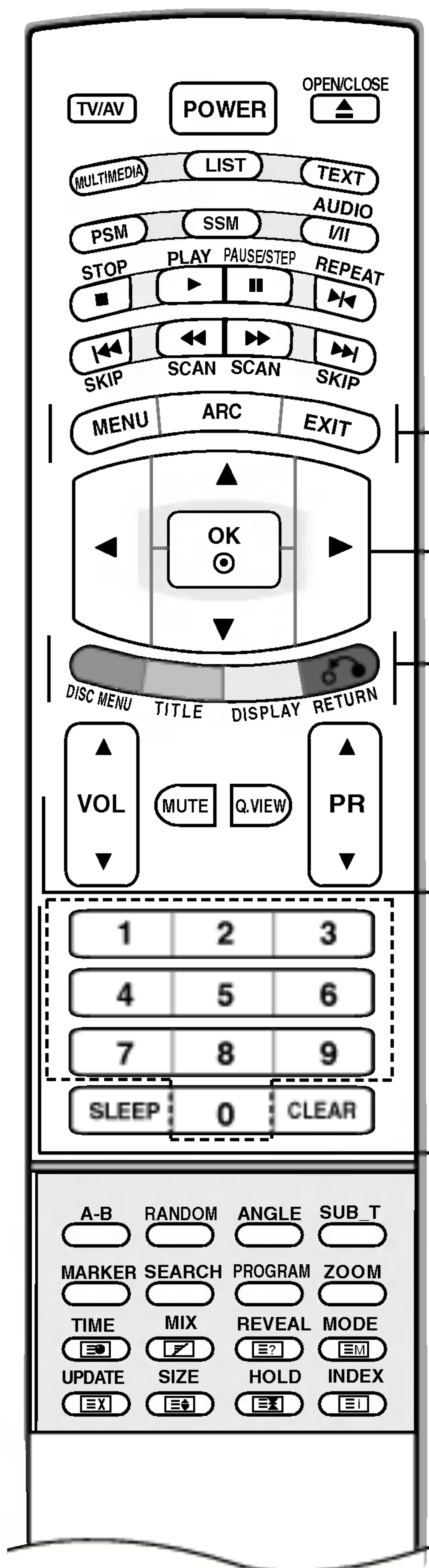

MENU
Selects a menu.

ARC
Selects your desired picture format. (Refer to p.26)

EXIT
Exits from each mode.

▲ / ▼ / ◀ / ▶ (up / down / left / right)
Selects or adjusts an item in the menu.

OK
Accepts your selection or displays the current mode.

DISC MENU
Accesses menu on a DVD disc. (Refer to p.50)

TITLE
Displays title menu, if available. (Refer to p.50)

DISPLAY
Accesses On-Screen display during DVD playback. (Refer to p.51)

RETURN

- Returns to playback.
- Hides information of file while viewing a JPEG file. (Refer to p.57)

★COLOURED BUTTONS : These buttons are used for teletext (only **TELETEXT** models) or **Programme edit**.

VOL (Volume) ▲ / ▼
Adjusts the volume.

MUTE
Switches the sound **On** or **Off**.

Q.VIEW

- Returns to the previously viewed programme.
- Selects a favourite programme. (Refer to p.24)

PR (Programme) ▲ / ▼
Selects a programme.

0-9 number buttons

- Selects a programme.
- Selects numbered items in a menu.

SLEEP
Sets the sleep timer. (Refer to p.31)

CLEAR
Removes a track number on the **program** list or a mark on the **MARKER SEARCH** menu. (Refer to p.53)

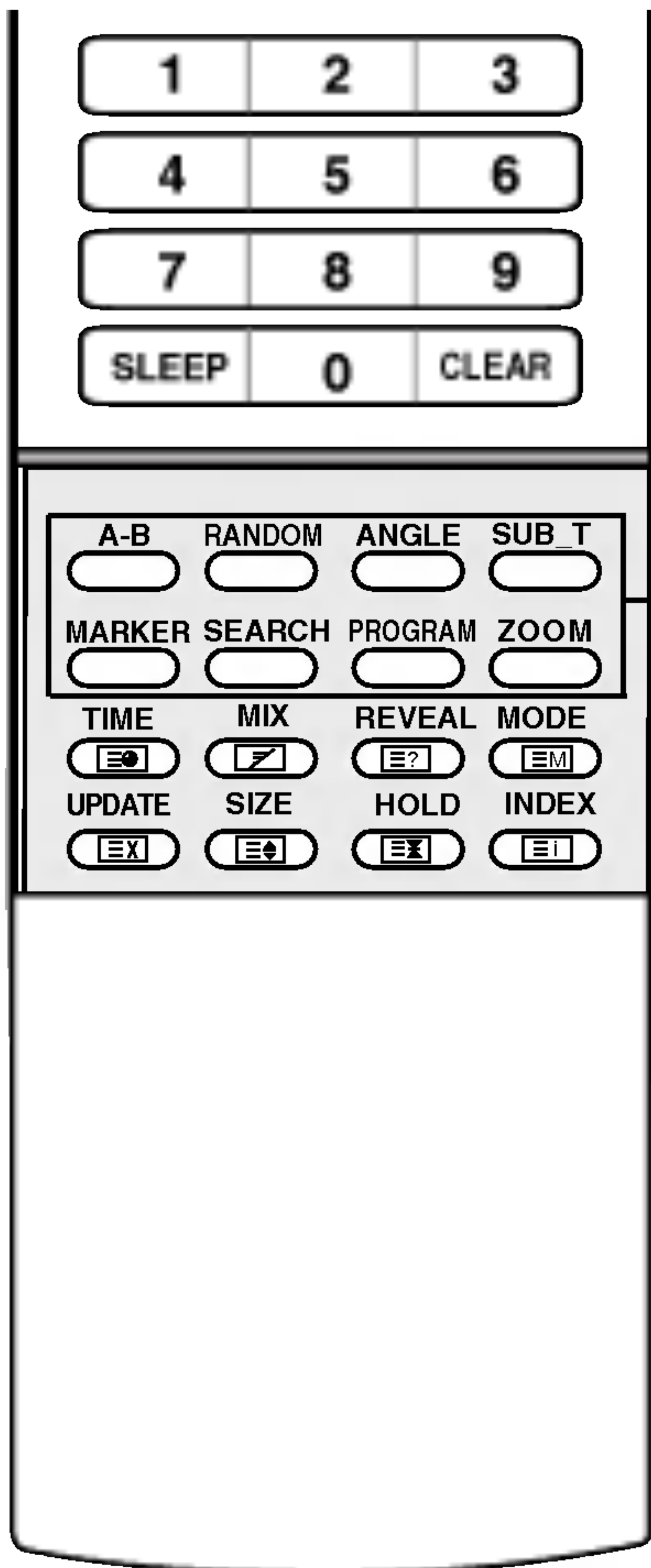

- A-B**
Repeat sequence. (Refer to p.52)
- RANDOM**
Plays chapters or tracks in random order. (Refer to p.52)
- ANGLE**
Selects a DVD camera angle if available. (Refer to p.52)
- SUB_T (SUBTITLE)**
Selects a subtitle language. (Refer to p.53)
- MARKER**
Marks any point during playback. (Refer to p.53)
- SEARCH**
Displays MARKER SEARCH menu. (Refer to p.53)
- PROGRAM**
Places a track on the program list. (Refer to p.56)
- ZOOM**
Changes the picture size during DVD playback. (Refer to p.53)

Installing Batteries

1 Open the battery compartment cover on the back side.

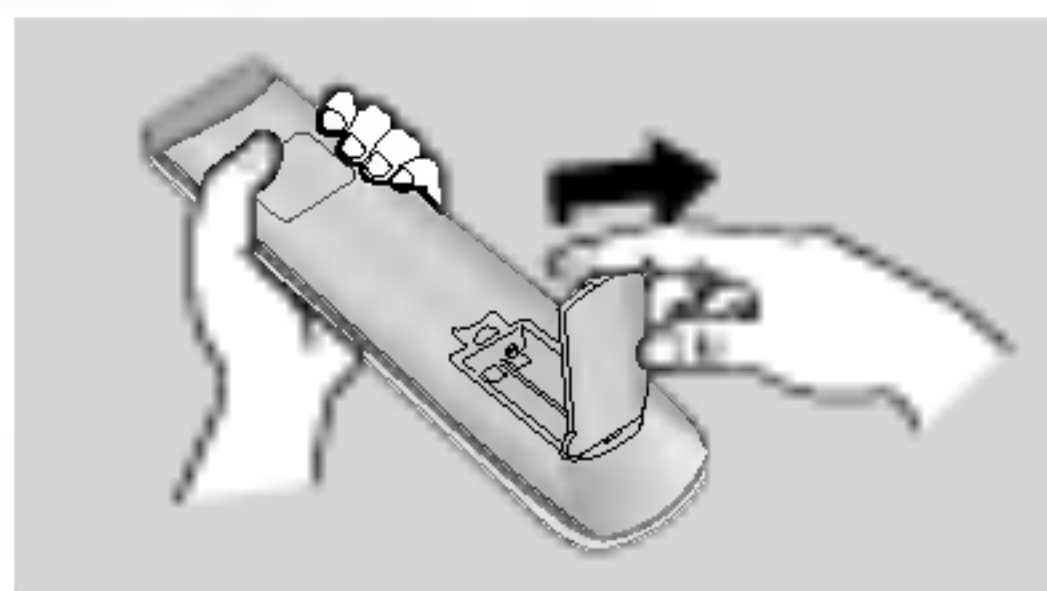

2 Insert two 1.5V AA size batteries in correct polarity (+ with +, - with -). Don't mix old or used batteries with new ones.

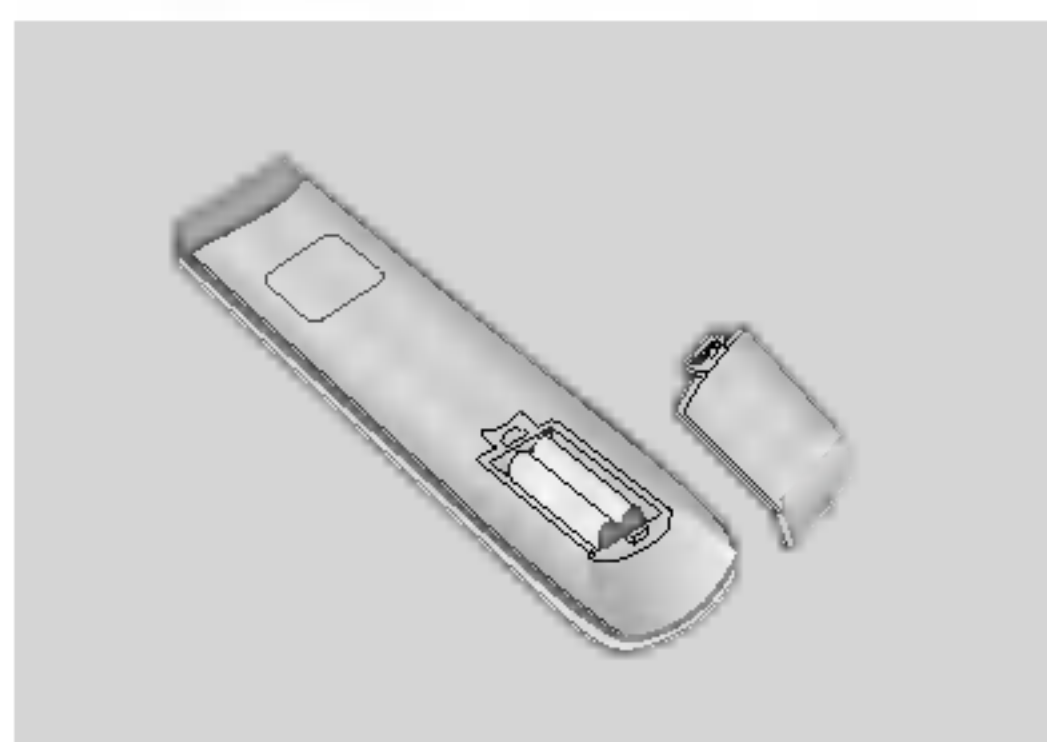

3 Close the cover.

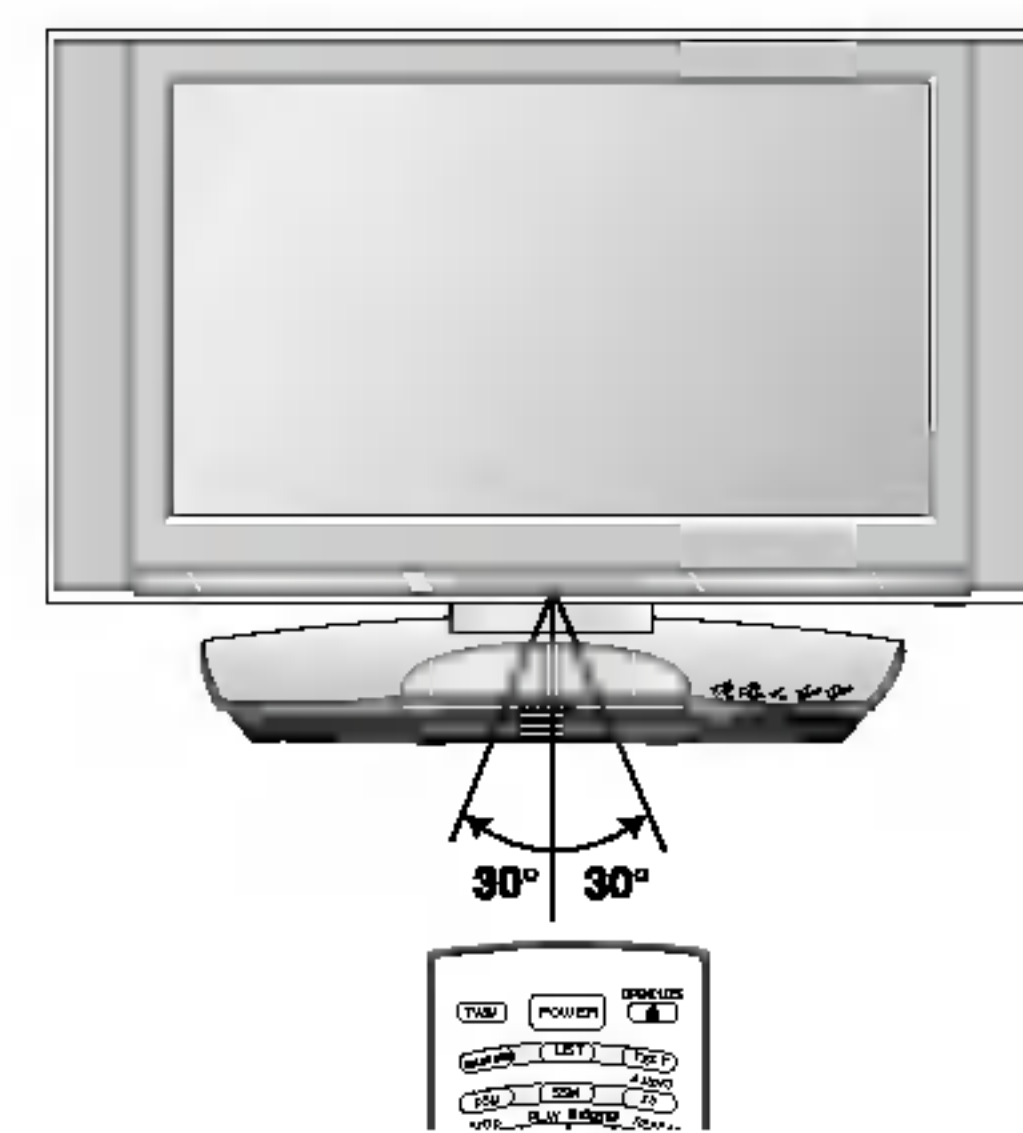
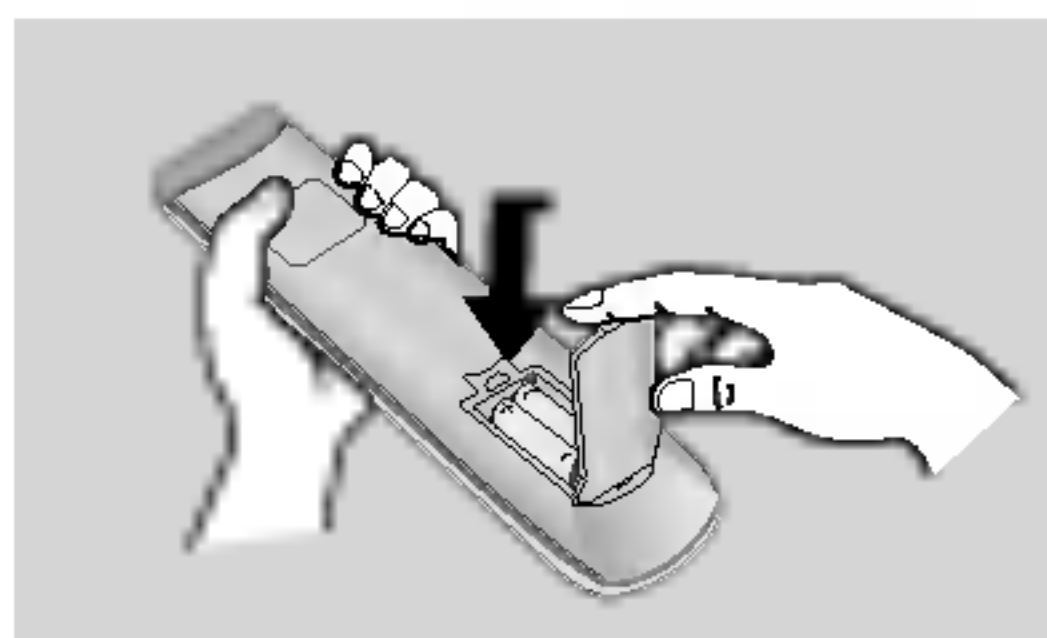

* Use a remote control 7 meter distance and 30 degree (left/right) within the receiving unit scope.

* Dispose of used batteries in the recycle bin to prevent environment.

Installation

Basic Connection

- 1** Pull the back cover backside while pushing the two tabs and then lift it up.

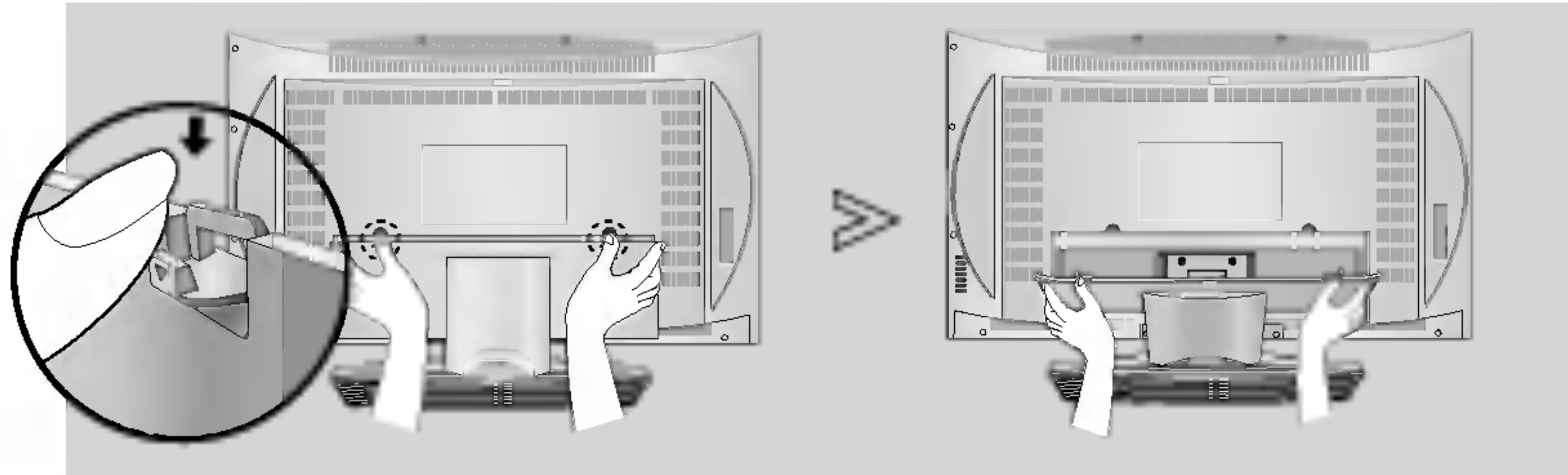

- 2** Connect the cables as necessary.
To connect an additional equipment, see the **External equipment Connections** section.

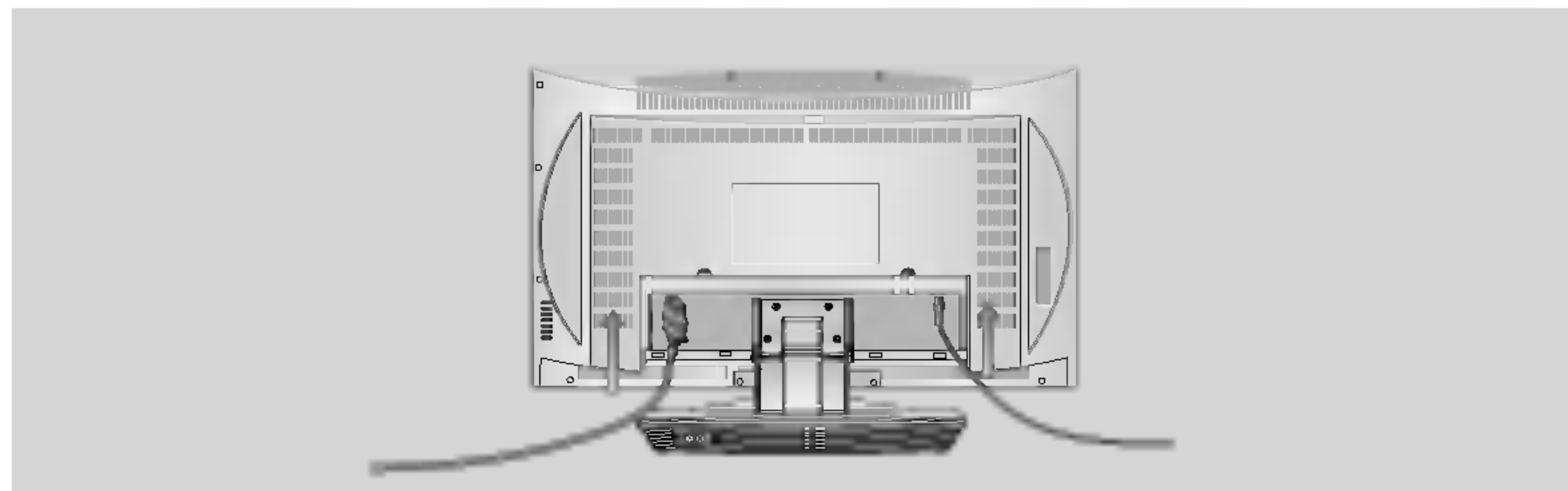

- 3** Align the holes on the TV back panel with the protuberances on the rear back cover and insert.

- Cable Arrangement

Pull the cables through the hole on the set and bundle the cables using the supplied twister holder.

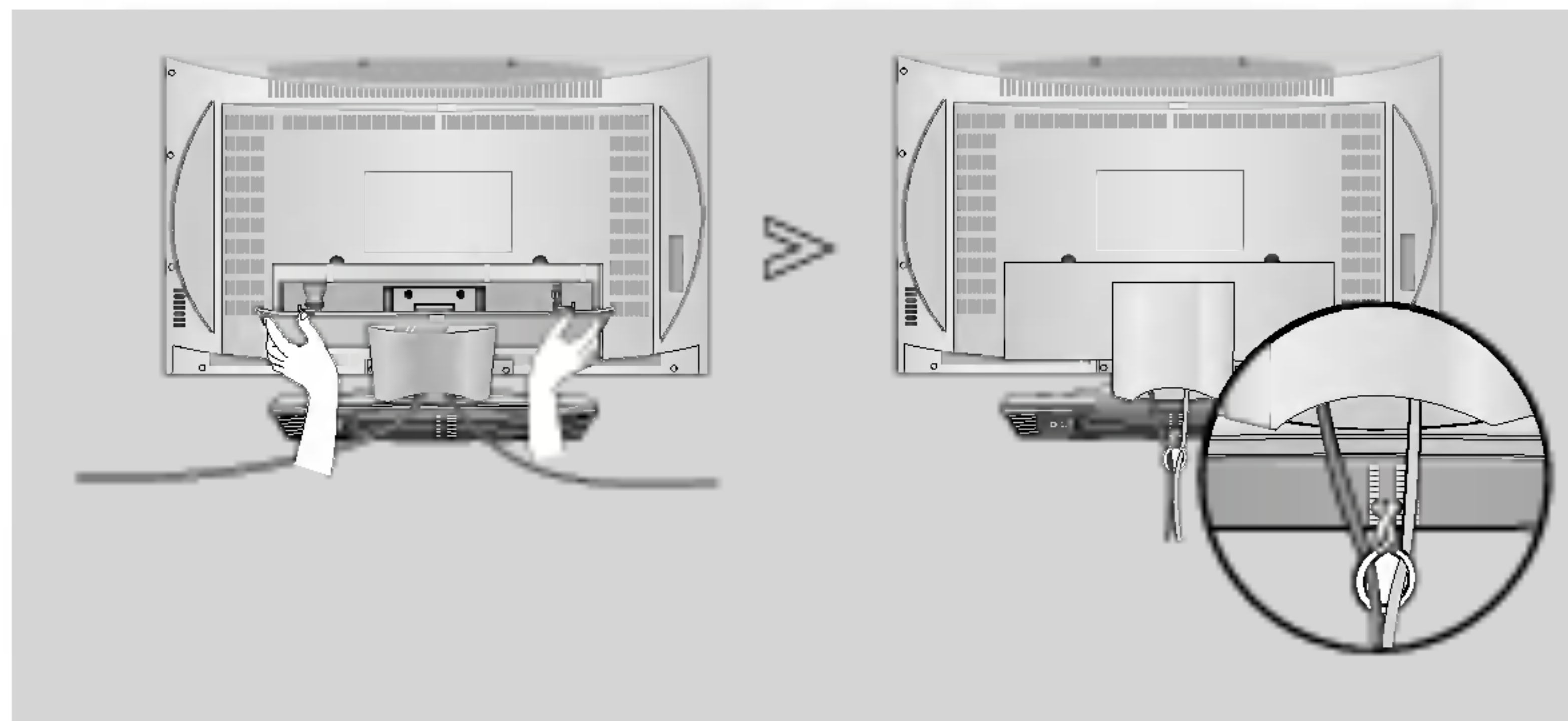

Desktop Pedestal Installation



For proper ventilation, allow a clearance of 4" on each side and from the wall.

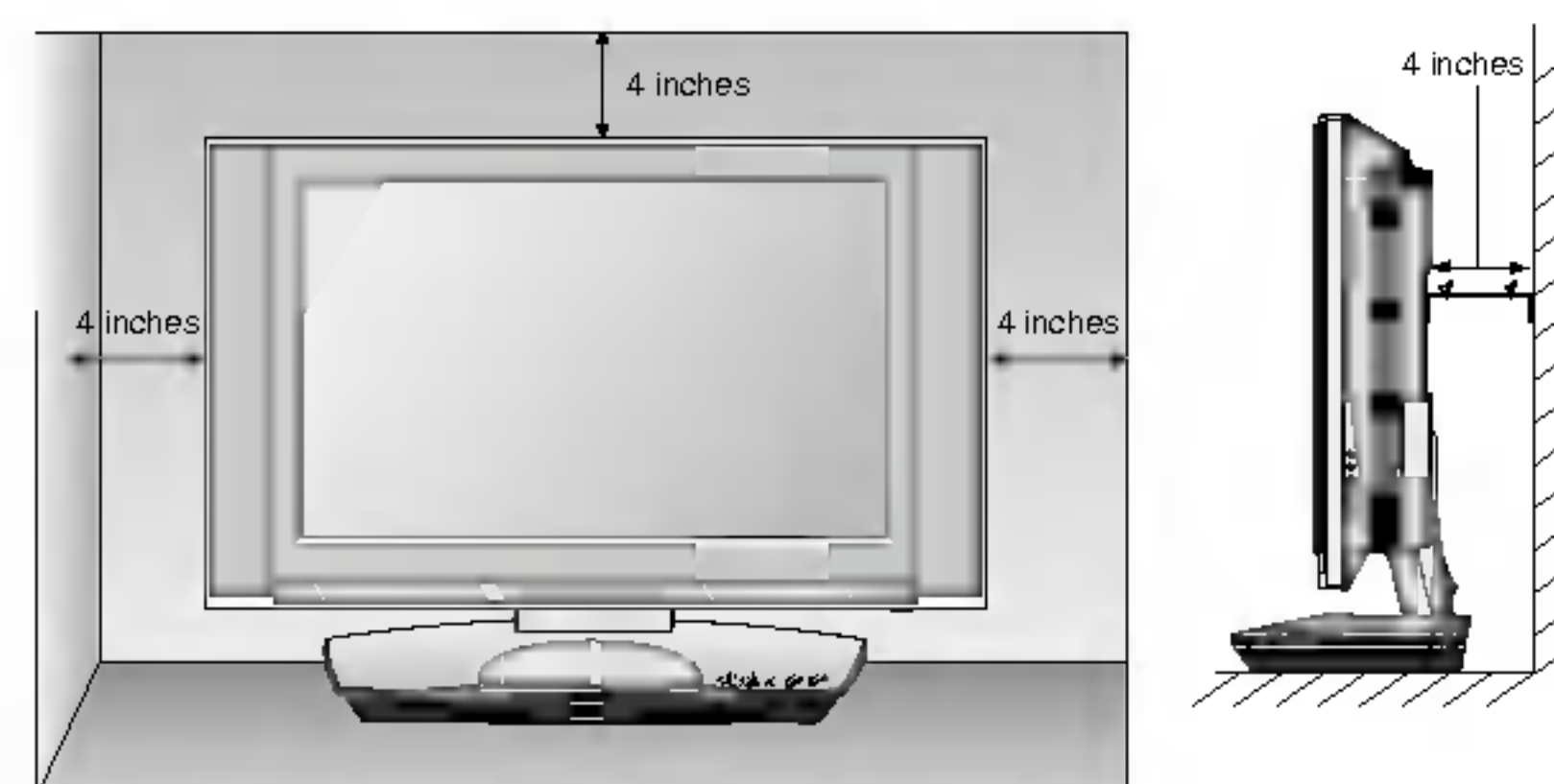

External Equipment Connections

To prevent the equipment damage, never plug in any power cords until you have finished connecting all equipment.

Antenna Connection

- For optimum picture quality, adjust antenna direction.
- An antenna cable and converter are not supplied.

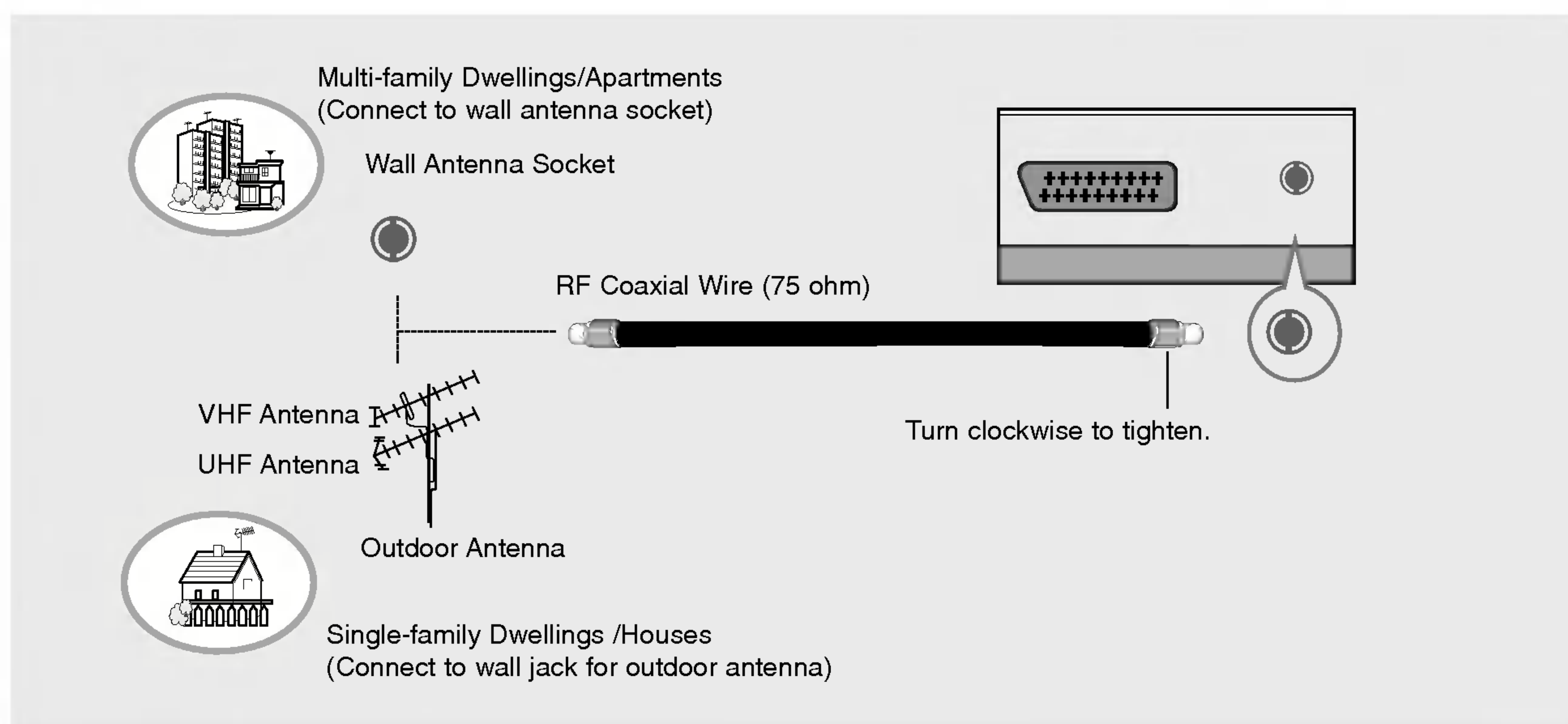

- In poor signal areas, to get better picture quality, install a signal amplifier to the antenna as shown to the right.
- If signal needs to be split for two TVs, use an antenna signal splitter for connection.

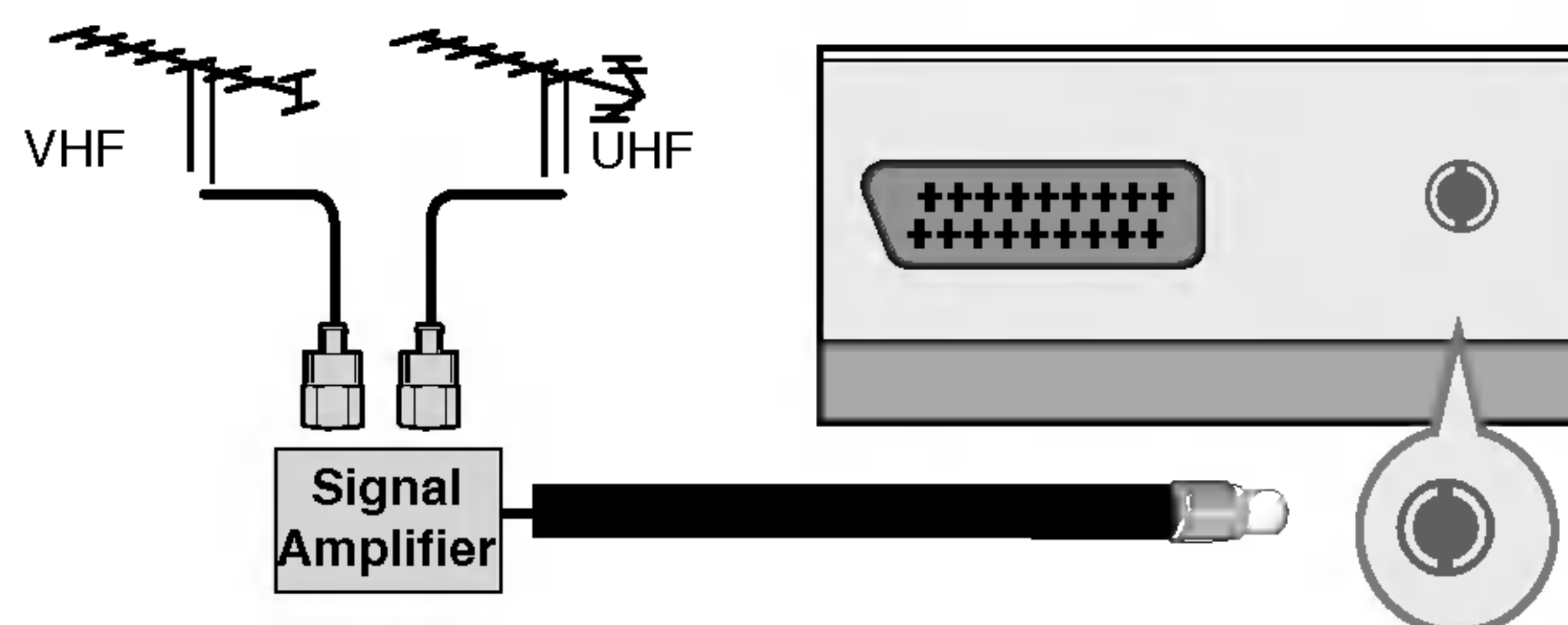

Installation

External Equipment Connections

VCR Setup

- To avoid picture noise (interference), leave an adequate distance between the VCR and TV.
- Typically a frozen still picture from a VCR. If the 4:3 picture format is used; the fixed images on the sides of the screen may remain visible on the screen.

When connecting with an antenna cable

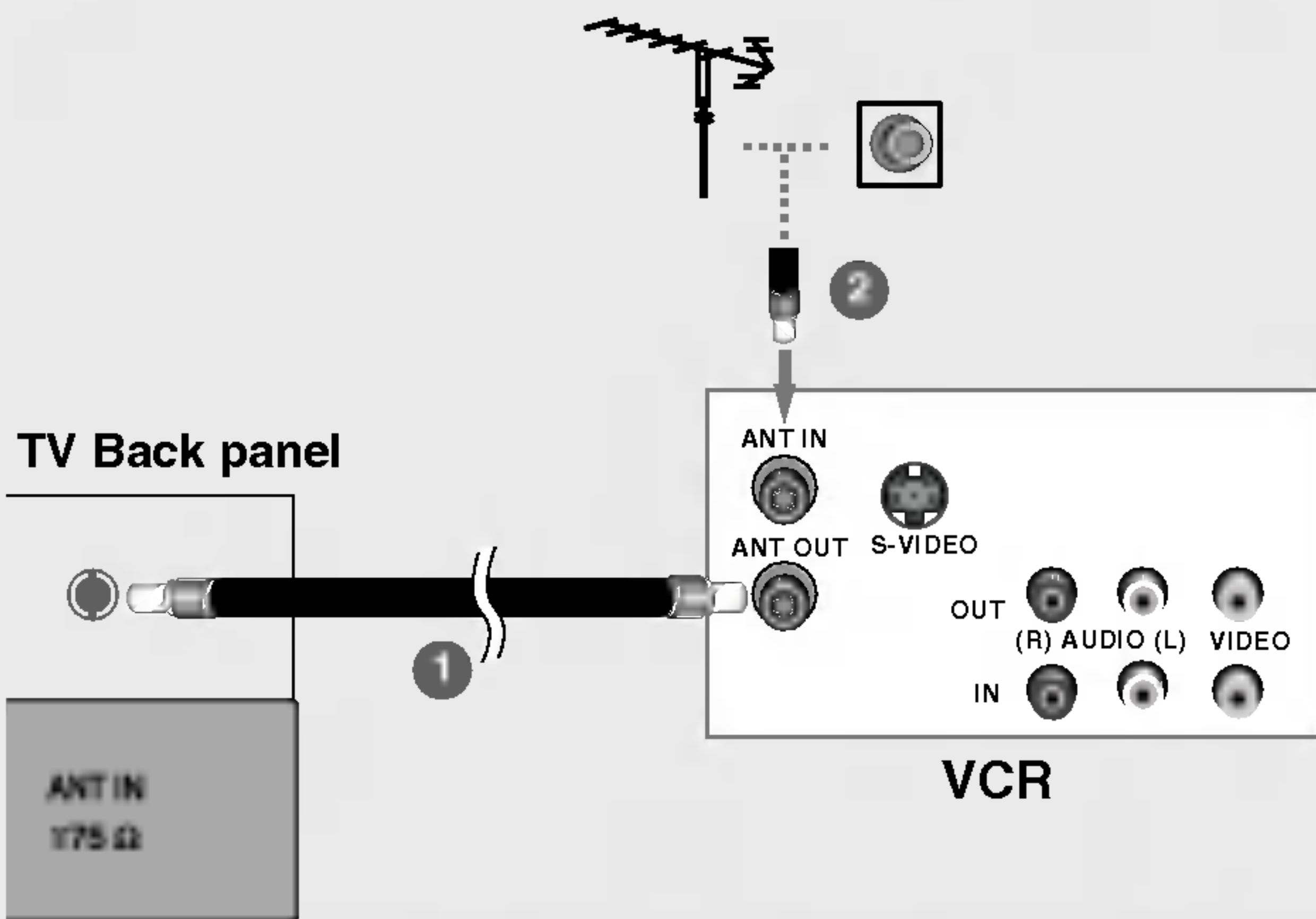

- 1 Connect the **ANT OUT** socket of the VCR to the **ANT IN** socket on the set.
- 2 Connect the antenna cable to the **ANT IN** socket of the VCR.
- 3 Press the **PLAY** button on the VCR and match the appropriate programme between the TV and VCR for viewing.

When connecting with a Scart cable

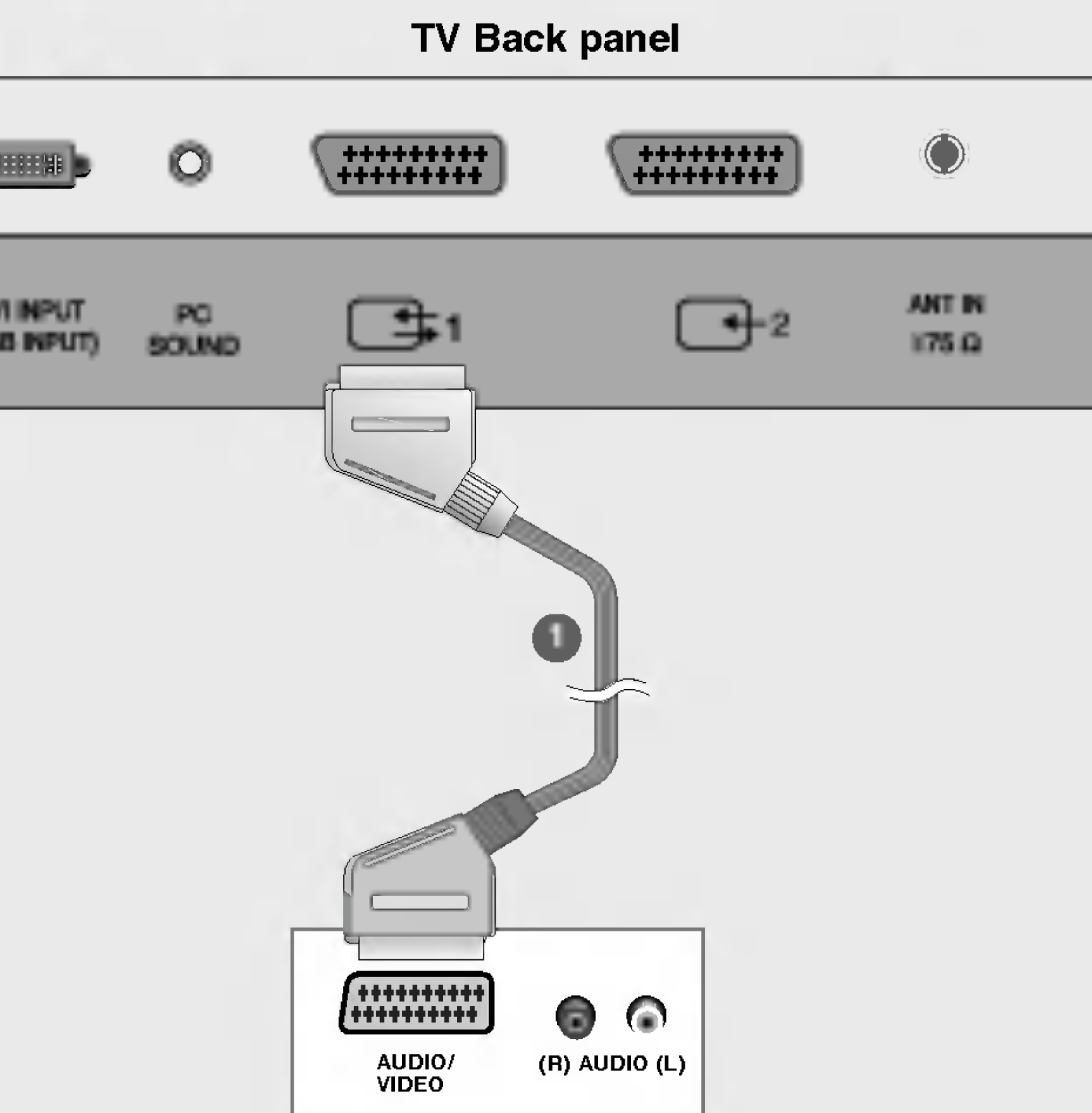

- 1 Connect the scart socket of the VCR to the **AV1** scart socket on the set. Please use shielded scart cable.
- 2 Insert a video tape into the VCR and press **PLAY** on the VCR. (Refer to the VCR owner's manual.)
- 3 Select **AV1** input source with using the **TV/AV** button on the remote control.
 - If connected to **AV2** scart socket, select **AV2** input source.

 If your VCR outputs an AV switching signal via the **AV1** or **AV2** scart sockets, the set will switch to **AV1** input source automatically. But if you want to keep on watching TV mode, press the PR ▲ / ▼ or number buttons.

- You can also record programmes received by the TV on video tape.
- The signal type RGB (the signals red, green and blue) can only be selected for the **AV1** scart socket and the **AV1** input source can be received. These signals are transmitted, for example, by a pay TV decoder, game machine or photo CD unit, etc and that digital signal can be recorded via **AV1** scart socket.
- If the **AV1**, **AV2** scart sockets have been connected to the VCRs simultaneously, only the **AV2** input source can be received.
- In **AV2** scart socket, the video output is not available.

When connecting with an S-Video cable

TV side panel

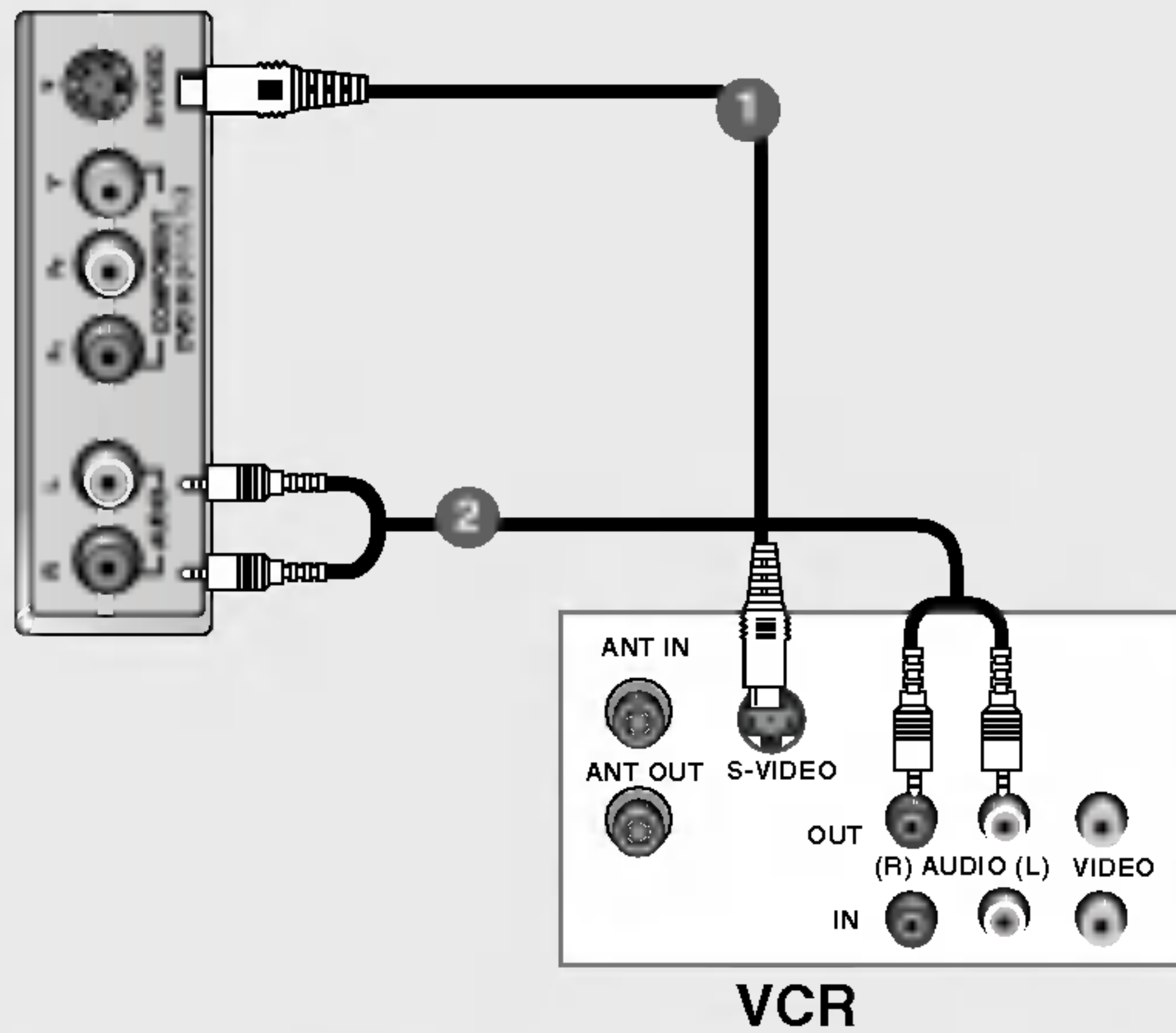

- 1 Connect the **S-VIDEO** output of the VCR to the **S-VIDEO** input on the set. The picture quality is improved; compared to connecting a regular VCR to the Video input.
- 2 Connect the **AUDIO** jacks between TV and VCR.
- 3 Insert a video tape into the VCR and press **PLAY** on the VCR. (Refer to the VCR owner's manual.)
- 4 Select **S-video** input source with using the **TV/AV** button on the remote control.

External AV Source Setup

TV side panel

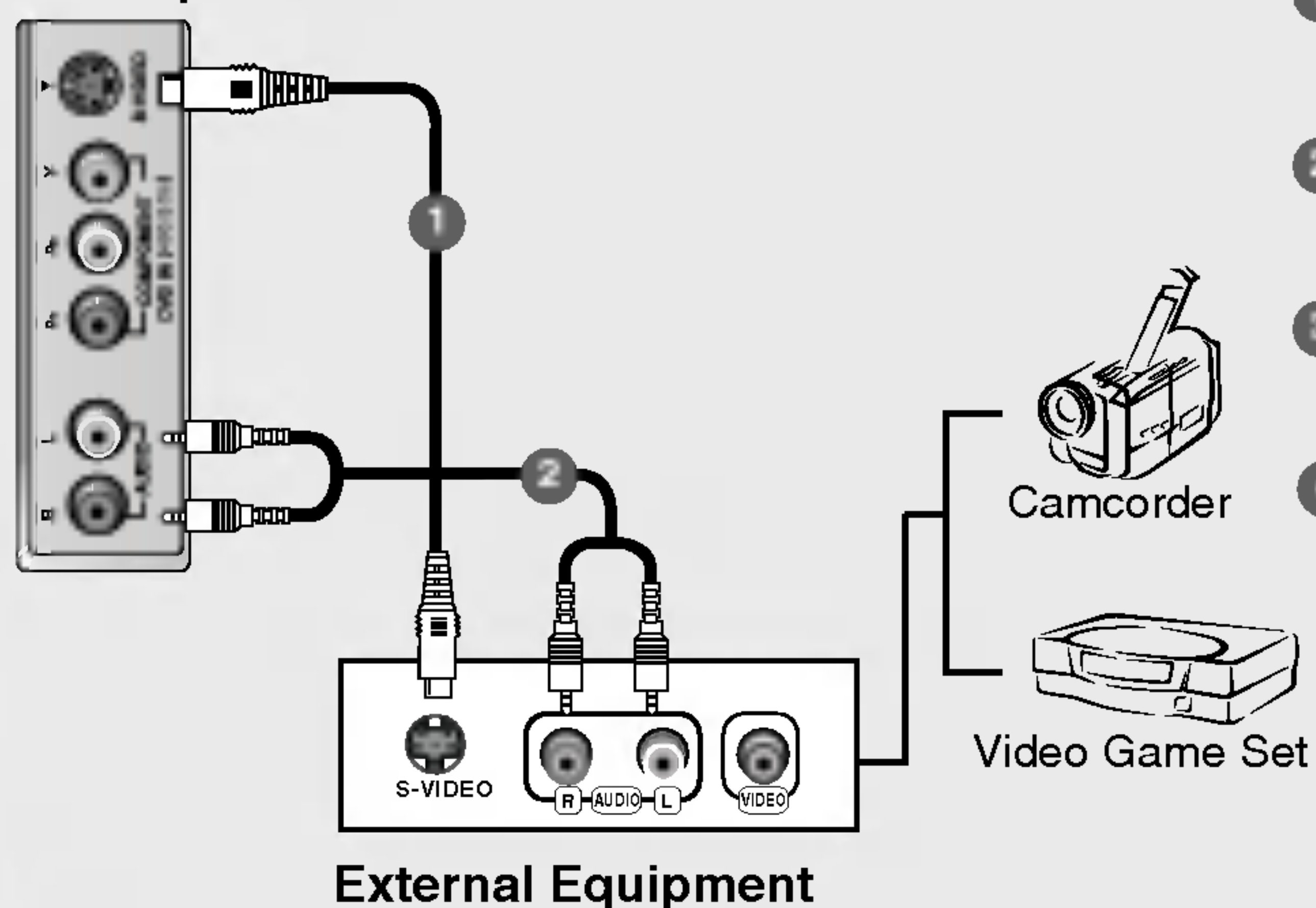

- 1 Connect the **S-VIDEO** output of the external equipment to the **S-VIDEO** input on the set.
- 2 Connect the audio outputs of the external equipment to the **AUDIO** input jacks on the set.
- 3 Select **S-video** input source with using the **TV/AV** button on the remote control.
- 4 Operate the corresponding external equipment. Refer to external equipment operating guide.

Installation

External Equipment Connections

External DVD Setup

When connecting with a component cable

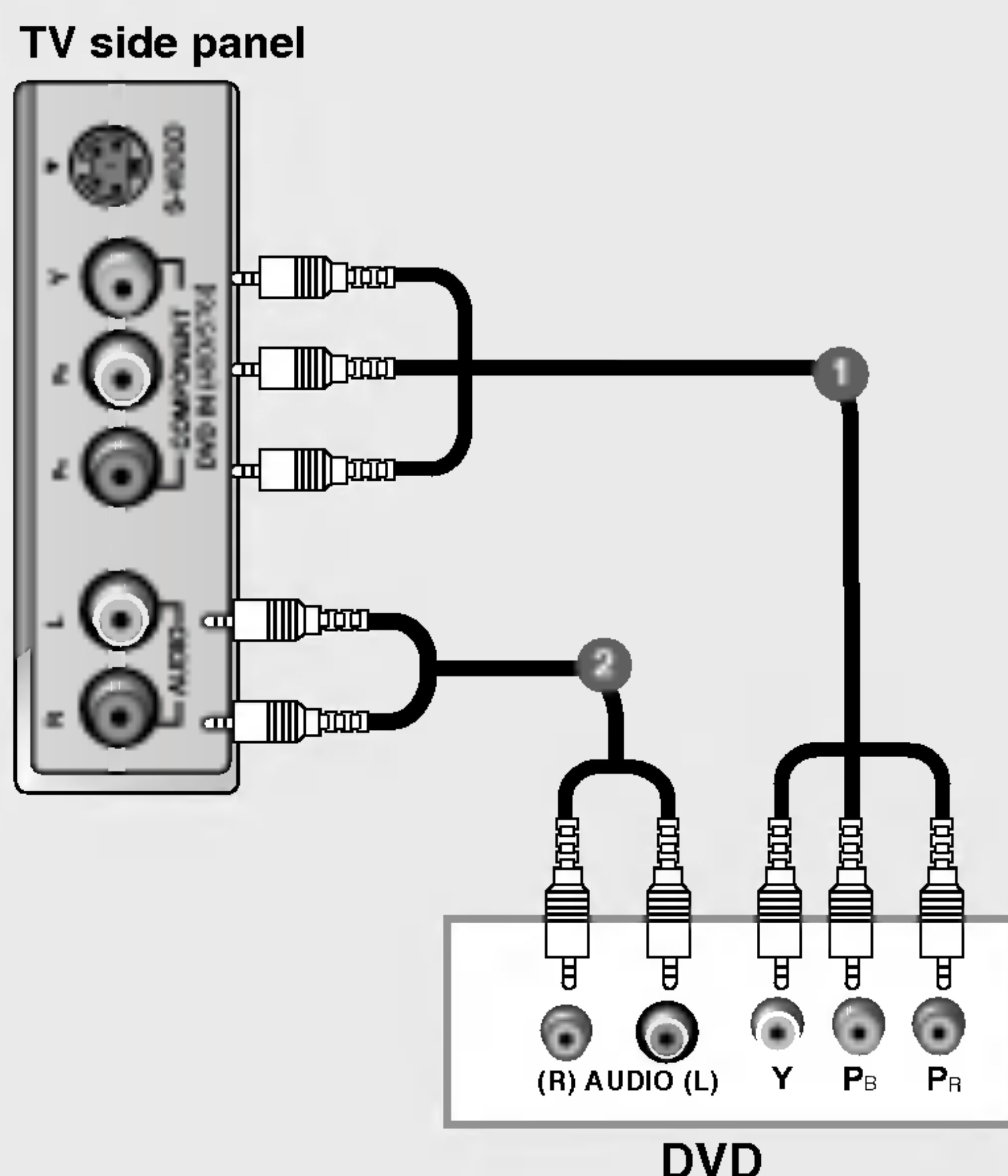

- 1 Connect the video outputs (Y, PB, PR) of the DVD to the **COMPONENT DVD IN (Y, PB, PR)** jacks on the set.
- 2 Connect the audio outputs of the DVD to the **AUDIO** input jacks on the set.
- 3 Turn on the DVD player, insert a DVD.
- 4 Select **Component** input source with using the **TV/AV** button on the remote control.
- 5 Refer to the DVD player's manual for operating instructions.



• Component Input ports

To get better picture quality, connect a DVD player to the component input ports as shown below.

Component ports on the TV	Y	P _B	P _R
Video output ports on DVD player	Y	P _b	P _r
	Y	B-Y	R-Y
	Y	Cb	Cr
	Y	P _B	P _R

When connecting with a scart cable

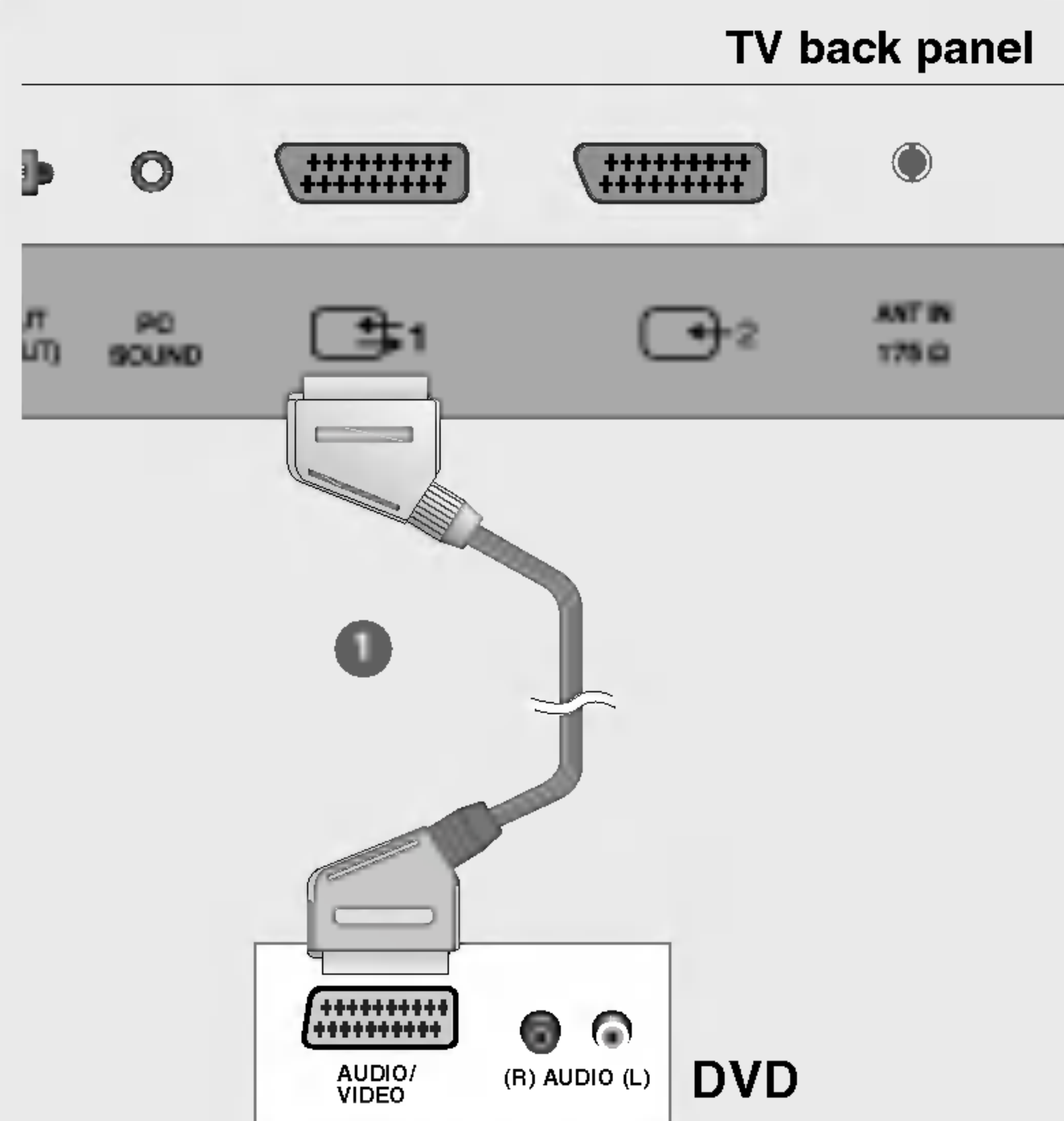

- 1 Connect the scart socket of the DVD to the **AV1** scart socket on the set. Please use shielded scart cable.
- 2 Turn on the DVD player, insert a DVD.
- 3 Select **AV1** input source with using the **TV/AV** button on the remote control.
 - If connected to **AV2** scart socket, select **AV2** input source.

When connecting with a S-Video cable

TV side panel

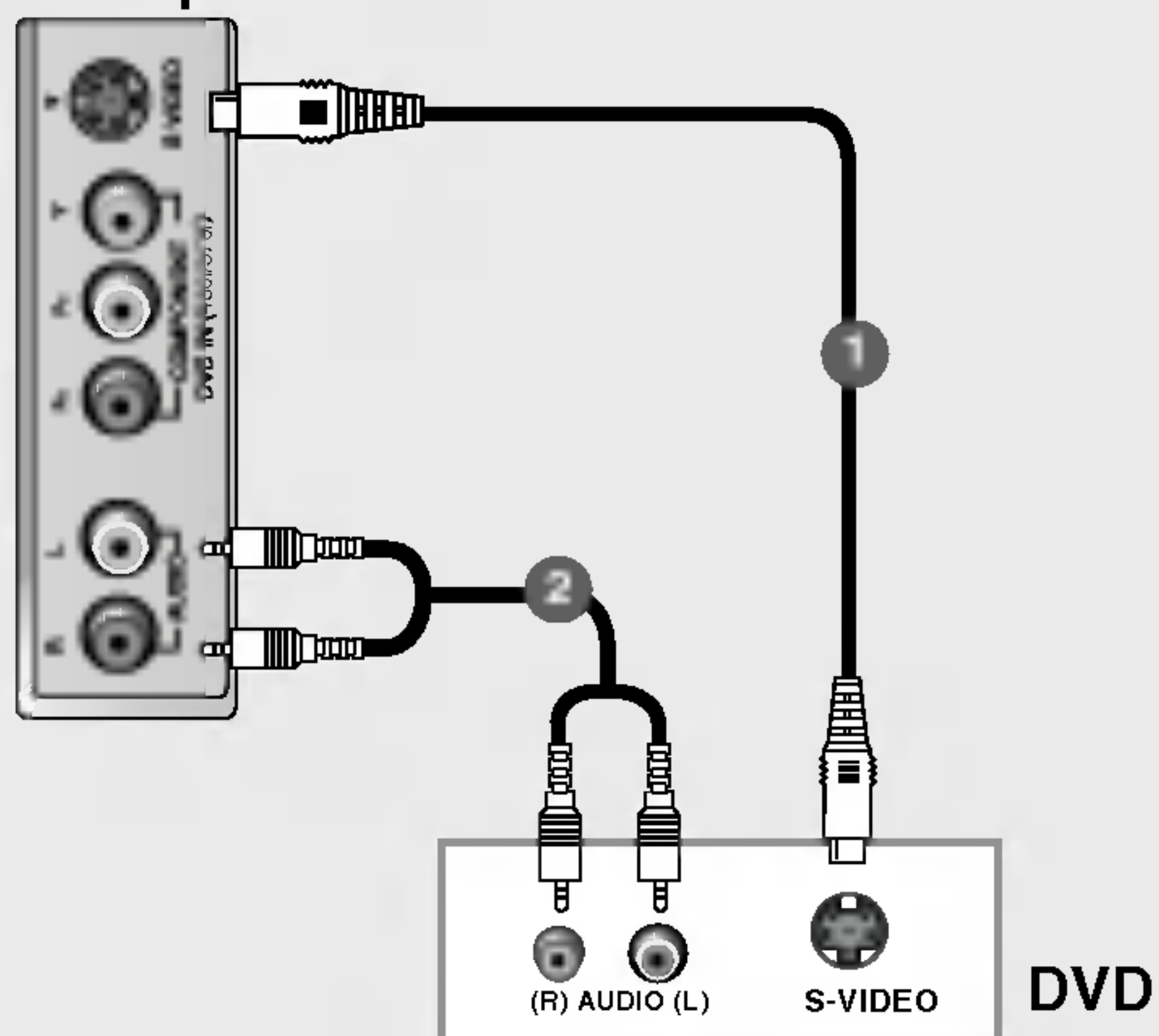

- 1 Connect the S-VIDEO output of the DVD to the **S-VIDEO** input on the set.
- 2 Connect the audio outputs of the DVD to the **AUDIO** input jacks on the set.
- 3 Turn on the DVD player, insert a DVD.
- 4 Select **S-video** input source with using the **TV/AV** button on the remote control.
- 5 Refer to the DVD player's manual for operating instructions.

DVD Output Setup

The TV has a special signal output capability which allows you to hook up a second TV or monitor.

- 1 Connect the second TV or monitor to the TV's **DVD OUT (VIDEO)** and **DVD OUT (AUDIO)** jacks.
 - 2 See the Operating Manual of the second TV or monitor for further details regarding that device's input settings.
- 1 Connect the second TV or monitor to the TV's **DVD OUT (VIDEO)** and **OPTICAL DIGITAL SOUND OUT** jacks.
 - 2 See the Operating Manual of the second TV or monitor for further details regarding that device's input settings.

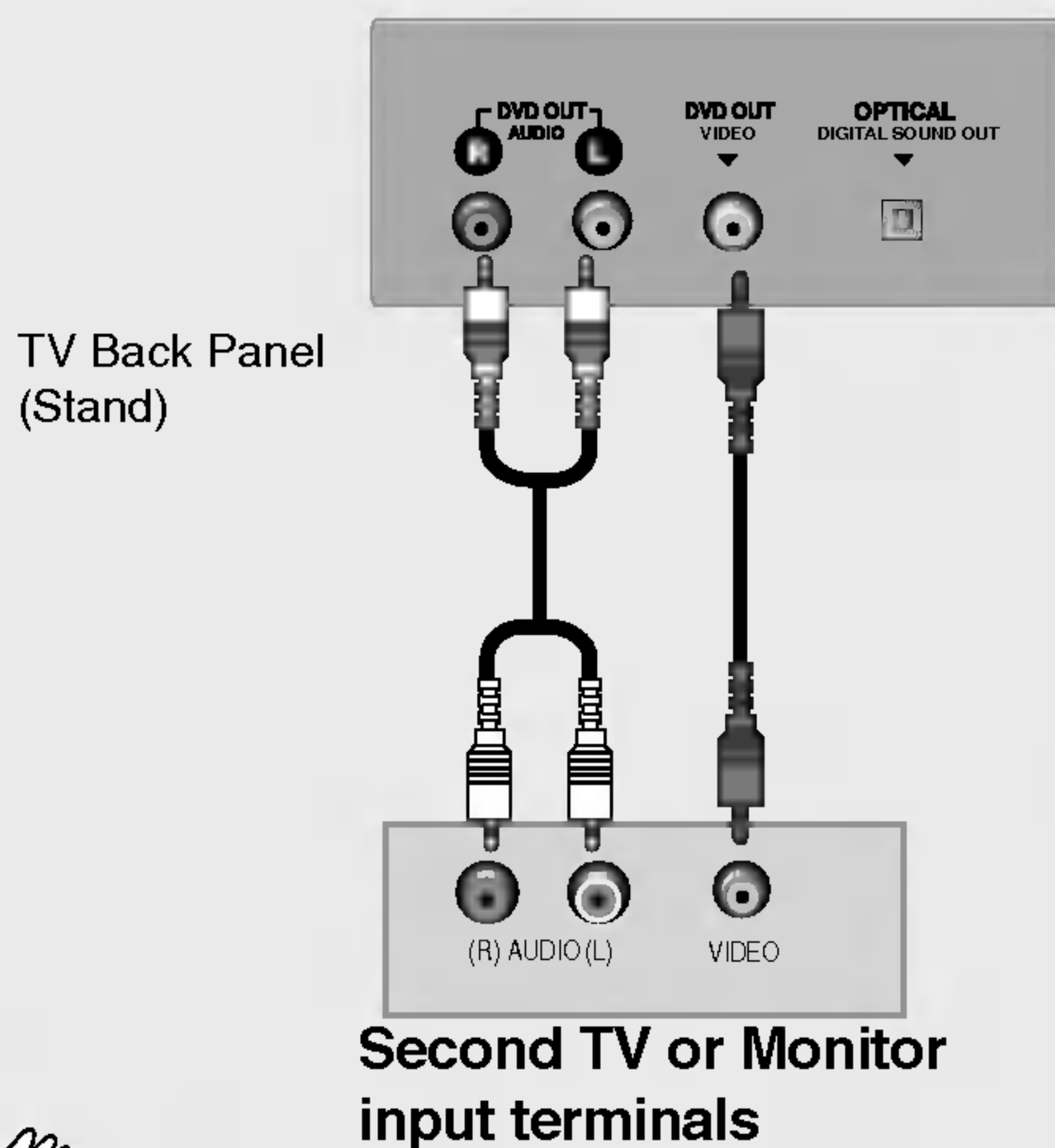

OR

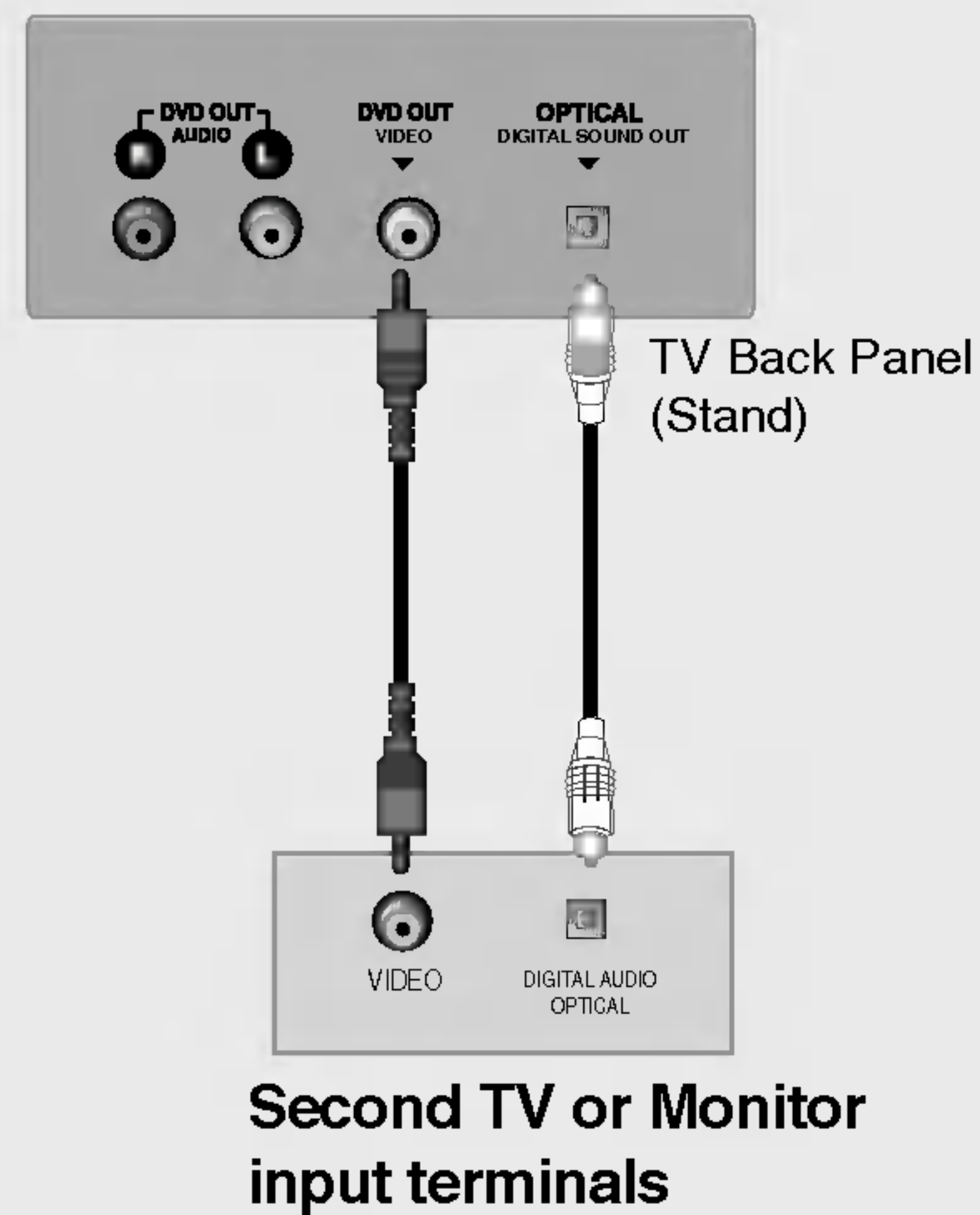

Note

- a. If your second TV or monitor has no optical digital audio input jack, it's impossible to use DVD digital sound output.
- b. Do not look into the optical output port. Looking at the laser beam may damage your vision.
- c. If your external audio equipment has a digital audio input optical port, you can connect it to your TV.

Installation

External Equipment Connections

PC Setup

- 1 Connect the TV to the PC with the PC cable.
- 2 Connect the PC audio output to the TV's **PC SOUND** input.
- 3 Turn on the PC.
- 4 Use the **TV/AV** button on the remote control to select **PC**.

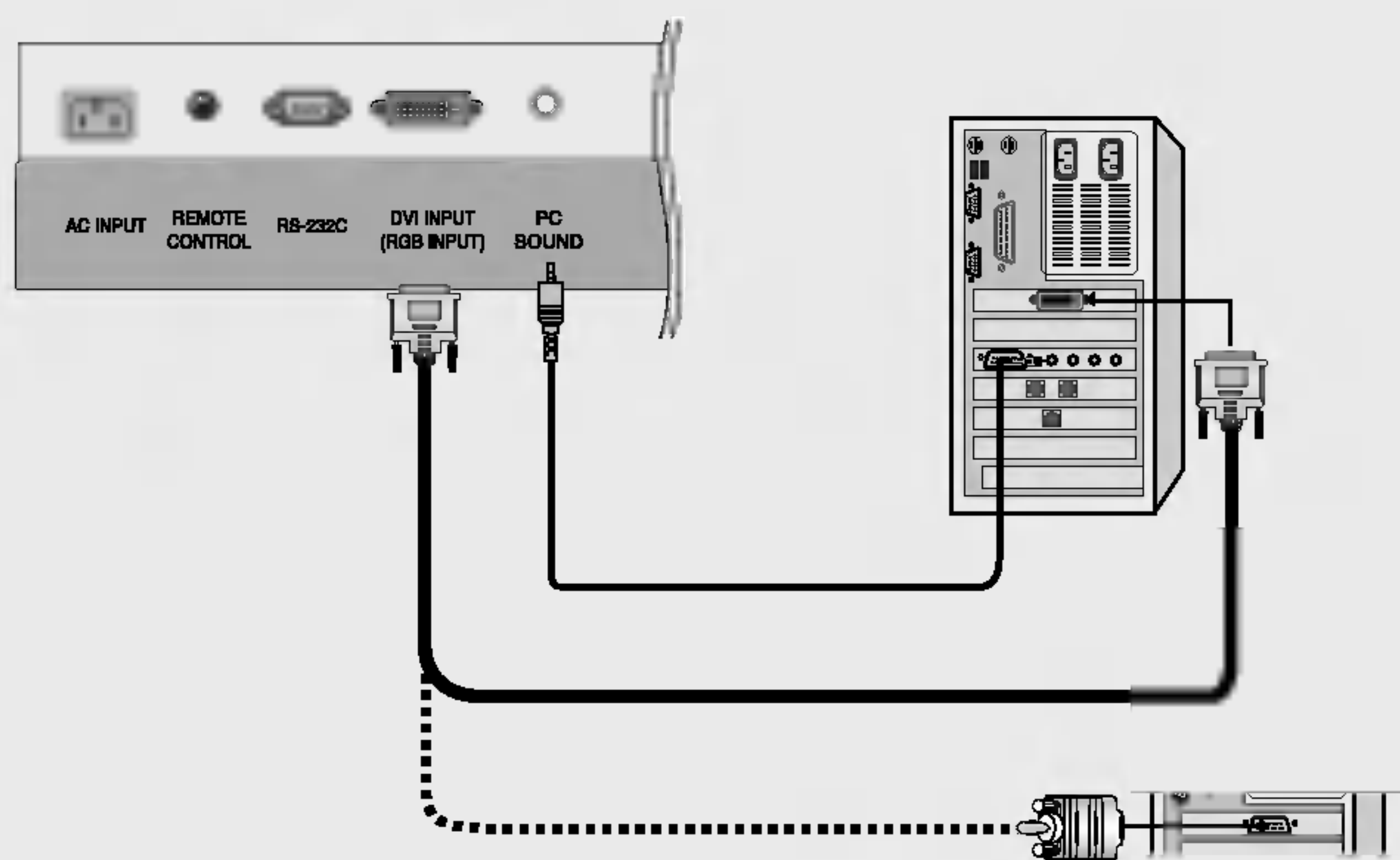

NOTE

Connect the signal cable (DVI-D cable, Not DVI to D-Sub cable) from the DVI output socket of the PC to the DVI input socket of the set when using a PC with DVI output. In some video cards, DVI-Analog output may not be supported.

Monitor Display Specifications

Resolution	Horizontal Frequency(kHz)	Vertical Frequency(Hz)
640x480	31.47	60
	35.00	66.67
	37.50	75
800x600	35.16	56.25
	37.88	60
	48.08	72.19
	46.88	75
1024x768	48.36	60
	56.48	70
	60.02	75
1280x768	47.78	60



Note

- a. For optimum picture quality, use standard WXGA 1280x768 computer output at a 60Hz refresh rate. Using other formats (VGA, SVGA, etc.) or refresh rates may result in reduced picture quality. (To change the computer video output format, please refer to the operating manual for the computer you are using).
- b. If the message **Out of range** appears on the screen, adjust the PC output to a format listed in the **Monitor Display Specifications** table.
- c. The synchronization input form for Horizontal and Vertical frequencies is separate.

DPM (Display Power Management) mode

If the PC goes to power saving mode, the monitor automatically switches to DPM mode. If you don't use the PC cable provided, DPM mode may not work.

Power Cord Connection

- Connect the power cord correctly as shown.

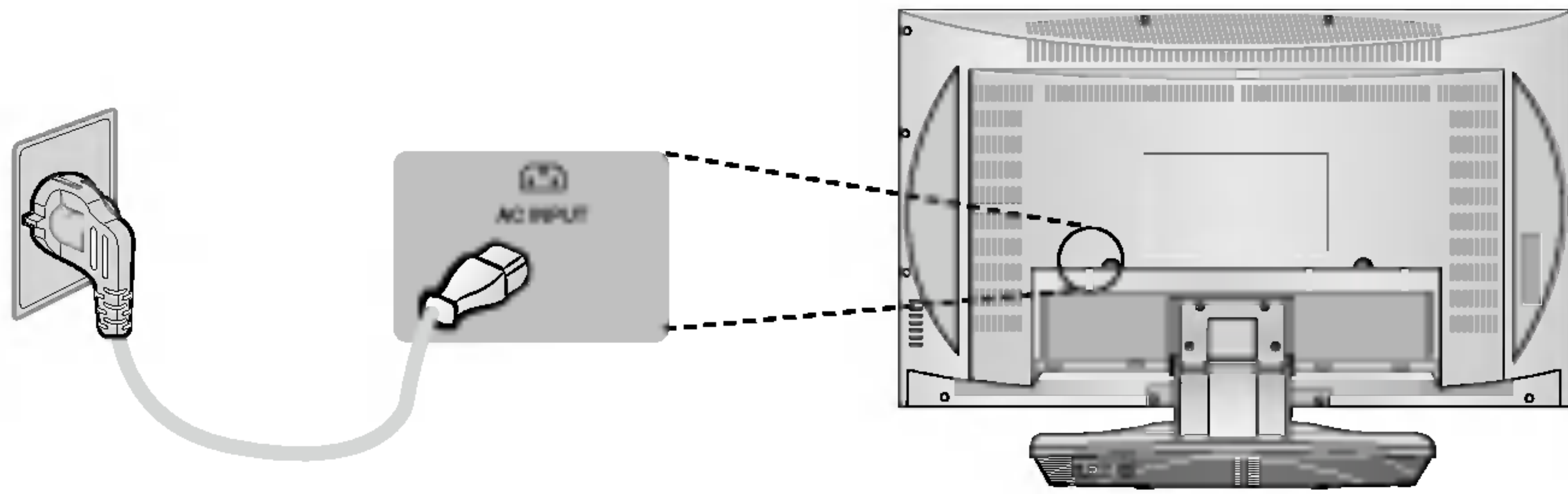

Operation

Basic Operation

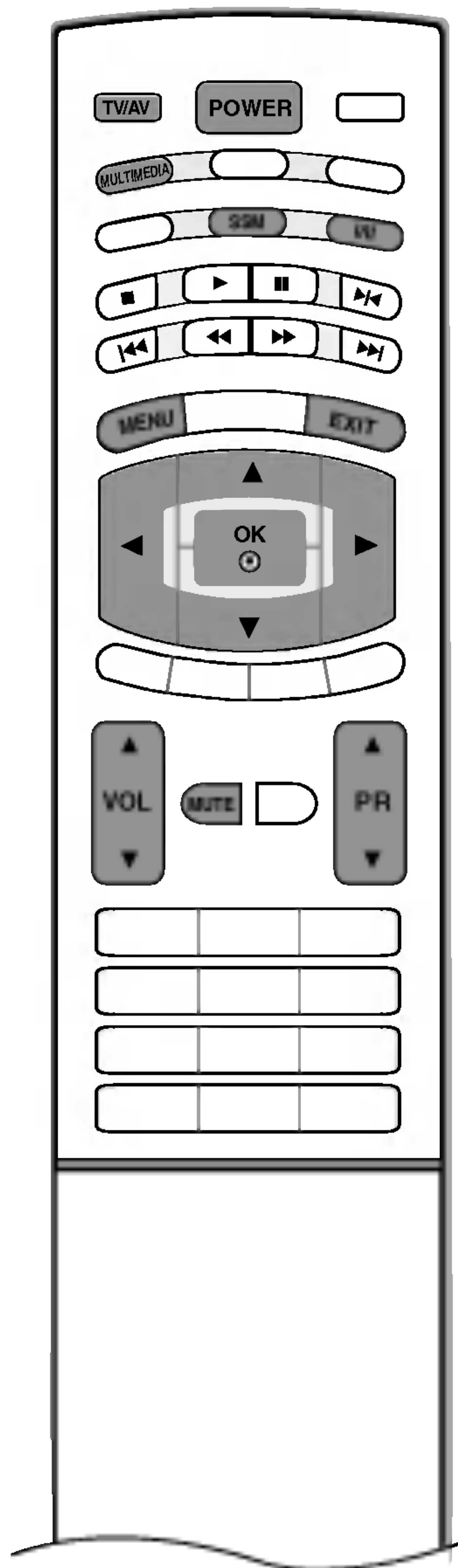

Turning On/Off the TV

- 1 First, make all equipment connections. Connect the AC power cord into the TV, then plug the power cord into a wall outlet. Press the **POWER** button located on the TV to turn on the TV. The power indicator will light.
 - In the standby mode, press the **POWER, PR ▲ / ▼, TV/AV, MULTIMEDIA** or number buttons on the remote control to turn on the TV.
- 2 If you want to turn the TV off, press the **POWER** button located on the remote control. If you intend to be away on vacation, disconnect the plug from the wall outlet.

Volume Adjustment

- 1 Press the **VOL ▲ / ▼** button to adjust the volume.
- 2 If you want to switch the sound off, press the **MUTE** button. You can cancel this function by pressing the **MUTE, VOL ▲ / ▼, I/II** or **SSM** button.

Programme selection

- 1 Press the **PR ▲ / ▼** or **NUMBER** buttons to select a programme number.

On screen language selection

- 1 Press the **MENU** button and then **▲ / ▼** button to select the **Setup** menu.
- 2 Press the **▶** button and then **▲ / ▼** button to select **Language**.
- 3 Press the **▶** button and then **▲ / ▼** button to select your desired language. All the on screen displays will appear in the selected language.
- 4 Press the **OK** button.
- 5 Press the **EXIT** button to return to normal TV viewing.

How to adjust the OSD screen

- 1 Press the **MENU** button and then **▲ / ▼** button to display each menu.
- 2 Press the **▶** button and then **▲ / ▼** button to select a menu item.
- 3 Change the setting of an item in the sub or pull-down menu with **◀ / ▶** button.
You can move to the higher level menu by pressing the **OK** or **MENU** button.

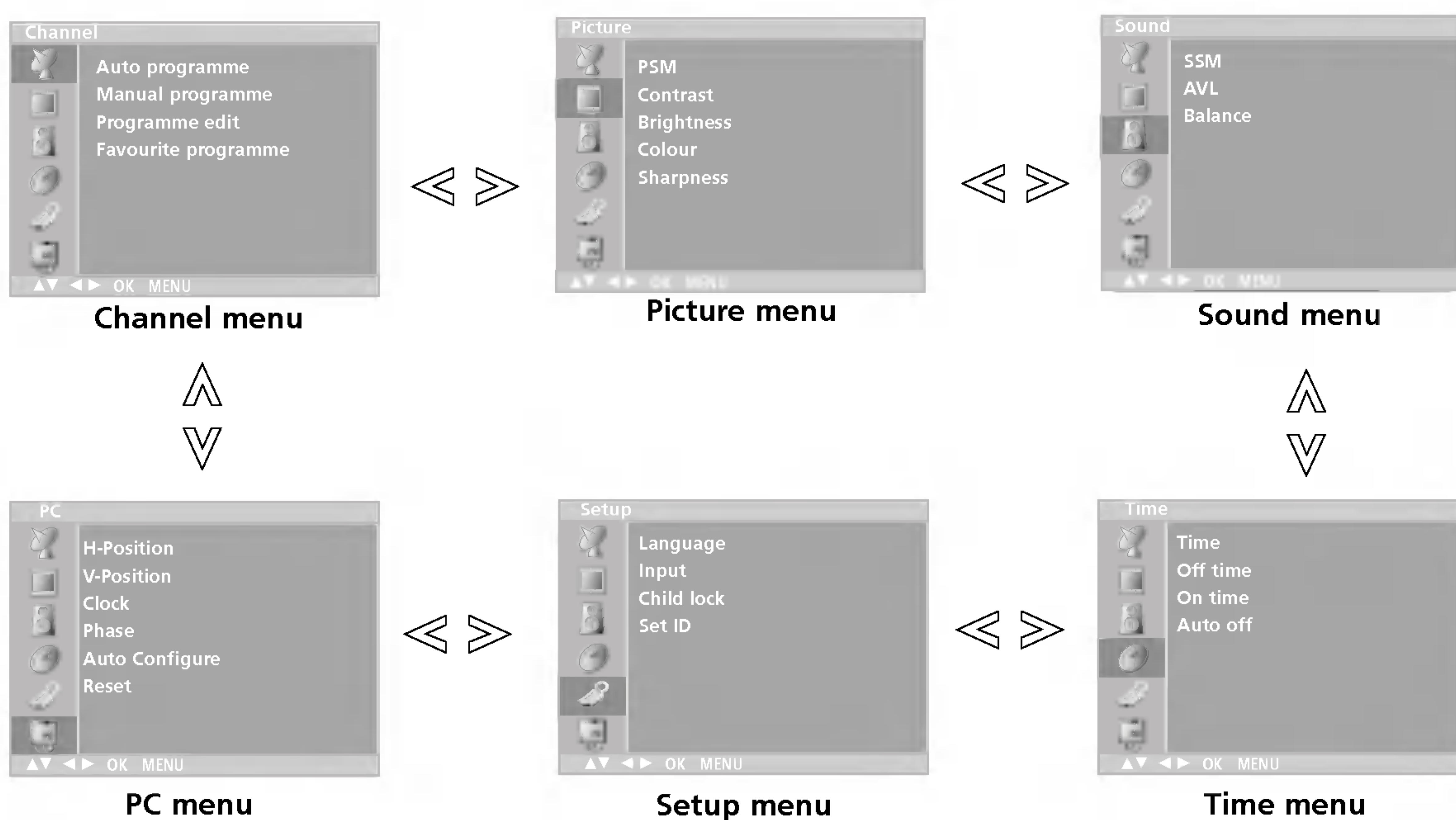

Note

- a. In the **TV**, **AV1**, **AV2**, **S-video**, **DVD**, and **Component** mode, the PC menu(option) is not displayed.
- b. In the teletext mode, menus are not displayed.



Setting up TV stations

Up to 100 TV stations can be stored by programme numbers (0 to 99). Once you have preset the stations, you will be able to use the ▲ / ▼ or NUMBER buttons to scan the stations you have programmed. Stations can be tuned using automatic or manual modes.

Auto programme tuning

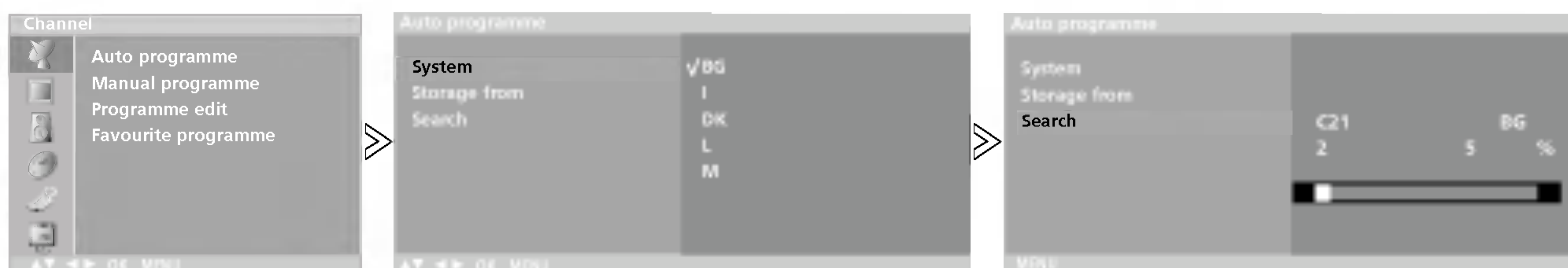

- All stations that can be received are stored by this method. It is recommended that you use auto programme during installation of this set.

- 1 Press the **MENU** button and then ▲ / ▼ button to select the **Channel** menu.
- 2 Press the ► button and then ▲ / ▼ button to select **Auto programme**.
- 3 Press the ► button. Select a TV system with the ► button and then ▲ / ▼ button on the **System** menu;
 - BG** : PAL B/G, SECAM B/G (Europe/East Europe)
 - I** : PAL I/II (U.K./Ireland)
 - DK** : PAL D/K, SECAM D/K (East Europe)
 - L** : SECAM L/L' (France)
 - M** : (USA/Korea/Philippines)
- 4 Press the **OK** button.
- 5 Press the ▲ / ▼ button to select **Storage from**.
- 6 Select the beginning programme number with the ◀ / ▶ button or NUMBER buttons on the **Storage from** pull-down menu. Any number under 10 is entered with a numeric '0' in front of it, i.e. '05' for 5.
- 7 Press the **OK** button.
- 8 Press the ▲ / ▼ button to select **Search**.
- 9 Press the ► button to begin auto programming.
All receivable stations are stored. The station name is stored for stations which broadcast VPS (Video Programme Service), PDC (Programme Delivery Control) or TELETXT data. If no station name can be assigned to a station, the channel number is assigned and stored as **C** (V/UHF 01-69) or **S** (Cable 01-47), followed by a number.

To stop auto programming, press the **MENU** button.

When auto programming is completed, the **Programme edit** menu appears on the screen. See the **Programme edit** section to edit the stored programme.

- 10 Press the **EXIT** button to return to normal TV viewing.

Manual programme tuning



- *Manual programme lets you manually tune and arrange the stations in whatever order you desire.*

- 1** Press the **MENU** button and then **▲ / ▼** button to select the **Channel** menu.
- 2** Press the **▶** button and then **▲ / ▼** button to select **Manual programme**.
- 3** Press the **▶** button and then **▲ / ▼** button to select **Storage**.
- 4** Select the desired programme number (0 to 99) with the **◀ / ▶** button or **NUMBER** buttons on the **Storage** menu. Any number under 10 is entered with a numeric **'0'** in front of it, i.e. **'05'** for 5.
- 5** Press the **OK** button.
- 6** Press the **▲ / ▼** button to select **System**.
- 7** Select a TV system with the **▶** button and then **▲ / ▼** button on the **System** menu;

BG	: PAL B/G, SECAM B/G (Europe/East Europe)
I	: PAL I/II (U.K./Ireland)
DK	: PAL D/K, SECAM D/K (East Europe)
L	: SECAM L/L' (France)
M	: (USA/Korea/Philippines)
- 8** Press the **OK** button.
- 9** Press the **▲ / ▼** button to select **Channel**.
- 10** Press the **▶** button and then **▲ / ▼** button to select **VHF/UHF** or **Cable** on the **Channel** menu.
 - If possible, press the channel number with the number buttons to commence searching directly . Any number under 10 is entered with a numeric **'0'** in front of it, i.e. **'05'** for 5.
- 11** Press the **OK** button.
- 12** Press the **▲ / ▼** button to select **Search**.
- 13** Press the **▶** button and then **◀ / ▶** button to commence searching. If a station is found the search will stop.
- 14** Press the **OK** button to store it.
- 15** To store another station, repeat steps **3** to **14**.
- 16** Press the **EXIT** button to return to normal TV viewing.

Setting up TV stations

Assigning a station name

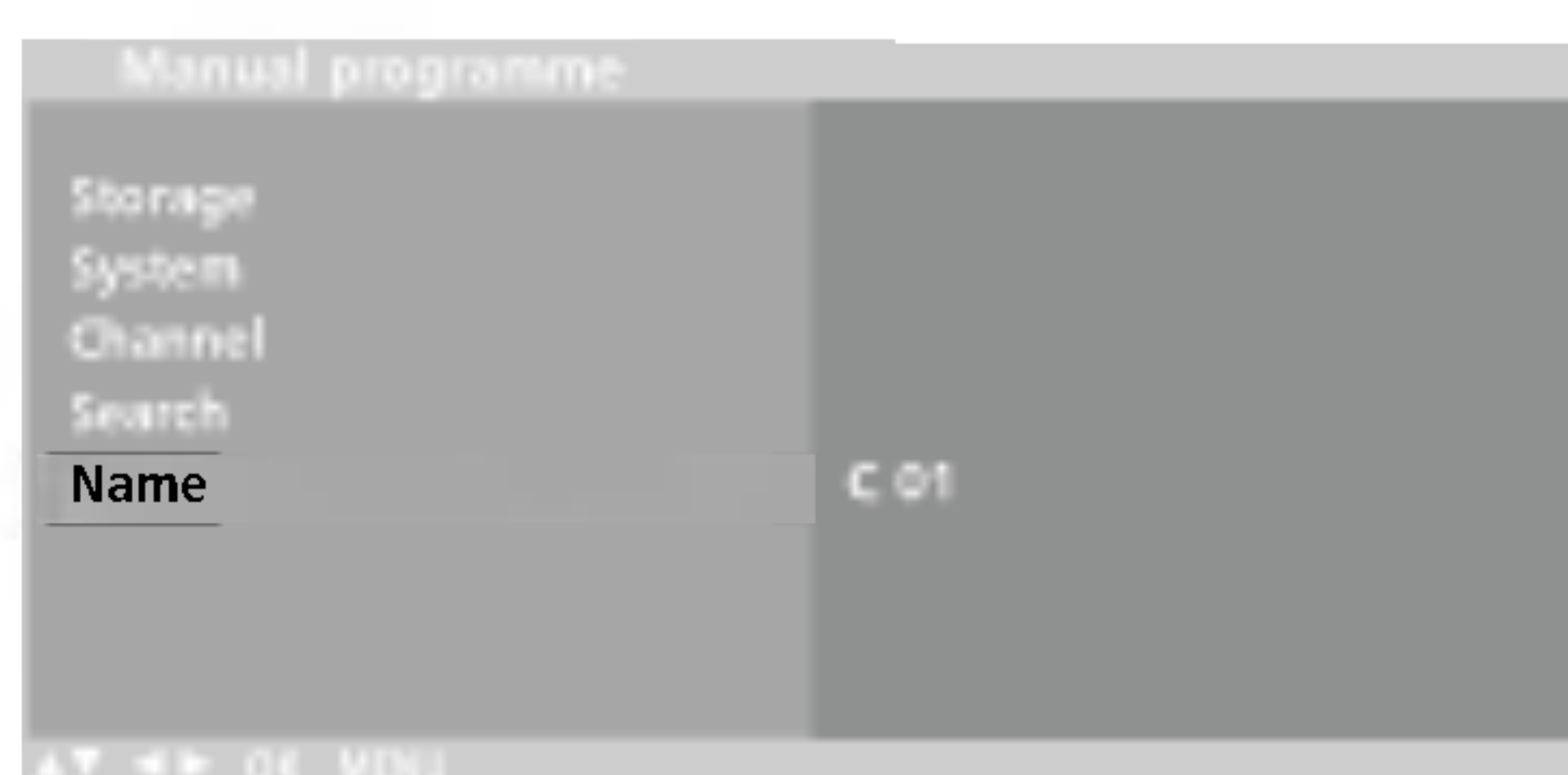

- You can assign a station name with five characters to each programme number.

- 1 Press the **MENU** button and then **▲ / ▼** button to select the **Channel** menu.
- 2 Press the **▶** button and then **▲ / ▼** button to select **Manual programme**.
- 3 Press the **▶** button and then **▲ / ▼** button to select **Name**.
- 4 Press the **▶** button and then use the **▲ / ▼** button. You can use a blank, +, -, the number **0** to **9** and the alphabet **A** to **Z**.
With the **◀** button you can select in the opposite direction.
- 5 Select the position by pressing the **◀ / ▶** button and then make your choice of the second character, and so on.
- 6 Press the **OK** button to store it.
- 7 Press the **EXIT** button to return to normal TV viewing.

Programme edit



- This function enables you to delete or skip the stored programmes. Also you can move some stations to other programme numbers or insert a blank station data into the selected programme number.

1 Press the **MENU** button and then **▲ / ▼** button to select the **Channel** menu.

2 Press the **▶** button and then **▲ / ▼** button to select **Programme edit**.

3 Press the **▶** button to display the **Programme edit** menu.

■ Deleting a programme

1. Select a programme to be deleted with the **▲ / ▼ / ◀ / ▶** button.
2. Press the **RED** button twice.

The selected programme is deleted, all the following programmes are shifted up one position.

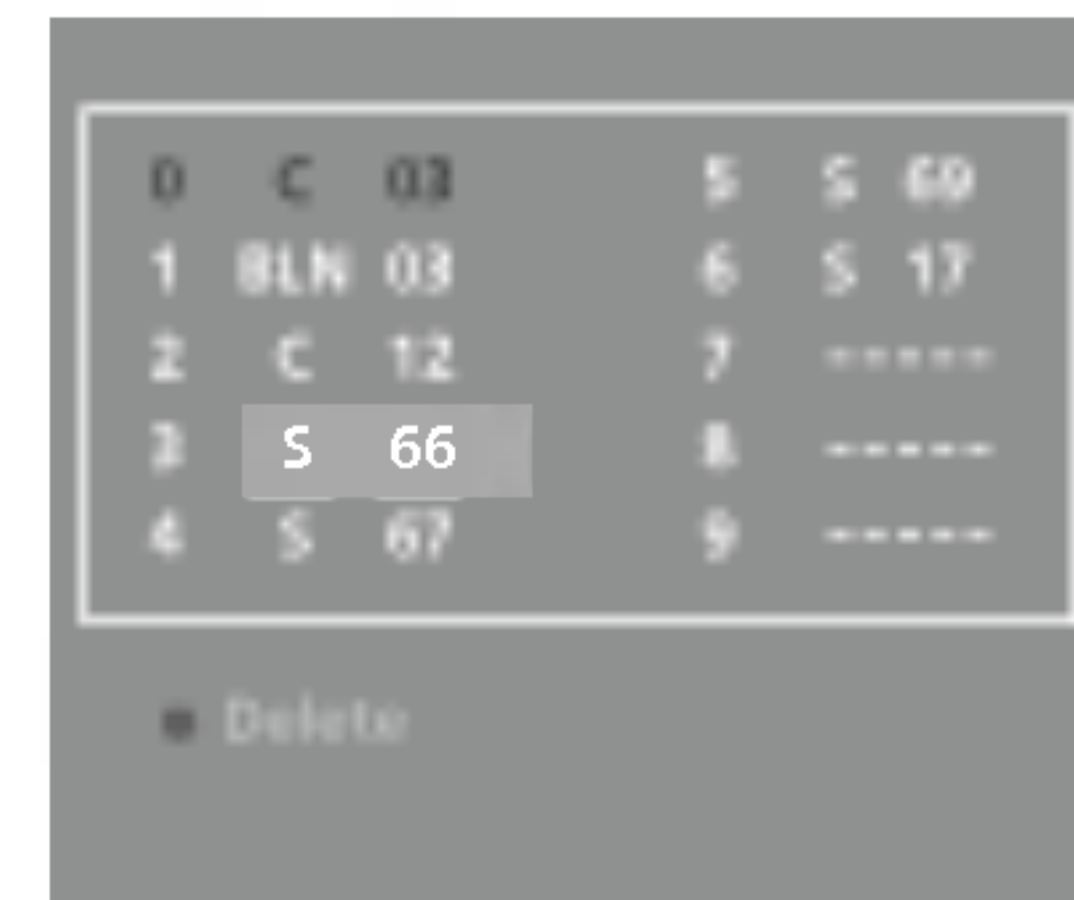

■ Copying a programme

1. Select a programme to be copied with the **▲ / ▼ / ◀ / ▶** button.
2. Press the **GREEN** button.

All the following programmes are shifted down one position.

■ Moving a programme

1. Select a programme to be moved with the **▲ / ▼ / ◀ / ▶** button.
2. Press the **YELLOW** button.
3. Move the programme to the desired programme number with the **▲ / ▼ / ◀ / ▶** button.
4. Press the **YELLOW** button again to release this function.

■ Skipping a programme number

1. Select a programme number to be skipped with the **▲ / ▼ / ◀ / ▶** button.
2. Press the **BLUE** button. The skipped programme turns to blue.
3. Press the **BLUE** button again to release the skipped programme.

When a programme number is skipped it means that you will be unable to select it using the **▲ / ▼** button during normal TV viewing. If you want to select the skipped programme, directly enter the programme number with the **NUMBER** buttons or select it in the programme edit or table menu.

4 Press the **EXIT** button to return to normal TV viewing.



Setting up TV stations

Favourite programme



- This function lets you select your favourite programmes directly.
- Repeatedly press the **Q.VIEW** button to select stored favourite programmes.

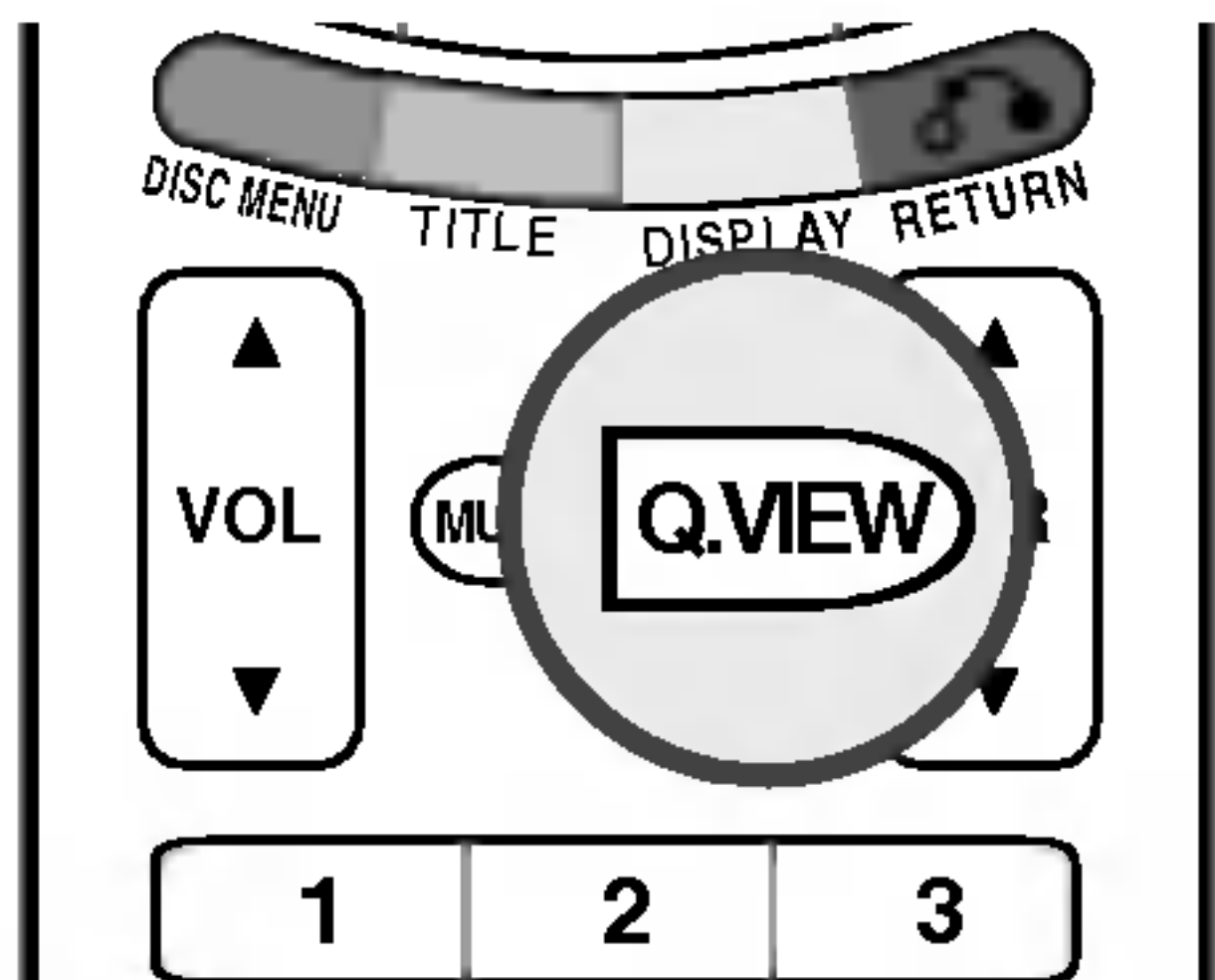

- 1 Press the **MENU** button and then **▲ / ▼** button to select the **Channel** menu.
- 2 Press the **▶** button and then **▲ / ▼** button to select **Favourite programme**.
- 3 Press the **▶** button and then **◀ / ▶** button to select **On** or **Off**.
- 4 Press the **▲ / ▼** button to select -- ----.
- 5 Select a desired programme with the **◀ / ▶** button.
- 6 To store another programme, repeat steps 4 to 5. You can store up to 8 programmes.
- 7 Press the **EXIT** button to return to normal TV viewing.

Calling the programme table

- You can check the programmes stored in the memory by displaying the programme table.

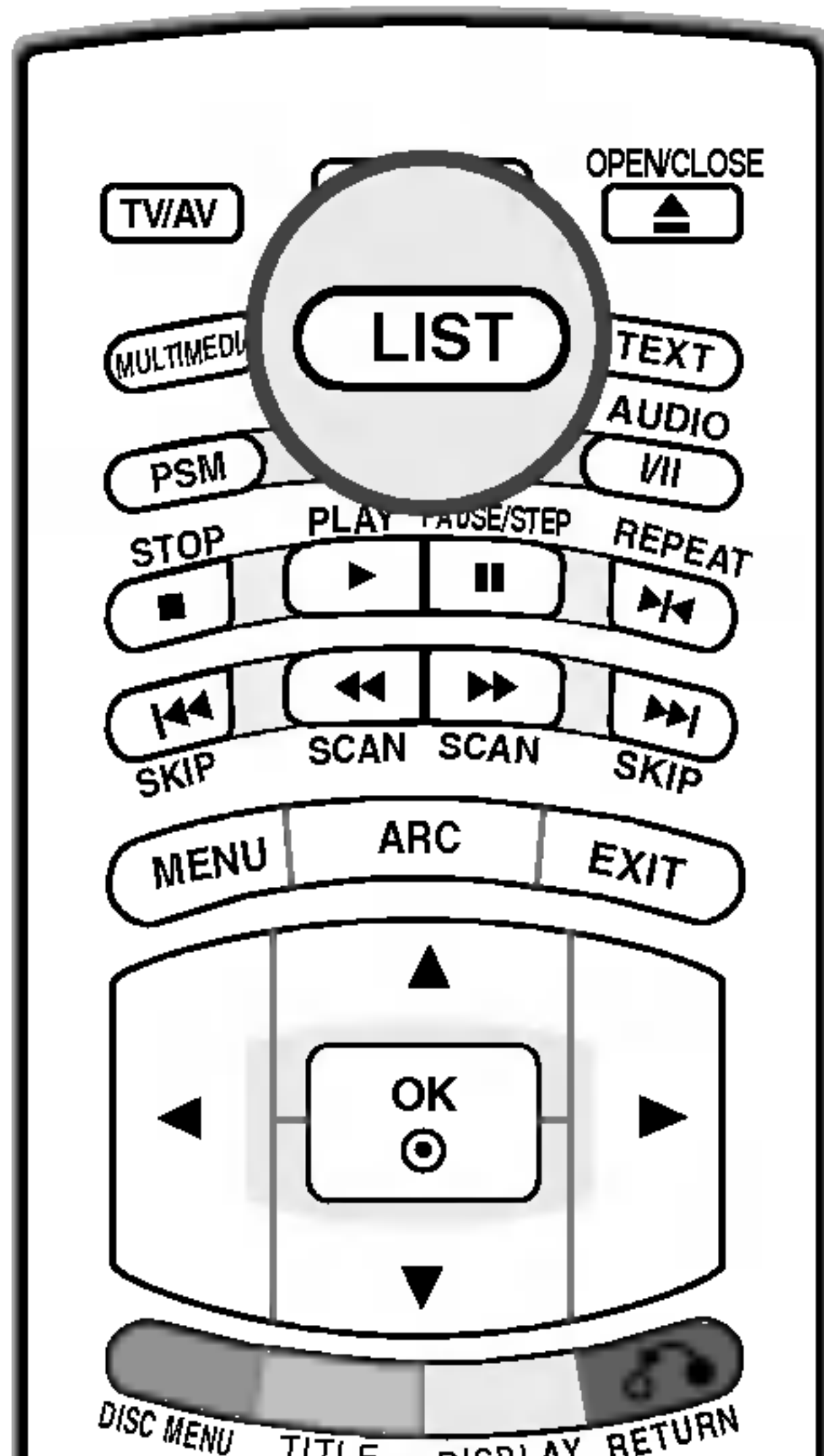

■ Displaying programme table

Press the **LIST** button to display the **Programme table** menu. The programme table appears on the screen. One programme table contains ten programmes as below.

0	C	03	5	S	69
1	BLN	03	6	S	17
2	C	12	7	S	22
3	S	66	8	C	09
4	S	67	9	C	11



Note

- a. You may find some blue programmes. They have been set up to be skipped by auto programming or in the programme edit mode.
- b. Some programmes with the channel number shown in the programme table indicate there is no station name assigned.

■ Selecting a programme in the programme table

Select a programme with the **▲ / ▼ / ◀ / ▶** button. Then press the **OK** button. The set switches to the chosen programme number.

■ Paging through a programme table

There are 10 programme table pages in which contain 100 programmes. Pressing the **▲ / ▼ / ◀ / ▶** button repeatedly turns the pages.

Press the **EXIT** button to return to normal TV viewing.

Picture adjustment

PSM (Picture Status Memory)



- You can also recall a desired picture (**Dynamic, Standard, Mild, Game or User**) with **PSM** button on the remote control. The picture **Dynamic, Standard, Mild and Game** are programmed for optimum picture reproduction at the factory and cannot be changed.

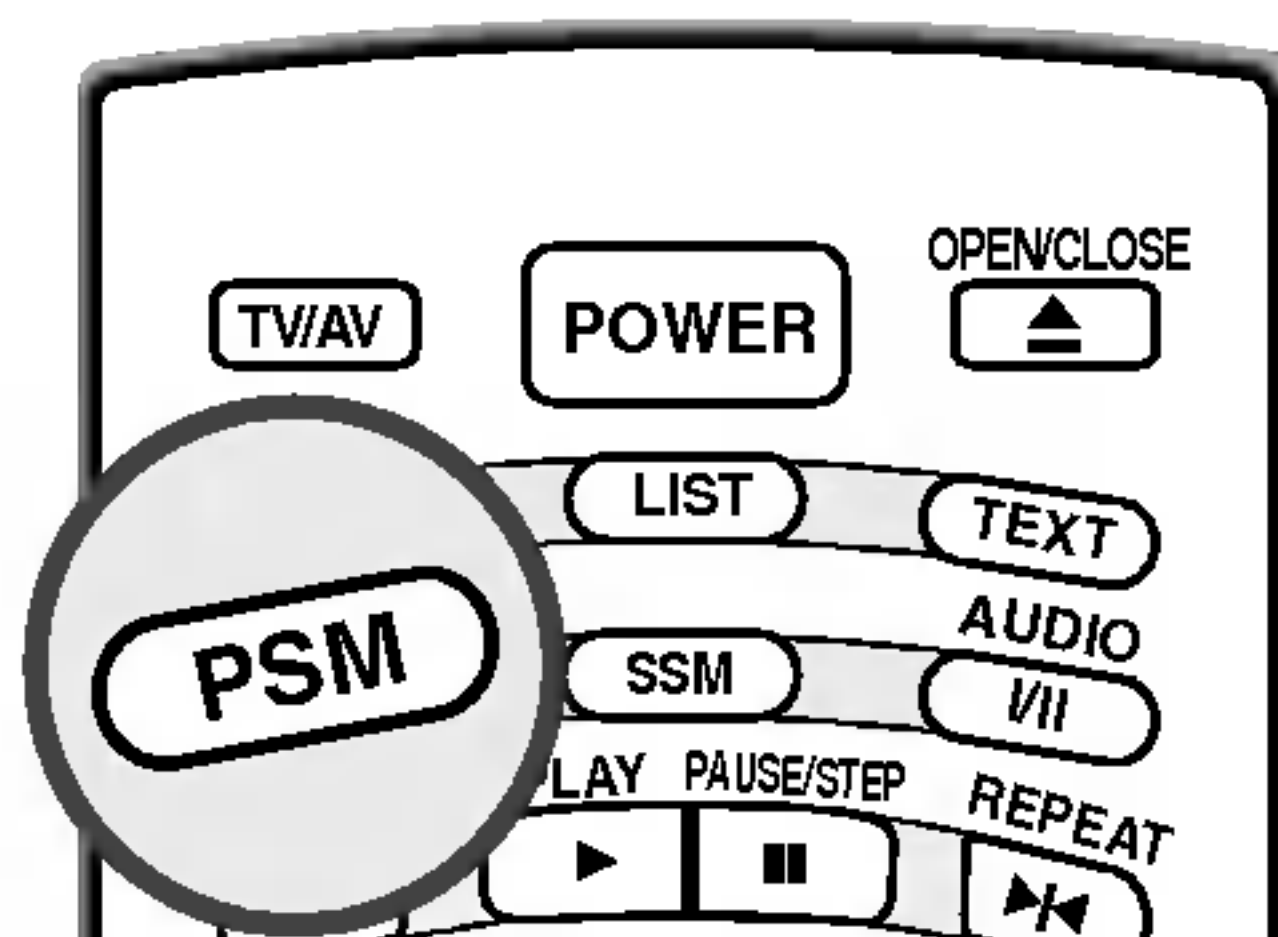

- 1 Press the **MENU** button and then **▲ / ▼** button to select the **Picture** menu.
- 2 Press the **▶** button and then **▲ / ▼** button to select **PSM**.
- 3 Press the **▶** button and then **▲ / ▼** button to select a picture setting on the **PSM** menu.
- 4 Press the **OK** button.
- 5 Press the **EXIT** button to return to normal TV viewing.

Manual Picture adjustment

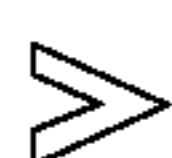
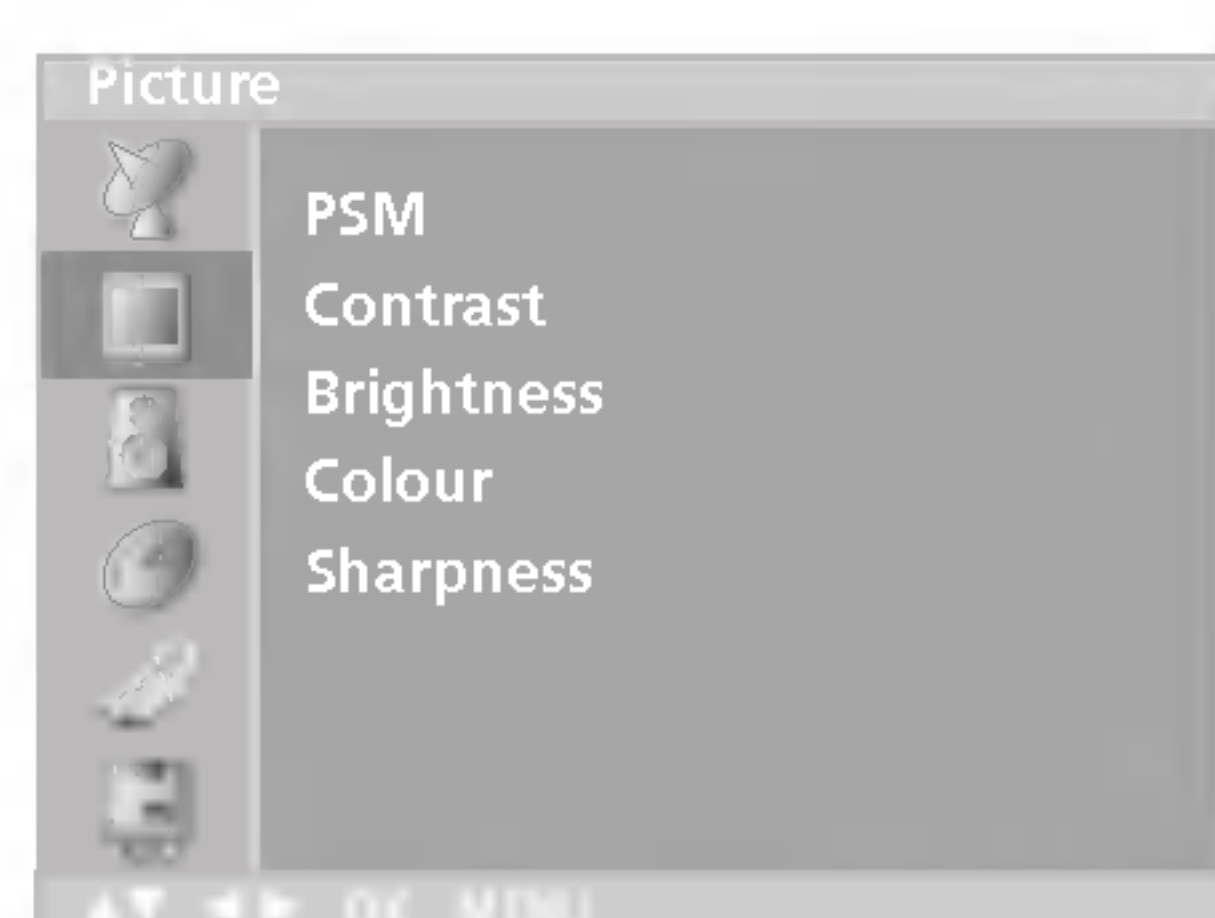

- You can adjust picture contrast, brightness, colour intensity, sharpness to the levels you prefer.

- 1 Press the **MENU** button and then **▲ / ▼** button to select the **Picture** menu.
- 2 Press the **▶** button and then **▲ / ▼** button to select the desired picture item.
- 3 Press the **◀ / ▶** button to make appropriate adjustments.
- 4 Press the **EXIT** button to return to normal TV viewing.



Note

- a. Only **Contrast** and **Brightness** are displayed in PC mode.

Picture adjustment

Picture format (ARC)

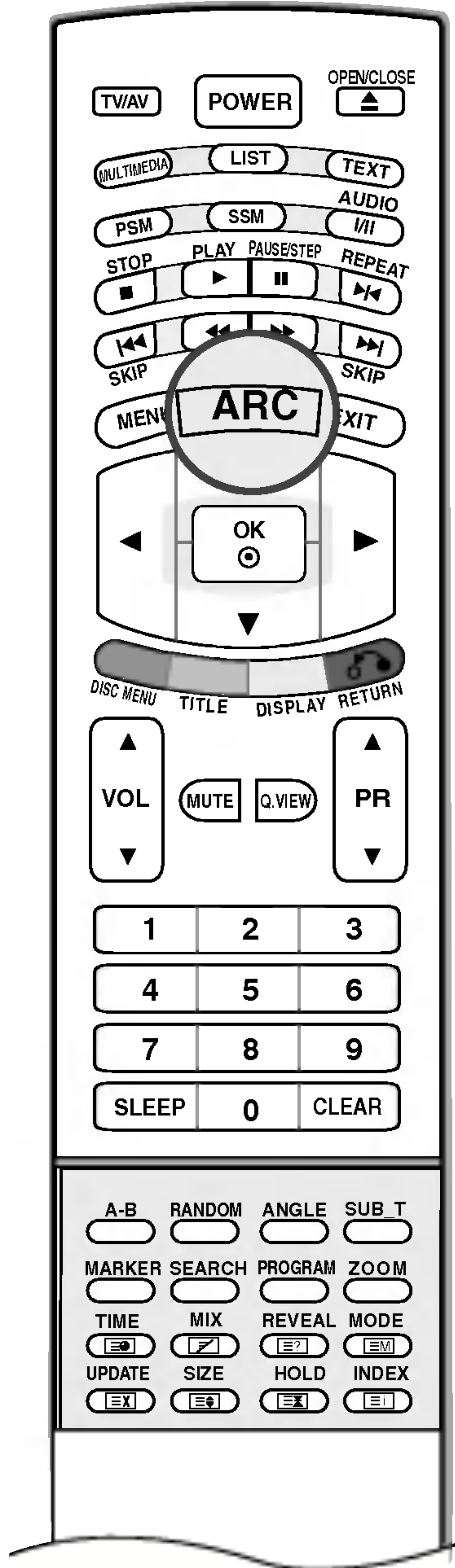

- You can watch TV in various picture formats; **16:9**, **14:9**, **Zoom**, **Spectacle**, **Original**, **4:3**.

Repeatedly press the **ARC** button to select your desired picture format.

16:9

You can enjoy the cinema (the picture format of 16:9) or general TV programme through the 16:9 mode.

The screen 16:9 is viewed just like that but the screen 4:3 is magnified to the left and right so that the screen 16:9 is full.

14:9

You can enjoy the picture format of 14:9 or general TV programme through the 14:9 mode.

The screen 14:9 is viewed just like that the screen 4:3 is magnified to the upper / lower and left / right.

Zoom

You can enjoy the cinema in a vast screen through the Zoom mode.

The screen 4:3 is magnified to the upper / lower and left / right sides so that the screen 16:9 is full. The bottom and top of the picture may be lost.

Spectacle

When your TV receives the wide screen signal, it will lead you to adjust the picture horizontally, in a nonlinear proportion, to fill the entire screen.

Original

When your TV receives the wide screen signal, it will be automatically changed to the picture format to be sent.

4:3

This picture format is 4 to 3 of general TV.



Note

- In **PC** mode only **16:9** and **4:3** aspect ratios are available.
- In **Component** or **DVD** mode, **Spectacle** and **Original** aspect ratios are not available.



Sound adjustment

If you enter the **SSM** button after making appropriate adjustment on the **User** sub menu, the display **User** automatically appears even though you have already set a factory preset setting; **Flat**, **Music**, **Movie** or **Speech**.

SSM (Sound Status Memory)

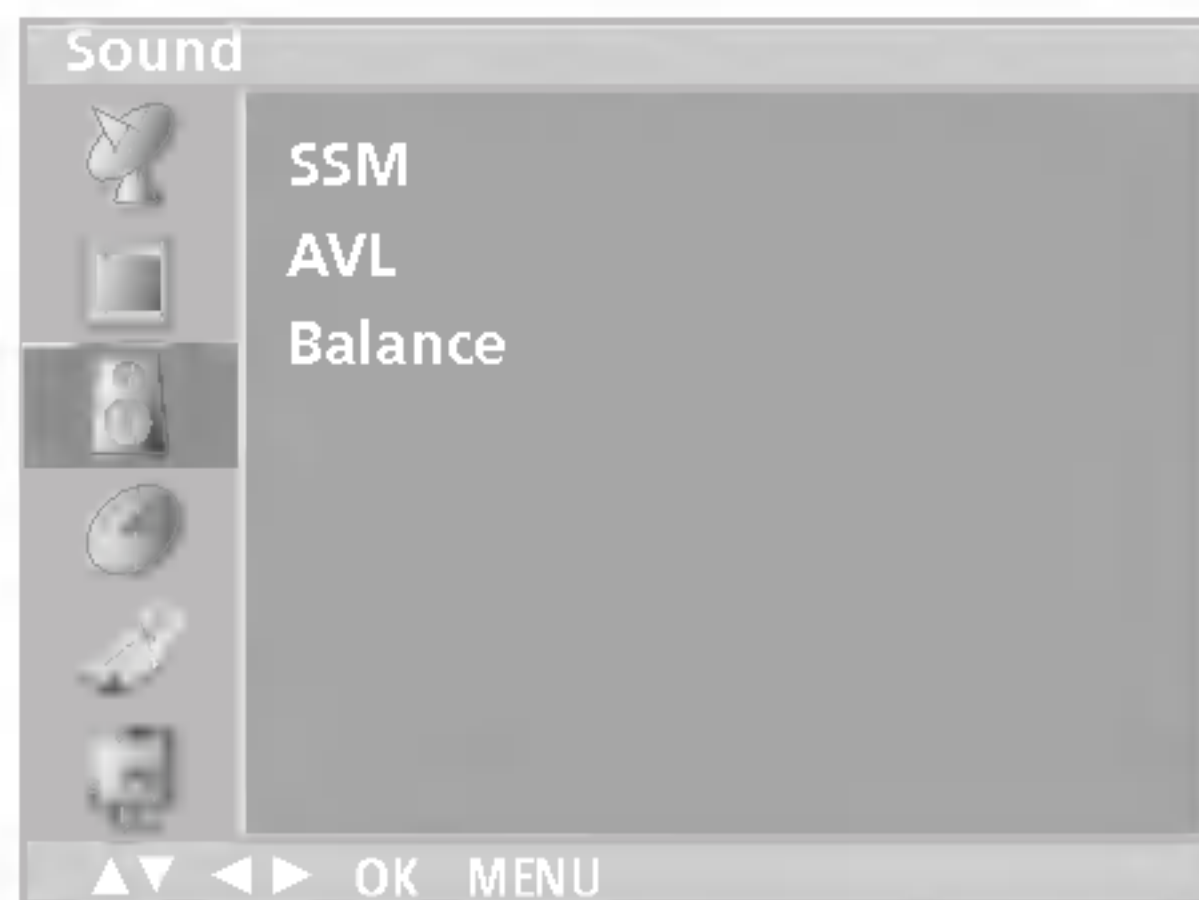

- You can also recall a desired sound setting (**Flat**, **Music**, **Movie**, **Speech** or **User**) with **SSM** button on the remote control. The sound settings **Flat**, **Music**, **Movie** and **Speech** are programmed for optimum sound reproduction at the factory and cannot be changed.

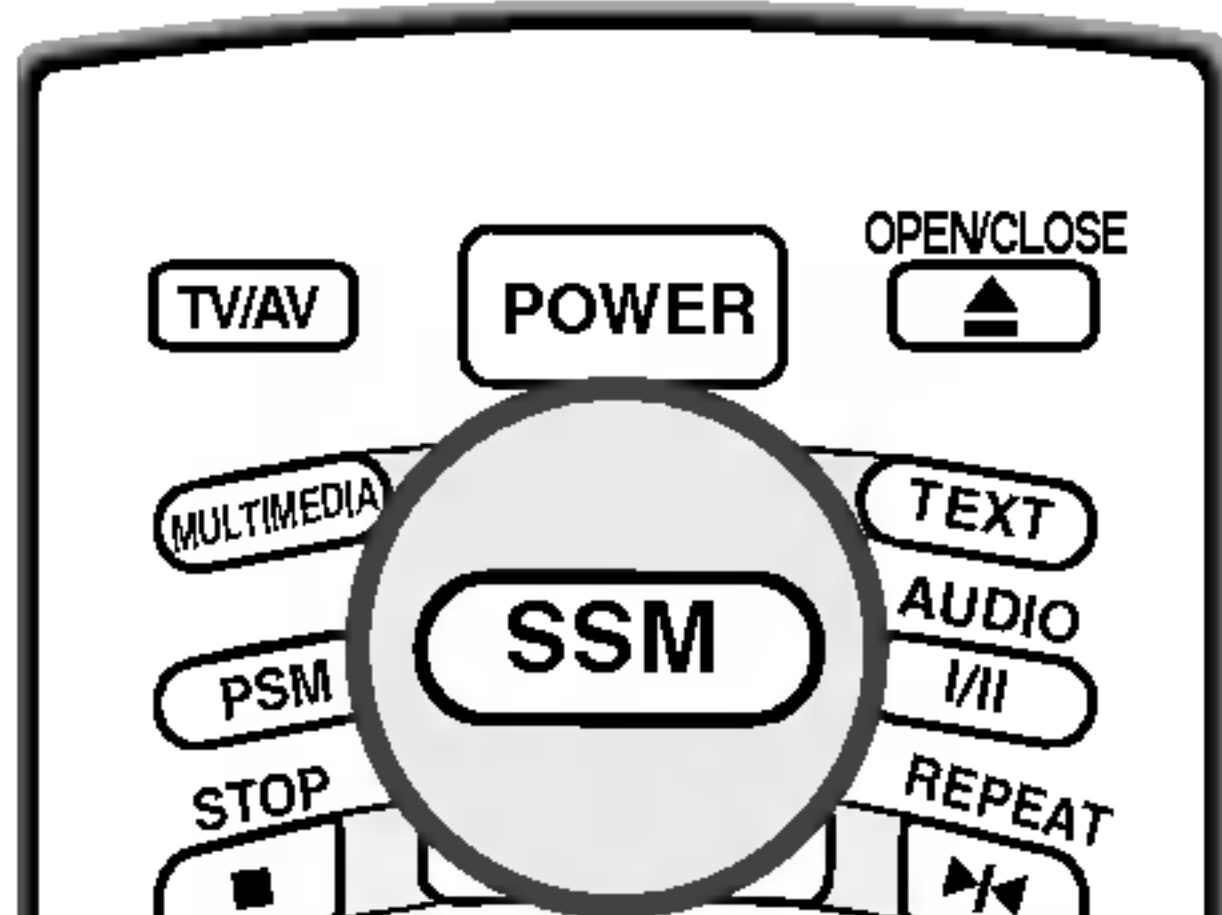

- 1 Press the **MENU** button and then **▲ / ▼** button to select the **Sound** menu.
- 2 Press the **▶** button and then **▲ / ▼** button to select **SSM**.
- 3 Press the **▶** button and then use the **▲ / ▼** button to select the appropriate sound option;
Flat, **Music**, **Movie**, **Speech**.
- 4 Press the **OK** button to save.
- 5 Press the **EXIT** button to return to normal TV viewing.

Equalizer Adjustments

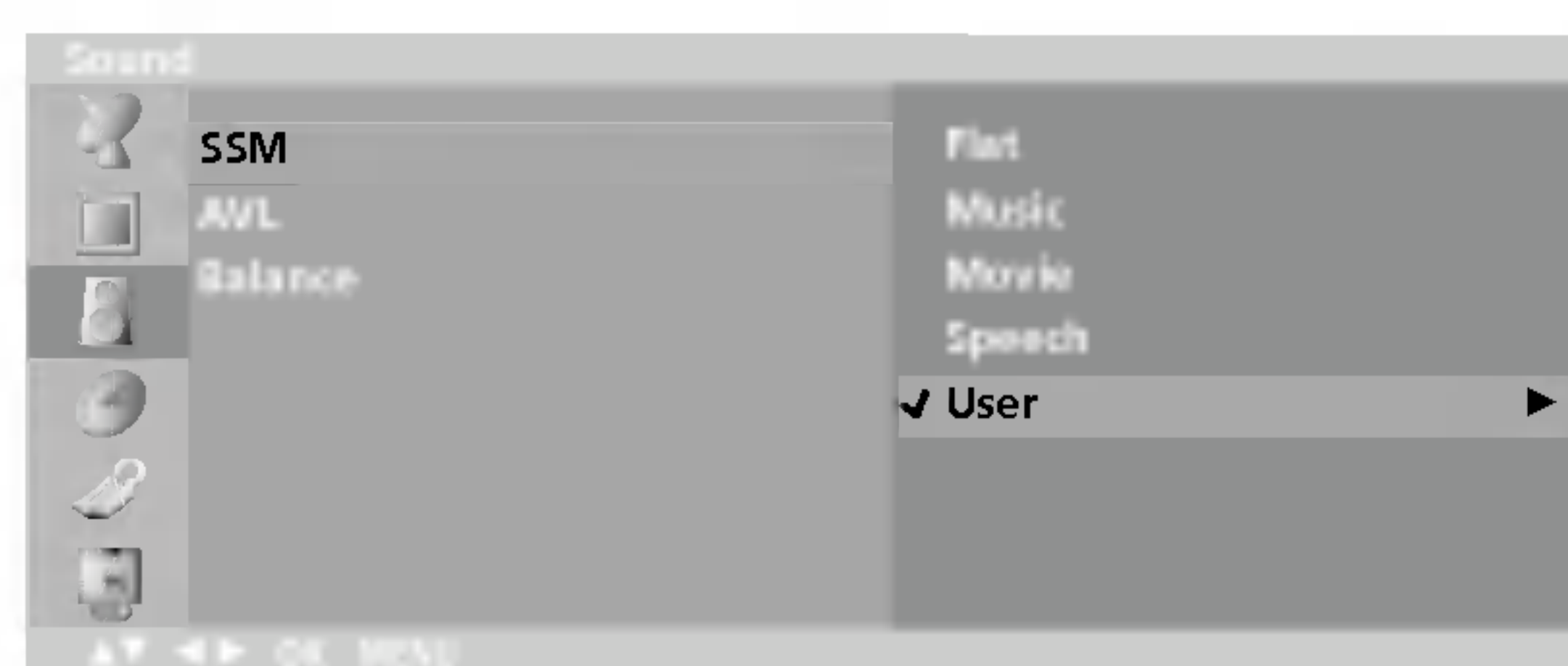

- 1 Press the **MENU** button and then **▲ / ▼** button to select the **Sound** menu.
- 2 Press the **▶** button and then **▲ / ▼** button to select **SSM**.
- 3 Press the **▶** button and then use the **▲ / ▼** button to select **User**.
- 4 Press the **▶** button and then use the **◀ / ▶** button to select the band you want to adjust. Then, use the **▲ / ▼** button to adjust the band level.
- 5 Press the **OK** button to save.
- 6 Press the **EXIT** button to return to normal TV viewing.



Sound adjustment

AVL (Auto Volume Leveler)

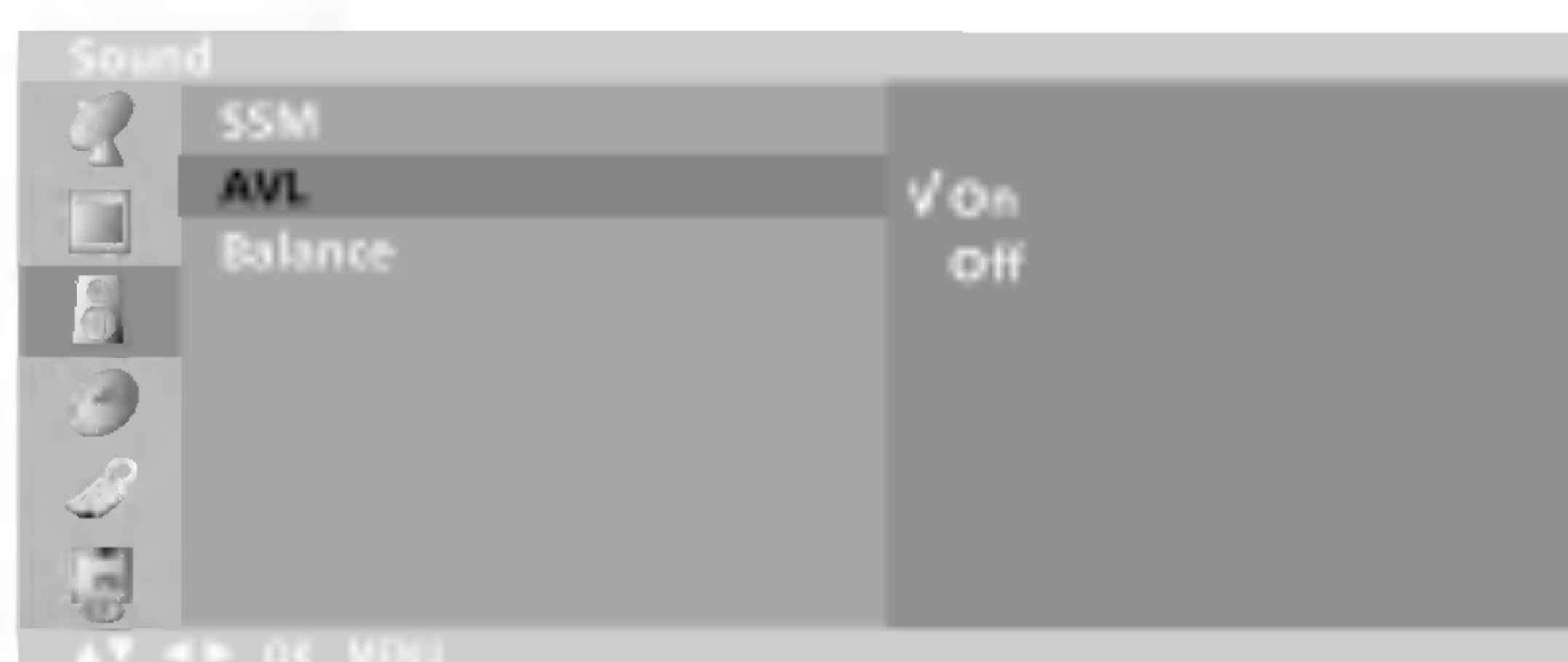
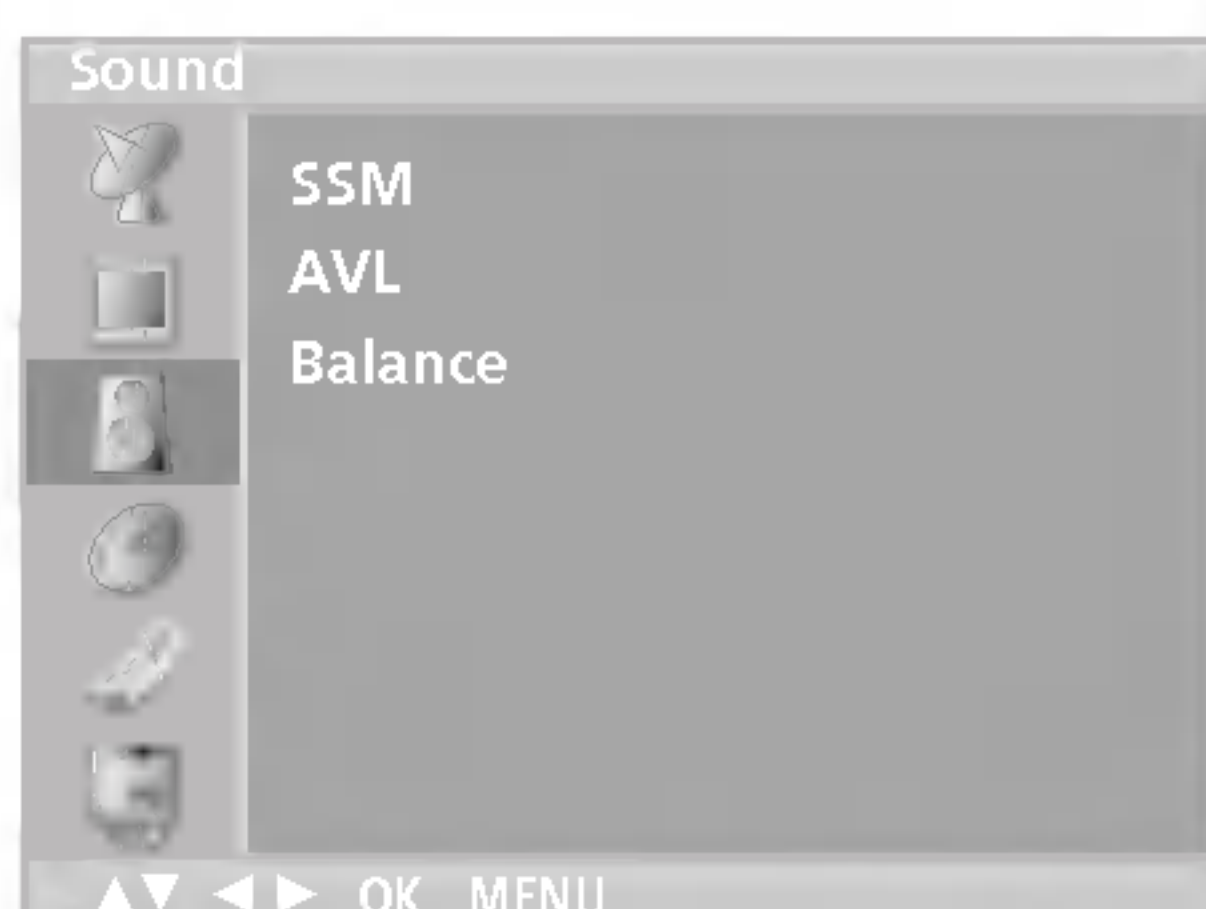

- AVL (Auto Volume Leveler) maintains an equal volume level automatically even if the programme is changed.

- 1 Press the **MENU** button and then **▲ / ▼** button to select the **Sound** menu.
- 2 Press the **▶** button and then **▲ / ▼** button to select **AVL**.
- 3 Press the **▶** button and then use the **▲ / ▼** button to select **On** or **Off**.
- 4 Press the **OK** button to save.
- 5 Press the **EXIT** button to return to normal TV viewing.

Sound Balance



- 1 Press the **MENU** button and then **▲ / ▼** button to select the **Sound** menu.
- 2 Press the **▶** button and then **▲ / ▼** button to select **Balance**.
- 3 Press the **▶** button and then use the **◀ / ▶** button to adjust the sound balance.
 - Balance is adjustable from Left 50 to Right 50.
- 4 Press the **OK** button to save.
- 5 Press the **EXIT** button to return to normal TV viewing.

I/II

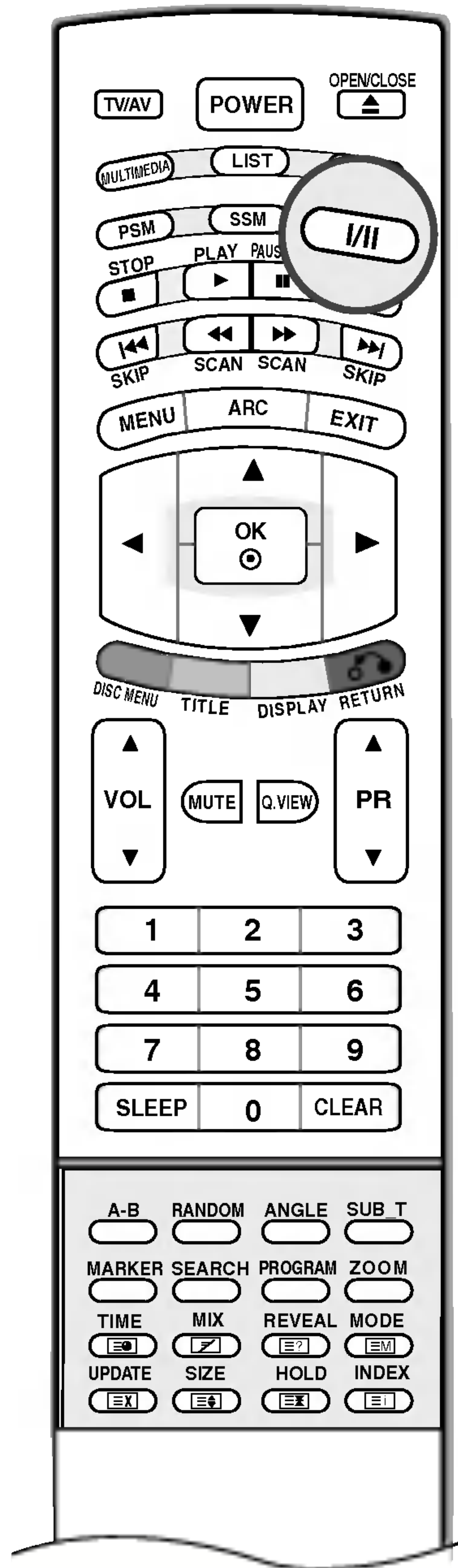

■ Stereo/Dual reception

When a programme is selected, the sound information for the station appears after the programme number and station name disappear.

Broadcast	On Screen Display
Mono	MONO
Stereo	STEREO
Dual	DUAL I

• Mono sound selection

In stereo reception if the stereo signal is weak, you can switch to mono by pressing the I/II button twice. In mono reception the depth of sound is improved. To switch back to stereo, press the I/II button twice again.

• Language selection for dual language broadcast

If a programme is received in two languages (dual language), you can switch to **DUAL I**, **DUAL II** or **DUAL I+II** by pressing the I/II button repeatedly. **DUAL I** sends the primary broadcast language to the loudspeakers. **DUAL II** sends the secondary broadcast language to the loud-speakers. **DUAL I+II** sends a separate language to each loudspeaker.

■ NICAM reception (option)

If your set is equipped with the receiver for NICAM reception, the high quality NICAM (Near Instantaneous Companding Audio Multiplex) digital sound can be received.

Sound output can be selected according to the type of received broadcast as follows by pressing the I/II button repeatedly.

1. When **NICAM mono** is received, you can select **NICAM MONO** or **FM MONO**.
2. When **NICAM stereo** is received, you can select **NICAM STEREO** or **FM MONO**. If the stereo signal is weak, switch to **FM mono**.
3. When **NICAM dual** is received, you can select **NICAM DUAL I**, **NICAM DUAL II** or **NICAM DUAL I+II** or **MONO**. When **FM mono** is selected the display **MONO** appears on the screen.

■ Sound output selection

In AV mode, you can select output sound for the left and right loud-speakers. Repeatedly press the I/II button to select the sound output.

L+R : Audio signal from audio L input is sent to left loud-speaker and audio signal from audio R input is sent to right loud-speaker.

L+L : Audio signal from audio L input is sent to left and right loud-speakers.

R+R : Audio signal from audio R input is sent to left and right loud-speakers.

Time menu

Time

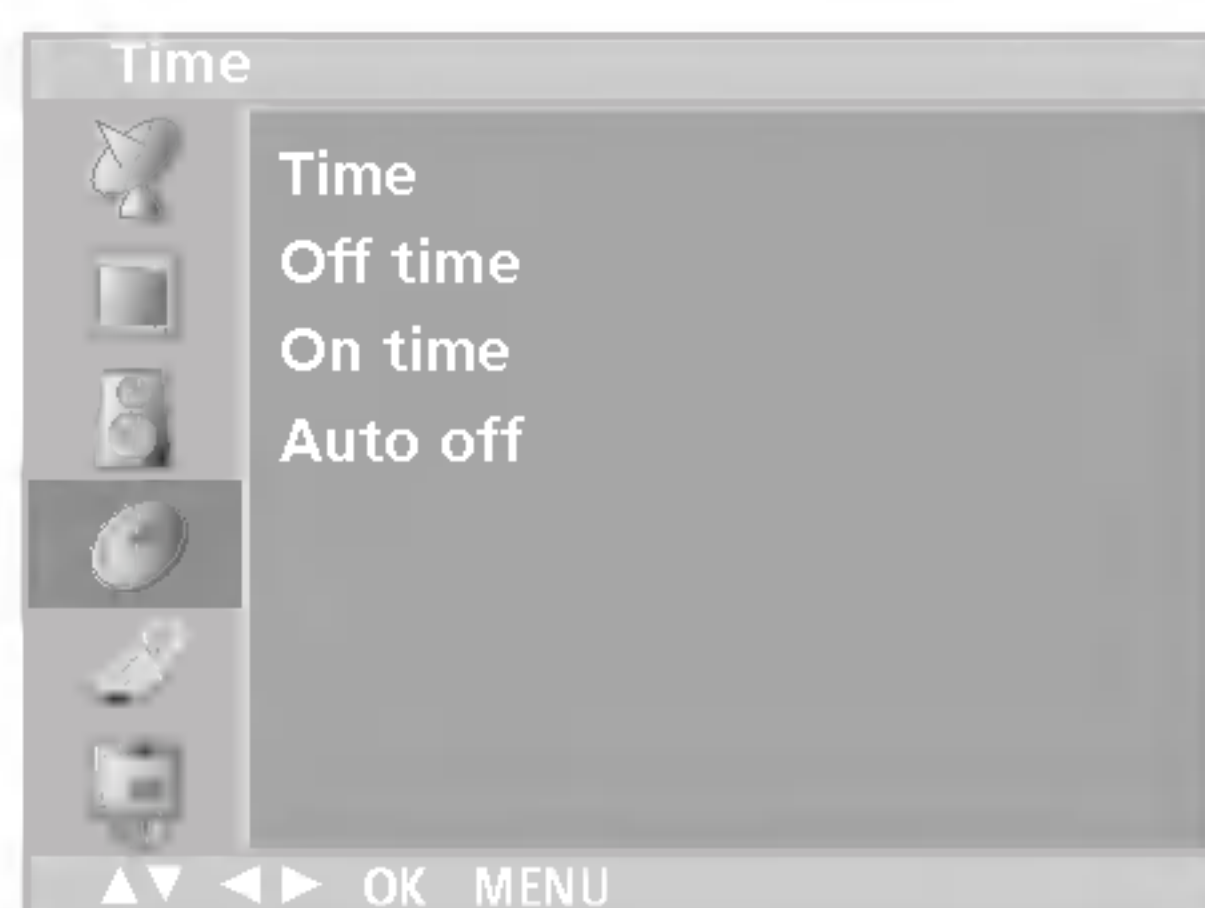

- You must set the time correctly before using on/off time function.

- 1 Press the **MENU** button and then **▲ / ▼** button to select the **TIME** menu.
- 2 Press the **▶** button and then **▲ / ▼** button to select **TIME**.
- 3 Press the **▶** button and then **▲ / ▼** button to adjust the hour.
- 4 Press the **▶** button and then **▲ / ▼** button to adjust the minute.
- 5 Press the **OK** button to save.
- 6 Press the **EXIT** button to return to normal TV viewing.

On/Off Time

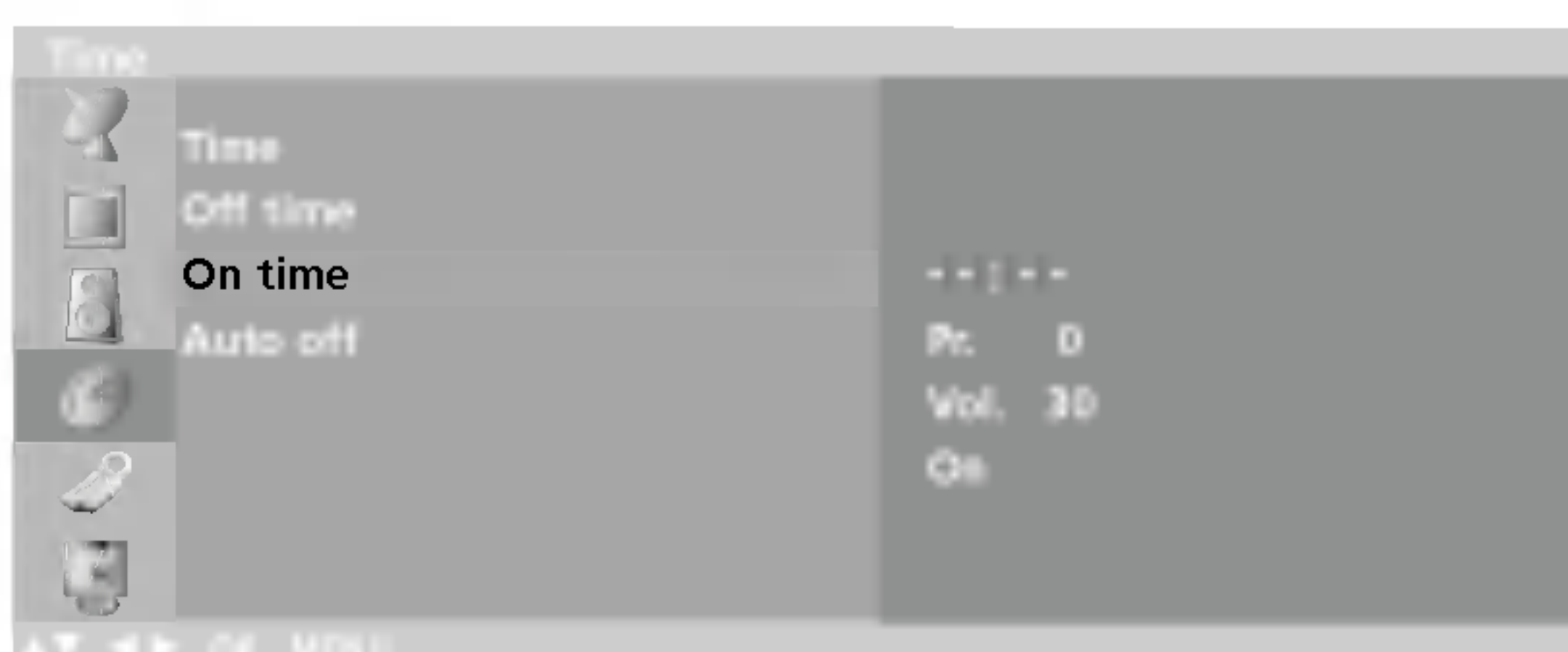

- The off timer automatically switches the set to standby at the preset time.

- 1 Press the **MENU** button and then **▲ / ▼** button to select the **TIME** menu.
- 2 Press the **▶** button and then **▲ / ▼** button to select **Off time** or **On time**.
- 3 Press the **▶** button and then **▲ / ▼** button to select **On**.
To cancel **On/Off time** function, press the **▲ / ▼** button to select **Off**.
- 4 Press the **▶** button and then **▲ / ▼** button to adjust the hour.
- 5 Press the **▶** button and then **▲ / ▼** button to adjust the minute.
- 6 **Only On time function**; Press the **▶** button and then **▲ / ▼** button to adjust volume level and programme number.
- 7 Press the **OK** button to save.
- 8 Press the **EXIT** button to return to normal TV viewing.



Note

- a. In the event of power interruption (disconnection or power failure), the clock must be reset.
- b. Two hours after the set is switched on by the on time function it will automatically switch back to standby mode unless a button has been pressed.
- c. Once the **On** or **Off Time** is set, these functions operate daily at the preset time.
- d. **Off Time** function overrides **On Time** function if they are set to the same time.
- e. The set must be in standby mode for the **On Time** to work.

Auto off



- If you select **On** on the **Auto off** menu, the set will automatically switch itself to standby mode approximately ten minutes after a TV station stops broadcasting.
- In the **Component**, **DVD**, or **PC** mode, **Auto off** is not available.

- 1 Press the **MENU** button and then **▲** / **▼** button to select the **TIME** menu.
- 2 Press the **▶** button and then **▲** / **▼** button to select **Auto off**.
- 3 Press the **▶** button and then **▲** / **▼** button to select **On** or **Off**.
- 4 Press the **EXIT** button to return to normal TV viewing.

Sleep timer

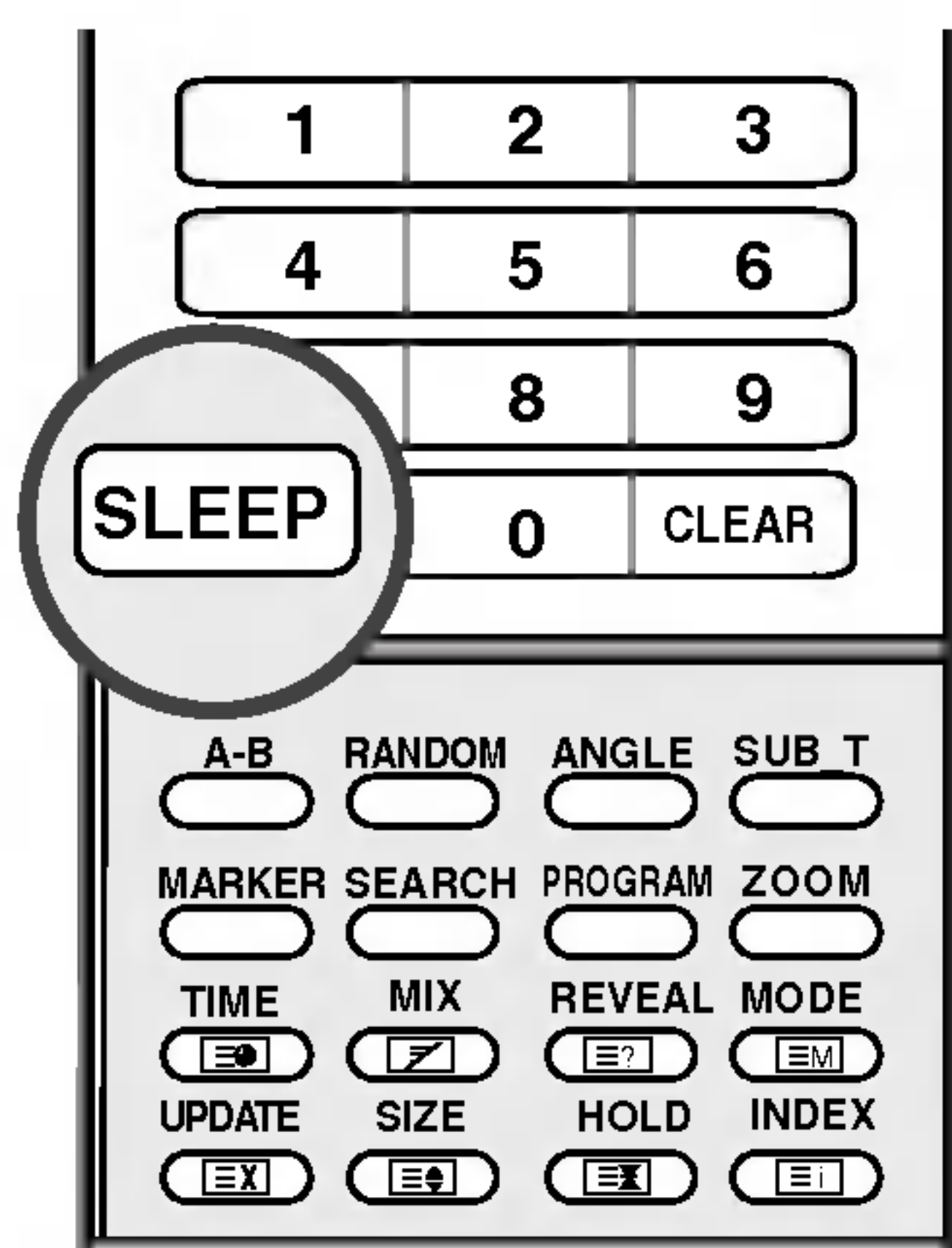

- 1 Press the **SLEEP** button repeatedly to select the number of minutes. First the **zz off** option appears on the screen, followed by the following sleep timer options: 10, 20, 30, 60, 90, 120, 180, and 240 minutes.
- 2 The timer begins to count down from the number of minutes selected.
- 3 To check the remaining minutes before the TV turns off, press the **SLEEP** button once.
- 4 To cancel the Sleep Timer, press the **SLEEP** button repeatedly until **zz off** appears.



Note

- a. To view the remaining sleep time, press the **SLEEP** button once.
- b. When you switch the set off, the set releases the preset sleep time.

Setup menu

Input source



- Inputs can be set for **TV, AV, DVD** or **PC** mode. AV mode is used when a video cassette recorder (VCR), or other equipment is connected to the set.
- Alternatively you can select the TV or AV mode by pressing the **TV/AV** button.
- In **AV, Component, or PC** mode, to return to TV mode, press the **PR ▲ / ▼** or **NUMBER** buttons.

- 1** Press the **MENU** button and then **▲ / ▼** button to select the **Setup** menu.
- 2** Press the **▶** button and then **▲ / ▼** button to select **Input**.
- 3** Press the **▶** button and then use the **▲ / ▼** button to select **TV, AV1, AV2, S-video, DVD, Component, or PC**
- 4** Press the **EXIT** button to return to normal TV viewing.

Auto AV switching

- If your VCR outputs an AV switching voltage when connected to the Euro scart socket, the set will switch to **AV1** or **AV2** mode automatically. But if you want to keep on watching TV mode, press the **PR ▲ / ▼** or **NUMBER** buttons. Press the **TV/AV** button to return to AV modes.

Child lock

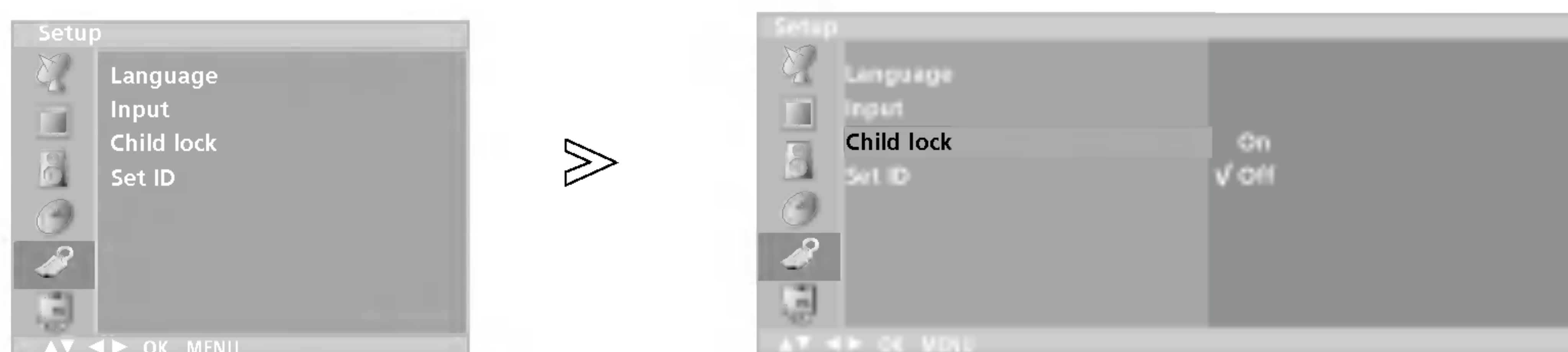

- The TV can be set so that the remote control handset is needed to control it. This feature can be used to prevent unauthorized viewing.

- With the lock on, the display **Child lock** appears on the screen if any button on the side panel is pressed while viewing the TV.

1 Press the **MENU** button and then **▲ / ▼** button to select the **Setup** menu.

2 Press the **▶** button and then **▲ / ▼** button to select **Child lock**.

3 Press the **▶** button and then **▲ / ▼** button to select **On** or **Off** on the **Child lock** menu.

4 Press the **EXIT** button to return to normal TV viewing.



Note

- The display **Child lock** will not appear on the screen if any button on the panel is pressed while displaying the menus.



PC menu

After setup, be sure to select **PC** source to see the PC image the on TV screen.

Auto Configure

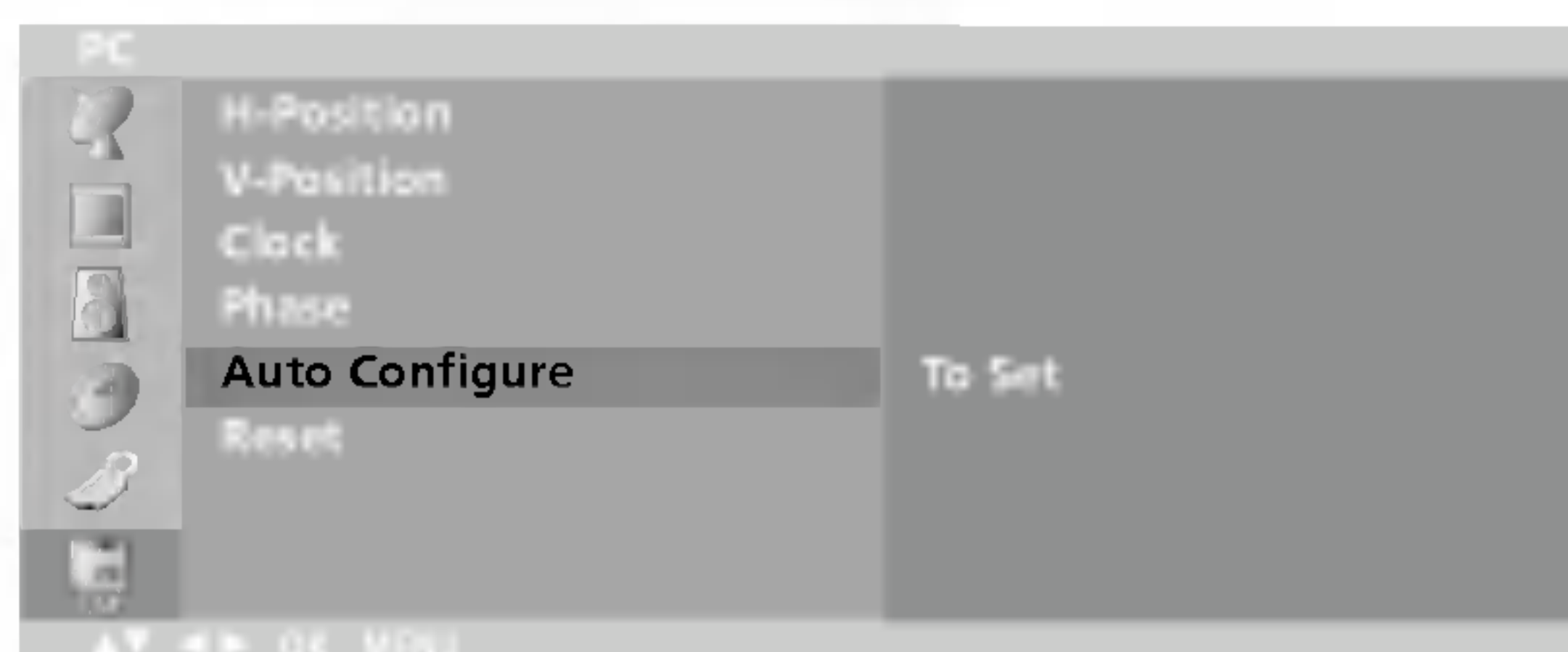

- Automatically adjusts the screen position, clock, and phase. (The displayed image will disappear for a few seconds while Auto-configuration is in progress.)

- 1 Press the **MENU** button and then use the **▲ / ▼** button to select the **PC** menu.
- 2 Press the **▶** button and then use the **▲ / ▼** button to select **Auto Configure**.
- 3 Press the **▶** button to start **Auto Configure**.
- 4 Press the **EXIT** button to return to normal TV viewing.

H-Position / V-Position

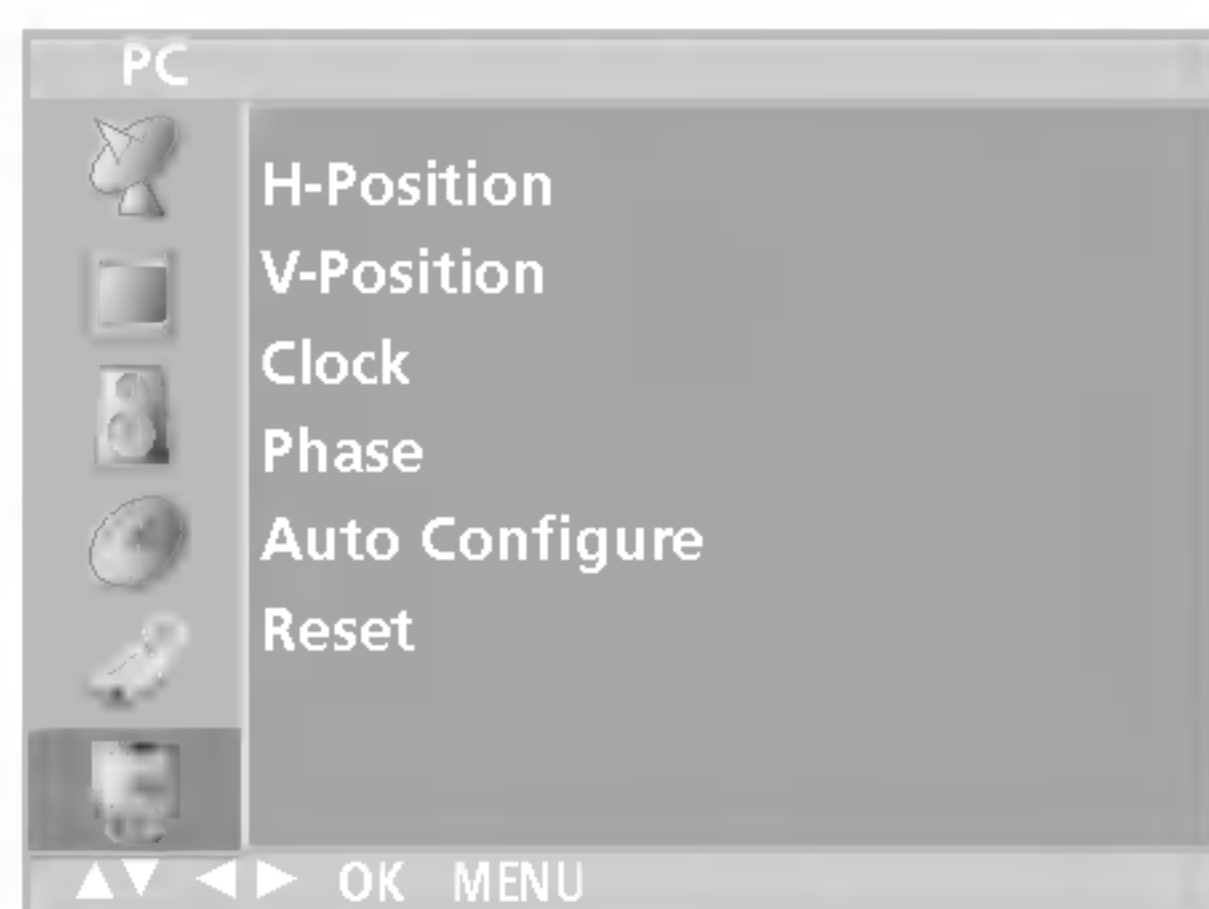

• **H position / V Position**
This function is to adjust picture to left/right and up/down as you prefer.

- 1 Press the **MENU** button and then use the **▲ / ▼** button to select the **PC** menu.
- 2 Press the **▶** button and then use the **▲ / ▼** button to select **H-Position** or **V-Position**.
- 3 Use the **◀ / ▶** button to make appropriate adjustments.
- 4 Press the **EXIT** button to return to normal TV viewing.

Clock / Phase

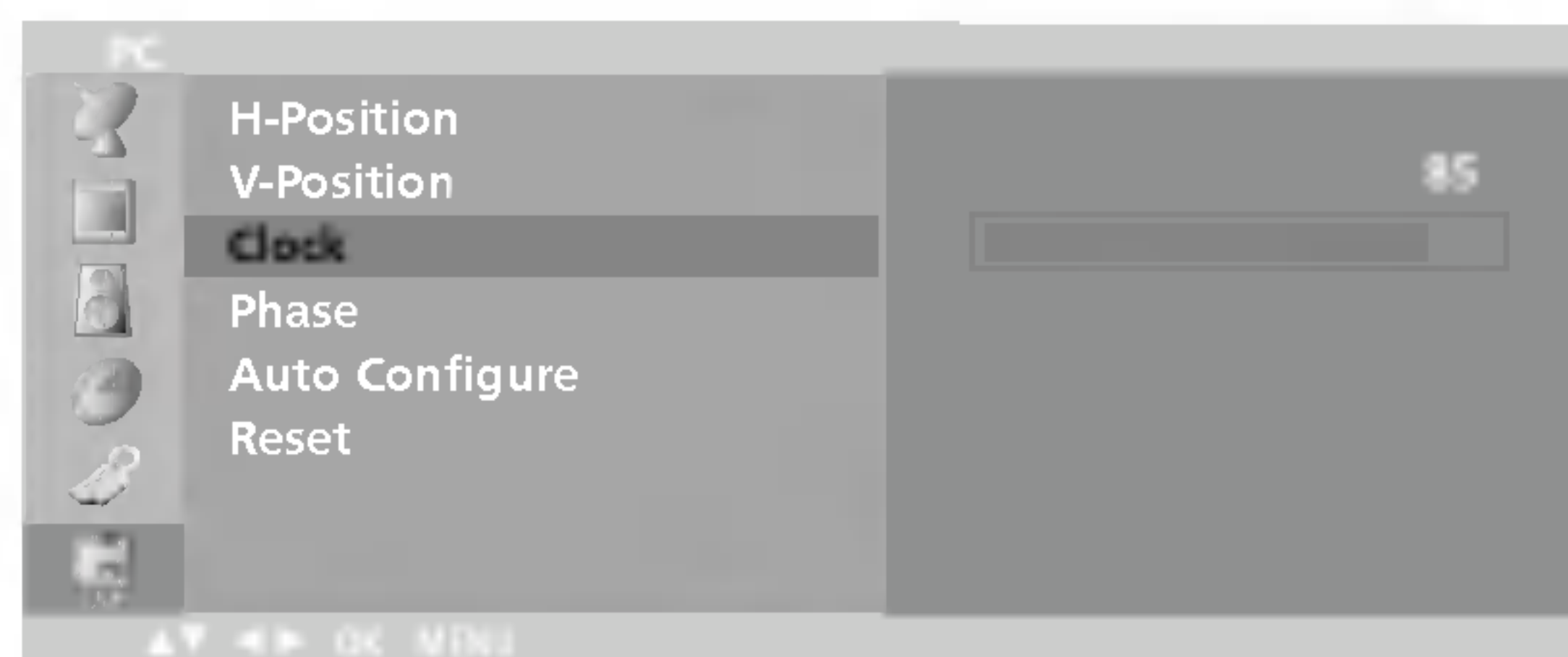

• Clock

This function is to minimize any vertical bars or stripes visible on the screen background. And the horizontal screen size will also change.

• Phase

This function allows you to remove any horizontal noise and clear or sharpen the image of characters.

- 1 Press the **MENU** button and then use the **▲ / ▼** button to select the **PC** menu.
- 2 Press the **▶** button and then use the **▲ / ▼** button to select **Clock** or **Phase**.
- 3 Use the **◀ / ▶** button to make appropriate adjustments.
- 4 Press the **OK** button to save.
- 5 Press the **EXIT** button to return to normal TV viewing.

Reset

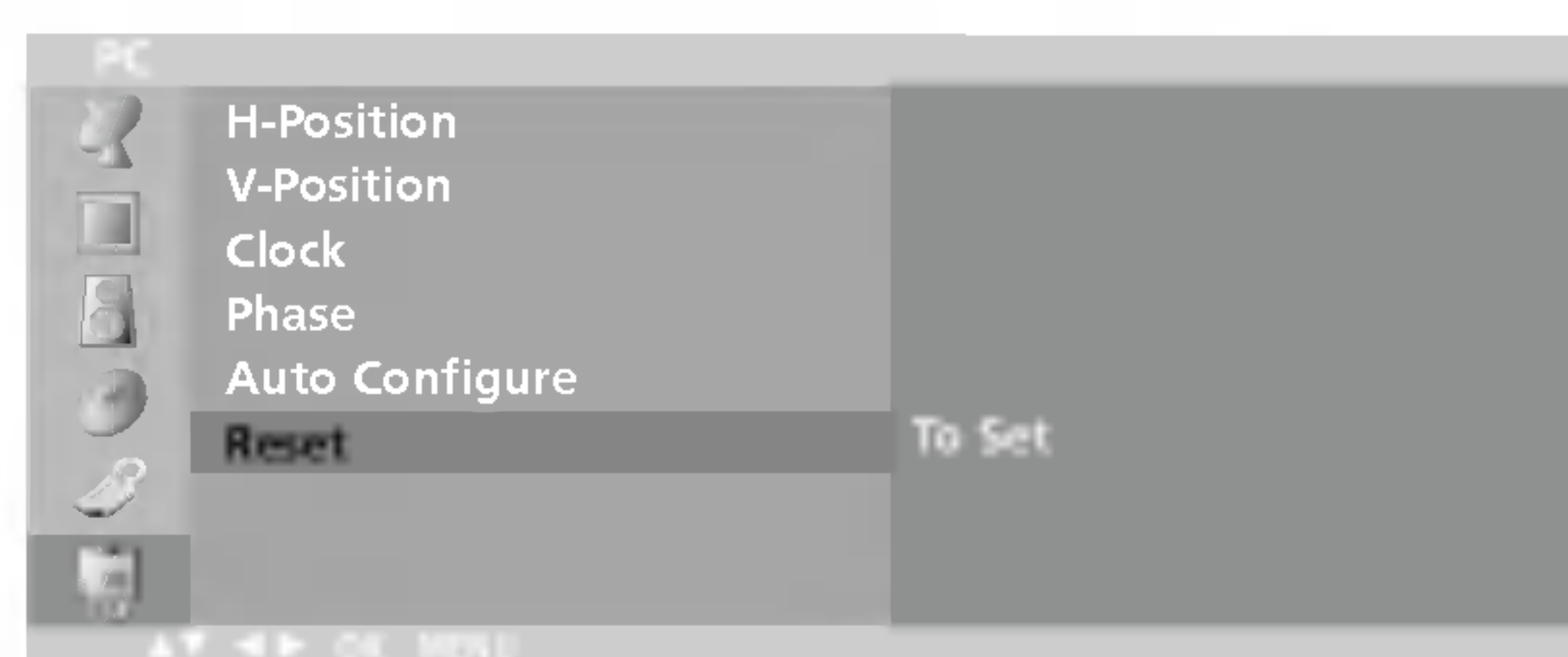
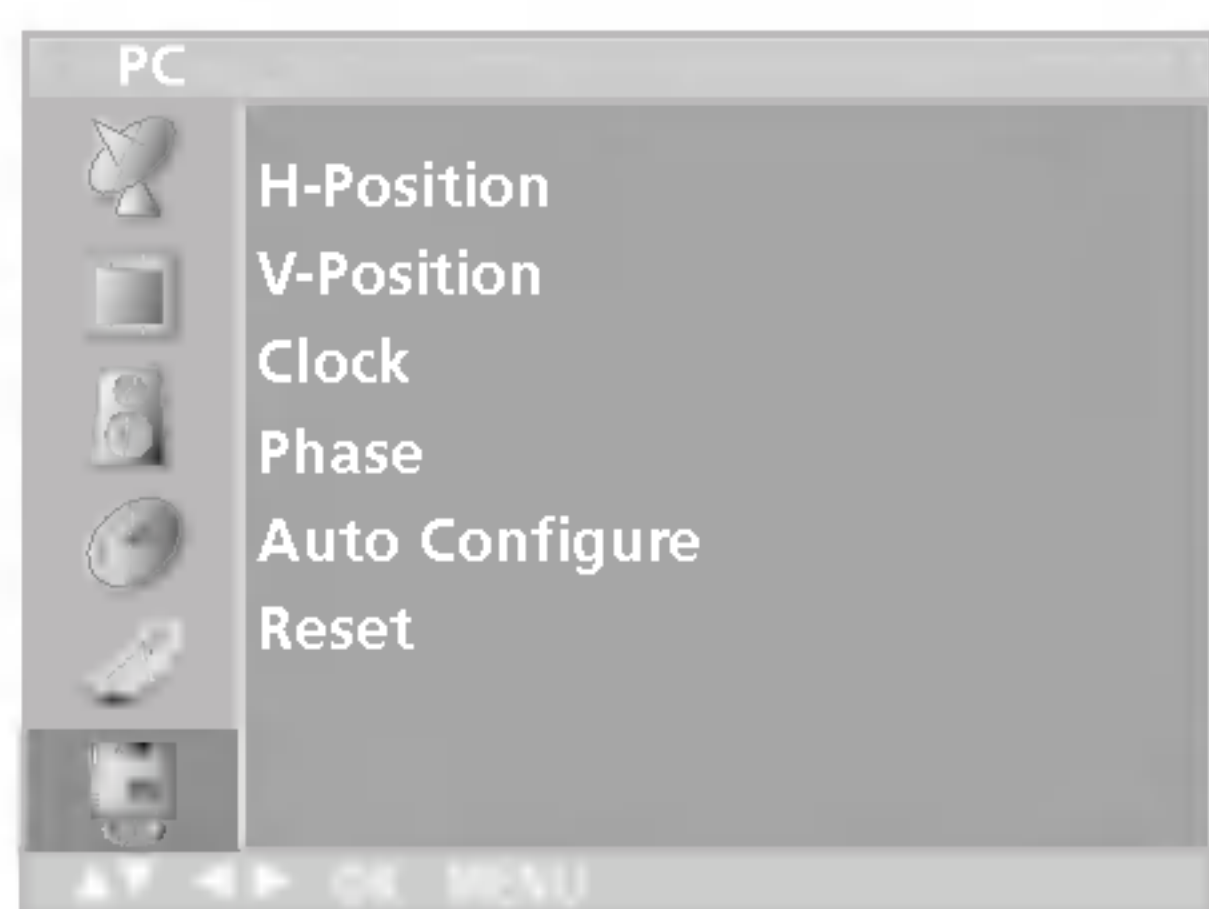

- Returns to the default settings programmed at the factory; default settings cannot be changed.

- 1 Press the **MENU** button and then use the **▲ / ▼** button to select the **PC** menu.
- 2 Press the **▶** button and then use the **▲ / ▼** button to select **Reset**.
- 3 Press the **▶** button to start **Reset**.
- 4 Press the **EXIT** button to return to normal TV viewing.

Teletext

Teletext (or TOP text) is an optional function, therefore only a set with the teletext system can receive the teletext broadcast.

Teletext is a free service broadcast by most TV stations which gives up-to-the-minute information on news, weather, television programmes, share prices and many other topics.

The teletext decoder of this TV can support the SIMPLE, TOP and FASTEXT systems. SIMPLE (standard teletext) consists of a number of pages which are selected by directly entering the corresponding page number. TOP and FASTEXT are more modern methods allowing quick and easy selection of teletext information.

Switch on/off

Press the **TEXT** button to switch to teletext. The initial page or last page appears on the screen.

Two page numbers, TV station name, date and time are displayed on the screen headline. The first page number indicates your selection, while the second shows the current page displayed.

Press the **TEXT** button to switch off teletext. The previous mode reappears.

SIMPLE text

■ Page selection

1. Enter the desired page number as a three digit number with the NUMBER buttons. If during selection you press a wrong number, you must complete the three digit number and then reenter the correct page number.
2. The ▲ / ▼ buttons can be used to select the preceding or following page.

■ Programming a colour button in LIST mode

If the TV is in SIMPLE text, TOP text or FASTEXT mode, press the **EM** button to switch to LIST mode.

Four teletext page numbers of your choice can be colour coded and easily selected by pressing the corresponding coloured button on the remote control handset.

1. Press a coloured button.
2. Using the NUMBER buttons, select the page you wish to programme.
3. Press the **OK** button. Then the selected page is stored as the selected page number by blinking once. From now on, you can select this page with the same coloured button.
4. The three other coloured buttons are programmed in this way.

TOP text (option)

The user guide displays four fields-red, green, yellow and blue at the bottom of the screen. The yellow field denotes the next group and the blue field indicates the next block.

■ Block / group / page selection

1. With the blue button you can progress from block to block.
2. Use the yellow button to proceed to the next group with automatic overflow to the next block.
3. With the green button you can proceed to the next existing page with automatic overflow to the next group. Alternatively the ▲ button can be used.
4. The red button permits to return to previous selection.
Alternatively the ▼ button can be used.

■ Direct page selection

Corresponding to the SIMPLE teletext mode, you can select a page by entering it as a three digit number using the NUMBER buttons in TOP mode.

FASTEXT

The teletext pages are colour coded along the bottom of the screen and are selected by pressing the corresponding coloured button.

■ Page selection

1. Press the  button to select the index page.
2. You can select the pages which are colour coded along the bottom line with the same coloured buttons.
3. Corresponding to the SIMPLE teletext mode, you can select a page by entering its three digit page number with the NUMBER buttons in FASTEXT mode.
4. The ▲ / ▼ buttons can be used to select the preceding or following.

Special teletext functions



REVEAL

Press this button to display concealed information, such as solutions of riddles or puzzles.
Press this button again to remove the information from the display.

SIZE

Selects double height text.
Press this button to enlarge the top half of the page.
Press this button again to enlarge the bottom half of the page.
Press this button again to return to the normal display.

UPDATE

Displays the TV picture on the screen while waiting for the new teletext page. The display  will appear at the top left hand corner of the screen. When the updated page is available then display  will change to the page number.

Press this button to view the updated teletext page.

HOLD

Stops the automatic page change which will occur if a teletext page consists of 2 or more sub pages. The number of sub pages and the sub page displayed is, usually, shown on the screen below the time. When this button is pressed the stop symbol is displayed at the top left-hand corner of the screen and the automatic page change is inhibited.
To continue press this button again.

MIX

Displays the teletext pages superimposed on the TV picture.
To switch the TV picture off press this button again.









TIME

When viewing a TV programme, press this button to display the time at the top right hand corner of the screen. Press this button again to remove the display. In the teletext mode, press this button to select a sub page number. The sub page number is displayed at the bottom of the screen. To hold or change the sub page, press the RED/GREEN, ▲ / ▼ or NUMBER buttons.
Press again to exit this function.

DVD operation

Notes on Discs

Symbol Used in this Manual

-  DVD and finalized DVD±R/RW
-  Video CDs
-  Audio CDs
-  MP3 Discs
-  WMA Discs
-  JPEG Discs
-  DivX Discs
-  may appear on your TV display during operation and indicates that the function explained in this owner's manual is not available on that specific DVD video disc.

On handling discs

- Do not touch the playback side of the disc.

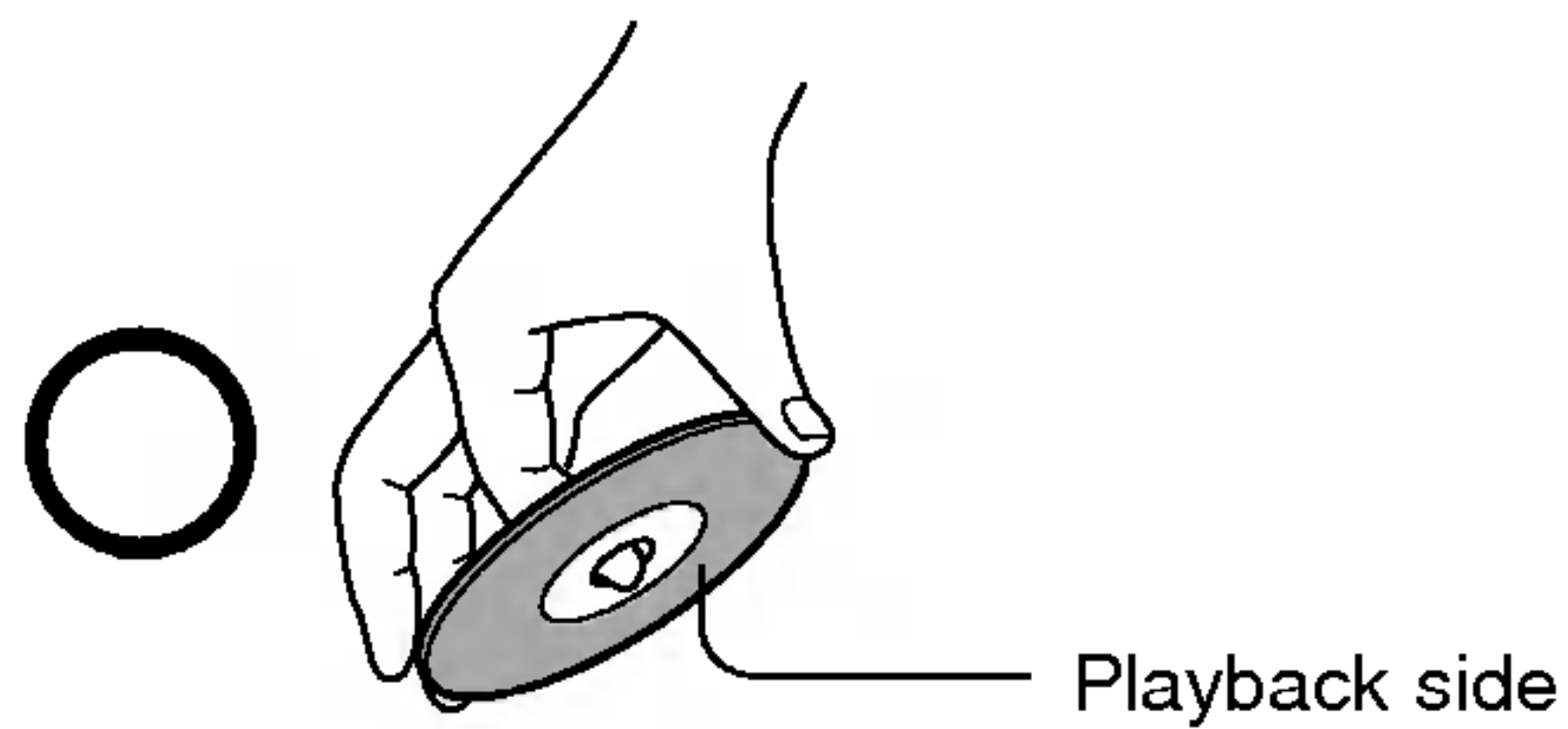

- Do not attach paper or tape to discs.



On cleaning discs

- Fingerprints and dust on the disc cause picture and sound deterioration. Wipe the disc from the center outwards with a soft cloth. Always keep the disc clean.

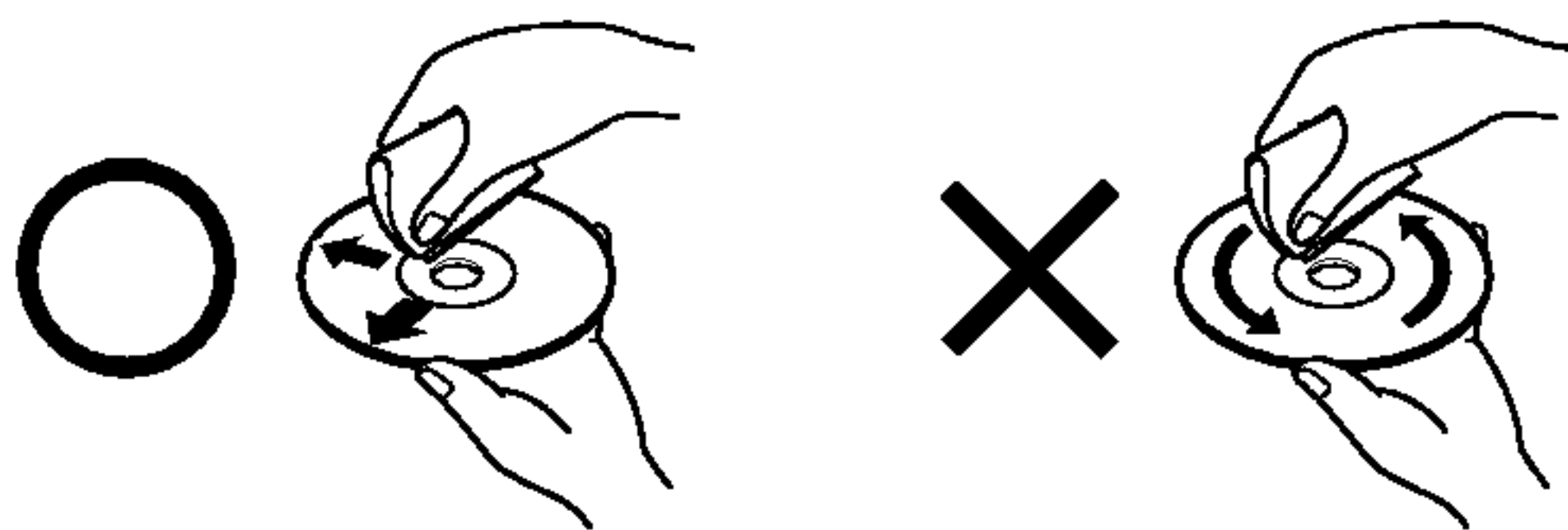

- Do not use any type of solvent such as thinner, benzene, commercially available cleaners or antistatic spray for vinyl LPs. It may damage the disc.

On storing discs

- Do not store discs in a place subject to direct sunlight or near heat sources.
- Do not store discs in places subject to moisture and dust such as a bathroom or near a humidifier.
- Store discs vertically in a case. Stacking or placing objects on discs outside of their case may cause warping.

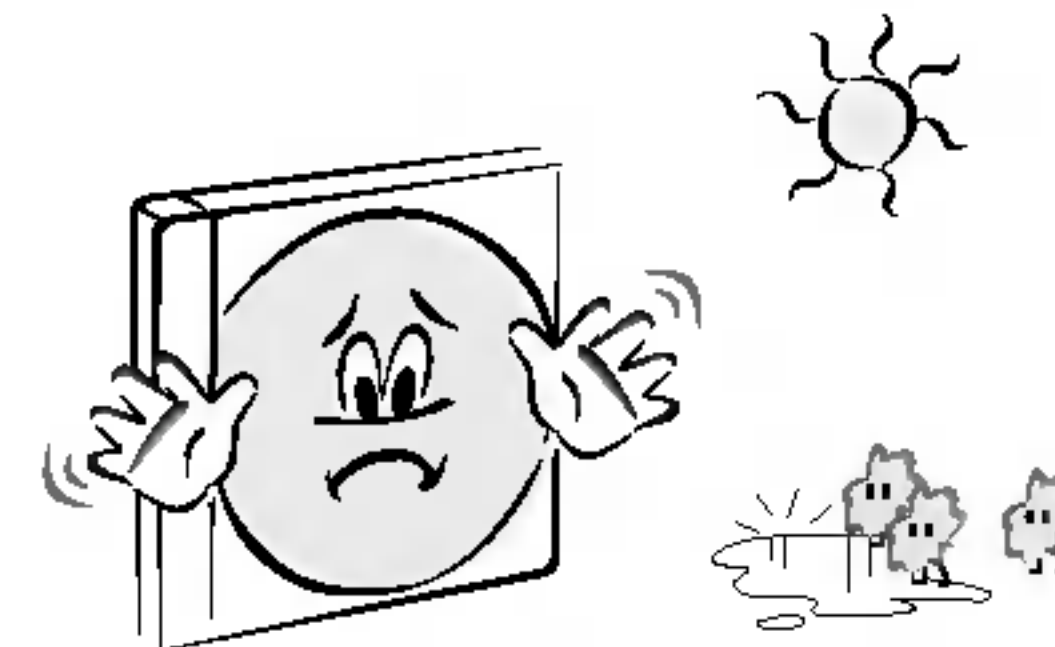

Structure of disc contents

Normally, DVD video discs are divided into titles, and the titles are sub-divided into chapters. Video CDs and Audio CDs are divided into tracks.

DVD video disc

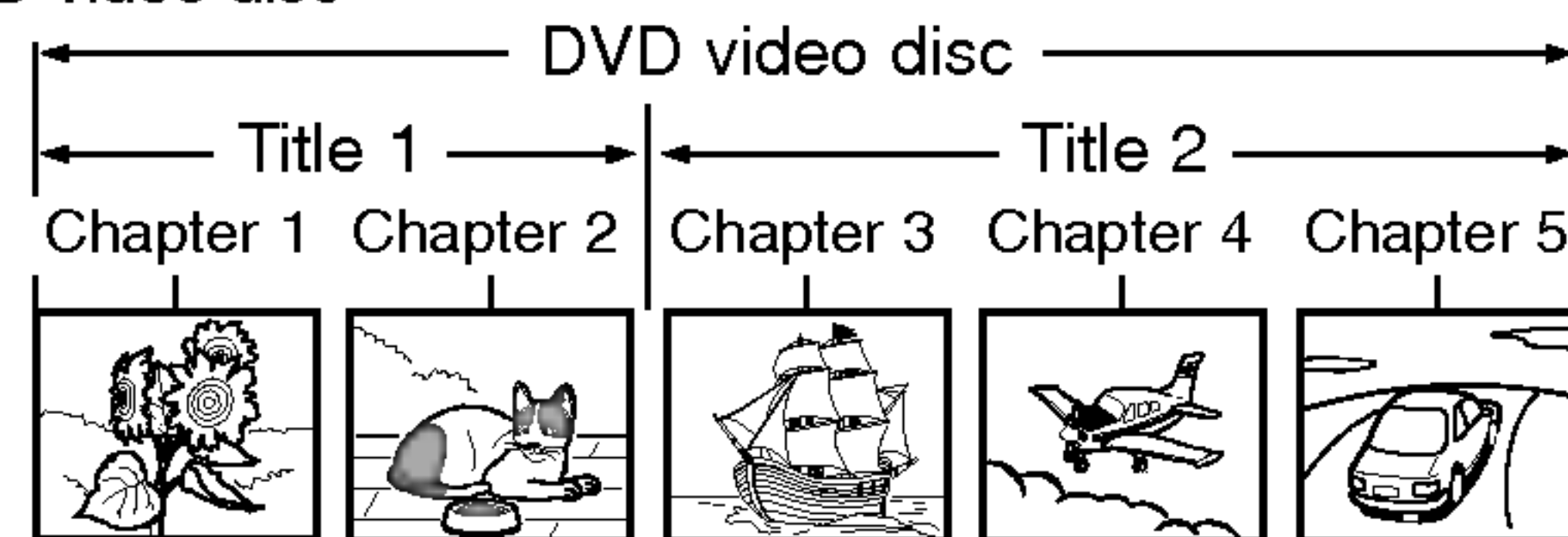

Video CD/Audio CD

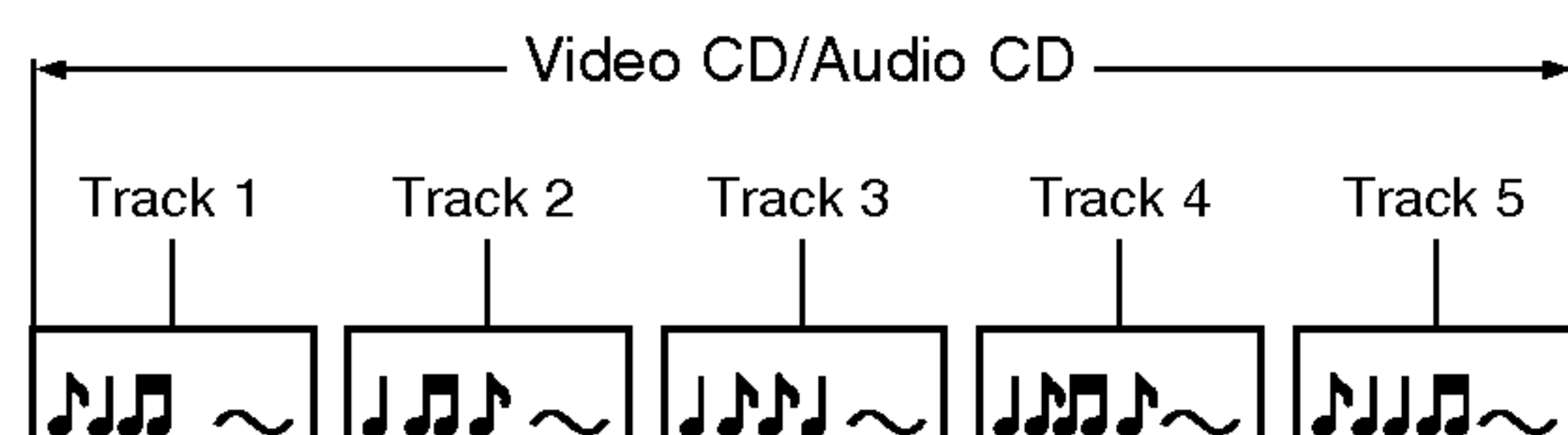

Each title, chapter or track is assigned a number, which is called "title number", "chapter number" or "track number" respectively. There may be discs that do not have these numbers.

- **Title:** When two or more movies are recorded on a disc, the disc is divided into two or more parts. Each part is called a "TITLE".
- **Chapter:** The titles can be subdivided into many sections. Each section is called a "CHAPTER".
- **Track:** An audio CD can contain several items. These are assigned to the tracks.

Note

- If an MP3 or JPEG file CD is created using an incorrect method, the player may not be able to recognize it. If this happens, try reburning another CD after setting up the disc writing parameters correctly on your PC.

Types of Playable Discs

- DVD (8 cm / 12 cm disc)
- Video CD (VCD) (8 cm / 12 cm disc)
- Audio CD (8 cm / 12 cm disc)

In addition, this unit plays DivX file, DVD -R, DVD +R, DVD -RW, DVD +RW, Kodak Picture CDs, SVCD, and CD-R / CD-RW that contains audio titles, MP3, WMA, and/or JPEG files.

Note

- Depending on the conditions of the recording equipment or the CD-R/RW (or DVD -R, DVD +R, DVD -RW, DVD +RW) disc itself, some CD-R/RW (or DVD -R, DVD +R, DVD -RW, DVD +RW) discs cannot be played on the unit.

Regional code of the DVD player and DVDs



This DVD player is designed and manufactured for playback of region "5" encoded DVD software. The region code on the labels of some DVD discs indicates which type of player can play those discs. This unit can play only DVD discs labeled "5" or "ALL". If you try to play any other discs, the message "Check Regional Code" will appear on the TV screen. Some DVD discs may not have a region code label even though their playback is prohibited by area limits.

Manufactured under license from Dolby Laboratories. "Dolby" and the double-D symbol are trademarks of Dolby Laboratories. "DTS" and "DTS Digital Surround" are trademarks of Digital Theater System, Inc.

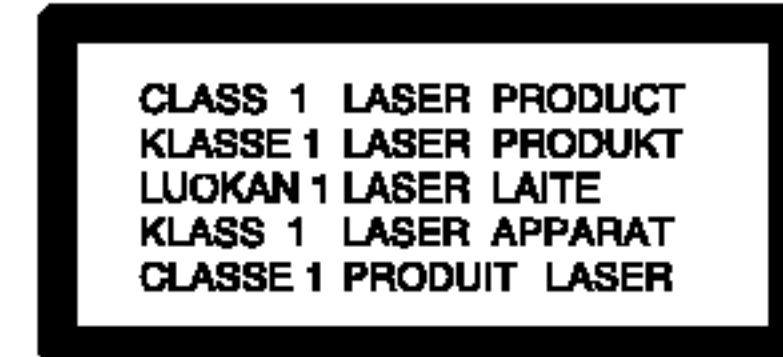

CAUTION:

This Digital Video Disc Player employs a Laser System. To ensure proper use of this product, please read this owner's manual carefully and retain for future reference should the unit require maintenance, contact an authorized service location (see service procedure). Use of controls, adjustments, or the performance of procedures other than those specified herein may result in hazardous radiation exposure. To prevent direct exposure to laser beam, do not try to open the enclosure. Visible laser radiation when open. **DO NOT STARE INTO BEAM.**

CAUTION: The apparatus should not be exposed to water (dripping or splashing) and no objects filled with liquids, such as vases, should be placed on the apparatus.

Screen Saver

The screen saver appears when you leave the DVD player in Stop mode for about five minutes. If the Screen Saver is displayed for five minutes, the DVD Player automatically turns itself off.

Last Scene Memory

This player memorizes last scene from the last disc that is viewed. The last scene remains in memory even if you remove the disc from the player or turn off the set. If you load a disc that has the scene memorized, the scene is automatically recalled.

Note:

This player does not memorize the scene of a disc if you switch off the player before commencing to play the disc.

Note

- Except **DVD** mode the **PLAY** button must be pressed after inserting the disk to switch to **DVD** mode.

DVD operation

DVD Menu options - LANGUAGE

By using the DVD menu, you can make various adjustments to items such as picture and sound. You can also set a language for the subtitles and the DVD menu, among other things.

Menu Language



- Select your preferred language for the DVD menus and on screen displays messages.

- 1 Press the **MENU** button twice and then use the **▲ / ▼** button to select **Language**.
- 2 Press the **▶** button and then use **▲ / ▼** button to select **Menu Language**.
- 3 Press the **▶** button and then use **▲ / ▼** button to select your desired language.
- 4 Press the **OK** button.
The menus and on screen displays will appear in the selected language.
- 5 Press the **EXIT** button to exit the menu.

Disc Audio / Disc Subtitle / Disc Menu

DVD-V



- Select the language you prefer for the **Disc Audio / Disc Subtitle / Disc Menu**.

- **Original:** Refers to the original language in which the disc was recorded.
- **Other:** To select another language, press number buttons then **OK** button to enter the corresponding 4-digit number according to the language code list in the **REFERENCE** chapter. (Refer to P.62) If you enter the wrong language code, press **CLEAR** button.

- 1 Press the **MENU** button twice and then use the **▲ / ▼** button to select **Language**.
- 2 Press the **▶** button and then use **▲ / ▼** button to select **Disc Audio / Disc Subtitle / Disc Menu**.
- 3 Press the **▶** button and then use **▲ / ▼** button to select your desired language.
- 4 Press the **OK** button.
- 5 Press the **EXIT** button to exit the menu.

DVD Menu options - DISPLAY

Progressive Scan



- *Progressive Scan Video provides the highest quality pictures with less flickering. Set **Progressive Scan** to **On**.*

- 1** Press the **MENU** button twice and then use the **▲ / ▼** button to select **DISPLAY**.
- 2** Press the **▶** button to select **Progressive Scan**.
- 3** Press the **▶** button and then use **▲ / ▼** button to select **On** or **Off**.
- 4** Press the **OK** button.
- 5** Press the **EXIT** button to exit the menu.

DVD operation

DVD Menu options - AUDIO

Each DVD disc has a variety of audio output options.

Set the player's AUDIO options according to the type of audio system you use.



• **Bitstream:** Select **Bitstream** if you connect the DVD Player's DIGITAL OUT jack to an amplifier or other equipment with a Dolby Digital, DTS or MPEG decoder.

• **PCM (Pulse Code Modulation):** Select when connected to a two-channel digital stereo amplifier. DVDs encoded in Dolby Digital, DTS or MPEG will be automatically down-mixed to two-channel PCM audio.

- 1 Press the **MENU** button twice and then use the **▲ / ▼** button to select **AUDIO**.
- 2 Press the **▶** button and then use **▲ / ▼** button to select **Dolby Digital / DTS / MPEG**.
- 3 Press the **▶** button and then use **▲ / ▼** button to select **Bitstream** or **PCM**.
- 4 Press the **OK** button.
- 5 Press the **EXIT** button to exit the menu.



- If your receiver or amplifier is **NOT** capable of handling 96 kHz signals, select 48 kHz. When this choice is made, this unit automatically converts any 96 kHz signals to 48 kHz so your system can decode them.

If your receiver or amplifier is capable of handling 96 kHz signals, select 96 kHz. When this choice is made, this unit passes each type of signal through without any further processing.

Check the documentation for your amplifier to verify its capabilities.

- 1 Press the **MENU** button twice and then use the **▲ / ▼** button to select **AUDIO**.
- 2 Press the **▶** button and then use **▲ / ▼** button to select **Sample Freq.**
- 3 Press the **▶** button and then use **▲ / ▼** button to select **48KHz** or **96KHz**.
- 4 Press the **OK** button.
- 5 Press the **EXIT** button to exit the menu.

DRC (Dynamic Range Control)

DVD-V DVD-X



- With the DVD format, you can hear a program's soundtrack in the most accurate and realistic presentation possible, thanks to digital audio technology. However, you may wish to compress the dynamic range of the audio output (the difference between the loudest sounds and the quietest ones). This allows you to listen to a movie at a lower volume without losing clarity of sound. Set **DRC** to **On** for this effect.

- 1 Press the **MENU** button twice and then use the **▲ / ▼** button to select **AUDIO**.
- 2 Press the **▶** button and then use **▲ / ▼** button to select **DRC**.
- 3 Press the **▶** button and then use **▲ / ▼** button to select **On** or **Off**.
- 4 Press the **OK** button.
- 5 Press the **EXIT** button to exit the menu.

Vocal

DVD-V



- Set to **On** only when a multi-channel karaoke DVD is playing. The karaoke channels on the disc mix into normal stereo sound.
- **Vocal** setting works when the **Dolby Digital** mode is set to **PCM** in the DVD menu.

- 1 Press the **MENU** button twice and then use the **▲ / ▼** button to select **AUDIO**.
- 2 Press the **▶** button and then use **▲ / ▼** button to select **Vocal**.
- 3 Press the **▶** button and then use **▲ / ▼** button to select **On** or **Off**.
- 4 Press the **OK** button.
- 5 Press the **EXIT** button to exit the menu.

DVD operation

DVD Menu options - LOCK

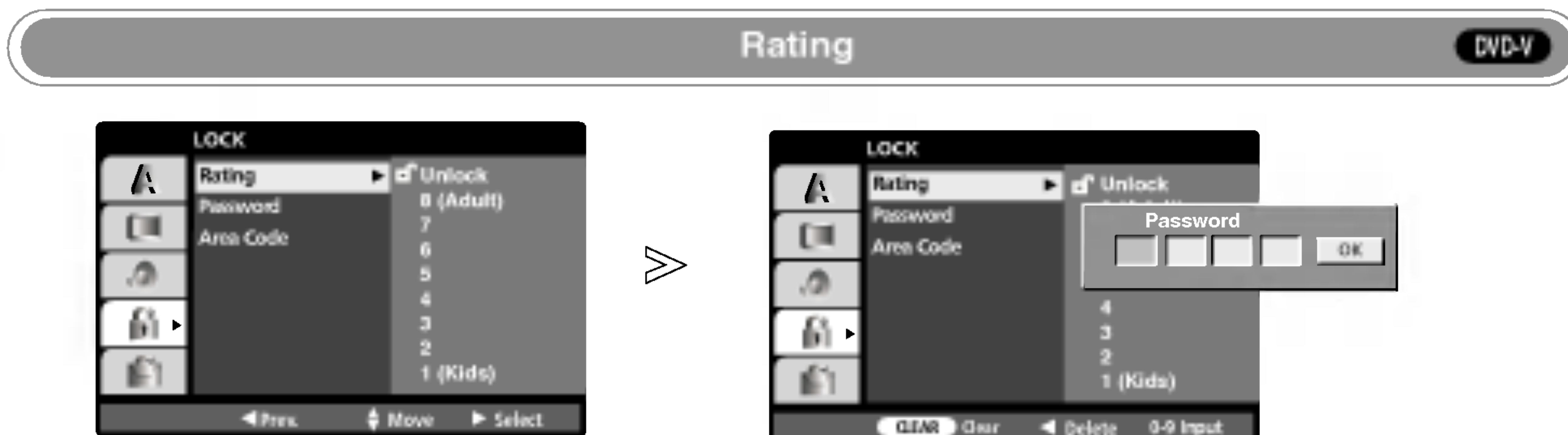

- Some movies contain scenes that may not be suitable for children to view. Many of these discs contain parental control information that applies to the complete disc or to certain scenes on the disc. Movies and scenes are rated from 1 to 8, depending on the country. Some discs offer more suitable scenes as an alternative.

The parental control feature allows you to block access to scenes below the rating you input, thereby preventing your children from being able to view material you believe is unsuitable.

- 1 Press the **MENU** button twice and then use the **▲ / ▼** button to select **LOCK**.
- 2 Press the **▶** button and then use **▲ / ▼** button to select **Rating**.
- 3 Press the **▶** button.
To access the **Rating**, you must input the 4-digit password you created. If you have not yet entered a password you are prompted to do so. Input a 4-digit password and press **OK** button. Enter it again and press **OK** button to verify. If you make a mistake before pressing **OK** button, press **CLEAR** button.
- 4 Select a rating from **1** to **8** using the **▲ / ▼** button.
Rating 1-8: Rating **1** has the most restrictions and rating **8** is the least restrictive.
Unlock : If you select unlock, parental control is not active and the disc plays in full.
- 5 Press the **OK** button.
- 6 Press the **EXIT** button to exit the menu.



Note

- a. If you set a rating for the player, all disc scenes with the same rating or lower are played. Higher rated scenes are not played unless an alternate scene is available on the disc. The alternative must have the same rating or a lower one. If no suitable alternative is found, playback stops. You must enter the 4-digit password or change the rating level in order to play the disc.

Password (Security Code)

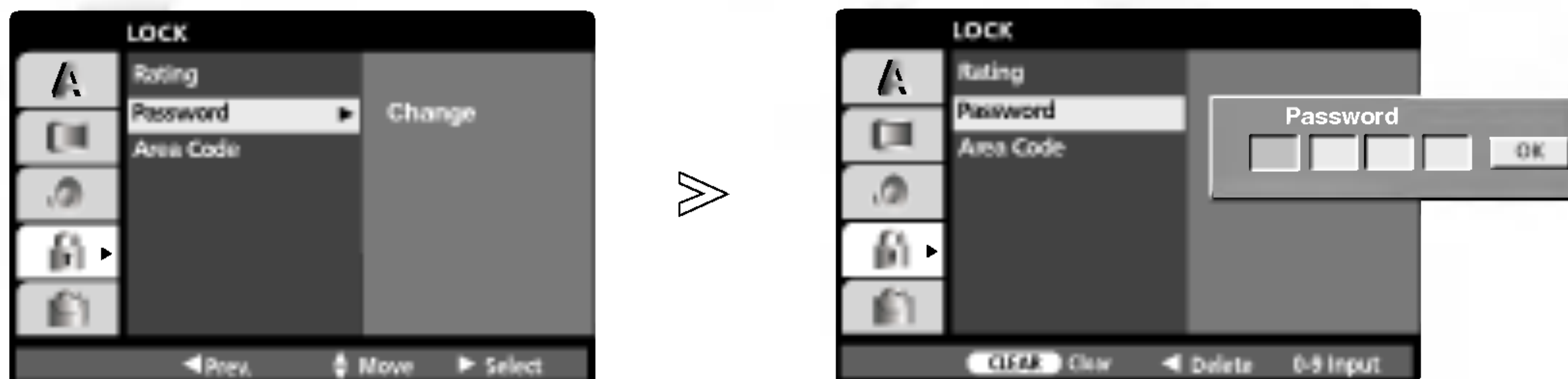

- You can enter or change password.

- 1 Press the **MENU** button twice and then use the **▲ / ▼** button to select **LOCK**.
- 2 Press the **▶** button and then use **▲ / ▼** button to select **Password**.
- 3 Press the **▶** and **OK** button.
 - In case of "New"**
 - Input a 4-digit password and press **OK** button. Enter it again and press **OK** button to verify. If you make a mistake before pressing **OK** button, press **CLEAR** button.
 - In case of "Change"**
 - 1. Input the 4-digit password you created.
 - 2. Input the new 4-digit password and press **OK** button. Enter it again and press **OK** button to verify. If you make a mistake before pressing **OK** button, press **CLEAR** button.
- 4 Press the **EXIT** button to exit the menu.

If you forget your Password

If you forget your password you can clear it using the following steps:

1. Press the **MENU** button twice to display the DVD menu.
2. Input the 6-digit number "**210499**" and the password is cleared.
3. Enter a new password as described above.

Area Code

DVD-V

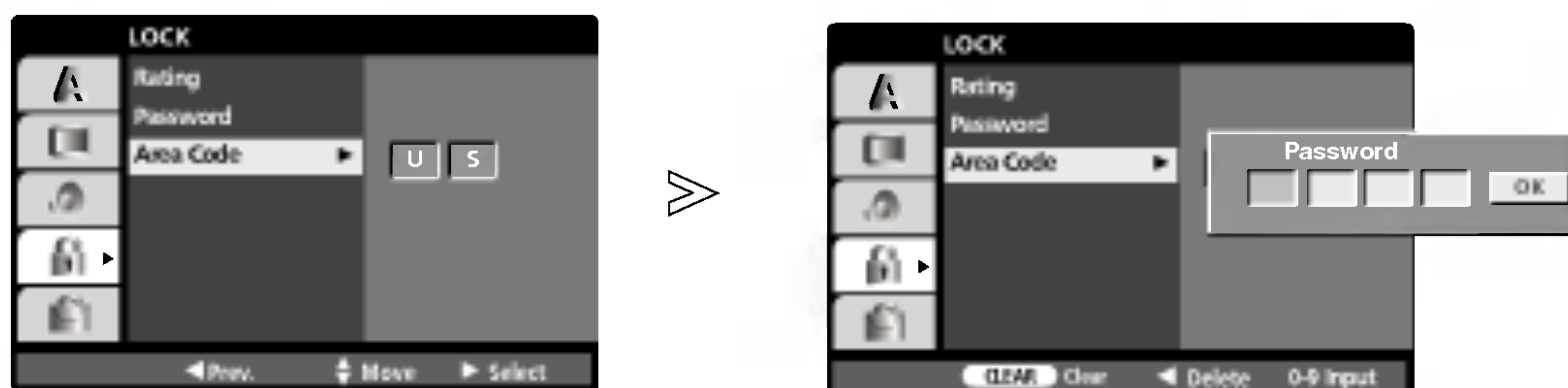

- Enter the code of the country/area whose standards were used to rate the DVD video disc, based on the list in the "**REFERENCE**" chapter. (Refer to P.62)

- 1 Press the **MENU** button twice and then use the **▲ / ▼** button to select **LOCK**.
- 2 Press the **▶** button and then use **▲ / ▼** button to select **Area Code**.
- 3 Press the **▶** button.
 - To access the **Area Code**, you must input the 4-digit password you created. If you have not yet entered a password you are prompted to do so.
 - Input a 4-digit password and press **OK** button. Enter it again and press **OK** button to verify. If you make a mistake before pressing **OK** button, press **CLEAR** button.
- 4 Select the first character using **▲ / ▼** button and press **OK** button.
- 5 Select the second character using **▲ / ▼** button and press **OK** button to confirm your country code selection.
- 6 Press the **EXIT** button to exit the menu.

DVD operation

DVD Menu options - OTHERS



- Set Playback Control (PBC) to **On** or **Off**.
- On:** Video CDs with **PBC** are played according to the **PBC**.
- Off:** Video CDs with **PBC** are played the same way as Audio CDs.

- 1 Press the **MENU** button twice and then use the **▲ / ▼** button to select **OTHERS**.
- 2 Press the **▶** button and then use **▲ / ▼** button to select **PBC**.
- 3 Press the **▶** button and then use **▲ / ▼** button to select **On** or **Off**.
- 4 Press the **OK** button.
- 5 Press the **EXIT** button to exit the menu.



- You can set up the DVD Player so a DVD disc automatically starts playing whenever the DVD is inserted. If **Auto Play** mode is set to **On**, this DVD player will search for title that has the longest playback time and then play back the title automatically.

- 1 Press the **MENU** button twice and then use the **▲ / ▼** button to select **OTHERS**.
- 2 Press the **▶** button and then use **▲ / ▼** button to select **Auto Play**.
- 3 Press the **▶** button and then use **▲ / ▼** button to select **On** or **Off**.
- 4 Press the **OK** button.
- 5 Press the **EXIT** button to exit the menu.



Note

- a. The Auto Play function may not work for some DVDs.
- b. When you load and play back again the same disc in the tray, Playback starts from the location where you stopped playback because **Last scene memory** function works prior to **Auto Play** function.

DivX(R) VOD Div-X



- You can show the DivX DRM (Digital Right Management) Registration code for your unit only. The Registration code is used for VOD (Video-On-Demand) service agent. You can purchase or rental an encrypt movie file.

- 1 Press the **MENU** button twice and then use the **▲ / ▼** button to select **OTHERS**.
- 2 Press the **▶** button and then use **▲ / ▼** button to select **DivX(R) VOD**.
- 3 Press the **▶** and **OK** button.
- 4 Press the **EXIT** button to exit the menu.



Note

a. If you rent the DivX VOD file, it has several options of viewing limits as show below.

- Display the number which you can watch the file.
- The rental has been expired.
- Display the authorization error.

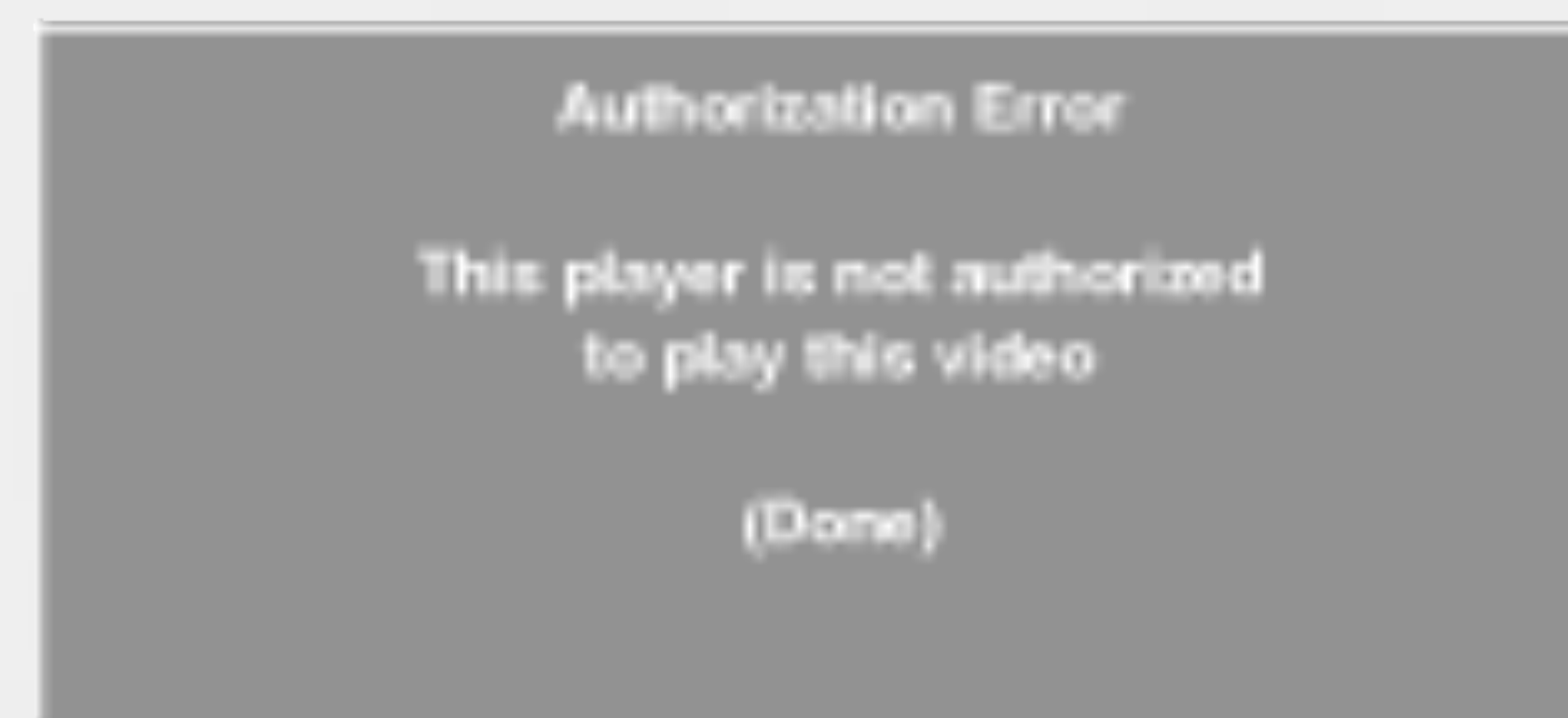
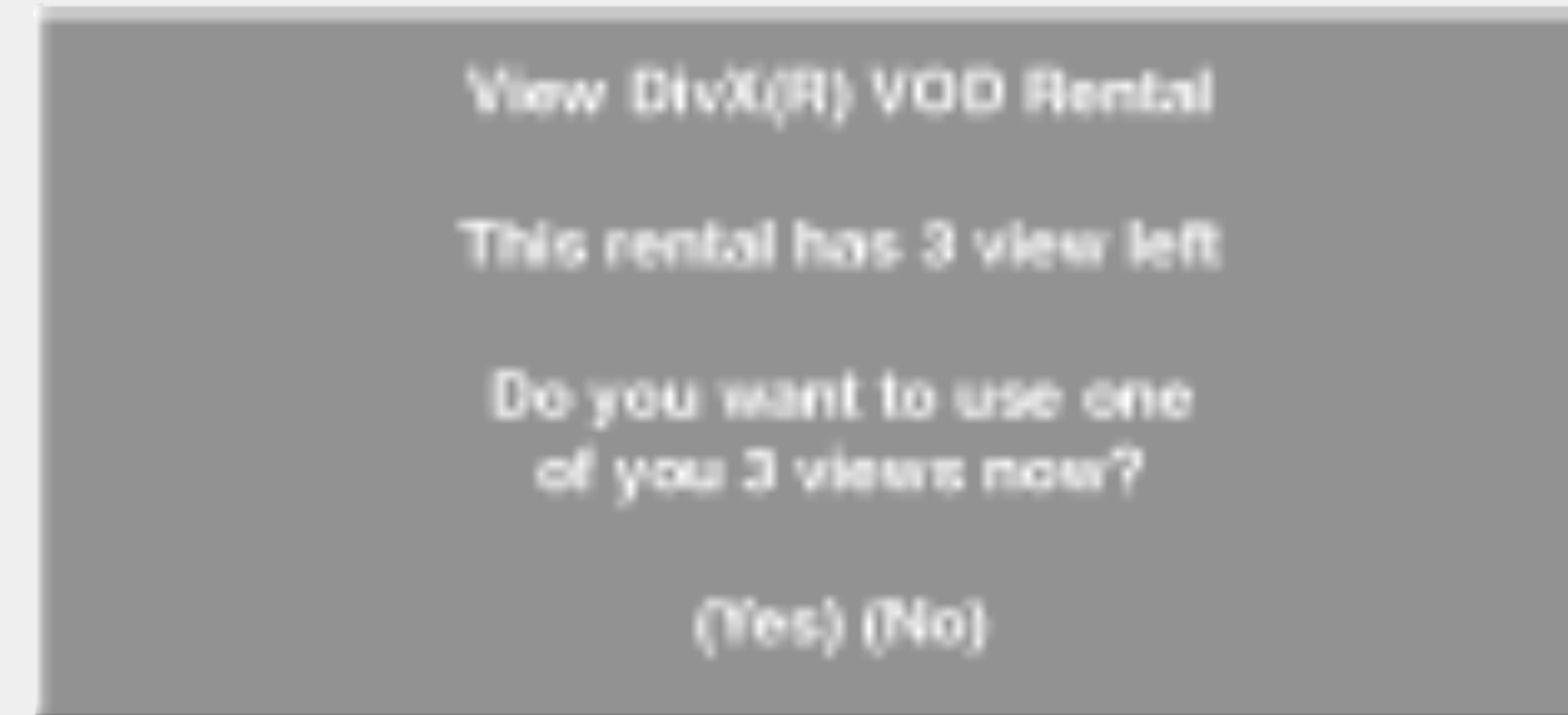

DVD operation

Playing a DVD or Video CD

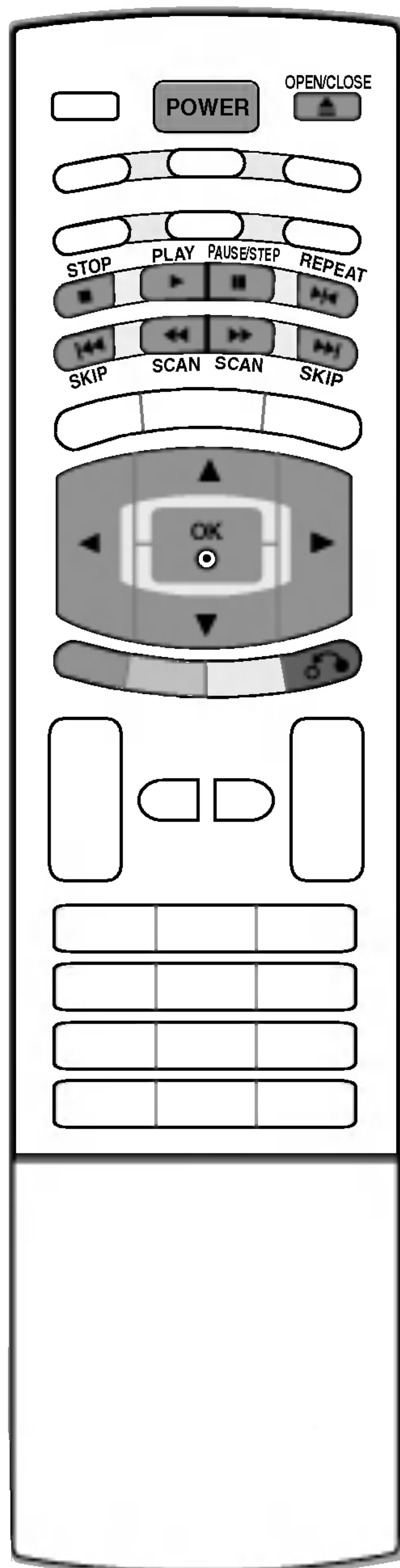

Basic Playback

DVD-V

VCD

DivX

- 1 Press the **POWER** button to turn the unit on.
- 2 Press **OPEN/CLOSE** button to open the disc tray and load your chosen disc in the tray, with the playback side down.
- 3 Press **OPEN/CLOSE** button to close the tray. Playback starts automatically. If playback does not start, press ► **PLAY** button.

Stop Playback

DVD-V

VCD

DivX

- 1 Press the ■ **STOP** button to stop playback. At this time the DVD video player stops playback temporarily and maintains the current playback position. If you ► **PLAY** button is pressed, playback will resume from the location where you stopped playback.
- 2 Press the ■ **STOP** button again to stop playback fully. At this time if you press ► **PLAY** button, the disc playback starts from the beginning.

Pause Playback (Still mode)

DVD-V

VCD

DivX

- 1 Press II **PAUSE/STEP** button during playback.
- 2 Press the ► **PLAY** button again to return to normal playback.

Still Picture and Frame-by-Frame Playback

DVD-V

VCD

DivX

- 1 Press II **PAUSE/STEP** button on the remote control during playback. Advance the picture frame-by-frame by pressing II **PAUSE/STEP** button repeatedly.
- 2 To exit still motion mode, press ► **PLAY** button.

Fast Forward/Backward

DVD-V

VCD

DivX

- 1 Press ◀◀ **SCAN** or ▶▶ **SCAN** button during playback.
- 2 Press ◀◀ **SCAN** or ▶▶ **SCAN** button repeatedly to select the required speed.
 - **DVD, DivX disc:** X2, X4, X16 or X100
 - **Video CD:** X2, X4 or X8
- 3 Press the ► **PLAY** button again to return to normal playback.

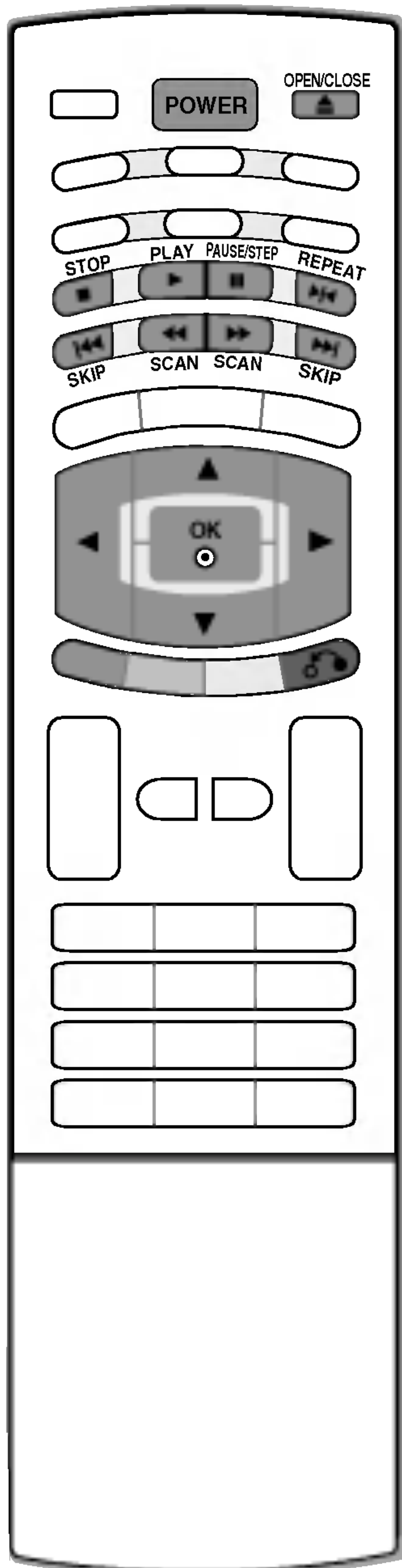

Slow Motion

DVD-V VCD DivX

- 1 Press **II PAUSE/STEP** button on the remote control during playback. The DVD player will now go into PAUSE mode.
- 2 Use the **◀◀ SCAN** or **▶▶ SCAN** button to select the required speed: **◀◀ 1/16**, **◀◀ 1/8**, **◀◀ 1/4**, or **◀◀ 1/2** (backward), or **▶▶ 1/16**, **▶▶ 1/8**, **▶▶ 1/4**, or **▶▶ 1/2** (forward). With a DivX Disc and Video CD, the Slow speed changes: **▶▶ 1/16**, **▶▶ 1/8**, **▶▶ 1/4** or **▶▶ 1/2** (forward).
- 3 To exit Slow Motion mode, press **▶ PLAY** button.



Note

- a. There is no sound during fast or slow playback for DVDs or Video CDs.
- b. Slow motion playback in reverse is not possible with Video CDs and DivX Discs.

Moving to another CHAPTER/TRACK

DVD-V VCD DivX

- 1 When a title on a disc has more than one chapter or a disc has more than one track, you can move to another chapter/track as follows:
 - Press **◀◀ SKIP** or **▶▶ SKIP** button briefly during playback to select the next chapter/track or to return to the beginning of the current chapter/track.
 - Press **◀◀ SKIP** button twice briefly to step back to the previous chapter/track.
 - To go directly to any chapter during DVD playback, press **DISPLAY** button and press **▲ / ▼** to select the chapter/track icon. Then, input the chapter/track number or use **◀ / ▶**.

Repeat Playback

DVD-V VCD DivX

- You can play a specific title, chapter, or track repeatedly.

- 1 Press the **▶◀ REPEAT** button during playback. Each time you press the **▶◀ REPEAT** button, the repeat mode changes as follows.
 - DVD Video Discs : **Chapter** → **Title** → **Off**
 - Video CDs, DivX discs : **Track** → **All** → **Off**



Note

- a. On a Video CD with PBC, you must set **PBC** to **Off** on the DVD menu to use the repeat function.
- b. If you press **▶▶ SKIP** button once during Repeat Chapter (Track) playback, the repeat playback cancels.

DVD operation

Playing a DVD or Video CD

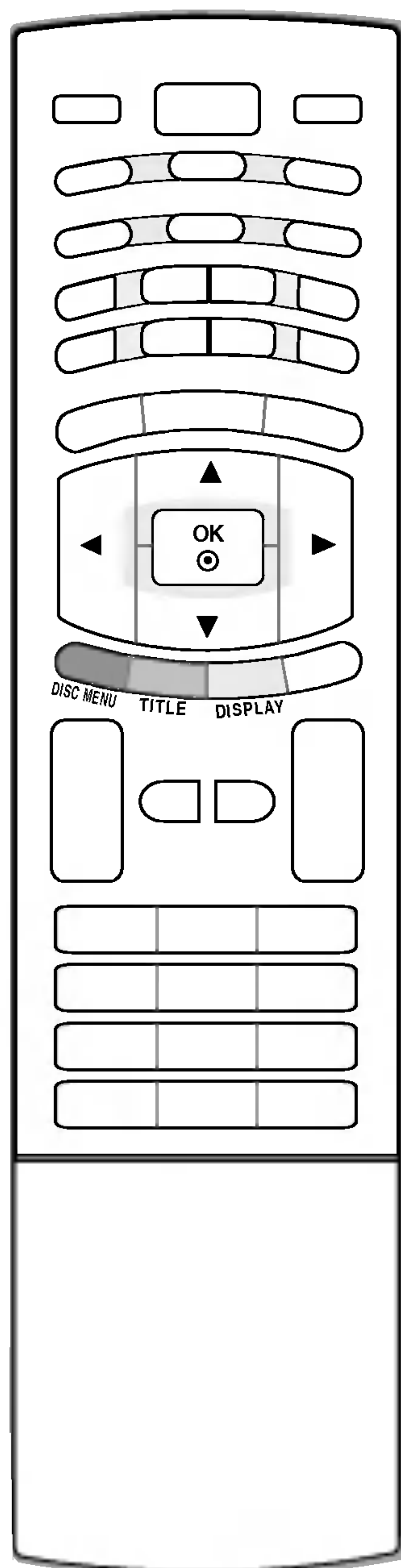

Disc Menu

DVD-V

- 1 Press the **DISC MENU** button during playback.
- 2 Use the **▲ / ▼ / ◀ / ▶** button or **OK** button to select the desired menu option.

Title Menu

DVD-V

- 1 Press the **TITLE** button during playback.
- 2 Use the **▲ / ▼ / ◀ / ▶** button or **OK** button to select the desired item.



Note

- a. The unit may not be able to select the disc or title menu depending on a sort of DVD disc.

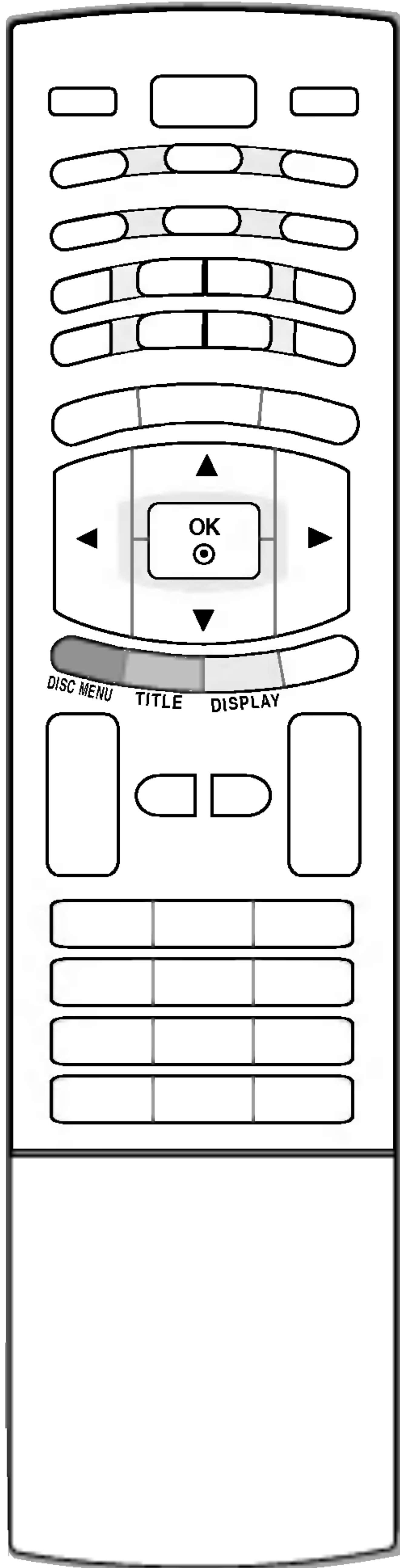

On-Screen Display

- 1** Press **DISPLAY** button during playback.
- 2** Use **▲ / ▼** button to select an item.
- 3** Press **◀ / ▶** button to change the setting. You can also use the number buttons if appropriate (e.g. inputting the title number). For some functions, press **OK** to execute the setting. Some discs may not provide all of the features shown below.

DVD-V	Items	Selection Method
• Title Number	◀ 1 / 3 ▶	• ◀ / ▶, Numbers → OK
• Chapter Number	1 / 12	• ◀ / ▶, Numbers → OK
• Time search	0:20:09	• Numbers → OK
• Audio language and Digital Audio Output mode	1 ENG D/D/D 3/2.1CH	• ◀ / ▶ or AUDIO
• Subtitle language	1 ENG	• ◀ / ▶ or SUB_T
• Angle	1 / 3	• ◀ / ▶ or ANGLE
• Sound	3D SUR	• ◀ / ▶

VCD	Items	Selection Method
• Track Number (or PBC mode)	◀ 1 / 3 ▶	• ◀ / ▶, Numbers → OK
• Time search	0:20:09	• Numbers → OK
• Audio Channel	Stereo	• ◀ / ▶ or AUDIO
• Sound	3D SUR	• ◀ / ▶

DVD	Items	Selection Method
• Track Number	◀ 1 / 3 ▶	• ◀ / ▶, Numbers → OK
• Time search	0:20:09	• Numbers → OK
• Audio language and Digital Audio Output mode	1 MP3 2/0 CH	• ◀ / ▶ or AUDIO
• Subtitle language	1 ENG	• ◀ / ▶ or SUB_T
• Sound	3D SUR	• ◀ / ▶

DVD operation

Playing a DVD or Video CD

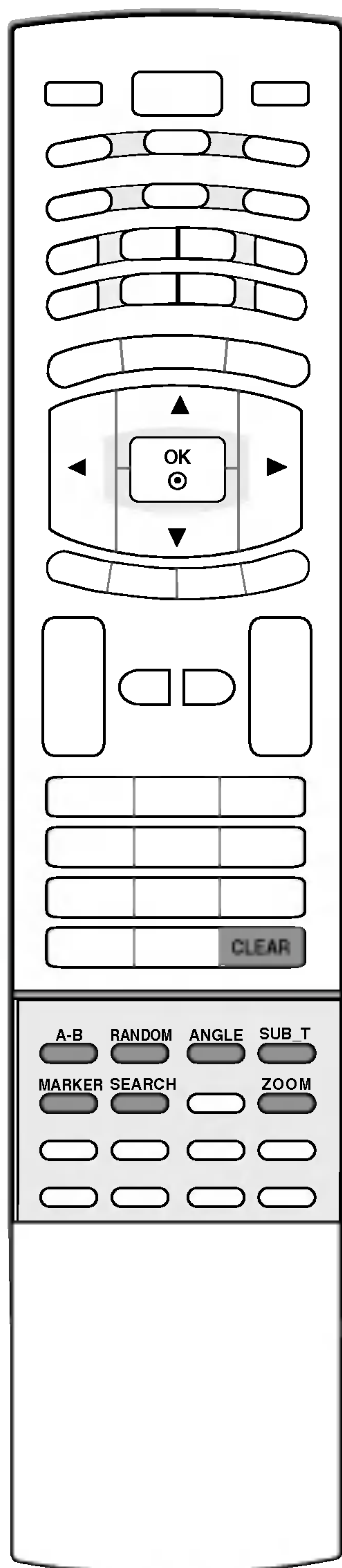

A-B Repeat Playback

DVD-V VCD DivX

- **A-B** repeat playback allows you to repeat material between two selected points.

- 1 Press the **A-B** button to select the start point during playback. “**↻A***” is displayed on the TV screen and the starting point of your selected segment is set up.
- 2 Press the **A-B** button again to select the end point. “**↻AB**” is displayed on the TV screen and the ending point is set up. Playback starts at the point that you selected. Playback stops at the end point, returns to Point **A** automatically, then starts again.
- 3 Repeatedly press the **A-B** button again to resume normal playback. “**off**” appears on the screen.

Random Playback

VCD

- 1 Press **RANDOM** button during playback. The unit automatically begins random playback and **RANDOM** appears on the TV screen.
- 2 Press **RANDOM** button again to normal.
 - By pressing **▶▶ SKIP** button during random playback, the unit selects another title (track) and resumes random playback.



Note

- a. On a Video CD with PBC, You must set **PBC** to **Off** on the DVD menu to use the random function

Camera Angle

DVD-V

- If the scene was recorded from multiple angles, you can easily change the camera angle of the scene you are currently watching.

- 1 Press the **ANGLE** button during playback.
- 2 Repeatedly press the **ANGLE** button to select the desired angle.



Note

- a. You can only change the angle for DVDs that provide multiple angles of scenes.
- b. The angle function will not work on DVD video discs that do not contain scenes recorded at different angles.
- c. The number of angles varies from disc to disc.

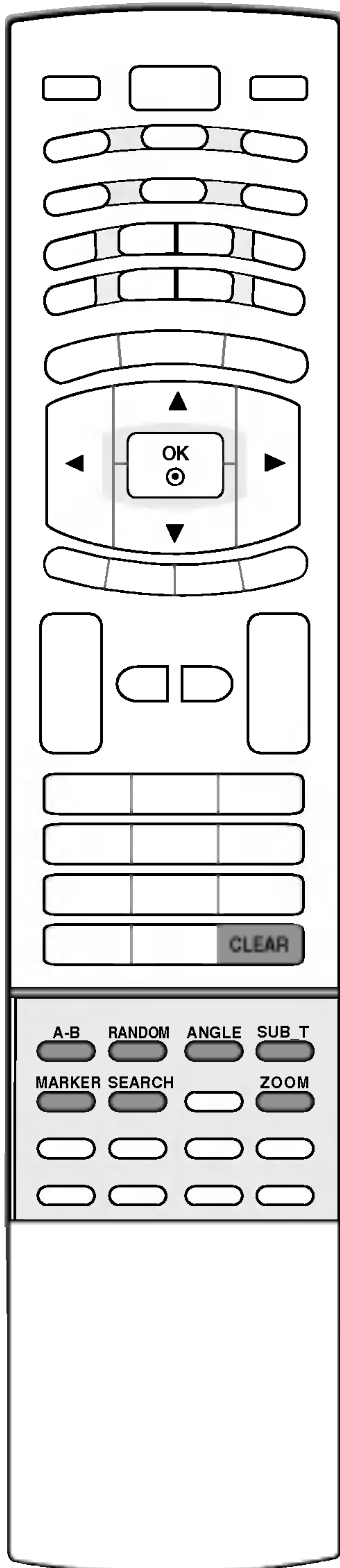

Subtitles

DVD-V DivX

- 1 Press **SUB_T** button repeatedly during playback to see the different subtitle languages. If a subtitle language is selected, the selected subtitle language is played whenever you start a new disc playback. (The disc must contain the selected language)



Note

- a. The subtitle file of the DivX file is displayed only smi, srt and sub.
- b. If there is no information or there is a code that can not read in the DivX file, " 1 " etc are displayed.

Marker Search

DVD-V VCD DivX

- You can start playback from up to nine memorized points.

■ To enter a Marker 1 / 9

Press **MARKER** button during playback at the desired point on the disc . The **MARKER** icon appears on the TV screen briefly. Repeat to enter up to nine markers.

■ To Recall or Clear a Marked Scene

1. During disc playback, press **SEARCH** button. The **MARKER SEARCH** menu appears on the screen.
2. Within 10 seconds, press ◀ / ▶ button to select a marker number that you want to recall or clear.
3. Press **OK** button and playback starts from the marked scene. Or, Press **CLEAR** button and the marker number is erased from the list.
4. You can play any marker by inputting its number on the **MARKER SEARCH** menu.

Zoom

DVD-V VCD DivX

- Use zoom to enlarge the video image.

- 1 Press **ZOOM** button during playback or still playback. The square frame appears briefly in the right bottom of the picture.
- 2 Each press of the **ZOOM** button changes the TV screen in the sequence: **100%** → **400%** → **1600%** → **Screen fit mode** → **100%**
 - **Screen fit mode :**
You can change the way the image appears on the screen when you're playing a DVD movie. Press ▲ / ▼ button to select between Normal, Enhanced, and Maximum.
- 3 Use the ▲ / ▼ / ◀ / ▶ button to move through the zoomed picture.
- 4 To resume normal playback, press **CLEAR** button.



Note

- a. Zoom may not work on some DVDs.
- b. Screen fit mode is available for playing the DVD disc, VR disc and movie file.

DVD operation

Playing an Audio CD or MP3/WMA Disc

- The DVD player can play MP3/WMA formatted recordings on CD-ROM, CD-R, or CD-RW discs.

■ Audio CD **CD**

1. Once you insert an audio CD a menu appears on the TV screen.
2. Press **▲ / ▼** button to select a track then press **▶ PLAY** or **OK** button. Playback starts.

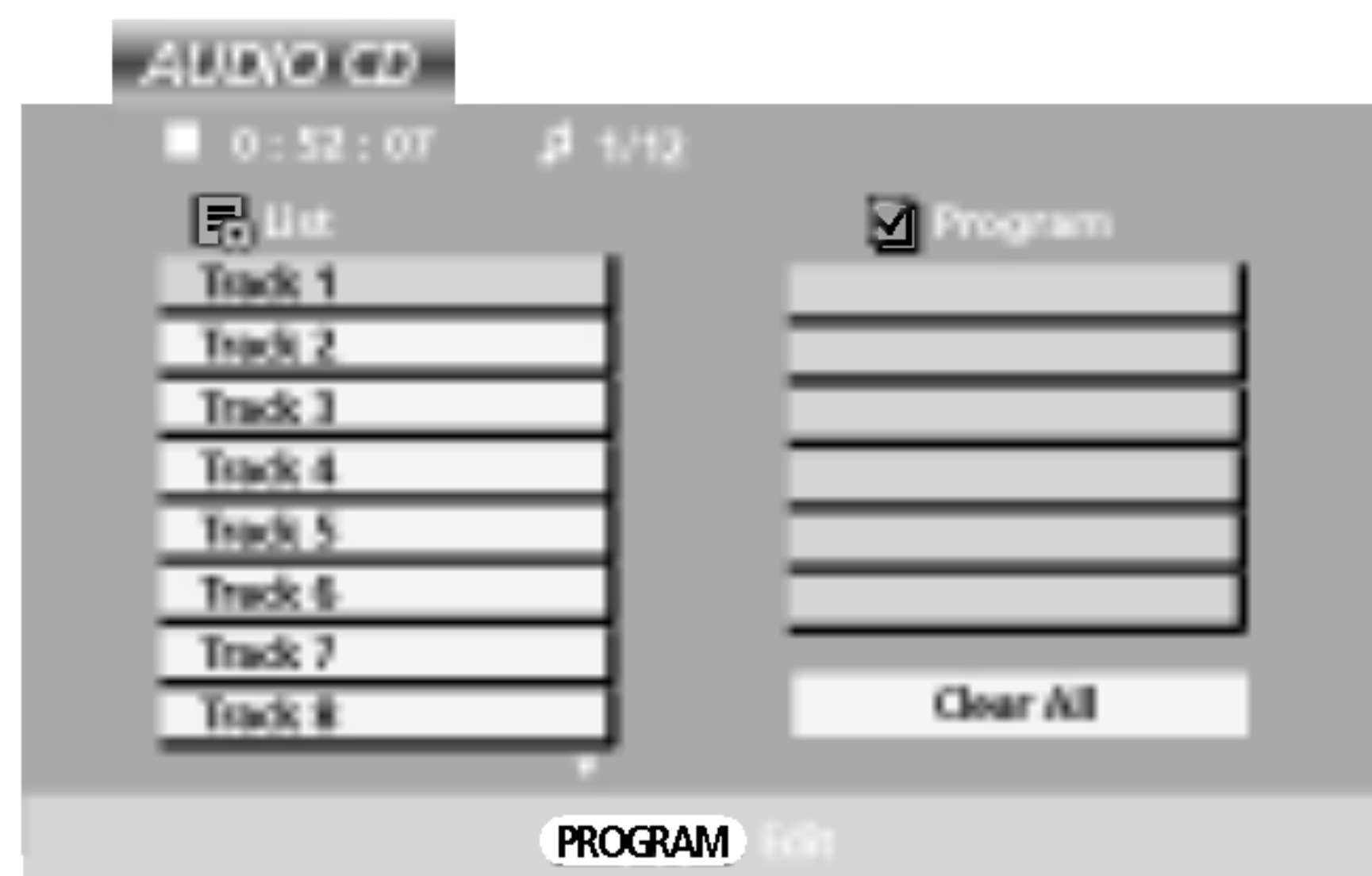

■ MP3 / WMA **MP3** **WMA**

1. Press **▲ / ▼** button to select a folder, and press **OK** button to see the folder contents.
2. Press **▲ / ▼** button to select a track then press **▶ PLAY** or **OK** button. Playback starts.

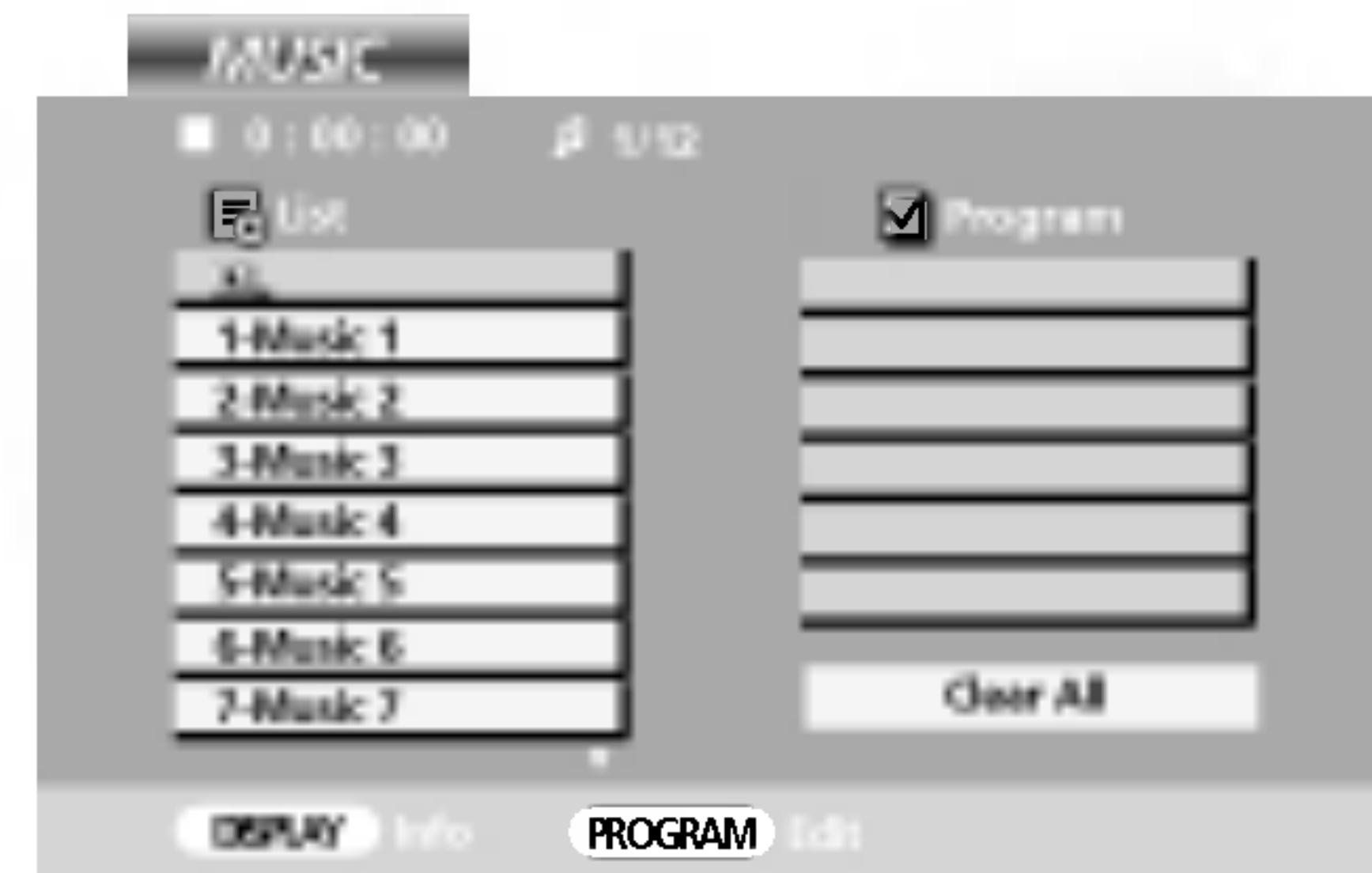

■ ID3 TAG

- When playing a file containing information such as track titles, you can see the information by pressing **DISPLAY** button. [Title, Artist, Album, Year, Comment]
- If there is no information, **NO ID3 TAG** appear on the display.

Pause Playback (Still mode)

CD **MP3** **WMA**

- 1 Press **II PAUSE/STEP** button during playback.
- 2 To return to playback, press **▶ PLAY**, **OK** or press **II PAUSE/STEP** button again.

Fast Forward/Backward

CD **MP3** **WMA**

- 1 Press **◀◀ SCAN** or **▶▶ SCAN** button during playback.
- 2 Press **◀◀ SCAN** or **▶▶ SCAN** button repeatedly to select the required speed.
 - X2, X4 or X8
- 3 Press the **▶ PLAY** button again to return to normal playback.

Moving to another Track

CD **MP3** **WMA**

- 1 Press **I◀◀ SKIP** or **▶▶I SKIP** button briefly during playback to go to the next track or to return to the beginning of the current track.
- 2 Press **I◀◀ SKIP** button twice briefly to go back to the previous track.
- 3 You can play any track by inputting its number.

Repeat Playback

CD

MP3

WMA

- You can play a track/all on a disc.

- 1 Press the **▶◀ REPEAT** button during playback.
- 2 Each time you press the **▶◀ REPEAT** button, the repeat mode changes as follows.
◀ Track → ▶ All → (Off)
 - If you press **▶▶ SKIP** button once during repeat track playback, the repeat playback cancels.

A-B Repeat Playback

CD

- **A-B** repeat playback allows you to repeat material between two selected points.

- 1 Press the **A-B** button to select the start point during playback. “◀ A” is displayed on the TV screen and the starting point of your selected segment is set up.
- 2 Press the **A-B** button again to select the end point. “▶ B” is displayed on the TV screen and the ending point is set up. Playback starts at the point that you selected. Playback stops at the end point, returns to Point **A** automatically, then starts again.
- 3 To exit the sequence and return to normal play, press **A-B** button again. The Repeat icon disappears from the menu screen.

Random Playback

CD

MP3

WMA

- 1 Press **RANDOM** button during playback. The unit automatically begins random playback and **RANDOM** button appears on the TV screen.
- 2 Press **RANDOM** button again to normal.
 - By pressing **▶▶ SKIP** button during random playback, the unit selects another track and resumes random playback.

3D Surround

CD

To produce a 3D surround effect that simulates multi-channel audio from two stereo speakers (instead of the five+ speakers normally required for multi-channel audio from a home theater system).

- 1 Press **AUDIO** button during playback. “**3D SUR.**” appears on the menu screen.
- 2 To return to normal playback, press **AUDIO** button repeatedly until “**3D SUR.**” disappears from the menu screen.

■ MP3 / WMA disc compatibility with this player is limited as follows:

- Sampling frequency: within 8 - 48 kHz (MP3), within 32 - 48kHz (WMA)
- Bit rate: within 8 - 320kbps (MP3), 32 - 192kbps (WMA)
- The player cannot read an MP3/WMA file that has a file extension other than “.mp3” / “.wma”.
- CD-R physical format should be ISO 9660 or JOLIET file.
- If you record MP3 / WMA files using software that cannot create a file system (eg. Direct-CD) it is impossible to playback MP3 / WMA files. We recommend that you use Easy-CD Creator, which creates an ISO 9660 file system.
- File names should have a maximum of 8 letters and must incorporate an .mp3 or .wma extension.
- They should not contain special letters such as / ? * : “ < > | etc.
- The total number of files on the disc should be less than 650.
- Play a MP3 file that made by user for personal purpose. Use other MP3 Player if an MP3 file is protected by copyright.

DVD operation

Programmed Playback

- The program function enables you to store your favorite tracks from any disc in the player memory. A program can contain 30 tracks.

- 1 Insert a disc.
- 2 Press **PROGRAM** button.
The **E** mark will appear to the right of the word **Program** on the right side of the menu screen.
 - Press **PROGRAM** button again, then the **E** mark will disappear to exit the Program Edit mode.



Audio CD Menu



MP3/WMA Menu

- **Video CD:** Press **PROGRAM** button while playback is stopped. The program menu appears. Press **PROGRAM** button again and hold it down for a few seconds to exit the menu.



Note

- a. On a Video CD with **PBC**, you must set **PBC** to **Off** on the setup menu to use the programmed playback.

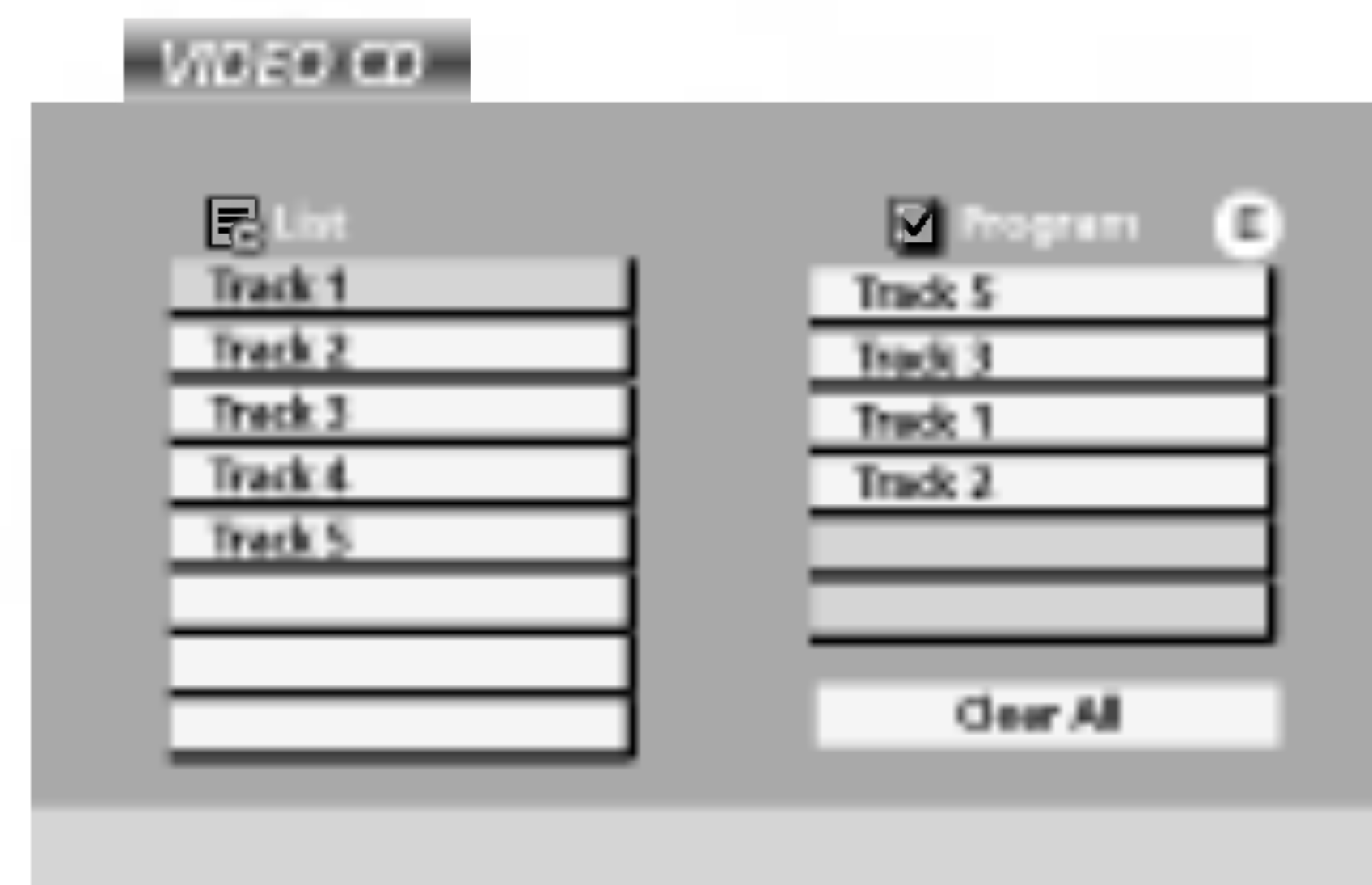

- 3 Select a track on the **List**, then press **OK** button to place the selected track on the **Program** list. Repeat to place additional tracks on the list.
- 4 Press **▶** button.
Select the track you want to start playing on the **Program** list.
- 5 Press **PLAY** or **OK** button to start.
Playback begins in the order in which you programmed the tracks. Playback stops after all of the tracks on the **Program** list have played once.
- 6 To resume normal playback from programmed playback, select a track on the **List** and then press **PLAY** button.

Repeat Programmed Tracks

1. Press the **▶◀ REPEAT** button during playback.
2. Each time you press the **▶◀ REPEAT** button, the repeat mode changes as follows.
Track → **All** → (Off)

Erasing a Track from Program list

1. Use **▲ / ▼ / ▶** button to select the track that you wish to erase from the Program list.
2. Press **CLEAR** button. Repeat to erase additional tracks on the list.

Erasing the Complete Program list

1. Press **▶** button to move to the **Program** list.
2. Use **▲ / ▼** button to select **Clear All**, then press **OK** button.



Note

- a. The programs are also cleared when the disc is removed.

Viewing a JPEG Disc

- Using this DVD Player you can view Kodak PICTURE CDs and discs with JPEG files.

- 1 Insert a disc and close the tray. The **PHOTO** menu appears on the TV screen.

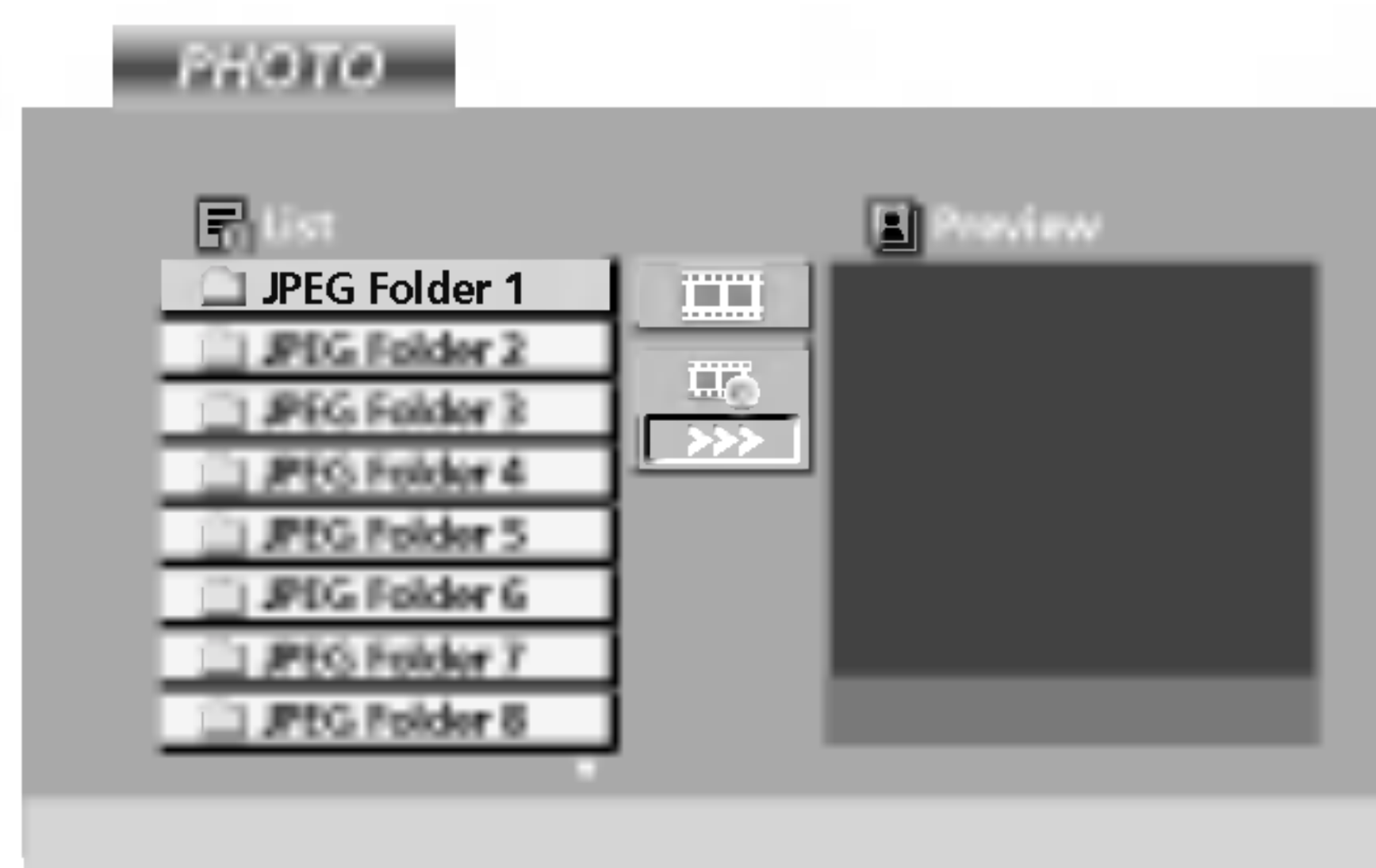

- 2 Press **▲ / ▼** button to select a folder, and press **OK** button. A list of files in the folder appears. If you are in a file list and want to return to the previous Folder list, use the **▲ / ▼** button on the remote to highlight **[-]** and press **OK** button.
 - Press **DISC MENU** button to move to the next page
 - On a disc with MP3/WMA and JPEG you can switch MP3/WMA and JPEG. Press **TITLE** button and **MUSIC** or **PHOTO** word on top of the menu is highlighted.
- 3 If you want to view a particular file, press **▲ / ▼** button to highlight a file and press **OK** or **▶ PLAY** button. Viewing the file proceeding starts.
 - While viewing a file, you can press **■ STOP** button to move to the previous **PHOTO** menu.
 - While viewing a file, If you press **RETURN** button, information of file is hidden.

■ Slide Show

1. Use **▲ / ▼ / ◀ / ▶** button to highlight the  (Slide Show) then press **OK** button.

■ Slide Speed

There are three slide speed options :

>>> (Fast) → **>>** (Normal) → **>** (Slow)

1. Use **▲ / ▼ / ◀ / ▶** button to highlight the Speed. Then, use **◀ / ▶** button to select the option you want to use then press **OK** button.

■ Still Picture

1. Press **II PAUSE/STEP** button during slide show. The player will now go into PAUSE mode.
2. To return to the slide show, press **▶ PLAY** or press **II PAUSE/STEP** button again.

■ Moving to another File

1. Press **I◀◀ SKIP** , **▶▶I SKIP** , **◀** or **▶** button once while viewing a picture to advance to the next or previous file.

■ Zoom

1. Press **ZOOM** button during playback or still playback. The square frame appears briefly in the right bottom of the picture.
2. Each press of the **ZOOM** button changes the TV screen in the sequence:
100% → 400% → 1600% → 100%
3. Use the **▲ / ▼ / ◀ / ▶** buttons to move through the zoomed picture.
4. To resume normal playback, press **CLEAR** button.

■ To rotate picture

1. Press **▲ / ▼** button during showing a picture to rotate the picture clockwise or counter clockwise.

DVD operation

Viewing a JPEG Disc

■ To listen to MP3/WMA music watching picture

You can display files while listening to MP3/WMA music files recorded on the same disc.

1. Insert the disc containing the two types of file in the player.
2. Press **TITLE** button to display **PHOTO** menu.
3. Press **▲ / ▼** button to select a photo file.
4. Use **▶** button to select  icon then press **OK** button.

Playback starts. The playback will continue until **■ STOP** button is pressed.

- To listen to only the desired music watching picture, programmed the desired tracks from the **MUSIC** menu and then proceed as above.

■ JPEG disc compatibility with this player is limited as follows:

- Depending upon the size and number of JPEG files, it could take a long time for the DVD player to read the disc's contents. If you don't see an on-screen display after several minutes, some of the files may be too large — reduce the resolution of the JPEG files to less than 2M pixels as 2760 x 2048 pixels and burn another disc.
- The total number of files and folders on the disc should be less than 650.
- Some discs may be incompatible due to a different recording format or the condition of disc.
- Ensure that all the selected files have the ".jpg" extensions when copying into the CD layout.
- If the files have ".jpe" or ".jpeg" extensions, please rename them as ".jpg" file.
- File names without ".jpg" extension will not be able to be read by this DVD player. Even though the files are shown as JPEG image files in Windows Explorer.

Playing a DVD VR format Disc

- This unit will play DVD-R/RW discs recorded using the DVD-Video format that have been finalized using a DVD-recorder.
- This unit will play DVD-RW discs recorded using the Video Recording (VR) format.

- 1 Insert a disc and close the tray. The DVD-VR menu appears on the TV screen.

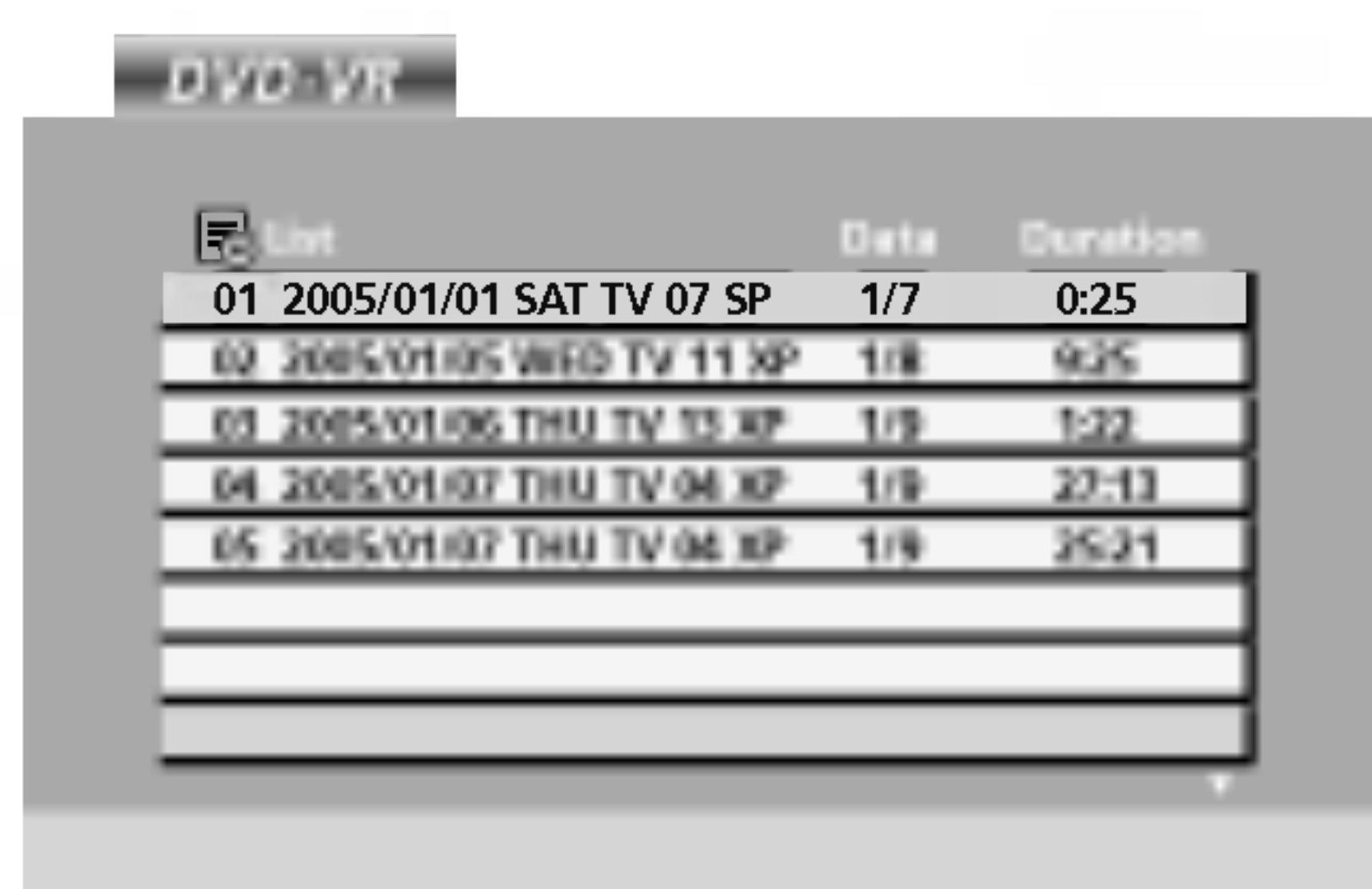

- 2 Press **▲ / ▼** button to select a track then press **▶ PLAY** or **OK** button and playback starts.



Note

- a. Unfinalized DVD-R/RW discs cannot be played in this player.
- b. Some DVD-VR disc are made with CPRM data by DVD RECORDER. Player does not support these kinds of discs and display the **CHECK DISC**.

• What is 'CPRM'?

CPRM is a copy protection system (with scramble system) only allowing the recording of 'copy once' broadcast programs. CPRM stands for Content Protection for Recordable Media.

This player is CPRM compatible, which means that you can record copy-once broadcast programs, but you cannot then make a copy of those recordings. CPRM recordings can only be made on DVD-RW discs formatted in VR mode, and CPRM recordings can only be played on players that are specifically compatible with CPRM.

Playing a DivX Movie Disc

- Using this DVD Player you can play DivX (Digital Internet Video eXpress) disc.

- 1 Insert a disc and close the tray. The **MOVIE** menu appears on the TV screen.

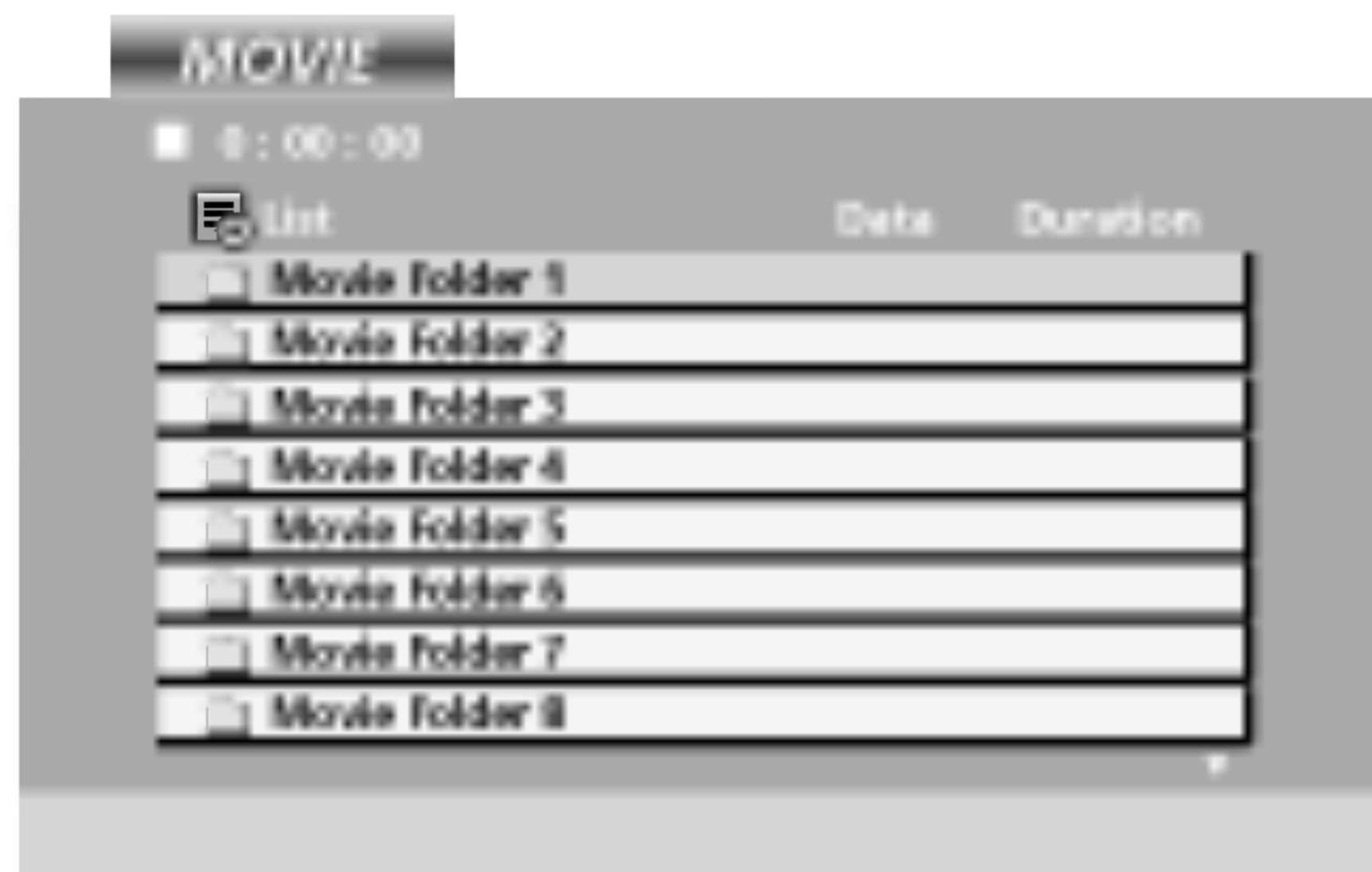

- 2 Press ▲ / ▼ button to select a folder, and press **OK** button. A list of files in the folder appears. If you are in a file list and want to return to the Folder list, use the ▲ / ▼ button on the remote to highlight  and press **OK** button.
- 3 If you want to view a particular file, press ▲ / ▼ button to highlight a file and press **OK** or ► **PLAY** button.
- 4 Press ■ **STOP** button to exit.

- On a CD with MP3/WMA, JPEG and MOVIE file, you can switch **MUSIC**, **PHOTO** and **MOVIE** menu. Press **TITLE** button and **MUSIC**, **PHOTO** and **MOVIE** word on top of the menu is highlighted.

■ DivX disc compatibility with this player is limited as follows:

- Available resolution size of the DivX file is under 720x576 (W x H) pixel.
- The file name of the DivX subtitle is available by 56 characters.
- If there is impossible code to express in the DivX file, it may be displayed as " _ " mark on the display.
- If the number of the screen frame is over 30 per 1 second, this unit may not operate normally.
- If the video and audio structure of recorded file is not interleaved, either video or audio is outputted.
- If the file is recorded with **GMC**, the unit supports only 1-point of the record level.

What is '**GMC**'?

GMC is the acronym for Global Motion Compensation. It is an encoding tool specified in MPEG4 standard. Some MPEG4 encoders, like DivX or Xvid, have this option. There are different levels of GMC encoding, usually called 1-point, 2-point, or 3-point GMC.

- Playable DivX file : ".avi ", ".mpg ", ".mpeg "
- Playable Codec format
"DIVX3.xx ", "DIVX4.xx ", "DIVX5.xx ", "XVID ", "MP43 ", "3IVX "
- Playable Audio format
"AC3 ", "DTS ", "PCM ", "MP3 ", "WMA "
 - Sampling frequency: within 8 - 48 kHz (MP3), within 32 - 48kHz (WMA)
 - Bit rate: within 8 - 320kbps (MP3), 32 - 192kbps (WMA)

Reference

Troubleshooting Checklist

The operation does not work normally.	
The remote control doesn't work	<ul style="list-style-type: none"> • Check to see if there is any object between the product and the remote control causing obstruction. • Are batteries installed with correct polarity (+ to +, - to -)? • Correct remote operating mode set: TV, VCR etc.? • Install new batteries.
Power is suddenly turned off	<ul style="list-style-type: none"> • Is the sleep timer set? • Check the power control settings. Power interrupted • No broadcast on station tuned with Auto off activated.

The video function does not work.	
No picture & No sound	<ul style="list-style-type: none"> • Check whether the product is turned on. • Try another channel. The problem may be with the broadcast. • Is the power cord inserted into wall power outlet? • Check your antenna direction and/or location. • Test the wall power outlet, plug another product's power cord into the outlet where the product's power cord was plugged in.
Picture appears slowly after switching on	<ul style="list-style-type: none"> • This is normal, the image is muted during the product startup process. Please contact your service center, if the picture has not appeared after five minutes.
No or poor color or poor picture	<ul style="list-style-type: none"> • Adjust Color in menu option. • Keep a sufficient distance between the product and the VCR. • Try another channel. The problem may be with the broadcast. • Are the video cables installed properly? • Activate any function to restore the brightness of the picture.
Horizontal/vertical bars or picture shaking	<ul style="list-style-type: none"> • Check for local interference such as an electrical appliance or power tool.
Poor reception on some channels	<ul style="list-style-type: none"> • Station or cable product experiencing problems, tune to another station. • Station signal is weak, reorient antenna to receive weaker station. • Check for sources of possible interference.
Lines or streaks in pictures	<ul style="list-style-type: none"> • Check antenna (Change the direction of the antenna).

The audio function does not work.	
Picture OK & No sound	<ul style="list-style-type: none"> • Press the VOL or VOLUME button. • Sound muted? Press MUTE button. • Try another channel. The problem may be with the broadcast. • Are the audio cables installed properly?
No output from one of the speakers	<ul style="list-style-type: none"> • Adjust Balance in menu option.
Unusual sound from inside the product	<ul style="list-style-type: none"> • A change in ambient humidity or temperature may result in an unusual noise when the product is turned on or off and does not indicate a fault with the product.

There is a problem in PC mode. (Only PC mode applied)	
The signal is out of range.	<ul style="list-style-type: none"> • Adjust resolution, horizontal frequency, or vertical frequency. • Check it whether the signal cable is connected or loose. • Check the input source.
Vertical bar or stripe on back- ground & Horizontal Noise & Incorrect position	<ul style="list-style-type: none"> • Work the Auto configure or adjust clock, phase, or H/V position.
Screen color is unstable or single color	<ul style="list-style-type: none"> • Check the signal cable. • Reinstall the PC video card.

Reference

Language Codes

Use this list to input your desired language for the following initial settings: **Disc Audio, Disc Subtitle, Disc Menu.**

Language	Code	Language	Code	Language	Code	Language	Code
Abkhazian	6566	Fiji	7074	Lingala	7678	Singhalese	8373
Afar	6565	Finnish	7073	Lithuanian	7684	Slovak	8375
Afrikaans	6570	French	7082	Macedonian	7775	Slovenian	8376
Albanian	8381	Frisian	7089	Malagasy	7771	Somali	8379
Ameharic	6577	Galician	7176	Malay	7783	Spanish	6983
Arabic	6582	Georgian	7565	Malayalam	7776	Sudanese	8385
Armenian	7289	German	6869	Maltese	7784	Swahili	8387
Assamese	6583	Greek	6976	Maori	7773	Swedish	8386
Aymara	6588	Greenlandic	7576	Marathi	7782	Tagalog	8476
Azerbaijani	6590	Guarani	7178	Moldavian	7779	Tajik	8471
Bashkir	6665	Gujarati	7185	Mongolian	7778	Tamil	8465
Basque	6985	Hausa	7265	Nauru	7865	Tatar	8484
Bengali; Bangla	6678	Hebrew	7387	Nepali	7869	Telugu	8469
Bhutani	6890	Hindi	7273	Norwegian	7879	Thai	8472
Bihari	6672	Hungarian	7285	Oriya	7982	Tibetan	6679
Breton	6682	Icelandic	7383	Panjabi	8065	Tigrinya	8473
Bulgarian	6671	Indonesian	7378	Pashto, Pushto	8083	Tonga	8479
Burmese	7789	Interlingua	7365	Persian	7065	Turkish	8482
Byelorussian	6669	Irish	7165	Polish	8076	Turkmen	8475
Cambodian	7577	Italian	7384	Portuguese	8084	Twi	8487
Catalan	6765	Japanese	7465	Quechua	8185	Ukrainian	8575
Chinese	9072	Javanese	7487	Rhaeto-Romance	8277	Urdu	8582
Corsican	6779	Kannada	7578	Rumanian	8279	Uzbek	8590
Croatian	7282	Kashmiri	7583	Russian	8285	Vietnamese	8673
Czech	6783	Kazakh	7575	Samoan	8377	Volapük	8679
Danish	6865	Kirghiz	7589	Sanskrit	8365	Welsh	6789
Dutch	7876	Korean	7579	Scots Gaelic	7168	Wolof	8779
English	6978	Kurdish	7585	Serbian	8382	Xhosa	8872
Esperanto	6979	Laothian	7679	Serbo-Croatian	8372	Yiddish	7473
Estonian	6984	Latin	7665	Shona	8378	Yoruba	8979
Faroese	7079	Latvian, Lettish	7686	Sindhi	8368	Zulu	9085

Area Codes

Choose a country code from this list.

Country	Code	Country	Code	Country	Code	Country	Code
Afghanistan	AF	Ethiopia	ET	Malaysia	MY	Saudi Arabia	SA
Argentina	AR	Fiji	FJ	Maldives	MV	Senegal	SN
Australia	AU	Finland	FI	Mexico	MX	Singapore	SG
Austria	AT	France	FR	Monaco	MC	Slovak Republic	SK
Belgium	BE	Germany	DE	Mongolia	MN	Slovenia	SI
Bhutan	BT	Great Britain	GB	Morocco	MA	South Africa	ZA
Bolivia	BO	Greece	GR	Nepal	NP	South Korea	KR
Brazil	BR	Greenland	GL	Netherlands	NL	Spain	ES
Cambodia	KH	Islands	HM	Netherlands Antilles	AN	Sri Lanka	LK
Canada	CA	Hong Kong	HK	New Zealand	NZ	Sweden	SE
Chile	CL	Hungary	HU	Nigeria	NG	Switzerland	CH
China	CN	India	IN	Norway	NO	Taiwan	TW
Colombia	CO	Indonesia	ID	Oman	OM	Thailand	TH
Congo	CG	Israel	IL	Pakistan	PK	Turkey	TR
Costa Rica	CR	Italy	IT	Panama	PA	Uganda	UG
Croatia	HR	Jamaica	JM	Paraguay	PY	Ukraine	UA
Czech Republic	CZ	Japan	JP	Philippines	PH	United States	US
Denmark	DK	Kenya	KE	Poland	PL	Uruguay	UY
Ecuador	EC	Kuwait	KW	Portugal	PT	Uzbekistan	UZ
Egypt	EG	Libya	LY	Romania	RO	Vietnam	VN
El Salvador	SV	Luxembourg	LU	Russian Federation	RU	Zimbabwe	ZW

IR codes

How to Connect

- ▶ Connect your wired remote control to the Remote Control port on the TV.

Remote Control IR Codes

▶ Output waveform

Single pulse, modulated with 37.917KHz signal at 455KHz

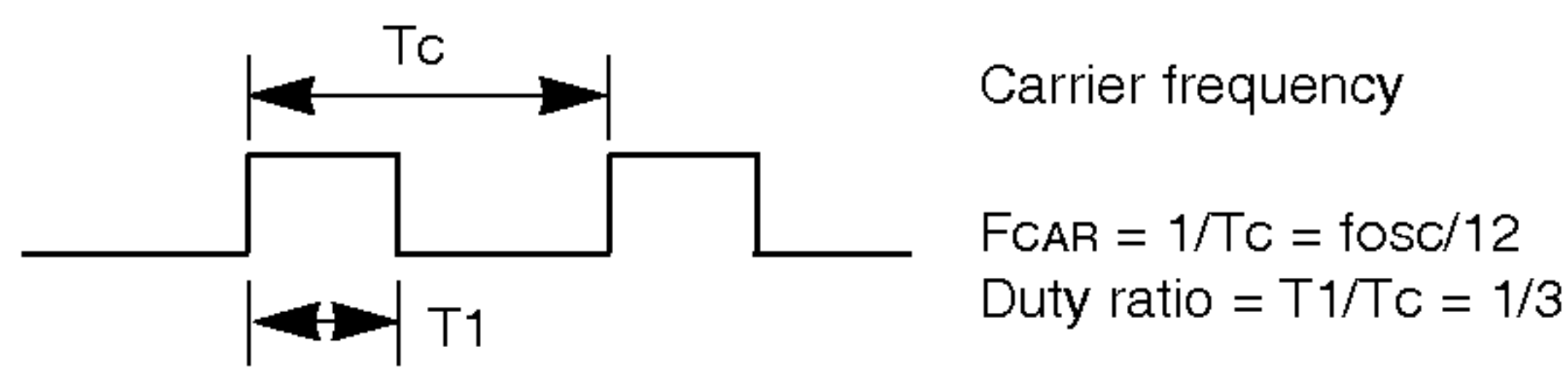

▶ Configuration of frame

- 1st frame

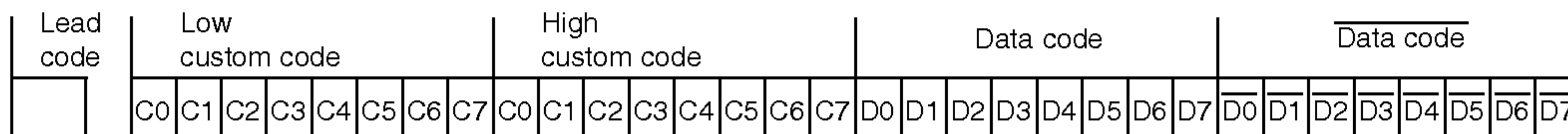

- Repeat frame

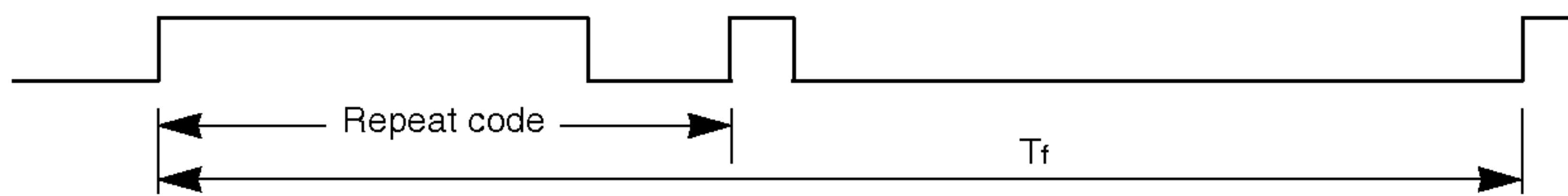

▶ Lead code

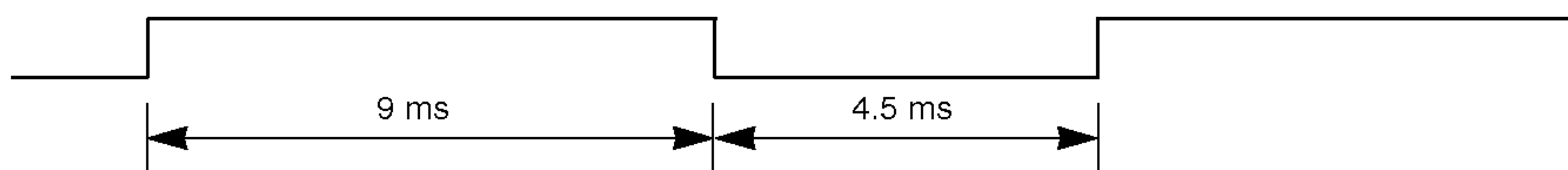

▶ Repeat code

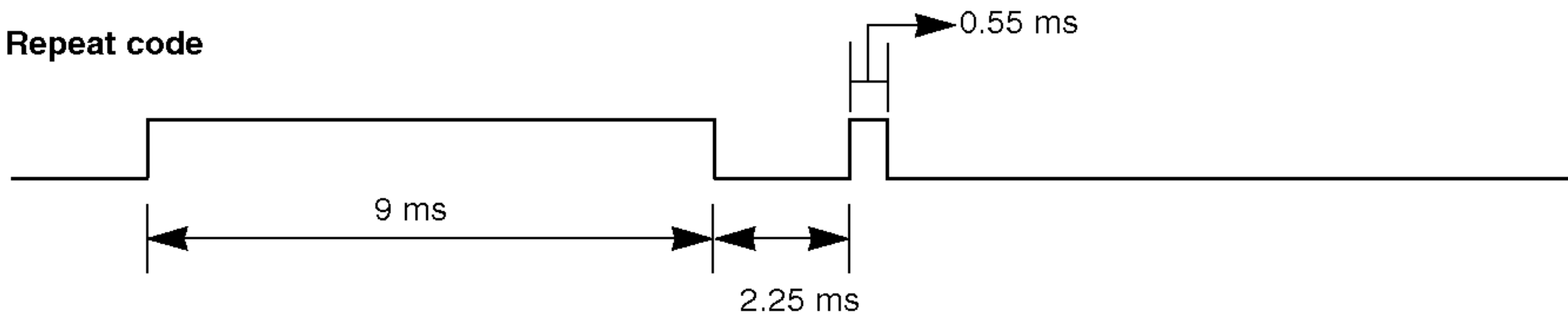

▶ Bit description

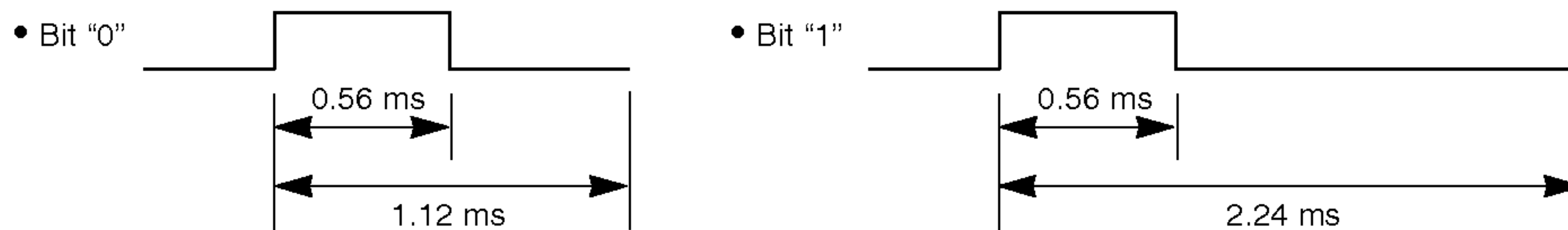

▶ Frame interval : Tf

The waveform is transmitted as long as a key is depressed.

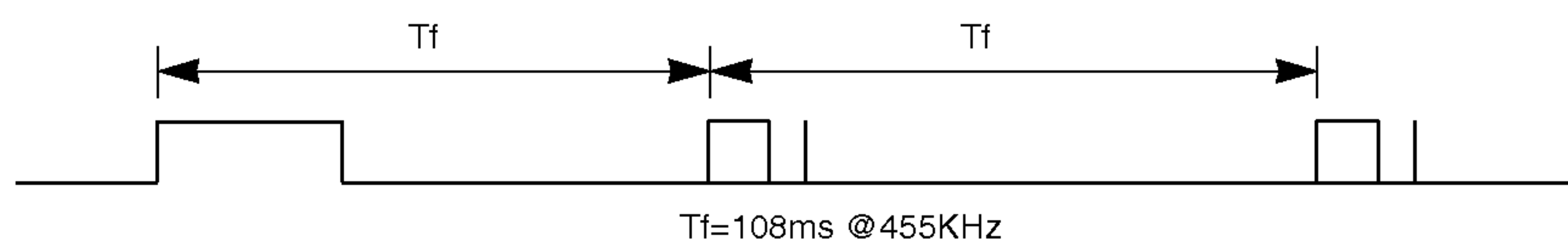

Reference

IR codes

Code (Hexa)	Function	Note
0BH	TV/AV	Remote Control Button
08H	POWER	Remote Control Button
98H	MULTIMEDIA	Remote Control Button
53H	LIST	Remote Control Button
20H	TEXT	Remote Control Button
4DH	PSM	Remote Control Button
52H	SSM	Remote Control Button
0AH	I/II	Remote Control Button
43H	MENU	Remote Control Button
79H	ARC	Remote Control Button
5BH	EXIT	Remote Control Button
07H	◀	Remote Control Button
06H	▶	Remote Control Button
40H	▲	Remote Control Button
41H	▼	Remote Control Button
44H	OK	Remote Control Button
72H	RED	Remote Control Button
71H	GREEN	Remote Control Button
63H	YELLOW	Remote Control Button
61H	BLUE	Remote Control Button
02H	VOL ▲	Remote Control Button
03H	VOL ▼	Remote Control Button
00H	PR ▲	Remote Control Button
01H	PR ▼	Remote Control Button
09H	MUTE	Remote Control Button
1AH	Q.VIEW	Remote Control Button
10H~19H	Number Key 0~ 9	Remote Control Button
0EH	SLEEP	Remote Control Button
26H	TIME	Remote Control Button
24H	MIX	Remote Control Button
2AH	REVEAL	Remote Control Button
22H	MODE	Remote Control Button
62H	UPDATE	Remote Control Button
64H	SIZE	Remote Control Button
65H	HOLD	Remote Control Button
70H	INDEX	Remote Control Button

External Control Device Setup ; RS-232C

- Connect the RS-232C input jack to an external control device (such as a computer or an A/V control system) and control the TV's functions externally.
- Connect the serial port of the control device to the RS-232C jack on the TV back panel.
- RS-232C connection cable is not supplied with the TV.

RS-232C Setup

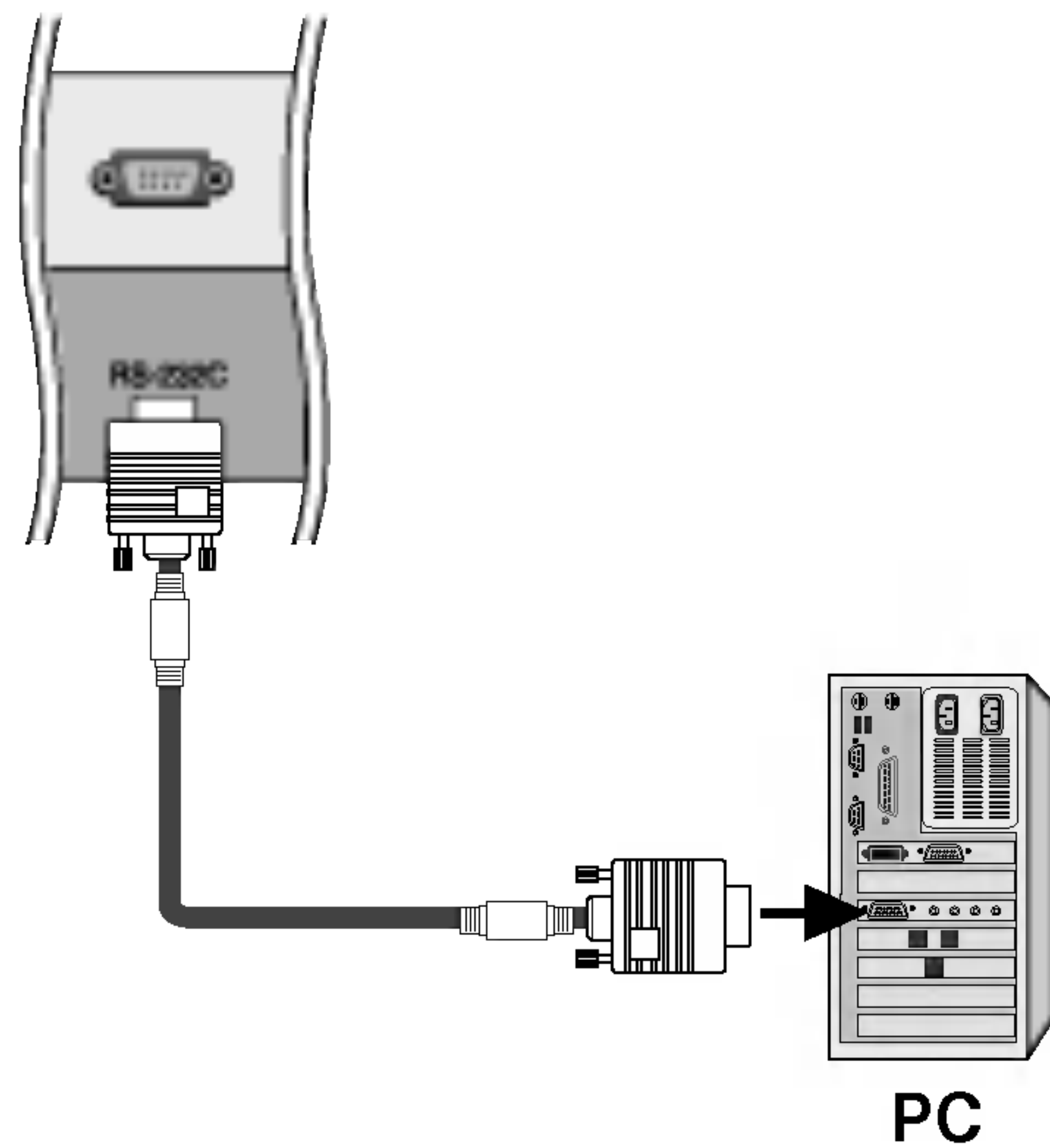

Type of Connector; D-Sub 9-Pin Male

No.	Pin name
1	No connection
2	RXD (Receive data)
3	TXD (Transmit data)
4	DTR (DTE side ready)
5	GND
6	DSR (DCE side ready)
7	RTS (Ready to send)
8	CTS (Clear to send)
9	No Connection

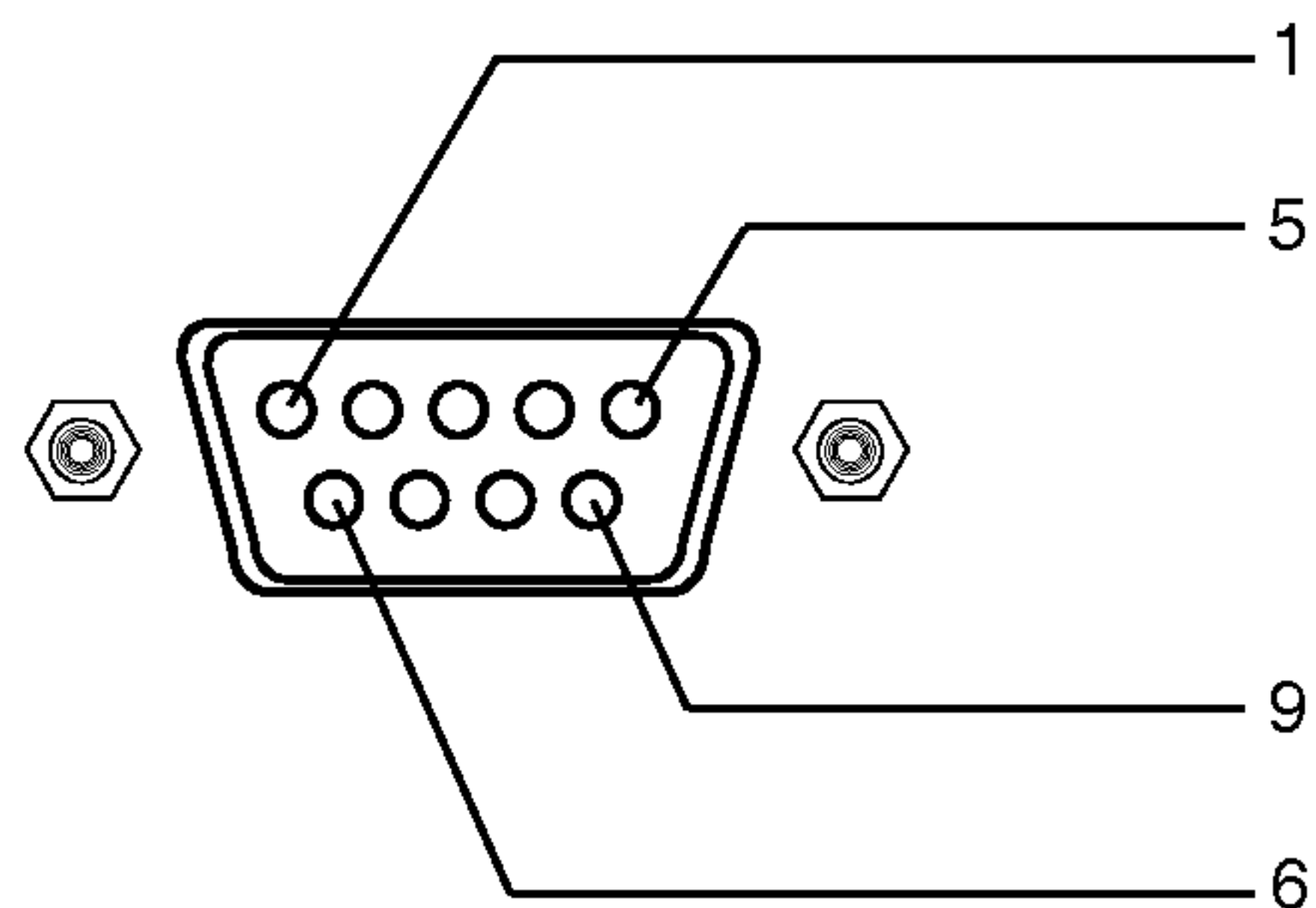

RS-232C Configurations

7-Wire Configurations (Standard RS-232C cable)

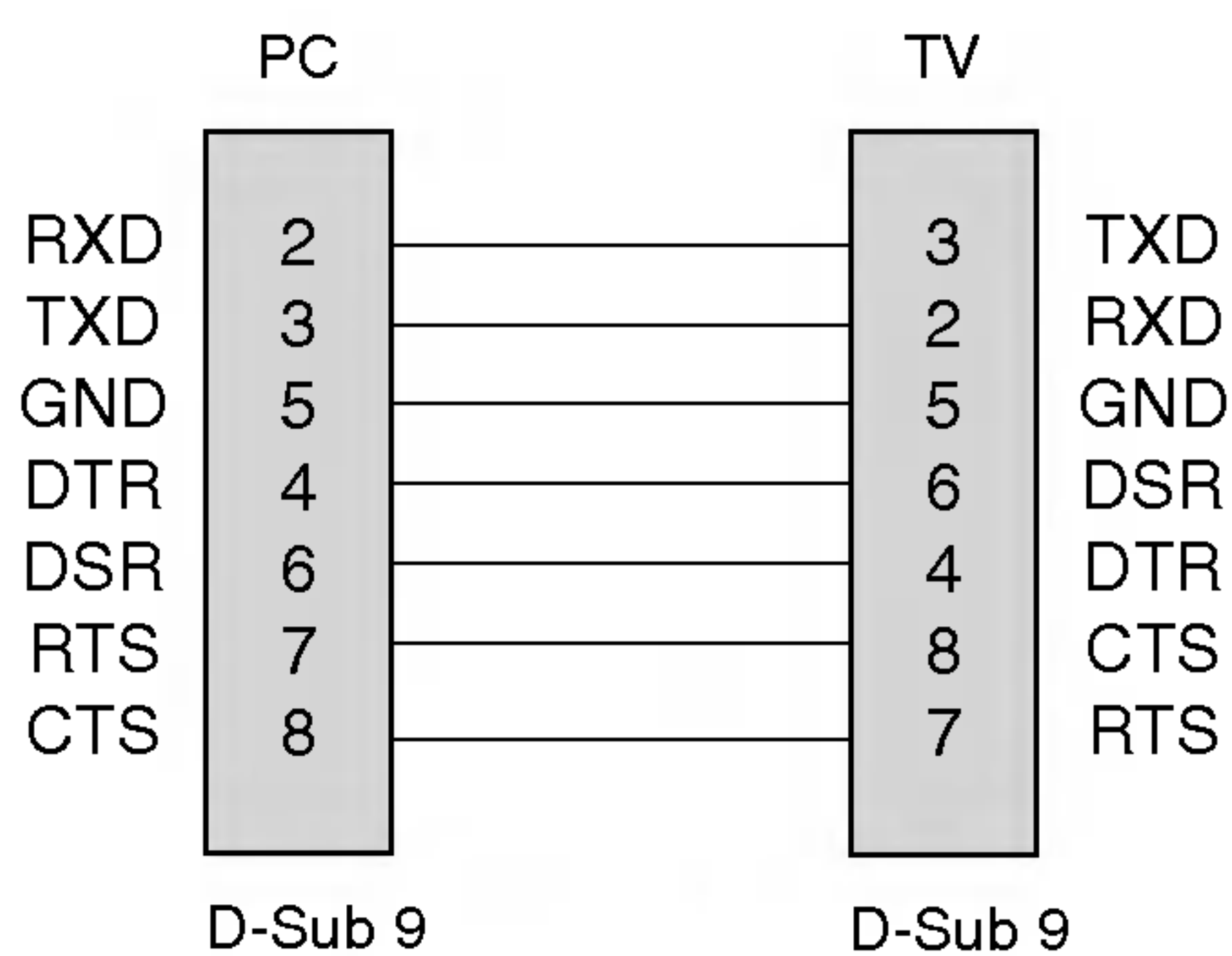

3-Wire Configurations (Not standard)

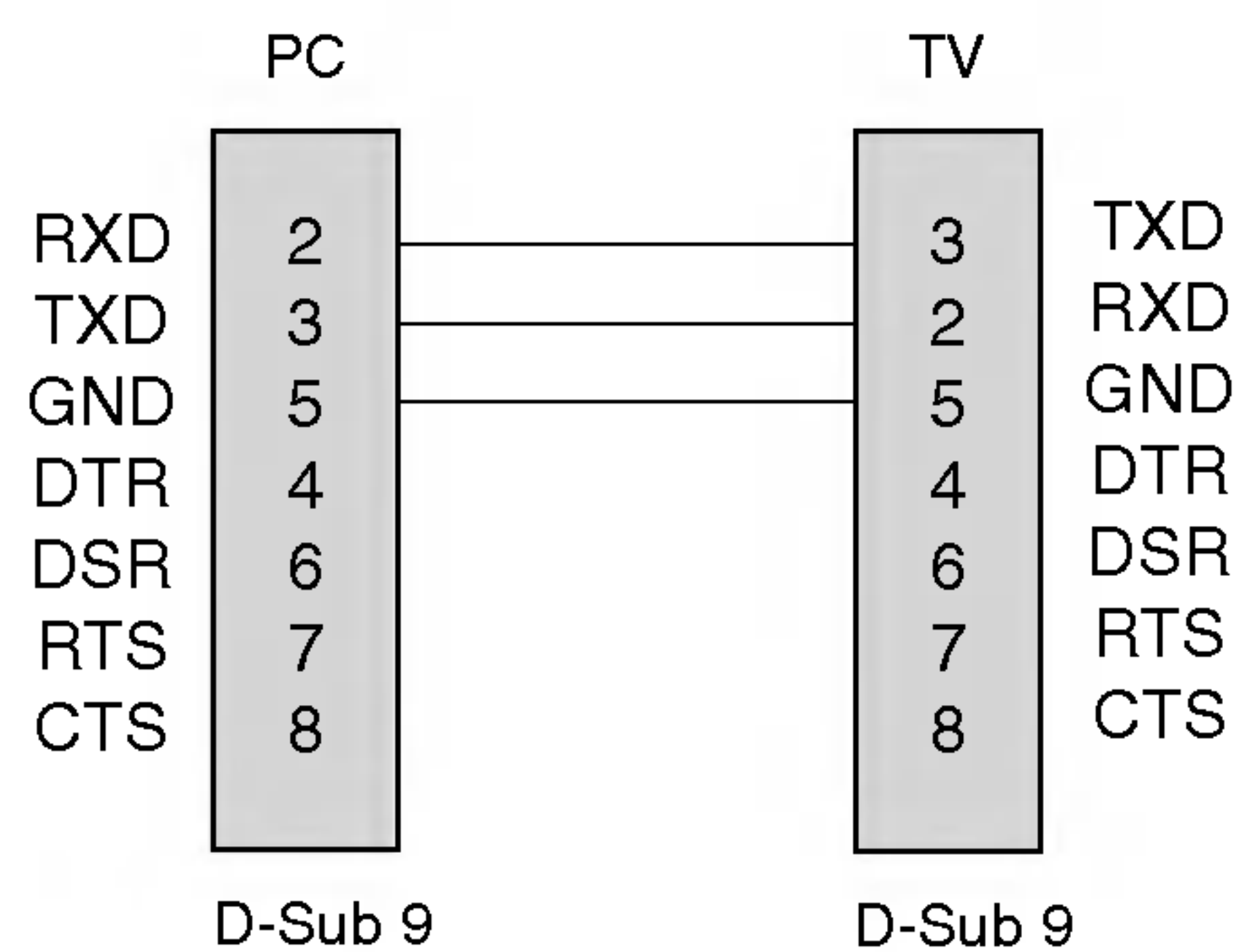

Reference

External Control Device Setup ; RS-232C

Set ID

- Use this function to specify a monitor ID number.
 - Refer to 'Real Data Mapping 1'. See page 67.
1. Press the **MENU** button and then use ▲ / ▼ button to select the **Setup** menu.
 2. Press the ► button and then use ▲ / ▼ button to select **Set ID**.
 3. Press the ► button and then use ◀ / ▶ button to adjust **Set ID** to choose the desired monitor ID number. The adjustment range of **Set ID** is 1 ~ 99.
 4. Press the **OK** button to save.

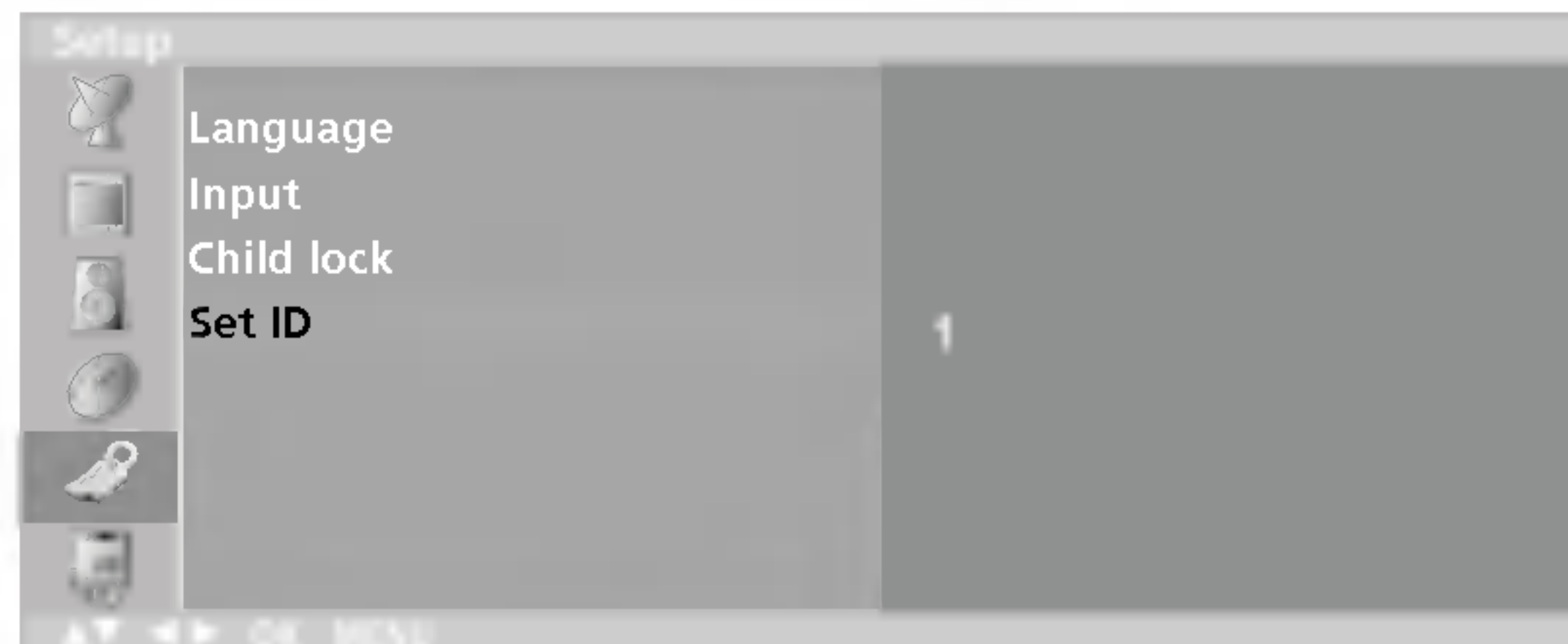

Communication Parameters

- Baud rate : 9600 bps (UART)
- Data length : 8 bits
- Parity : None
- Stop bit : 1 bit
- Communication code : ASCII code

* Use a crossed (reverse) cable.

Command Reference List

	COMMAND 1	COMMAND 2	DATA (Hexa)
01. Power	k	a	0 ~ 1
02. Input Select	k	b	*
03. Aspect Ratio	k	c	0 ~ 6
04. Screen Mute	k	d	0 ~ 1
05. Volume Mute	k	e	0 ~ 1
06. Volume Control	k	f	0 ~ 64
07. Contrast	k	g	0 ~ 64
08. Brightness	k	h	0 ~ 64
09. Colour	k	i	0 ~ 64
10. Tint	k	j	0 ~ 64
11. Sharpness	k	k	0 ~ 64
12. OSD Select	k	l	0 ~ 1
13. Key Lock	k	m	0 ~ 1
14. Balance	k	t	0 ~ 64
15. Tune Command	m	a	0 ~ 63
16. Skip programme	m	b	0~1
17. Key	m	c	Key Code

* : Refer to '02. Input Select' on page 67

Transmission / Receiving Protocol

Transmission

[Command1][Command2][][Set ID][][Data][Cr]

- * [Command 1]: First command. (m or k)
- * [Command 2]: Second command.
- * [Set ID]: You can adjust the set ID to choose desired monitor ID number in Special menu. Adjustment range is 1 ~ 99. When selecting Set ID '0', every connected TV set is controlled. Set ID is indicated as decimal (1~99) on menu and as Hexa decimal (0x0~0x63) on transmission/receiving protocol.
- * [DATA]: To transmit command data.
Transmit 'FF' data to read status of command.
- * [Cr]: Carriage Return
ASCII code '0x0D'
- * []: ASCII code 'space (0x20)'

OK Acknowledgement

[Command2][][Set ID][][OK][Data][x]

- * The Monitor transmits ACK (acknowledgement) based on this format when receiving normal data. At this time, if the data is data read mode, it indicates present status data. If the data is data write mode, it returns the data of the PC computer.

Error Acknowledgement

[Command2][][Set ID][][NG][Data][x]

- * The Monitor transmits ACK (acknowledgement) based on this format when receiving abnormal data from non-viable functions or communication errors.

01. Power On (Command:a)

- ▶ To control Power On/Off of the TV.

Transmission

[k][a][][Set ID][][Data][Cr]

Data 0 : Power Off 1 : Power On

Acknowledgement

[a][][Set ID][][OK][Data][x]

- ▶ To show Power On/Off.

Transmission

[k][a][][Set ID][][FF][Cr]

Acknowledgement

[a][][Set ID][][OK][Data][x]

Data 0 : Power Off 1 : Power On

02. Input Select (Command:b) (Main Picture Input)

- ▶ To select input source for the TV.
You can also select an input source using the TV/AV button on the TV's remote control.

Transmission

[k][b][][Set ID][][Data][Cr]

Data 10 : TV 40 : DVD
 20 : AV1 41 : Component
 21 : AV2 60 : PC
 30 : S-Video

Acknowledgement

[b][][Set ID][][OK][Data][x]

03. Aspect Ratio (Command:c) (Main picture format)

- ▶ To adjust the screen format.
You can also adjust the screen format using the ARC (Aspect Ratio Control) button on remote control or in the Screen menu.

Transmission

[k][c][][Set ID][][Data][Cr]

Data 0 : Normal screen (4:3) 3 : Zoom
 1 : Wide screen (16:9) 4 : Spectacle
 2 : 14:9 6 : Original

* In **PC** mode only 16:9 and 4:3 aspect ratios are available.

* In **Component** or **DVD** mode, Spectacle and Original aspect ratios are not available.

Acknowledgement

[c][][Set ID][][OK][Data][x]

04. Screen Mute (Command:d)

- ▶ To select screen mute on/off.

Transmission

[k][d][][Set ID][][Data][Cr]

Data 0 : Screen mute off (Picture on)
 1 : Screen mute on (Picture off)

05. Volume Mute (Command:e)

- ▶ To control volume mute on/off.
You can also adjust mute using the MUTE button on remote control.

Transmission

[k][e][][Set ID][][Data][Cr]

Data 0 : Volume mute off (Volume on)
 1 : Volume mute on (Volume off)

Acknowledgement

[e][][Set ID][][OK][Data][x]

06. Volume Control (Command:f)

- ▶ To adjust volume.
You can also adjust volume with the volume buttons on remote control.

Transmission

[k][f][][Set ID][][Data][Cr]

Data Min : 0 ~ Max : 64

- Refer to 'Real data mapping 1' as shown below.

Acknowledgement

[f][][Set ID][][OK][Data][x]

07. Contrast (Command:g)

- ▶ To adjust screen contrast.
You can also adjust contrast in the Picture menu.

Transmission

[k][g][][Set ID][][Data][Cr]

Data Min : 0 ~ Max : 64

- Refer to 'Real data mapping 1' as shown below.

Acknowledgement

[g][][Set ID][][OK][Data][x]

08. Brightness (Command:h)

- ▶ To adjust screen brightness.
You can also adjust brightness in the Picture menu.

Transmission

[k][h][][Set ID][][Data][Cr]

Data Min : 0 ~ Max : 64

- Refer to 'Real data mapping 1' as shown below.

Acknowledgement

[h][][Set ID][][OK][Data][x]

* Real data mapping 1

0 : Step 0

⋮

A : Step 10

⋮

F : Step 15

10 : Step 16

⋮

64 : Step 100

* Tint : -50 ~ +50

* Balance : -50 ~ +50

Reference

External Control Device Setup ; RS-232C

09. Colour (Command:i)

- ▶ To adjust the screen colour.
You can also adjust colour in the Picture menu.

Transmission

```
[k][i][ ][Set ID][ ][Data][Cr]
```

Data Min : 0 ~ Max : 64

- Refer to 'Real data mapping 1'. See page 67.

Acknowledgement

```
[i][ ][Set ID][ ][OK][Data][x]
```

10. Tint (Command:j)

- ▶ To adjust the screen tint.(NTSC M input only)
You can also adjust tint in the Picture menu.

Transmission

```
[k][j][ ][Set ID][ ][Data][Cr]
```

Data :Green 0 ~ Red : 64

- Refer to 'Real data mapping 1'. See page 67.

Acknowledgement

```
[j][ ][Set ID][ ][OK][Data][x]
```

11. Sharpness (Command:k)

- ▶ To adjust the screen sharpness.
You can also adjust sharpness in the Picture menu.

Transmission

```
[k][k][ ][Set ID][ ][Data][Cr]
```

Data Min: 0 ~ Max: 64

- Refer to 'Real data mapping 1'. See page 67.

Acknowledgement

```
[k][ ][Set ID][ ][OK][Data][x]
```

12. OSD Select (Command:l)

- ▶ To select OSD (On Screen Display) mute on/off.

Transmission

```
[k][l][ ][Set ID][ ][Data][Cr]
```

Data 0: OSD mute on 1: OSD mute off

Acknowledgement

```
[l][ ][Set ID][ ][OK][Data][x]
```

13. Key Lock (Command:m)

- ▶ To lock the remote control and the front panel controls on the TV.

Transmission

```
[k][m][ ][Set ID][ ][Data][Cr]
```

Data 0: Lock off 1: Lock on

Acknowledgement

```
[m][ ][Set ID][ ][OK][Data][x]
```

- If you're not using the remote control and front panel controls on the TV, use this mode. When main power is on/off, remote control lock is released.

14. Balance (Command:t)

- ▶ To adjust balance.

Transmission

```
[k][t][ ][Set ID][ ][Data][Cr]
```

Data Min: 0 ~ Max: 64 (transmit by Hexadecimal code)

- Refer to 'Real data mapping 1'. See page 67.

Acknowledgement

```
[t][ ][Set ID][ ][OK][Data][x]
```

15. Tune Command (Command:m a)

- ▶ Tune channel to following Physical/major/minor number.

Transmission

```
[m][a][ ][Set ID][ ][Data0][ ][Cr]
```

Data0: Programme Number

Min : 0 ~ Max : 63(transmit by Hexadecimal code)

Acknowledgement

```
[a][ ][Set ID][ ][OK][Data0][x]  
[a][ ][Set ID][ ][NG][Data0][x]
```

16. Skip programme (Command:m b)

- ▶ To skip the current programme.

Transmission

```
[m][b][ ][Set ID][ ][Data 0][Cr]
```

Data0: (Programme)Skip on-0, (Programme)Skip off-1

Acknowledgement

```
[b][ ][Set ID][ ][OK][Data0][x]  
[b][ ][Set ID][ ][NG][Data0][x]
```

17. Key (Command:m c)

- ▶ To send IR remote key code.

Transmission

```
[m][c][ ][Set ID][ ][Data][Cr]
```

Data: Key code (Refer to P.64)

Acknowledgement

```
[c][ ][Set ID][ ][OK][Data][x]
```

