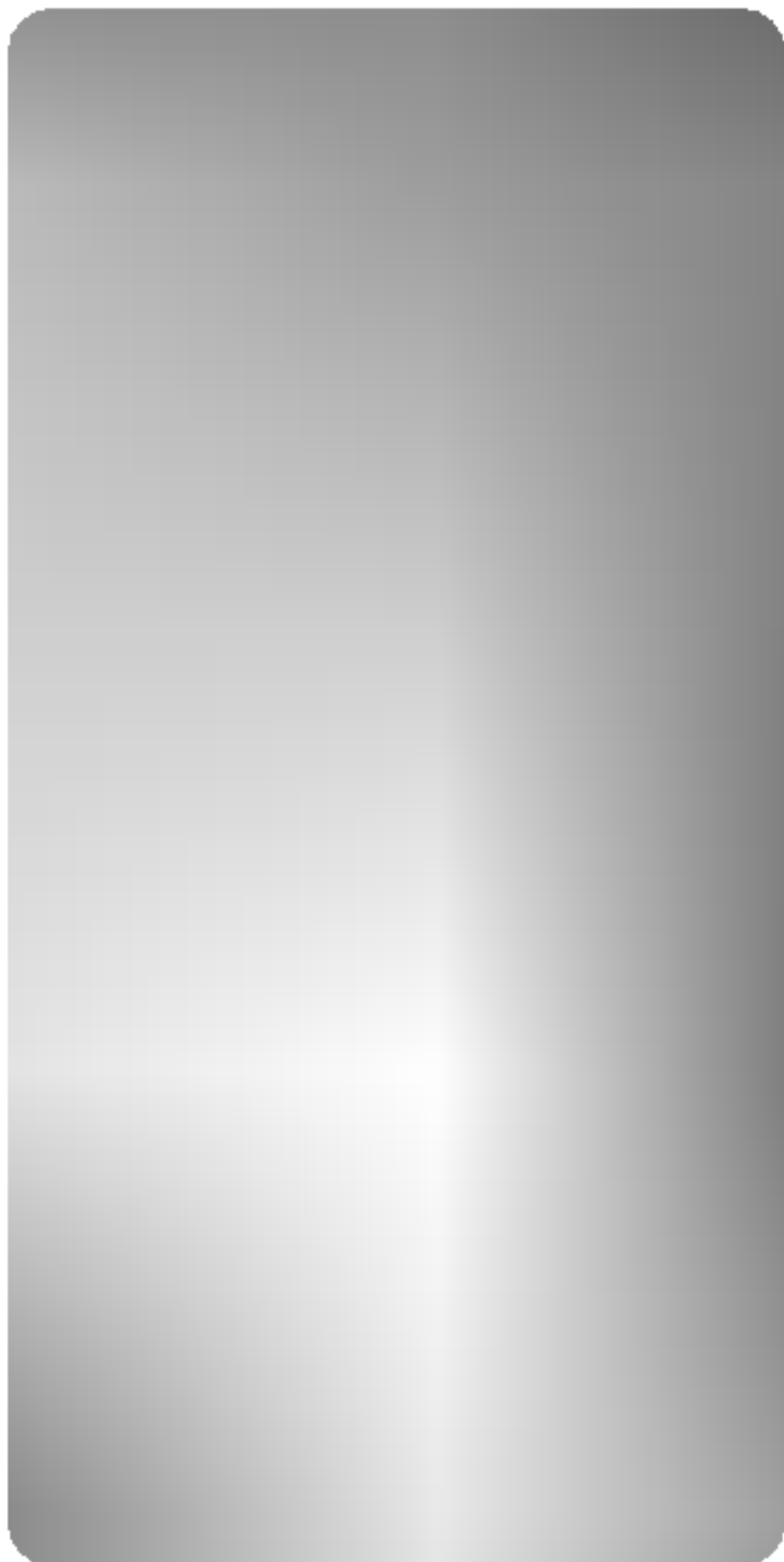

Table of Contents



Safety Precautions

Accessories

Using the Remote Control

To arrange cables in order - Optional

Connecting the Speakers - Optional

Name and Function of the Parts

Connecting to External Devices

- When Connecting to your PC
- When Watching VCR/DVD
- When Watching HDTV (720p/1080i)
- When Watching DVD (480i)
- When Watching DVI-D(HDCP) from the DVD/SET-TOP BOX
- Watching AV Outputs

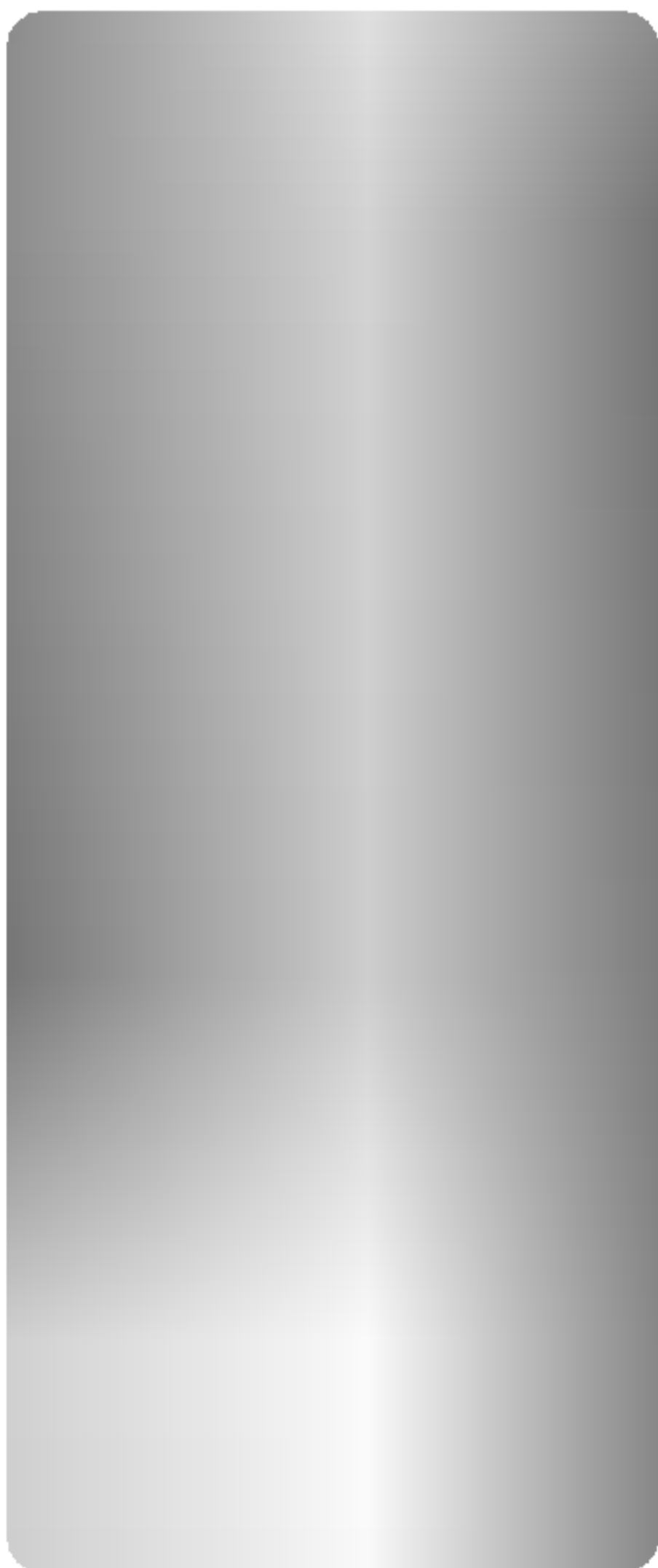
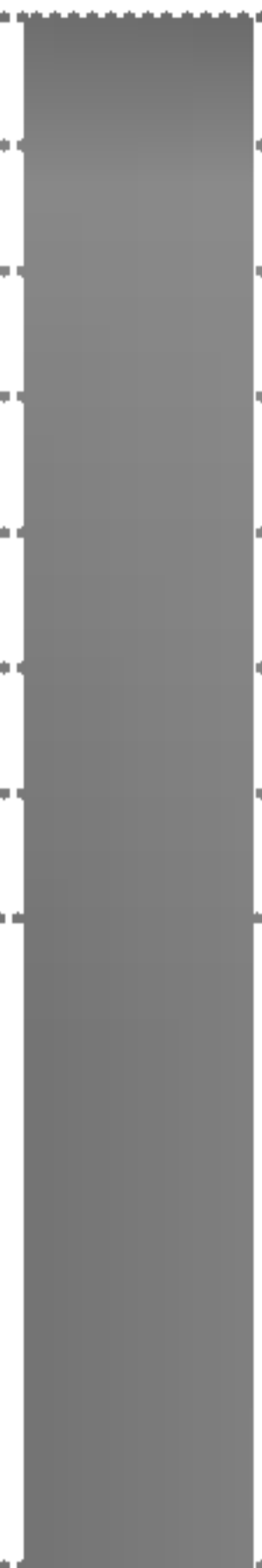

Selecting and Adjusting the Screen

How to adjust the OSD (On Screen Display) Screen

- Adjusting Screen Color
- Adjusting the audio function
- Selecting the Options
- Adjusting Screen CLOCK/PHASE and Position
- Adjusting PIP/POP/PBP Mode (Multiple Screen) Functions



Controlling the Multiple Products (RS-232C protocol)

IR Code

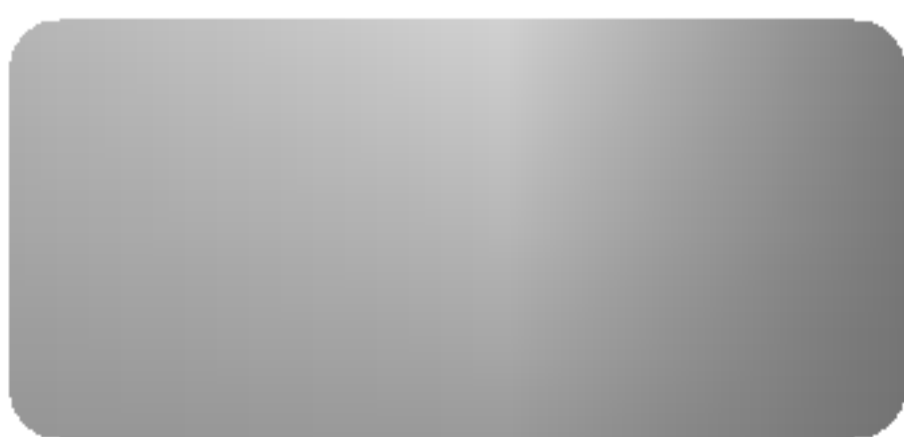

Troubleshooting

Specifications

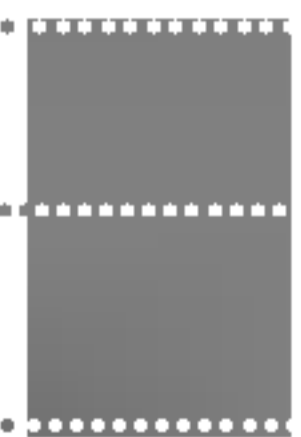

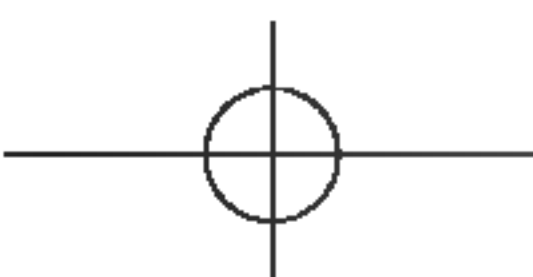

is a trademark of SRS Labs, Inc.
technology is incorporated under license from SRS Labs, Inc.

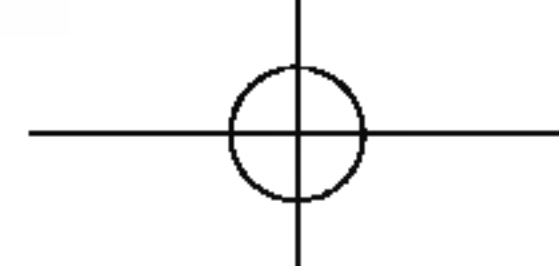



Please read these safety precautions carefully before using the product.

 **Warning** If you ignore the warning message, you may be seriously injured or there is a possibility of accident or death.

 **Caution** If you ignore the caution message, you may be slightly injured or the product may be damaged

Precautions in installing the Product

Warning

- **Keep away from heat sources like electrical heaters.**
 - Electrical shock, fire, malfunction or deformation may occur.
- **Keep the packing anti-moisture material or vinyl packing out of the reach of children.**
 - Anti-moisture material is harmful if swallowed. If swallowed by mistake, force the patient to vomit and visit the nearest hospital. Additionally, vinyl packing can cause suffocation. Keep it out of the reach of children.
- **Do not put heavy objects on the product or sit upon it.**
 - If the product collapses or is dropped, you may be injured. Children must pay particular attention.
- **Do not leave the power or signal cable unattended on the pathway.**
 - The passerby can falter, which can cause electrical shock, fire, product breakdown or injury.
- **Install the product in a neat and dry place.**
 - Dust or moisture can cause electrical shock, fire or product damage.
- **If you can smell smoke or other odors or hear a strange sound unplug the power cord and contact the service center.**
 - If you continue to use without taking proper measures, electrical shock or fire can occur.
- **If you dropped the product or the case is broken, turn off the product and unplug the power cord.**
 - If you continue to use without taking proper measures, electrical shock or fire can occur. Contact the service center.
- **Do not drop metallic objects such as coins, hair pins, chopsticks or wire into the product, or inflammable objects such as paper and matches. Children must pay particular attention.**
 - Electrical shock, fire or injury can occur. If a foreign object is dropped into the product, unplug the power cord and contact the service center.

Caution

- **Make sure the product ventilation hole is not blocked. Install the product in a suitably wide place (more than 10cm from the wall)**
 - If you install the product too close to the wall, it may be deformed or fire can break out due to internal heat.
- **Do not block the ventilation hole of the product by a tablecloth or curtain.**
 - The product can be deformed or fire can break out due to overheating inside the product.
- **Install the product on a flat and stable place that has no risk of dropping the product.**
 - If the product is dropped, you may be injured or the product may be broken.
- **Install the product where no EMI occurs.**
- **Keep the product away from direct sunlight.**
 - The product can be damaged.

Electrical Power Related Precautions

Warning

- **Make sure to connect the power cable to the grounded current.**
 - You may be electrocuted or injured.
- **Use the rated voltage only.**
 - The product can be damaged, or you may be electrocuted.
- **During a thunder or lightning storm, unplug the power cable or signal cable.**
 - You may be electrocuted or a fire can break out.
- **Do not connect several extension cords, electrical appliances or electrical heaters to a single outlet. Use a power bar with a grounding terminal designed for exclusive use with the computer.**
 - A fire can break out due to overheating.
- **Do not touch the power plug with wet hands. Additionally, if the cord pin is wet or covered with dust, dry the power plug completely or wipe dust off.**
 - You may be electrocuted due to excess moisture.
- **If you don't intend to use the product for a long time, unplug the power cable from the product.**
 - Covering dust can cause a fire, or insulation deterioration can cause electric leakage, electric shock or fire.
- **Fix the power cable completely.**
 - If the power cable is not fixed completely, a fire can break out.
- **Hold the plug when pulling out the power cable. Do not bend the power cord with excessive force or put heavy objects on the power cord.**
 - The power line can be damaged, which may cause electric shock or fire.
- **Do not insert a conductor (like a metal chopstick) into one end of the power cable while the other end is connected to the input terminal on the wall. Additionally, do not touch the power cable right after plugging into the wall input terminal.**
 - You may be electrocuted.
- **The power supply cord is used as the main disconnection device. Ensure that the socket-outlet is easily accessible after installation.**

Caution

- **Do not unplug the power cord while the product is in use.**
 - Electrical shock can damage the product.

Precautions in Moving the Product

Warning

- **Make sure to turn off the product.**
 - You may be electrocuted or the product can be damaged.
- **Make sure to remove all cables before moving the product.**
 - You may be electrocuted or the product can be damaged.

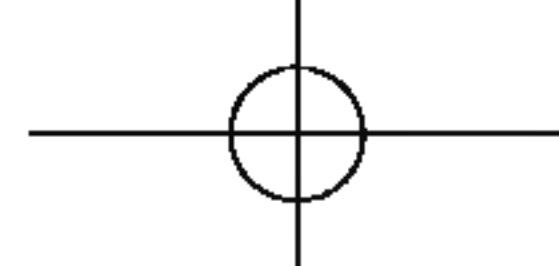

Caution

- **Do not shock the product when moving it.**
 - You may be electrocuted or the product can be damaged
- **Do not dispose the product-packing box. Use it when you move.**
- **Make the panel face forward and hold it with both hands to move.**
 - If you drop the product, the damaged product can cause electric shock or fire. Contact with the service center for repair.

Precautions in Using the Product

Warning

- **Do not disassemble, repair or modify the product at your own discretion.**
 - Fire or electric shock accident can occur.
 - Contact the service center for check, calibration or repair.
- **Do not spray water on the product or scrub with an inflammable substance (thinner or benzene). Fire or electric shock accident can occur**
- **Keep the product away from water.**
 - Fire or electric shock accident can occur.

Caution

- **Do not put or store inflammable substances near the product.**
 - There is a danger of explosion or fire due careless handling of the inflammable substances.
- **When cleaning the brown tube surface, unplug the power cord and scrub with soft cloth to prevent scratching. Do not clean with a wet cloth.**
 - The water can sink into the product, which can cause electric shock or serious malfunction.
- **Take a rest from time to time to protect your vision.**
- **Keep the product clean at all times.**
- **Take a comfortable and natural position when working with a product to relax the muscles.**
- **Take a regular break when working with a product for a long time.**
- **Do not press strongly upon the panel with a hand or sharp object such as nail, pencil or pen, or make a scratch on it.**
- **Keep proper distance from the product.**
 - Your vision may be impaired if you look at the product too closely.
- **Set the appropriate resolution and clock by referring to the User's Guide.**
 - Your vision can be impaired.
- **Use authorized detergent only when cleaning the product. (Do not use benzene, thinner or alcohol.)**
 - Product can be deformed.

On Disposal

- The fluorescent lamp used in this product contains a small amount of mercury.
- Do not dispose of this product with general household waste.
Disposal of this product must be carried out in accordance to the regulations of your local authority.

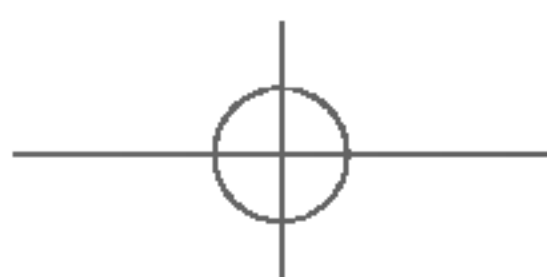

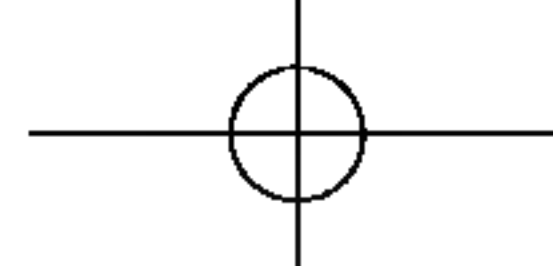

Please check the accessories in the product package.

*** The product and the accessories can be different from the figures shown here.**

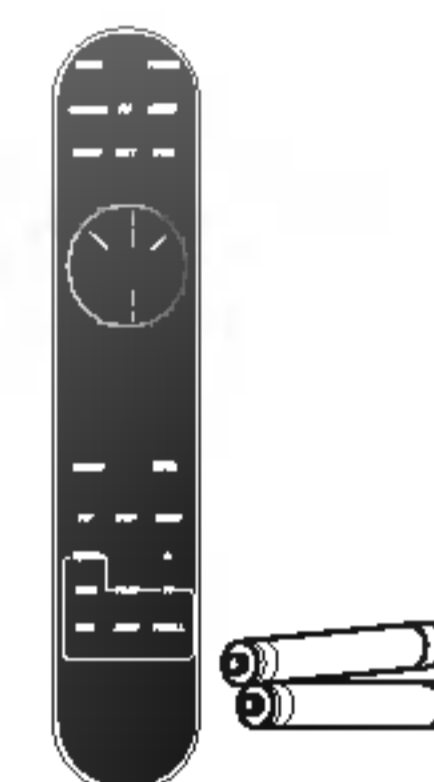
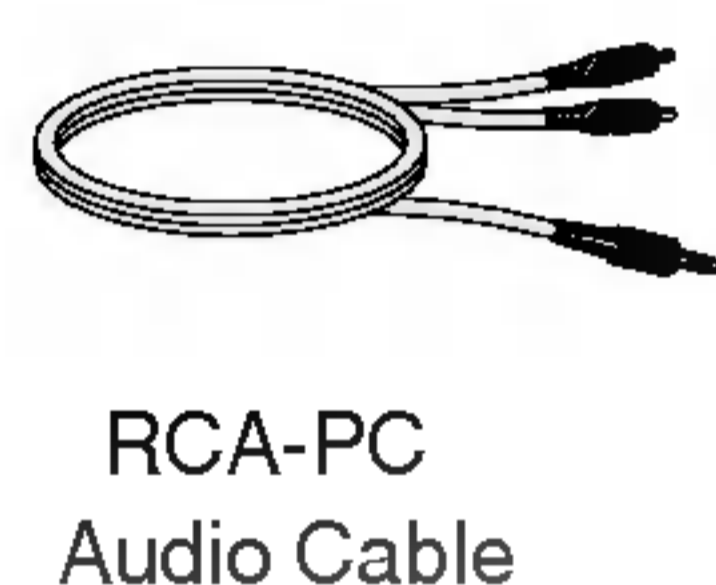
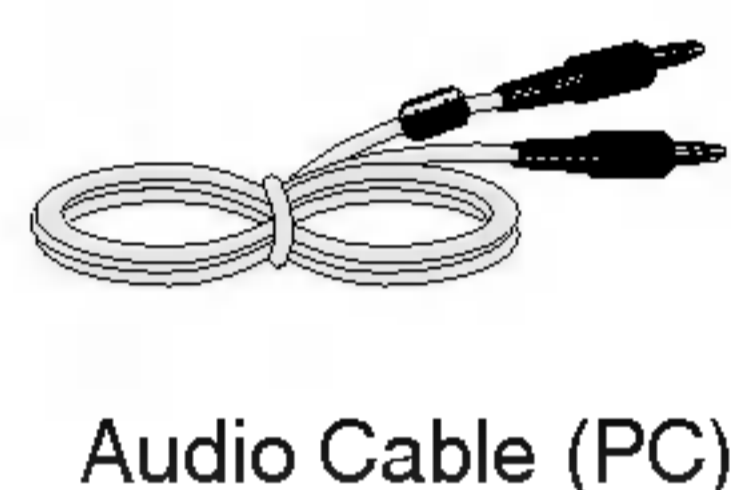
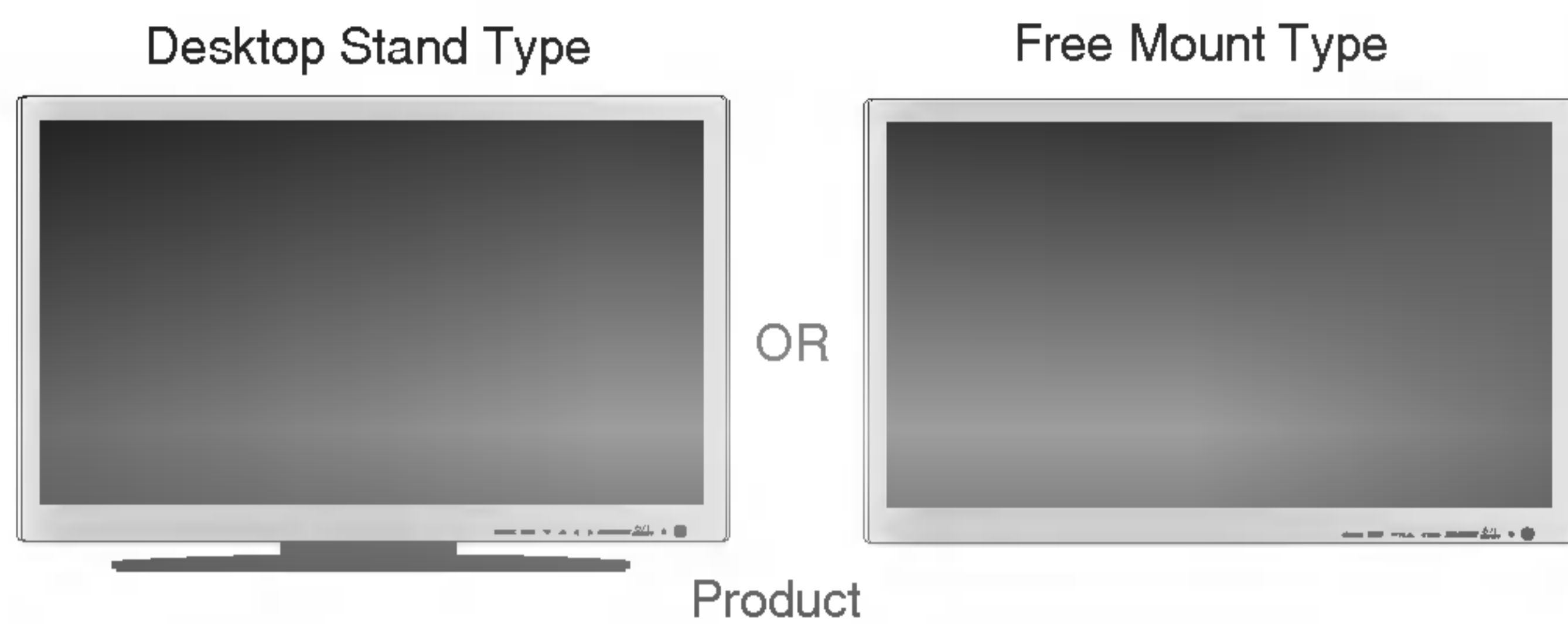

Remote Control/
Batteries

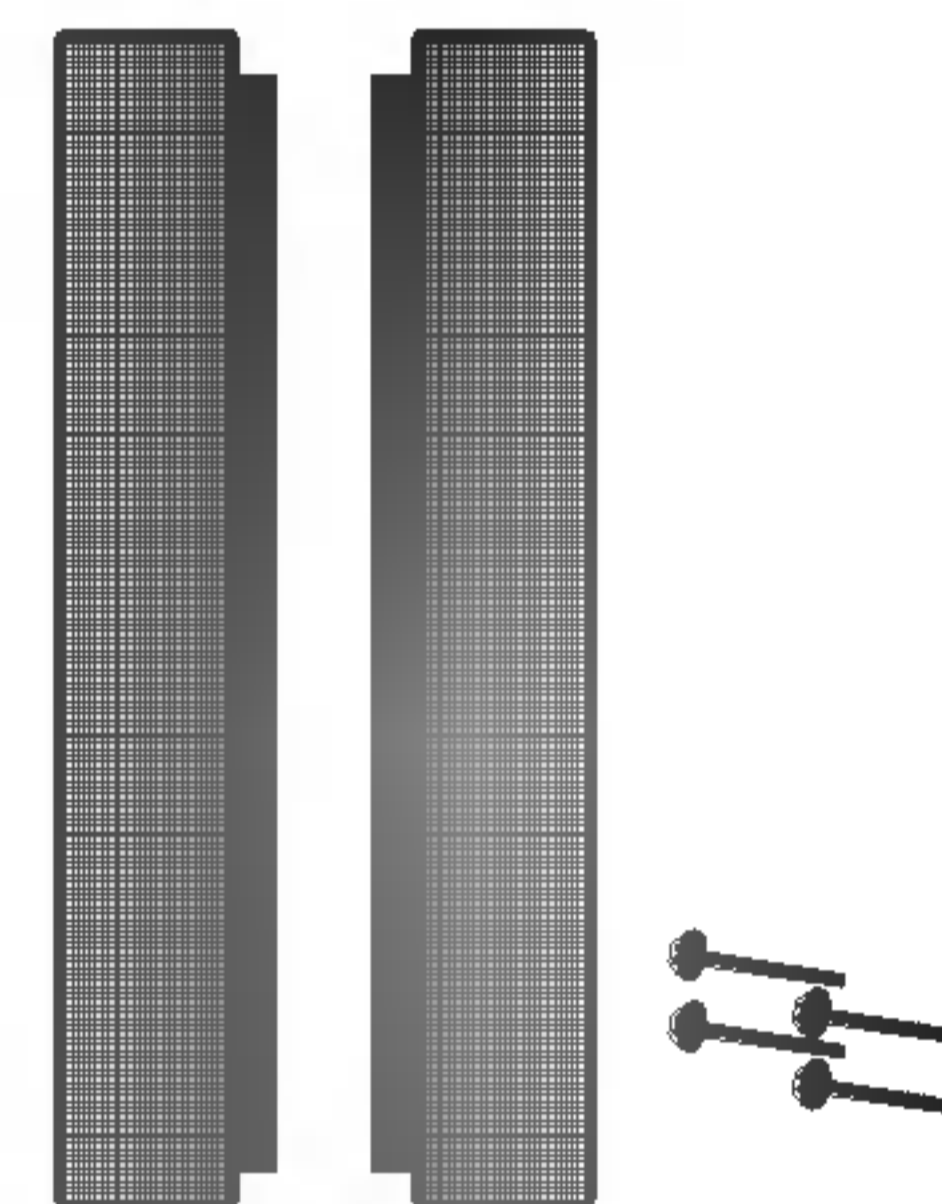

Speaker kit / Screws
(Applicable only for models
that support the speakers)

Optional

Wall-mount Rack

Please refer to the enclosed "Installation Guide" when installing the wall-mount rack.

Inserting batteries into remote control.

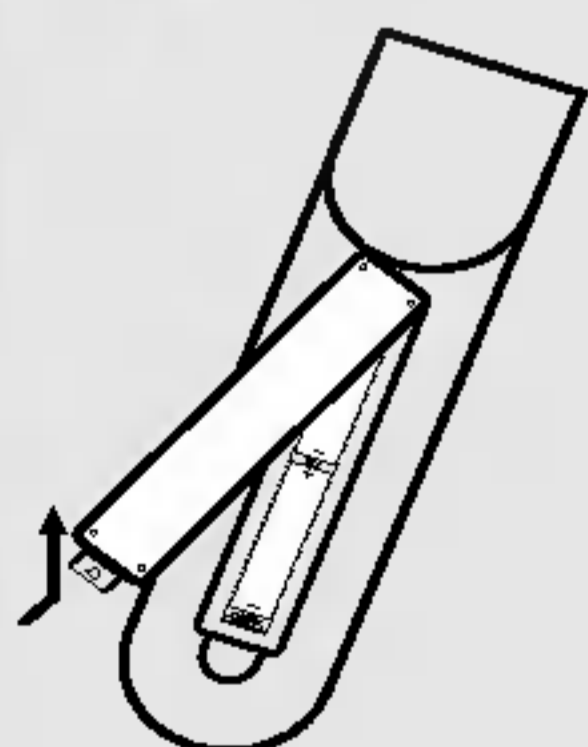

1. Take out the battery cap.
2. Insert batteries with correct polarity (+/-).
3. Close the battery cap.
 - You can use a remote control 7 meter distance and 30 degree (left/right) within the receiving unit scope.
 - Dispose of used batteries in the recycle bin to prevent environmental pollution.

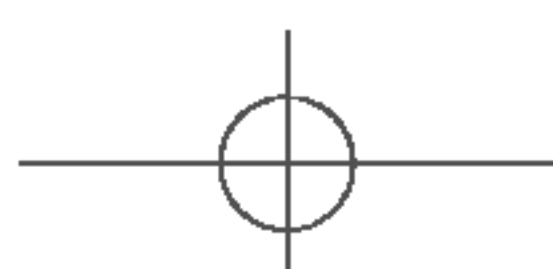

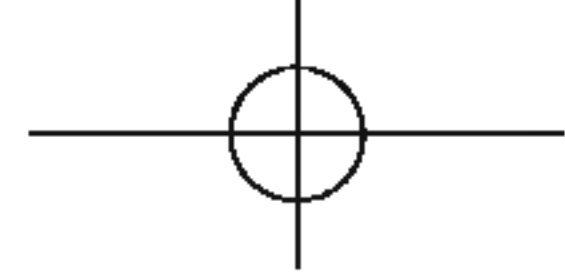

● Name of the Remote Control Buttons

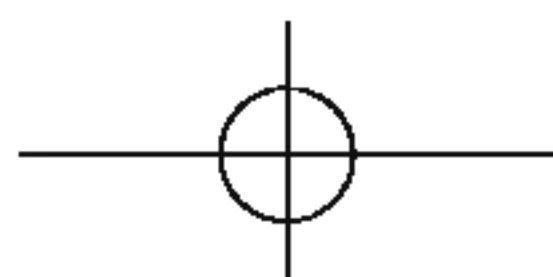
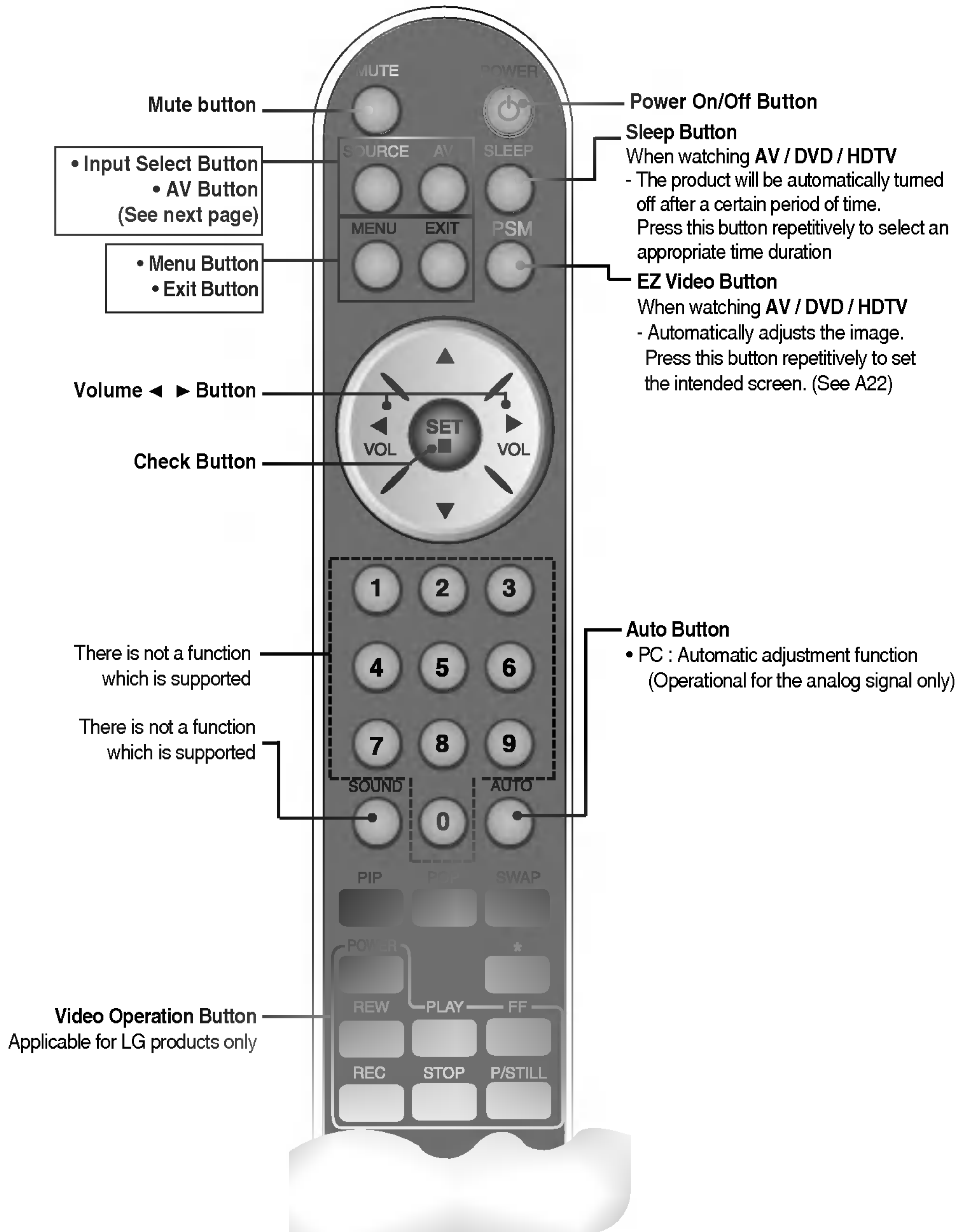

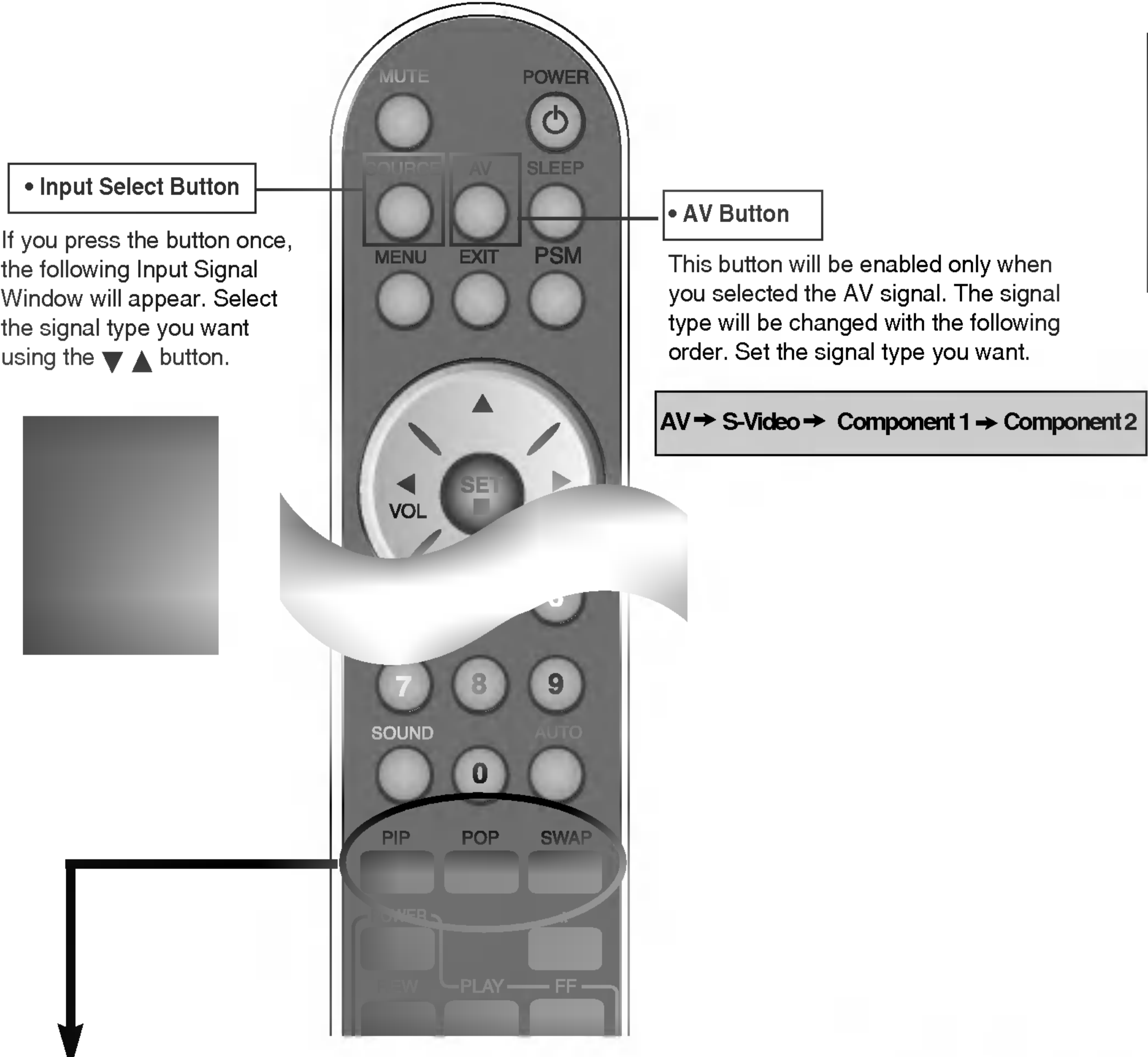
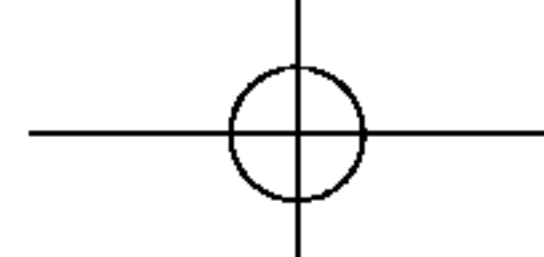

1. PIP (Picture in Picture) Button

The sub-screen moves to the next mode whenever you press this button.
: SMALL -> MEDIUM -> LARGE -> OFF

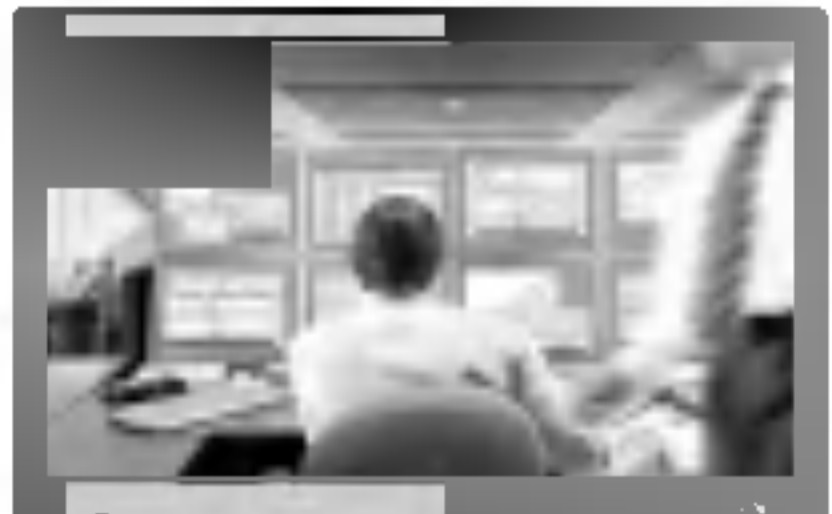

PIP

2. POP (Picture out Picture) Button

The sub-screen moves to the next mode whenever you press this button.
: POP ON -> PBP(FULL) -> PBP(4:3) -> OFF



POP ON



PBP (FULL)



PBP (4:3)



Note

• Case 1 / Case 2
Different descriptions are applicable depending on the type of AV option board selected (an optional product).

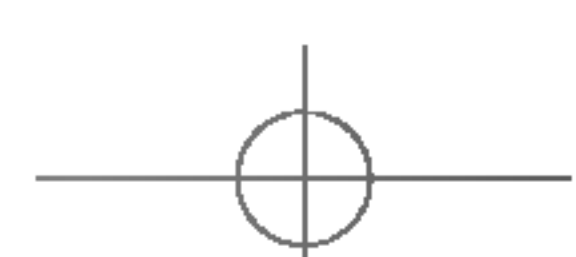

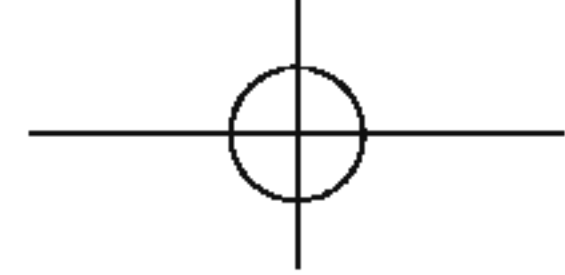

3. SWAP Button

You can swap the main screen and the sub-screen when the PIP/POP/PBP function is used.

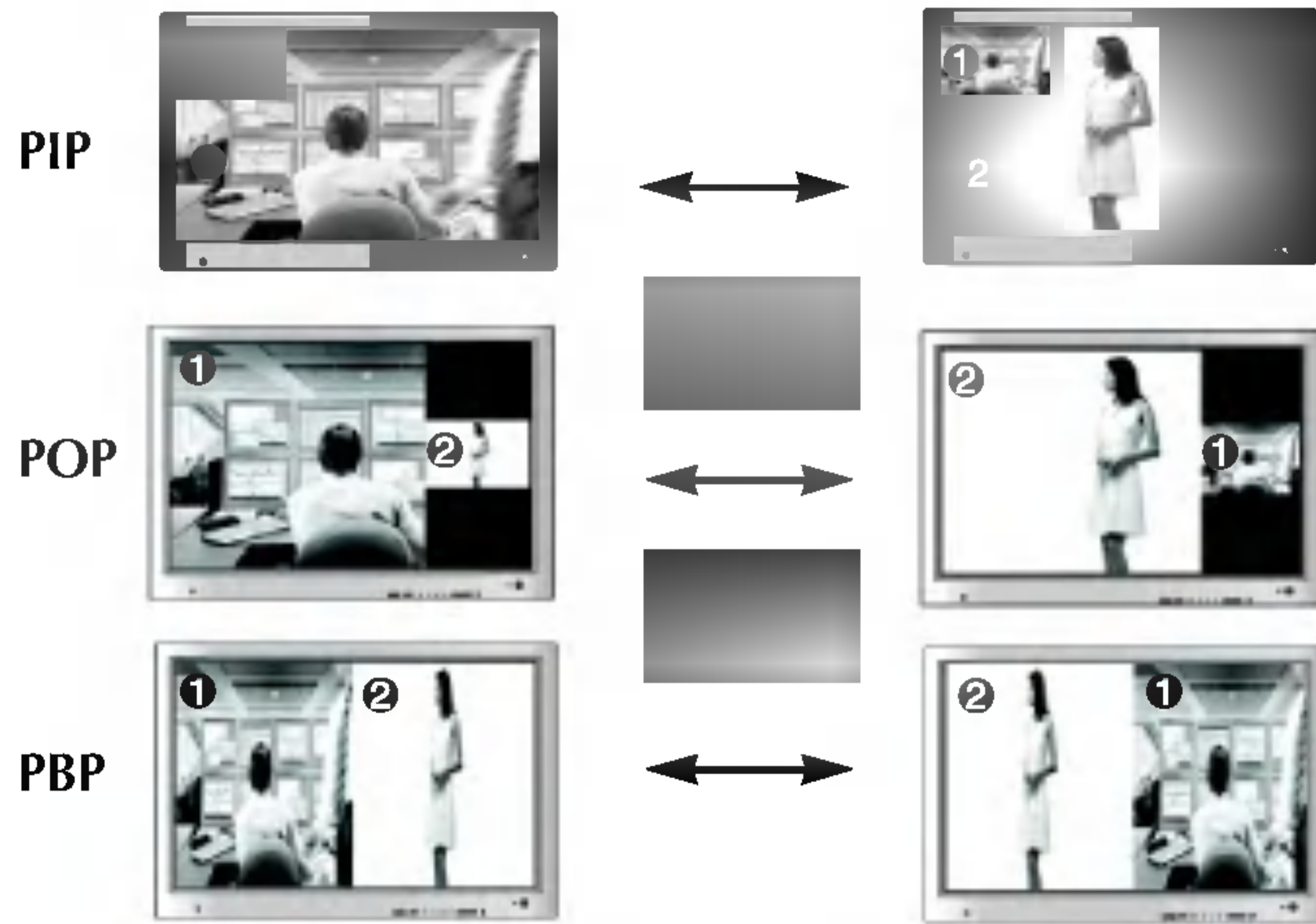

When 'Input Signal 1' comes on in the main screen, only 'Input Signal 2' can be displayed on the sub-screen. On the contrary, if the main screen displays 'Input Signal 2', the sub-screen can display 'Input Signal 1' only. You can swap 'Input Signal 1' and 'Input Signal 2' using the SWAP button.

*PIP function is not supported in 480i, 576i and 1080i modes.

<Table of PIP/POP/PBP Function Support>

Main Screen / Sub-Screen	AV	S-Video	COMPONENT 1	COMPONENT 2	RGB PC	DVI PC
AV	X	X	X	X	●	●
S-Video	X	X	X	X	●	●
COMPONENT 1	X	X	X	X	●	●
COMPONENT 2	X	X	X	X	●	●
RGB PC	●	●	●	●	X	●
DVI PC	●	●	●	●	●	X

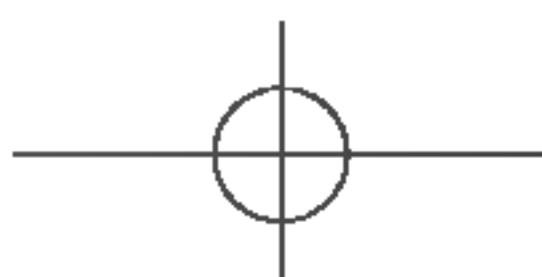

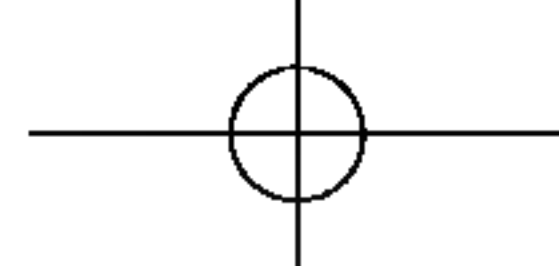

* Applicable only for models that support the stand

1. Disassemble the **stand cover**. The cover may be easily disassembled by pressing down on the base as shown in the figure.

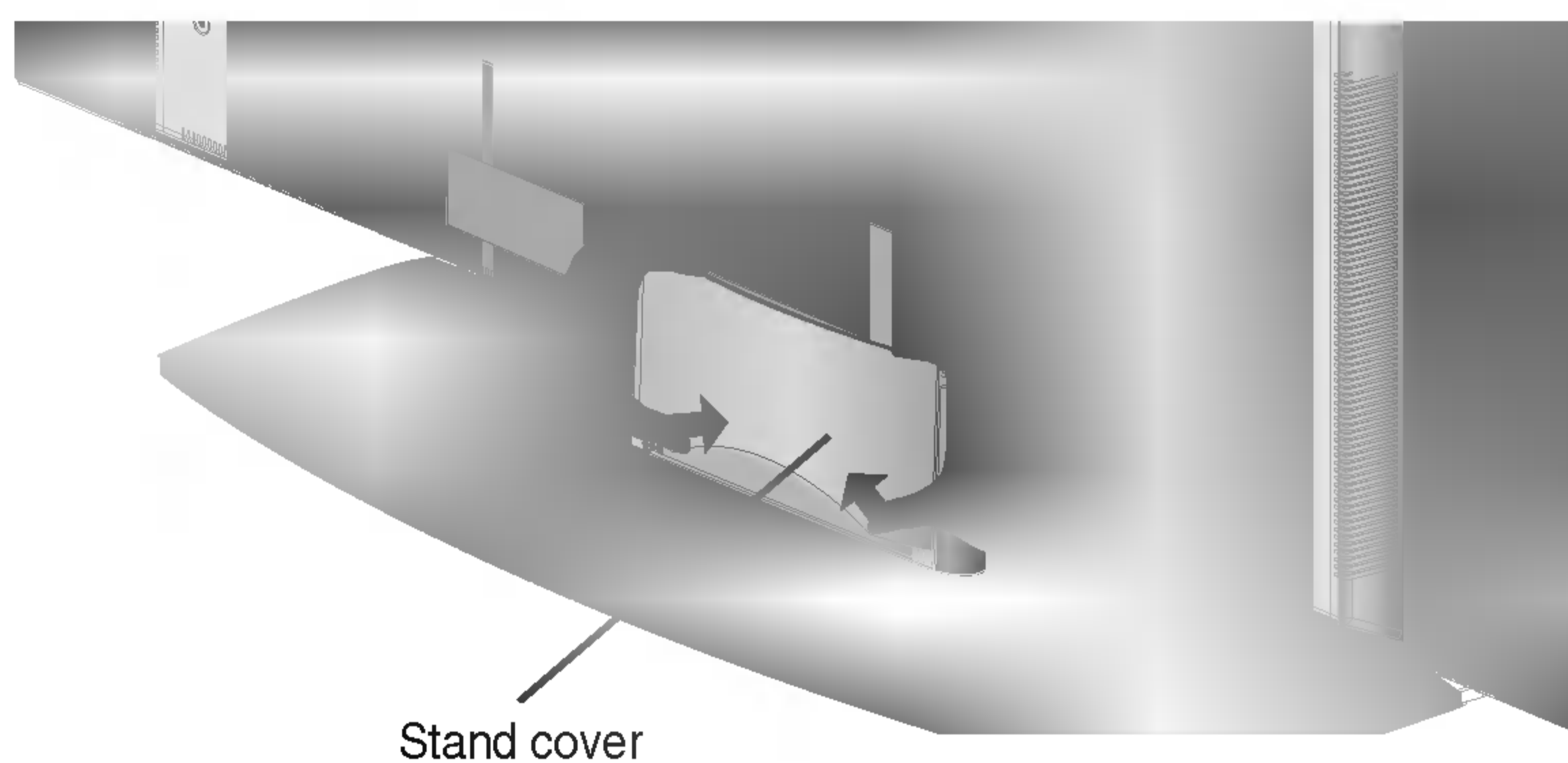

2. After connecting the cables, correctly position the stand cover into the holes on the stand. If securely connected, you will hear the latch click into place.

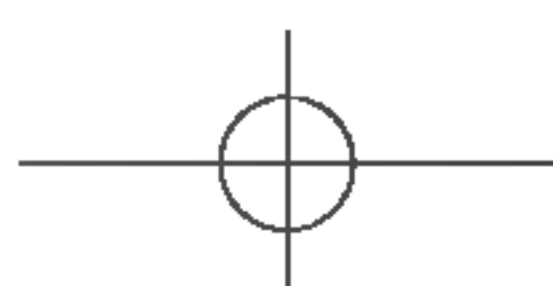
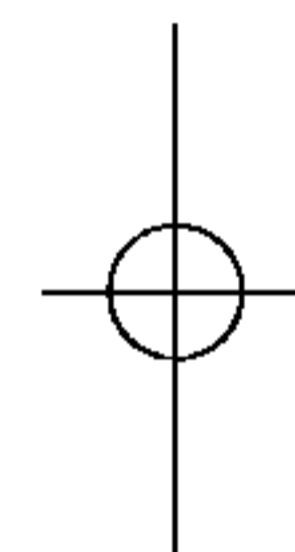
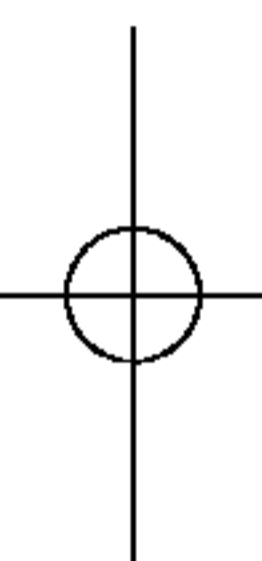

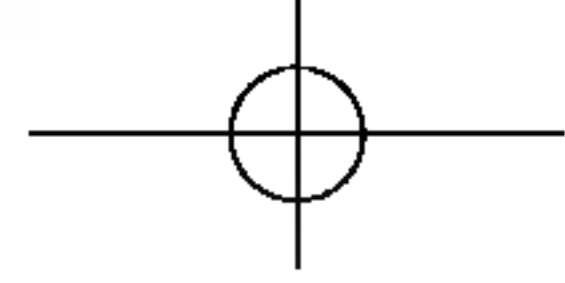

* Applicable only for models that support the speakers

Use the screws to secure the speakers on the rear side of the product as shown in the below figure.

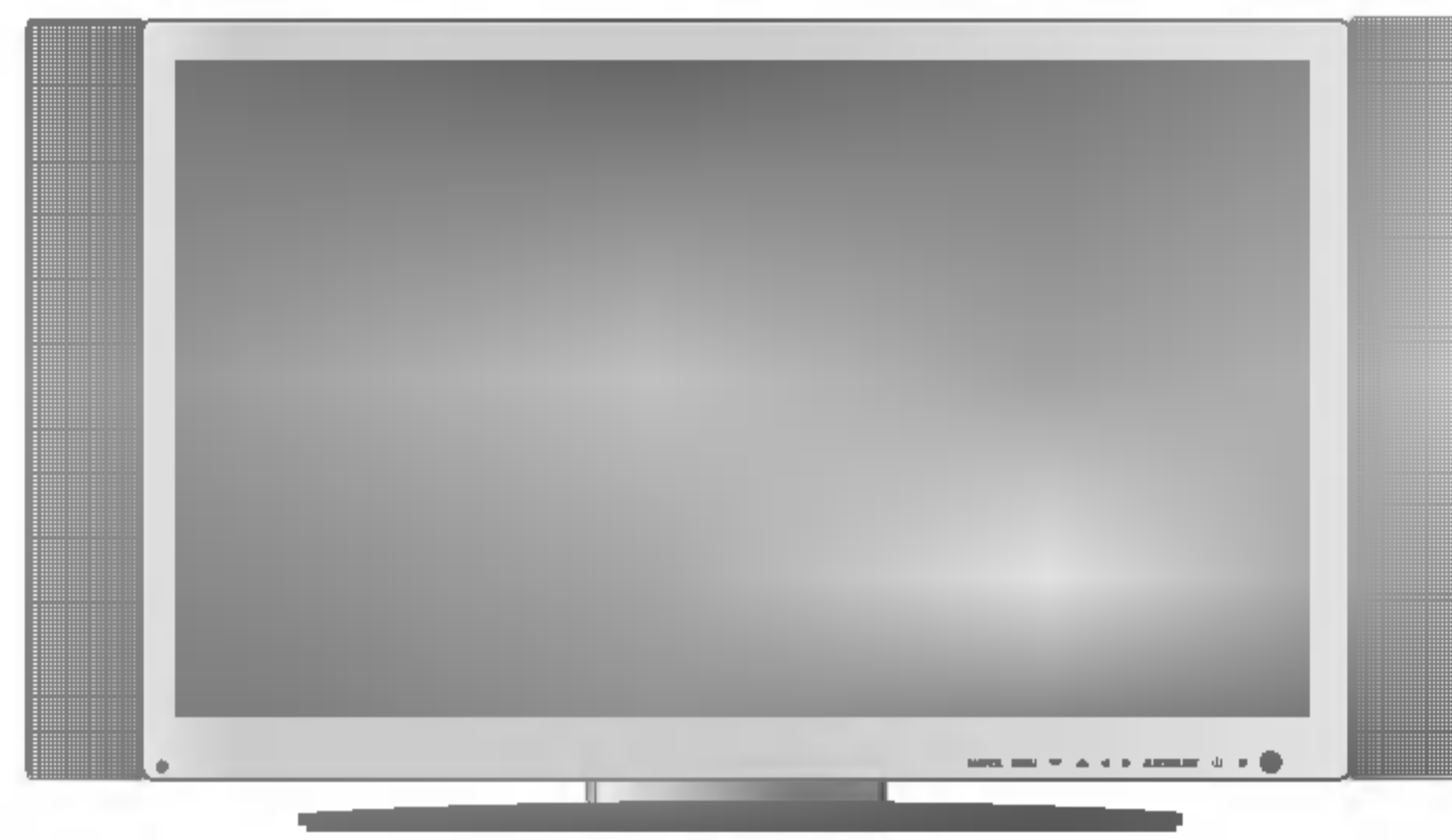
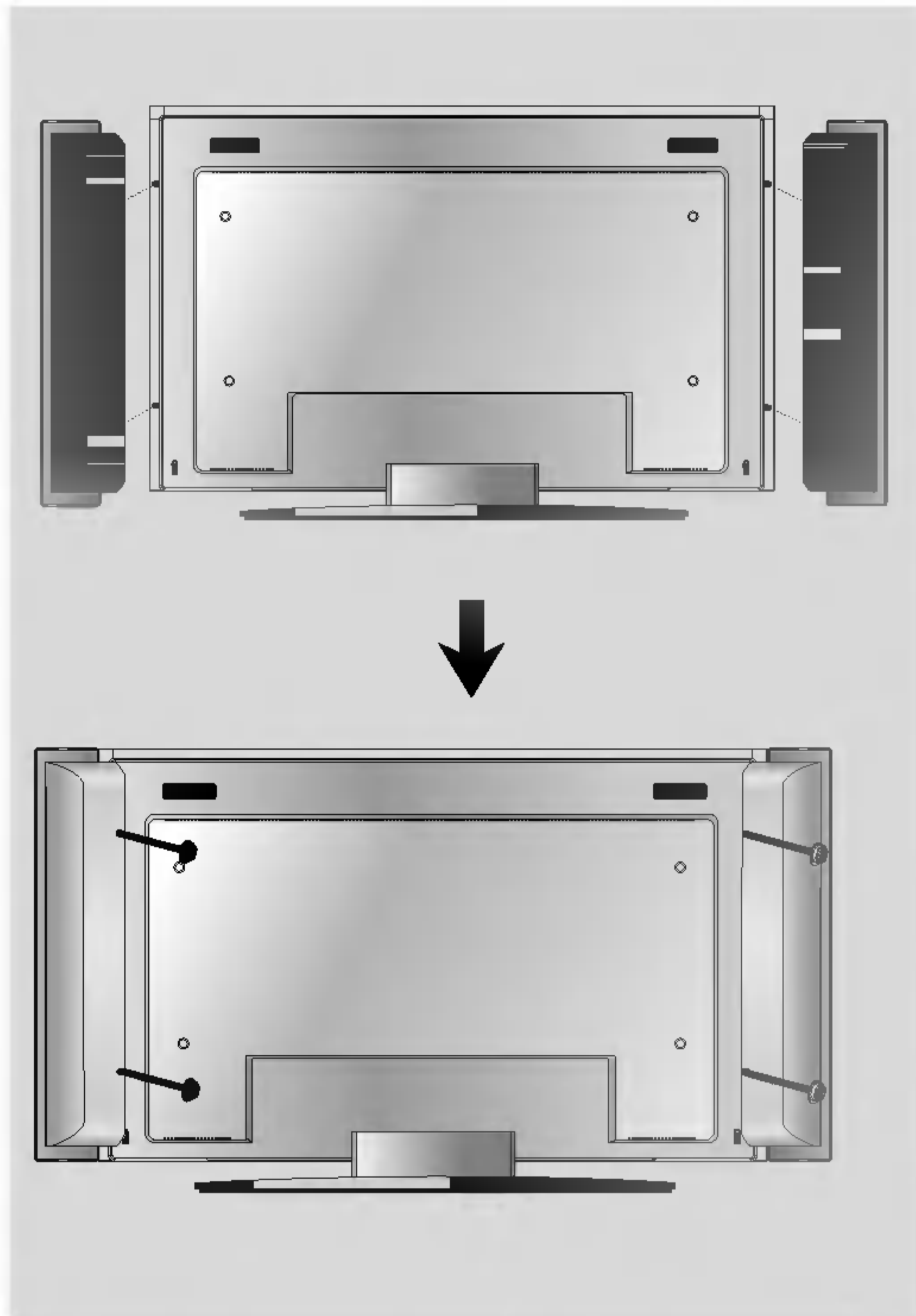

When the speaker is installed.

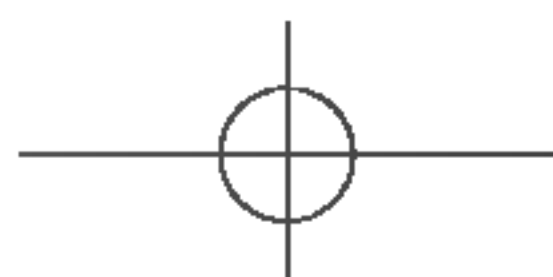
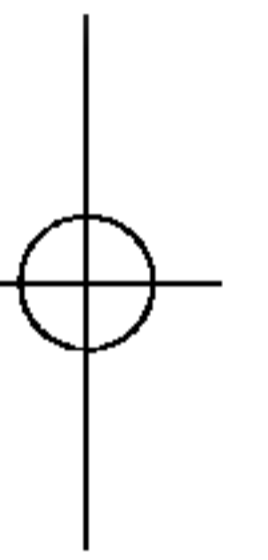

Rear View

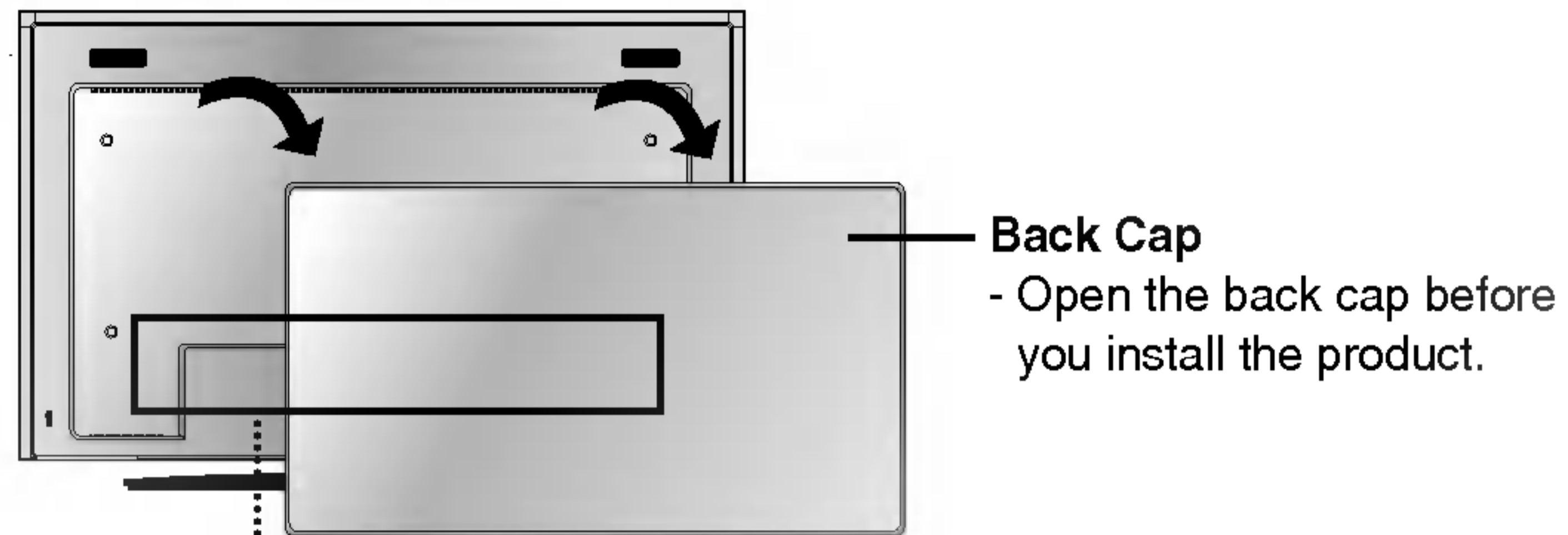

- ❶ Power Connector : Connect the power cord
- ❷ Wired Remote Control Port
- ❸ RS-232C Serial Ports
- ❹ PC Signal Inputs
- ❺ PC Sound Jack
: Connect the audio cable to the *LINE OUT jack of the PC sound card.
- ❻ AV Input Ports

***LINE OUT**

A terminal used to connect to the speaker including a built-in amplifier (Amp). Make sure that the connecting terminal of the PC sound card is checked before connecting. If the Audio Out of PC sound card has only Speaker Out, reduce the PC volume.

If the Audio Out of the PC sound card supports both Speaker Out and Line Out, convert to Line Out using the card jumper of the program (Refer to the Sound Card Manual).

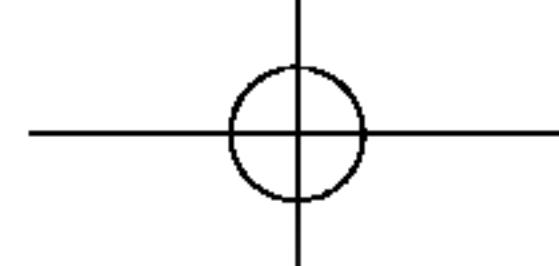

1 First of all, see if the computer, product and the peripherals are turned off.
Then, connect the signal input cable.

- (A)** When connecting with the DVI signal input cable.
- (B)** When connecting with the D-Sub signal input cable. (IBM compatible PC)
- (C)** When connecting with the D-Sub signal input cable. (Macintosh)

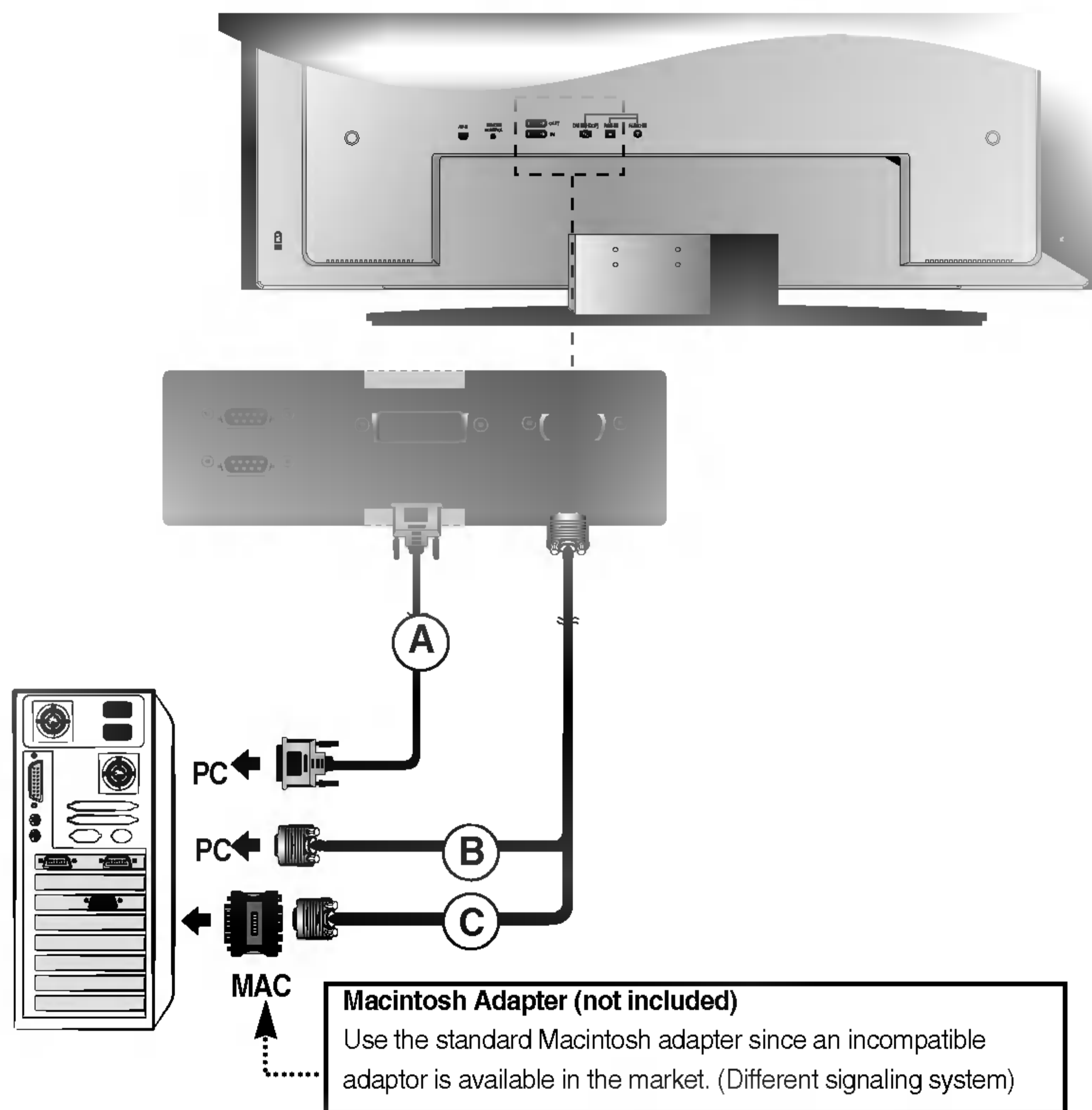

2 Connect the power cord.

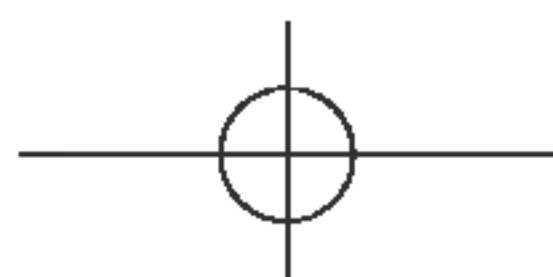
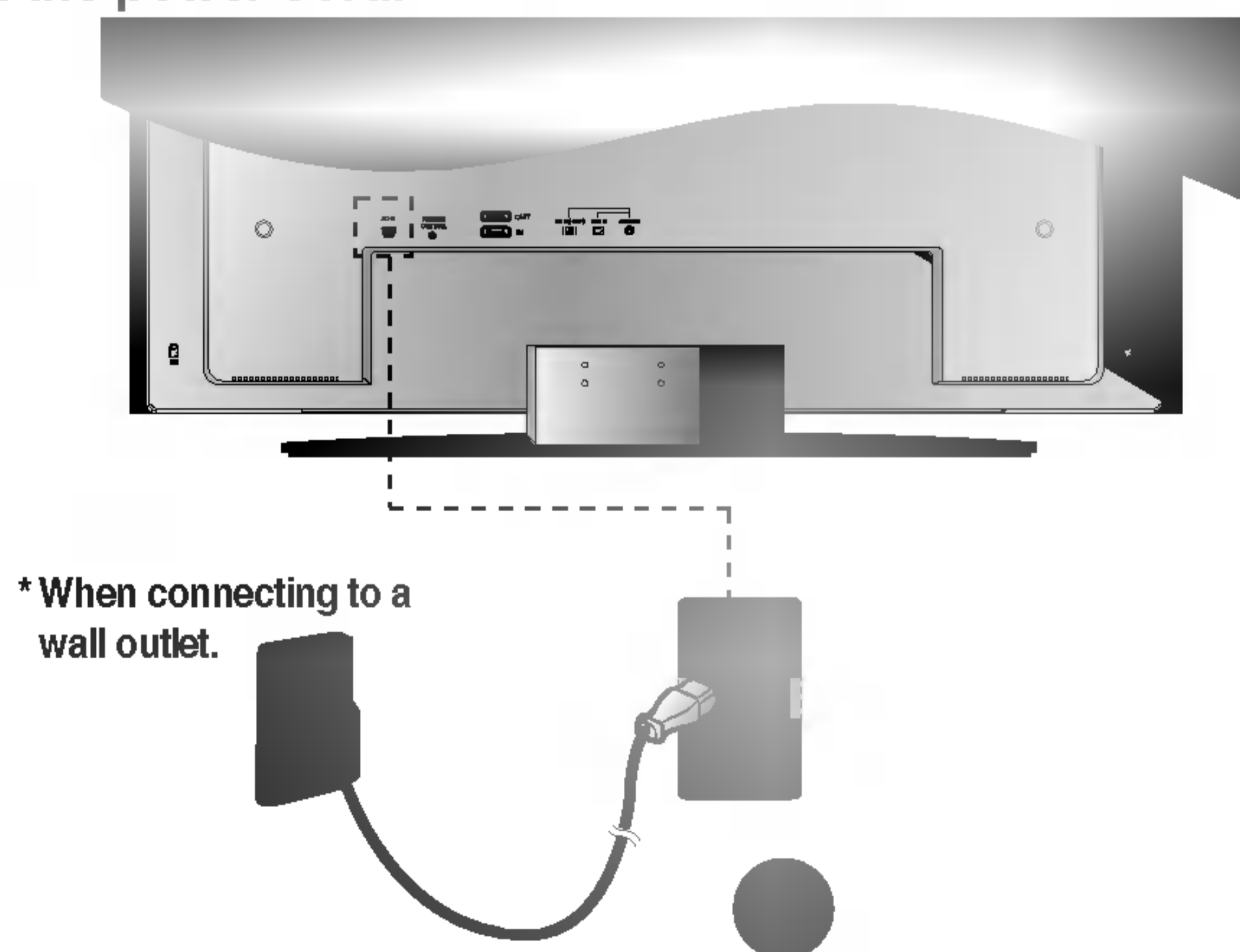

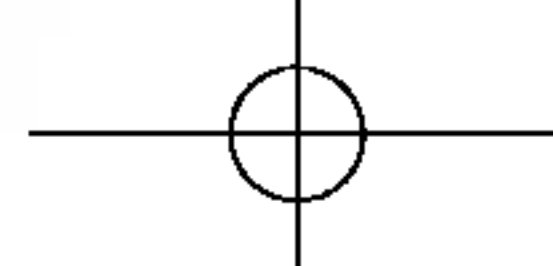

- 3 (A) Turn on power by pressing the power button on the product.

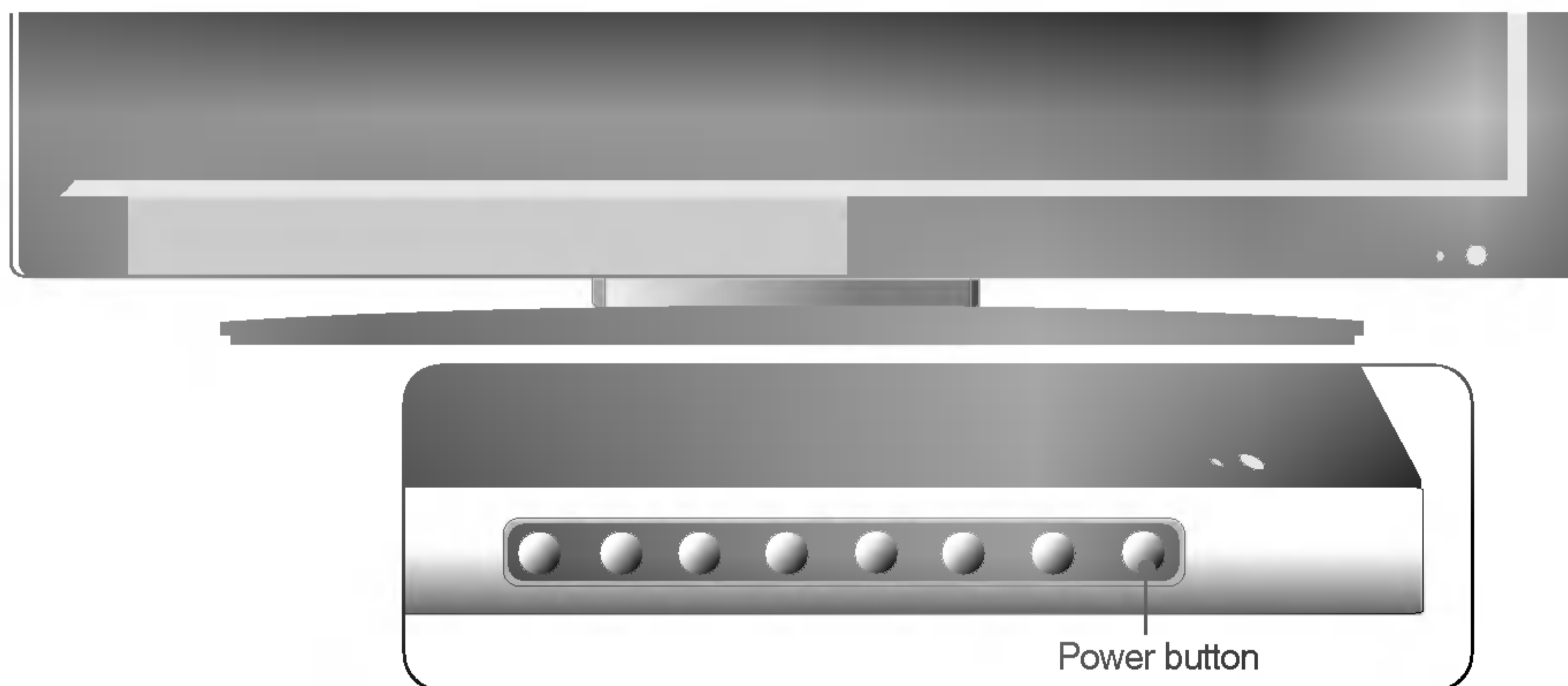

- (B) Turn on the PC.

- 4 Select an input signal.
Press the SOURCE button on the remote control to select the input signal.

SOURCE → ▼▲ → **SET**

Or, press the SOURCE button at the front side of the product.

SOURCE → ▼▲ → **SELECT**

- (A) When connecting with a DVI-D signal input cable.
• Select **DVI PC** : DVI-D digital signal.
- (B) When connecting with a D-Sub signal input cable.
• Select **RGB PC** : 15-pin D-Sub analog signal.



Note

- **How to connect to two computers.**
Connect the signal cables (DVI and D-Sub) to each computer.
Press the **SOURCE** button in a remote control to select the computer to use.
- **Directly connect to a grounded power outlet on the wall or a power bar with a ground wire.**

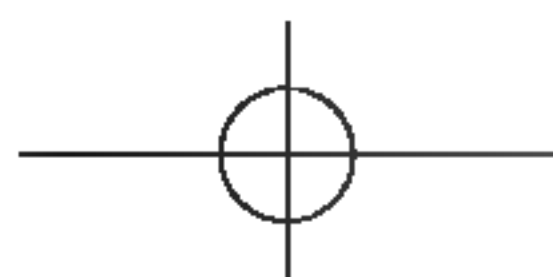

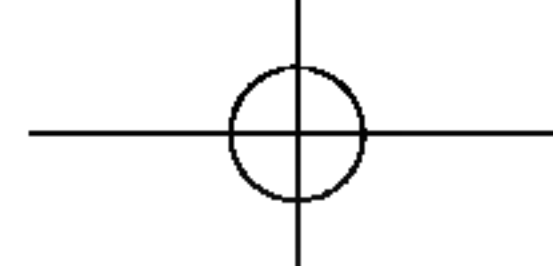

1 Connect the video cable as shown in the below figure and then connect the power cord (See page A11).

(A) When connecting with a RCA cable.

- Connect the input terminal with a proper color match.
(Video – Yellow, Sound (left) – White, Sound (right) – Red)

(B) When connecting with a S-Video cable.

- Connect to the S-Video input terminal to watch high image quality movies.

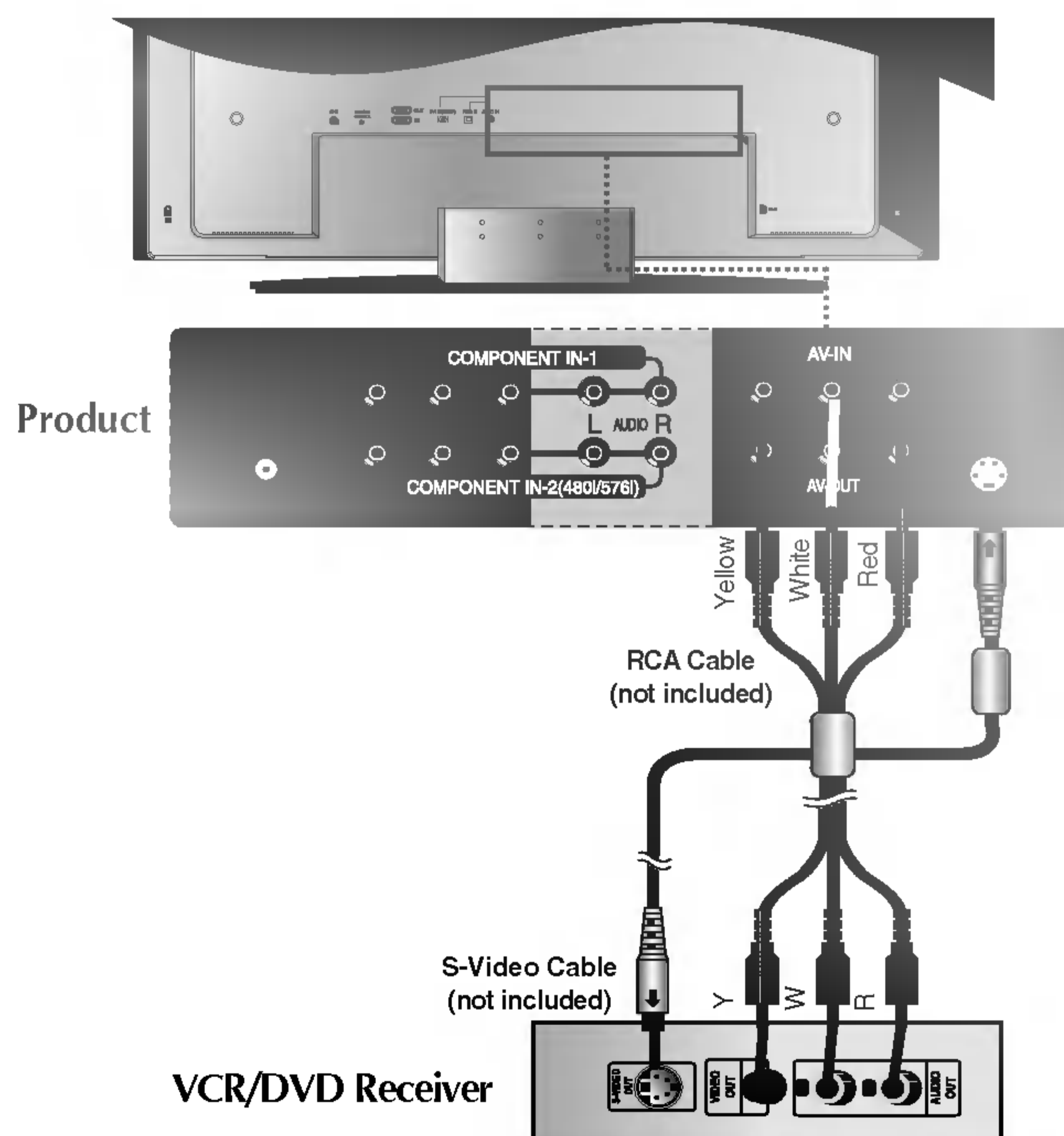

2 Select an input signal.

Press the SOURCE button on the remote control to select the input signal.

SOURCE → ▼▲ → **SET**

Or, press the SOURCE button at the front side of the product.

SOURCE → ▼▲ → **SELECT**

(A) When connecting with an RCA cable.

- Select **AV**.

(B) When connecting with an S-Video cable.

- Select **S-Video**.

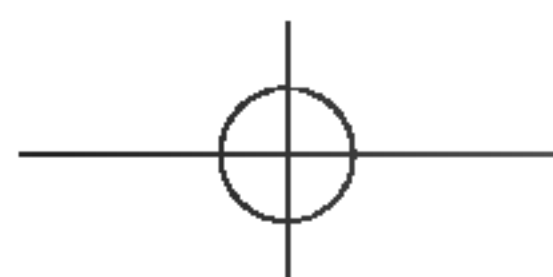

- 1** Connect the video/audio cable as shown in the below figure and then, connect the power cord (See page A11).

- Connect the input terminal with a proper color match.

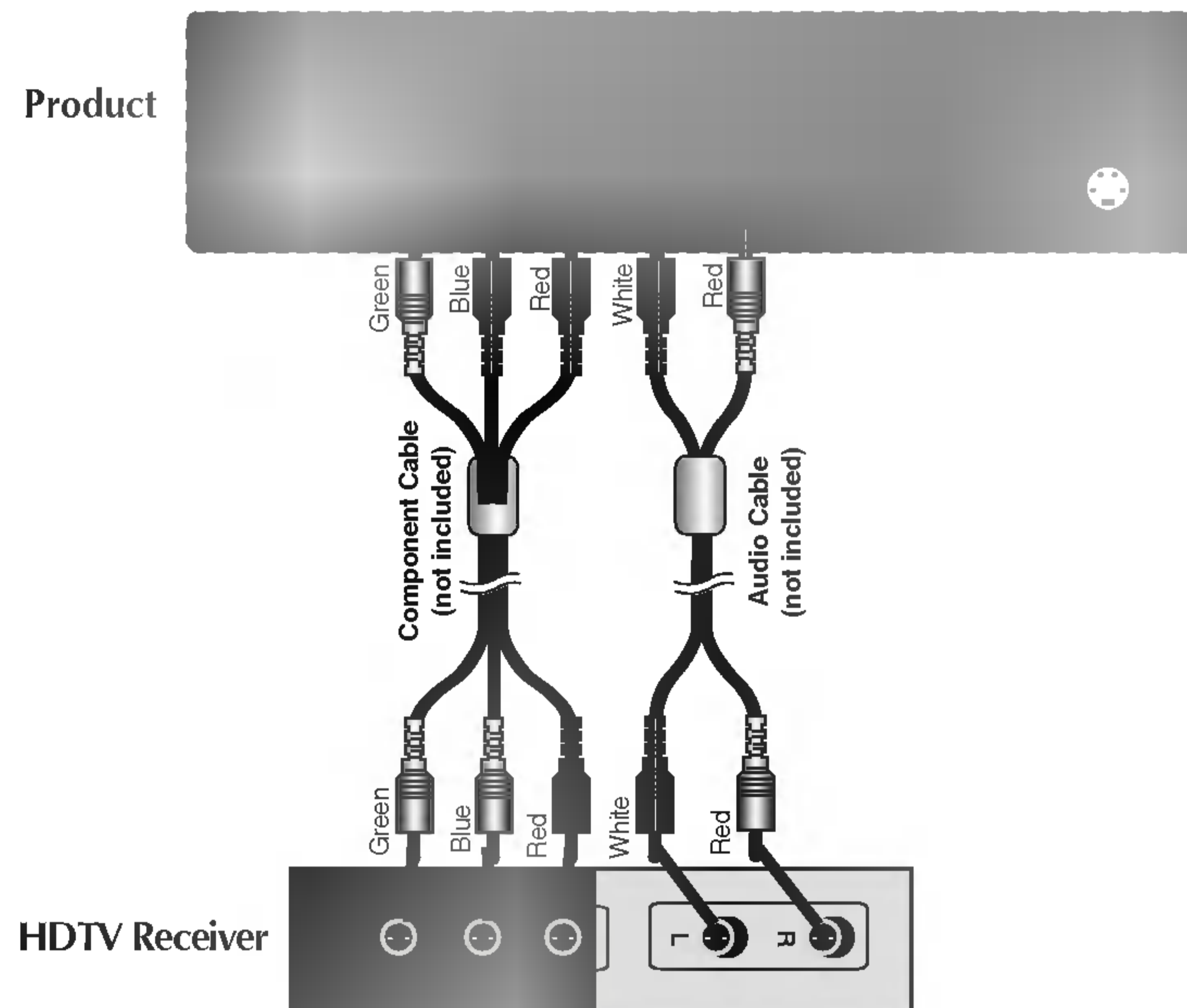

- 2** Select an input signal.
Press the SOURCE button on the remote control to select the input signal.

SOURCE → ▼▲ → **SET**

Or, press the SOURCE button at the front side of the product.

SOURCE → ▼▲ → **SELECT**

- Select Component 1.

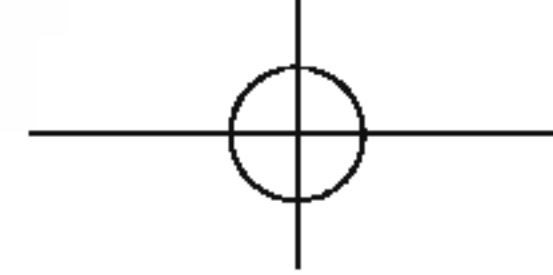

- 1** Connect the video/audio cable as shown in the below figure and then, connect the power cord (See page A11).

- Connect the input terminal with a proper color match.

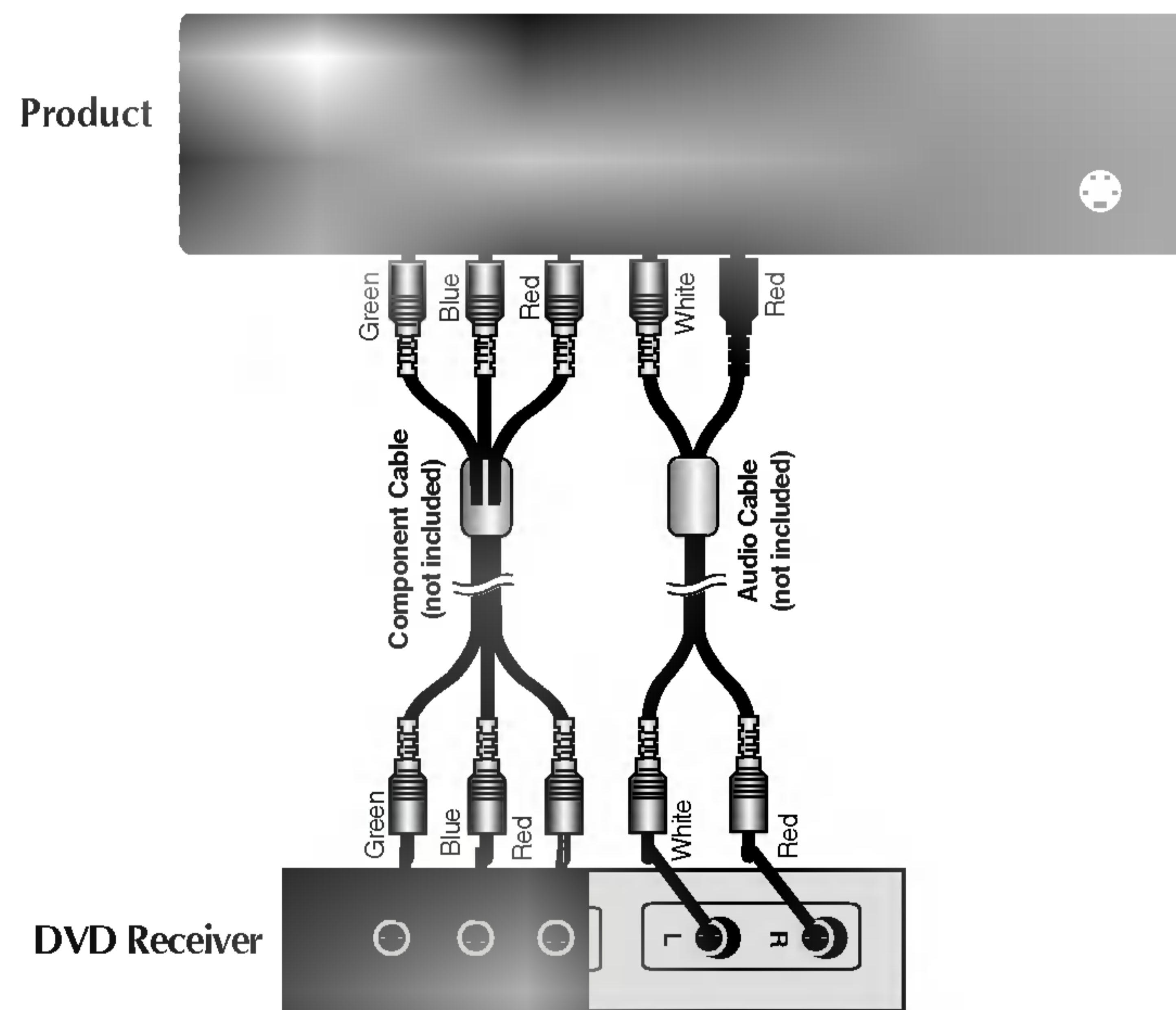

- 2** Select an input signal.
Press the SOURCE button on the remote control to select the input signal.

SOURCE → ▼▲ → **SET**

Or, press the SOURCE button at the front side of the product.

SOURCE → ▼▲ → **SELECT**

- Select Component 2.

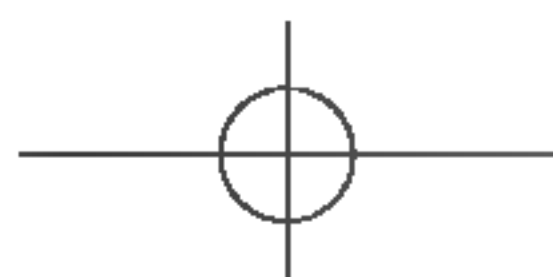

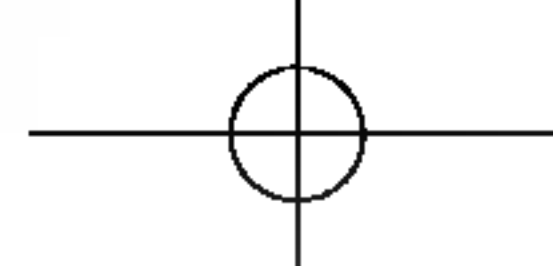

- 1** Connect the video/audio cable as shown in the below figure and then connect the power cord (See page A11).

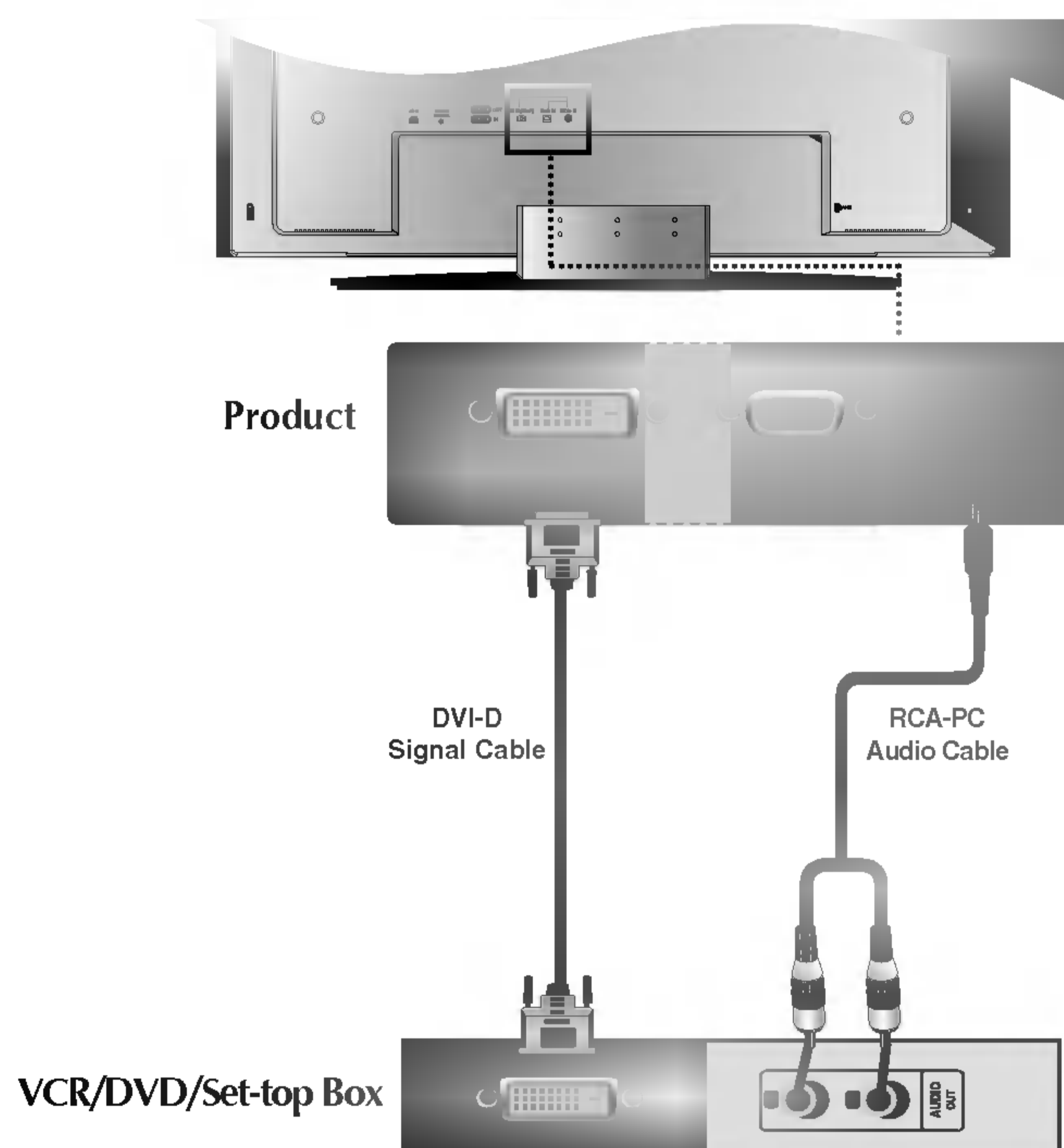

- 2** Select an input signal.
Press the SOURCE button on the remote control to select the input signal.

SOURCE → ▼▲ → **SET**

Or, press the SOURCE button at the front side of the product.

SOURCE → ▼▲ → **SELECT**

- Select DVI PC.

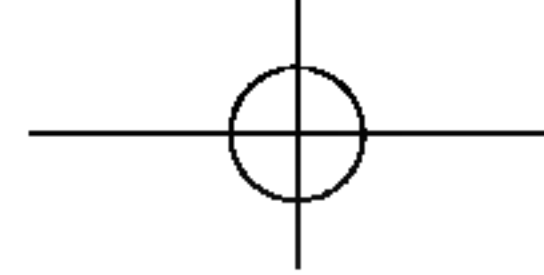

Connect to the external device if you record the broadcasting.

- When you set the input signal of the main screen as 'AV (CVBS)', you can transmit the signal that you're watching to the AV output terminal.

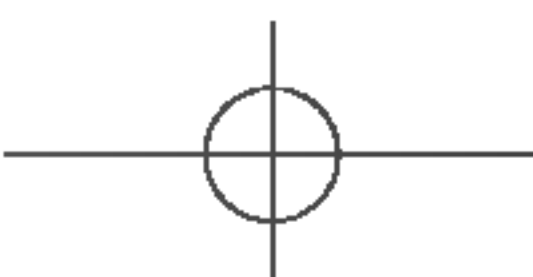
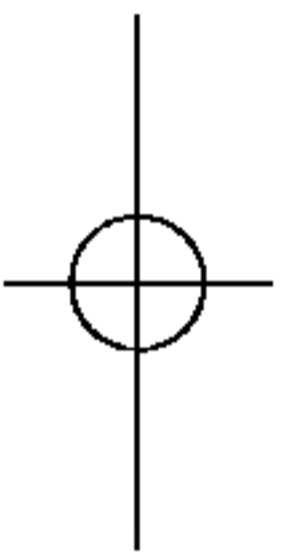
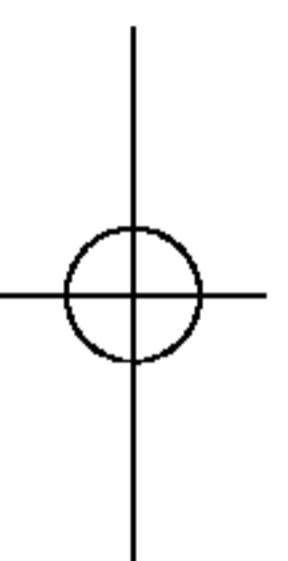
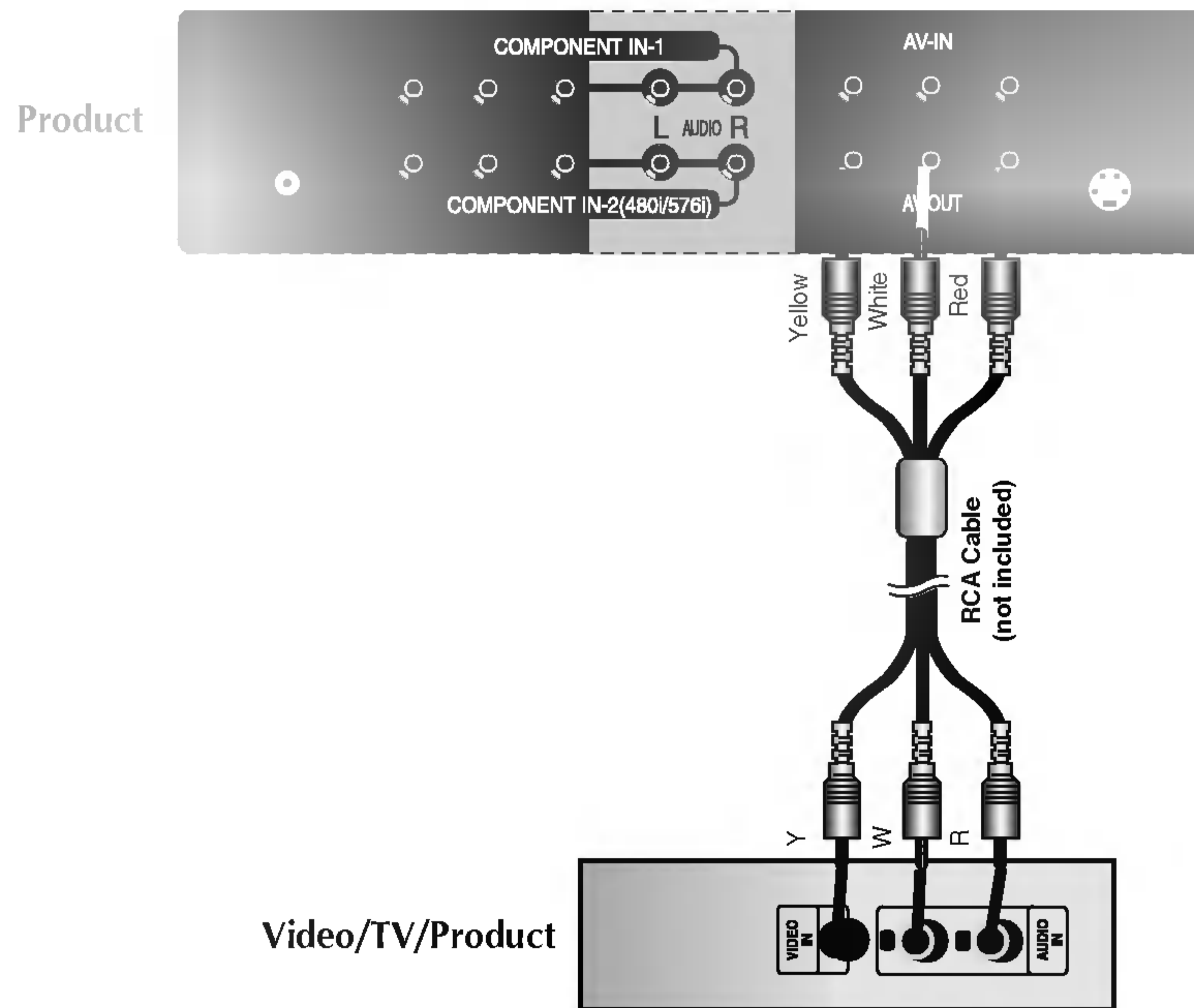

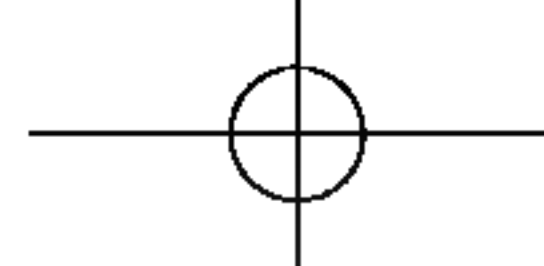

Name of the Buttons in the Screen Adjustment Unit

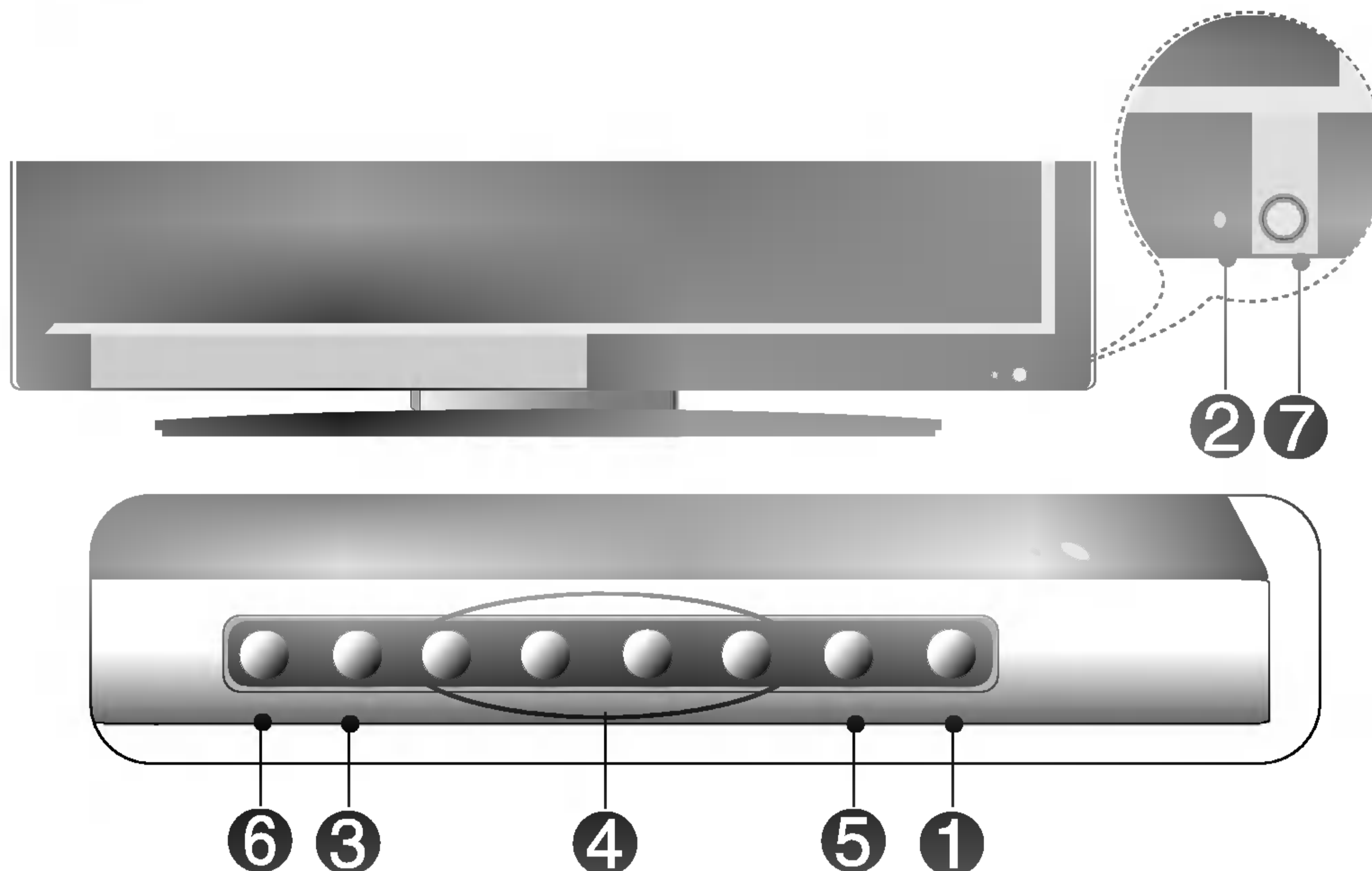

1 **Power Button** • Press this button to turn on the power. Press this button again to turn it off.

2 **Power Indicator** • This Indicator lights up green when the display operates normally (on mode). If the display is in sleep (Energy Saving) mode, this indicator color changes to amber.

3 **MENU Button** • Use this button to show/hide the OSD (On Screen Display) menu screen.

4 **OSD Select / Adjust Button** • Use this button to select an icon or adjust the setting in the OSD screen.

▼▲ • Use this button to directly control brightness and contrast of the PC signal (RGB PC / DVI PC).

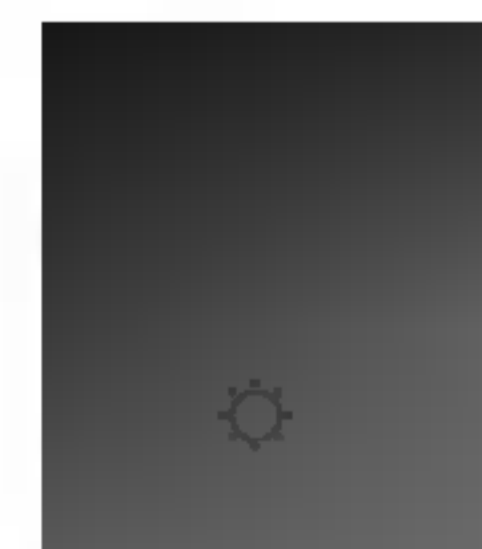

◀▶ • Adjust the volume.

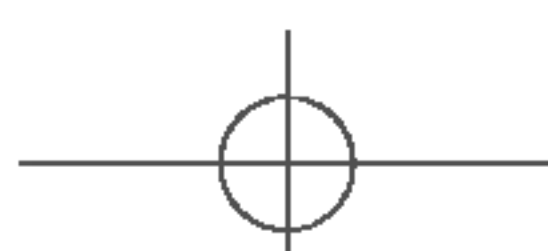

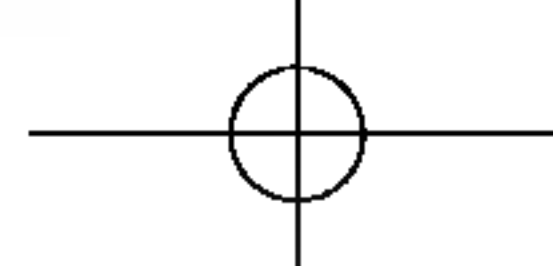

● Name of the Buttons in the Screen Adjustment Unit

5 AUTO/SELECT Button [For PC Analog signal]



[Other signals]

- The current signal and mode information will be displayed.

6 SOURCE Button SOURCE → ▼▲ → AUTO/SELECT

- Select the input signal



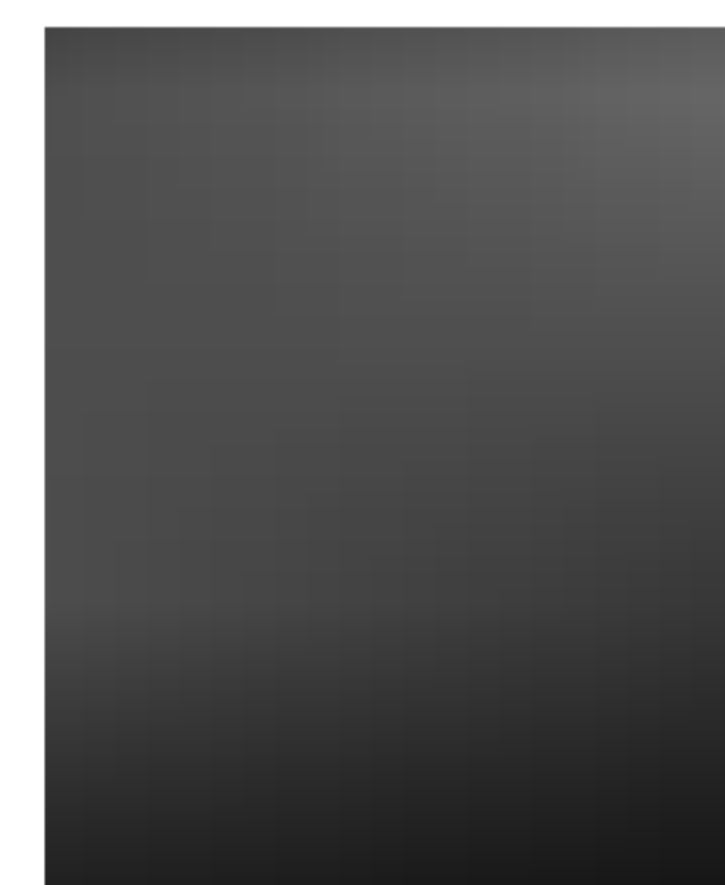

AV	Composite Video
S-Video	Separate Video
Component 1	HDTV
Component 2	DVD
RGB PC	15-pin D-Sub analog signal
DVI PC	DVI digital signal

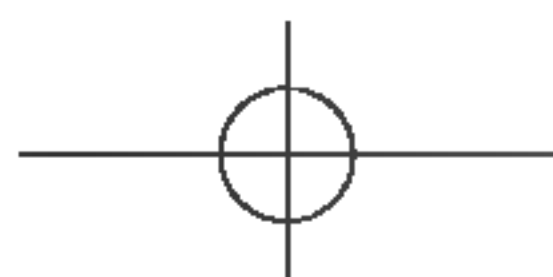

7 ● • The unit that receives the signal from the remote control.



OSD Menu

Icon	Function Description
 PICTURE	Adjusts screen brightness, contrast and color that you prefer.
 SOUND	Adjusts the audio function.
 SPECIAL	Adjusts the screen status according to the circumstances.
 SCREEN	Adjusts the screen video.
 PIP/POP/PBP	Adjusts PIP/POP/PBP mode function.



Note

OSD(On Screen Display)

The OSD function enables you to adjust the screen status conveniently since it provides graphical presentation.

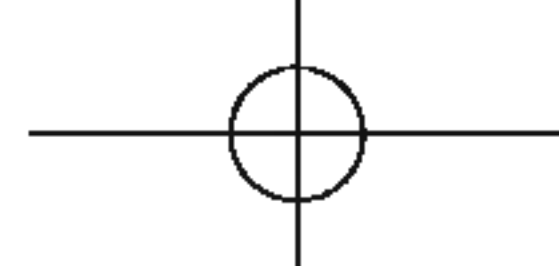

● How to adjust the OSD (On Screen Display) screen

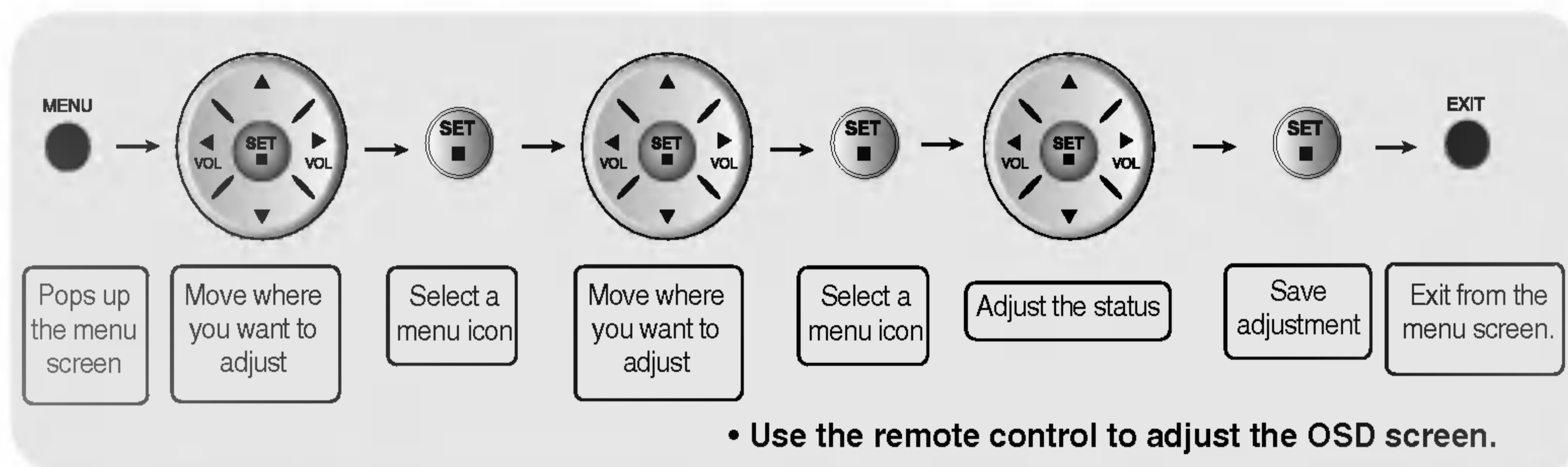

Press the **MENU** Button, then the main menu of the OSD appears.

To access a control, use the ▼ ▲ Buttons.

When the icon you want becomes highlighted, press the **SET** Button.

Use the ▼ ▲ ◀ ▶ Buttons to adjust the item to the desired level.

Accept the changes by pressing the **SET** Button.

Exit the OSD by pressing the **EXIT** Button.

● How to adjust the screen automatically

You need to adjust the screen display when connecting the product to a new computer or changing the mode. Refer to the following section to set an optimal product screen.

Press the **AUTO/SELECT** button (**AUTO** button in a remote control) in the PC analog signal. Then, an optimal screen status will be selected that fits into the current mode.

If adjustment is not satisfactory, you need to adjust screen position, clock and phase in the OSD menu.

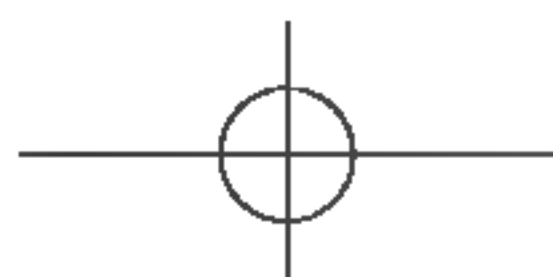

Adjusting Screen Color

EZ Video

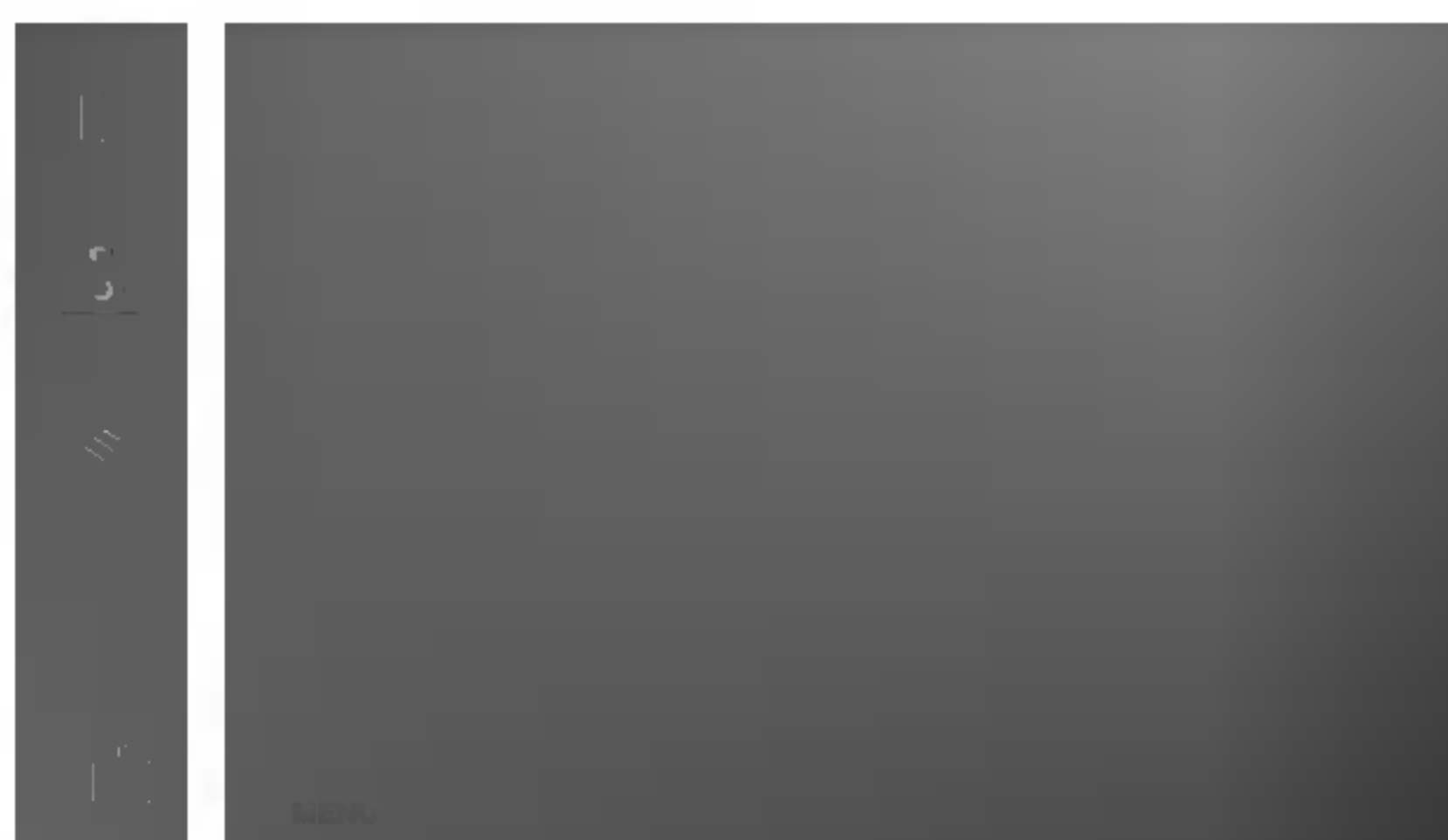

AV/S-Video/Component 1/
Component 2 input only

The **EZ Video** function automatically adjusts the screen image quality depending on the AV usage environment.

- **Dynamic** : Select this option to display with a sharp image.
- **Standard** : The most general and natural screen display status.
- **Mild** : Select this option to display with a mild image.
- **Game** : Select this option to enjoy dynamic image when playing a game.
- **User** : Select this option to use the user-defined settings.



Contrast

To adjust the contrast of the screen.

Brightness

To adjust the brightness of the screen.

Color

To adjust the color to desired level.

Sharpness

To adjust the cleanness of the screen.

Tint

To adjust the tint to desired level.

ACC

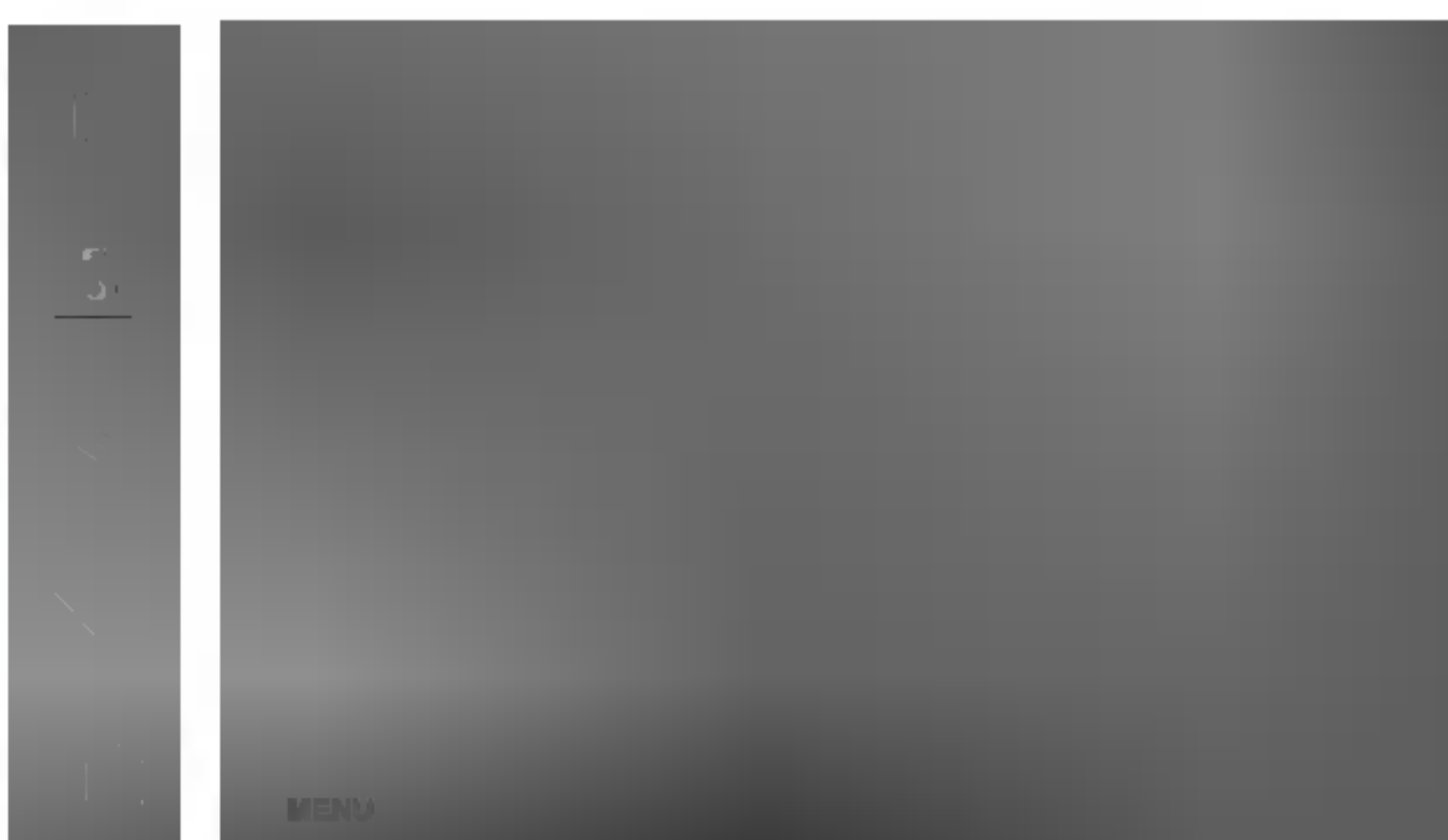

Selecting a factory setting color set.

- **Warm** : Slightly reddish white.
- **Normal** : Slightly bluish white.
- **Cool** : Slightly purplish white.



Note

If the input is RGB PC(D-Sub analog)/DVI PC(DVI Digital), the adjustable items in the ACC function are color temp (9300K / 6500K).

If the '**EZ Video**' setting in the **PICTURE** menu is set to **Dynamic**, **Standard**, **Mild** or **Game** the subsequent menus will be automatically set.

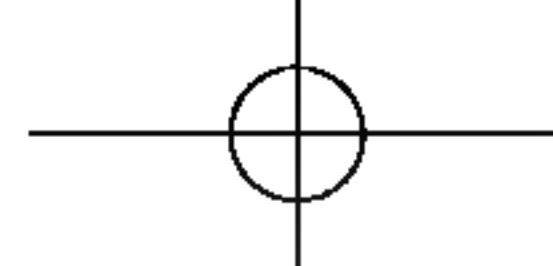

Adjusting Screen Color

ACC



RGB PC / DVI PC input only

- **6500K/9300K**
Selecting a factory setting color set.
6500K: Slightly reddish white.
9300K: Slightly bluish white.
- **User** : Select this option to use the user-defined settings.



Contrast
To adjust the contrast of the screen.

Brightness
To adjust the brightness of the screen.

Red / Green / Blue
Set your own color levels.

Adjusting the audio function

EZ Audio



The best sound tone quality will be selected automatically depending on the video type that you're currently watching.

- **Flat**
The most commanding and natural audio.
- **Music**
Select this option to enjoy the original sound when listening to the music.
- **Movie**
Select this option to enjoy sublime sound.
- **Speech**
Select this option to watch sports broadcasting.
- **User**
Select this option to use the user-defined audio settings.

Balance Use this function to balance sound from the left and right speakers.

AVL To adjust uneven sound volumes across all channels or signals automatically to the most appropriate level. To use this feature, select ON.

SRS WOW Set the SRS WOW menu on.
The SRS WOW function plays back the mono or stereo sound input with the dynamic surround effects. It will provide rich and profound sound tone. If you set the SRS WOW on, user audio setting can not be adjusted.



Note

When connected to your computer and the 'EZ Audio' setting in the audio menu is one of Flat, Music, Movie or Speech, the available menus are Balance, AVL and SRS WOW .

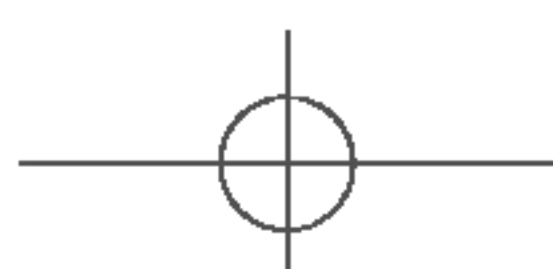



Selecting the options

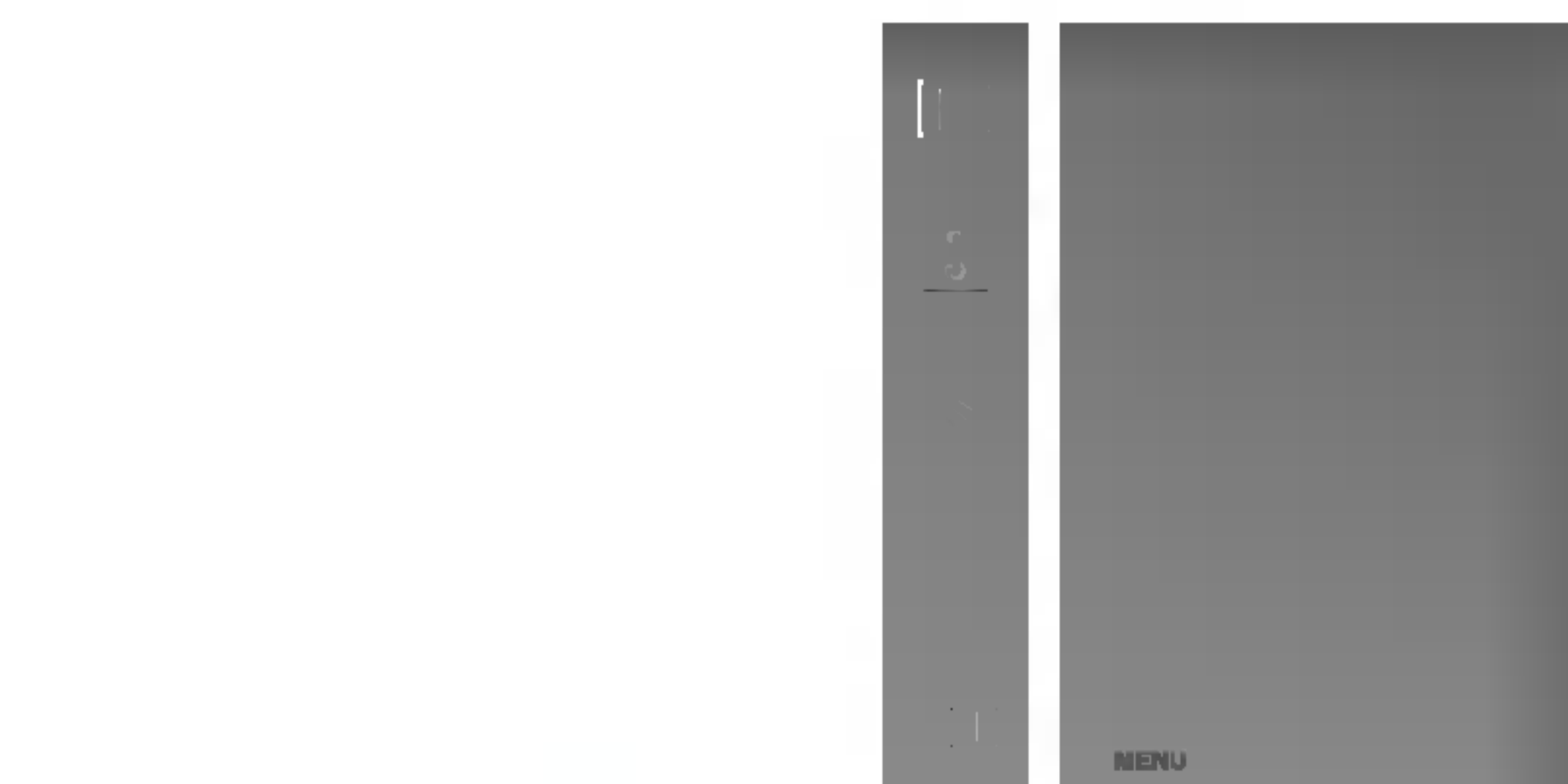

Input



If you press the button once, the following Input Signal Window will appear. Select the signal type you want using the ▼▲ button.

Child Lock

Use the ▼▲ buttons to select **On** or **Off**. The Set can be set up so that it can only be used with the remote control. This feature can prevent unauthorized viewing.

In order to lock the OSD screen adjustment, set the **Child Lock** tab to the 'On' position. In order to unlock it, do the following :

- 1) Push the **MENU** button on the remote control and set **Child Lock** to the 'Off' position.

Language

To choose the language in which the control names are displayed.

Power Indicator

Use this function to set the power indicator on the front side of the product to **On** or **Off**. If you set **Off**, it will go off. If you set **On** at any time, the power indicator will automatically be turned on.

Transparency

To adjust the transparency of the OSD menu screen.

Zoom

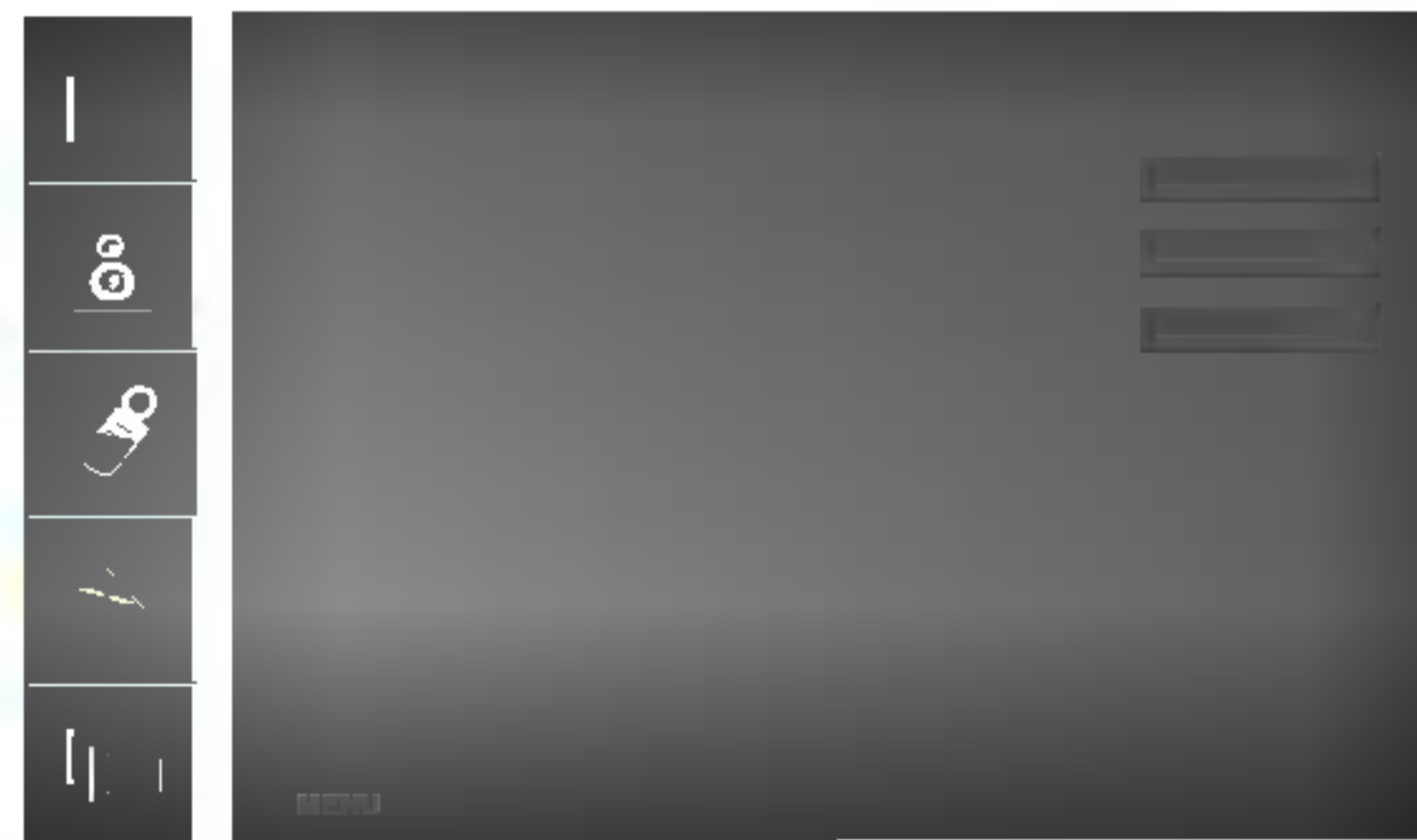

Use this function to zoom in the screen. When you turn the product off and on again, the default screen size will be restored. Press the ► button to display the submenu for Zoom.

- * If the zooming value is set to '0', vertical and horizontal positioning cannot be adjusted.
- * The variable range can differ according to the type of the input signal.

Reset

Use this function to reset the product to the factory default. However, language selection will not be initialized.



Note

the **Zoom menu** will be disabled if the screen size is not Full or PIP/POP/PBP is in use.

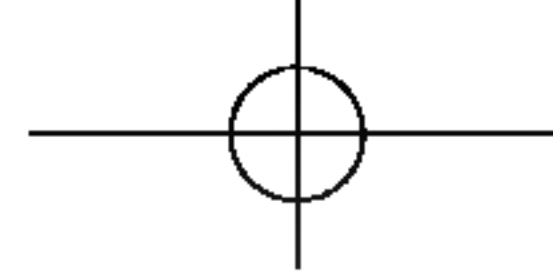

Selecting the options

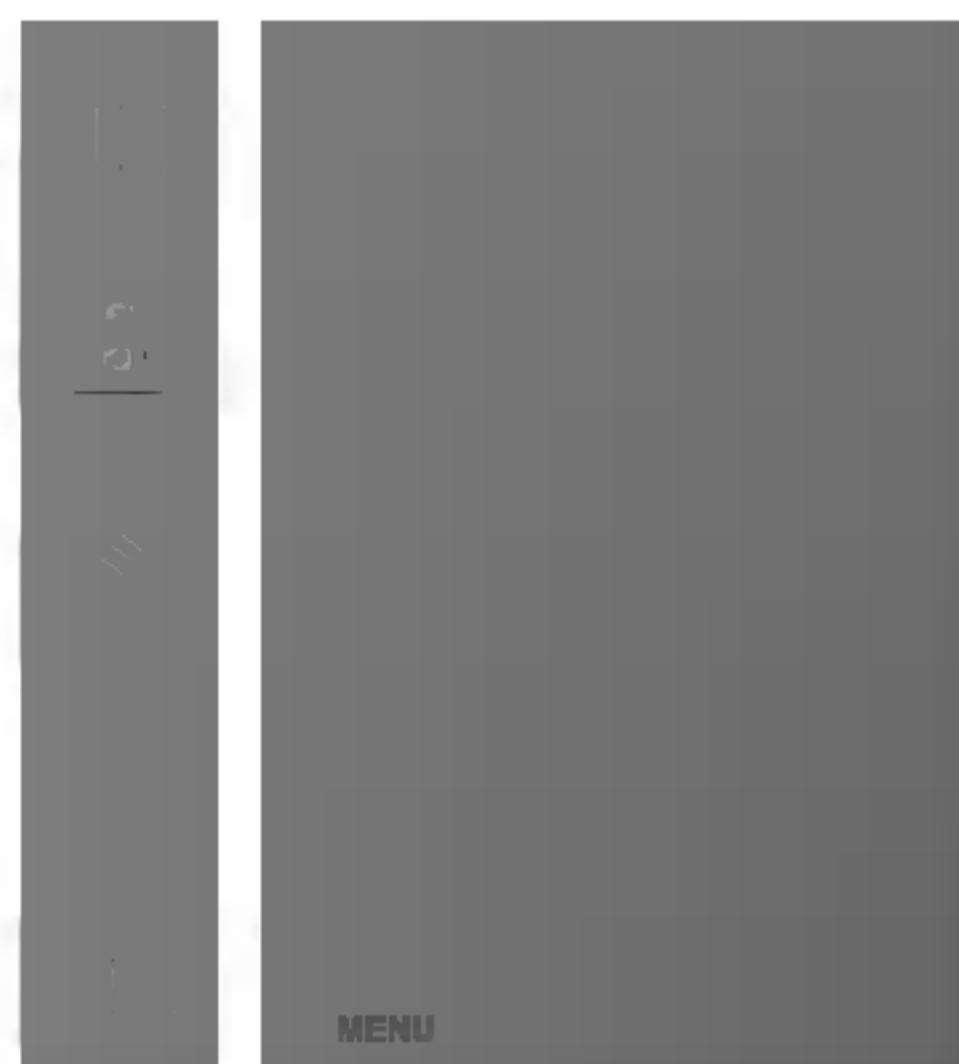

Set ID



You can assign a unique SET ID NO (name assignment) to each product when several products are connected for display. Specify the number (0~99) using the ▼▲ button and exit. Use the assigned SET ID to individually control each product using the Product Control Program.

Logo Display Lamp

Use this function to set the Logo Display Lamp on the front side of the product to On or Off. If you set On, the lamp will automatically be turned on.

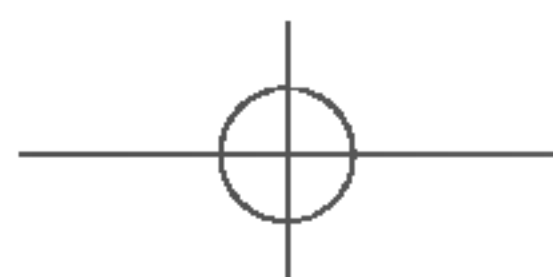
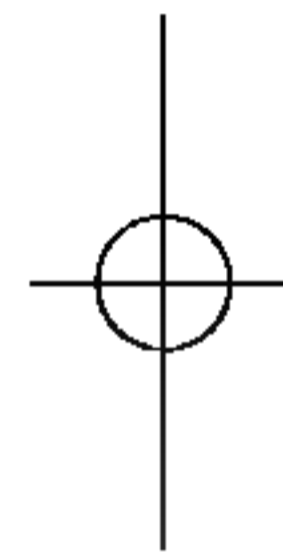
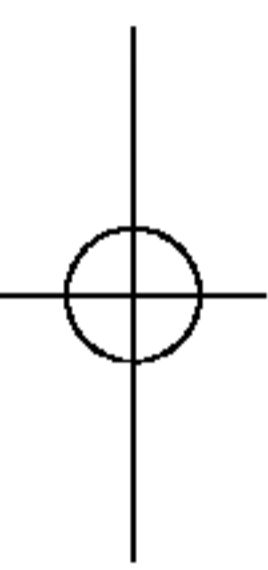

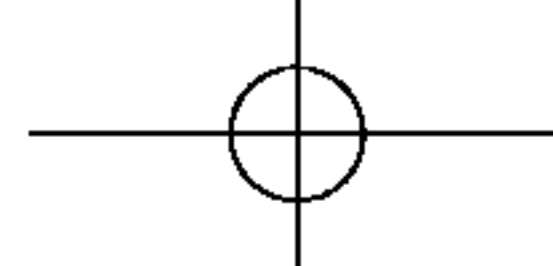

Adjusting Screen CLOCK/PHASE and Position



ARC

To select the image size of the screen.

<AV / S-Video / Component 1, 2 input only>

<RGB PC / DVI PC input only>

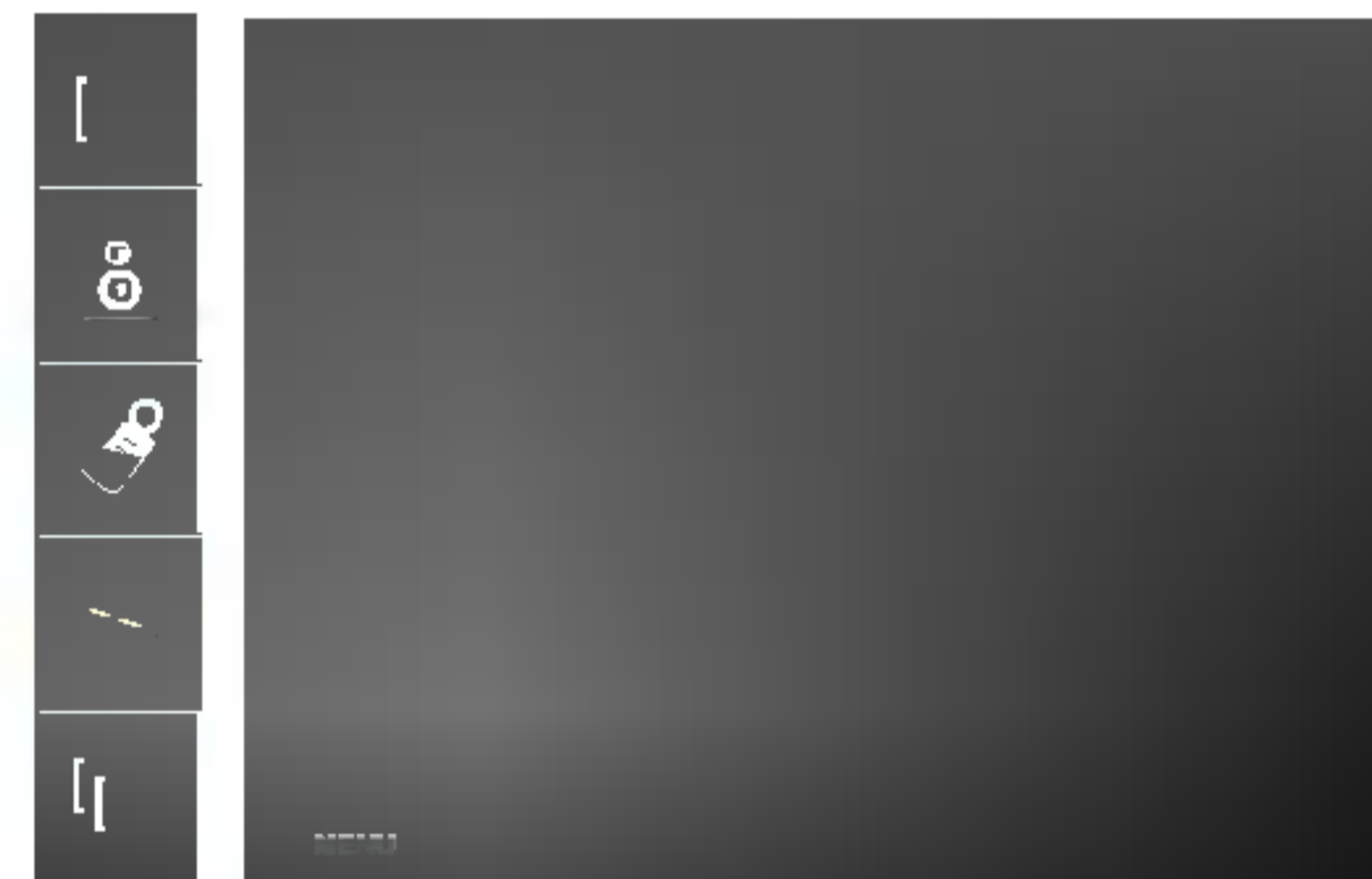
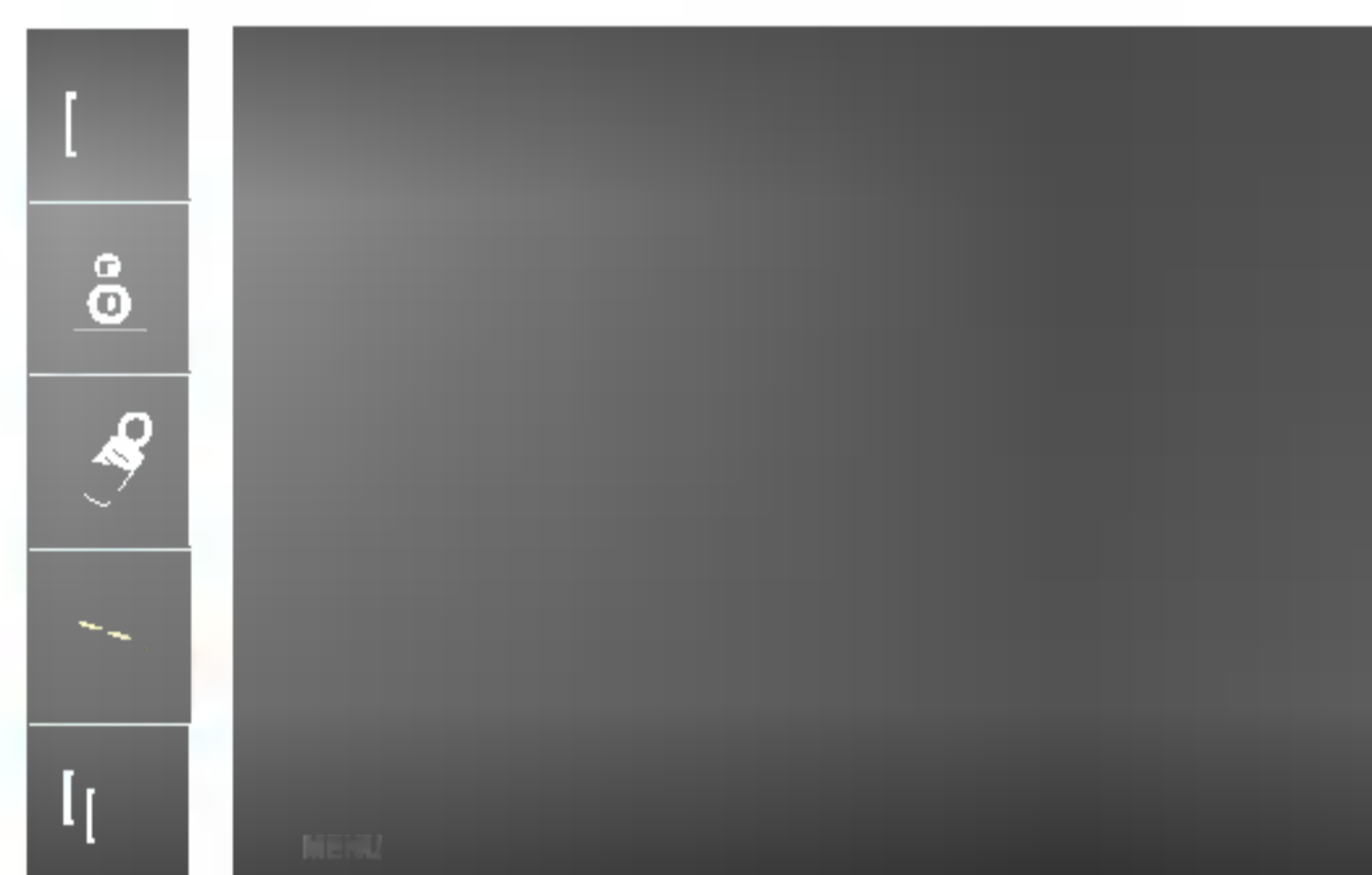

* When the **component 1** input signal is 720p or 1080i, the spectacle function is not supported.

Auto config.

This button is for the automatic adjustment of the screen position, clock and phase. This function is suitable for analoge singnal input only(RGB PC input only).

Clock

To minimize any vertical bars or stripes visible on the screen background. The horizontal screen size will also change. This function is suitable for analoge singnal input only(RGB PC input only).

Phase

To adjust the focus of the display. This item allows you to remove any horizontal noise and clear or sharpen the image of characters. This function is suitable for analoge singnal input only(RGB PC input only).

Position



To adjust position of the screen (RGB PC input only).

Press the ► button to display the submenu for position.

◀ Left Moving the screen position
▶ Right horizontally.

▲ Up Moving the screen position
▼ Down vertically.

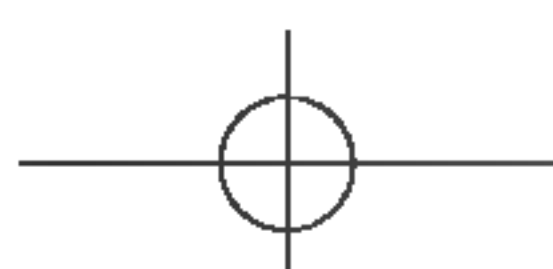

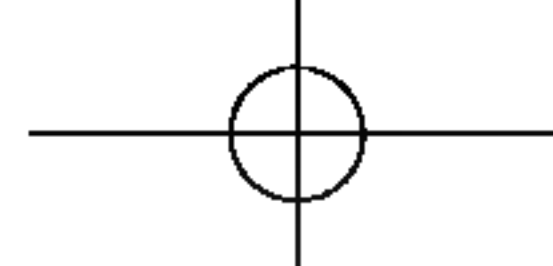

Adjusting PIP/POP/PBP Mode (Multiple Screen) Functions



On/Off



PIP

After selecting **PIP** in the **PIP On/Off** menu, the following menu items can be adjusted.



POP

After selecting **POP** in the **POP On/Off** menu, the following menu items can be adjusted.



PBP

After selecting **PBP** in the **PBP On/Off** menu, the following menu items can be adjusted.

PIP Input To select an input signal for PIP/POP/PBP.

Size To adjust the size of the PIP/POP/PBP screen. (PIP : Small, Medium, Large / PBP : Full, 4:3)

Image To adjust the image of the PIP/POP/PBP screen; Press the **▶** button to display the submenu for PIP/POP/PBP image. Use the **◀ ▶** buttons to adjust the item to the desired level. The items of the sub-menu may vary depending on the type of the source.



■ Contrast

Adjust PIP/POP/PBP screen contrast.

■ Brightness

Adjust PIP/POP/PBP screen brightness.

■ Color

Adjust the PIP/POP/PBP screen color.

■ Tint

To adjust the tint to desired level.

This function is available only in NTSC broadcasting mode.

* The sub-menu can differ according to the type of the input signal.

Sound To turn the PIP/POP/PBP sound on/off.

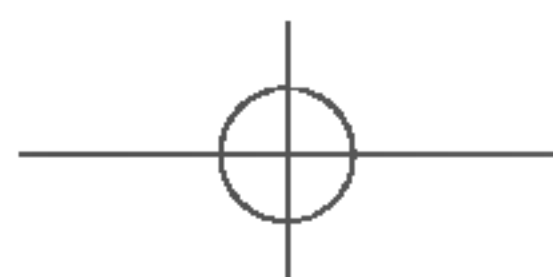

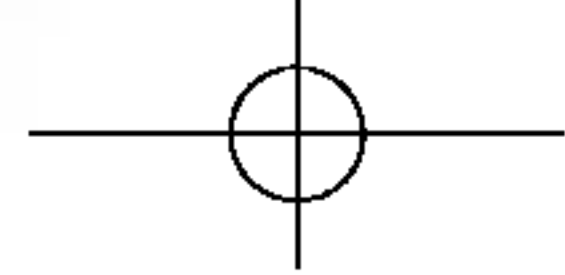

Adjusting PIP/POP/PBP Mode (Multiple Screen) Functions

Position



To adjust the position to PIP screen.

Swap



To switch the main-screen and sub-screen in PIP/POP/PBP mode.

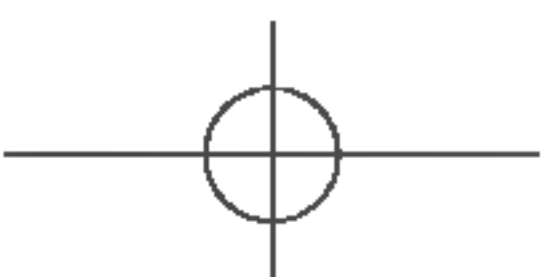
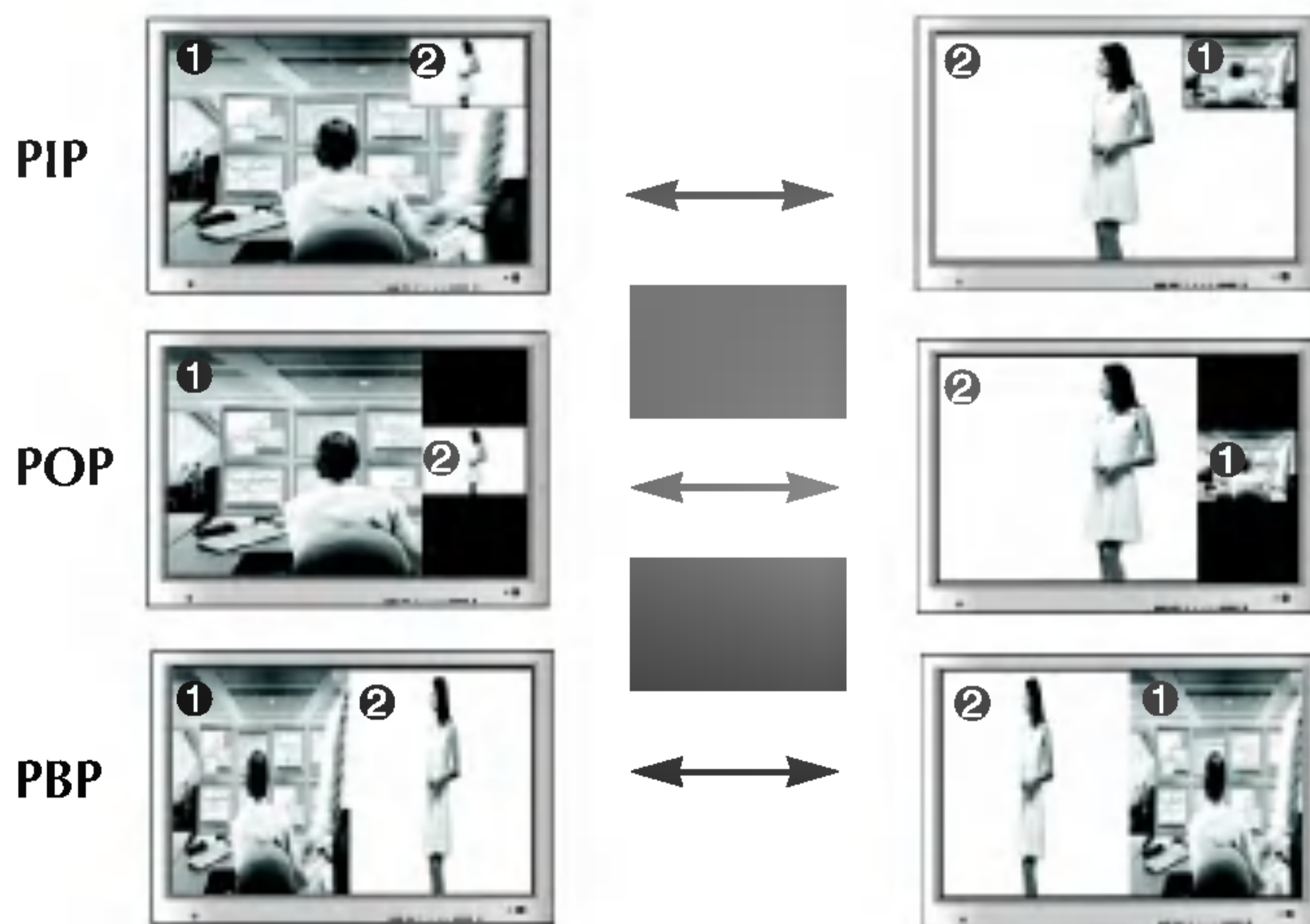

**Use this method to connect several products to a single PC.
You can control several products at a time by connecting them to a single PC.**

● Connecting the cable

Connect the RS-232C cable as shown in the picture.

* The RS-232C protocol is used for communication between the PC and product. You can turn the product on/off, select an input source or adjust the OSD menu from your PC.

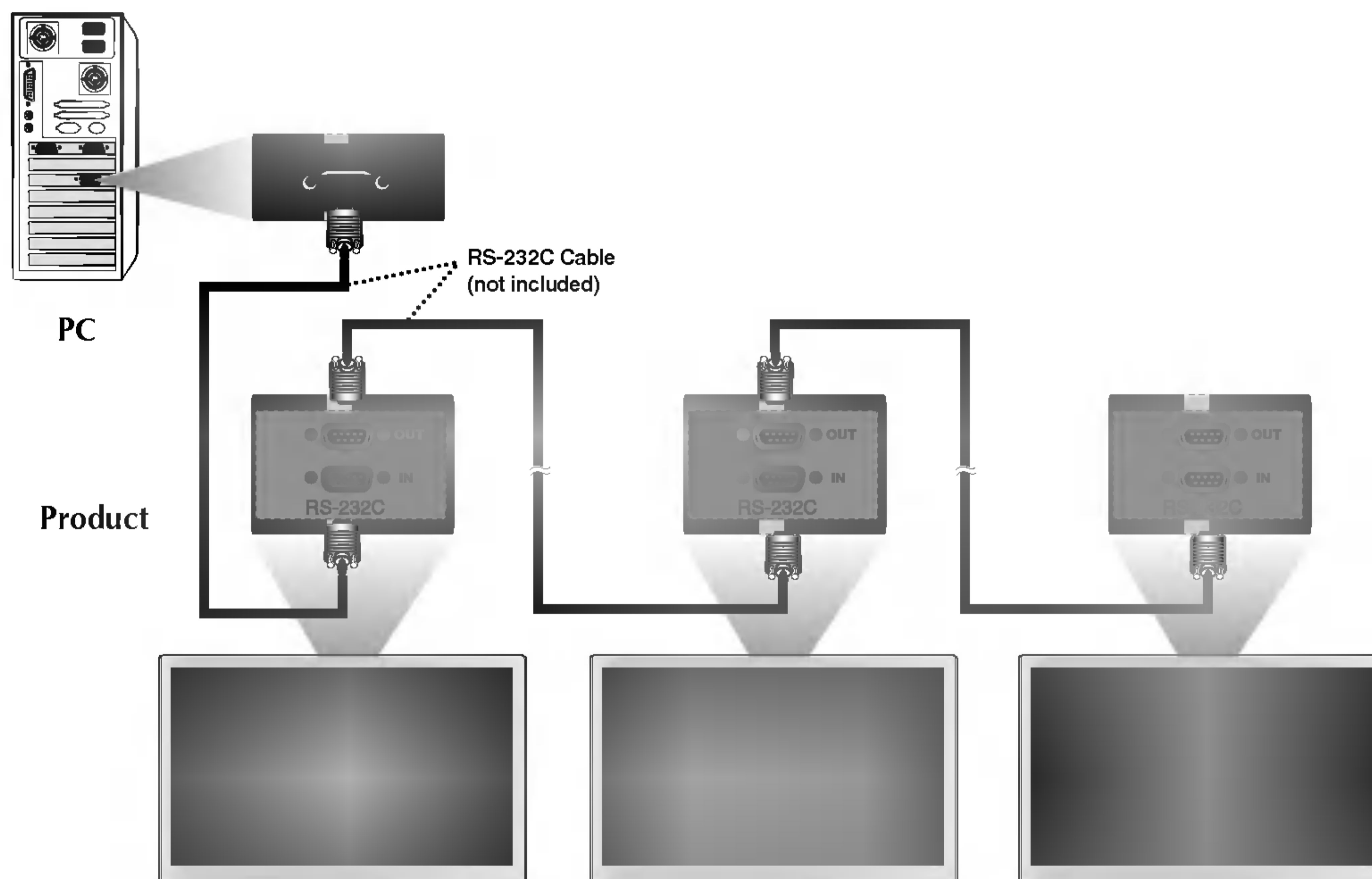

● Communication Parameter

- ▶ Baud Rate : 9600bps (UART)
- ▶ Data Length : 8bits
- ▶ Parity Bit : None
- ▶ Stop Bit : 1bit
- ▶ Flow Control : None
- ▶ Communication Code : ASCII code

● Command Reference List

	COMMAND1	COMMAND2	DATA(Hexa)
01. Power	k	a	00H - 01H
02. Input Select	k	b	00H - 08H
03. Aspect Ratio	k	c	01H - 06H
04. Screen Mute	k	d	00H - 01H
05. Volume Mute	k	e	00H - 01H
06. Volume Control	k	f	00H - 64H
07. Contrast	k	g	00H - 64H
08. Brightness	k	h	00H - 64H
09. Color	k	i	00H - 64H
10. Tint	k	j	00H - 64H
11. Sharpness	k	k	00H - 64H
12. OSD Select	k	l	00H - 01H
13. Remote Lock On/Off	k	m	00H - 01H
14. PIP/PBP/POP On/Off	k	n	00H - 03H
15. PIP Position	k	q	00H - 03H
16. Balance	k	t	00H - 64H
17. ACC	k	u	00H - 03H
18. PIP/PBP/POP SOURCE	k	y	00H - 08H
19. Auto Configure	j	u	01H
20. Key	m	c	Key Code

● Transmission / Receiving Protocol

Transmission

[Command1][Command2][][Set ID][][Data][Cr]

- * [Command 1]: First command. (j or k)
- * [Command 2]: Second command.
- * [Set ID]: You can adjust the set ID to choose desired product ID number in Special menu. Adjustment range is 0 ~ 99.
When selecting Set ID '0', every connected TV set is controlled. Set ID is indicated as decimal (0~99) on menu and as Hexa decimal (0x0~0x64) on transmission/receiving protocol.
- * [DATA]: To transmit command data.
Transmit 'FF' data to read status of command.
- * [Cr]: Carriage Return
ASCII code '0x0D'
- * []: ASCII code Space (0x20)

● Transmission / Receiving Protocol

OK Acknowledgement

[Command2][][Set ID][][OK][Data][x]

* The Product transmits ACK (acknowledgement) based on this format when receiving normal data. At this time, if the data is data read mode, it indicates present status data. If the data is data write mode, it returns the data of the PC computer.

Error Acknowledgement

[Command2][][Set ID][][NG][Data][x]

* The Product transmits ACK (acknowledgement) based on this format when receiving abnormal data from non-viable functions or communication errors.

Data 1: Illegal Code
2: Not supported function
3: Wait more time

01. Power On(Command : a)

▶ To control Power On/Off of the Set.

Transmission

[k][a][][Set ID][][Data][Cr]

Data 0 : Power Off 1 : Power On

Acknowledgement

[a][][Set ID][][OK][Data][x]

▶ To show the status of Power On/Off.

Transmission

[k][a][][Set ID][][FF][Cr]

Data 0 : Power Off 1 : Power On

Acknowledgement

[a][][Set ID][][OK][Data][x]

* The Product transmits ACK (acknowledgement) based on this format when receiving normal data. At this time, if the data is data read mode, it indicates present status data. If the data is data write mode, it returns the data of the PC computer.

Transmission / Receiving Protocol

02. Input Select(Command : b) (Main Picture Input)

- ▶ To select input source for the Set.
You can also select an input source using the SOURCE button on the remote control.

Transmission

```
[k][b][ ][Set ID][ ][Data][Cr]
```

Data 2 : AV 6 : RGB PC
 3 : S-Video 8 : DVI PC
 4 : Component 1
 5 : Component 2

Acknowledgement

```
[b][ ][Set ID][ ][OK][Data][x]
```

03. Aspect Ratio(Command : c) (Main picture format)

- ▶ To adjust the screen format.
You can also adjust the screen format using the ARC (Aspect Ratio Control) button on remote control or in the Screen menu.

Transmission

```
[k][c][ ][Set ID][ ][Data][Cr]
```

Data 1 : 4:3
 2 : Full
 3 : Spectacle
 4 : Zoom1
 5 : Zoom2
 6 : 1:1(PC)

Acknowledgement

```
[c][ ][Set ID][ ][OK][Data][x]
```

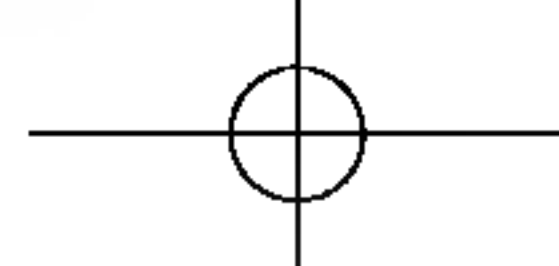

● Transmission / Receiving Protocol

04. Screen Mute(Command : d)

- ▶ To select screen mute on/off.

Transmission

```
[k][d][ ][Set ID][ ][Data][Cr]
```

Data 0 : Screen mute off (Picture on)
1 : Screen mute on (Picture off)

Acknowledgement

```
[d][ ][Set ID][ ][OK][Data][x]
```

05. Volume Mute(Command : e)

- ▶ To control On/Off of the Volume Mute.

Transmission

```
[k][e][ ][Set ID][ ][Data][Cr]
```

Data 0 : Volume Mute On (Volume Off)
1 : Volume Mute Off (Volume On)

Acknowledgement

```
[e][ ][Set ID][ ][OK][Data][x]
```

Data 0 : Volume Mute On (Volume Off)
1 : Volume Mute Off (Volume On)

06. Volume Control(Command : f)

- ▶ To adjust Volume.

Transmission

```
[k][f][ ][Set ID][ ][Data][Cr]
```

Data Min : 00H ~ Max : 64H
(Hexadecimal code)

Acknowledgement

```
[f][ ][Set ID][ ][OK][Data][x]
```

Data Min : 00H ~ Max : 64H

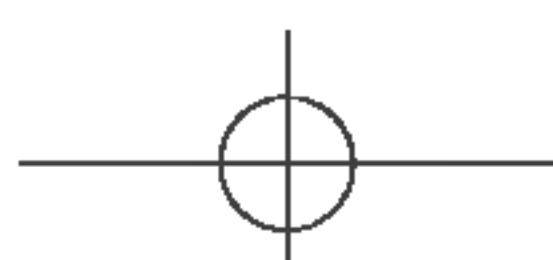

● Transmission / Receiving Protocol

07. Contrast(Command : g)

▶ To adjust screen contrast.

You can also adjust the contrast in the Picture menu.

Transmission

[k][g][][Set ID][][Data][Cr]

Data Min : 00H ~ Max : 64H

• Refer to 'Real data mapping' as shown below.

Acknowledgement

[g][][Set ID][][OK][Data][x]

* Real data mapping

0 : Step 0

⋮

A : Step 10

⋮

F : Step 15

10 : Step 16

⋮

64 : Step 100

08. Brightness(Command : h)

▶ To adjust screen brightness.

You can also adjust the brightness in the Picture menu.

Transmission

[k][h][][Set ID][][Data][Cr]

Data Min : 00H ~ Max : 64H

• Refer to 'Real data mapping' as shown below.

Acknowledgement

[h][][Set ID][][OK][Data][x]

* Real data mapping

0 : Step

⋮

A : Step 10

⋮

F : Step 15

10 : Step 16

⋮

64 : Step 100



Transmission / Receiving Protocol

09. Color(Command : i) (AV only)

- ▶ To adjust the screen color.
You can also adjust the color in the Picture menu.

Transmission

[k][i][][Set ID][][Data][Cr]

Data Min : 00H ~ Max : 64H
(Hexadecimal code)

Acknowledgement

[i][][Set ID][][OK][Data][x]

Data Min : 00H ~ Max : 64H

10. Tint(Command : j) (AV-NTSC only)

- ▶ To adjust the screen tint.
You can also adjust the tint in the Picture menu.

Transmission

[k][j][][Set ID][][Data][Cr]

Data Red: 00H ~ Green: 64H
(Hexadecimal code)

Acknowledgement

[j][][Set ID][][OK][Data][x]

Data Red: 00H ~ Green: 64H

* Tint : -50 ~ +50

Transmission / Receiving Protocol

11. Sharpness(Command : k) (AV only)

- ▶ To adjust the screen Sharpness.
You can also adjust the sharpness in the Picture menu.

Transmission

[k][k][][Set ID][][Data][Cr]

Data Min : 00H ~ Max : 64H
(Hexadecimal code)

Acknowledgement

[k][][Set ID][][OK][Data][x]

Data Min : 00H ~ Max : 64H

12. OSD Select(Command : l)

- ▶ To control OSD on/off to the set.

Transmission

[k][l][][Set ID][][Data][Cr]

Data 0 : OSD Off 1 : OSD On

Acknowledgement

[l][][Set ID][][OK][Data][x]

Data 0 : OSD Off 1 : OSD On

13. Remote Lock On/Off(Command : m)

- ▶ To control Remote Lock on/off to the set.

Transmission

[k][m][][Set ID][][Data][Cr]

Data 0 : Remote Lock Off 1 : Remote Lock On

Acknowledgement

[m][][Set ID][][OK][Data][x]

Data 0 : Remote Lock Off 1 : Remote Lock On

 **Transmission / Receiving Protocol****14. PIP/PBP/POP On/Off(Command : n)**

▶ To control PIP/PBP/POP On/Off of the Set.

Transmission

[k][n][][Set ID][][Data][Cr]

Data 0 : OFF

- 1 : PIP
- 2 : PBP
- 3 : POP

Acknowledgement

[n][][Set ID][][OK][Data][x]

Data 0 : OFF

- 1 : PIP
- 2 : PBP
- 3 : POP

15. PIP Position(Command : q)

▶ To adjust PIP position.

Transmission

[k][q][][Set ID][][Data][Cr]

Data 0 : Bottom of the right side on screen

- 1 : Bottom of the left side on screen
- 2 : Top of the left side on screen
- 3 : Top of the right side on screen

Acknowledgement

[q][][Set ID][][OK][Data][x]

Data 0 : Bottom of the right side on screen

- 1 : Bottom of the left side on screen
- 2 : Top of the left side on screen
- 3 : Top of the right side on screen

Transmission / Receiving Protocol

16. Balance(Command : t)

▶ To adjust the sound Balance.

Transmission

```
[k][t][ ][Set ID][ ][Data][Cr]
```

Data Min : 00H ~ Max : 64H
(Hexadecimal code)

Acknowledgement

```
[t][ ][Set ID][ ][OK][Data][x]
```

Data Min : 00H ~ Max : 64H

* Balance : -50 ~ +50

17. ACC(Command : u)

▶ To adjust the screen color temperature.

Transmission

```
[k][u][ ][Set ID][ ][Data][Cr]
```

Data 0 : Normal (9300K) 2 : Warm (6500K)
1 : Cool 3 : User
PC : 0, 2, 3 AV : 0, 1, 2

Acknowledgement

```
[u][ ][Set ID][ ][OK][Data][x]
```

Data 0 : Normal (9300K) 2 : Warm (6500K)
1 : Cool 3 : User
PC : 0, 2, 3 AV : 0, 1, 2

18. PIP/PBP/POP SOURCE(Command : y)

▶ To select the sub-screen source.

Transmission

```
[k][y][ ][Set ID][ ][Data][Cr]
```

Data 2 : AV 5 : Component 2
3 : S-Video 6 : RGB PC
4 : Component 1 8 : DVI PC

Acknowledgement

```
[y][ ][Set ID][ ][OK][Data][x]
```

Data 2 : AV 5 : Component 2
3 : S-Video 6 : RGB PC
4 : Component 1 8 : DVI PC

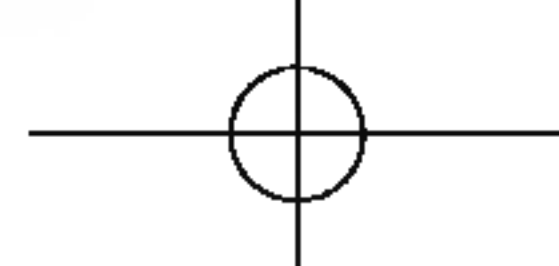

Transmission / Receiving Protocol

19. Auto Configure(Command: j u)

- ▶ To adjust picture position and minimize image shaking automatically. it works only in RGB(PC) mode.

Transmission

[j][u][][Set ID][][Data][Cr]

Data 1 : To set

Acknowledgement

[u][][Set ID][][OK][Data][x]

20. Key(Command : m c)

- ▶ To send IR remote key code.

Transmission

[m][c][][Set ID][][Data][Cr]

Data Key code : Refer to page 41.

Acknowledgement

[c][][Set ID][][OK][Data][x]

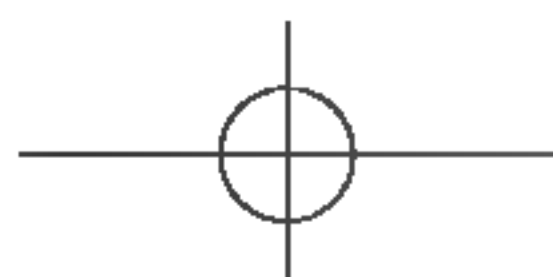

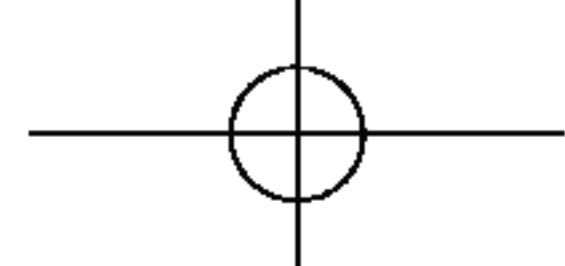

IR Codes

ENGLISH

How to connect

▶ Connect your wired remote control to Remote Control port on the Product.

Remote Control IR Code

▶ Output waveform

single pulse, modulated with 37.917KHz signal at 455KHz

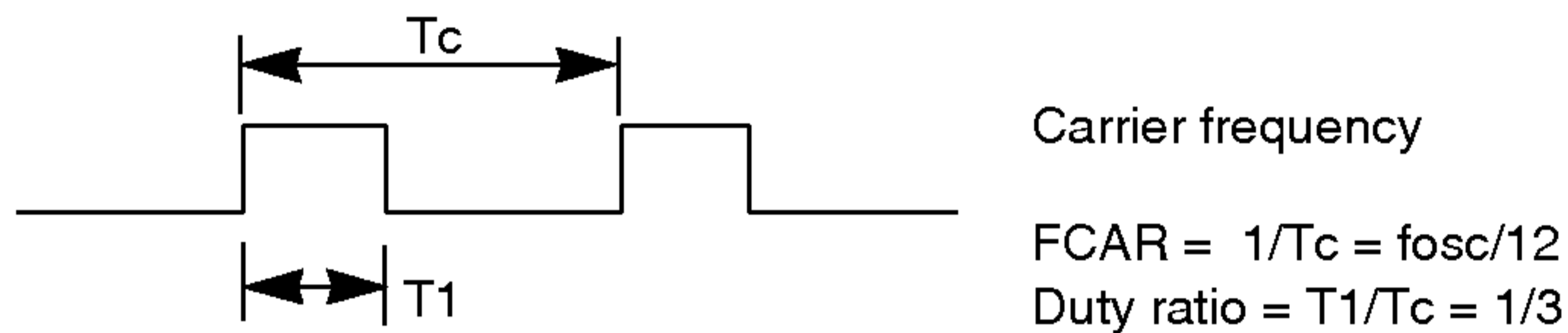

▶ Configuration of frame

• 1st frame

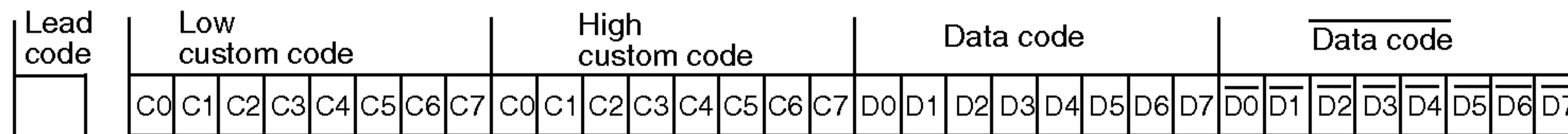

• Repeat frame

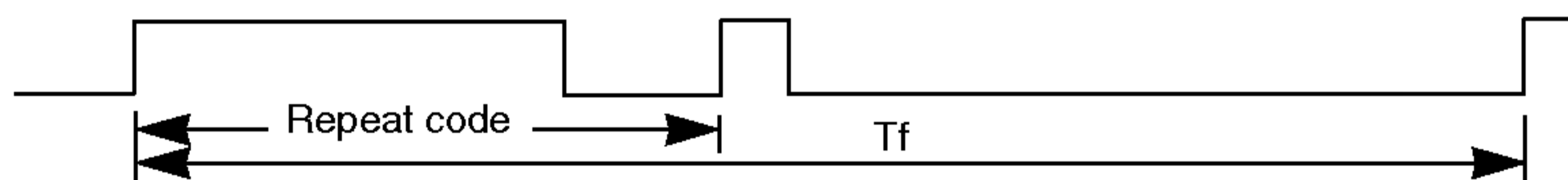

▶ Lead code

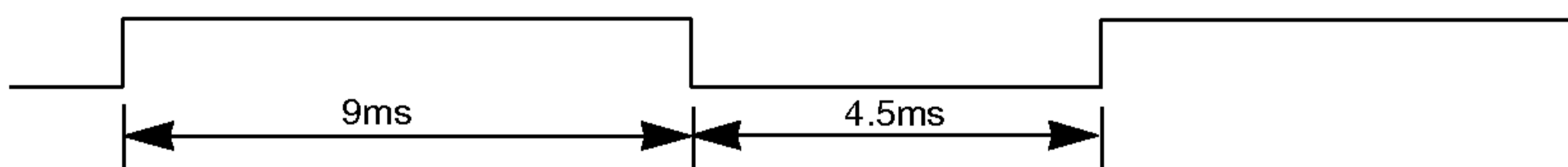

▶ Repeat code

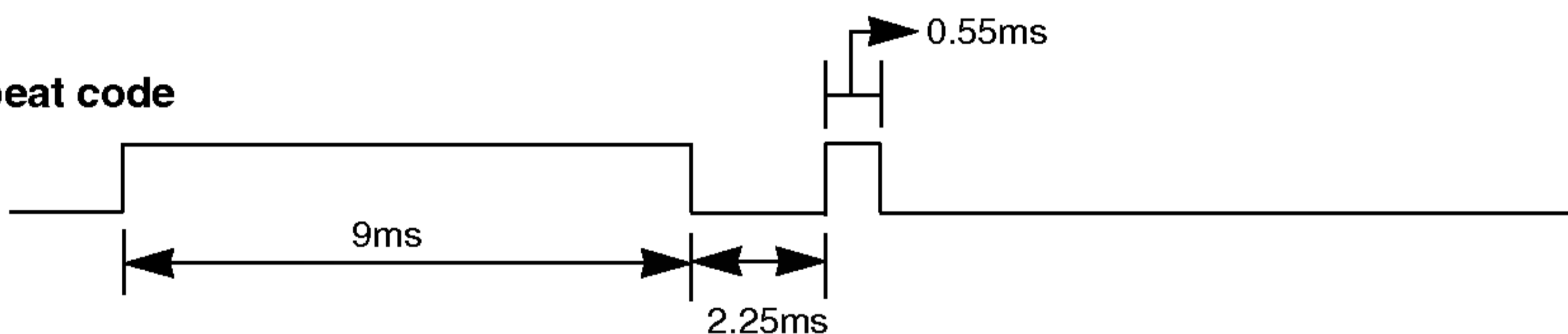

▶ Bit description

• Bit "0"

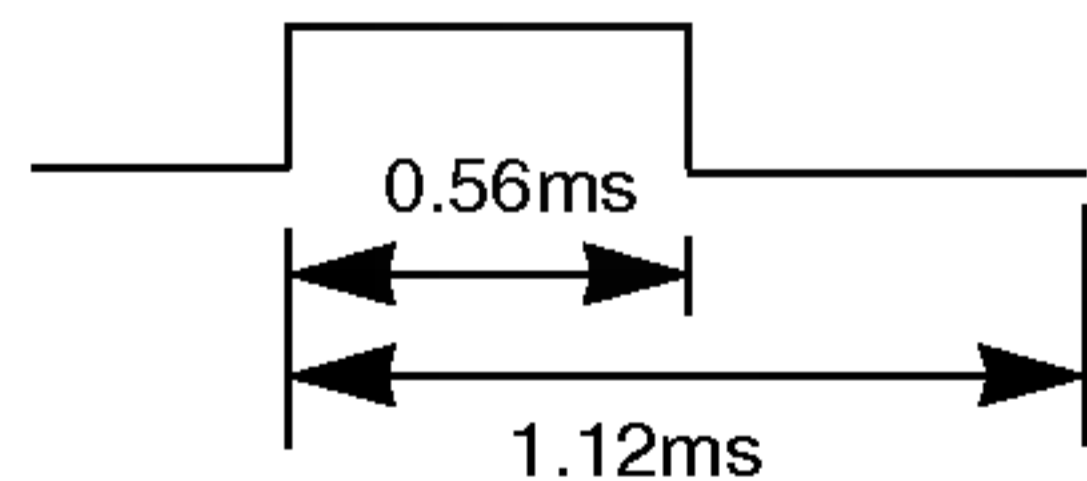

• Bit "1"

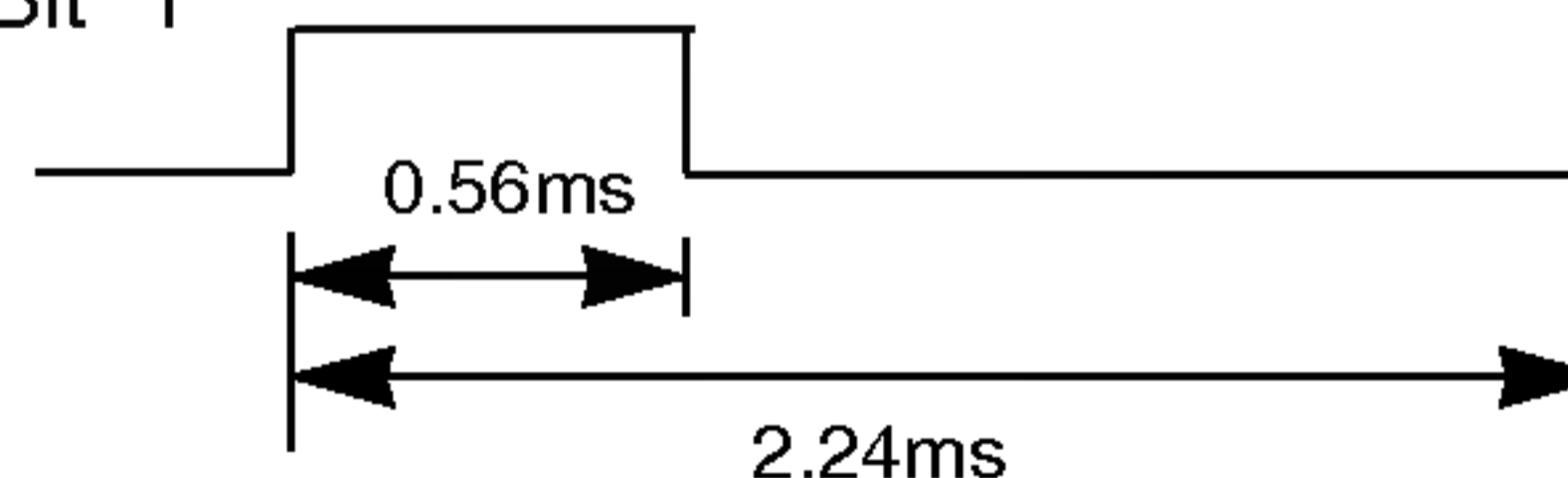

▶ Frame interval : Tf

• The waveform is transmitted as long as a key is depressed.

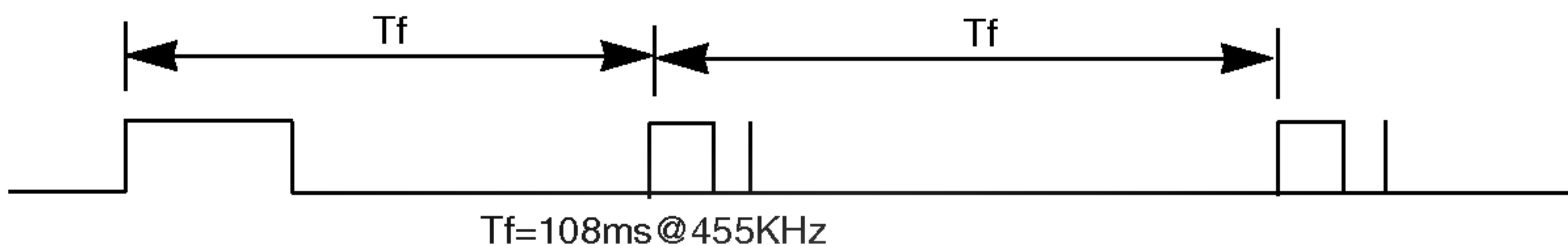

Tf=108ms@455KHz

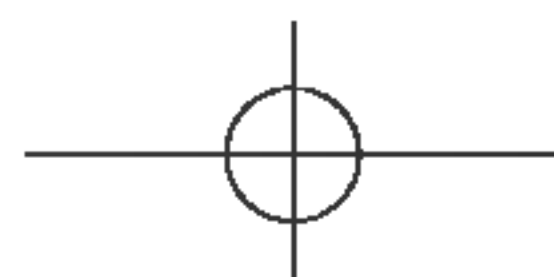

IR Codes

Code(Hexa)	Function	Note
00	(▲)	R/C Button
01	(▼)	R/C Button
02	VOL(▶)	R/C Button
03	VOL(◀)	R/C Button
08	POWER ON/OFF	R/C Button(Power On/Off)
C4	POWER ON	Discrete IR Code(Only Power On)
C5	POWER OFF	Discrete IR Code(Only Power Off)
09	MUTE	R/C Button
10	Number Key 0	R/C Button
11	Number Key 1	R/C Button
12	Number Key 2	R/C Button
13	Number Key 3	R/C Button
14	Number Key 4	R/C Button
15	Number Key 5	R/C Button
16	Number Key 6	R/C Button
17	Number Key 7	R/C Button
18	Number Key 8	R/C Button
19	Number Key 9	R/C Button
0B	AV	R/C Button
98	SOURCE	R/C Button
5A	AV	Discrete IR Code(Input AV Selection)
D8	S-Video	Discrete IR Code(Input S-video Selection)
BF	Component 1	Discrete IR Code(Input Component 1 Selection)
D4	Component 2	Discrete IR Code(Input Component 2 Selection)
C6	DVI	Discrete IR Code(Input DVI Selection)
D5	RGB	Discrete IR Code(Input RGB Selection)
0E	SLEEP	R/C Button
43	MENU	R/C Button
44	SET	R/C Button
60	PIP	R/C Button
63	SWAP	R/C Button
79	ARC	R/C Button
76	ARC(4:3)	Discrete IR Code(Only 4:3 mode)
77	ARC(Full)	Discrete IR Code(Only Full mode)
AF	ARC(ZOOM)	Discrete IR Code(Only Zoom mode)
99	AUTO CONFIG	Discrete IR Code

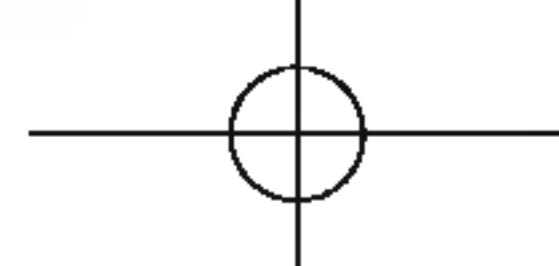

- | | |
|--|--|
| <ul style="list-style-type: none"> ● Is the product power cord connected? | <ul style="list-style-type: none"> • See if the power cord is properly connected to the outlet. |
| <ul style="list-style-type: none"> ● Is the power indicator light on? | <ul style="list-style-type: none"> • See if the power switch is turned on. |
| <ul style="list-style-type: none"> ● Power is on, power indicator is green but the screen appears extremely dark. | <ul style="list-style-type: none"> • Adjust brightness and contrast again. |
| <ul style="list-style-type: none"> ● the power indicator amber? | <ul style="list-style-type: none"> • If the product is in power saving mode, move the mouse or press any key. |
| <ul style="list-style-type: none"> ● Does the 'Out of range' message appear? | <ul style="list-style-type: none"> • The signal from the PC (video card) is out of the vertical or horizontal frequency range of the product. Adjust the frequency range by referring to the Specifications in this manual. * Maximum resolution
RGB PC : 1600 x 1200 @60Hz
DVI PC : 1360 x 768 @60Hz |
| <ul style="list-style-type: none"> ● Does the 'Check signal cable' message appear? | <ul style="list-style-type: none"> • The signal cable between PC and product is not connected. Check the signal cable. • Press the 'SOURCE' menu in the remote control to check the input signal. |

- | | |
|---|---|
| <ul style="list-style-type: none"> ● Did you install the driver? | <ul style="list-style-type: none"> • Install the product driver, which is provided with the product, or download it from the web site. (http://www.lge.com) • See if the plug&play function is supported by referring to the video card user manual. |
|---|---|

- | | |
|--|--|
| <ul style="list-style-type: none"> ● The 'Controls locked' message appears when pressing the Menu button. | <ul style="list-style-type: none"> • The control locking function prevents unintentional OSD setting change due to careless usage. To unlock the controls, simultaneously press the Menu button and ► button for several seconds. (You cannot set this function using the remote control buttons. You can set this function in the product only.) |
|--|--|

**Note**

* **Vertical frequency:** To enable the user to watch the product display, screen image should be changed tens of times every second like a fluorescent lamp. The vertical frequency or refresh rate is the times of image display per second. The unit is Hz.

* **Horizontal frequency:** The horizontal interval is the time to display one vertical line. When 1 is divided by the horizontal interval, the number of horizontal lines displayed every second can be tabulated as the horizontal frequency. The unit is kHz.

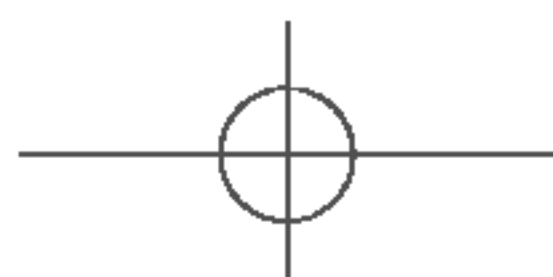

Troubleshooting

The screen image looks abnormal.

- **Is the screen position wrong?**
 - D-Sub analog signal – Press the “AUTO” button in the remote control to automatically select the optimal screen status that fits into the current mode. If adjustment is not satisfactory, use the Position OSD menu.
 - See if the video card resolution and frequency are supported by the product. If the frequency is out of range, set to the recommended resolution in the Control Panel – Display – Setting menu.
- **Do thin lines appear on the background screen?**
 - D-Sub analog signal – Press the “AUTO” button in the remote control to automatically select an optimal screen status that fits into the current mode. If adjustment is not satisfactory, use the Clock OSD menu.
- **Horizontal noise appears or the characters look blurred.**
 - D-Sub analog signal – Press the “AUTO” button in the remote control to automatically select an optimal screen status that fits into the current mode. If adjustment is not satisfactory, use the Phase OSD menu.
- **Unable to adjust the horizontal/vertical position in the Zoom menu.**
 - See if the Zoom value is set to 0. If it is, you cannot adjust the H/V Position value.
- **Screen size is automatically adjusted when connected to the PC.**
 - If the screen size is not full when connected to the PC, execute the PIP/POP/PBP to change to full screen mode.
- **Brightness differs in the main and sub screen when connected to the PC.**
 - You cannot adjust brightness and tint in the PIP/POP/PBP Screen menu for the sub-screen among PIP/POP/PBP menus. Therefore, brightness can be different for the sub-screen.
- **The screen is displayed abnormally.**
 - The proper input signal is not connected to the signal port. Connect the signal cable that matches with the source input signal.

After-image appears on the product.

- **After-image appears when the product is turned off.**
 - If you use a fixed image for a long time, the pixels may be damaged quickly. Use the screensaver function.

The audio function does not work.

- **No sound?**
 - See if the audio cable is connected properly.
 - Adjust the volume.
 - See if the sound is set properly.
- **No sound is available when the PIP/POP/PBP mode is engaged.**
 - See if the Sound is set to On in the PIP/POP/PBP menu.
- **Sound is too dull.**
 - Select the appropriate equalize sound.
- **Sound is too low.**
 - Adjust the volume.

The screen size function in the OSD menu does not work.

- **The screen size function in the OSD menu does not work.**
 - See if the PIP/POP/PBP function is in use. If the PIP/POP/PBP function is in use, the screen size function may not work.

Screen color is abnormal.

- **Screen has poor color resolution (16 colors).**
 - Set the number of colors to more than 24 bits (true color)
Select Control Panel – Display – Settings – Color Table menu in Windows.
- **Screen color is unstable or mono-colored.**
 - Check the connection status of the signal cable.
Or, re-insert the PC video card.
- **Do black spots appear on the screen?**
 - Several pixels (red, green, white or black color) may appear on the screen, which can be attributable to the unique characteristics of the LCD panel. It is not a malfunction of the LCD.

The product specifications can change without prior notice for product improvement.

LCD Panel

[32 inch]	32 inches (80.04 cm) TFT (Thin Film Transistor) LCD (Liquid Crystal Display) Panel Visible diagonal size: 80.04 cm 0.5025 mm (Pixel Pitch)
[37 inch]	37 inches (94.03 cm) TFT (Thin Film Transistor) LCD (Liquid Crystal Display) Panel Visible diagonal size: 94.03 cm 0.6000 mm (Pixel Pitch)
[42 inch]	42 inches (106.68 cm) TFT (Thin Film Transistor) LCD (Liquid Crystal Display) Panel Anti-Glare coating Visible diagonal size: 106.68 cm 0.681 mm (Pixel Pitch)

Power

[32 inch]	<p>Rated Voltage AC 100-240V~ 50/60Hz 2.0A</p> <p>Power Consumption On Mode : 160W Sleep Mode : ≤ 4W Off Mode : ≤ 2W</p>
[37 inch]	<p>Rated Voltage AC 100-240V~ 50/60Hz 2.4A</p> <p>Power Consumption On Mode : 220W Sleep Mode : ≤ 4W Off Mode : ≤ 3W</p>
[42 inch]	<p>Rated Voltage AC 100-240V~ 50/60Hz 2.8A</p> <p>Power Consumption On Mode : 300W Sleep Mode : ≤ 4W Off Mode : ≤ 3W</p>

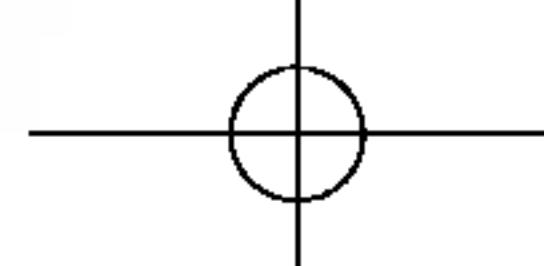

The product specifications can change without prior notice for product improvement.

Dimensions & Weight

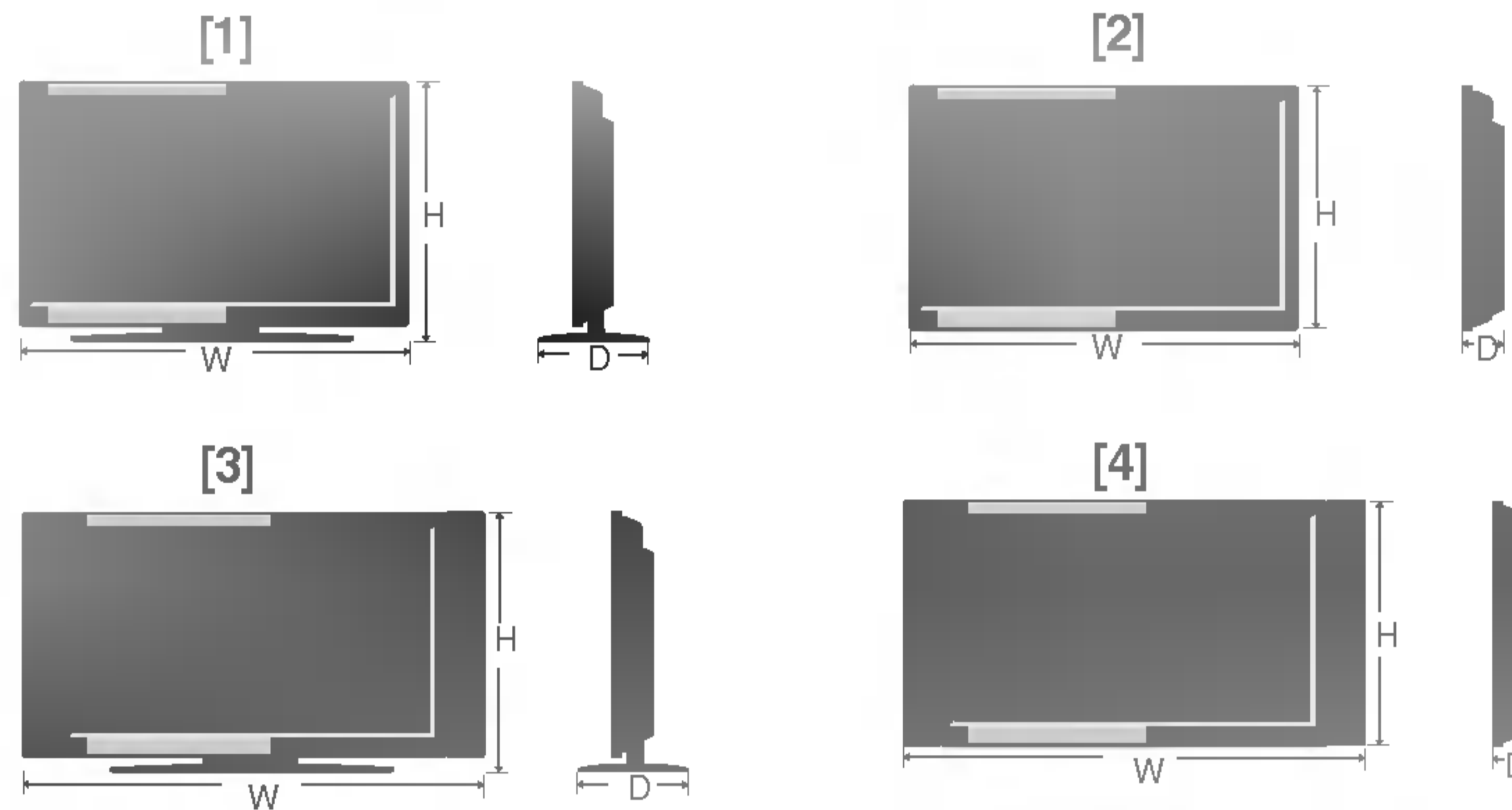

Width x Height x Depth

[32 inch]

[1] 80.30 cm (31.61 inches) x 54.00cm (21.26 inches) x 18.00 cm (7.09 inches)

[2] 80.30 cm (31.61 inches) x 49.30 cm (19.4 inches) x 9.99 cm (3.93 inches)

[3] 96.40 cm (37.95 inches) x 54.00cm (21.26 inches) x 18.00 cm (7.09 inches)

[4] 96.40 cm (37.95 inches) x 49.30 cm (19.4 inches) x 9.99 cm (3.93 inches)

[37 inch]

[1] 92.80 cm (36.54 inches) x 61.90 cm (24.37 inches) x 22.77 cm (8.96 inches)

[2] 92.80 cm (36.54 inches) x 57.12 cm (22.49 inches) x 12.00 cm (4.72 inches)

[3] 112.9 cm (44.45 inches) x 61.90 cm (24.37 inches) x 22.77 cm (8.96 inches)

[4] 112.9 cm (44.45 inches) x 57.12 cm (22.49 inches) x 12.00 cm (4.72 inches)

[42 inch]

[1] 105.7 cm (41.61 inches) x 70.20 cm (27.64 inches) x 29.45 cm (11.59 inches)

[2] 105.7 cm (41.61 inches) x 65.30 cm (25.71 inches) x 11.91 cm (4.69 inches)

[3] 125.9 cm (49.57 inches) x 70.20 cm (27.64 inches) x 29.45 cm (11.59 inches)

[4] 125.9 cm (49.57 inches) x 65.30 cm (25.71 inches) x 11.91 cm (4.69 inches)

Net

[32 inch]

[1] 19.4 kg (42.77 lbs)

[2] 16.0 kg (35.27 lbs)

[3] 21.1 kg (46.52 lbs)

[4] 17.7 kg (39.02 lbs)

[37 inch]

[1] 31.1 kg (68.56 lbs)

[2] 29.0 kg (63.93 lbs)

[3] 39.1 kg (86.20 lbs)

[4] 35.1 kg (77.38 lbs)

[42 inch]

[1] 41.4 kg (91.27 lbs)

[2] 37.0 kg (81.57 lbs)

[3] 44.0 kg (97.00 lbs)

[4] 39.6 kg (87.30 lbs)

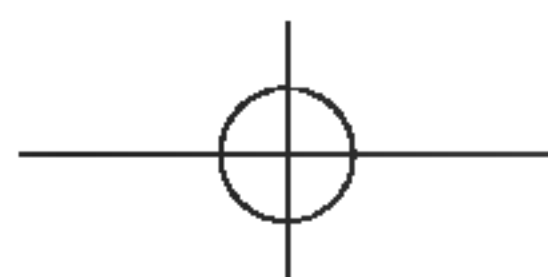

The product specifications can change without prior notice for product improvement.

Video Signal	Max. Resolution	RGB PC : 1600 X 1200 @60Hz DVI PC : 1360 X 768 @60Hz – It may not be supported depending on the OS or video card type.
	Recommended Resolution	RGB PC : WXGA 1360 X 768 @60Hz DVI PC : WXGA 1360 X 768 @60Hz – It may not be supported depending on the OS or video card type.
	Horizontal Frequency	RGB PC : 30 - 83 kHz DVI PC : 30 - 72 kHz
	Vertical Frequency	56 - 85 Hz
	Synchronization Type	Separate/Composite/SOG (Sync On Green)/Digital
		15-pin D-Sub type, DVI-D (digital), S-Video, Composite Video, HDTV, DVD
	Operational Condition Storage Condition	Temperature: 10°C ~ 35°C , Humidity: 10% ~ 80% Temperature: -20°C ~ 60°C , Humidity: 5% ~ 95%

*** Applicable only for models that support the speakers**

RMS Audio Output	10W+10W(R+L)
Input Sensitivity	0.7Vrms
Speaker Impedance	8Ω

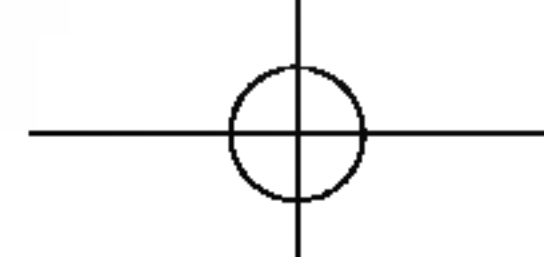

● PC Mode – Preset Mode

1	VGA	640 x 350	31.469	70	11	VESA 1024 x 768	60.123	75
2	VGA	720 x 400	31.468	70	12	VESA 1024 x 768	68.68	85
3	VGA	640 x 480	31.469	60	13	VESA 1280 x 720	44.772	60
4	VESA	640 x 480	37.500	75	14	VESA 1360 x 768	47.72	60
5	VESA	640 x 480	43.269	85	15	VESA 1280 x 1024	63.981	60
6	VESA	800 x 600	37.879	60	16	VESA 1280 x 1024	79.98	75
7	VESA	800 x 600	46.875	75	17	VESA 1600 x 1200	75.00	60
8	VESA	800 x 600	53.674	85	RGB PC : Mode 1 ~ Mode 17 DVI PC : Mode 1 ~ Mode 15			
9	MAC	832 x 624	49.725	75				
10	VESA	1024 x 768	48.363	60				

● Power Indicator

On Mode	Green
Sleep Mode	Amber
Off Mode	-

VESA wall mounting

Connected to another object (stand type and wall-mounted type.) This product accepts a VESA-compliant mounting interface pad.- **(optional)**
For further information, refer to the VESA Wall Mounting Instruction Guide.

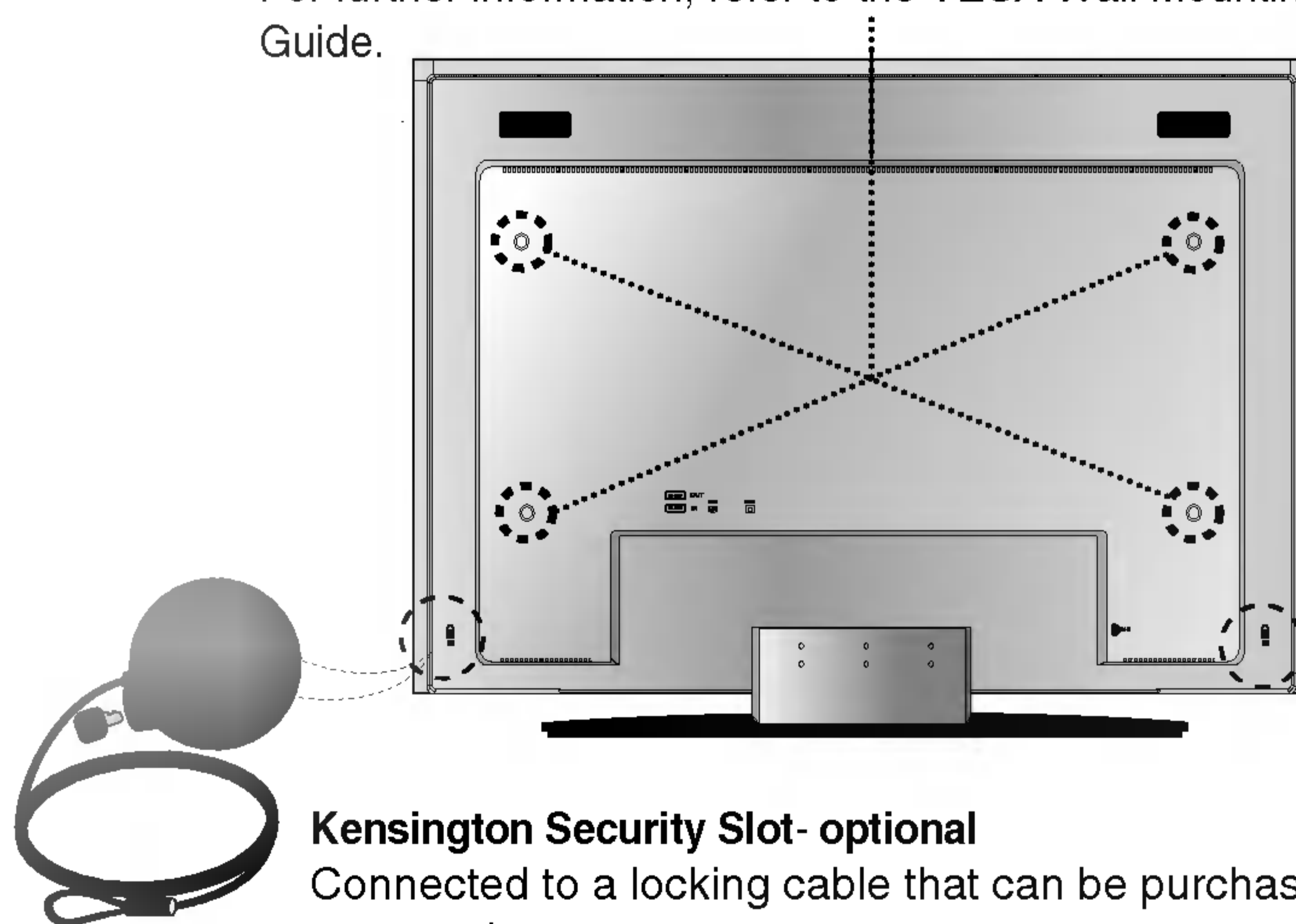

Kensington Security Slot- optional

Connected to a locking cable that can be purchased separately at most computer stores

