



# LCD Colour Television OWNER'S MANUAL

**MODELS: RM-23LZ50  
RM-26LZ50  
RM-27LZ50  
RM-30LZ50  
RM-32LZ50**

Please read this manual carefully before operating your set.  
Retain it for future reference.

Record model number and serial number of the set.

See the label attached on the back cover and quote this information to your dealer when you require service.

Internet Home Page : <http://www.lge.com>

<http://www.lge.com.br>

Q : 3828TUL271B(0407-REV00)

in Korea

# Safety Instructions

**WARNING : TO REDUCE THE RISK OF FIRE OR ELECTRIC SHOCK, DO NOT EXPOSE THIS PRODUCT TO RAIN OR MOISTURE.**  
**CAUTION : TO REDUCE THE RISK OF ELECTRIC SHOCK, DO NOT REMOVE COVER(OR BACK). NO USER-SERVICEABLE PARTS IN SIDE. REFER SERVICING TO QUALIFIED SERVICE PERSONNEL.**

## Cleaning

Unplug this television receiver from the wall outlet before cleaning. Do not use liquid cleaners or aerosol cleaners. Use a damp cloth for cleaning.

Do not use attachments not recommended by the television receiver manufacturer as they may cause hazards.

## Power Supply

This television receiver should be operated only from the type of power source indicated on the marking label. If you are not sure of the type of power supplied to your home, consult your television dealer or local power company.

## Installation

Do not use this television receiver near water, for example, near a bathtub, washbowl, kitchen sink, or laundry tub, in a wet basement, or near a swimming pool, etc.

Do not place this television receiver on an unstable cart, stand, or table. The television receiver may fall, causing serious injury to a child or an adult, and serious damage to the appliance.

Use only with a cart or stand recommended by the manufacturer, or sold with the television receiver. Wall or shelf mounting should follow the manufacturer's instructions and should use a mounting kit approved by the manufacturer.

Slots and openings in the cabinet and the back or bottom are provided for ventilation, and to insure reliable operation of the television receiver, and to protect it from overheating. These openings must not be blocked or covered. The openings should never be blocked by placing the television receiver on a bed, sofa, rug, or other similar surface. This television receiver should not be placed in a builtin installation such as a bookcase unless proper ventilation is provided.

It is recommended not to operate this unit near speakers or big metallic furnitures in order to keep their magnetism from disturbing colors purity (uniformity) on the screen.

## Use

Do not allow anything to rest on the power cord. Do not locate this television receiver where the cord will be abused by persons walking on it.

Do not overload wall outlets and extension cords as this can result in fire or electric shock.

Never push objects of any kind into this television receiver through cabinet slots as they may touch dangerous voltage points or short out parts that could result in a fire or electric shock.

Never spill liquid of any kind on the television receiver.

## Service

Do not attempt to service this television yourself as opening or removing covers may expose you to dangerous voltage or other hazards. Refer all servicing to qualified personnel.

## Writing Model And Serial Numbers

The serial number and model number are found on the back of this unit. The serial number is unique to this unit. You should record requested information here and retain this guide as a permanent record of your purchase. Please retain your purchase receipt as your proof of purchase.

Date of Purchase \_\_\_\_\_  
Dealer Purchased from \_\_\_\_\_  
Dealer Address \_\_\_\_\_  
Dealer Phone No. \_\_\_\_\_  
Model No. \_\_\_\_\_  
Serial No. \_\_\_\_\_

# Contents

Safety Instructions .....	2		
<b>Introduction</b>			
Controls .....	4		
Connection Options .....	5		
Remote Control Key Functions .....	6		
<b>Installation</b>			
Accessories .....	7		
Kensington Security System .....	7		
Installation Instruction .....	8		
External Equipment Connections .....	9~12		
Antenna Connection .....	9		
VCR Setup .....	10		
Cable TV Setup .....	10		
External A/V Source Setup .....	11		
DVD Setup .....	11		
DTV Setup .....	12		
PC Setup .....	12		
<b>Operation</b>			
TV Operation Overview .....	13		
Menu Language Selection .....	13		
Channel Menu Options			
Memorizing the Channels with Auto Program ..	14		
Add/Delete Channels with Manual Program ..	14		
Favorite Channels Setup .....	15		
Picture Menu Options			
APC (Auto Picture Control) .....	16		
Manual Picture Control (User option) .....	16		
Picture format (ARC) .....	16		
		Sound Menu Options	
		DASP (Digital Auto Sound Processing) .....	17
		Equalizer Adjustments .....	17
		AVL (Auto Volume Leveler) .....	17
		Sound Balance .....	18
		Stereo/SAP Broadcasts Setup .....	18
		Timer Menu Options	
		Clock Setup .....	19
		On/Off Timer Setup .....	19
		Sleep Timer Setup .....	20
		Auto Off .....	20
		Special Menu Options	
		Closed Captions .....	21
		Caption .....	21
		Key Lock .....	21
		PC Menu Options .....	22
		<b>IR Codes .....</b>	<b>23</b>
		<b>Maintenance .....</b>	<b>24</b>
		<b>Product Specifications .....</b>	<b>25</b>
		<b>Troubleshooting Checklist .....</b>	<b>27</b>

# Introduction

## Controls

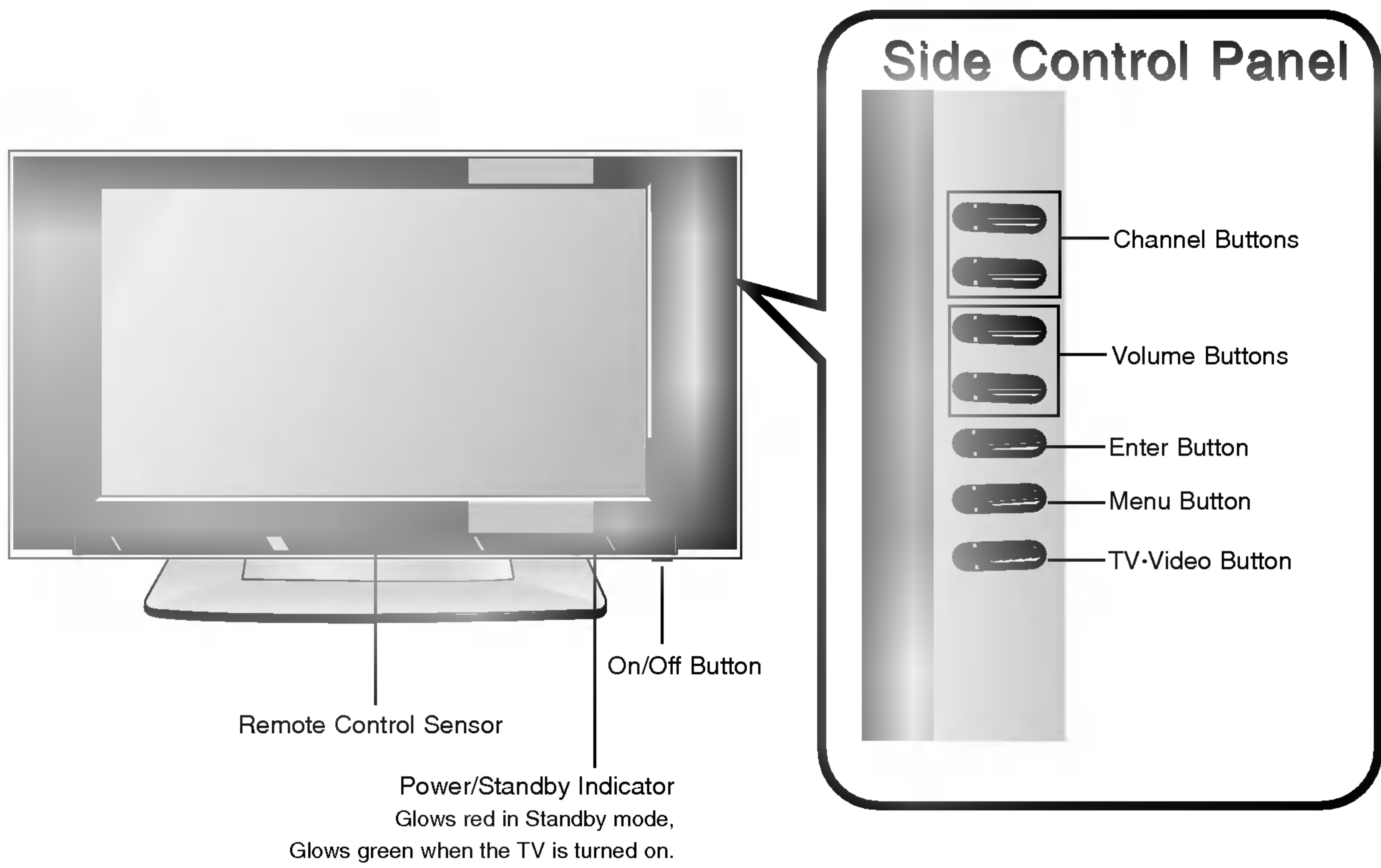

# Connection Options

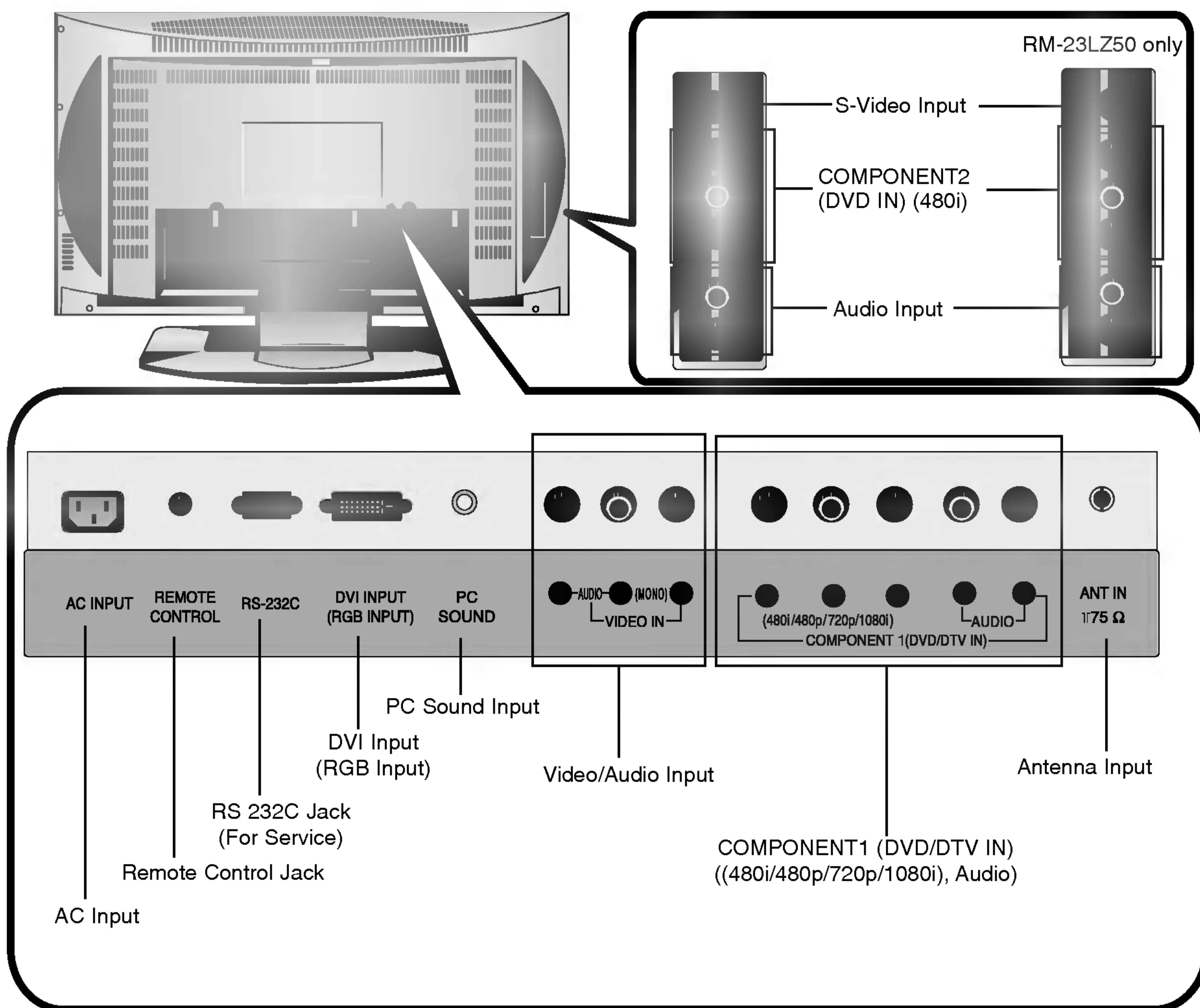



# Remote Control Key Functions

- When using the remote control, aim it at the remote control sensor on the TV.

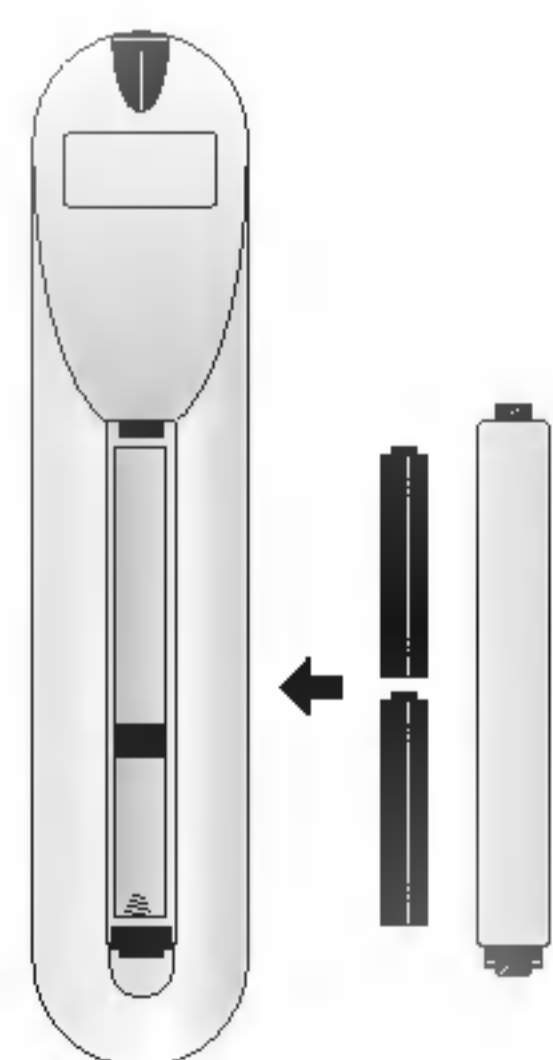
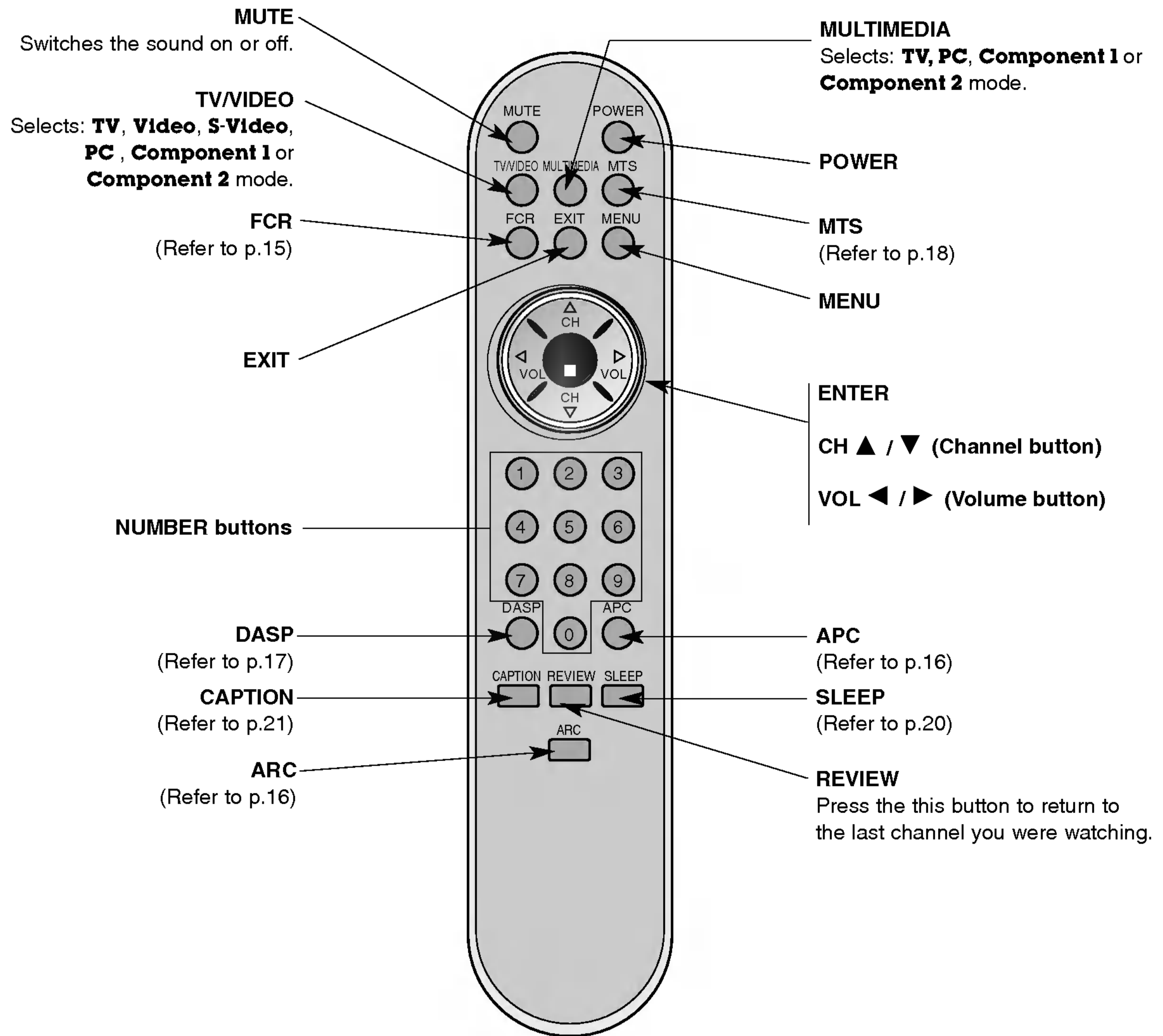

- Open the battery compartment cover on the back side and insert the batteries with correct polarity.
- Install two 1.5V batteries of AAA type. Don't mix used batteries with new batteries.

# Installation

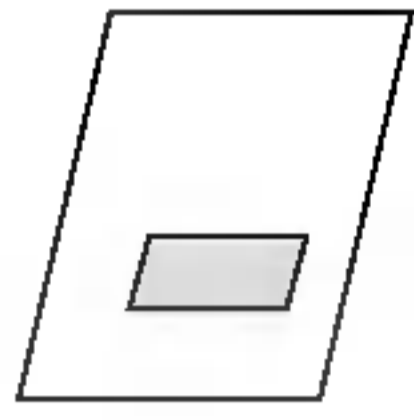

Owner's Manual

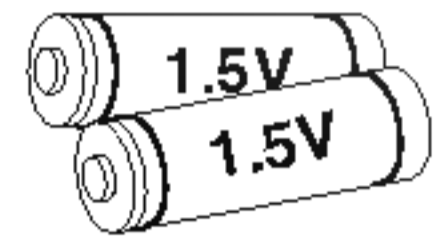

AAA Batteries

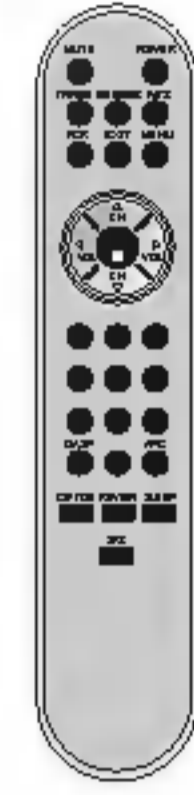

Remote Control

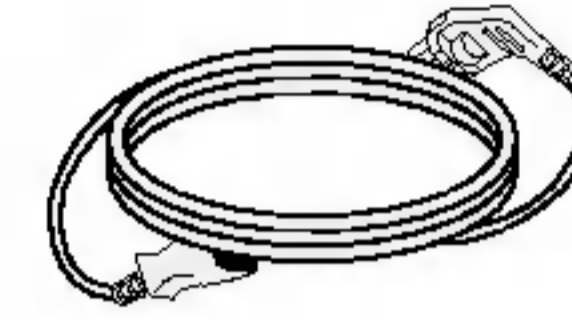

Power Cord

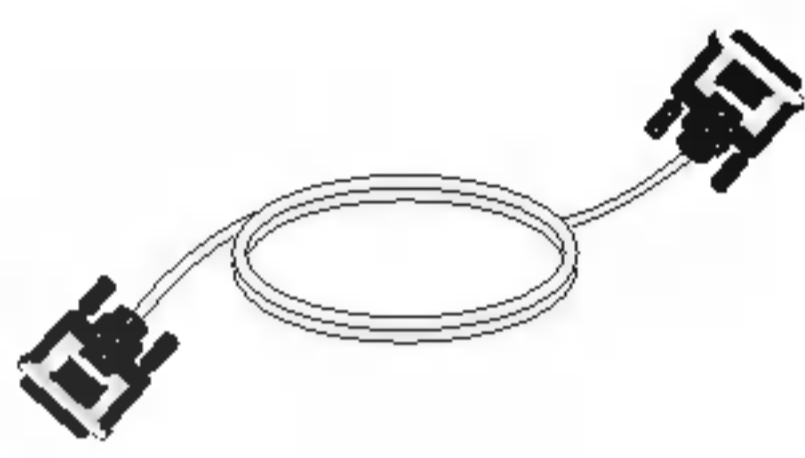

DVI-D cable (PC)



DVI to D-Sub cable (PC)

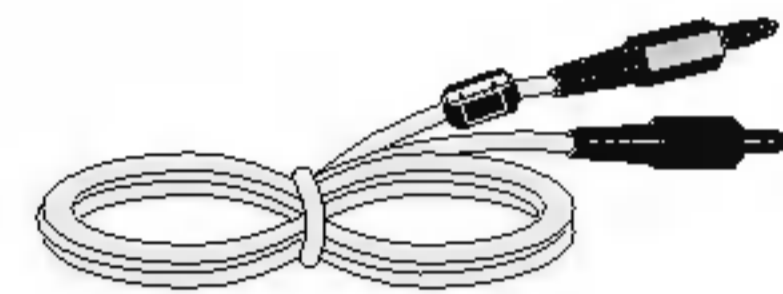

Audio cable (PC)

Tie Holder (option)  
- Arrange the wires with the tie Holder.

## Kensington Security System (RM-23LZ50 only)

- The TV is equipped with a Kensington Security System connector on the back panel. Connect the Kensington Security System cable as shown below.
- For the detailed installation and use of the Kensington Security System, refer to the user's guide provided with the Kensington Security System.  
For further information, contact <http://www.kensington.com>, the internet homepage of the Kensington company. Kensington sells security systems for expensive electronic equipment such as notebook PCs and LCD projectors.

### NOTES

- The Kensington Security System is an optional accessory.

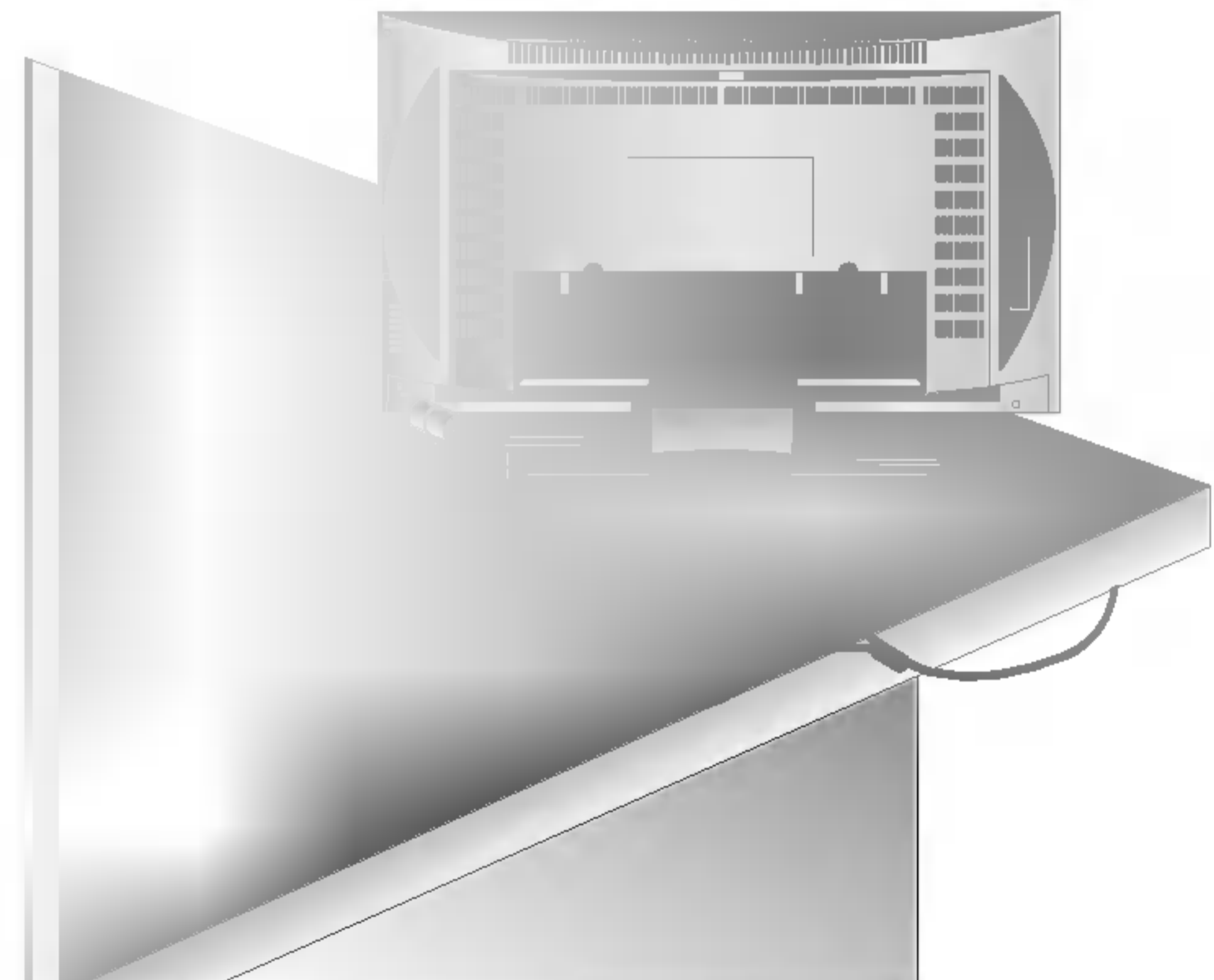

### NOTES

- a. If the TV feels cold to the touch, there may be a small "flicker" when when it is turned on.  
This is normal, there is nothing wrong with TV.
- b. Some minute dot defects may be visible on the screen, appearing as tiny red, green, or blue spots. However, they have no adverse effect on the monitor's performance.
- c. Avoid touching the LCD screen or holding your finger(s) against it for long periods of time.  
Doing so may produce some temporary distortion effects on the screen.

## Installation Instruction

\* The connection panel is hidden behind the A/V cover.

- a. Remove the cover.
- b. Install wires as necessary.
- c. Reinstall the cover. Align the holes on the TV back panel with the two tabs on the rear A/V cover as shown.
- d. Close cover.

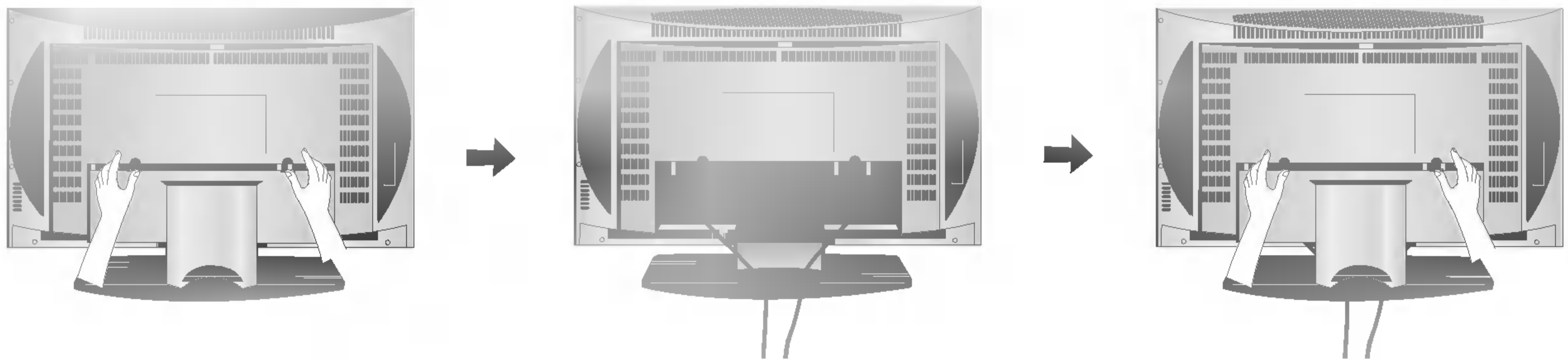

- Thread, then pull the wires through the hole on the TV stand.

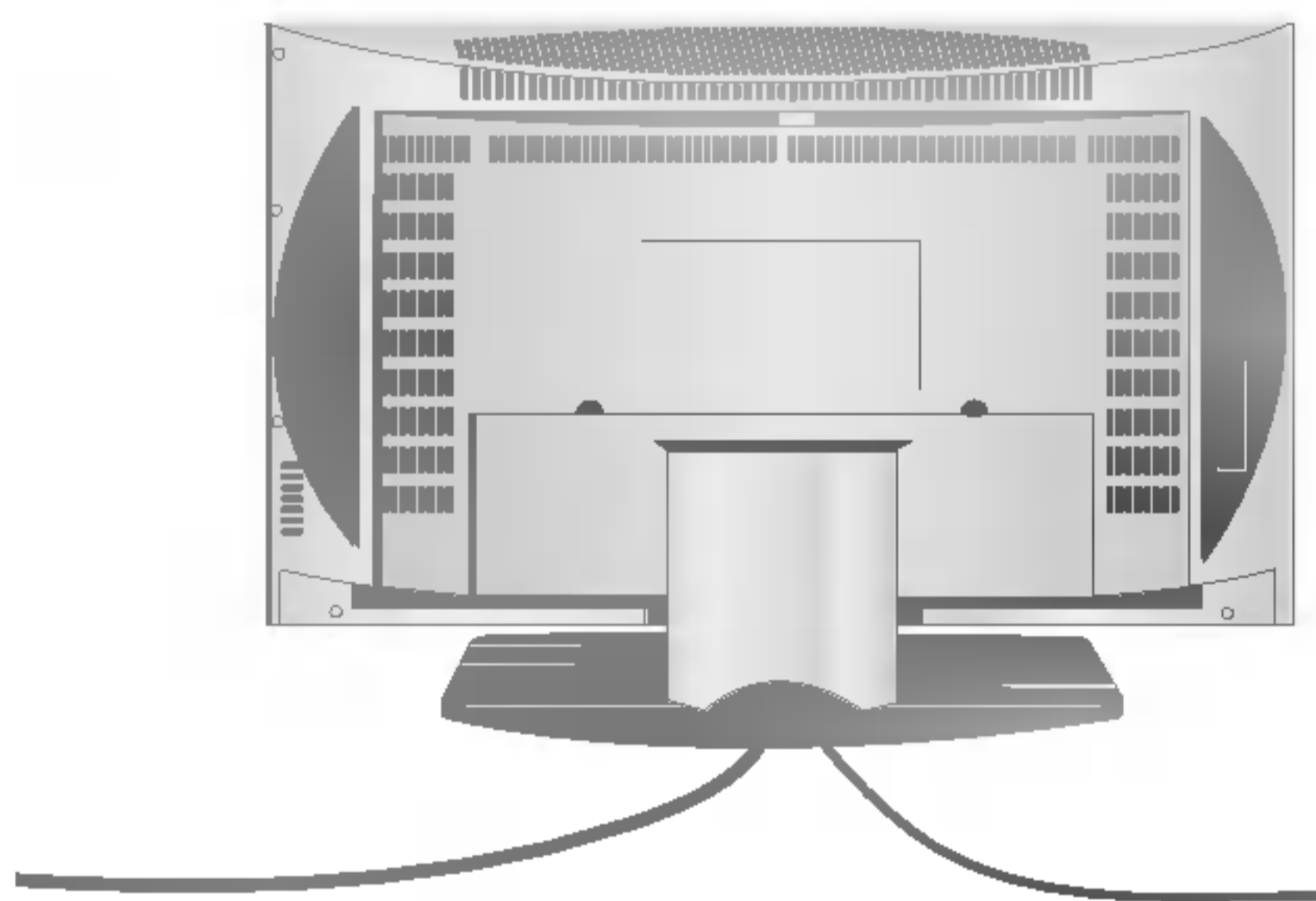

### Adjusting the TV Viewing Angle

- You can adjust the vertical angle of the TV.

RM-23LZ50 only





# External Equipment Connections

- For optimum picture quality, adjust antenna direction.

## Connecting to an Inside Antenna Setup

- Typical wall antenna jack used in apartment buildings, connect the antenna cable as shown below. (Use the correct type of antenna cable for the type of wall antenna jack.)

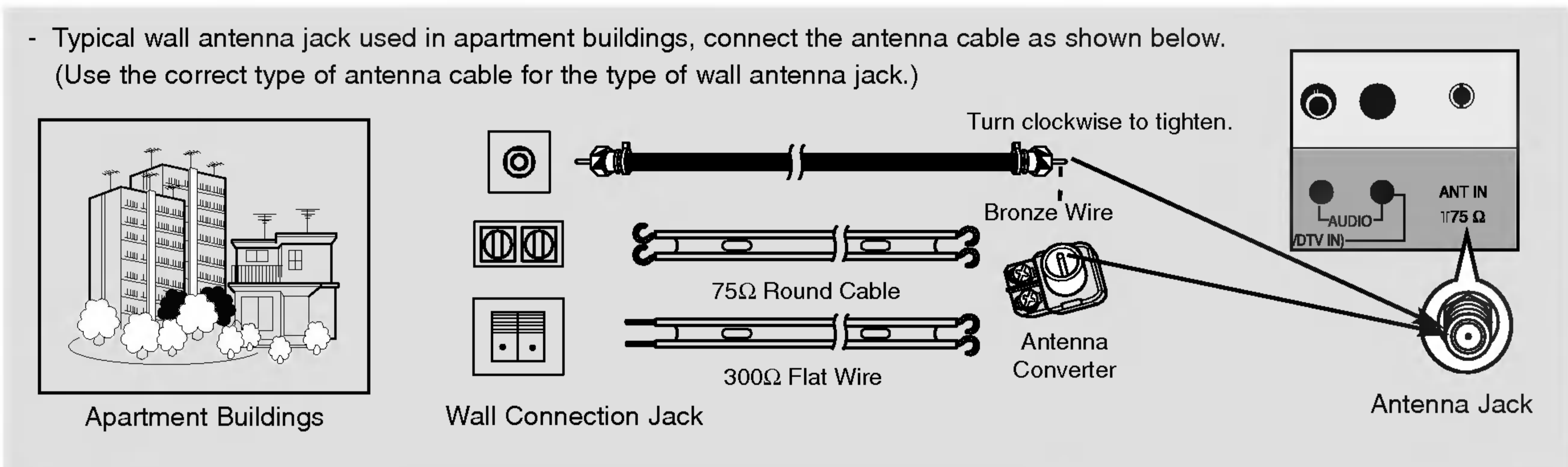

- If you have a 75Ω round cable, insert the bronze wire and then tighten the connection nut. If you have a 300Ω flat wire, connect the twisted wire to the antenna converter and then connect the converter to the antenna jack on the TV.  
 - If using 75Ω round cable, do not bend the bronze wire. It may cause poor picture quality.

## Connecting to an Outdoor Antenna Setup

- This type of antenna is commonly used in single family dwellings.

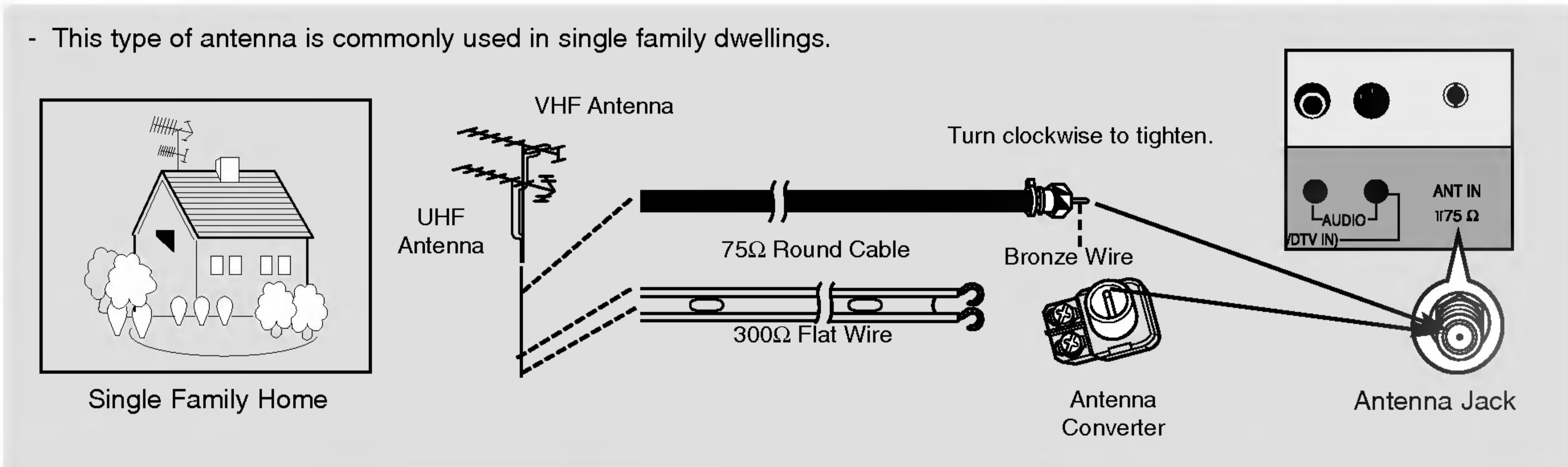

- In poor signal areas, to get better picture quality, install a signal amplifier to the antenna as shown to the right.  
 - If signal needs to be split for two TVs, use an antenna signal splitter for connection.

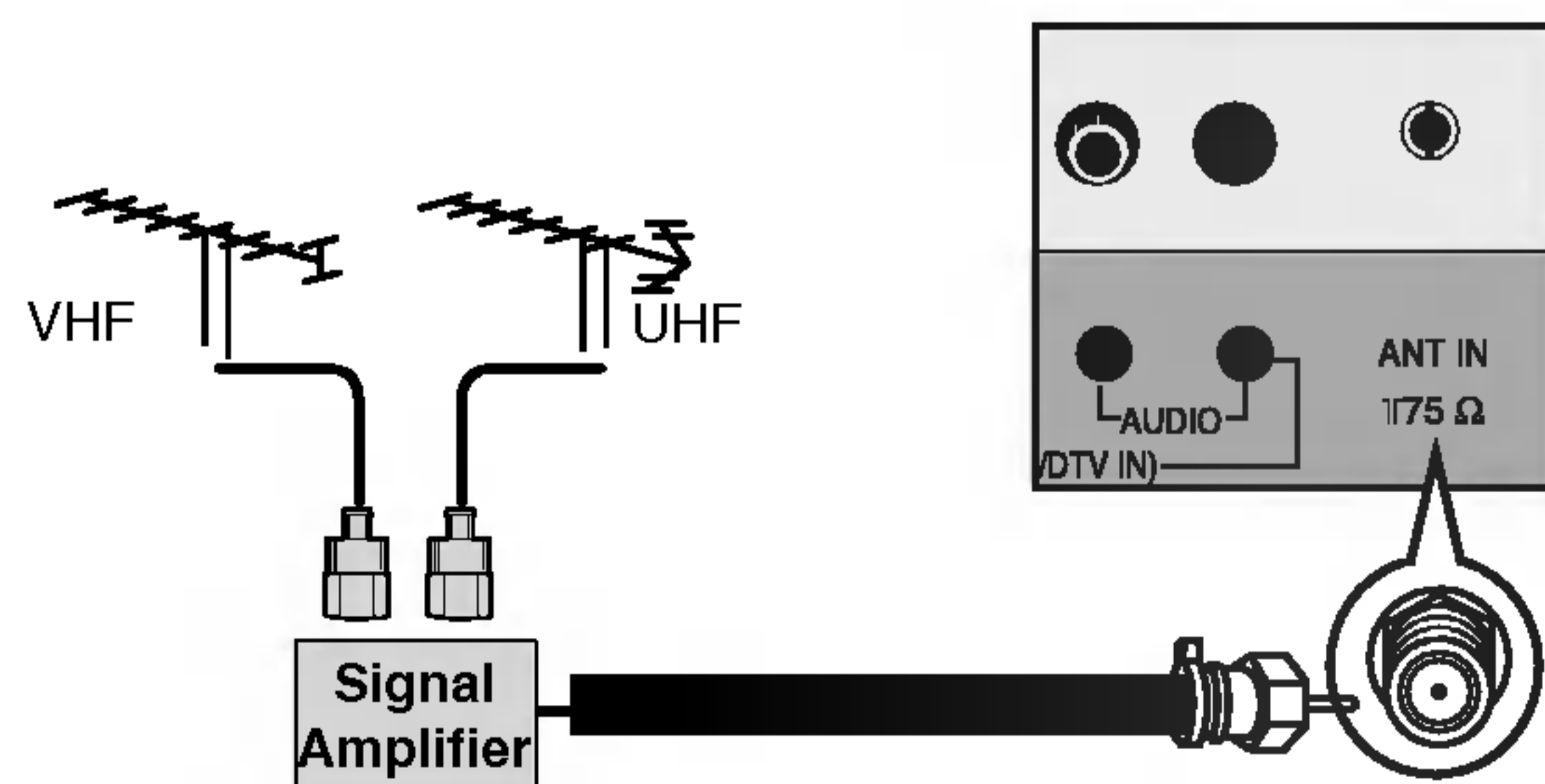

## External Equipment Connections Continued

- In Video mode, TV automatically reverts to TV mode if the **FCR** button or **REVIEW** buttons are pressed.

### Connection 1

Set VCR switch to 3 or 4 and then tune TV to the same channel number.

### Connection 2

1. Connect the audio/video output jacks on VCR to the corresponding input jacks on the TV. When connecting the TV to a VCR, match the jack colors (Video = yellow, Audio Left = white, and Audio Right = red).
2. Insert a video tape into the VCR and press PLAY on the VCR. (Refer to the VCR owner's manual.)
3. Use the **TV/VIDEO** button on the remote control to select **Video**. (If connected to S-VIDEO on side panel, select the **S-Video** external input source.)

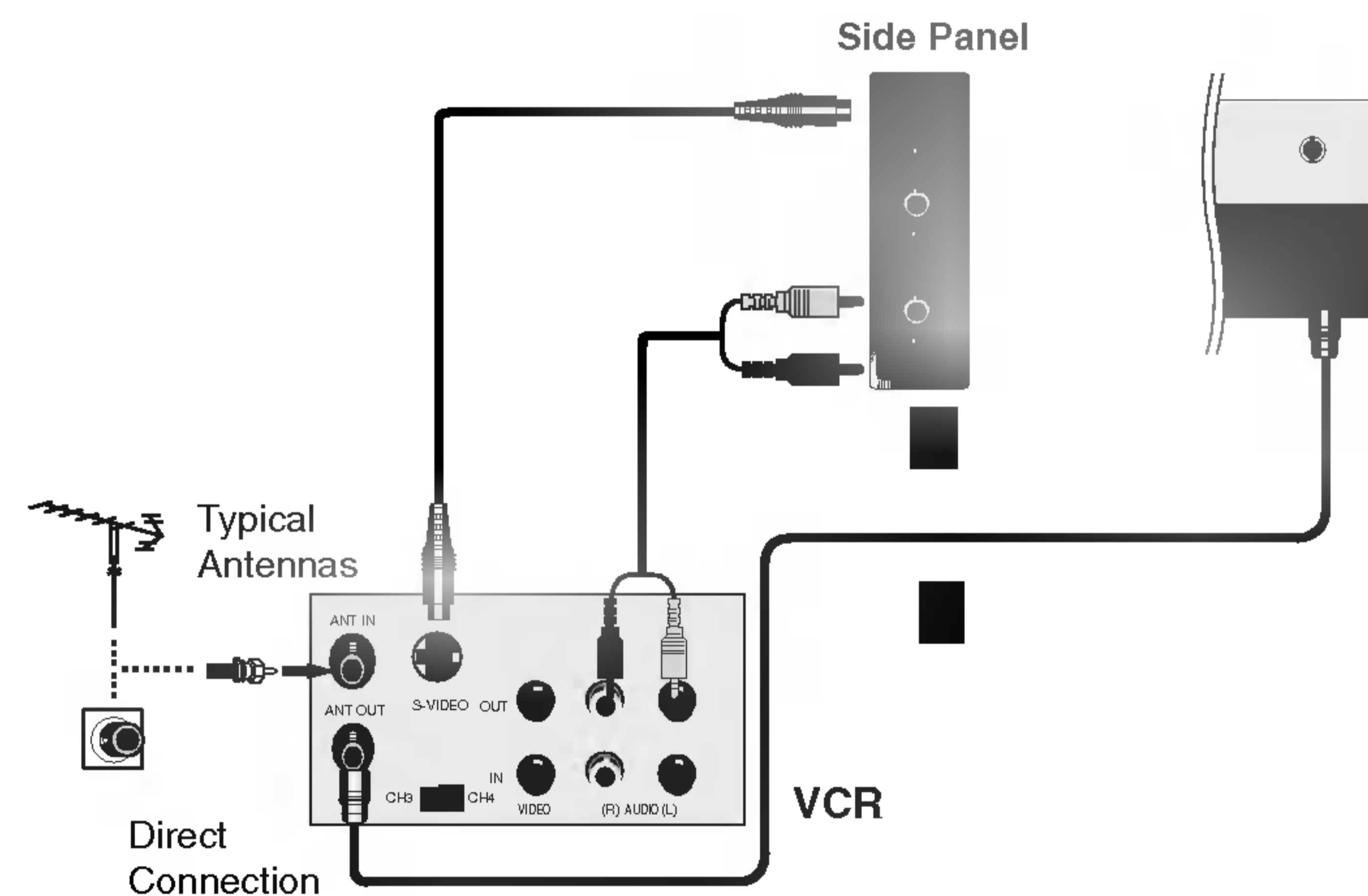
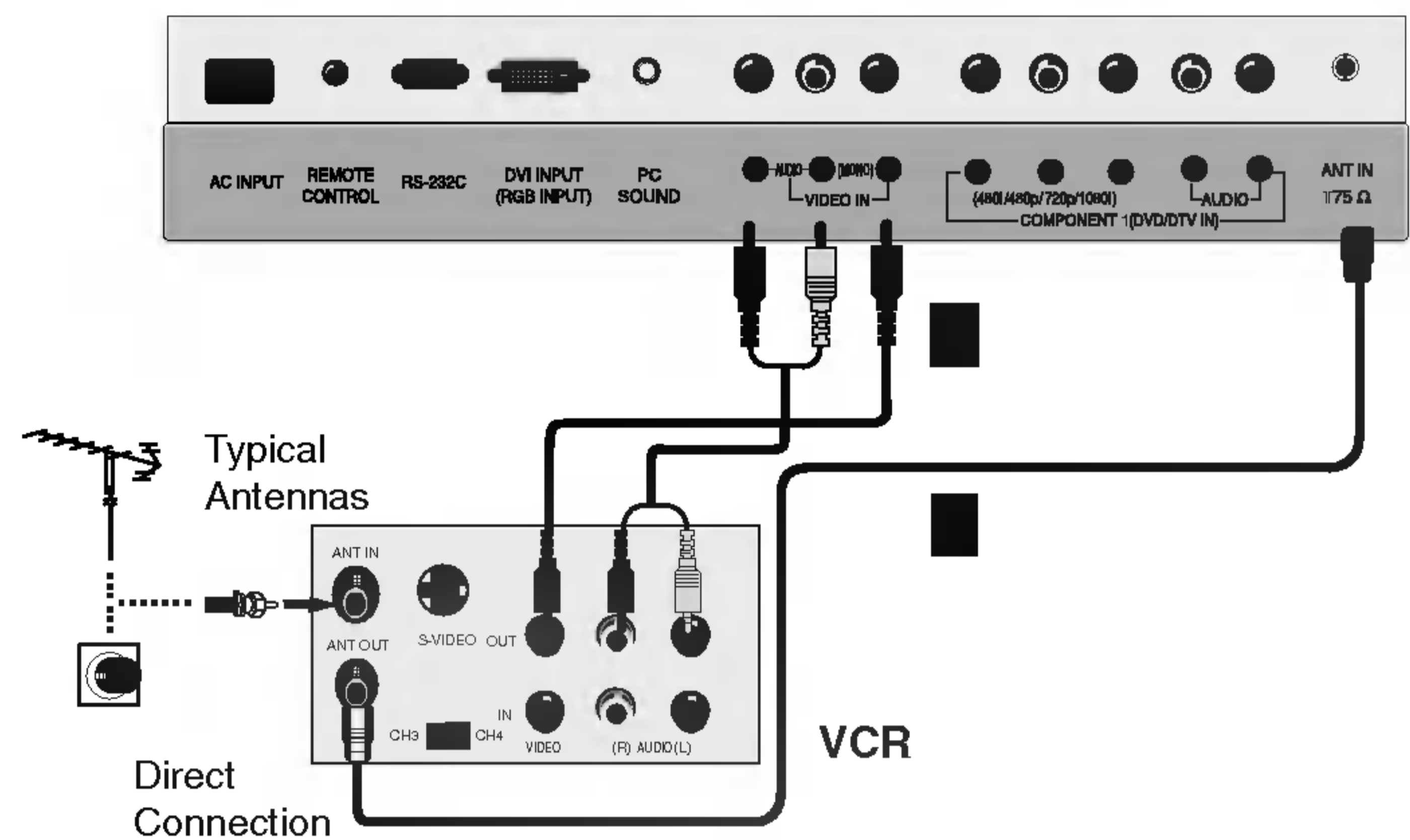

- After subscribing to a local cable TV service and installing a converter, you can watch cable TV programming.  
 - For further cable TV information, contact a local cable service provider.

### Connection 1

1. Select 3 or 4 with channel switch on cable box.
2. Tune the TV channel to the same selected output channel of cable box.
3. Select channels at the cable box or with the cable box remote control.

### Connection 2

1. Connect the audio/video output jacks on Cable Box to the corresponding input jacks on the TV. When connecting the TV to Cable Box, match the jack colors (Video = yellow, Audio Left = white, and Audio Right = red).
2. Use the **TV/VIDEO** button on the remote control to select **Video**.
3. Select channels with the cable box remote control.

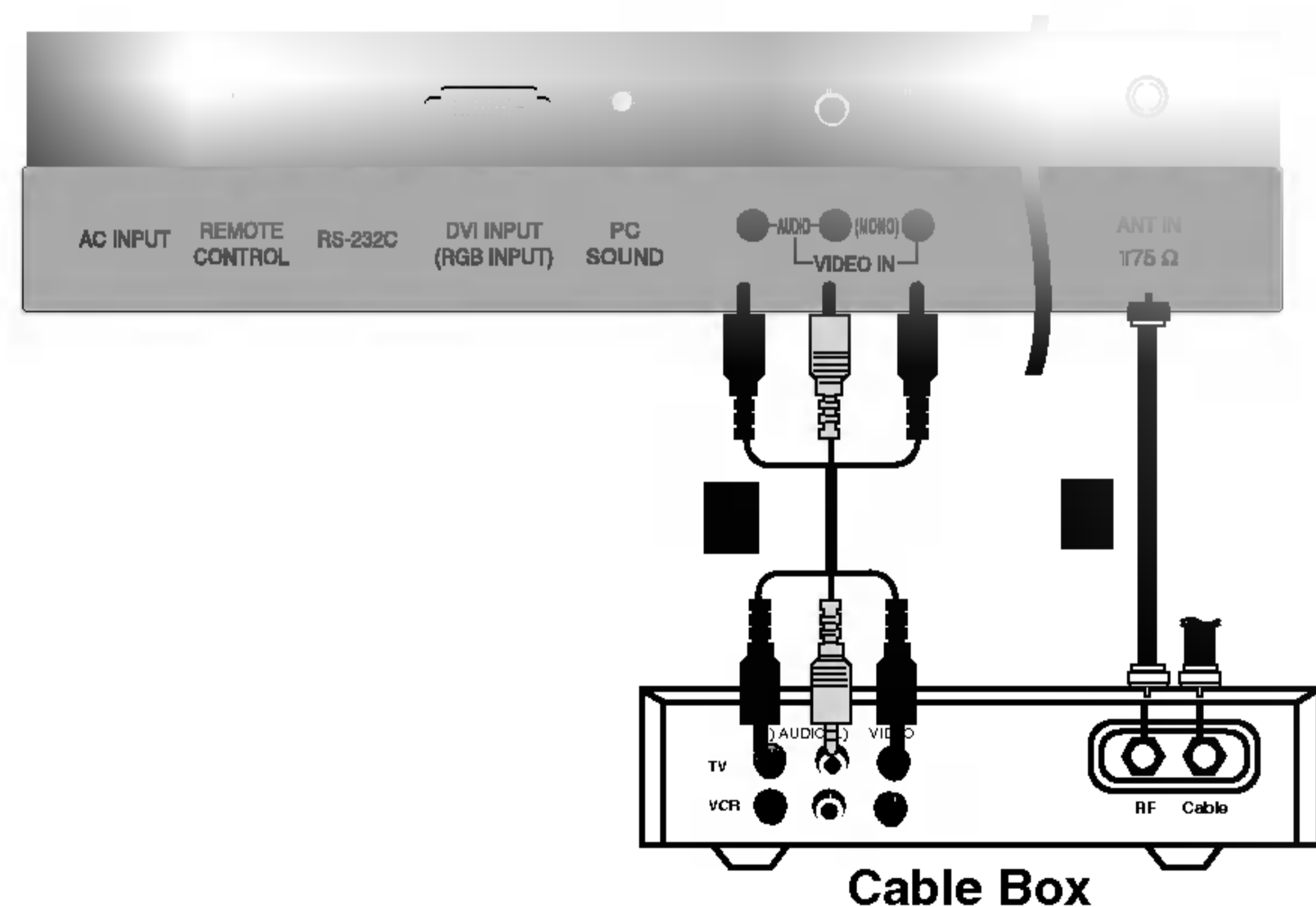



### Connections

Connect the audio/video output jacks on the external A/V equipment to the corresponding input jacks on the TV. When connecting the TV to external A/V equipment, match the jack colors (Video = yellow, Audio Left = white, and Audio Right = red).

### Viewing Setup

1. Turn on the external A/V equipment.
2. Use the **TV/VIDEO** button on the remote control to select **Video**.
3. Operate the corresponding external equipment. Refer to external equipment operating guide.

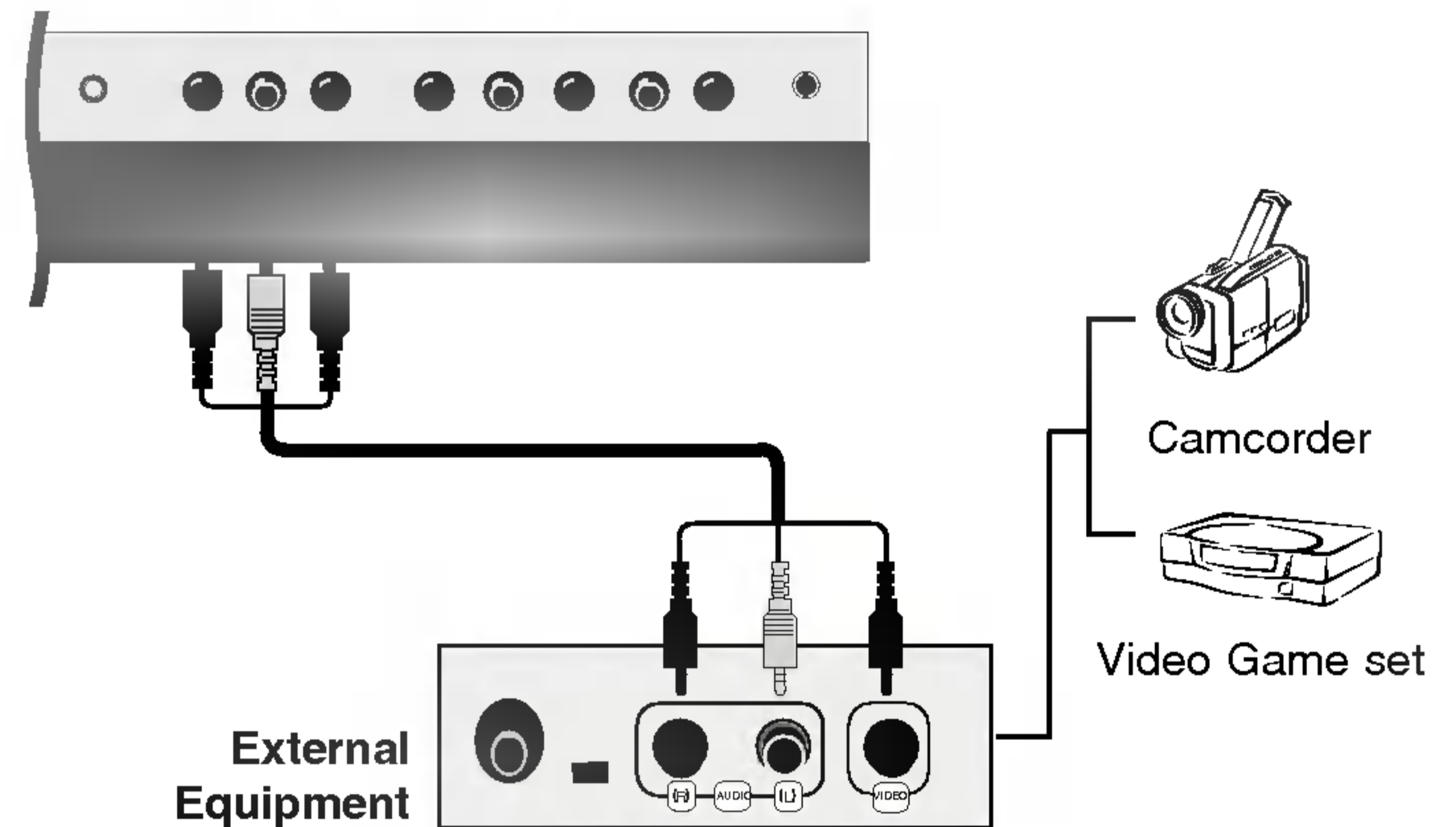

### Connections

1. Connect the DVD video outputs to the COMPONENT (Y, P<sub>B</sub>, P<sub>R</sub>) jacks and connect the DVD audio outputs to the AUDIO jacks.
2. If your DVD only has an S-Video output jack, connect this to the S-VIDEO input on the TV and connect the DVD audio outputs to the AUDIO INPUT jacks on the TV, as shown in the figure.

**NOTE:** If your DVD player does not have component video output, use S-Video.

### Viewing Setup

1. Turn on the DVD player, insert a DVD.
2. Use the **TV/VIDEO** or **MULTIMEDIA** button on the remote control to select **Component 1** or **Component 2** (If connected to S-VIDEO, select the **S-Video** input source.)
3. Refer to the DVD player's manual for operating instructions.

#### • Component Input ports

To get better picture quality, connect a DVD player to the component input ports as shown below.

Component ports of the TV	Y	
Video output ports of DVD player	Y	P <sub>b</sub>
	Y	B-Y
	Y	C <sub>b</sub>
	Y	P <sub>B</sub>

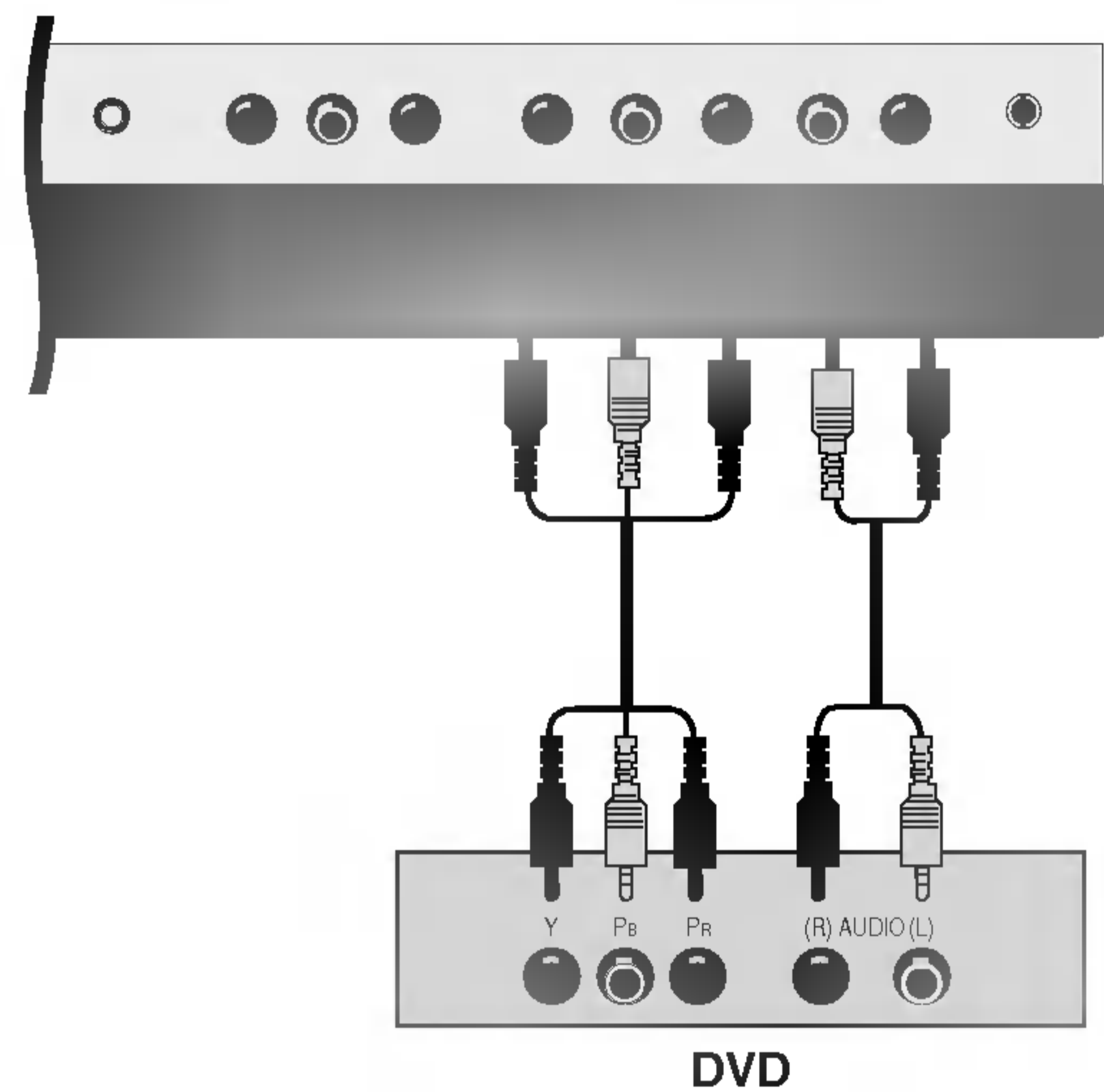

Side Panel

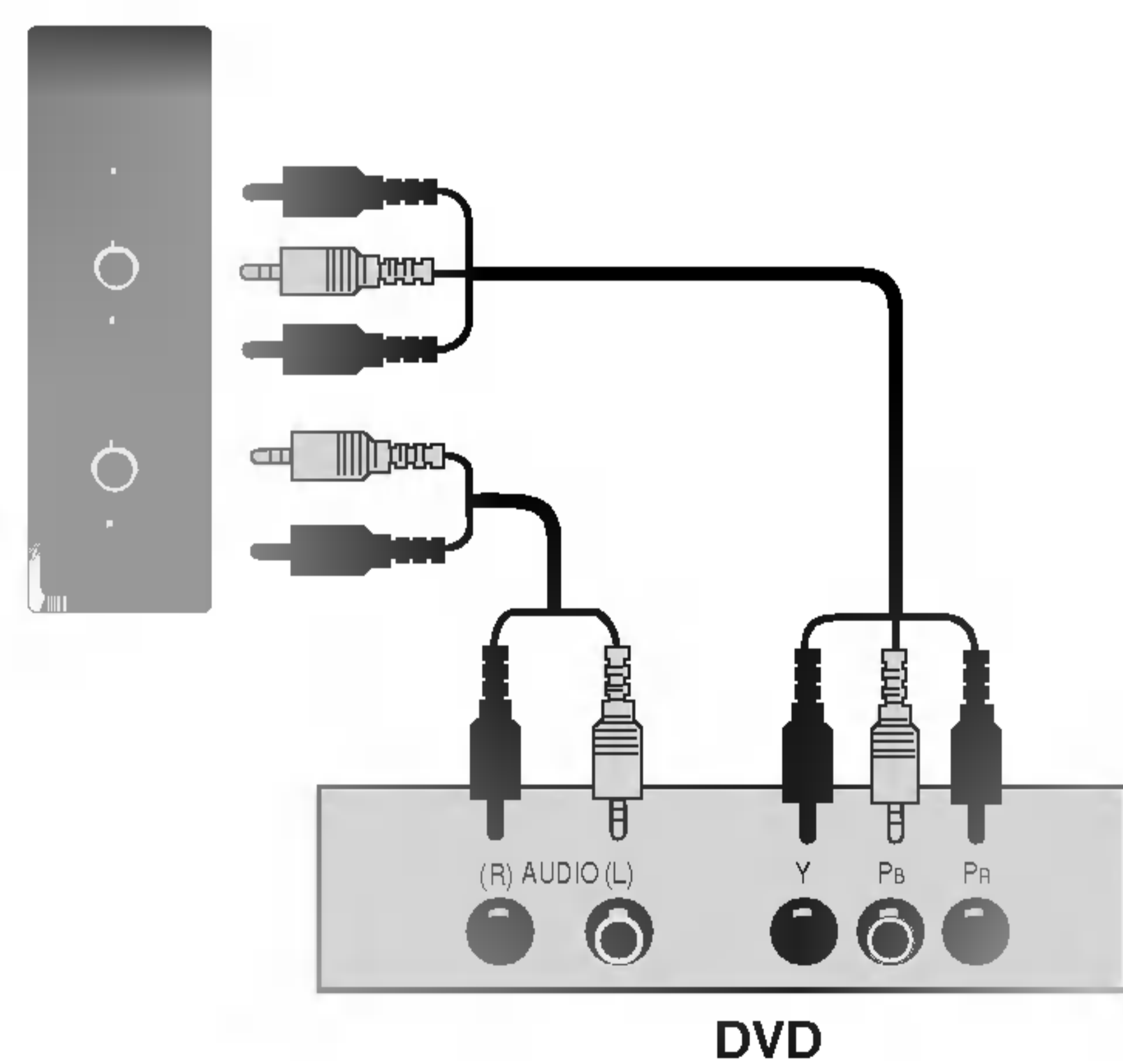

## External Equipment Connections

- To watch digitally broadcast programs, purchase and connect a digital set-top box.

### Connections

Connect the digital set-top box video outputs to the COMPONENT (Y, P<sub>B</sub>, P<sub>R</sub>) jacks and connect the digital set-top box audio outputs to the AUDIO jacks.

### Viewing Setup

1. Turn on the digital set-top box. (Refer to the owner's manual for the digital set-top box.)
2. Use the **TV/VIDEO** or **MULTIMEDIA** button on the remote control to select **Component 1**.

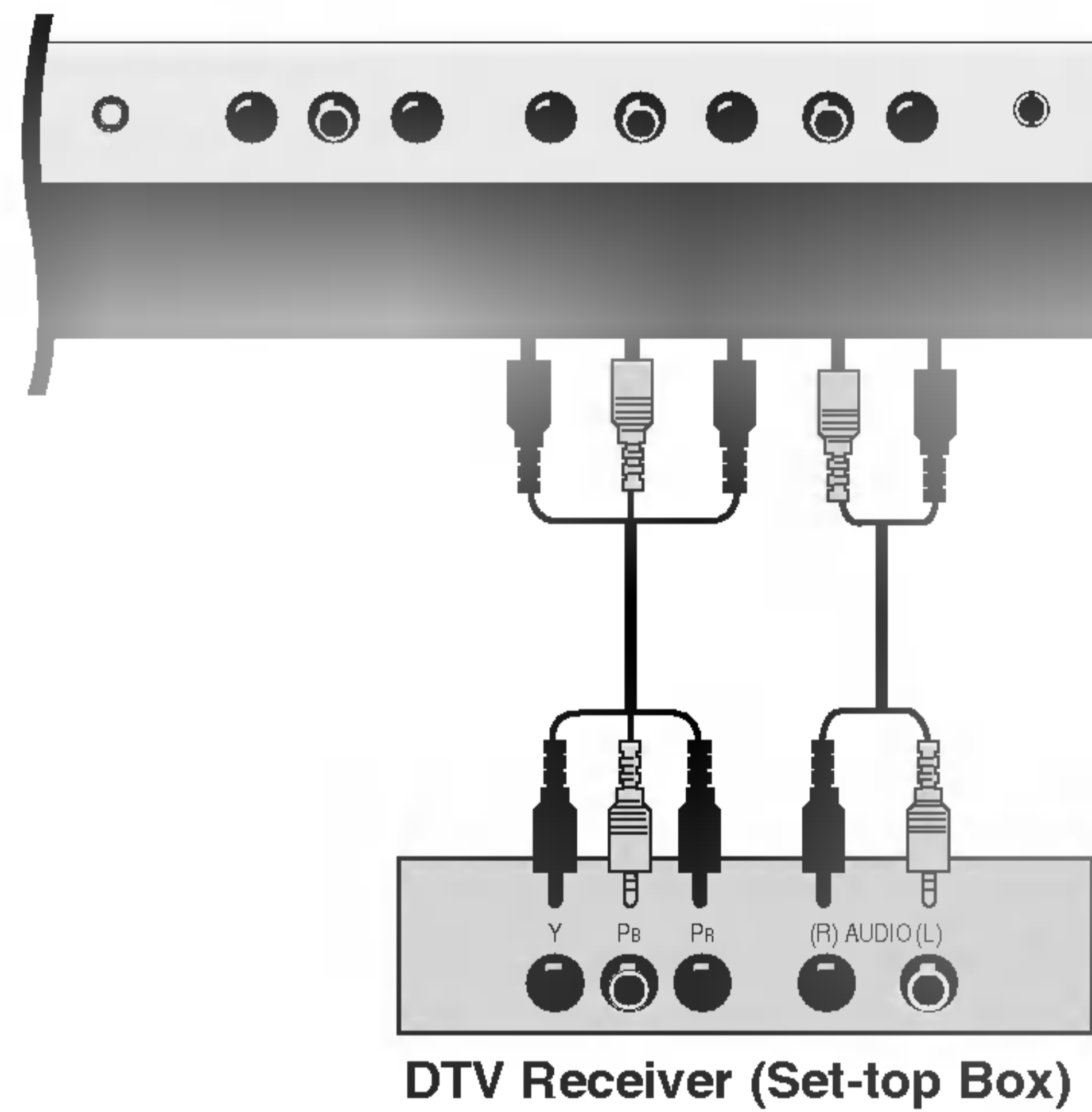

- After setup, be sure to select RGB-PC source on TV.

### Connections

1. Set the monitor output resolution on the PC before connecting to the TV.
2. Connect the TV to the PC with the PC cable.
3. Connect the PC audio output to the TV's PC SOUND input.

### Viewing Setup

1. Turn on the PC.
2. Use the **TV/VIDEO** or **MULTIMEDIA** button on the remote control to select **PC**.

### Monitor Display Specifications

Resolution	Horizontal Frequency(kHz)	Vertical Frequency(Hz)
640x480	31.47	60
	35.00	66.67
	37.50	75
800x600	35.16	56.25
	37.88	60
	48.08	72.19
1024x768	46.88	75
	48.36	60
	56.48	70
1280x768	60.02	75
	47.78	60
* 1280x720	44.70	60

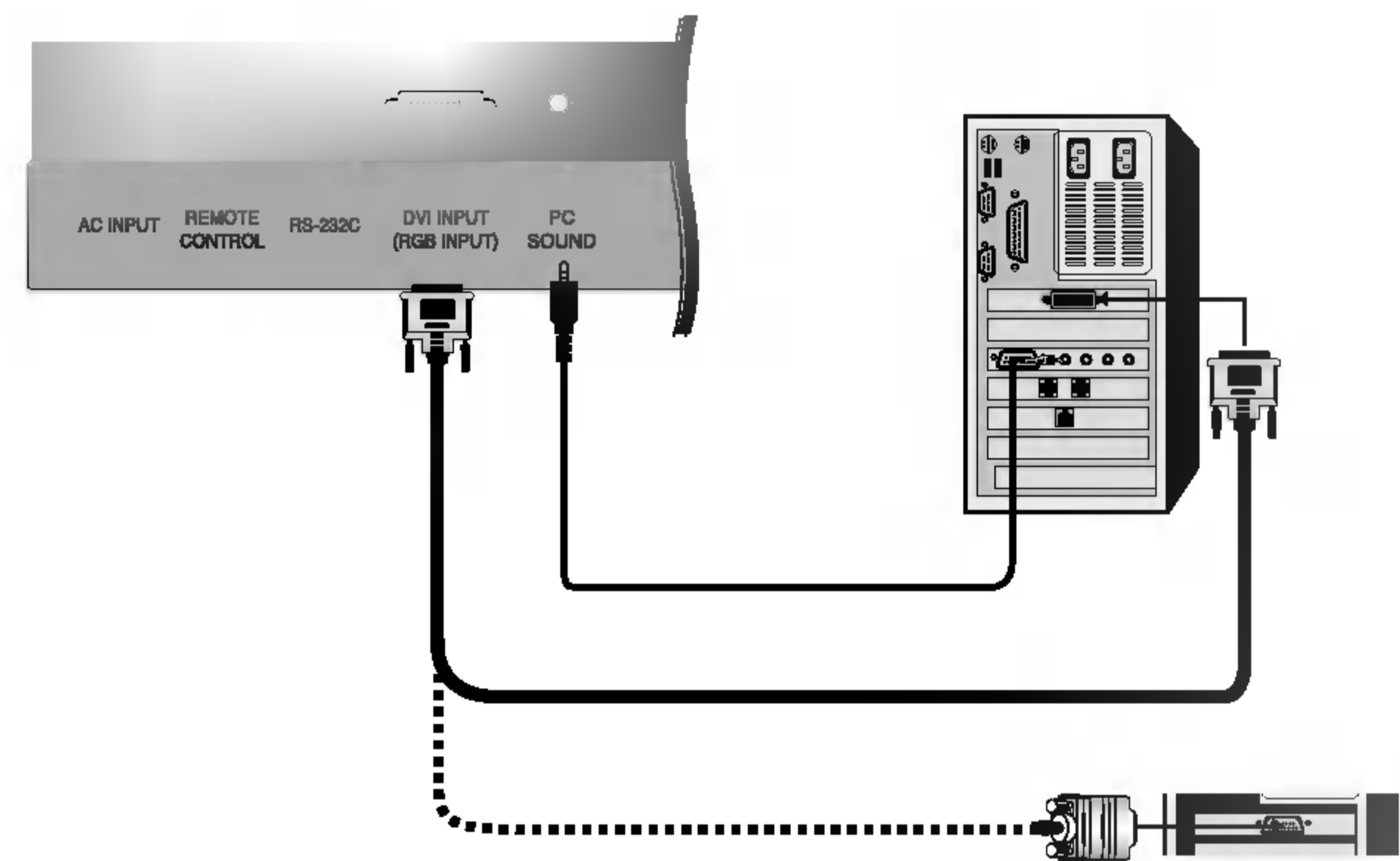

### NOTE

Connect the signal cable (DVI-D cable, Not DVI to D-Sub cable) from the DVI output socket of the PC to the DVI input socket of the set when using a PC with DVI output. In some video cards, DVI-Analogue output may not be supported.

\* RM-27LZ50 only

### NOTES

- a. For optimum picture quality, use standard WXGA (1280x768) computer output at a 60Hz refresh rate (for 27 inch LCD monitor only, VESA 1280x720@60Hz; In some video cards, this mode may not be supported.) . Using other formats (VGA, SVGA, etc.) or refresh rates may result in reduced picture quality. (To change the computer video output format, please refer to the operating manual for the computer you are using).
- b. If the message "**Out of range**" appears on the screen, adjust the PC output to a format listed in the 'Monitor Display Specifications' chart above.
- c. The synchronization input form for Horizontal and Vertical frequencies is separate.

### DPM (Display Power Management) mode

If the PC goes to power saving mode, the monitor automatically switches to DPM mode.  
If you don't use the PC cable provided, DPM mode may not work.

# Operation

## TV Operation Overview

1. First, make all equipment connections. Plug the AC Adapter into the TV, then plug the AC Adapter into a power outlet. At this time, the TV is switched to standby mode.
  - In standby mode, press the **POWER**, **CH** (▲,▼), **TV/VIDEO**, **MULTIMEDIA** or **number** button on the remote control or **ON/OFF**, **CH** (▲,▼), **TV/VIDEO** located on the TV to turn the TV on.
2. Select the viewing source by pressing **TV/VIDEO** or **MULTIMEDIA** repeatedly.
  - Note: See page 16 if you have not auto programmed the TV to receive channels in your local broadcast area.
3. After viewing, press the **POWER** button on the remote control or **ON/OFF** located on the TV. The TV reverts to standby mode.

### NOTE

- If you want to turn the TV off, press the on/off button located on the TV. If you intend to be away on vacation, disconnect the power plug from the wall power outlet.

## Menu Language Selection

- The menus can be shown on the screen in the selected language. First select your language.

1. Press the **MENU** button and then use ▲ / ▼ button to select the **Special** menu.
2. Press the ► button and then use ▲ / ▼ button to select **Language**.
3. Press the ► button and then use ▲ / ▼ button to select your desired language.  
From this point on, the on-screen menus will be shown in the language of your choice.
4. Press the **ENTER** button to save.



## Channel Menu Options

### Memorizing the Channels with Auto Program

- For Auto program to work, the programming source must be connected to the TV and the TV must be receiving programming signals either over-the-air or from a cable-type service provider.

1. Press the **MENU** button and then use **▲ / ▼** button to select the **Channel** menu.
2. Press the **▶** button and then use **▲ / ▼** button to select **Auto Program**.
3. Press the **▶** button to begin the channel search.
  - Wait for auto program to complete the channel search cycle before choosing a channel. The TV scans for over-the-air channels and then channels provided by a cable service.



### NOTES

- When the channel search is complete, use the **▲ / ▼** buttons to review the memorized channels.
- If you press the **ENTER** button in auto programming, the function will stop and only channels programming up to that time will remain.
- Auto program function can memorize only the channels which are being received at that time.

### Add/Delete Channels with Manual Program

- You can manually include or erase individual channels.

1. Press the **MENU** button and then use **▲ / ▼** button to select the **Channel** menu.
2. Press the **▶** button and then use **▲ / ▼** button to select **Manual prog**.
3. Press the **▶** button and then use **◀ / ▶** button to select a channel you want to add to memory or erase.
4. Press the **▼** button and then use **◀ / ▶** button to select **Memory** (add) or **Erase** (delete).
5. Press the **EXIT** button to save and return to TV viewing. The current channel is added to Memory or Erased from the channel list.

The current channel number is displayed.



- Favorite Channel lets you quickly tune in up to 5 channels of your choice without having to wait for the TV to scan through all the in-between channels.

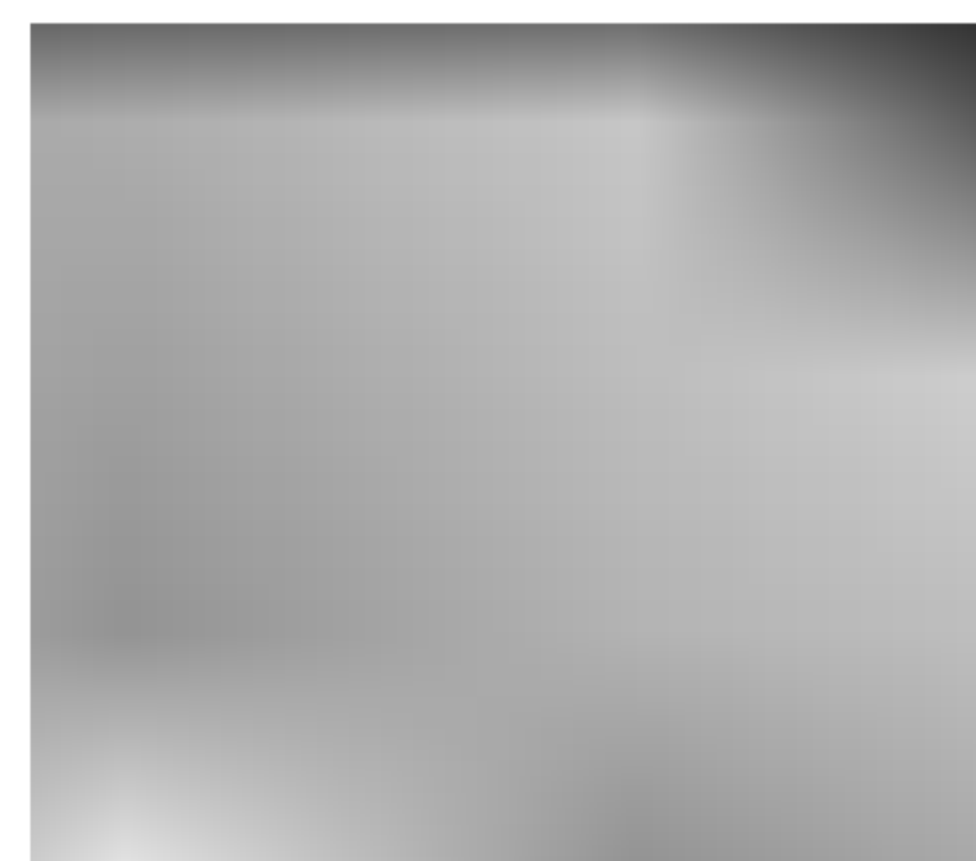
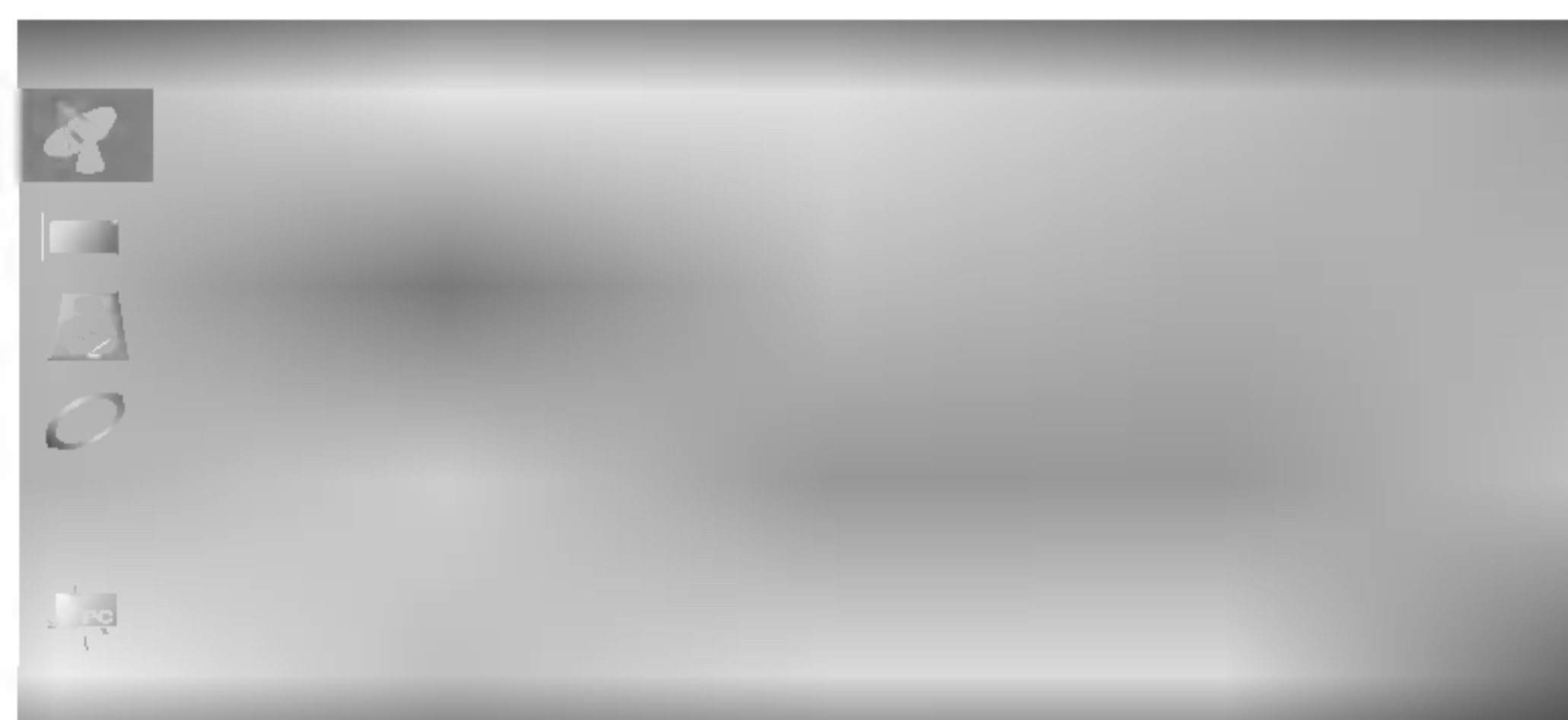

1. Press the **MENU** button and then use **▲ / ▼** button to select the **Channel** menu.
2. Press the **▶** button and then use **▲ / ▼** button to select **Favorite ch.**
3. Press the **▶** button and then use **▲ / ▼** button to select the first favorite channel position.
4. Use the **◀ / ▶** button to set the desired channel number for first favorite channel.
5. Repeat steps 3 to 4 to memorize other channels.
6. Press the **ENTER** button to save.
  - To return to a favorite channel, press the **FCR** (Favorite Channel Review) button repeatedly. The 5 favorite channels appear on the screen one-by-one.

## Picture Menu Options

- This function adjusts the TV for the best picture appearance.

1. Press the **APC** button repeatedly to select the picture appearance setup option as shown below.

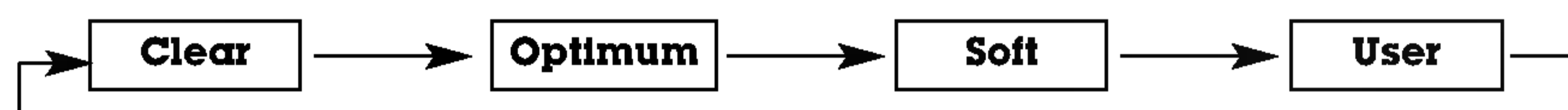

- You can also adjust **APC** in the **Picture** menu.
- **Clear, Optimum** and **Soft** are preset for good picture quality at the factory and cannot be changed.

- You can adjust picture contrast, brightness, color, sharpness and tint to the levels you prefer.

1. Press the **MENU** button and then use **▲ / ▼** button to select the **Picture** menu.
2. Press the **▶** button and then use **▲ / ▼** button to select **User**.
3. Press the **▶** button and then use **▲ / ▼** button to select the desired picture option (**Contrast, Brightness, Color, Sharpness, Tint**).
4. Use the **◀ / ▶** button to make appropriate adjustments.

- Contrast, Brightness, Color, and Sharpness are adjustable from 0 to 100.
- Tint is adjustable from - 50 to + 50.

5. Press the **ENTER** button to save.



- You can watch TV in various picture formats; **16:9, Zoom, 4:3**.  
Repeatedly press the **ARC** button to select your desired picture format.

### • 16:9

You can enjoy the cinema (the picture format of 16:9) or general TV programme through the 16:9 mode. The screen 16:9 is viewed just like that but the screen 4:3 is magnified to the left and right so that the screen 16:9 is full.

### • Zoom

You can enjoy the cinema in a vast screen through the Zoom mode.

The screen 4:3 is magnified to the upper / lower and left / right sides so that the screen 16:9 is full. The bottom and top of the picture may be lost.

### • 4:3

This picture format is 4 to 3 of general TV.

### NOTES

**16:9** and **4:3** are available in PC mode only.

# Sound Menu Options

## DASP (Digital Audio Sound Processing)

- This function lets you enjoy the best sound without any special adjustment because the TV selects the appropriate sound option based on the program content.

1. Use the **DASP** button to select the appropriate sound setup as shown below.



- You can also adjust **DASP** in the **Sound** menu.

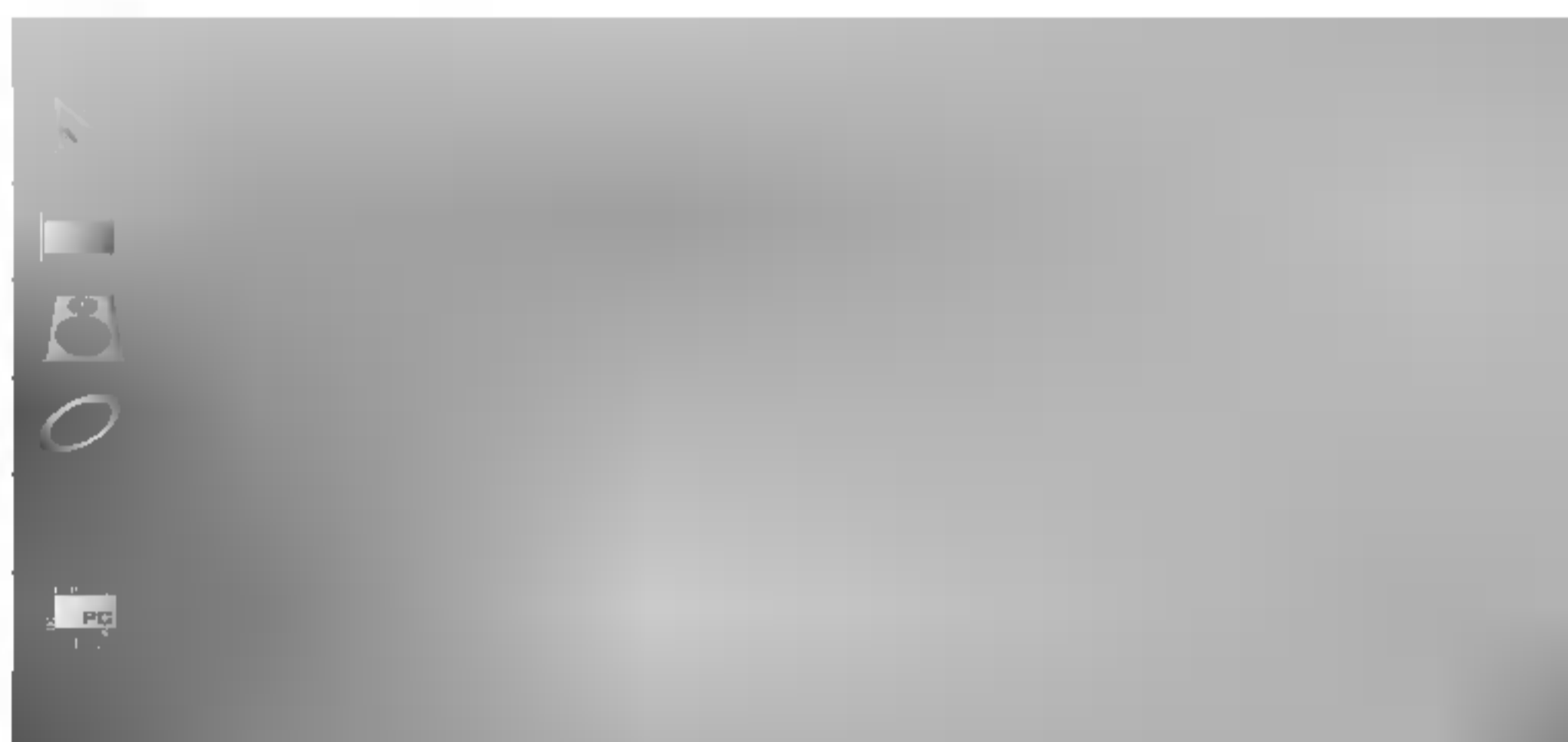

1. Press the **MENU** button and then use **▲ / ▼** button to select the **Sound** menu.
2. Press the **▶** button and then use **▲ / ▼** button to select **DASP**.
3. Press the **▶** button and then use **▲ / ▼** button to select **User**.
4. Press the **▶** button and then use **◀ / ▶** button to select the band you want to adjust. Then, use **▲ / ▼** button to adjust the band level.
5. Press the **EXIT** button to save and return to TV viewing.

- AVL maintains an equal volume level automatically even if the channel is changed.

1. Press the **MENU** button and then use **▲ / ▼** button to select the **Sound** menu.
2. Press the **▶** button and then use **▲ / ▼** button to select **AVL**.
3. Press the **▶** button and then use **▲ / ▼** button to to select **On** or **Off**.
4. Press the **EXIT** button to save and return to TV viewing.

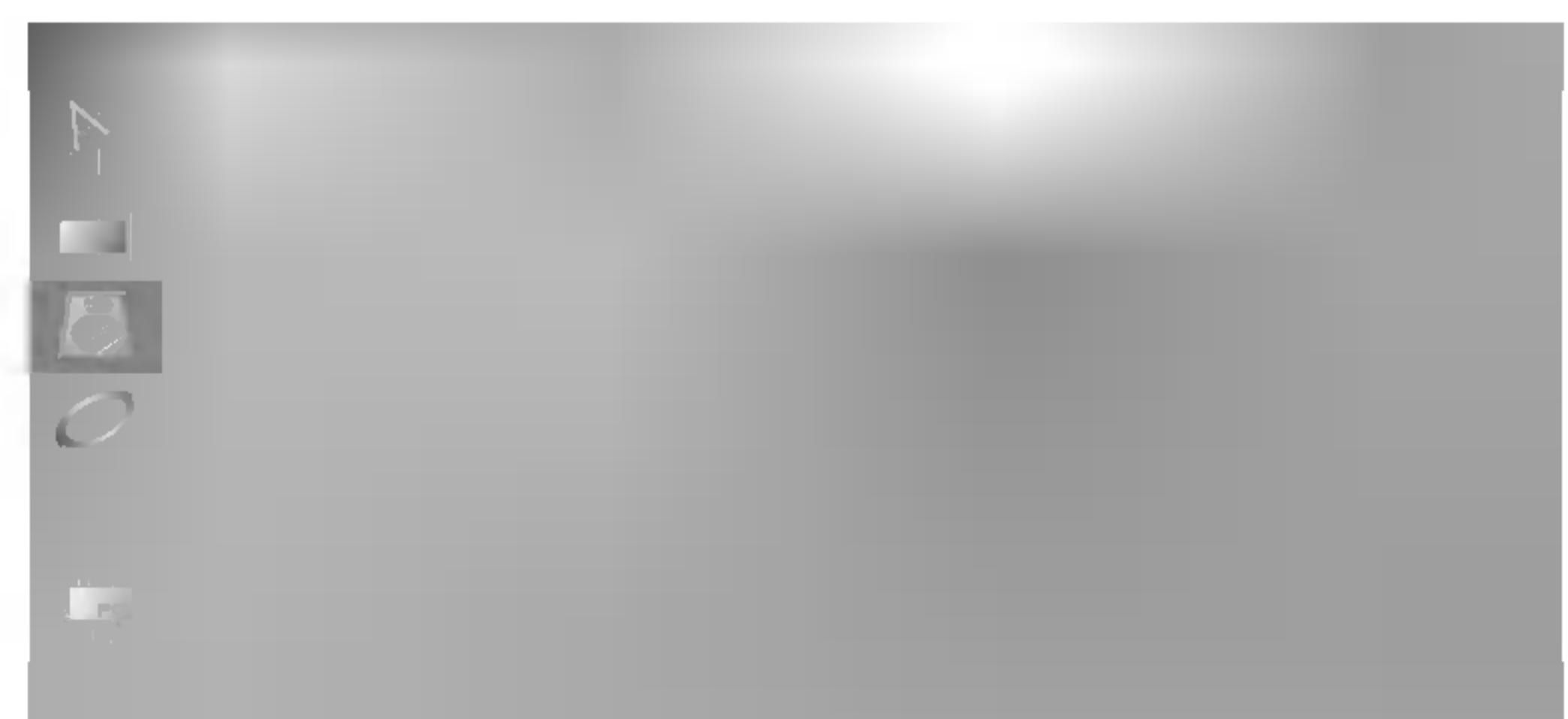

## Sound Menu Options Continued

1. Press the **MENU** button and then use **▲ / ▼** button to select the **Sound** menu.
2. Press the **▶** button and then use **▲ / ▼** button to select **Balance**.
3. Press the **▶** button and then use **◀ / ▶** button to adjust the sound balance.
  - Balance is adjustable from Left 50 to Right 50.
4. Press the **EXIT** button to save and return to TV viewing.



### Stereo/SAP Broadcasts Setup

- The TV can receive MTS stereo programs and any SAP (Secondary Audio Program) that accompanies the stereo program, if the broadcaster transmits an additional sound signal as well as the original one.
- Mono: The primary language is heard from left and right speakers. Signal mode is mono.
- Stereo: The primary language is heard from left and right speakers. Signal mode is stereo.
- SAP: The secondary language is heard from left and right speakers.

1. Press the **MTS** button repeatedly.



- Select mono sound mode if the signal is not clear or in poor signal reception areas.
- **Stereo, SAP** mode are available only if included on the broadcast signal.



## Timer Menu Options

- If the time on the clock is incorrect, reset the clock manually.

1. Press the **MENU** button and then use **▲ / ▼** button to select the **Timer** menu.
2. Press the **▶** button and then use **▲ / ▼** button to select **Clock**.
3. Press the **▶** button and then use **▲ / ▼** button to set the hour.
4. Press the **▶** button and then use **▲ / ▼** button to set the minutes.
5. Press the **EXIT** button to save and return to TV viewing.



- Timer function operates only if current time is set.
- Off-Timer function overrides On-Timer function if they are set to the same time.
- The TV must be in standby mode for the On-Timer to work.
- If you don't press any button within 2 hours after turning on the TV with the On-Timer function, the TV will automatically revert to standby mode.

1. Press the **MENU** button and then use **▲ / ▼** button to select the **Timer** menu.
2. Press the **▶** button and then use **▲ / ▼** button to select **Off timer** or **On timer**.
3. Press the **▶** button and then use **▲ / ▼** button to set the hour.
4. Press the **▶** button and then use **▲ / ▼** button to set the minutes.
5. **For On timer function only:**  
Press the **▶** button and then use **▲ / ▼** button to set the channel at turn-on.  
Then, press the **▶** button and then use **▲ / ▼** button to set the turn-on sound level.
6. Press the **▶** button and then use **▲ / ▼** button to select **Run** or **Hold**.
  - **Hold:** **Off timer/On timer** will not work.
  - **Run:** **Off timer/On timer** are active.
7. Press the **EXIT** button to save and return to TV viewing.



## Timer Menu Options Continued

- The Sleep Timer turns the TV off at a preset time.

1. Press the **SLEEP** button repeatedly to select the number of minutes. First the **Sleep ---** option appears on the screen, followed by the following sleep timer options: 10, 20, 30, 60, 90, 120, 180, and 240 minutes.
2. When the number of minutes you want is displayed on the screen, press the **ENTER** button. The timer begins to count down from the number of minutes selected.
3. To check the remaining minutes before the TV turns off, press the **SLEEP** button once.
4. To cancel the Sleep Timer, press the **SLEEP** button repeatedly until **Sleep ---** appears.

- If Auto Off is active and there is no input signal, the TV switches to Standby mode automatically after 10 minutes.

1. Press the **MENU** button and then use **▲ / ▼** button to select the **Timer** menu.
2. Press the **▶** button and then use **▲ / ▼** button to select **Auto off**.
3. Press the **▶** button and then use **▲ / ▼** button to select **On** or **Off**.
4. Press the **EXIT** button to save and return to TV viewing.

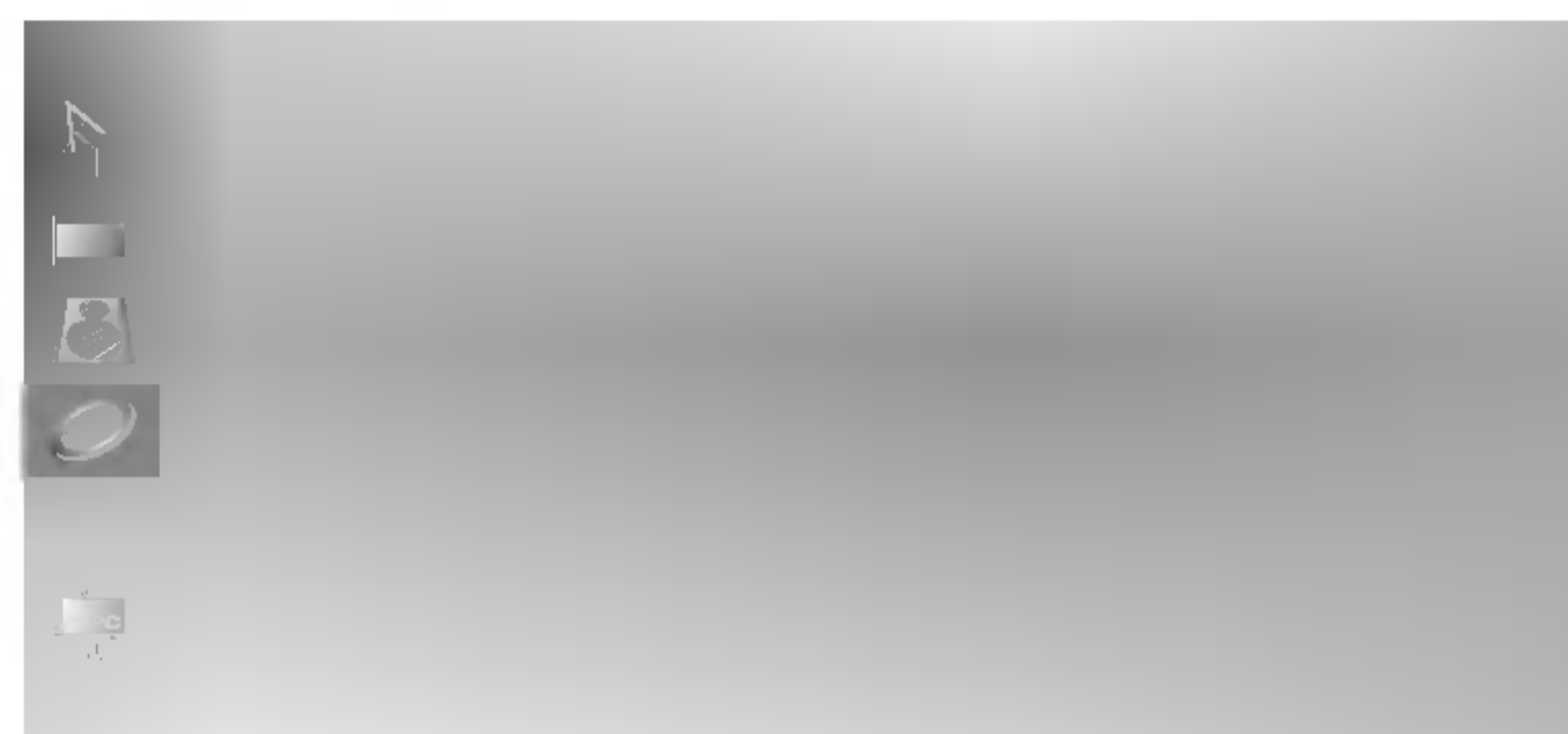



# Special Menu Options

## Closed Captions

Closed captioning is a process which converts the audio portion of a television program into written words which then appear as subtitles on the television screen. Closed captions allow viewers to read the dialogue and narration of television programs.

### Using Closed Captions

Captions are the subtitles of the dialogue and narration of television programs. For prerecorded programs, program dialogue can be arranged into captions in advance. Its possible to caption a live program by using a process called real-time captioning, which creates captions instantly. Real-time captioning is normally done by professional reporters using a machine shorthand system and computer for translation into English.

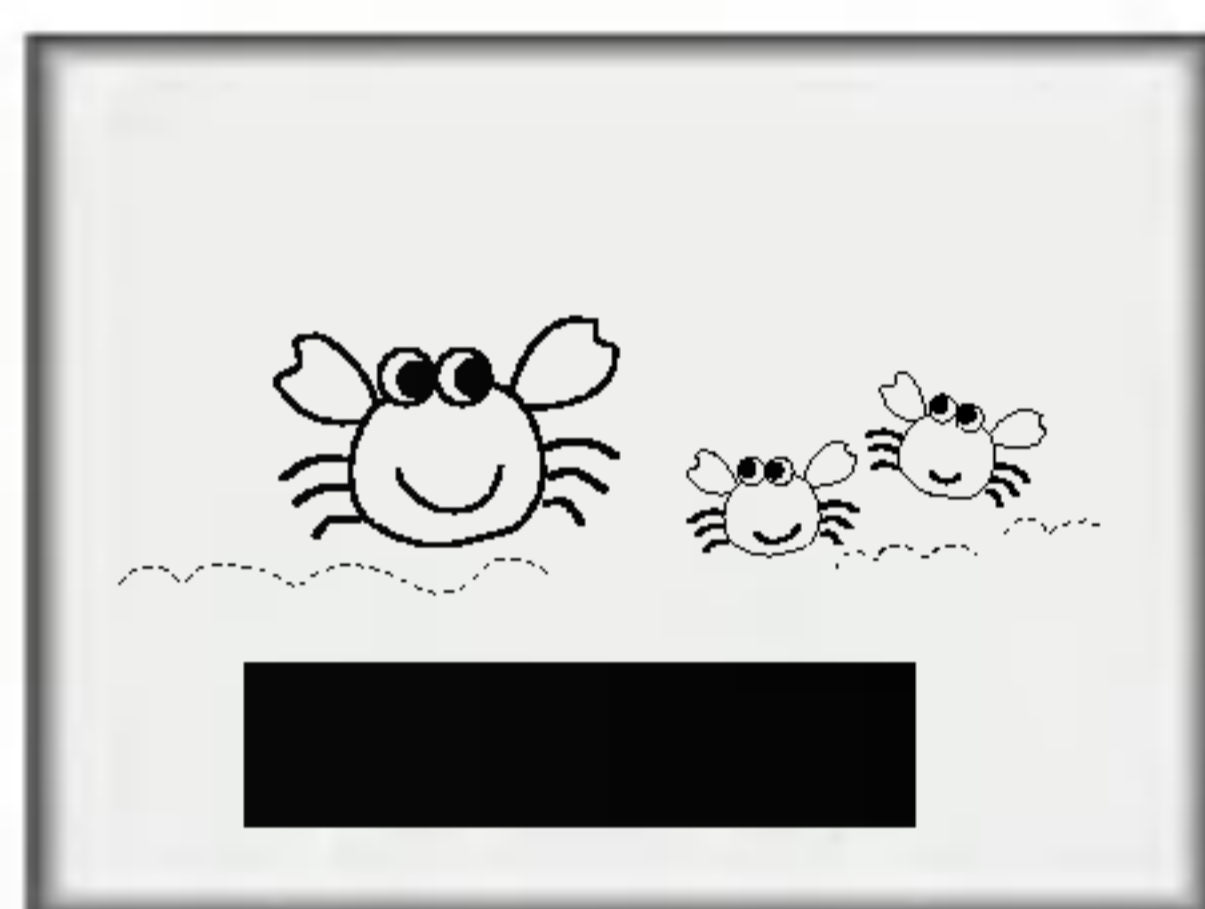

Captioning is an effective system for the hearing-impaired, and it can also aid in teaching language skills.

• The picture at left shows a typical caption.

### Caption Tips

- Not all TV broadcasts include closed caption signals.
- Sometimes TV stations broadcast four different caption signals on the same channel. By selecting **From Mode 1 to Mode 2**, you can choose which signal you view. **Mode 1** is usually the signal with the captions, while **Another mode** might show demonstration or programming information.
- Your TV might not receive caption signals normally in the following situations.

1. Poor reception conditions are encountered:



#### • IGNITION:

Picture may flutter, drift, suffer from black spots, or horizontal streaking. Usually caused by interference from automobile ignition systems, neon lamps, electrical drills, and other electrical appliances.



#### • GHOSTS:

Ghosts are caused when the TV signal splits and follows two paths. One is the direct path and the other is reflected off tall buildings, hills or other objects. Changing the direction or position of the antenna may improve reception.



#### • SNOW:

If your receiver is located at the weak, fringe area of a TV signal, your picture may be marred by small dots. It may be necessary to install a special antenna to improve the picture.

2. An old, bad, or illegally recorded tape is being played.
3. Strong, random signals from a car or airplane interfere with the TV signal.
4. The signal from the antenna is weak.
5. The program wasn't captioned when it was produced, transmitted, or taped.

1. Use the **CAPTION** button to select your caption selection as shown below.



• You can also adjust **Caption** in the **Special** menu.

- The TV can be set up so that it can only be used with the remote control.
- This feature can prevent unauthorized viewing.

1. Press the **MENU** button and then use **▲ / ▼** button to select the **Special** menu.
2. Press the **▶** button and then use **▲ / ▼** button to select **Key lock**.
3. Press the **▶** button and then use **▲ / ▼** button to select **On** or **Off**.
4. Press the **EXIT** button to save and return to TV viewing.

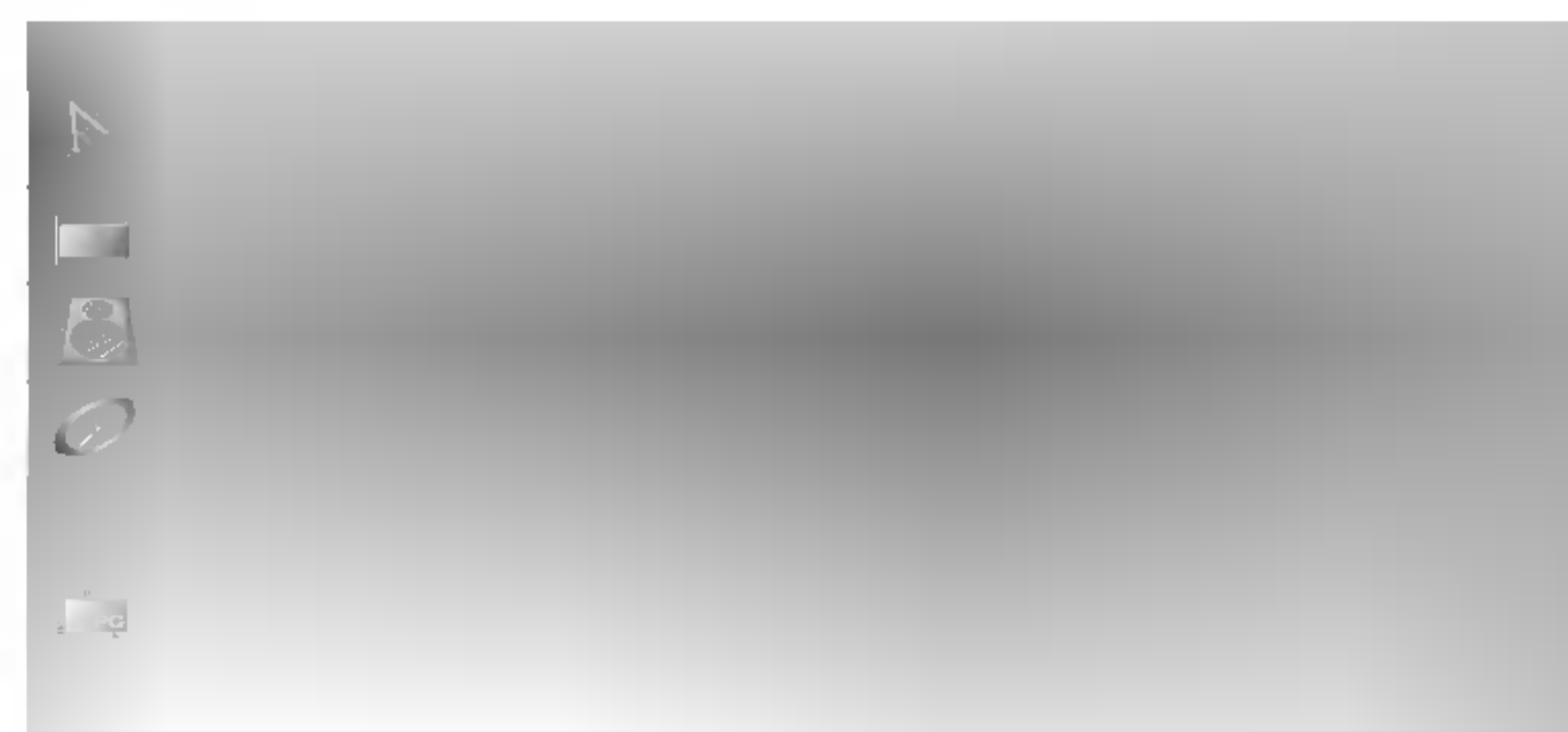

## PC Menu Options (only DVI-Analogue mode)

- After setup, be sure to select PC source to see the PC image on TV screen.

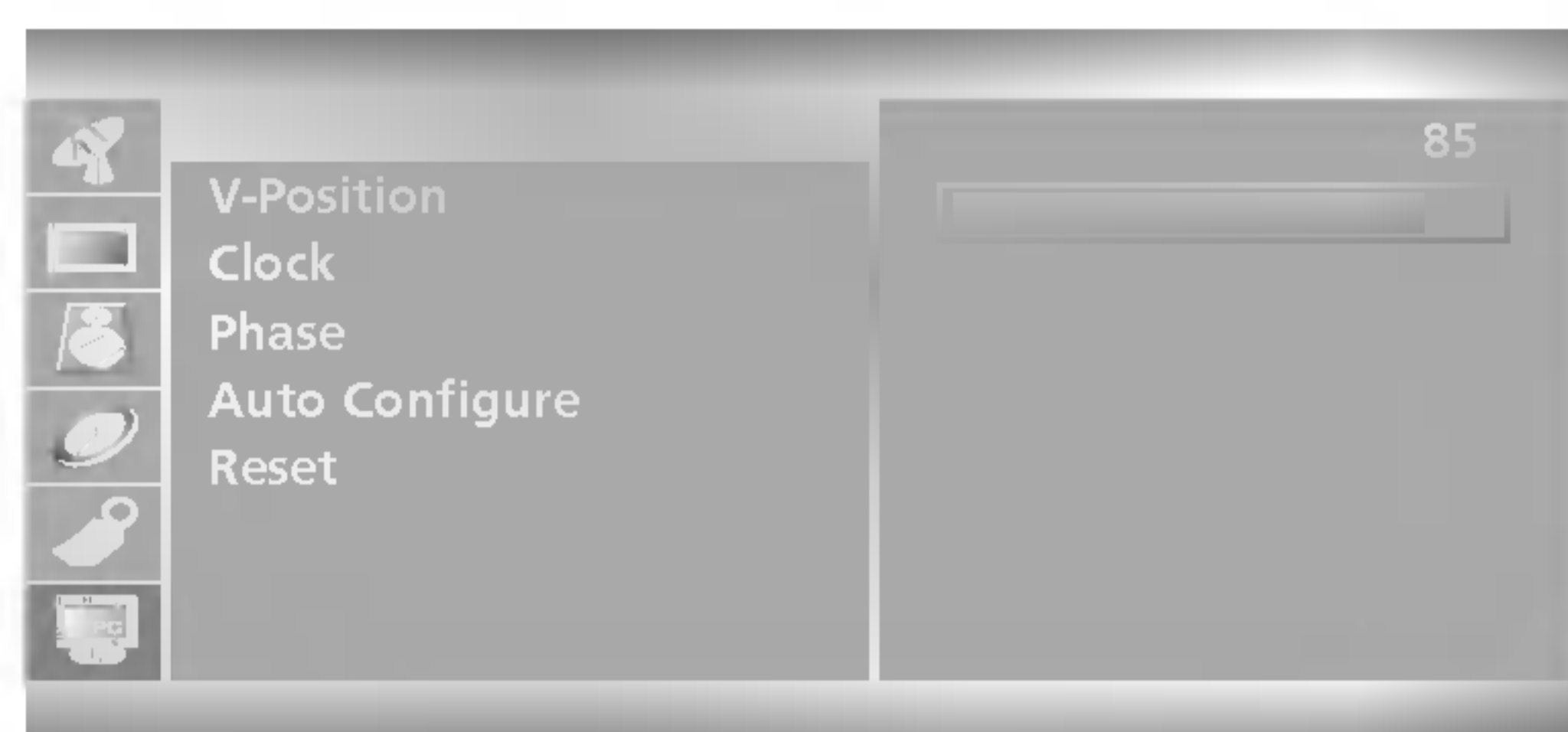

1. Press the **MENU** button and then use **▲ / ▼** button to select the **PC** menu.
2. Press the **▶** button and then use **▲ / ▼** button to select desired item.
3. Use the **◀ / ▶** button to make appropriate adjustments.
  - H-position/V-position  
Adjusts picture left/right and up/down.  
The adjustment ranges of H-Position is 0~100.  
(Based on the input mode, the adjustment range may change.)
  - Clock  
Minimizes any vertical bars or stripes appearing on the screen background.  
The adjustment range is 0~100. (Based on the input mode, the adjustment range may change.)
  - Phase  
Remove any horizontal noise and clear up or sharpen the character images.  
The range adjustment is 0~100. (Based on the input mode, the adjustment range may change.)
  - Auto-configure  
Automatically adjusts the screen position, clock, and clock phase.  
(The displayed image will disappear for a few seconds while Auto-configuration is in progress.)
  - Reset  
Returns to the default settings programmed at the factory; default settings cannot be changed.
4. Press the **ENTER** button to save.



# IR Codes

▶ Connect your wired remote control to the Remote Control port on the Monitor.

▶ **Output waveform**

Single pulse, modulated with 37.917KHz signal at 455KHz

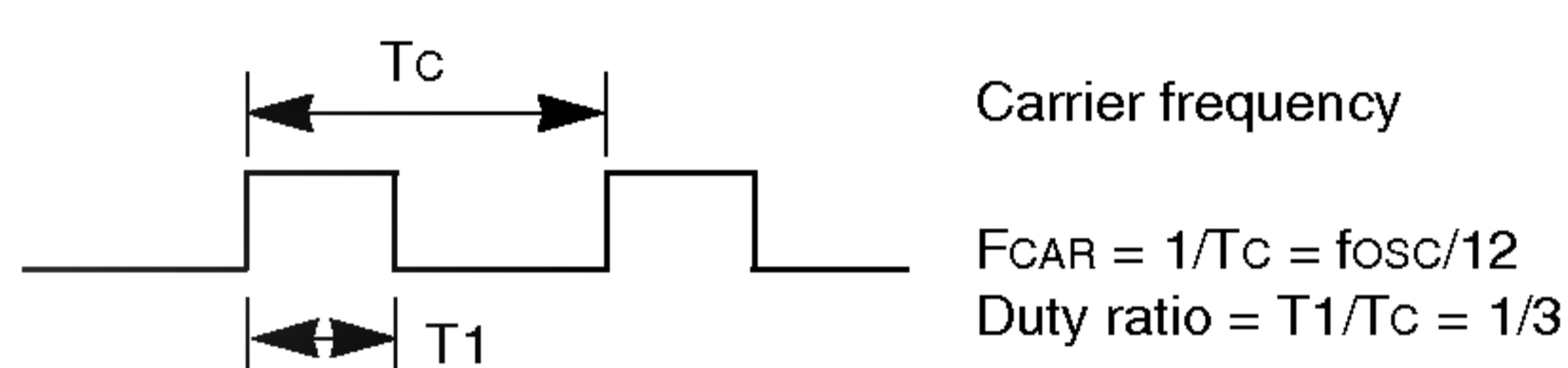

▶ **Configuration of frame**

• 1st frame

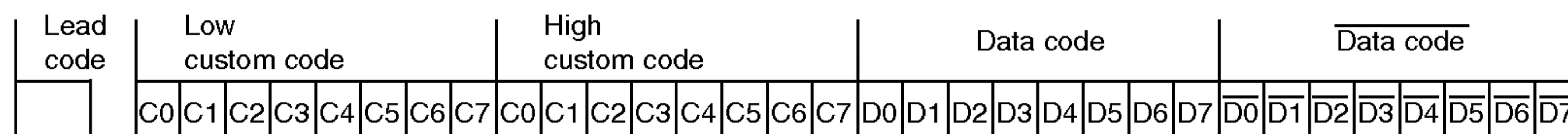

• Repeat frame

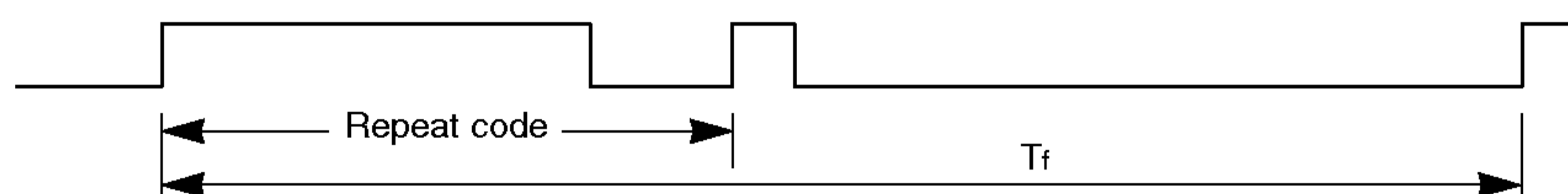

▶ **Lead code**

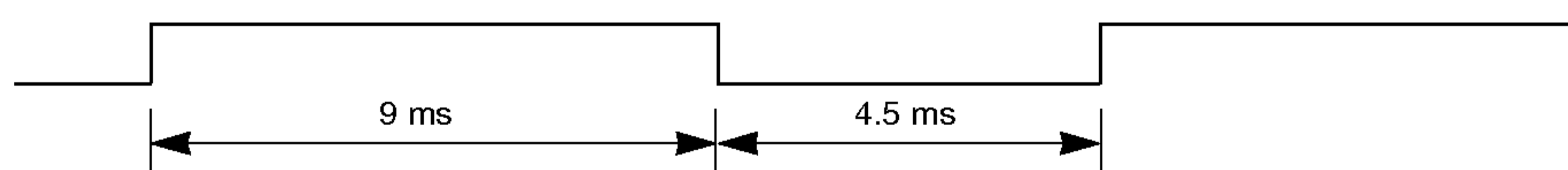

▶ **Repeat code**

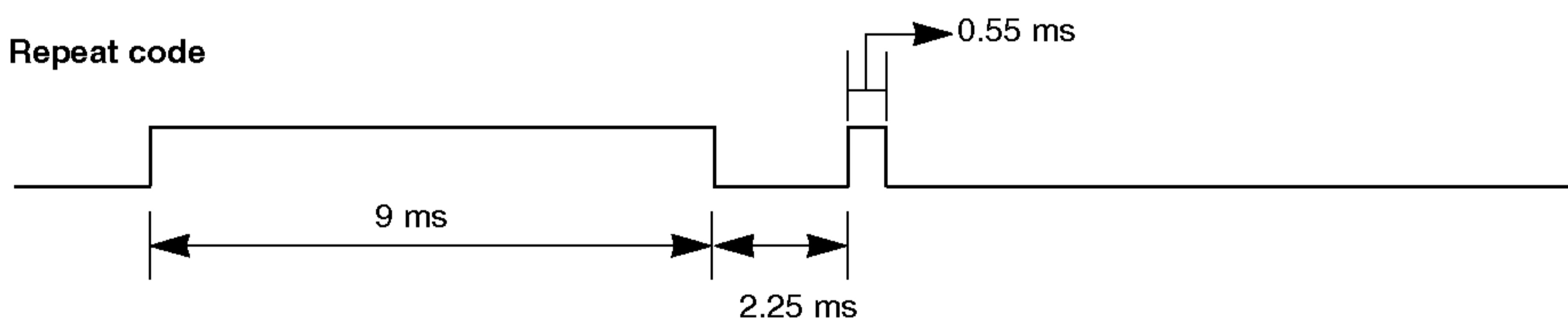

▶ **Bit description**

• Bit "0"

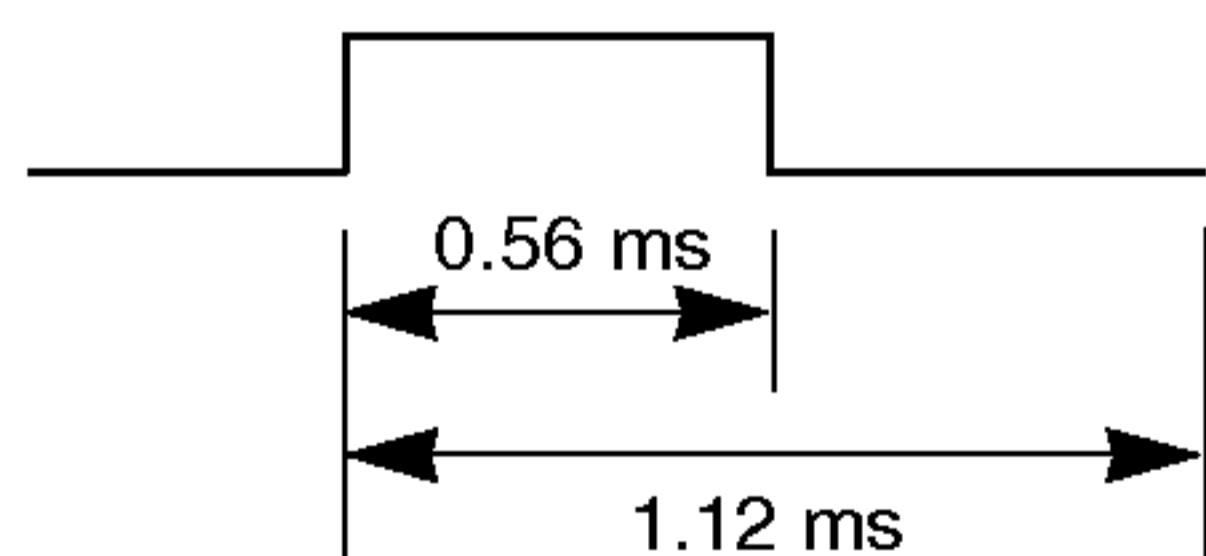

• Bit "1"

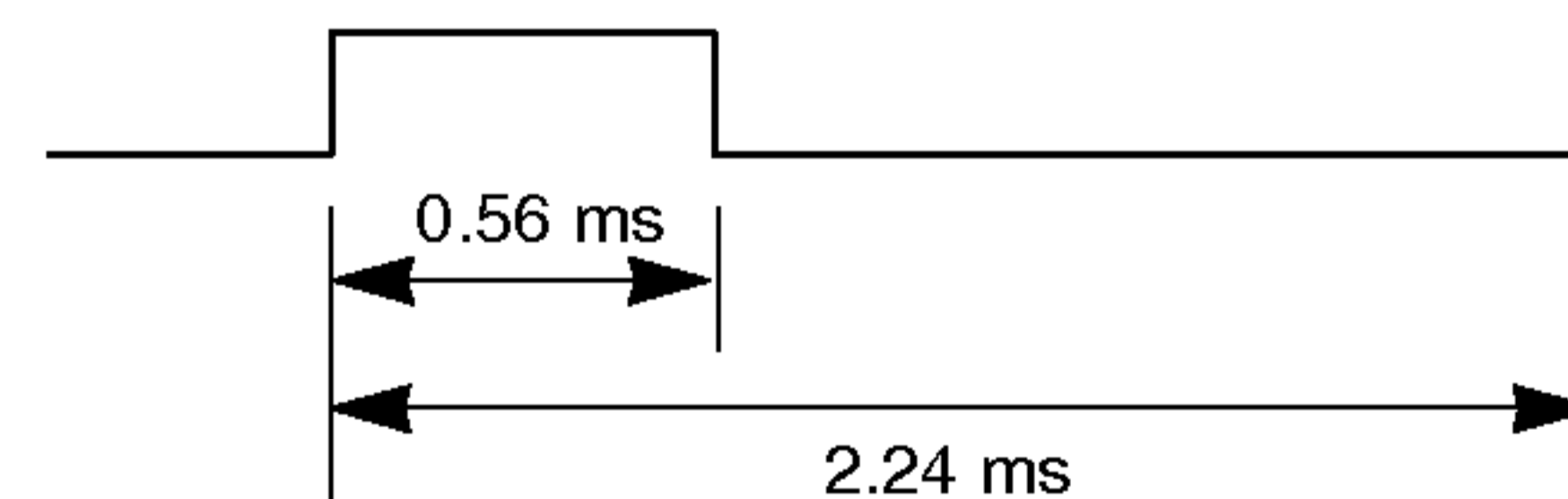

▶ **Frame interval : Tf**

The waveform is transmitted as long as a key is depressed.

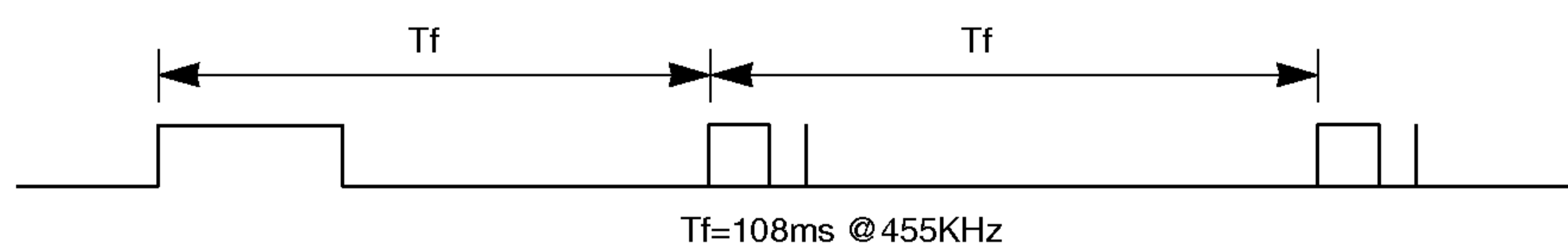



## Maintenance

- Early malfunctions can be prevented. Careful and regular cleaning can extend the amount of time you will have your new TV. Be sure to turn the power off and unplug the power cord before you begin any cleaning.

- 
1. Here's a great way to keep the dust off your screen for a while. Wet a soft cloth in a mixture of lukewarm water and a little fabric softener or dish washing detergent. Wring the cloth until it's almost dry, and then use it to wipe the screen.
  2. Make sure the excess water is off the screen, and then let it air-dry before you turn on your TV.



To remove dirt or dust, wipe the cabinet with a soft, dry, lint-free cloth. Please be sure not to use a wet cloth.



If you leave your TV dormant for a long time (such as a vacation), it's a good idea to unplug the power cord to protect against possible damage from lightning or power surges.

# Product Specifications

Power Requirement	<b>RM-23LZ50</b> : AC 100-240V~ 50/60Hz 1.4A <b>RM-26LZ50/27LZ50</b> : AC 100-240V~ 50/60Hz 1.5A <b>RM-30LZ50</b> : AC 100-240V~ 50/60Hz 1.8A <b>RM-32LZ50</b> : AC 100-240V~ 50/60Hz 2.0A
Power Consumption	<b>RM-23LZ50</b> : 120W <b>RM-26LZ50/27LZ50</b> : 130W <b>RM-30LZ50</b> : 140W <b>RM-32LZ50</b> : 160W
Television System	NTSC , PAL - M/N
Television Channel	VHF : 2 ~ 13, UHF : 14 ~ 69, Cable : 01 ~ 125
Television Screen	LCD Panel
External Antenna Impedance	75 $\Omega$
Audio Output	<b>RM-23LZ50/26LZ50/27LZ50</b> : 7 W + 7 W <b>RM-30/32LZ50</b> : 10 W + 10 W

# Note

# Troubleshooting Checklist

## SYMPTOMS

No power

No picture or sound

Poor picture but good sound

Poor reception

Lines in picture

Ghosts (multiple images)

Remote control does not work.

Cannot tune desired channel.

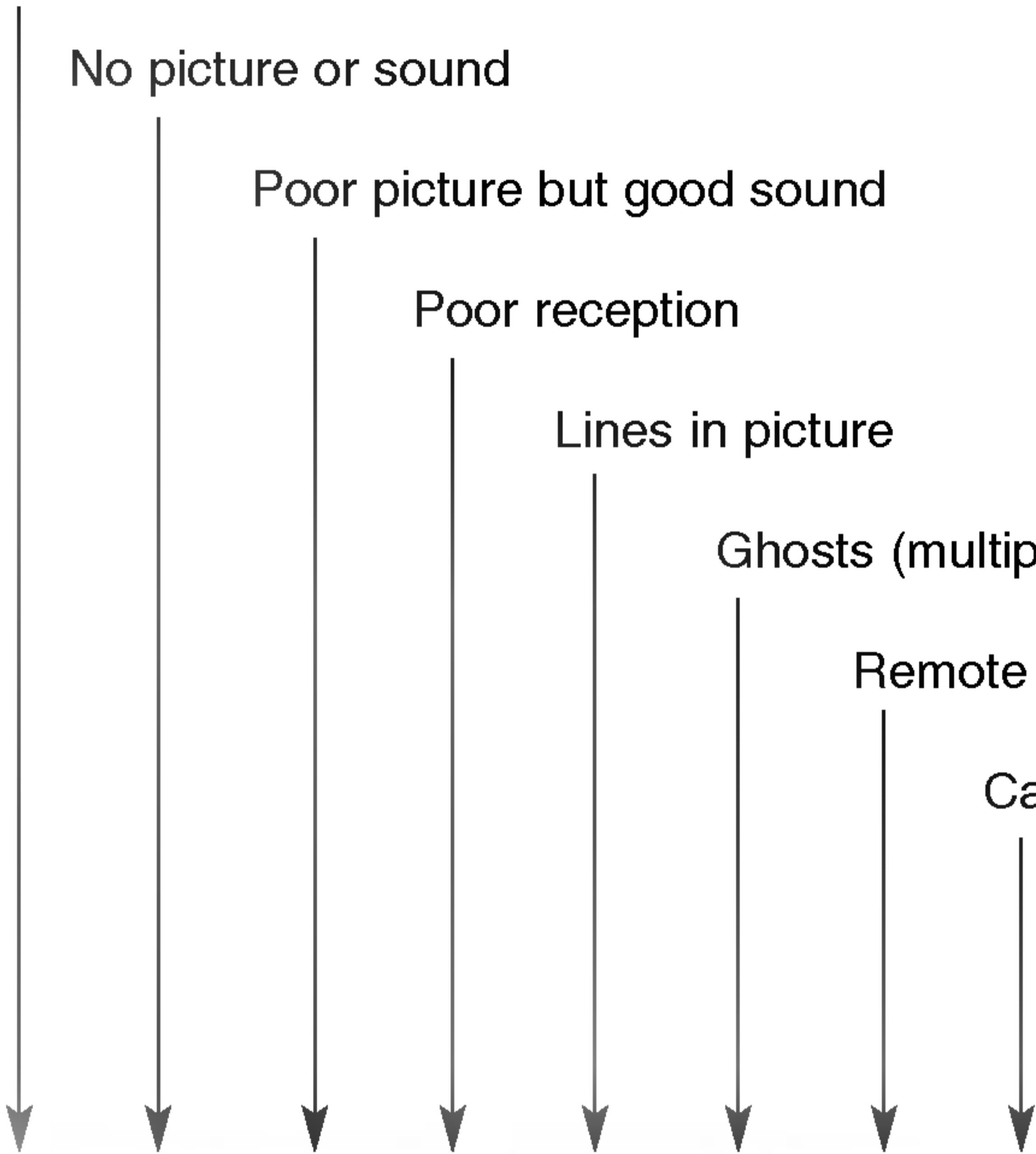
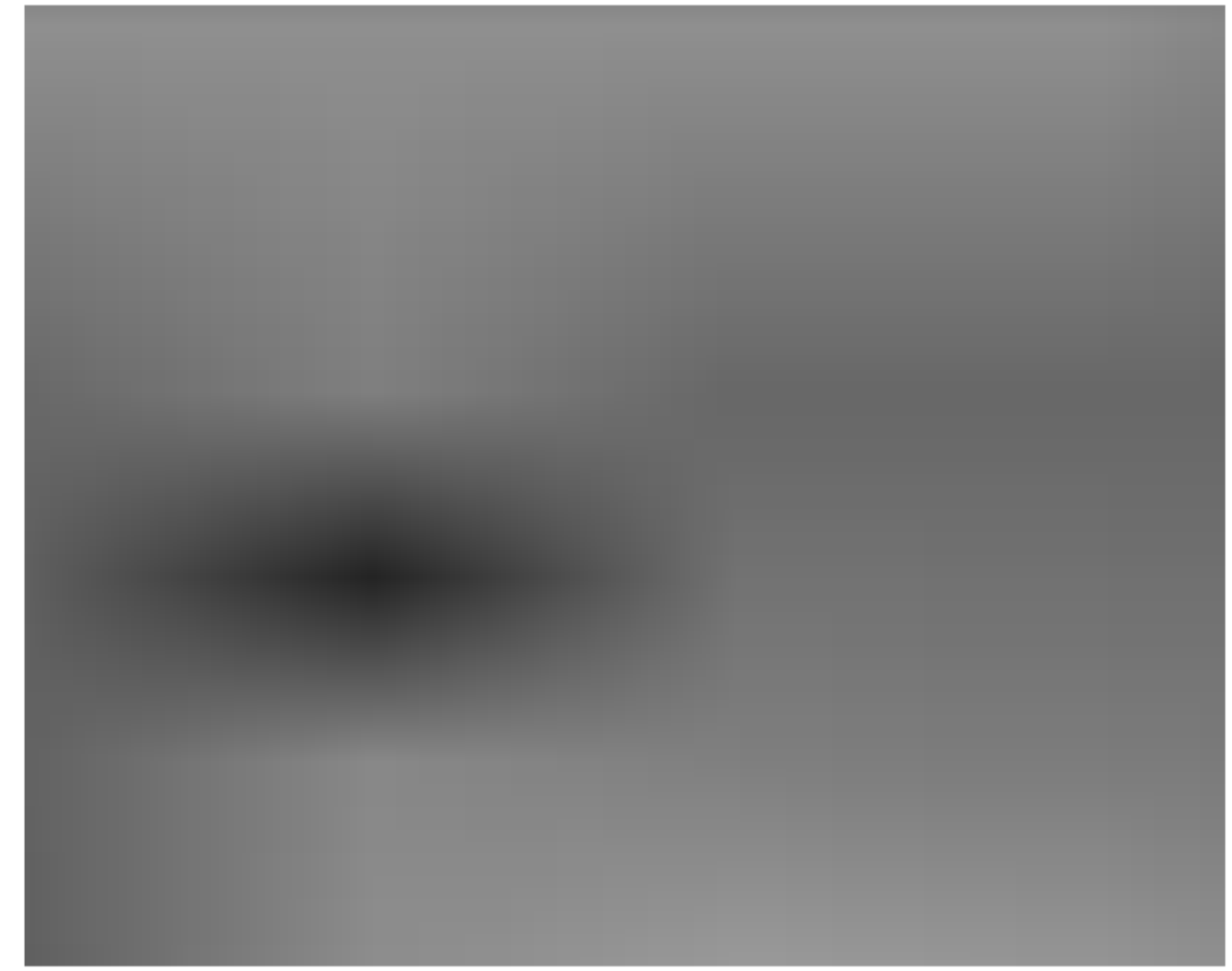

## CHECK THESE THINGS

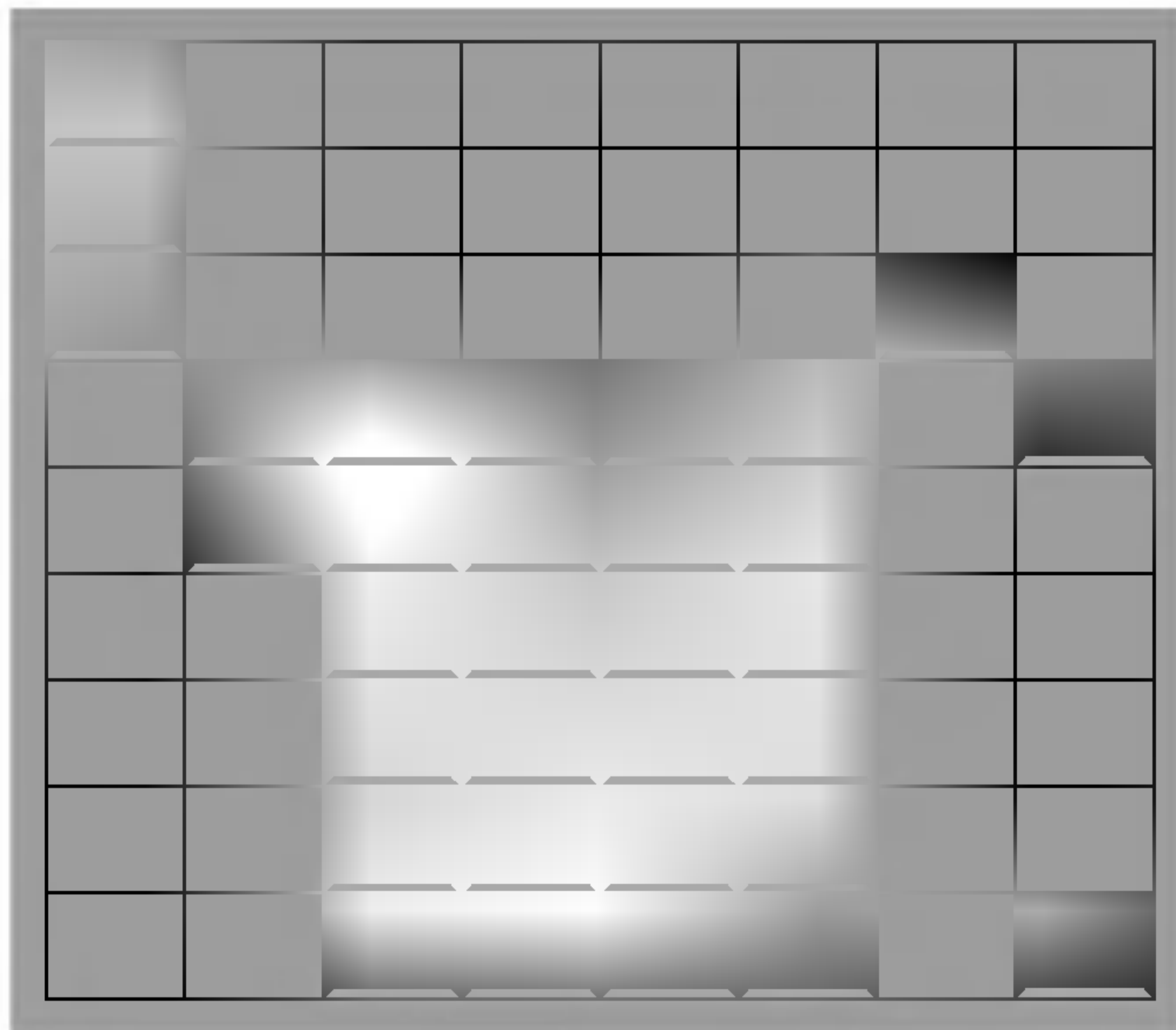

- Is power cord plugged in ?
- Is television turned on ?
- Check batteries in remote control.
- Try another channel (station trouble).
- Check antenna connectings.
- Check for local interference.
- Adjust the antenna.
- Adjust the picture control.
- Program channel using Auto program.

