



# PLASMA TV OWNER'S MANUAL

Please read this manual carefully before operating your set.  
Retain it for future reference.  
Record model number and serial number of the set.  
See the label attached on the back cover and quote this information to your dealer when you require service.

Model number :  
Serial number :

# Safety Instructions

## **WARNING**

**Do not place the set in direct sunlight or near heat sources such as heat registers, stove and so on.**

- This may cause a fire.

**Do not use the set in damp place such as a bathroom or any place where it is likely to get wet.**

- This may cause a fire or could give an electric shock.

**Bend antenna cable between inside and outside building to prevent rain from flowing in.**

- This may cause water damaged inside the set and could give an electric shock.

**Earth wire should be connected.**

- If the earth wire is not connected, there is possible a danger of electric shock caused by the current leakage.
- If grounding methods are not possible, a separate circuit breaker should be employed and installed by a qualified electrician.

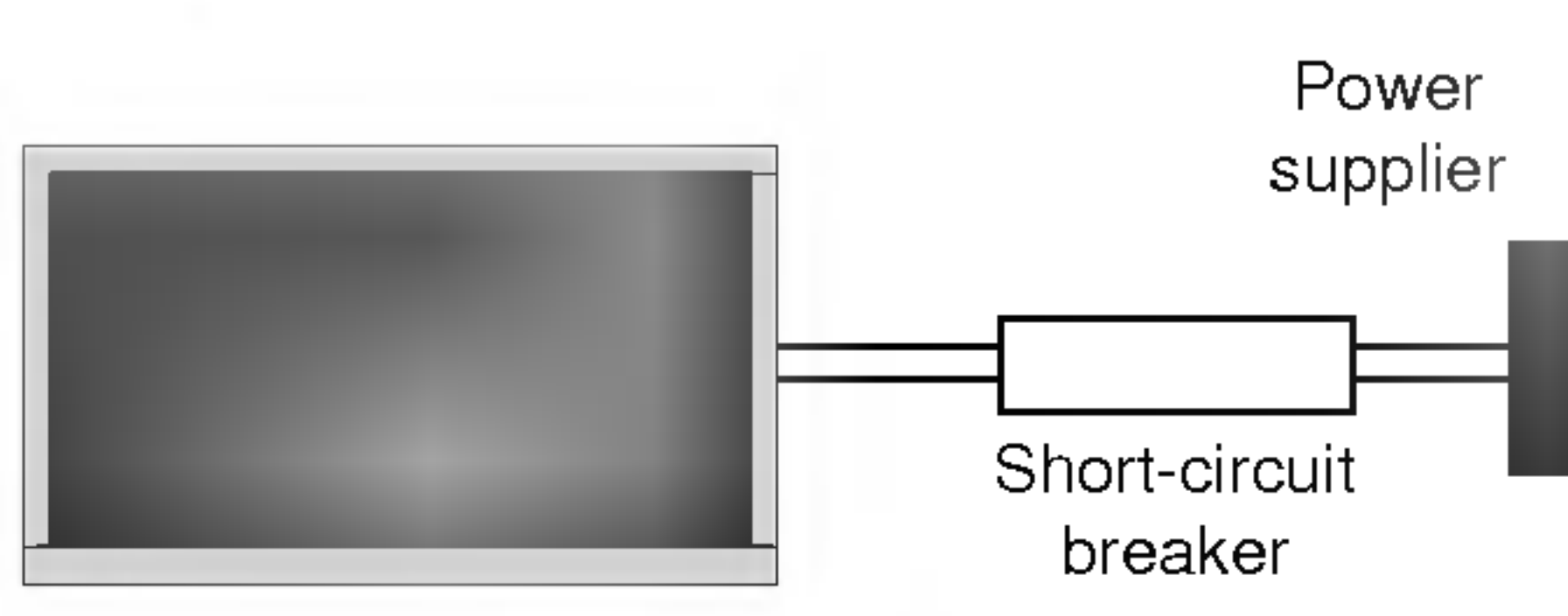

- Do not connect ground to telephone wires, lightning rods or gas pipe.

**Apparatus shall not be exposed to dripping or splashing and no objects filled with liquids, such as vases, shall be placed on the apparatus.**

**Do not insert any object into the exhaust vent.**

- This may cause a fire or could give an electric shock.

**Do not place heavy objects on the set.**

- This may cause serious injury to a child or adult.

## **WARNING in U.K. only**

- \* This set is supplied with a BS 1363 approved 13 amp mains plug, fused at 13 amp. When replacing the fuse always use a 13 amp BS 1362, BSI or ASTA approved type. Never use this plug with the fuse cover omitted. To obtain a replacement fuse cover contact your dealer or "LG Electronics U.K. Ltd." If the type of plug supplied is not suitable for the mains sockets in your home, then the plug should be removed and a suitable type fitted. A mains plug removed from the mains lead of this set must be destroyed. A mains plug with bared wires is hazardous if inserted in a mains socket. Do not connect either wire to the earth pin, marked with the letter E or with the earth symbol  $\equiv$  or coloured green or green and yellow. If any other plug is fitted, use a 13 amp fuse, either in the plug, or at the distribution board. The wires in this mains lead are coloured in accordance with the following codes: **BLUE: NEUTRAL, BROWN: LIVE** As the colours of the wires in the mains lead of this set may not correspond with the coloured marking identifying the terminals in your plug, proceed as follows: The wire which is coloured blue must be connected to the terminal which is marked with the letter N or coloured black. The wire which is coloured brown must be connected to the terminal which is marked with the letter L or coloured red.

**Do not use water while cleaning the set.**

- This may cause damaged the set or could give an electric shock.

**In case of smoke or strange smell from the set, switch it off ,unplug it from the wall outlet and contact your dealer or service center.**

- This may cause a fire or could give an electric shock.

**Do not attempt to service the set yourself. Contact your dealer or service center.**

- This may cause damaged the set or could give an electric shock.

**During storm activity, unplug the set from the wall outlet and don't touch an antenna cable.**

- This may cause damaged the set or could give an electric shock.

**DISCONNECTING DEVICE FROM MAINS**

- Mains plug is the disconnecting device. The plug must remain readily operable.

\* Safety instructions have two kinds of information, and each meaning of it is as below.

**⚠ WARNING** The violation of this instruction may cause serious injuries and even death.

**⚠ NOTES** The violation of this instruction may cause light injuries or damage of the product.

**⚠** Take care of danger that may happen under specific condition.

**⚠ NOTES**

**Never touch the power plug with a wet hand.**

- This may cause an electric shock.

**Disconnect from the mains and remove all connections before moving.**

**Do not place the set in a built-in installation such as a bookcase or rack.**

- Ventilation required.

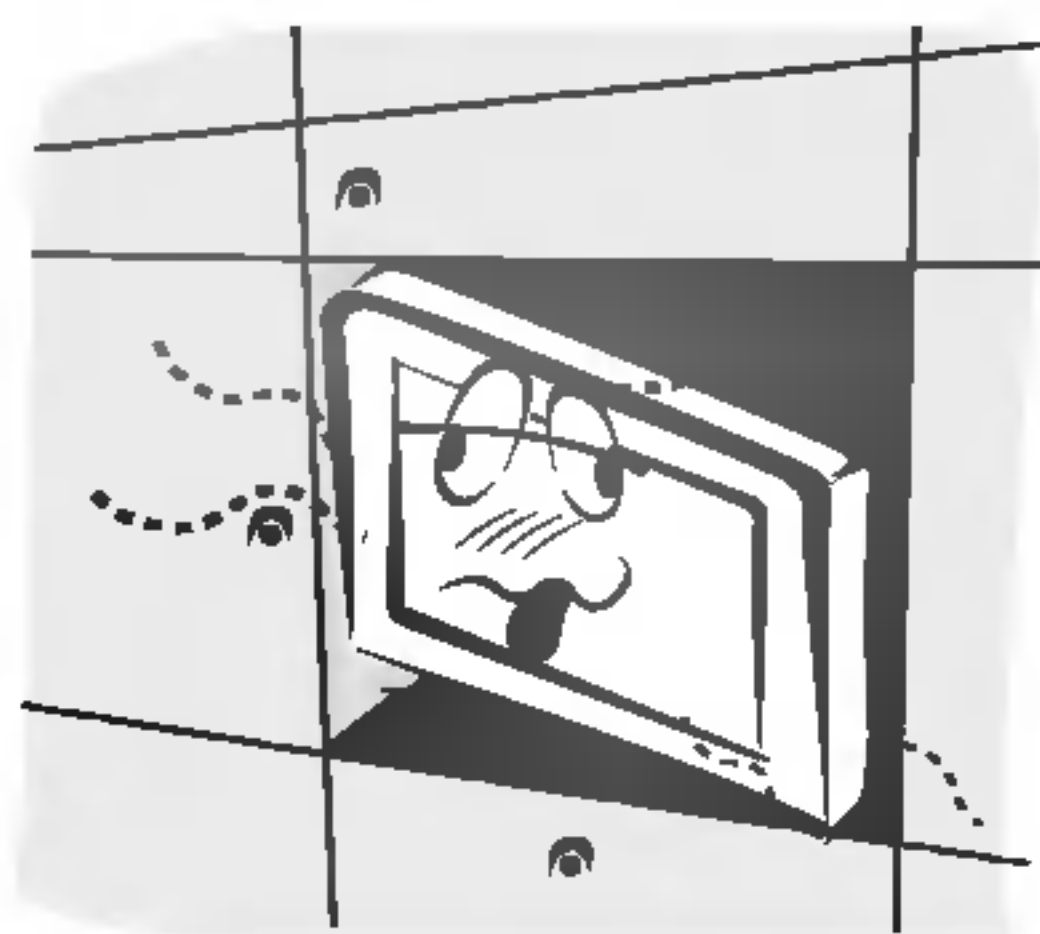

**When installing the set on a table, be careful not to place the edge of its stand on the end of the table.**

- This may cause the set to fall, causing serious injury to a child or adult, and serious damage to the set.

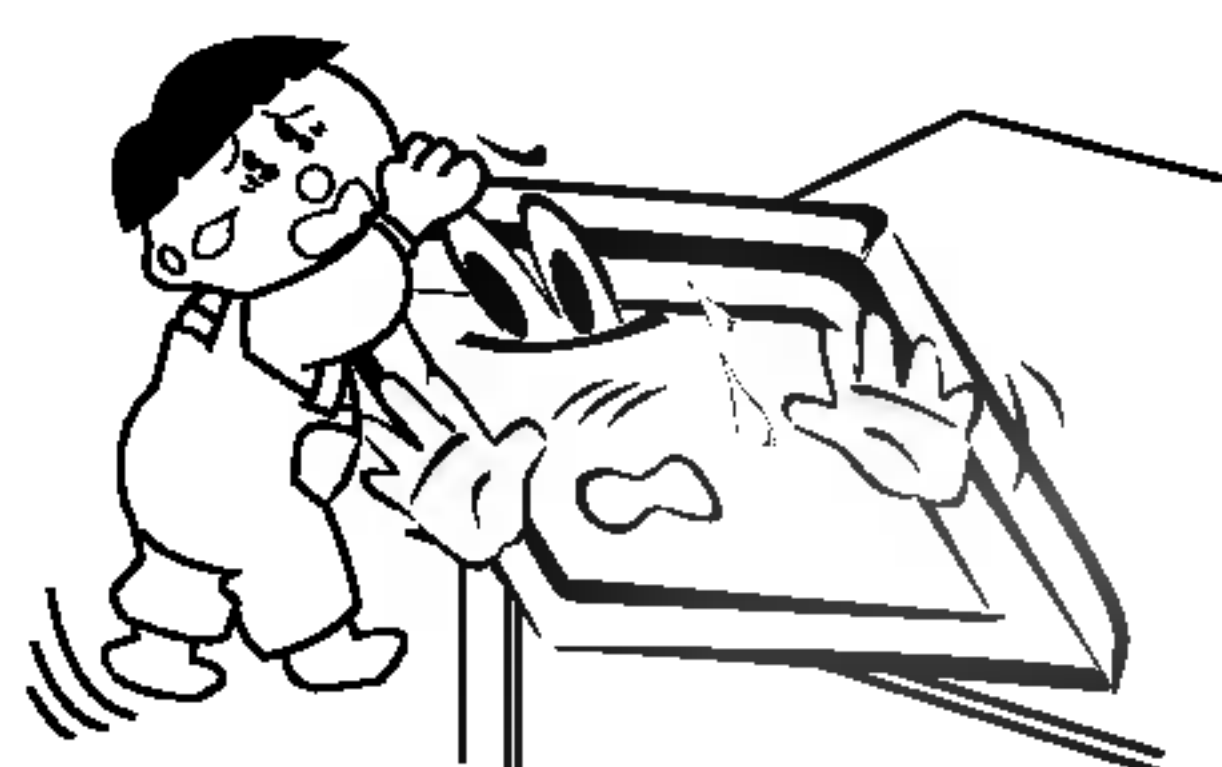

**Do not place an outside antenna in the vicinity of overhead power lines or other electric light or power circuits.**

- This may cause an electric shock.

**There should be enough distance between an outside antenna and power lines to keep the former from touching the latter even when the antenna falls.**

- This may cause an electric shock.

**Do not pull the plug not the cord when disconnecting.**

- This may cause a fire.

**Ensure the power cord doesn't trail across any hot objects like a heater.**

- This may cause a fire or an electric shock.

**Do not plug in unit if power cord or plug is damaged or the connecting part of the power outlet is loose.**

- This may cause a fire or an electric shock.

**Dispose of used batteries carefully to prevent a child from eating them.**

- In case of a child eating them, contact doctor immediately.

**When moving the set assembled with speakers do not carry holding the speakers.**

- This may cause the set to fall, causing serious injury to a child or adult, and serious damage to the Monitor.

**Unplug this product from the wall outlet before cleaning. Do not use liquid cleaners or aerosol cleaners.**

- This may cause damage the set or could give an electric shock.

**Contact the service center once a year to clean the internal part of the set.**

- Accumulated dust can cause mechanical failure.

**The distance between eyes and the screen should be approx. 5 ~ 7 times the diagonal length of the screen away.**

- If not, eyes will strain.

**Unplug the set from the wall outlet when it is left unattended and unused for long periods of time or occurred a state of emergency.**

- Accumulated dust may cause a fire or an electric shock from deterioration through electric leakage.



# Contents

<b>Safety Warnings</b>	
Safety Instructions	2~3
<b>Introduction</b>	
Remote Control Key Functions	6
Location and Function of Controls	7~8
<b>Installation</b>	
External Equipment Viewing Setups	9~12
Displayable Monitor Specification	13
HDMI	14~15
Accessories	16
Installation Options	17
<b>Operation</b>	
Turning on the Set	18
On-Screen Menu Language Selection (option)	18
<b>Channel Menu Options</b>	
Auto Programme Tuning	19
Manual Programme Tuning	19
Fine Tuning	20
Assigning a Station Name	20
Booster (option)	20
Programme Edit	21
Favourite Programme	21
Calling up the Programme Table	21
<b>Picture Menu Options</b>	
PSM (Picture Status Memory)	22
CSM (Colour Status Memory)	22
Manual Colour Temperature Control	22
<b>XD</b>	22
sRGB	23
ACM (Active Colour Management)	23
Manual Picture Control	23
<b>Sound Menu Options</b>	
SSM (Sound Status Memory)	24
BBE	24
AVL (Auto Volume Leveler)	24
Adjusting Sound Control	24
TV speaker	25
Stereo/Dual Reception	25
NICAM Reception (option)	25
<b>Time Menu Options</b>	
Setting the Clock	26
Setting the On/Off Timer	26
Auto Sleep	26
Sleep Timer	26
<b>Special Menu Options</b>	
Child Lock	27
ISM (Image Sticking Minimization) Method	27
Low Power	28
<b>XD</b> Demo	28
<b>Screen Menu Options</b>	
Auto Configure	29
Manual Configure	29
Selecting Wide VGA/XGA mode	29
Setting Picture Format	30
Picture Size Zoom	30
Screen Position	31
Cinema	31
NR (Noise Reduction)	31
Initializing (Reset to original factory value)	31
<b>PIP (Picture-in-Picture) Feature</b>	
Watching PIP	32
Programme Selection for Sub Picture	32
Selecting an Input Signal Source for the PIP	32
Moving the PIP (PIP mode only)	32
POP (Picture-out-of-Picture: Channel Scan)	32
Picture Size	32
Adjusting the screen for the PIP	32
Adjusting PIP Transparency (PIP mode only)	32
<b>Teletext (option)</b>	
Switch on/off	33
SIMPLE Text (option)	33
TOP Text (option)	33
FASTEXT	34
Special Teletext Functions	34
<b>Miscellaneous</b>	
External Control Device Setup	35~41
IR Code (NEC Format)	42~43
Programming the Remote	44
Programming Codes	45~46
Troubleshooting Checklist	50
Product Specifications	51

After reading this manual, keep it in a place where the user can refer to easily.

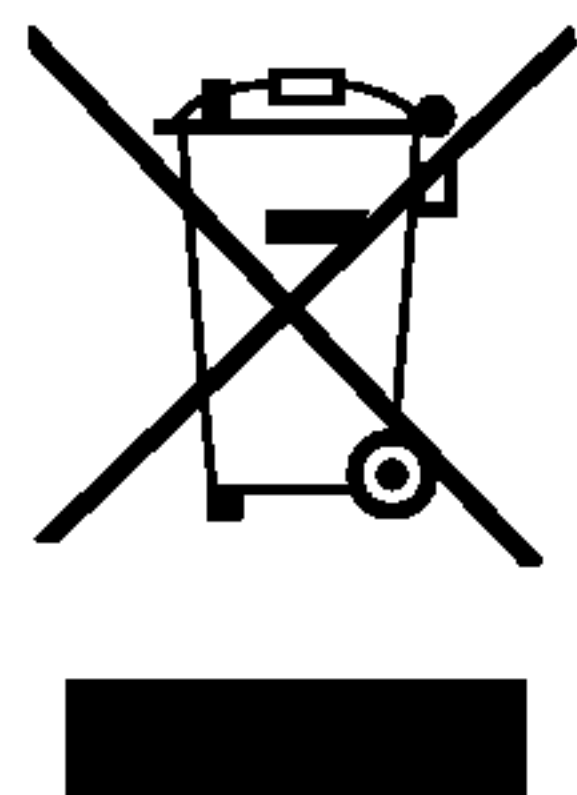

#### Disposal of your old appliance

1. When this crossed-out wheeled bin symbol is attached to a product it means the product is covered by the European Directive 2002/96/EC.
2. All electrical and electronic products should be disposed of separately from the municipal waste stream via designated collection facilities appointed by the government or the local authorities.
3. The correct disposal of your old appliance will help prevent potential negative consequences for the environment and human health.
4. For more detailed information about disposal of your old appliance, please contact your city office, waste disposal service or the shop where you purchased the product.

# Introduction

## What is a Plasma Display ?

If voltage is inputted to gas in glass panels, ultraviolet rays are outputted and fused with a fluorescent substance. At this moment, light is emitted. A Plasma Display is a next generation flat Display using this phenomenon.

## 160° - Wide angle range of vision

A Plasma Display provides more than 160° angle range of vision so that you can get a picture without distortion from any direction.

## Easy installation

A Plasma Display is much lighter and smaller than other same class products so that you can install the Plasma Display in the desired place.

## Big screen

The screen of a Plasma Display is 42" (or 50") so that you can get vivid experience as if you are in a theater.

## Multimedia Plasma Display

A Plasma Display can be connected with a computer so that you can use it as a screen for conference, game, internet and so on.

## The explanation about coloured dots may be present on PDP screen

The PDP which is the display device of this product is composed of 0.9 to 2.2 million cells and a few cell defects can occur in the manufacture of the PDP. Several coloured dots visible on the screen would be acceptable, in line with other PDP manufacturers and would not mean that the PDP is faulty. We hope you will understand that the product which corresponds to this standard is regarded as acceptable. It means that it could not be changed or refunded. We promise that we'll do our best to develop our technology to minimize the cell defects.

## The explanation about noise of 42" (or 50") PDP (option)

In the same way that a fan is used in a PC to keep the CPU cool, the PDP is equipped with cooling fans to improve the reliability of this product. Therefore, a certain level of noise could occur when the fan is operated. This noise doesn't have any negative effect on its efficiency and reliability and it's also determined to have no difficulty while using this product. The noise from the fans is normal in the operation of this product. We hope you will understand that a certain level of noise is acceptable. It means that it is not changeable nor refundable.

**WARNING**

TO REDUCE THE RISK OF FIRE AND ELECTRIC SHOCK, DO NOT EXPOSE THIS PRODUCT TO RAIN OR MOISTURE.



# Remote Control Key Functions

- When using the remote control aim it at the remote control sensor of the set.
- There's maybe a defect in consecutive operation of remote control in specified brightness according to this set feature.

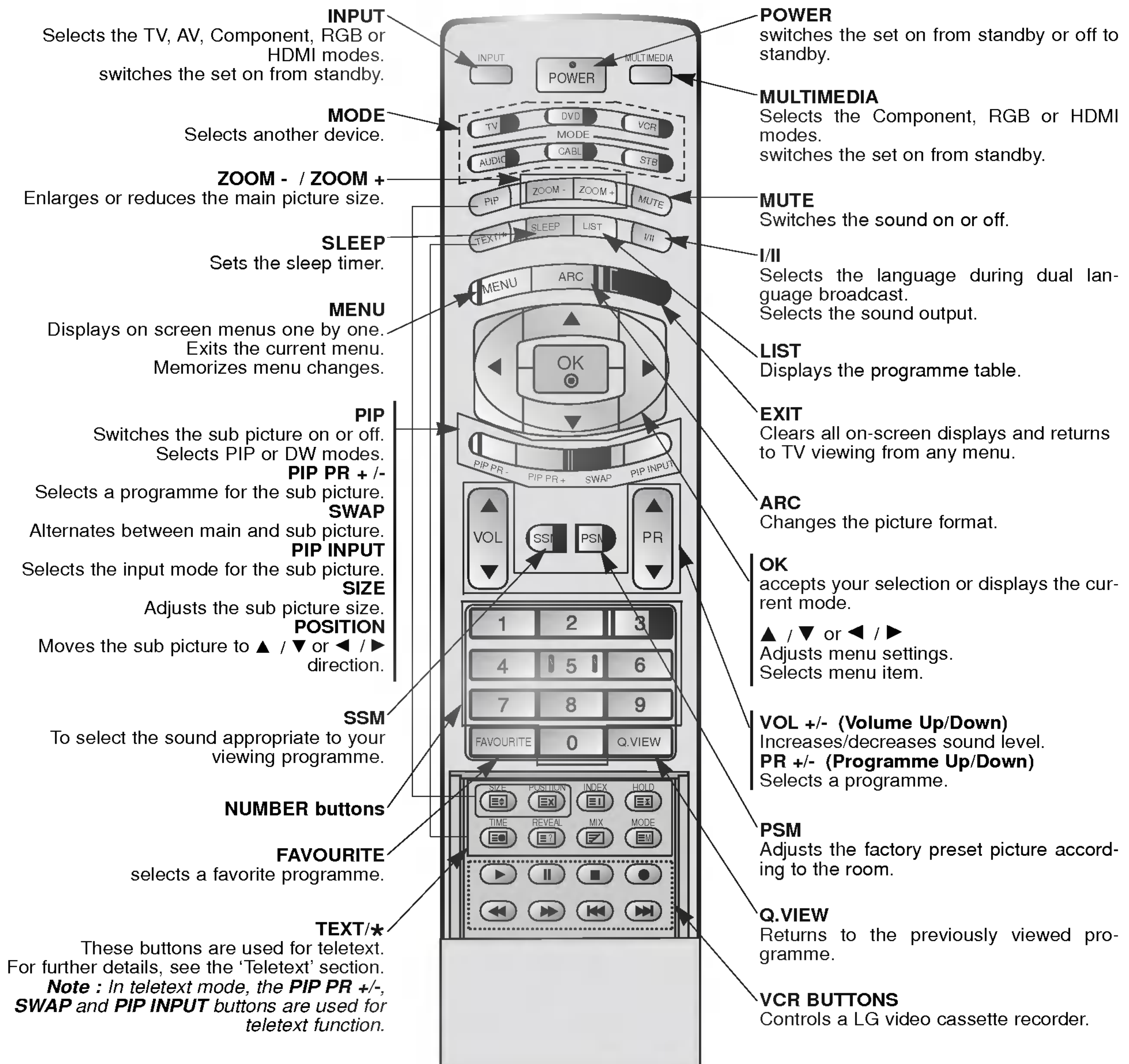

## Installing Batteries

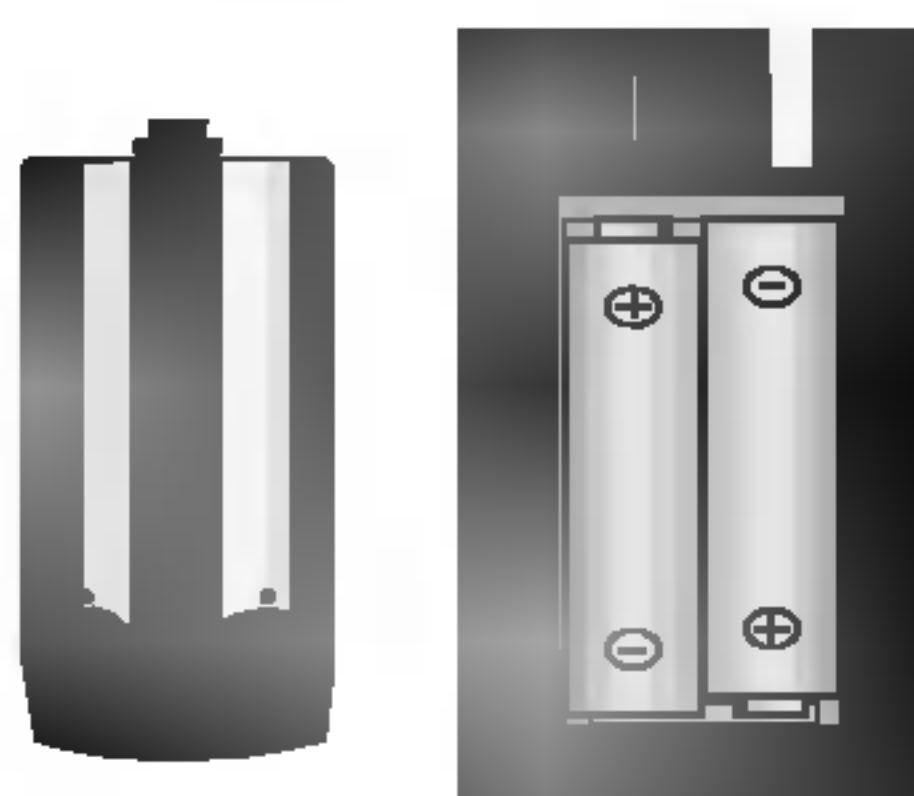

- Open the battery compartment cover on the back side and insert the batteries with correct polarity.
- Install two 1.5V alkaline batteries of AA type. Don't mix used batteries with new batteries.



# Location and Function of Controls

## <Front Panel Controls>

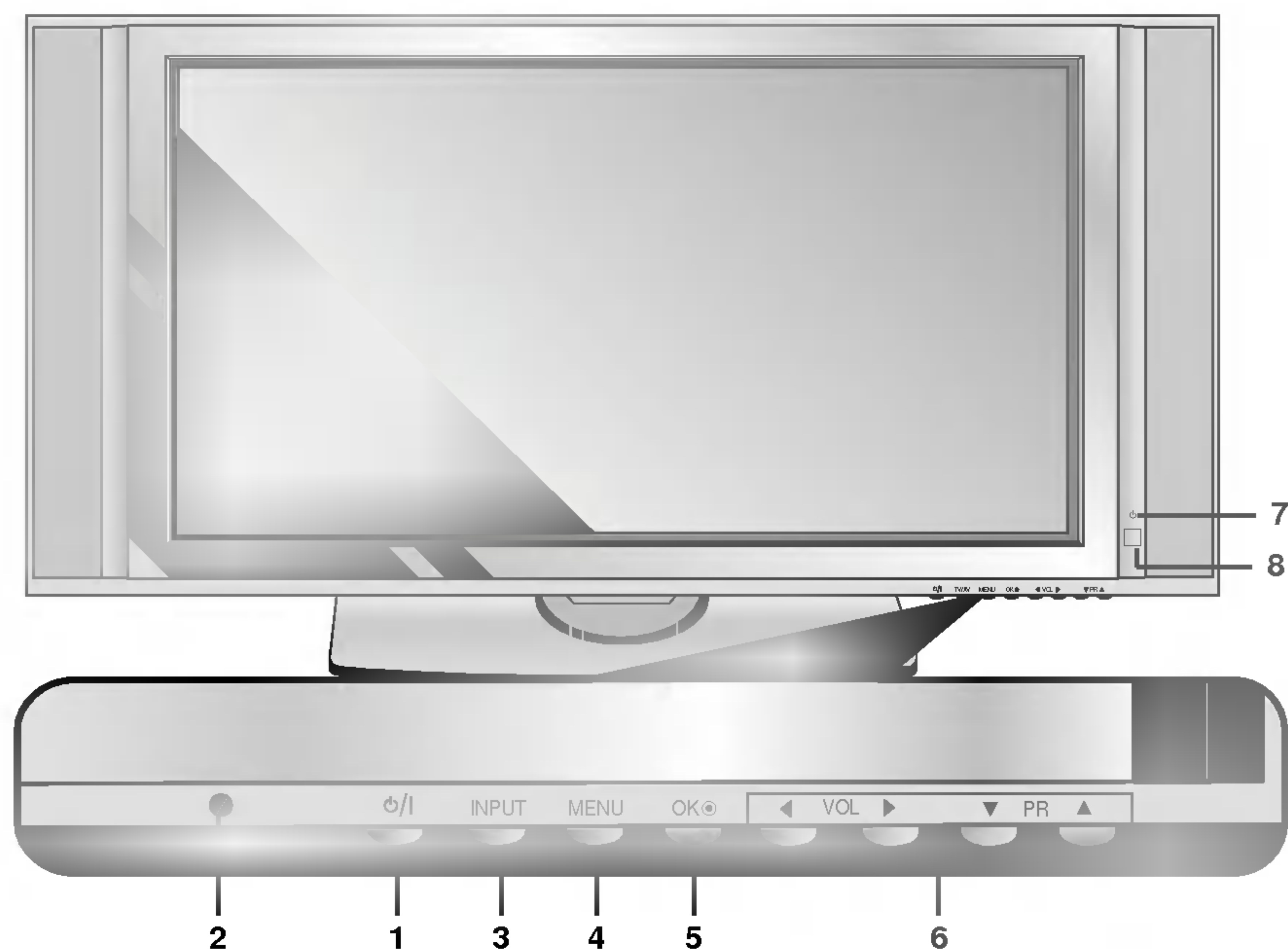

### 1. Power Button

Switches the set on from standby or off to standby.

### 2. Remote Control Sensor

### 3. INPUT Button

Selects the TV, AV, Component, RGB or HDMI modes.  
Switches the set on from standby.

### 4. MENU

Displays on screen menus one by one.  
Exits the current menu.  
Memorizes menu changes.

### 5. OK

Accepts your selection or displays the current mode.

### 6. ▲ / ▼ (Programme Up/Down)

Selects a programme or a menu item.  
Switches the set on from standby.

### ◀ / ▶ (Volume Up/Down)

Adjusts the volume.  
Adjusts menu settings.

### 7. Power Indicator

Illuminates red in standby mode, Illuminates green when the set is turned on

### 8. Intelligent Eye

Adjusts picture according to the surrounding conditions.

# Location and Function of Controls

- Shown is a simplified representation of the set.
- What is shown here may be somewhat different from your set.
- This manual explains the features available on the 42PX4R series.

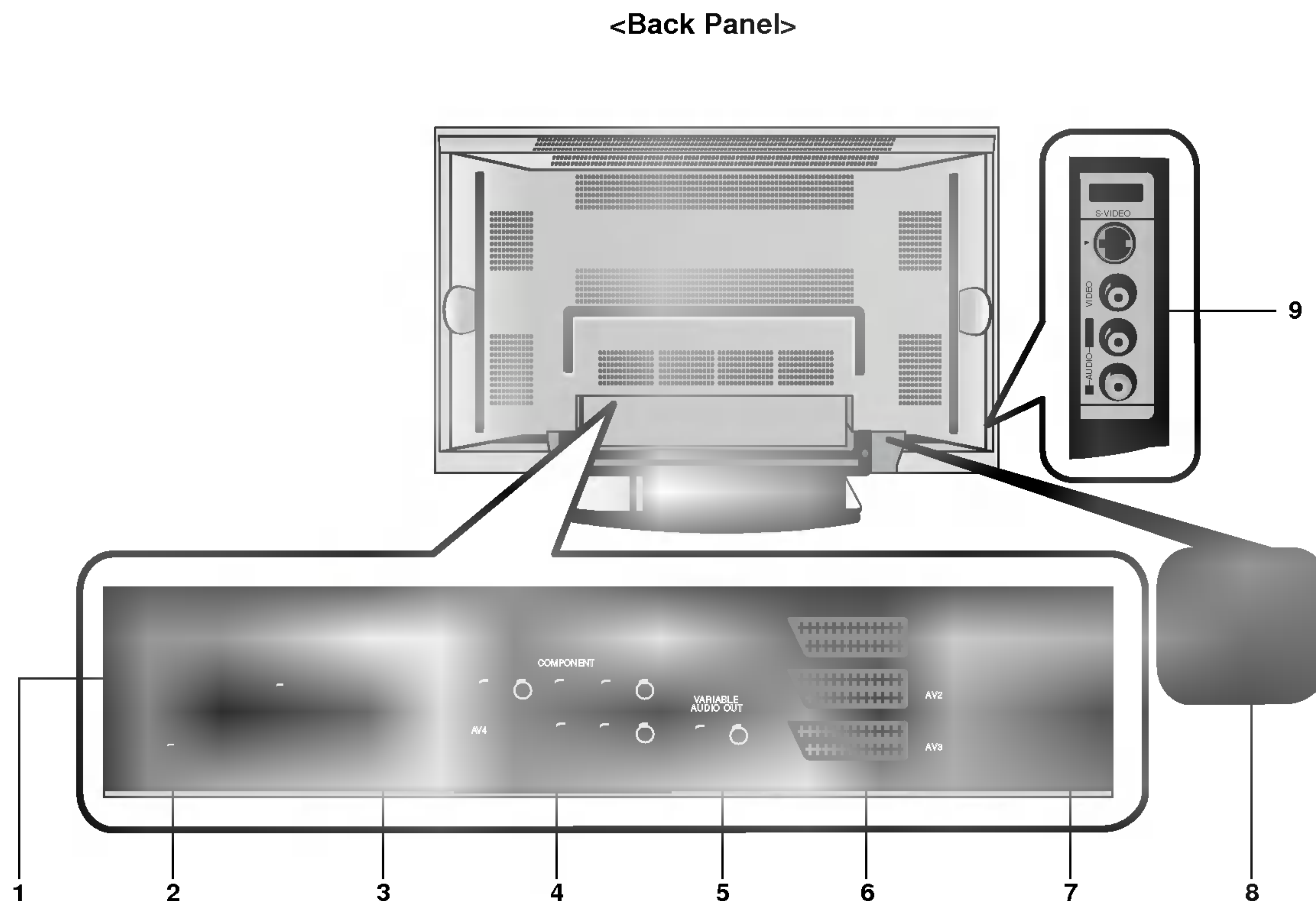

## 1. HDMI(DVI VIDEO) / AUDIO INPUT / RGB INPUT

Connect the monitor output socket of the PERSONAL COMPUTER, DVD or STB to this socket.

**Note:** If you want to use RGB/DVI audio, we strongly recommend that you use the cable that has a core, or the EMI Filter core along with separate cable.

## 2. REMOTE CONTROL

## 3. RS-232C INPUT(CONTROL/SERVICE) PORT

Connect to the RS-232C port on a PC.

## 4. COMPONENT INPUT

Connect DVD video outputs to Y, P<sub>B</sub>, P<sub>R</sub> of COMPONENT INPUT and audio outputs to Audio sockets of AUDIO INPUT.

### AUDIO/VIDEO IN SOCKETS (AV4)

Connect the audio/video out sockets of external equipment to these sockets.

### S-VIDEO/AUDIO IN SOCKETS

Connect the S-VIDEO out socket of an VCR to the S-VIDEO socket.

Connect the audio out sockets of the VCR to the audio sockets as in AV4.

## 5. VARIABLE AUDIO OUTPUT

## 6. EURO SCART SOCKET

Connect the euro scart socket of the VCR to these sockets.

### Note:

a. If you want to use the EURO scart cable, you have to use the signal shielded Euro scart cable.

b. If the S-VIDEO(Y/C) signal is received through the Euro scart socket 2 (AV 2), you must change to the S-Video 2 (Y/C) mode.

## 7. ANTENNA INPUT

## 8. POWER CORD SOCKET

This Monitor operates on AC power. The voltage is indicated on the Specifications page. Never attempt to operate the set on DC power.

## 9. AUDIO/VIDEO INPUT (AV5) S-VIDEO/AUDIO IN SOCKETS



# External Equipment Viewing Setups

## Antenna Connection

- Be careful not to bend the bronze wire when connecting to an antenna port.

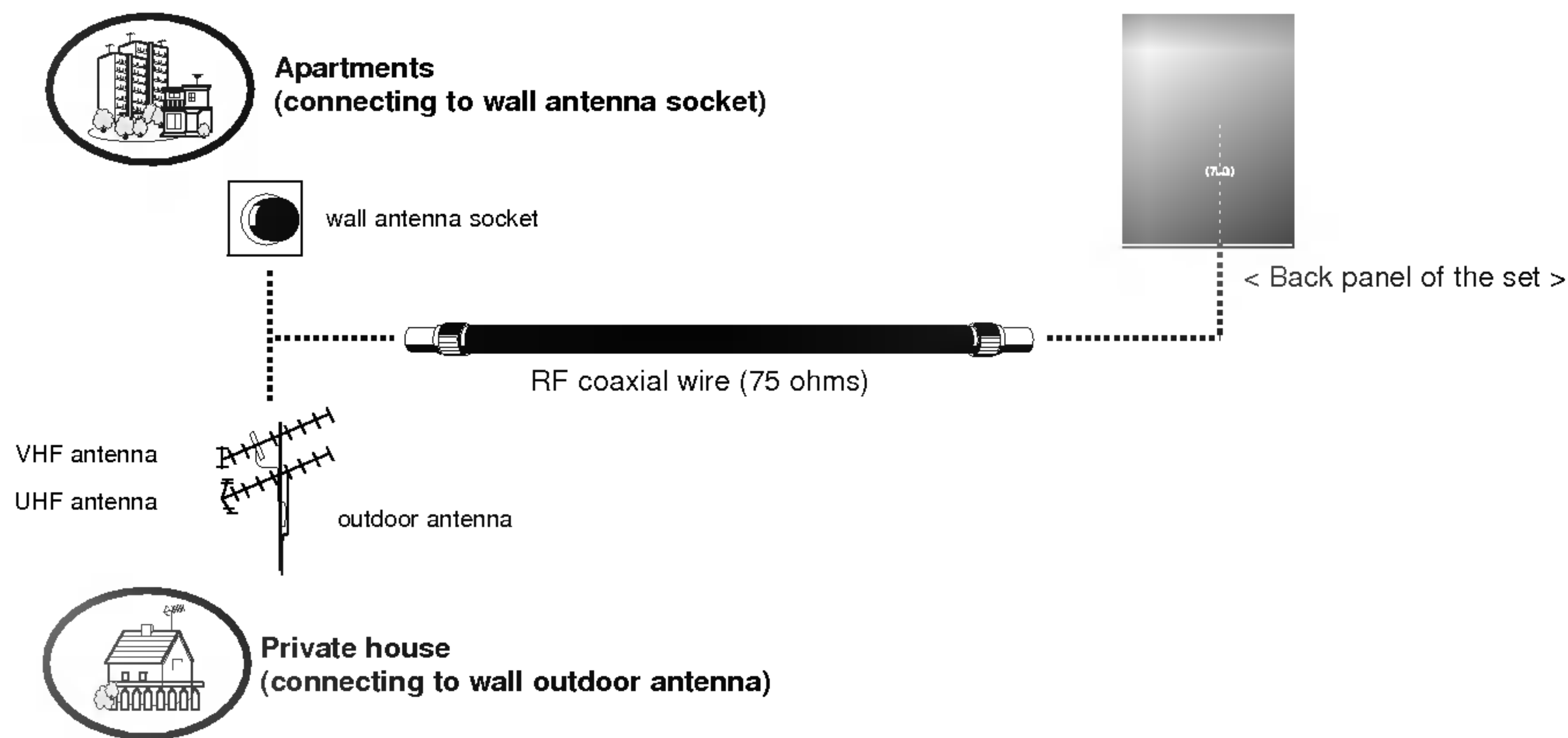

## Watching VCR

- When connecting the set to external equipment, match the colours of connecting ports (Video - yellow, Audio (L) - white, Audio (R) -red).
- Connect the VIDEO INPUT socket (yellow) of external equipment to the VIDEO INPUT on the set.
- If you have a mono VCR, connect the audio cable from the VCR to the AUDIO (L/MONO) input on the set.
- If you connect an S-VIDEO VCR to the S-VIDEO input, the picture quality is improved; compared to connecting a regular VCR to the Video input.  
Or, connect the Euro scart socket of the VCR to the Euro scart socket of the set.
- Use the orbiter function to Avoid having a fixed image remain on the screen for a long period of time. Typically a frozen still picture from a VCR. (Refer to p. 27)  
If a 4:3 picture format is used, the fixed image may remain visible on the screen.
- To avoid picture noise (interference), leave an adequate distance between the VCR and set.

## Watching TV programmes

- Turn the set on and select the programme you want.

## Watching VCR

1. Use the **INPUT** button on the remote control to select **AV1**, **AV2**, **S-Video2**, **AV3**, **AV4** or **AV5**.
- If both S-VIDEO and VIDEO sockets have been connected to the S-VHS VCR simultaneously, only the S-VIDEO can be received.
2. Insert a video tape into the VCR and press the **PLAY** button on the VCR.  
(See VCR owner's manual)

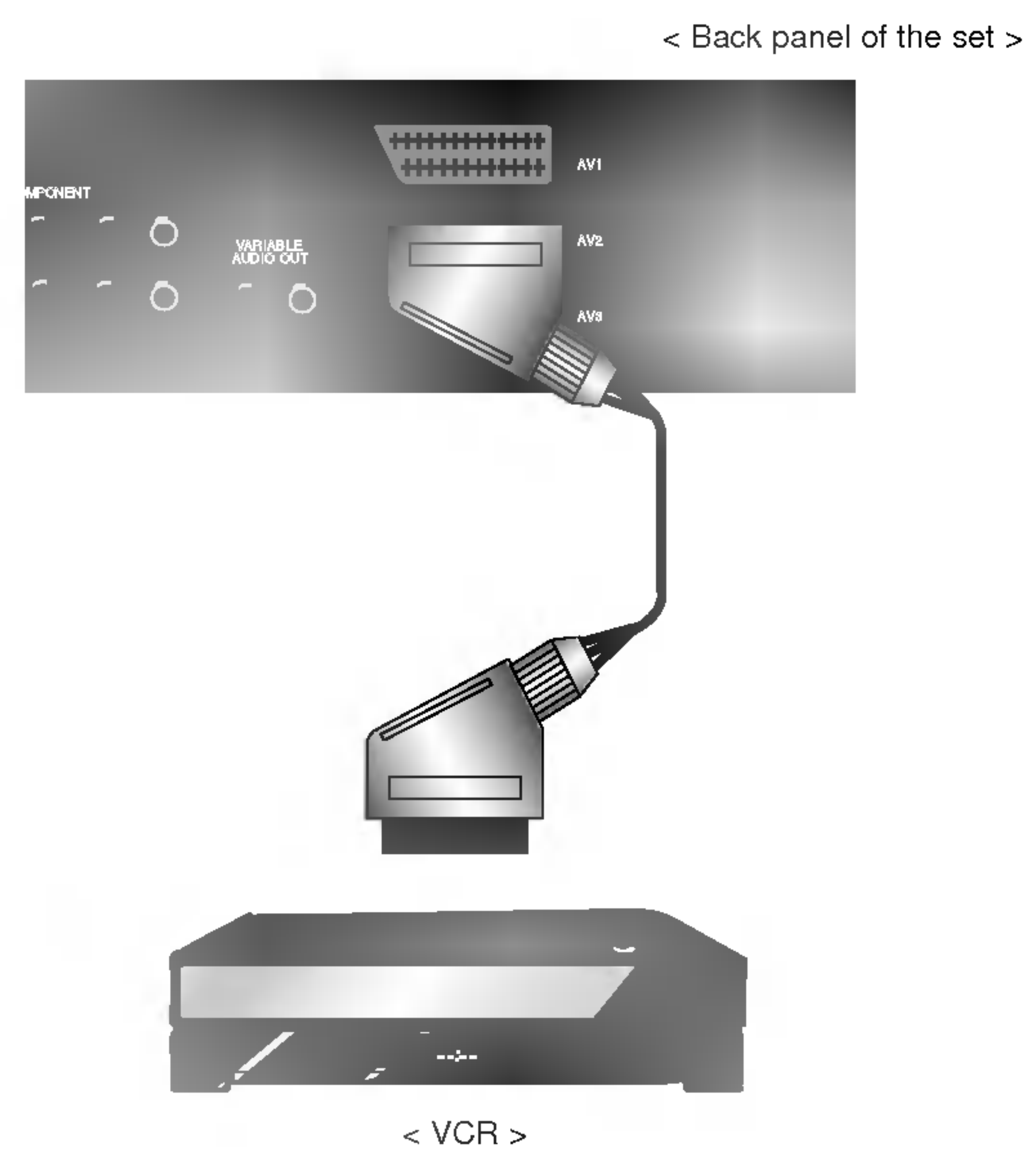

# External Equipment Viewing Setups

## Watching Cable TV

- After subscribing for a local cable TV station and installing a converter you can watch cable TV.
- For further information of cable TV, contact the local cable TV station.

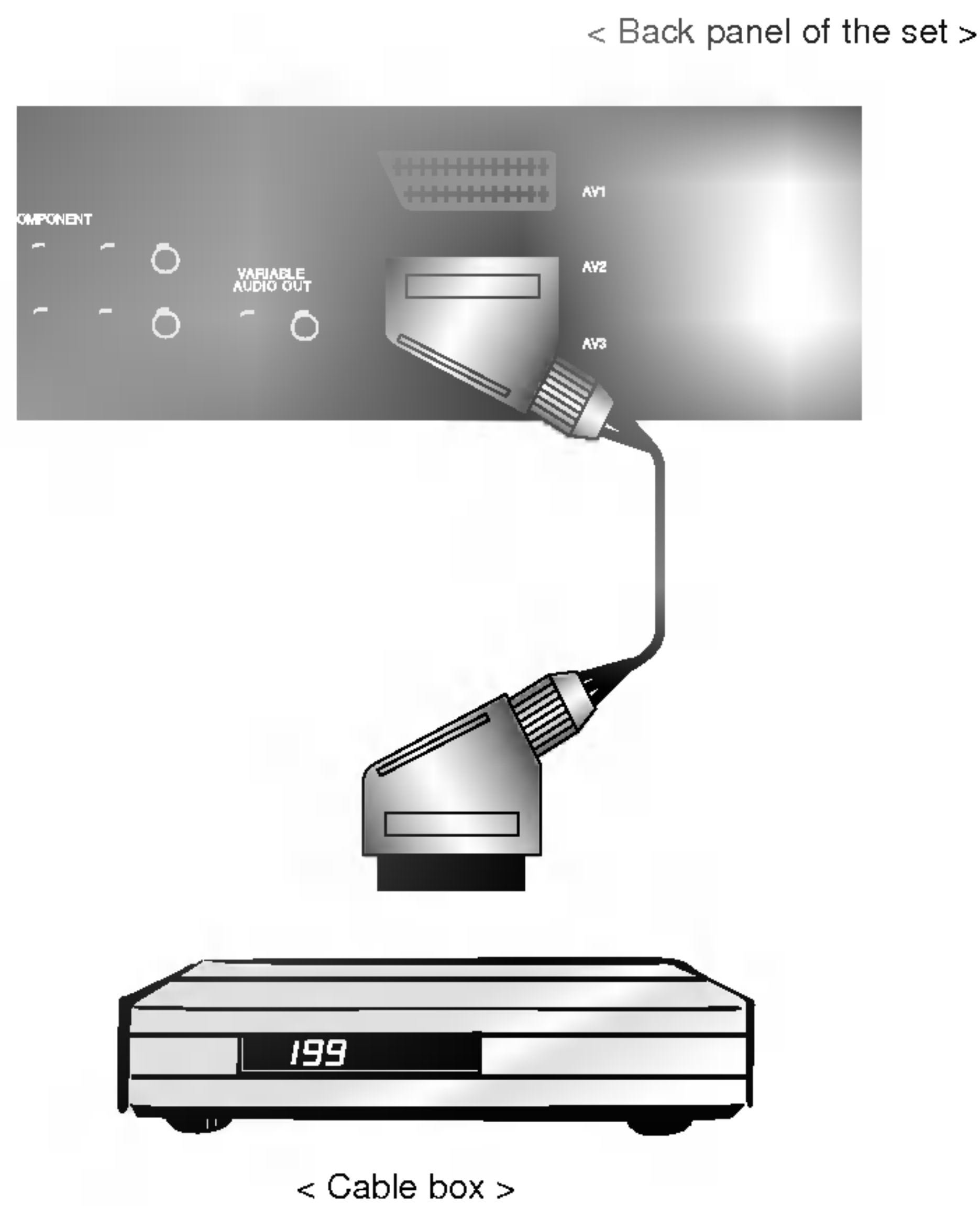

### To watch cable TV

1. Use the **INPUT** button on the remote control to select **AV1, AV2, S-Video2, AV3, AV4** or **AV5**.
- If both S-VIDEO and VIDEO sockets have been connected to the Cable box simultaneously, only the S-VIDEO can be received.
2. Select your desired channel with the remote control for cable box.

## Watching external AV source

- When connecting the set to an external source, match the colours of AUDIO/VIDEO input jacks on the set with the output jacks on the audio/video equipment: Video = yellow, Audio (Left) = white, Audio (Right) = red.  
Or, connect the Euro scart socket of the VCR to the Euro scart socket of the set.

### How to use

1. Use the **INPUT** button on the remote control to select **AV1, AV2, S-Video2, AV3, AV4** or **AV5**.
2. Operate the corresponding external equipment.  
See external equipment operating guide.

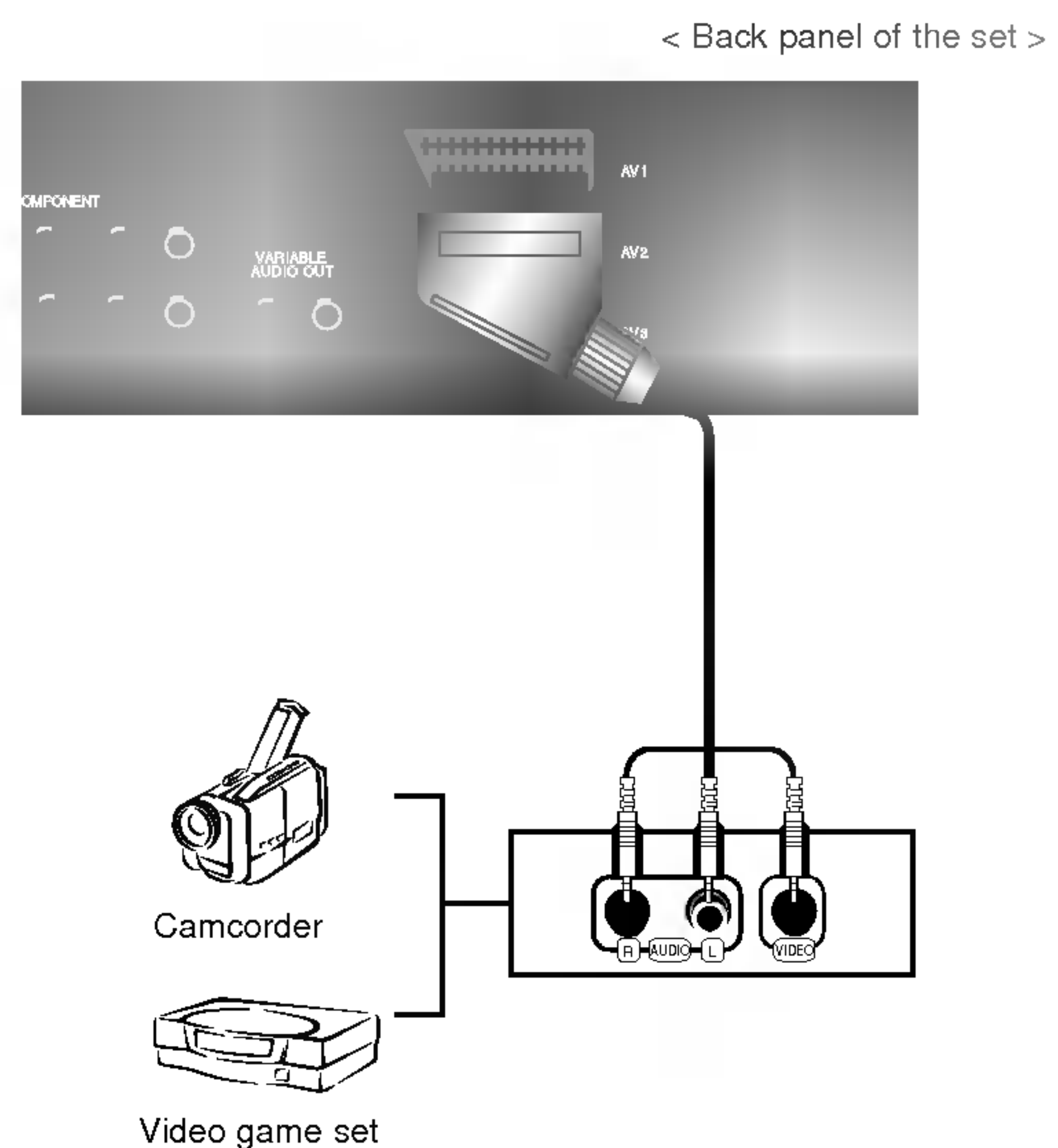



## Watching DVD

### How to connect

Connect DVD video outputs to Y, P<sub>B</sub>, P<sub>R</sub> of COMPONENT INPUT and audio outputs to Audio sockets of AUDIO INPUT.

### How to use

1. Turn on the DVD player, and insert a DVD.
2. Use **INPUT** or **MULTIMEDIA** button on the remote control to select **Component**.  
Refer to the DVD player's manual for operating instructions.

- **Component Input ports**

You can get better picture quality if you connect DVD player with component input ports as below.

Component ports of the set	Y	
Video output ports of DVD player	Y	Pb
	Y	B-Y
	Y	Cb
	Y	PB

< Back panel of the set >

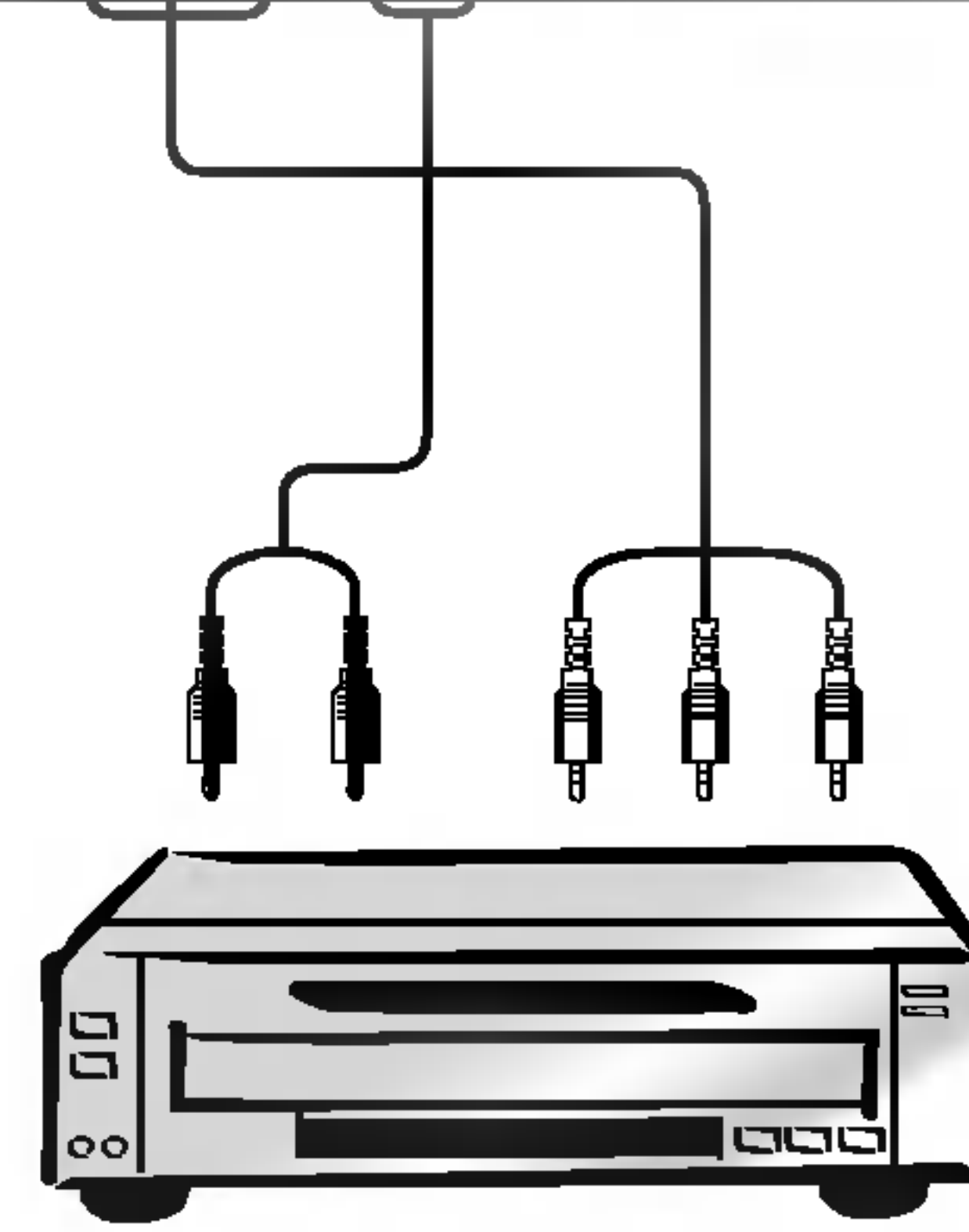
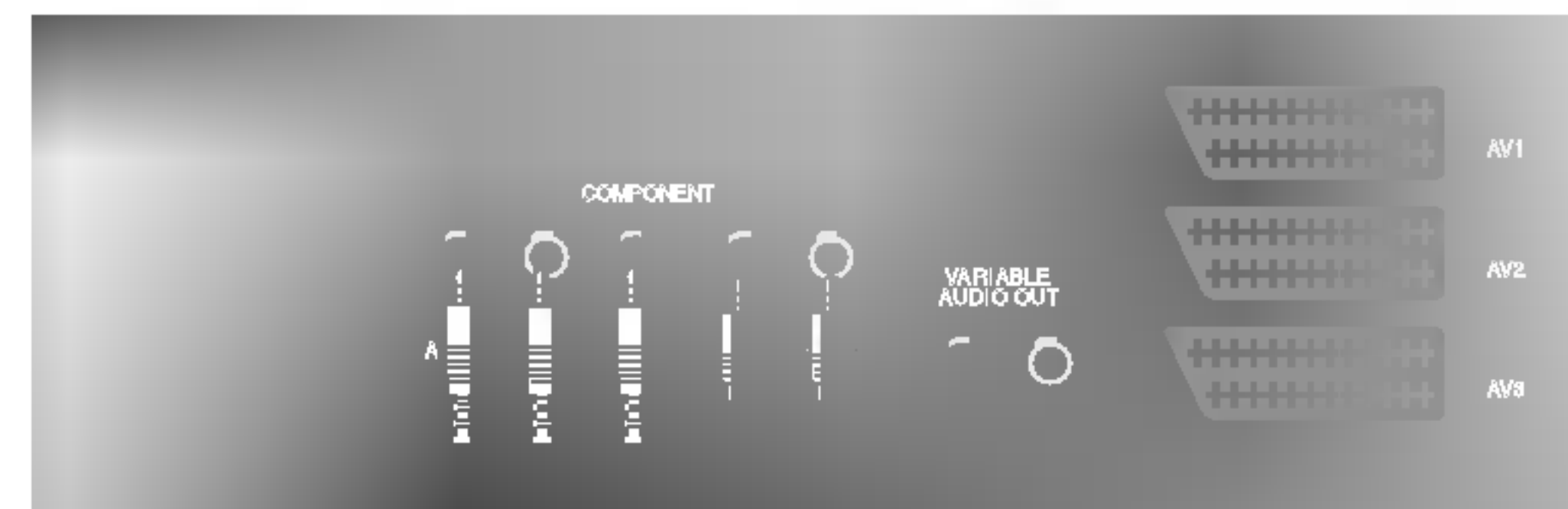

< DVD player >

# External Equipment Viewing Setups

## Connecting PC

- To enjoy vivid picture and sound, connect a PC to the set.
- Avoid keeping a fixed image on the set's screen for a long period of time. The fixed image may become permanently imprinted on the screen; use a screen saver when possible.
- Connect PC to the RGB INPUT(PC INPUT) or HDMI INPUT(DIGITAL RGB INPUT) port of the set; change the resolution output of PC accordingly.
- There might be noise according to some resolution, vertical pattern, contrast or brightness in PC mode. Change the PC mode into another resolution or change the refresh rate into another rate or adjust the brightness and contrast on the menu until the picture is clean. If the refresh rate of the PC graphic card can not be changed, change the PC graphic card or consult it to the manufacturer of the PC graphic card.
- The synchronization input waveform for Horizontal and Vertical frequencies are separate.

## Setup Instructions to Connect a PC to your set

- We recommend using 1024x768, 60Hz for the PC mode, they provide the best picture quality.  
In 42PX4RV series, we recommend using 640x480, 60Hz for the PC mode, they provide the best picture quality.
- If the resolution of PC is over UXGA, there will be no picture on the set.
- Connect the signal cable from the monitor output port of the PC to the RGB INPUT port of the set or the signal cable from the HDMI output port of the PC to the HDMI INPUT port on the set.
- Connect the audio cable from the PC to the Audio input on the set. (Audio cables are not included with the set).
- If using a sound card, adjust PC sound as required.
- This set uses a VESA Plug and Play Solution. The set provides EDID data to the PC system with a DDC protocol. The PC adjusts automatically to use this set.
- DDC protocol is preset for RGB (Analog RGB), HDMI (Digital RGB) mode.
- If required, adjust the settings for Plug and Play functionally.
- If graphics card on the PC does not output analog and digital RGB simultaneously, connect only one of RGB INPUT or HDMI INPUT to display the PC on the set.  
If graphic card on the PC does output analog and digital RGB simultaneously, set the set to either RGB or HDMI ; (the other mode is set to Plug and Play automatically by the set.)
- DOS mode may not work depending on video card if you use a HDMI to DVI cable.
- When you use too long RGB-PC cable, there might be a noise on the screen. We recommend using under 5m of the cable. It provides the best picture quality.

< Back panel of the set >

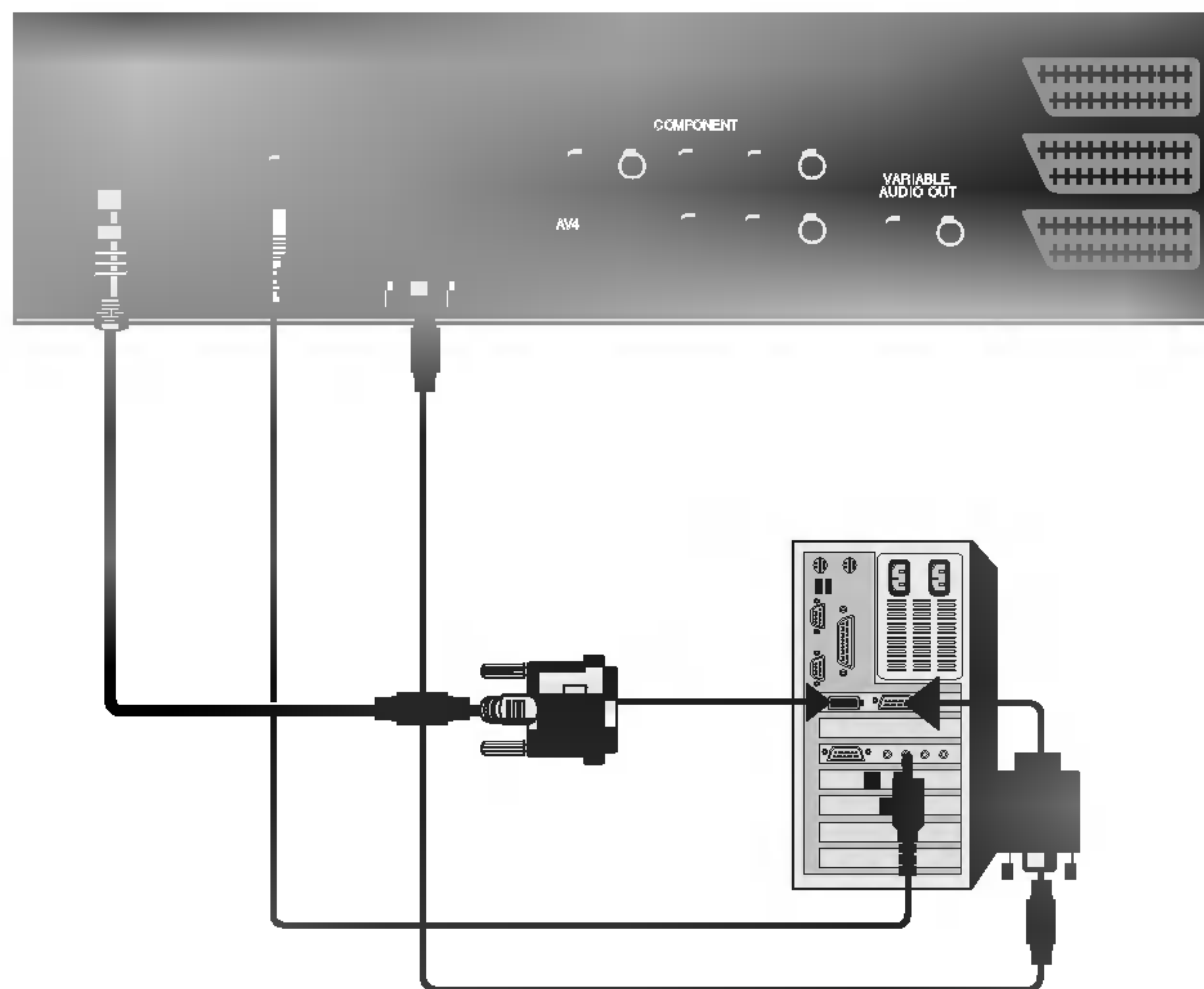

## PC Setup

1. Turn on the PC and apply power to the set.
2. Turn on the display by pressing the **POWER** button on the set's remote control.
3. Use the **INPUT** or **MULTIMEDIA** button on the remote control to select the **RGB** or **HDMI** input source.
4. Set the resolution output of the PC to SXGA or under (1280 x 1024, 60Hz). (Refer to p. 13)



# Displayable Monitor Specification

## RGB / HDMI mode

Resolution	Horizontal Frequency(KHz)	Vertical Frequency(Hz)
640x350	31.468	70.09
	37.861	85.08
720x400	31.469	70.08
	37.927	85.03
640x480	31.469	59.94
	35.000	66.66
	37.861	72.80
	37.500	75.00
848x480	43.269	85.00
	31.500	60.00
	37.799	70.00
	39.375	75.00
852x480	31.500	60.00
	37.799	70.00
	39.375	75.00
800x600	31.500	60.00
	37.799	70.00
	39.375	75.00
	35.156	56.25
	37.879	60.31
832x624	48.077	72.18
	46.875	75.00
	53.674	85.06
	49.725	74.55
1024x768	48.363	60.00
	56.476	70.06
	60.023	75.02
	68.677	85.00
1152x864	54.348	60.05
	63.995	70.01
	67.500	75.00
1152x870	68.681	75.06
1280x960	60.023	60.02
1280x1024	63.981	60.02

### 42PX4RV series

## RGB / HDMI mode

Resolution	Horizontal Frequency(KHz)	Vertical Frequency(Hz)
640x350	31.468	70.09
	37.861	85.08
720x400	31.469	70.08
	37.927	85.03
640x480	31.469	59.94
	35.000	66.66
	37.861	72.80
	37.500	75.00
848x480	43.269	85.00
	31.500	60.00
	37.799	70.00
	39.375	75.00
852x480	31.500	60.00
	37.799	70.00
	39.375	75.00
800x600	31.500	60.00
	37.799	70.00
	39.375	75.00
	35.156	56.25 (RGB)
	37.879	60.31
832x624	48.077	72.18
	46.875	75.00
	53.674	85.06
	49.725	74.55
1024x768	48.363	60.00
	56.476	70.06
	60.023	75.02
	68.677	85.00
1360x768	47.700	60.00
	59.625	75.02
	68.500	85.00
1366x768	47.700	60.00
	59.625	75.02
	69.500	85.00
1152x864	54.348	60.05
	63.995	70.01
	67.500	75.00
	77.487	85.00
1152x870	68.681	75.06
1280x768	47.693	60.00
	60.091	75.00
	68.504	85.00
1280x960	60.023	60.02
1280x1024	63.981	60.02

### 42PX4R series 50PX4R series



- HDMI™, the HDMI logo and High-Definition Multimedia Interface are trademarks or registered trademarks of HDMI Licensing.
- This set can receive the High-Definition Multimedia Interface (HDMI) or Input of Digital Visual Interface(DVI).
- This set supports HDCP (High-bandwidth Digital Contents Protection) Protocol for the set (480p, 720p, 1080i) modes.
- When you connect to HDMI/DVI Source devices (DVD Player, STB or PC) that support AUTO HDMI/DVI Plug & Play, this sets the HDMI/DVI source devices automatically. (1280 x 720p) (or 42PX4RV series : 640 x 480p).  
After reading HDMI/DVI source devices, using Display Data Channel (DDC) Protocol, Extended Display Identification Data (EDID) stored in the set is used.  
If HDMI/DVI Source devices do not support AUTO HDMI/DVI, the resolution is set manually.
- To get the best picture quality, adjust the DVD Player or Set Top Box output resolution to 1280 x 720p (or 42PX4RV series : 640 x 480p).
- To get the best picture quality, adjust the PC graphics card to 1024 x 768 (or 42PX4RV series : 640 x 480), 60Hz.
- When Source Devices have DVI Output Connector, you must connect audio with separated cable.(Refer to <How to connect>)

### How to connect

1. When Source Devices (DVD Player or Set Top Box) support HDMI.
  - If Source Devices have HDMI Output Connector, Source Devices connect to the set with HDMI Cable .(not supplied with the product).
  - If Source Devices support Auto HDMI, automatically, Source Devices divert output resolution in 1280 x 720p (or 42PX4RV series : 640 x 480p). But if not, resolution divert Manually Setting for reference Manual of Source Devices.
  - To get the best picture quality, adjust the DVD Player or Set Top Box output resolution to 1280 x 720p (or 42PX4RV series : 640 x 480p).
  - Because HDMI sends Digital Video and Audio with one cable, there is no need for Audio Cable when using HDMI Cable.
2. When Source Devices (DVD Player or Set Top Box) supports DVI.
  - If Source Devices have DVI Output Connector, Source Devices connect to the set with HDMI to DVI Cable (not supplied with the product).
  - If Source Devices support Auto DVI, automatically, Source Devices divert output resolution in 1280 x 720p (or 42PX4RV series : 640 x 480p). But if not, resolution divert Manually Setting for reference Manual of Source Devices.
  - To get the best picture quality, adjust the DVD Player or Set Top Box output resolution to 1280 x 720p (or 42PX4RV series : 640 x 480p).
  - In this case, Audio use other cable. When Source Devices have Analog Audio Output Connector, RGB/DVI Audio Input of the set connect to Audio Cable (not supplied with the product). And then you can listen to normal Audio.
3. When PC supports DVI.
  - If PC has a DVI Output Connector, Source Devices connect to the set with HDMI to DVI Cable (not supplied with the product).
  - To get the best picture quality, adjust the PC graphics card to 1024 x 768 (or 42PX4RV series : 640 x 480), 60Hz.
  - Use the the set's HDMI/DVI (VIDEO) for video connections, depending on your PC connector.
  - If the graphics card on the PC does not output analog RGB and DVI simultaneously, connect only one of either RGB Input or HDMI/DVI Input to display the PC on the set.
  - If the graphics card on the PC does output analog RGB and DVI simultaneously, the set to either RGB Input or HDMI/DVI Input; (the other mode is set to Plug and Play automatically by the set.)
  - Then, make the corresponding audio connections. If using a sound card, adjust the PC sound as required.
  - In this case, Audio use other cable. When PC (or sound card of PC) have Analog Audio Output Connector, RGB/DVI Audio Input of the set connect to Analog Audio Cable (not supplied with the product). And then you can listen to normal Audio.



## Reference

### Cable sample

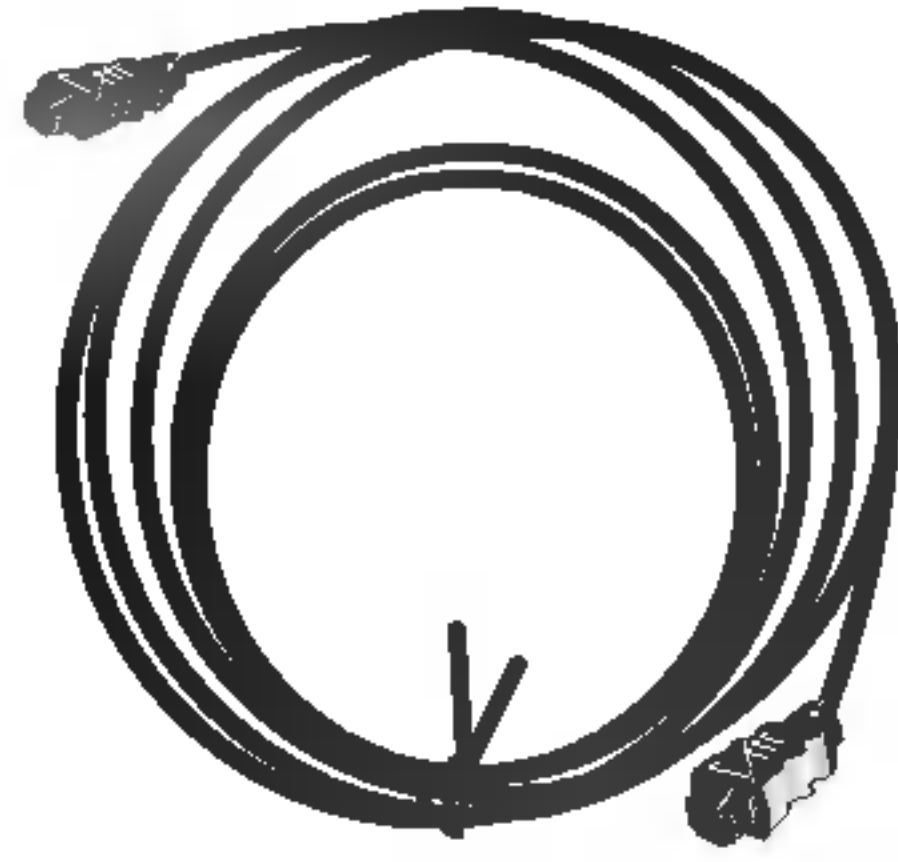

HDMI Cable  
(not supplied with the product)

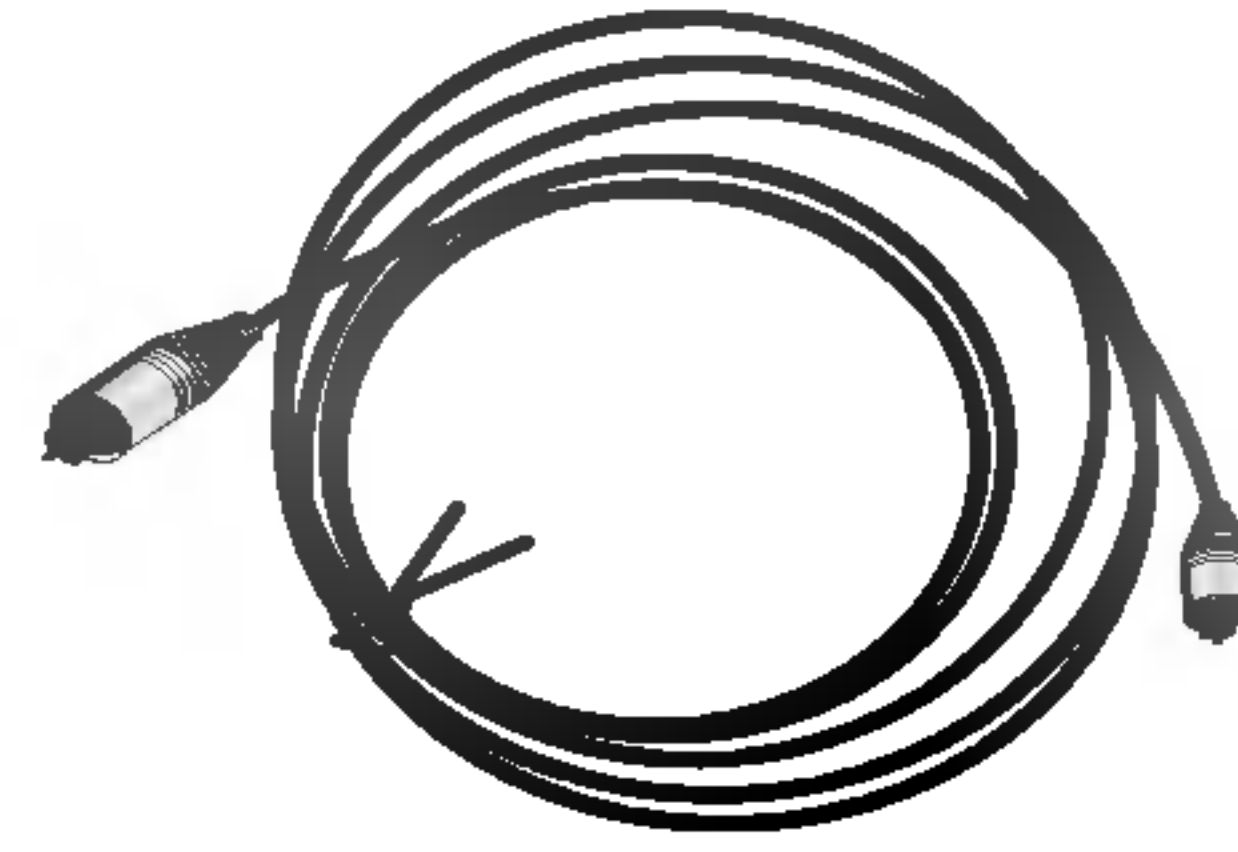

Analog Audio Cable (RCA type)  
(not supplied with the product)

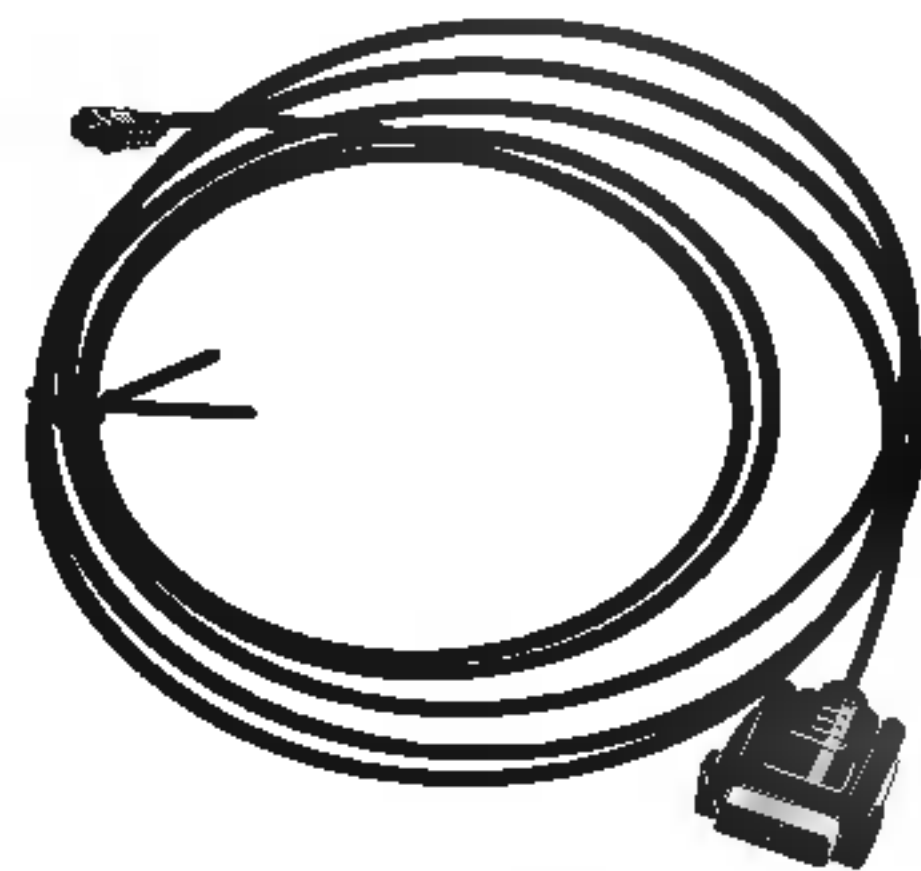

HDMI to DVI Cable  
(not supplied with the product)



Analog Audio Cable (Stereo to RCA type)  
(not supplied with the product)

### How to use

1. Connect the HDMI/DVI Source Devices(DVD Player or Set Top Box or PC) and the set.
2. Turn on the display by pressing the POWER button on the set and HDMI/DVI Source Devices remote control.
3. Select HDMI/DVI Input source in Main Input option of PIP/DW menu.
4. Check the image on your set. There may be noise associated with the resolution, vertical pattern, contrast or brightness in HDMI/DVI Source Devices. If noise is present, change the HDMI/DVI Source Devices to another resolution, change the refresh rate or adjust the brightness and contrast on the menu until the picture is clear. If the refresh rate of the PC graphics card can not be changed, change the PC graphics card or consult the manufacturer of the PC graphics card.

### Notes:

- Depending on the graphics card, DOS mode may not work if you use a HDMI to DVI Cable.
- Avoid keeping a fixed image on the set screen for a long period of time. The fixed image may become permanently imprinted on the screen. Use the Orbiter screen saver when possible.
- When Source Devices connected HDMI/DVI Input, output PC Resolution(VGA, SVGA, XGA), Position, Size may not fit to Screen. As shown the lower picture, press the **MENU** button to adjust the screen Position of the set and contact a PC graphics card service center.
- When Source Devices connected HDMI/DVI Input output the set Resolution(480p, 720p, 1080i), the set Display fit EIA/CEA-861-B Specification to Screen. If not, refer to the Manual of HDMI/DVI Source Devices or contact your service center.
- In case of HDMI/DVI Source Devices are not connected, Cable or poor cable connection, "No Signal" OSD display in HDMI/DVI Input. And In case of Video Resolution not supported when output is HDMI/DVI Source Devices, "No Signal" OSD display. Refer to the Manual of HDMI/DVI Source Devices or contact your service center.

# Accessories



Owner's Manual



Remote Control handset



2-Eye Bolts

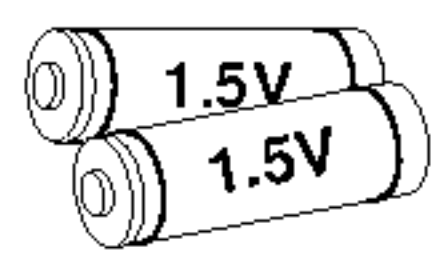

Alkaline batteries



Power Cord



2-Wall brackets

## Fixing the set assembly to the wall to protect the set tumbling

- Secure the set assembly by fixing it to a wall by using the Eye Bolts/Wall brackets.

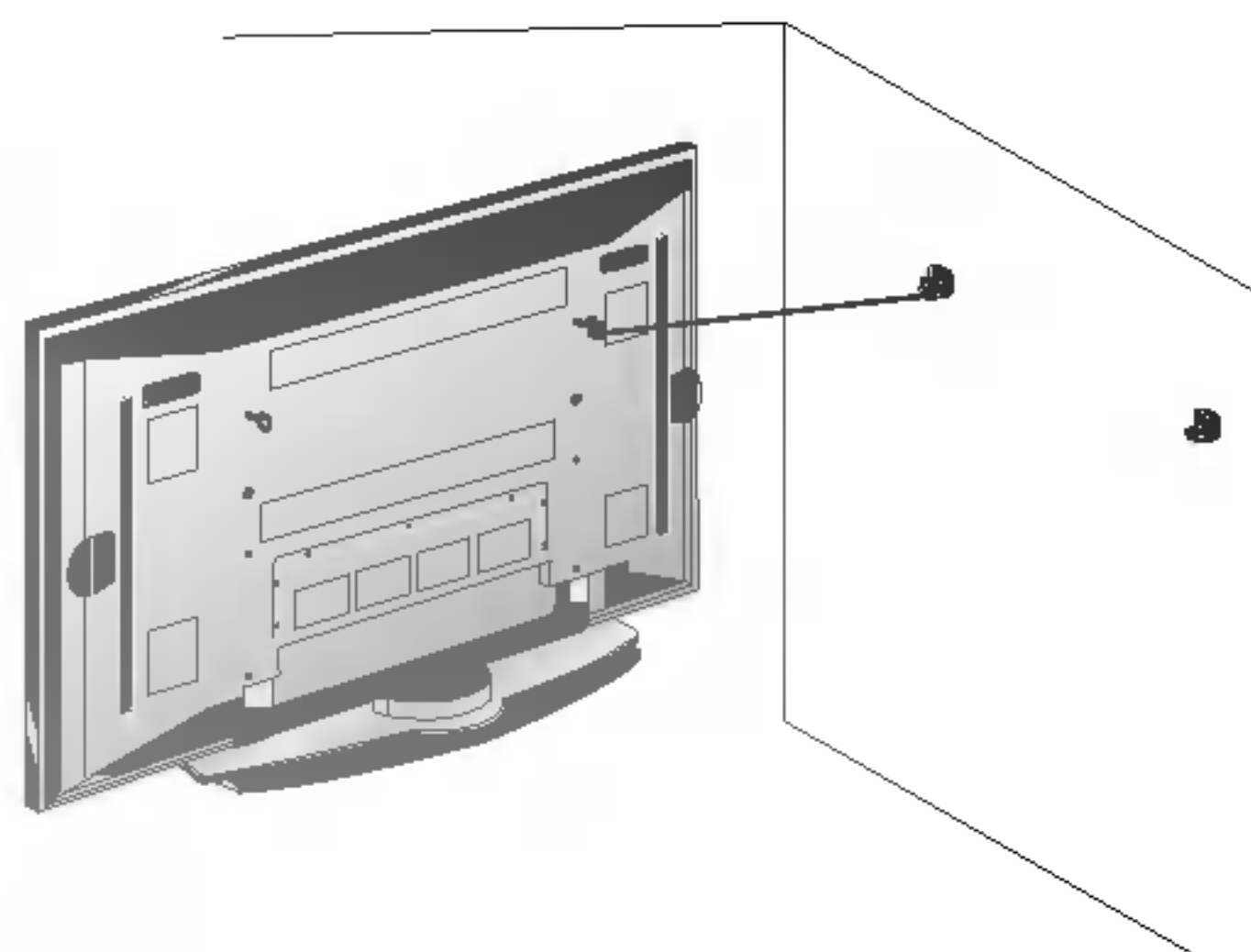

- If the set is mounted on a desk top, insert the 2 Eye-Bolts and tighten them securely in the upper holes as shown. Insert the 2 Eye Bolts and tighten securely, in the holes on the bracket. Install the wall brackets on the wall with 2 bolts, (not supplied with the product), as shown. Match the height of the Eye Bolts and the wall brackets. Check to be sure the brackets are tightened securely.

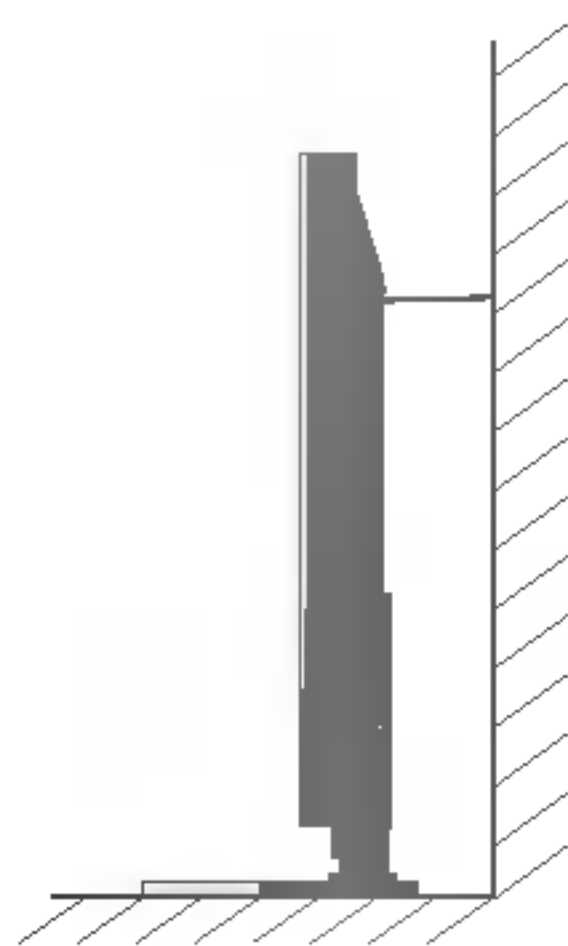

- Secure the set assembly to the wall with strong strings or wound wire cables, (not supplied with the product), as shown.

## Optional Extras

- Optional extras can be changed or modified for quality improvement. Without any notification new optional extras can be added.
- Contract your dealer for buying these items.

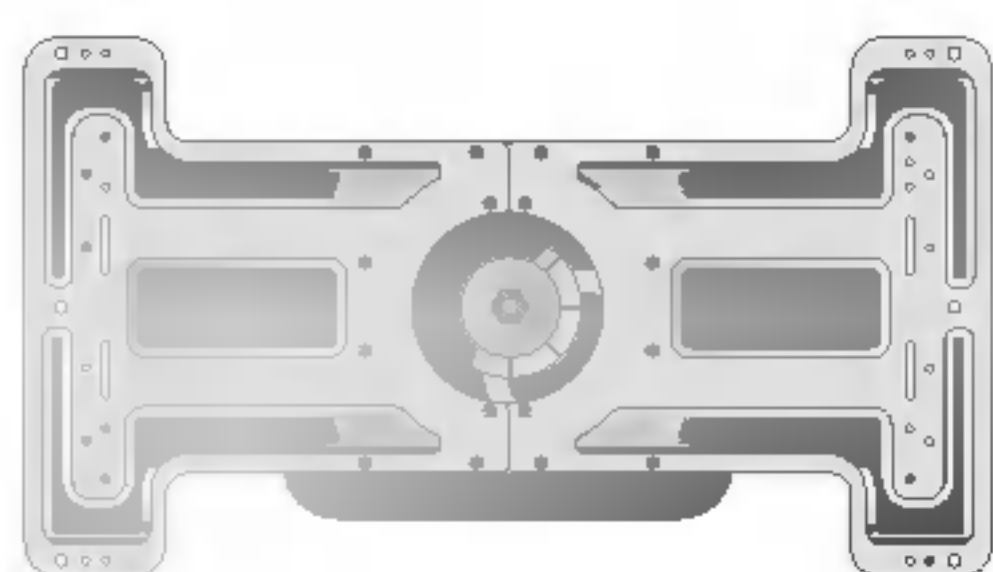

Tilt wall mounting bracket

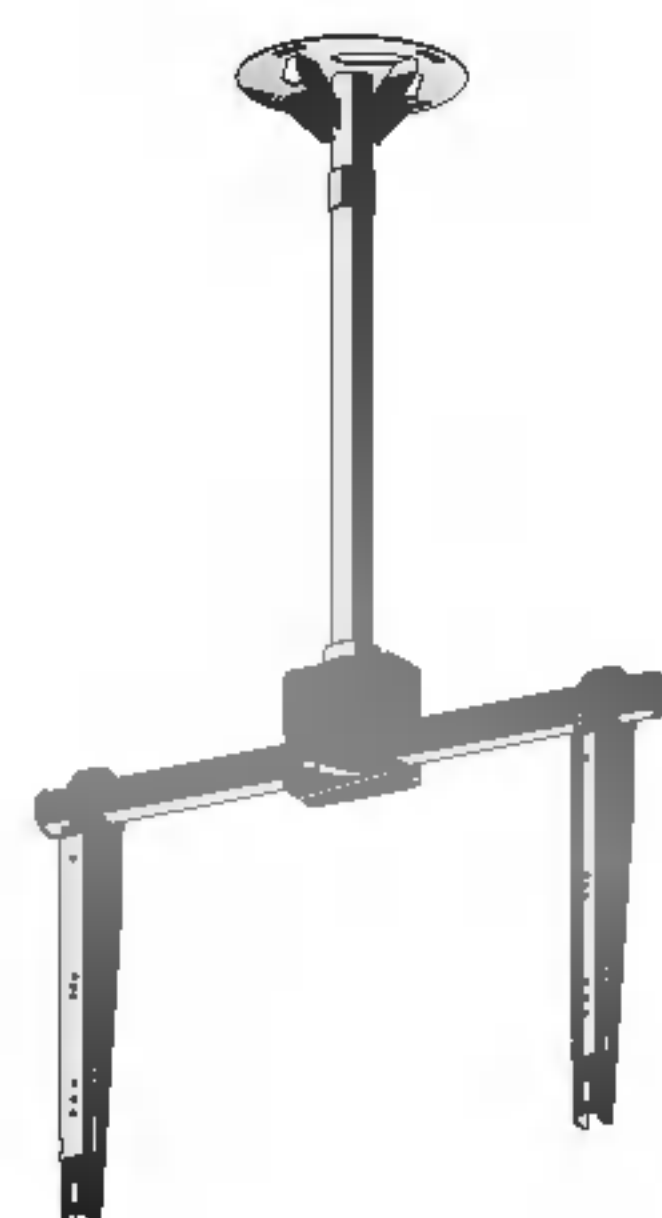

Ceiling mounting bracket

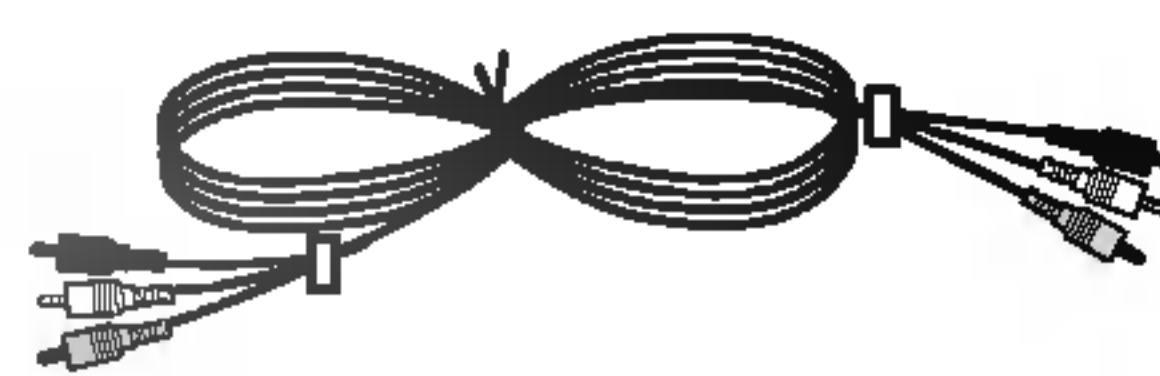

Video cables

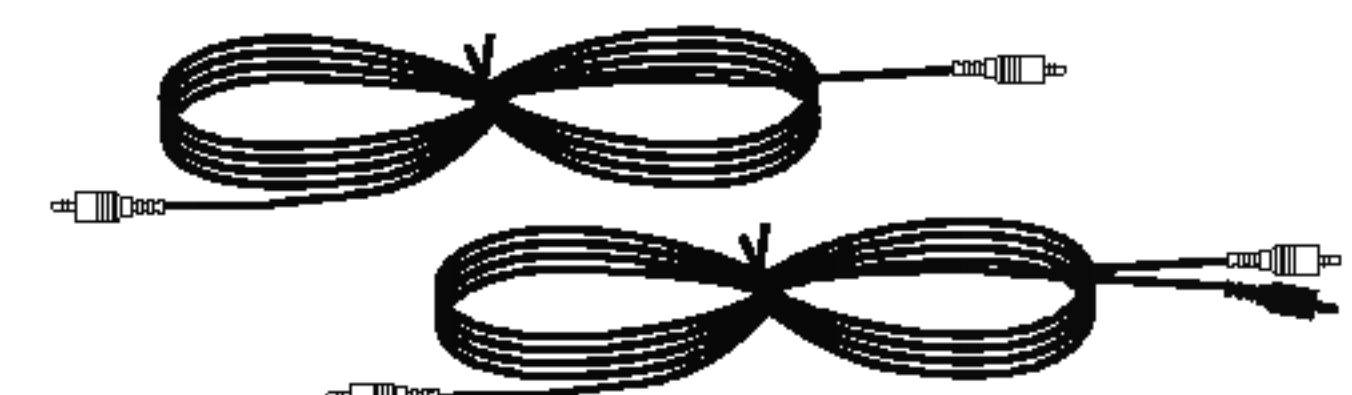

Audio cables



# Installation Options

- The set can be installed in different ways such as on a wall, or on a desktop etc.
- Install this set only in a location where adequate ventilation is available.

## Wall Mount: Horizontal Installation

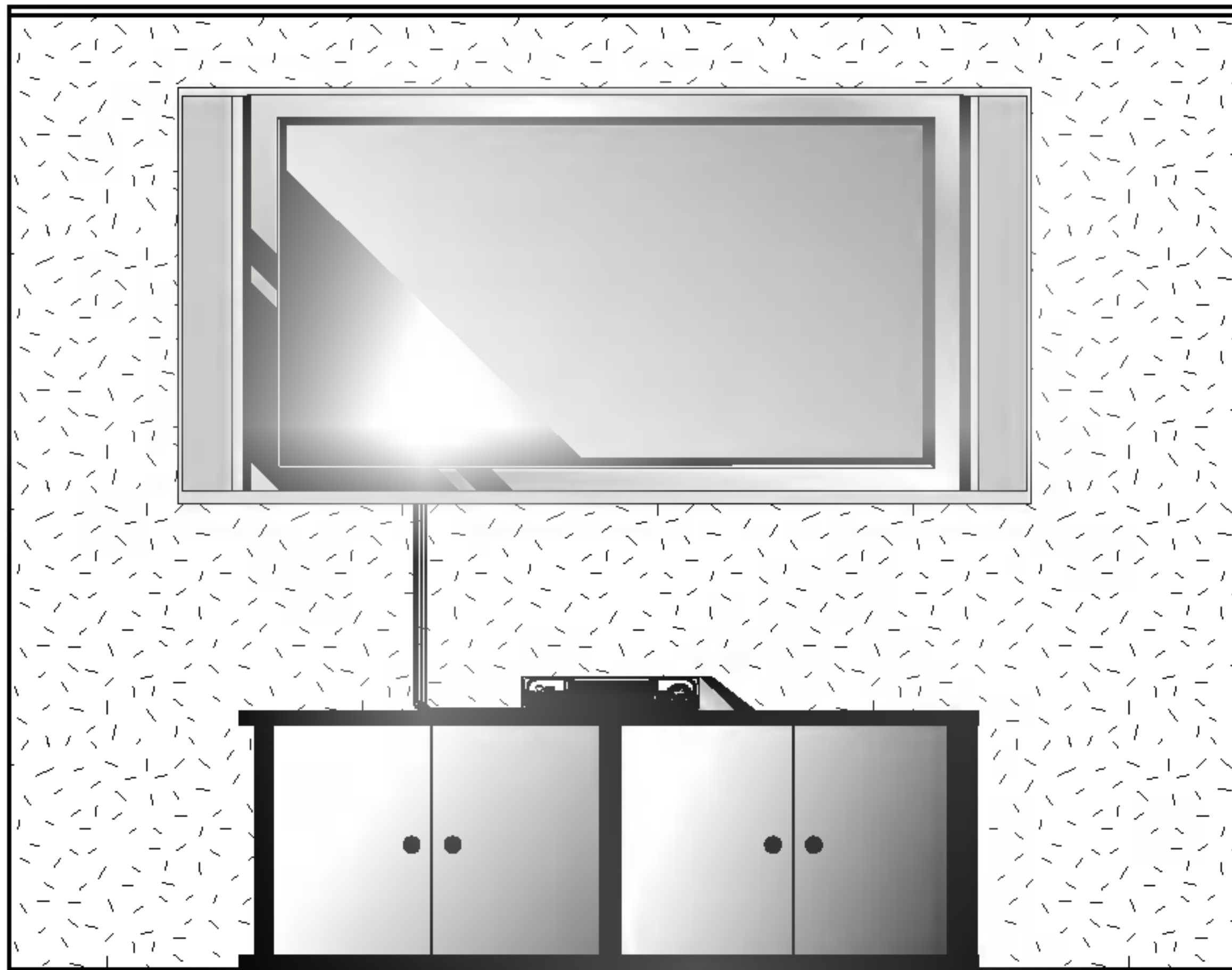

- The set can be installed on a wall as shown above. (For further information, refer to the optional 'Wall Mounting Bracket Installation and Setup Guide'.)

### To Mount on a Wall

Wall mount minimum allowable clearances for adequate ventilation.

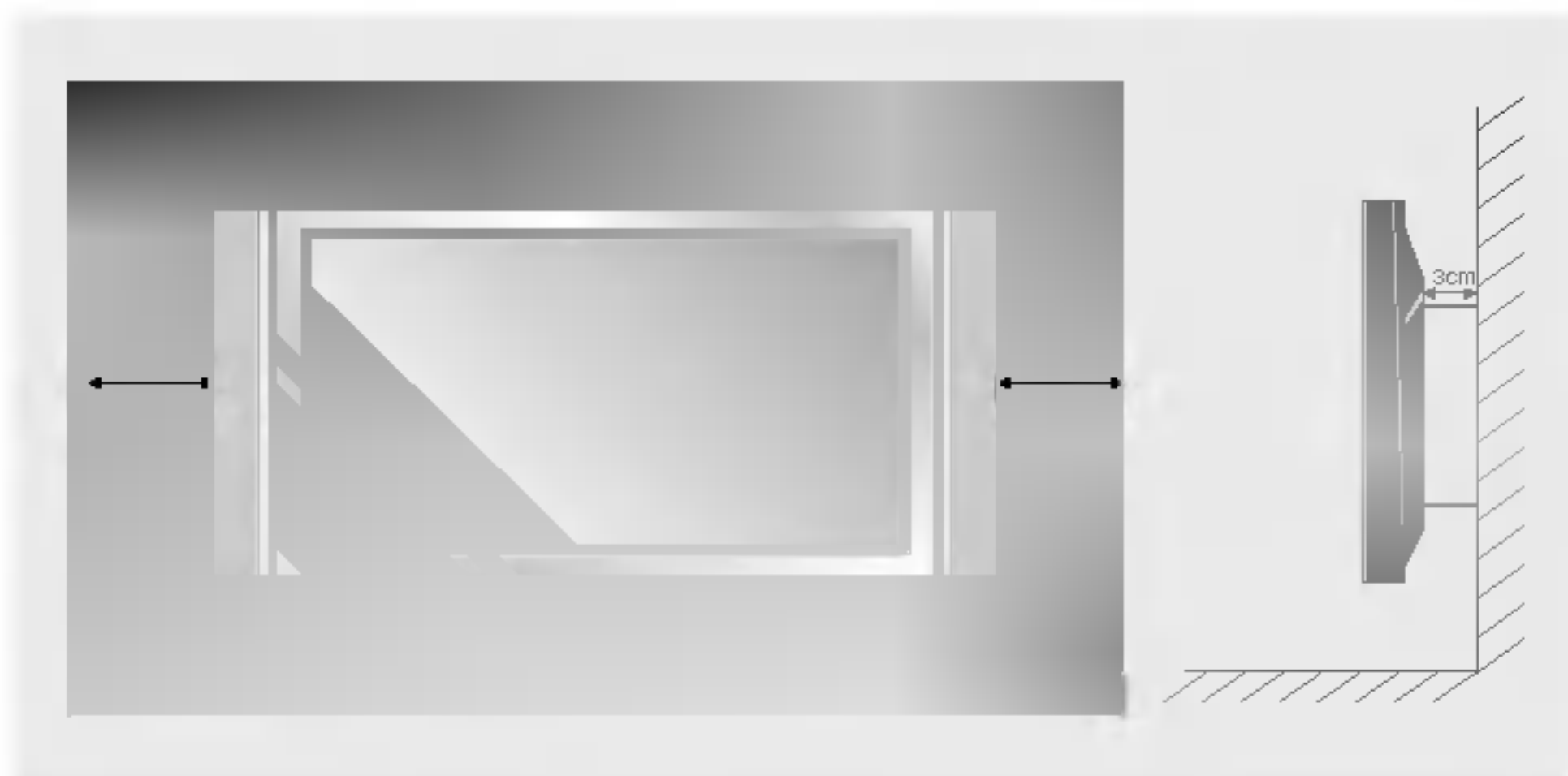

## Desktop Pedestal Installation



- The set can be mounted on a desk as shown above.

### To Install on a Desktop

Pedestal mount minimum allowable clearances for adequate ventilation.

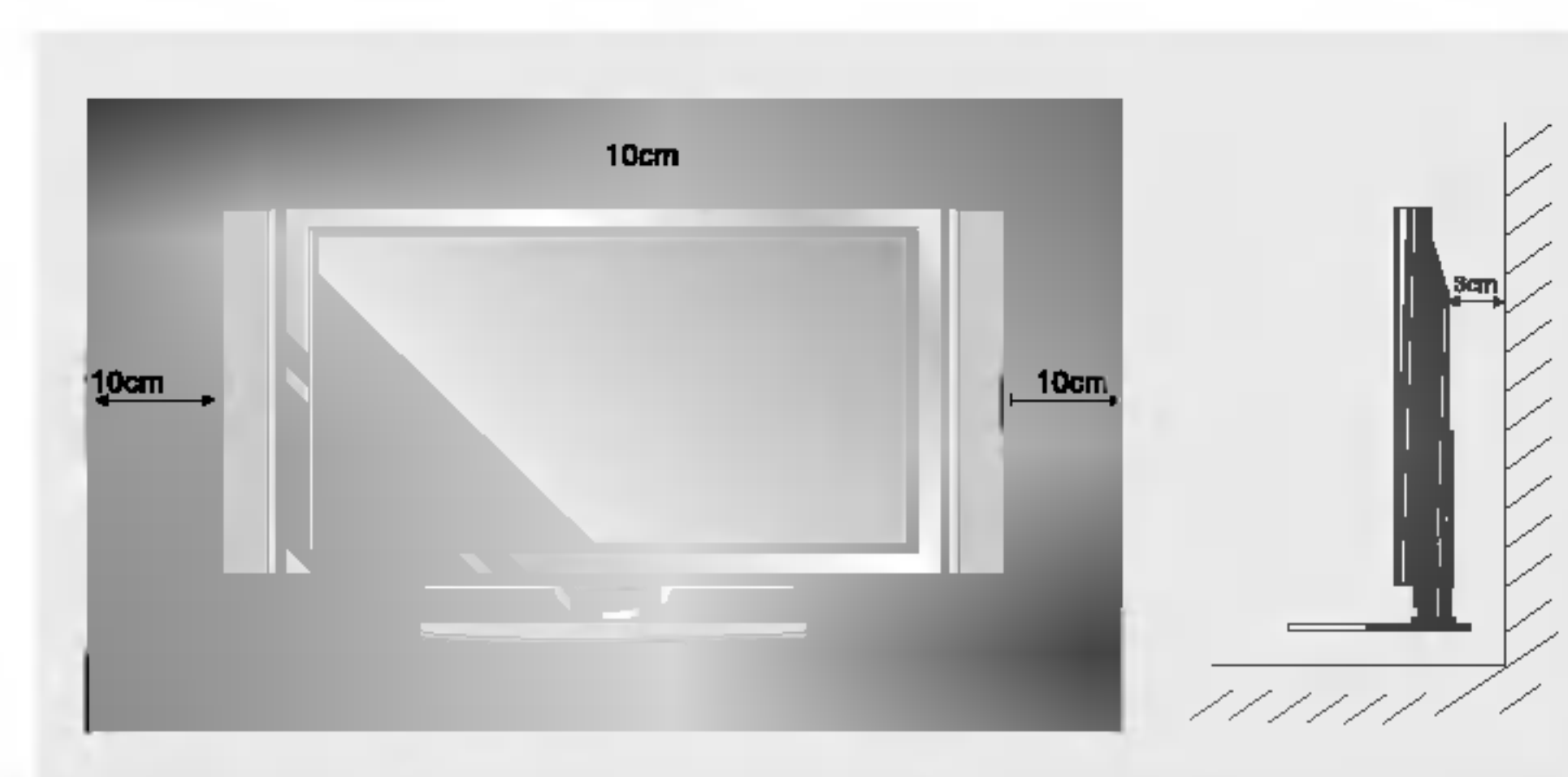

## Swivel function (option)

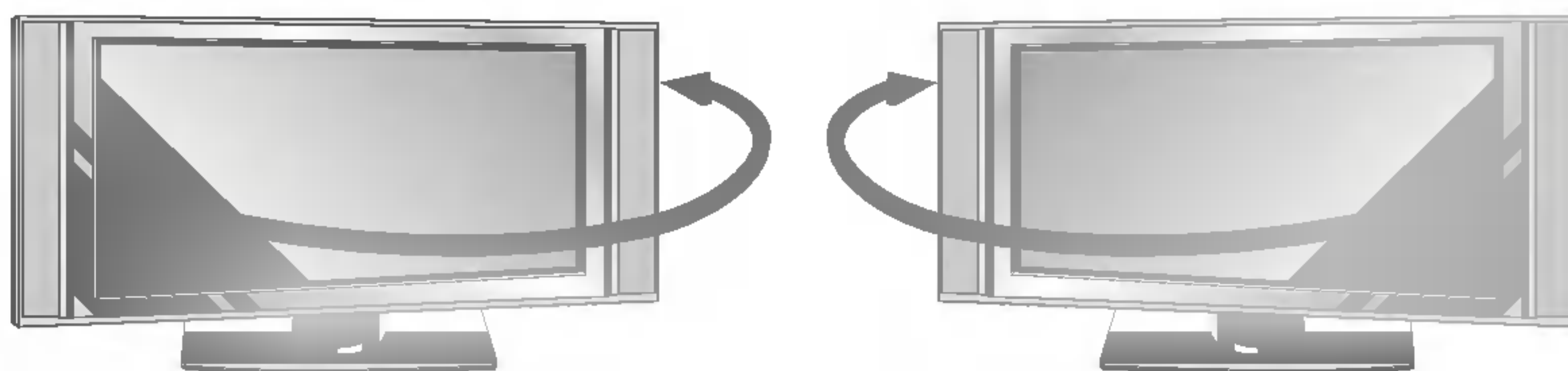

- After installing the set, you can adjust the the set manually to the left or right direction by 20 degrees to suit your viewing position.

**Note :** Before adjusting the angle, you must loosen (to the left) the shaft bolt on the middle of stand's back. And when stand be level with set, you must close (to the right) the shaft bolt to set the hole.

## Turning on the Set

- When using the remote control, aim it at its sensor on the set.



1. Connect power cord correctly, the set is switched to standby mode.
2. Press the  $\odot$  / I, **INPUT** or **PR**  $\blacktriangle$  /  $\blacktriangledown$  button on the set or press the **POWER**, **INPUT**, **MULTIMEDIA**, **PR**  $\blacktriangle$  /  $\blacktriangledown$  or **NUMBER** buttons on the remote control and then the set will switch on.



**If the set was turned off with the remote control power button and the  $\odot$  / I button on the set**

- Press the  $\odot$  / I, **INPUT** or **PR**  $\blacktriangle$  /  $\blacktriangledown$  button on the set or press the **POWER**, **INPUT**, **MULTIMEDIA**, **PR**  $\blacktriangle$  /  $\blacktriangledown$  or **NUMBER** button on the remote control to turn the set on.

## On-Screen Menu Language Selection (option)

- The menus can be shown on the screen in the selected language. First select your language.
  1. Press the **MENU** button and then use  $\blacktriangle$  /  $\blacktriangledown$  button to select the **SPECIAL** menu.
  2. Press the  $\blacktriangleright$  button and then use  $\blacktriangle$  /  $\blacktriangledown$  button to select **Language**.
  3. Press the  $\blacktriangleright$  button and then use  $\blacktriangle$  /  $\blacktriangledown$  button to select your desired language.  
From this point on, the on-screen menus will be shown in the language of your choice.
  4. Press the **EXIT** button to return to normal TV viewing.



# Channel Menu Options

## Auto Programme Tuning

- All stations that can be received are stored by this method. It is recommended that you use auto programme during installation of this set.

1. Press the **MENU** button and then use **▲ / ▼** button to select the **STATION** menu.
2. Press the **▶** button and then **▲ / ▼** button to select **Auto programme**.
3. Press the **▶** button to select **System**. Select a TV system with the **◀ / ▶** button;
  - L** : SECAM L/L' (option)
  - BG** : PAL B/G, SECAM B/G (Europe / East Europe / Asia / New Zealand / M.East / Africa / Australia)
  - I** : PAL I/II (U.K. / Ireland / Hong Kong / South Africa)
  - DK** : PAL D/K, SECAM D/K (East Europe / China / Africa / CIS)
  - M** : (USA / Korea / Philippines) (option)
4. Press the **▼** button to select **Storage from**. Select the beginning programme number with the **◀ / ▶** button or **NUMBER** buttons on the **Storage from** menu.
5. Press the **▼** button to select **Start**.
6. Press the **▶** button to begin auto programming.  
All receivable stations are stored.

**Note** : In some models, the station name is stored for stations which broadcast VPS (Video Programme Service), PDC (Programme Delivery Control) or TELETEXT data. If no station name can be assigned to a station, the channel number is assigned and stored as **C** (V/UHF 01-69) or **S** (Cable 01-47), followed by a number.

To stop auto programming, press the **MENU** button.

When auto programming is completed, the **Programme edit** menu appears on the screen. See the 'Programme edit' section to edit the stored programme.

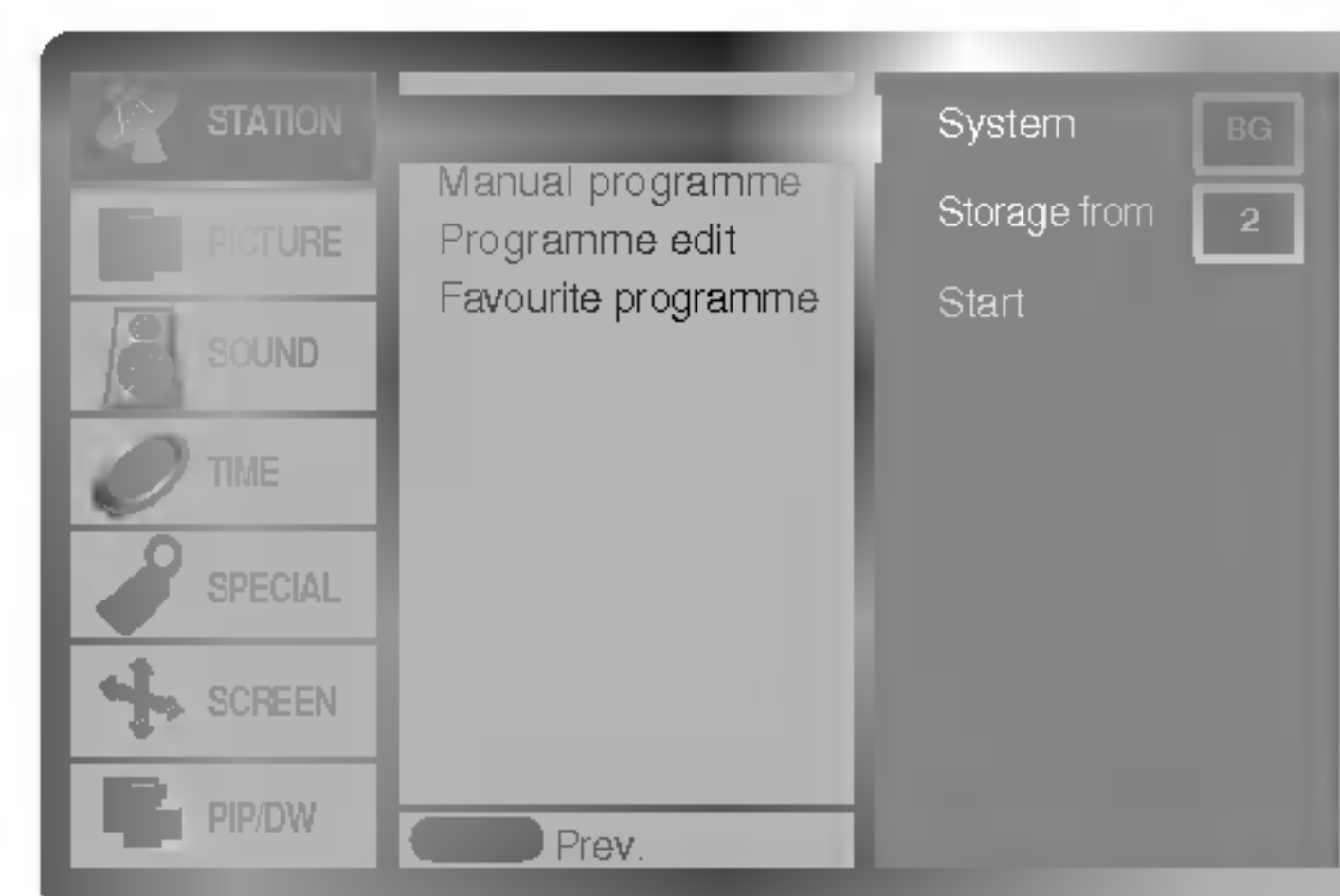

## Manual Programme Tuning

- Manual programme lets you manually tune and arrange the stations in whatever order you desire. Also you can assign a station name with five characters to each programme number.

1. Press the **MENU** button and then use **▲ / ▼** button to select the **STATION** menu.
2. Press the **▶** button and then **▲ / ▼** button to select **Manual programme**.
3. Press the **▶** button to select **Storage**. Select the desired programme number with the **◀ / ▶** button or **NUMBER** buttons on the **Storage** menu.
4. Press the **▼** button to select **System**. Select a TV system with the **◀ / ▶** button;
  - L** : SECAM L/L' (option)
  - BG** : PAL B/G, SECAM B/G (Europe / East Europe / Asia / New Zealand / M.East / Africa / Australia)
  - I** : PAL I/II (U.K. / Ireland / Hong Kong / South Africa)
  - DK** : PAL D/K, SECAM D/K (East Europe / China / Africa / CIS)
  - M** : (USA / Korea / Philippines) (option)
5. Press the **▼** button to select **Band**. Press the **◀ / ▶** button to select **V/UHF** or **Cable** as required.
6. Press the **▼** button to select **Channel**. You can select the desired channel number with the **◀ / ▶** button or **NUMBER** buttons. If possible, select the channel number directly with the number buttons.
7. Press the **▼** button to select **Search**. Press the **◀ / ▶** button to commence searching. If a station is found the search will stop.
8. Press the **OK** button to store it.
9. To store another station, repeat steps 3 to 8.

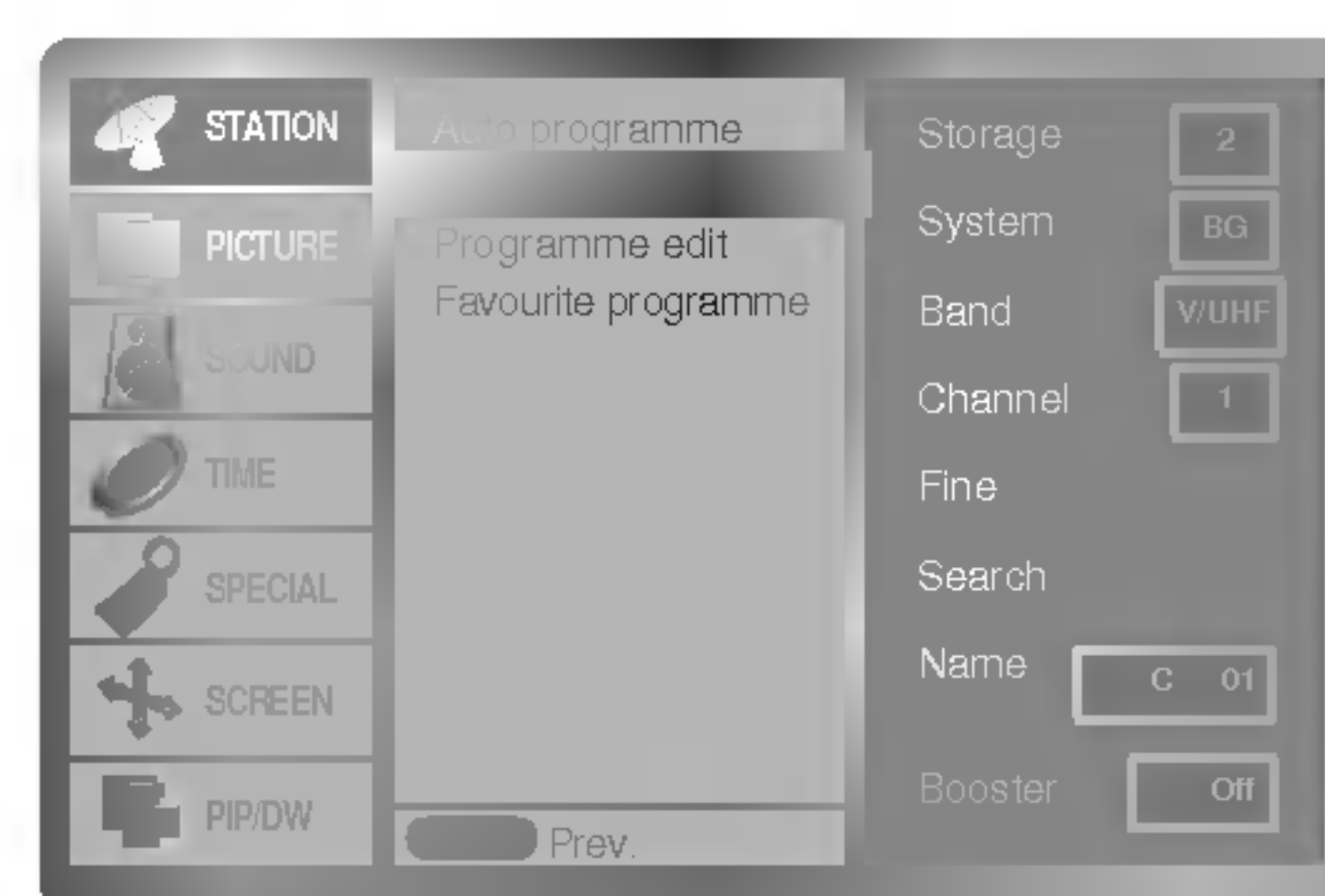

# Channel Menu Options

## Fine Tuning

- Normally fine tuning is only necessary if reception is poor.
  1. Repeat the 'Manual programme tuning' steps 1 to 2.
  2. Press the ► button and then ▲ / ▼ button to select **Fine**.
  3. Press the ◀ / ▶ button to fine tune for the best picture and sound.
  4. Press the **OK** button.  
The finely tuned programme will be indicated by a yellow number during programme selection.
  5. Press the **EXIT** button to return to normal TV viewing.



## Assigning a Station Name

1. Repeat the 'Manual programme tuning' steps 1 to 2.
2. Press the ► button and then ▲ / ▼ button to select **Name**.
3. Press the ► button to display the **Name** menu.
4. Press the ▲ button. You can use a blank, +, -, the alphabet **A** to **Z** and the numeric **0** to **9**.  
With the ▼ button you can select in the opposite direction.
5. Select the next position by pressing the ► button and then make your choice of the second character, and so on.
6. Press the **OK** button in twice.
7. Press the **EXIT** button to return to normal TV viewing.

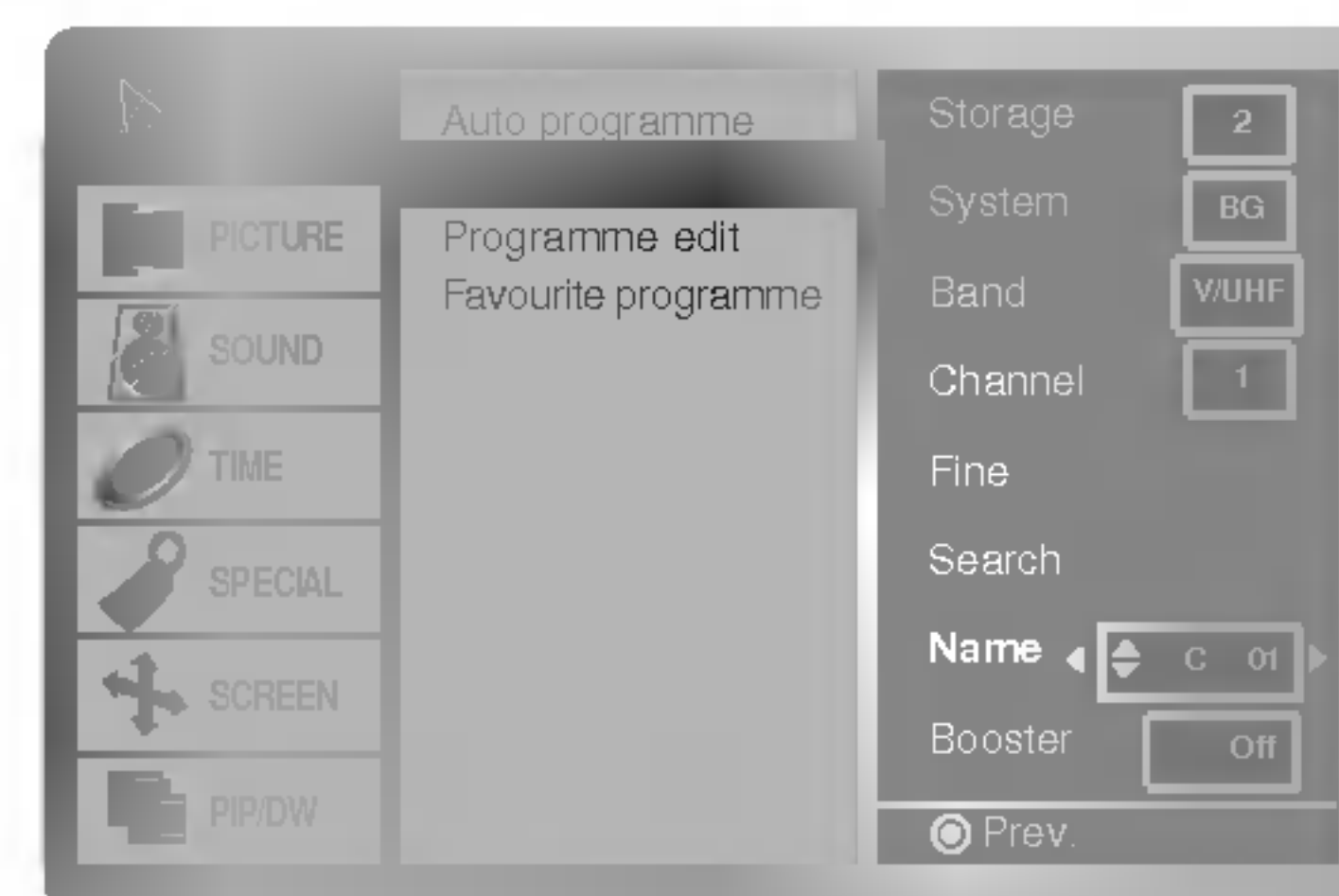

## Booster (option)

In some models, **Booster** is an optional function. Only a set with **Booster** can perform this function. If the reception is poor at the fringe area of TV signal, select **Booster** to **On**.

1. Repeat the 'Manual programme tuning' steps 1 to 2.
2. Press the ► button and then ▲ / ▼ button to select **Booster**.
3. Press the ◀ / ▶ button to select **On** or **Off**.
4. Press the **OK** button.
5. Press the **EXIT** button to return to normal TV viewing.

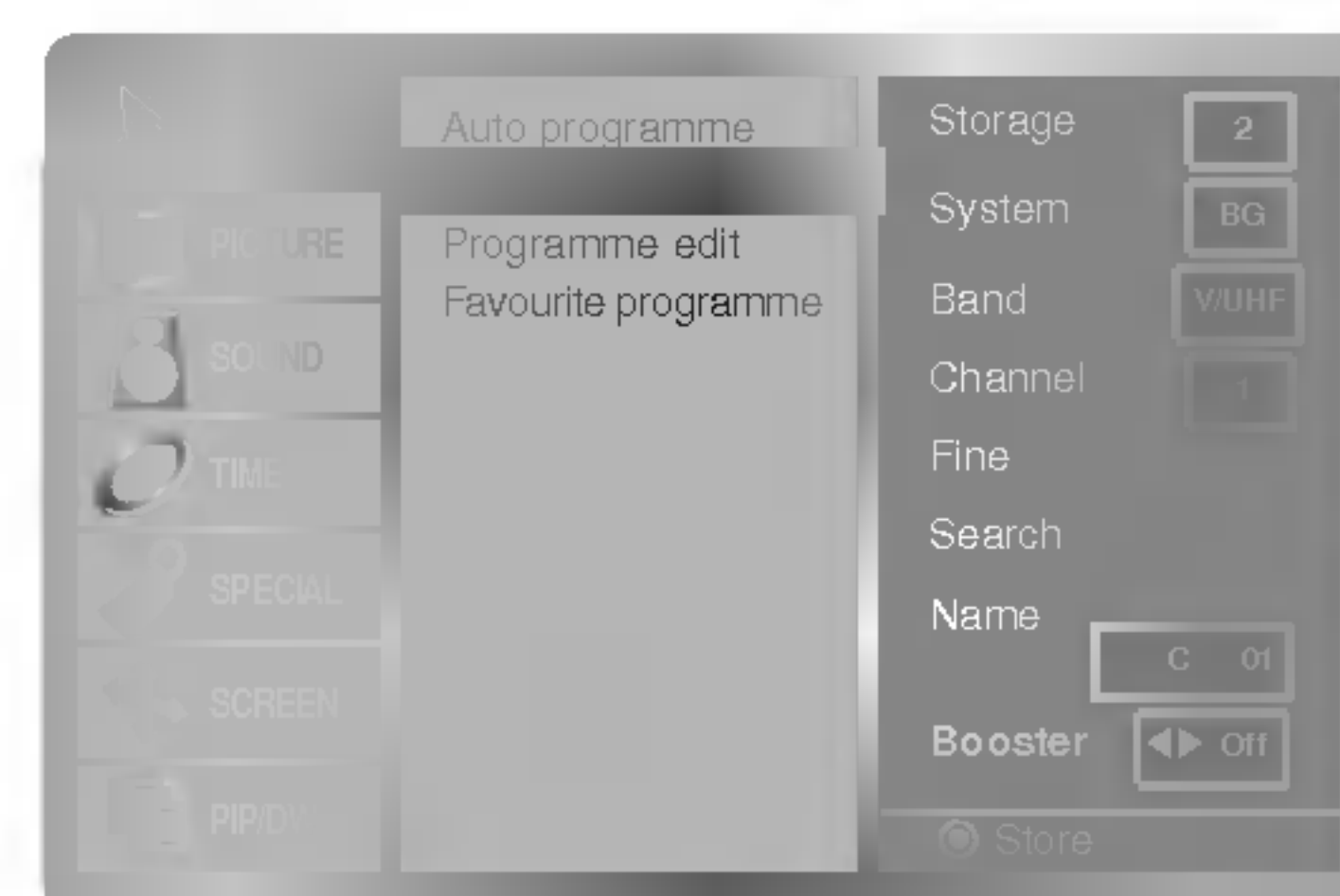

## Programme Edit

- This function enables you to delete or skip the stored programmes. Also you can move some stations to other programme numbers or copy a blank station data into the selected programme number.

1. Press the **MENU** button and then use **▲ / ▼** button to select the STATION menu.
2. Press the **▶** button and then **▲ / ▼** button to select **Programme edit**.
3. Press the **▶** button to display the **Programme edit** menu.

### Deleting a programme

1. Select a programme to be deleted with the **▲ / ▼** or **◀ / ▶** button.
2. Press the **RED** button twice.  
The selected programme is deleted, all the following programmes are shifted up one position.

### Copying a programme

1. Select a programme to be copied with the **▲ / ▼** or **◀ / ▶** button.
2. Press the **GREEN** button.  
All the following programmes are shifted down one position.

### Moving a programme

1. Select a programme to be moved with the **▲ / ▼** or **◀ / ▶** button.
2. Press the **YELLOW** button.
3. Move the programme to the desired programme number with the **▲ / ▼** or **◀ / ▶** button.
4. Press the **YELLOW** button again to release this function.

### Skipping a programme number

1. Select a programme number to be skipped with the **▲ / ▼** or **◀ / ▶** button.
2. Press the **BLUE** button. The skipped programme turns to blue.
3. Press the **BLUE** button again to release the skipped programme.  
When a programme number is skipped it means that you will be unable to select it using the **PR ▲ / ▼** button during normal TV viewing. If you want to select the skipped programme, directly enter the programme number with the NUMBER buttons or select it in the programme edit or table menu.

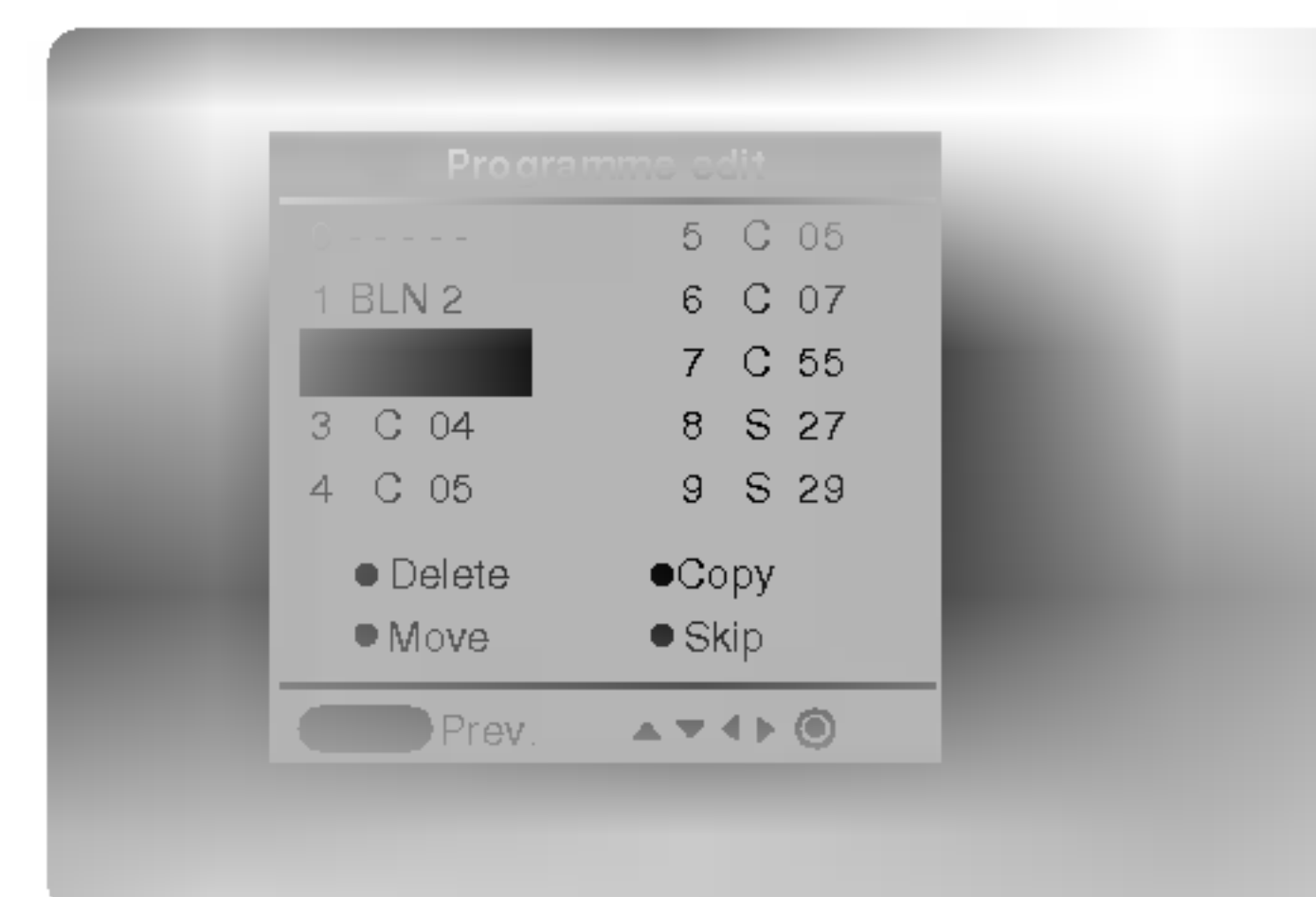

## Favourite Programme

- This function lets you select your favourite programmes directly.

1. Press the **MENU** button and then use **▲ / ▼** button to select the STATION menu.
2. Press the **▶** button and then **▲ / ▼** button to select **Favourite programme**.
3. Press the **▶** button to display the **Favourite programme** menu.
4. Press the **▲ / ▼** button to select -- -----.
5. Select a desired programme with the **◀ / ▶** button or NUMBER buttons. Any number under 10 is entered with a numeric '0' (or '00') in front of it, i.e. '05' (or '005') for 5.
6. To store another programme, repeat steps 4 to 5.  
You can store up to 8 programmes.
7. Press the **OK** button.
8. Press the **EXIT** button to return to normal TV viewing.

Repeatedly press the **FAVOURITE** button to select stored favorite programmes.

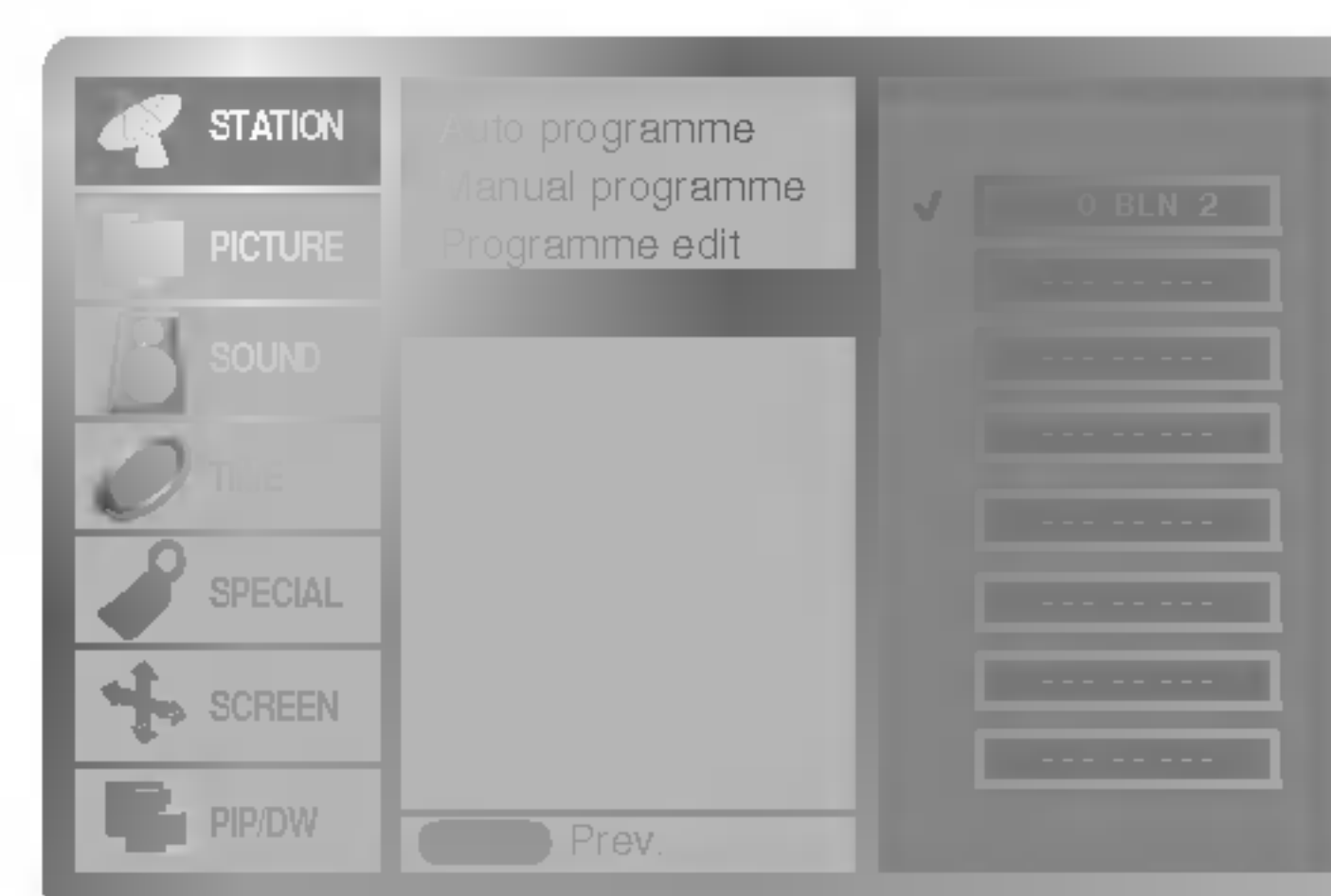

## Calling up the Programme Table

- You can check the programmes stored in the memory by displaying the programme table.

### Displaying programme table

Press the **LIST** button to display the Programme table menu.  
The programme table appears on the screen.

- You may find some blue highlighted programmes shown. They have been set up in the programme edit mode.
- Some programmes with the channel number shown in the programme table indicate there is no station name assigned.

### Selecting a programme in the programme table

Select a programme with the **▲ / ▼** or **◀ / ▶** button.  
Then press the **OK** button.  
The Plasma Display switches to the chosen programme number.

### Paging through a programme table

There are 10 programme table pages in which contain 100 programmes.  
Pressing the **▲ / ▼** or **◀ / ▶** button repeatedly turns the pages.

Press the **LIST** button to return to normal TV viewing.





# Picture Menu Options

## PSM (Picture Status Memory)

- This function adjusts the set to the best picture appearance.
- When adjusting picture options (contrast, brightness, colour, sharpness and tint (NTSC AV only)) manually, PSM is automatically changed to **User**.

1. Press the **PSM** button

- Each press of the **PSM** button changes the screen display as shown below.



- You can also select **Intelligent Eye**, **Dynamic**, **Standard**, **Mild** or **User** in the PICTURE menu.
- Picture options **Intelligent Eye**, **Dynamic**, **Standard** and **Mild** are preset and programmed for good picture quality at the factory and cannot be changed.
- When the eye function is on, the most suitable picture is automatically adjusted according to the surrounding conditions.

## CSM (Colour Status Memory)

- To initialize values (reset to default settings), select the **Normal** option.

1. Press the **MENU** button and then use **▲ / ▼** button to select the PICTURE menu.

2. Press the **▶** button and then use **▲ / ▼** button to select **CSM**.

3. Press the **▶** button and then use **▲ / ▼** button to select the desired colour temperature.

4. Press the **EXIT** button to return to normal TV viewing.

- Each press of **▲ / ▼** button changes the screen display as shown below.



## Manual Colour Temperature Control

- You can adjust red, green, or blue to any colour temperature you prefer.

1. Press the **MENU** button and then use **▲ / ▼** button to select the PICTURE menu.

2. Press the **▶** button and then use **▲ / ▼** button to select **CSM**.

3. Press the **▶** button and then use **▲ / ▼** button to select **User**.

4. Press the **▶** button and then use **▲ / ▼ / ◀ / ▶** button to make appropriate adjustments.

5. Press the **EXIT** button to return to normal TV viewing.

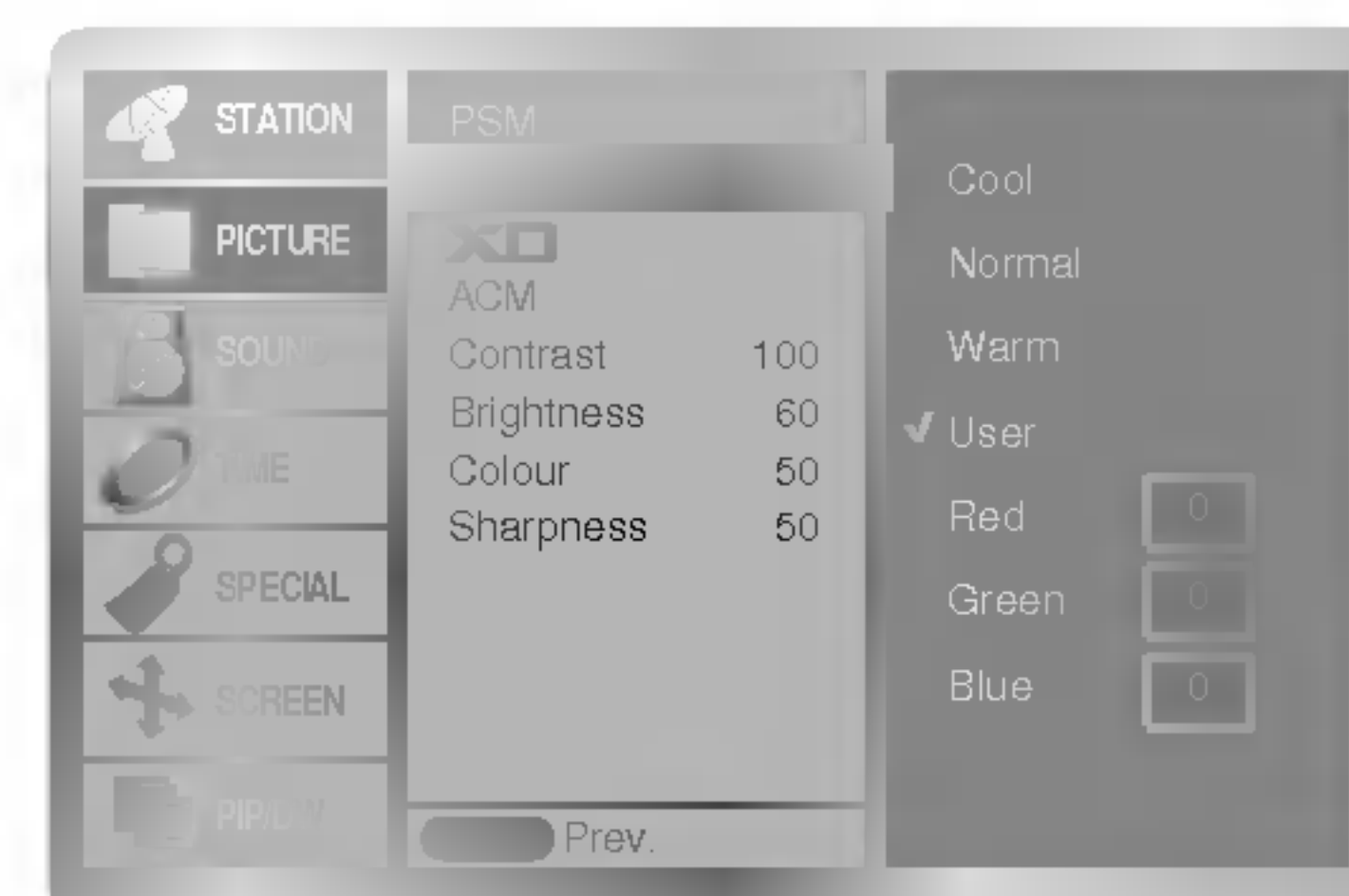

## XD

- You can enjoy the vivid and hi-definition picture with LG's Excellent Digital Reality processor technology.
- It's not available to use this function in RGB[PC], HDMI[PC] mode.
- When selecting picture options (**Intelligent Eye**, **Dynamic**, **Standard** and **Mild**) in PICTURE menu, **XD** is automatically changed to **On**.

1. Press the **MENU** button and then use **▲ / ▼** button to select the PICTURE menu.

2. Press the **▶** button and then use **▲ / ▼** button to select **XD**.

3. Press the **▶** button and then use **▲ / ▼** button to select **On** or **Off**.

4. Press the **EXIT** button to return to normal TV viewing.

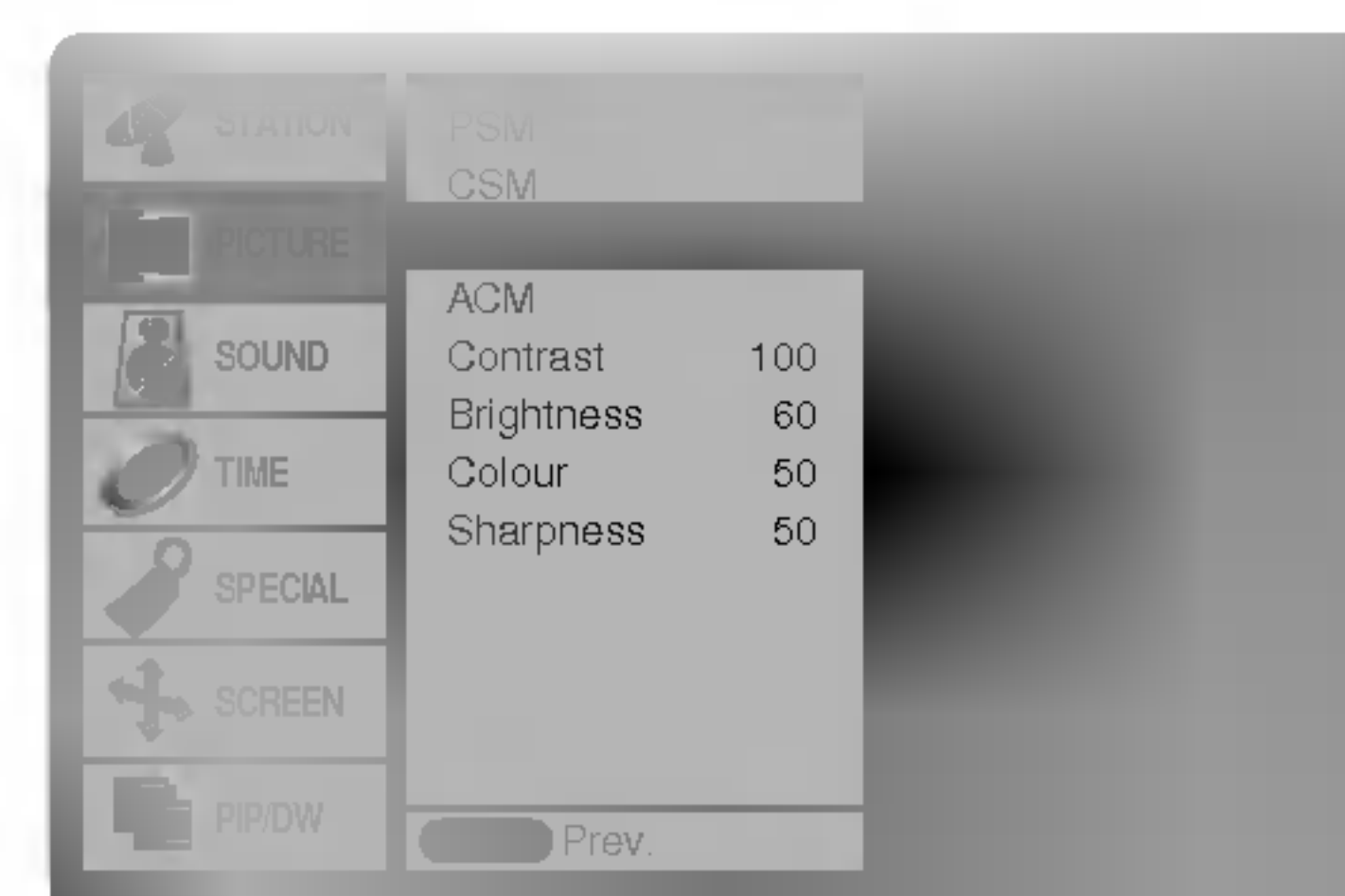

### sRGB

- When the set was connected to external equipment with sRGB function, It's adjusted a colour difference to display the equal image each other.
- This function works in the following mode:RGB[PC], HDMI[PC].
  1. Press the **MENU** button and then use ▲ / ▼ button to select the PICTURE menu.
  2. Press the ► button and then use ▲ / ▼ button to select **sRGB**.
  3. Press the ► button and then use ▲ / ▼ button to select **On** or **Off**.
  4. Press the **EXIT** button to return to normal TV viewing.



### ACM (Active Colour Management)

- Adjust the **ACM** to select the desired skin colour option.
- This function works in the following mode: TV, AV1, AV2, S-Video2, AV3, AV4, AV5 or COMPONENT, RGB[DTV], HDMI[DTV].
- It's not available to use this function in **XD Off** mode.

1. Press the **MENU** button and then use ▲ / ▼ button to select the PICTURE menu.
2. Press the ► button and then use ▲ / ▼ button to select **ACM**.
3. Press the ► button and then use ◀ / ▶ button to make appropriate adjustments.
4. Press the **EXIT** button to return to normal TV viewing.



### Manual Picture Control

- You can adjust picture contrast, brightness, colour, sharpness and tint (NTSC AV only) to the levels you prefer.
- It's not available to use colour, sharpness function in RGB[PC], HDMI[PC] mode.
- In the broadcasting system PAL/SECAM, the picture item Tint doesn't work.

1. Press the **MENU** button and then use ▲ / ▼ button to select the PICTURE menu.
2. Press the ► button and then use ▲ / ▼ button to select the desired picture option.
3. Press the ► button and then use ◀ / ▶ button to make appropriate adjustments.
4. Press the **EXIT** button to return to normal TV viewing.

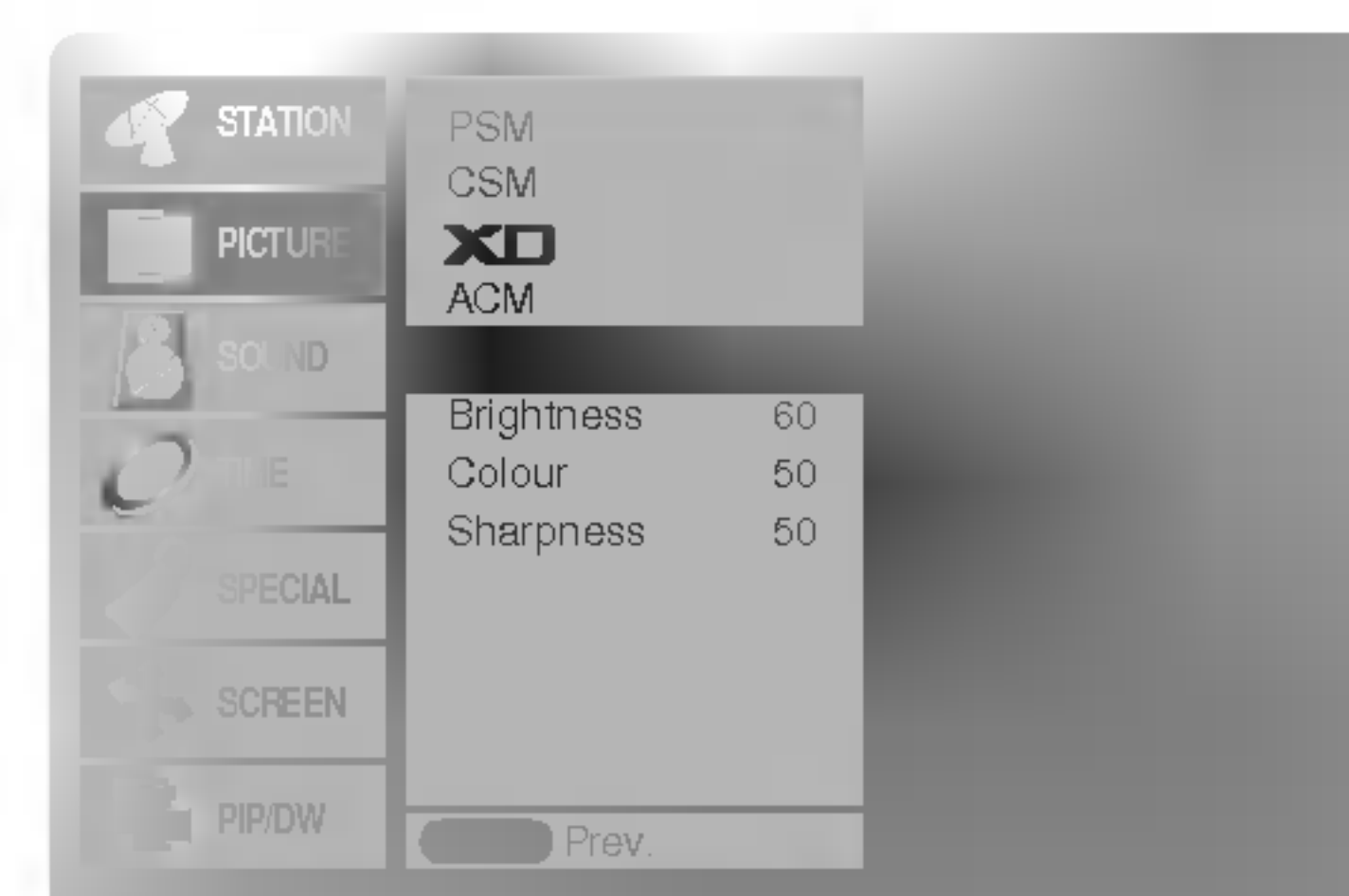



# Sound Menu Options

## SSM (Sound Status Memory)

- This function lets you enjoy the best sound without any special adjustment because the set automatically selects the appropriate sound option based on the program content.
- When adjusting sound options (treble and bass) manually, SSM is automatically changed to **User**.

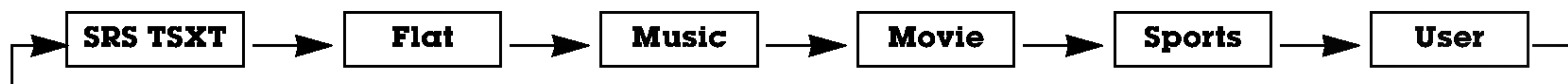
1. Press the **SSM** button.
2. Press the **SSM** button to select your desired sound.



- You can also select **SRS TSXT**, **Flat**, **Music**, **Movie**, **Sports** or **User** in the SOUND menu.
  - The sound **SRS TSXT**, **Flat**, **Music**, **Movie** and **Sports** are programmed for good sound reproduction at the factory and cannot be changed.
-  is a trademark of SRS Labs, Inc.
  - TruSurround XT technology is incorporated under license from SRS Labs, Inc.

## BBE

- BBE High Definition Sound restores clarity and presence for better speech intelligibility and musical realism.

1. Press the **MENU** button and then use **▲ / ▼** button to select the SOUND menu.
2. Press the **▶** button and then use **▲ / ▼** button to select **BBE**.
3. Press the **▶** button and then use **▲ / ▼** button to select **On** or **Off**.
4. Press the **EXIT** button to return to normal TV viewing.

**BBE** Manufactured under license from BBE Sound, Inc.

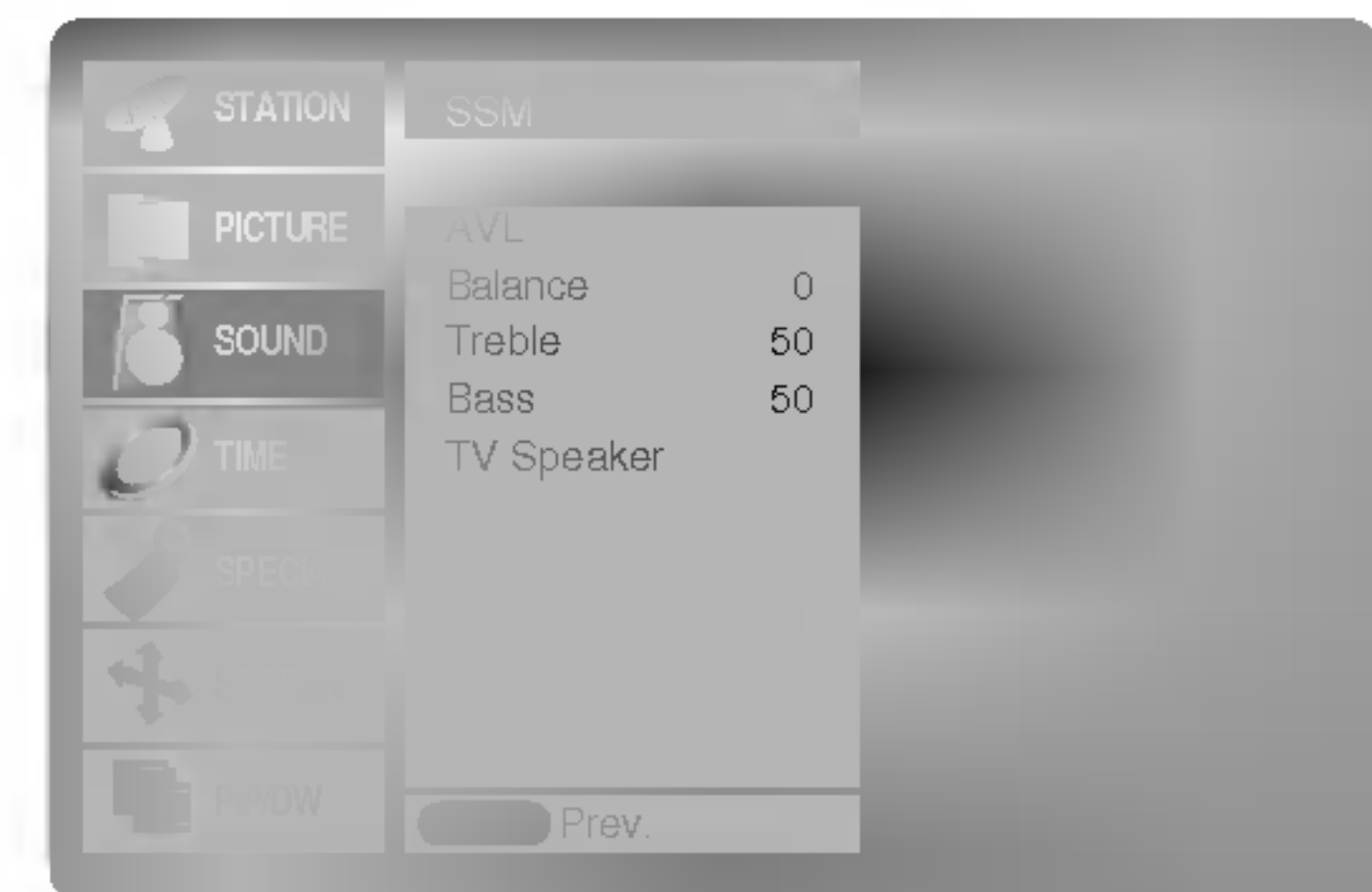

## AVL (Auto Volume Leveler)

- This feature maintains an equal volume level; even if you change channels.

1. Press the **MENU** button and then use **▲ / ▼** button to select the SOUND menu.
2. Press the **▶** button and then use **▲ / ▼** button to select **AVL**.
3. Press the **▶** button and then use **▲ / ▼** button to select **On** or **Off**.
4. Press the **EXIT** button to return to normal TV viewing.

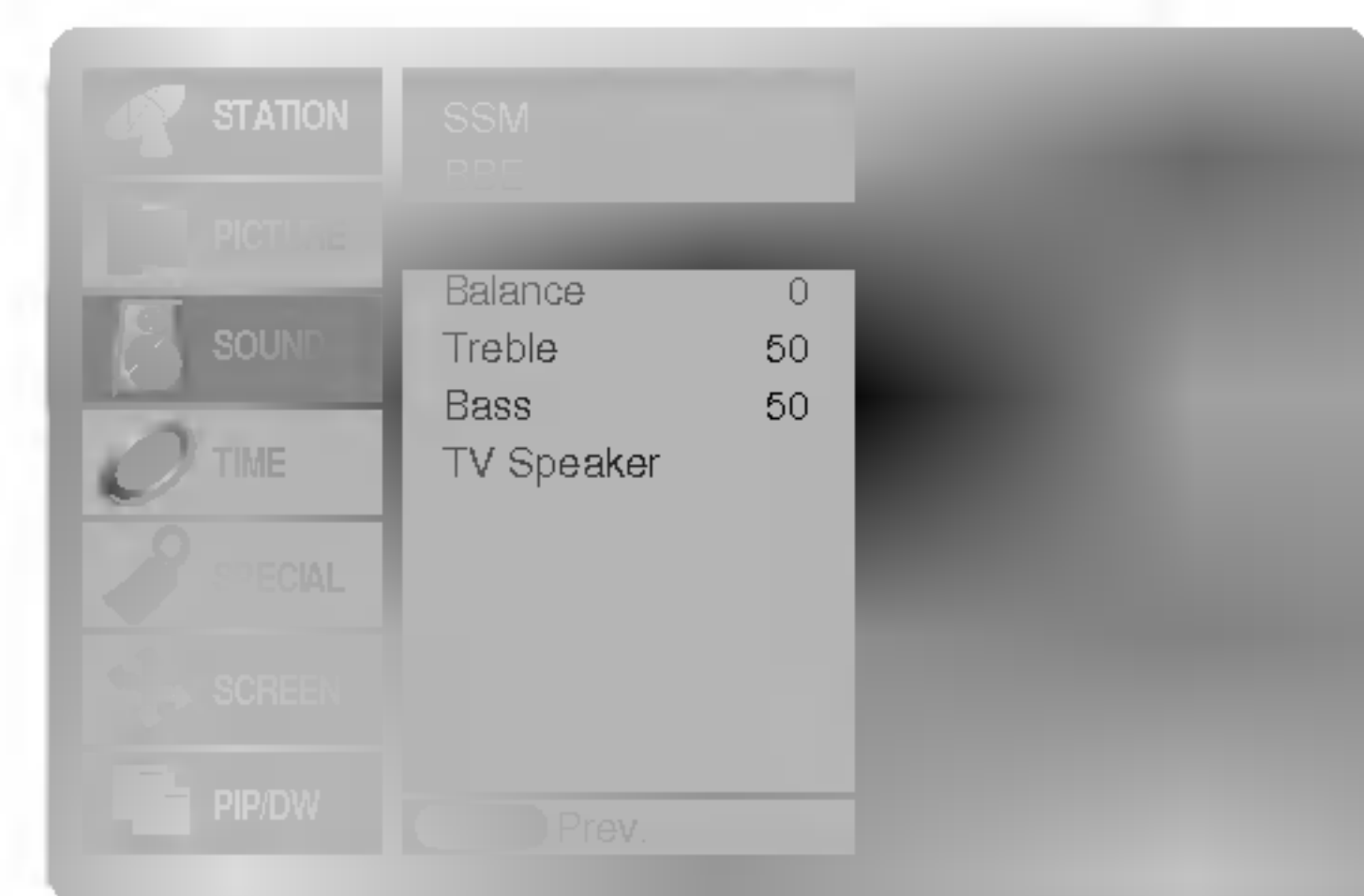

## Adjusting Sound Control

1. Press the **MENU** button and then use **▲ / ▼** button to select the SOUND menu.
2. Press the **▶** button and then use **▲ / ▼** button to select the desired sound item.
3. Press the **▶** button and then use **◀ / ▶** button to make appropriate adjustments.
4. Press the **EXIT** button to return to normal TV viewing.

**Note :** Treble, Bass or BBE aren't suitable to use **SRS TSXT**.

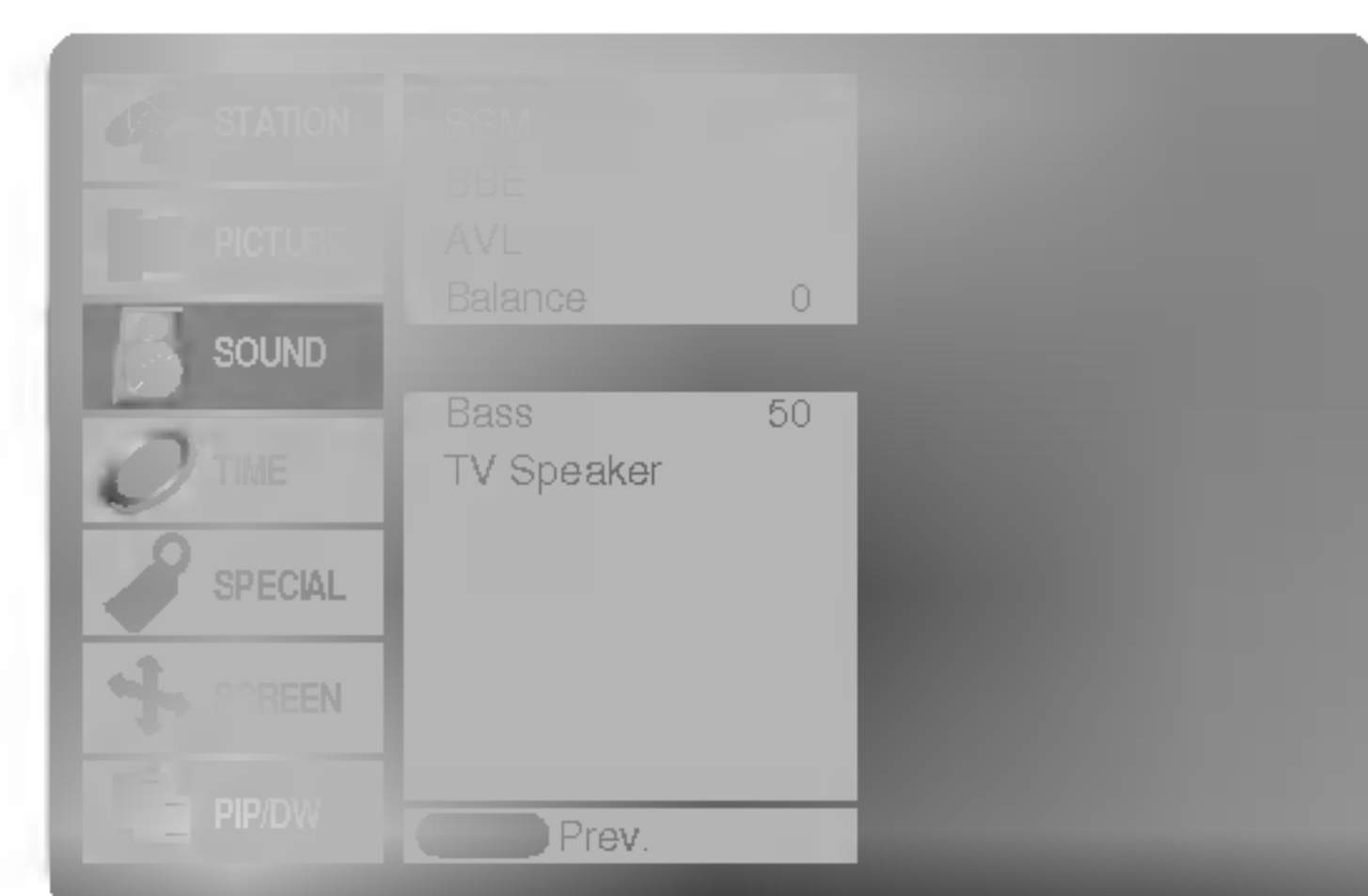



## TV Speaker

- You can adjust internal speaker status.
- In COMPONENT, RGB[PC] and HDMI[PC] mode, TV speaker/variable audio can be output even though there is no video signal.
- If you want to use your external hi-fi stereo system, turn off the internal speakers of the set.

1. Press the **MENU** button and then use **▲ / ▼** button to select the SOUND menu.
2. Press the **▶** button and then use **▲ / ▼** button to select **TV Speaker**.
3. Press the **▶** button and then use **▲ / ▼** button to select **On** or **Off**.
4. Press the **EXIT** button to return to normal TV viewing.

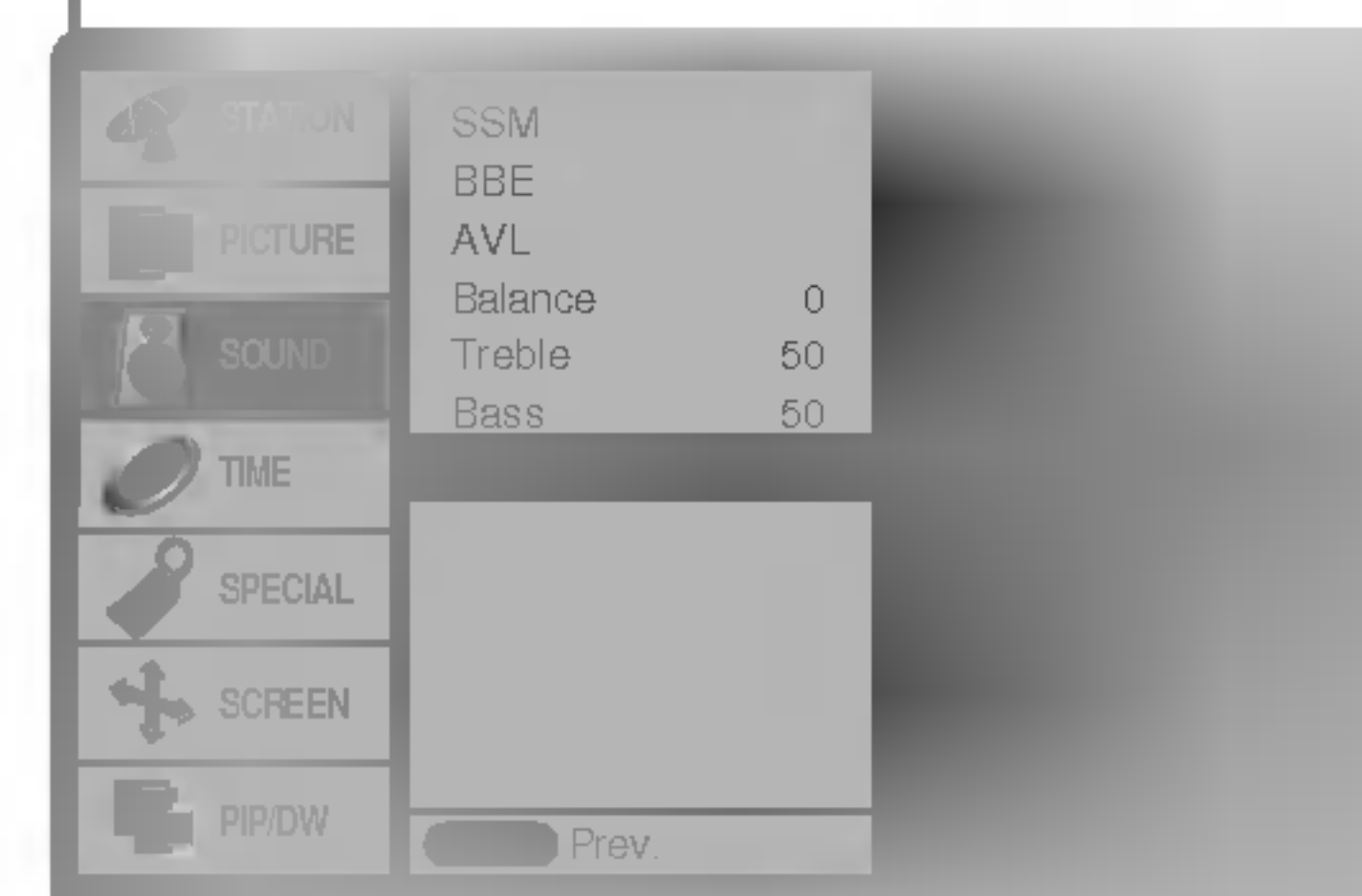

## Stereo / Dual Reception

- When a programme is selected, the sound information for the station appears after the programme number and station name disappear.

### On Screen Display

Press the **I/II** button to received broadcast state.

Broadcast	On screen Display
Mono	<b>MONO</b>
Stereo	<b>STEREO</b>
Dual	<b>DUAL I</b>

### Mono Sound Selection

In stereo reception if the stereo signal is weak, you can switch to mono by pressing the **I/II** button twice. In mono reception the depth of sound is improved. To switch back to stereo, press the **I/II** button twice again.

### Language Selection for Dual Language Broadcast

If a programme received in two languages (dual language), you can switch to **DUAL I**, **DUAL II** or **DUAL I + II** by pressing the **I/II** button repeatedly.

- **DUAL I** sends the primary broadcast language to the loudspeakers.
- **DUAL II** sends the secondary broadcast language to the loudspeakers.
- **DUAL I + II** sends a separate language to each loudspeaker.

## NICAM Reception (option)

- If your Plasma Display is equipped with the PDP Tuner for NICAM reception, the high quality NICAM (Near Instantaneous Companding Audio Multiplex) digital sound can be received.

Sound output can be selected according to the type of received broadcast as follows by pressing the **I/II** button repeatedly.

- When NICAM mono is received, you can select **NICAM MONO** or FM MONO.
- When NICAM stereo is received, you can select **NICAM STEREO** or FM MONO. If the stereo signal is weak, switch to FM mono.
- When NICAM dual is received, you can select **NICAM DUAL I**, **NICAM DUAL II**, **NICAM DUAL I + II**, or **MONO**. When FM mono is selected the display **MONO** appears on the screen.

### Sound output selection

In AV, Component, RGB or HDMI mode, you can select output sound for the left and right loudspeakers.

Repeatedly press the **I/II** button to select the sound output.

- **L+R** : Audio signal from audio L input is sent to left loud-speaker and audio signal from audio R input is sent to right loud-speaker.
- **L+L** : Audio signal from audio L input is sent to left and right loud-speakers.
- **R+R** : Audio signal from audio R input is sent to left and right loud-speakers.

# Time Menu Options

## Setting the Clock

- If current time setting is erased by a power failure or the set is unplugged, reset the clock.

1. Press the **MENU** button and then use ▲ / ▼ button to select the **TIME** menu.
2. Press the ► button and then use ▲ / ▼ button to select **Clock**.
3. Press the ► button and then use ▲ / ▼ button to adjust the hour.
4. Press the ► button and then use ▲ / ▼ button to adjust the minute.
5. Press the **EXIT** button to return to normal TV viewing.

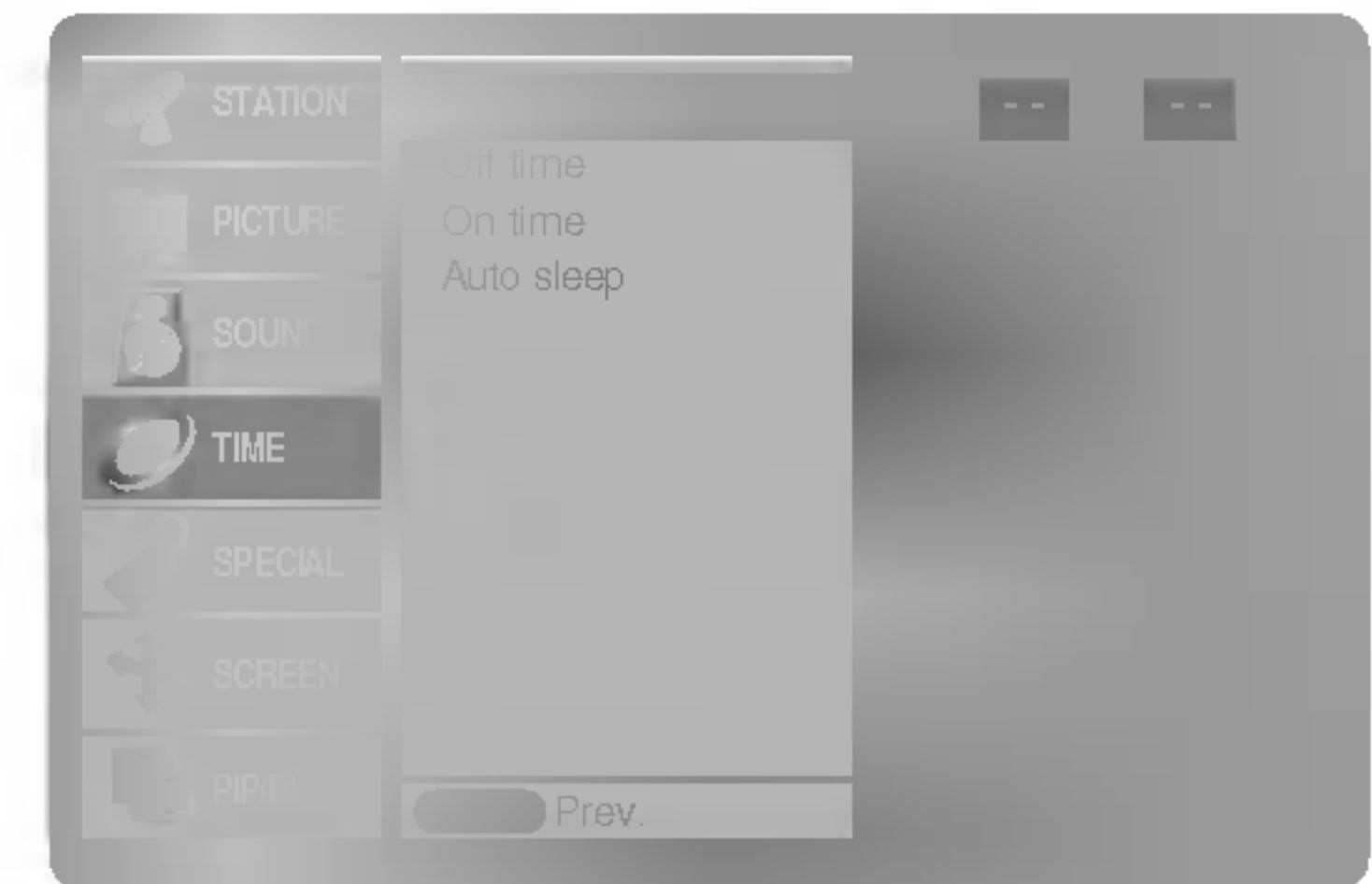

## Setting the On/Off Timer

- Timer function operates only if current time has been already set.
- Off Timer function overrides on Timer function if they are set to the same time.
- The set must be in standby mode for the On Timer to work.

1. Press the **MENU** button and then use ▲ / ▼ button to select the **TIME** menu.
2. Press the ► button and then use ▲ / ▼ button to select **Off time** or **On time**.
3. Press the ► button and then use ▲ / ▼ button to select **On**.
4. Press the ► button and then use ▲ / ▼ button to adjust the hour.
5. Press the ► button and then use ▲ / ▼ button to adjust the minute.
6. **Only On time function**; Press the ► button and then use ▲ / ▼ button to adjust programme number or volume level.
7. Press the **EXIT** button to return to normal TV viewing.

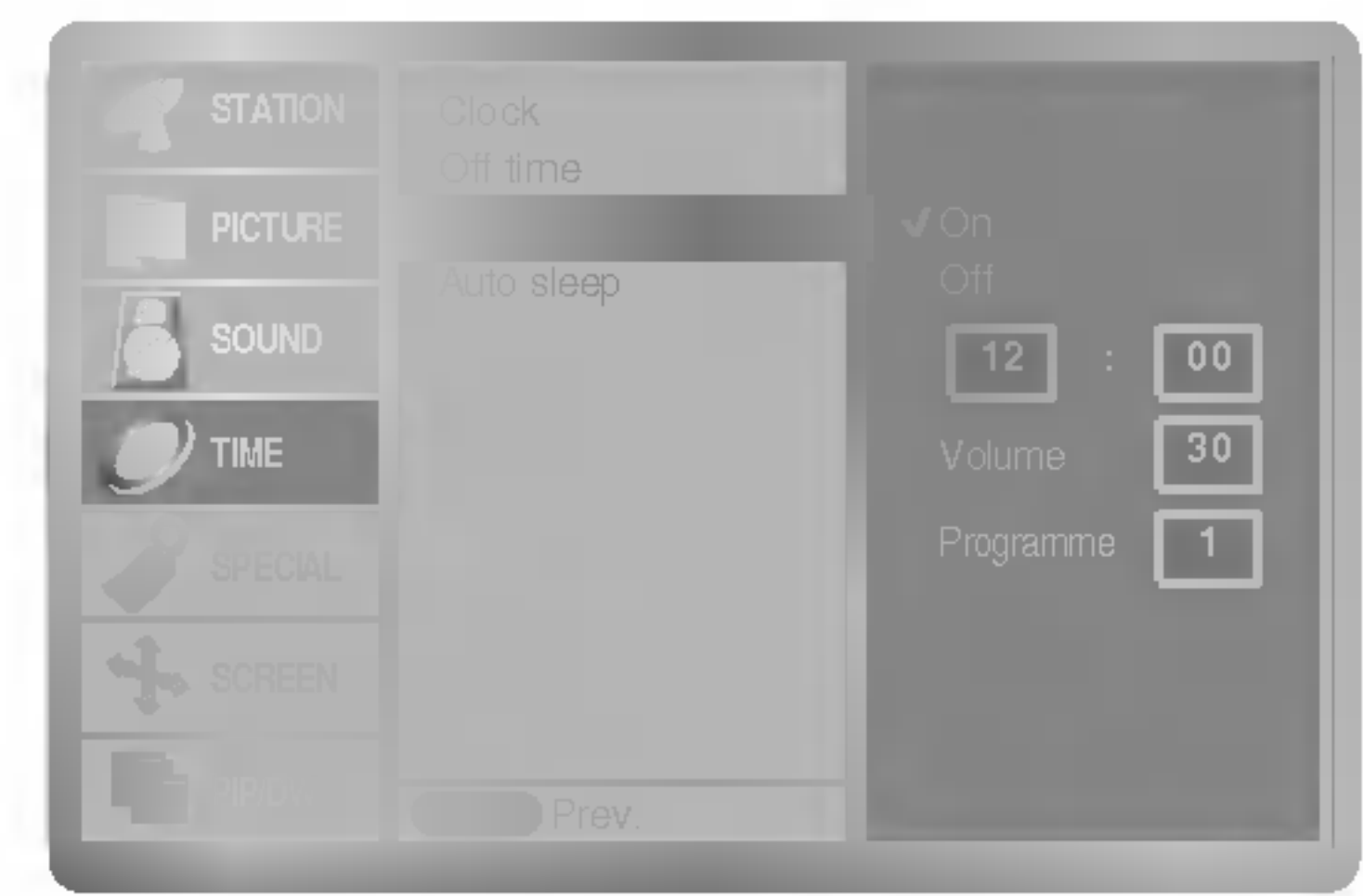

- To cancel **Off/On time** function  
Press the ▲ / ▼ button to select **Off** in step 3.
- Two hours after the set is switched on by the on time function it will automatically switch back to standby mode unless a button has been pressed.

## Auto Sleep

- If there is no input signal, the monitor turn off automatically after 10 minutes.

1. Press the **MENU** button and then use ▲ / ▼ button to select the **TIME** menu.
2. Press the ► button and then use ▲ / ▼ button to select **Auto sleep**.
3. Press the ► button and then use ▲ / ▼ button to select **On** or **Off**.
4. Press the **EXIT** button to return to normal TV viewing.

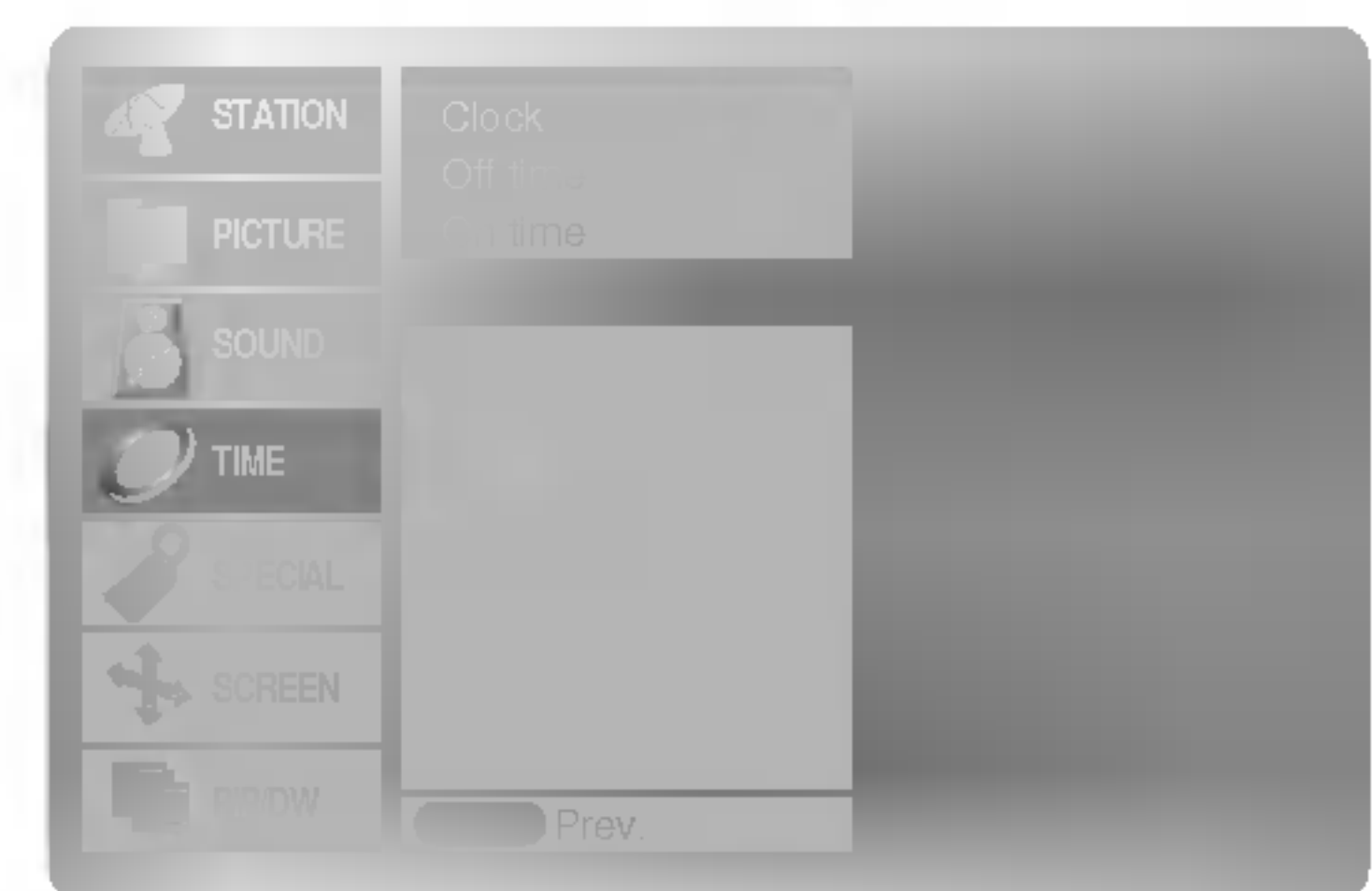

## Sleep Timer

- Sleep timer turns the set off at the preset time.
- Press the **SLEEP** button to select the number of minutes. The display **L<sup>zz</sup> --- Min** will appear on the screen, followed by **10, 20, 30, 60, 90, 120, 180** and **240** minutes. The timer begins to count down from the number of minutes selected.

- a. To check the remaining sleep time, press the **SLEEP** button once.
- b. To cancel the sleep time, repeatedly press the **SLEEP** button until the display **L<sup>zz</sup> --- Min** appears.
- c. If you turn the set off after setting the sleep timer, the setting will be erased.

# Special Menu Options

## Child Lock

- The set can be set up so that it can only be used with the remote control.

  1. Press the **MENU** button and then **▲ / ▼** button to select the **SPECIAL** menu.
  2. Press the **▶** button and then **▲ / ▼** button to select **Child lock**.
  3. Press the **▶** button and then **▲ / ▼** button to select **On** or **Off**.
  4. Press the **EXIT** button to return to normal TV viewing.

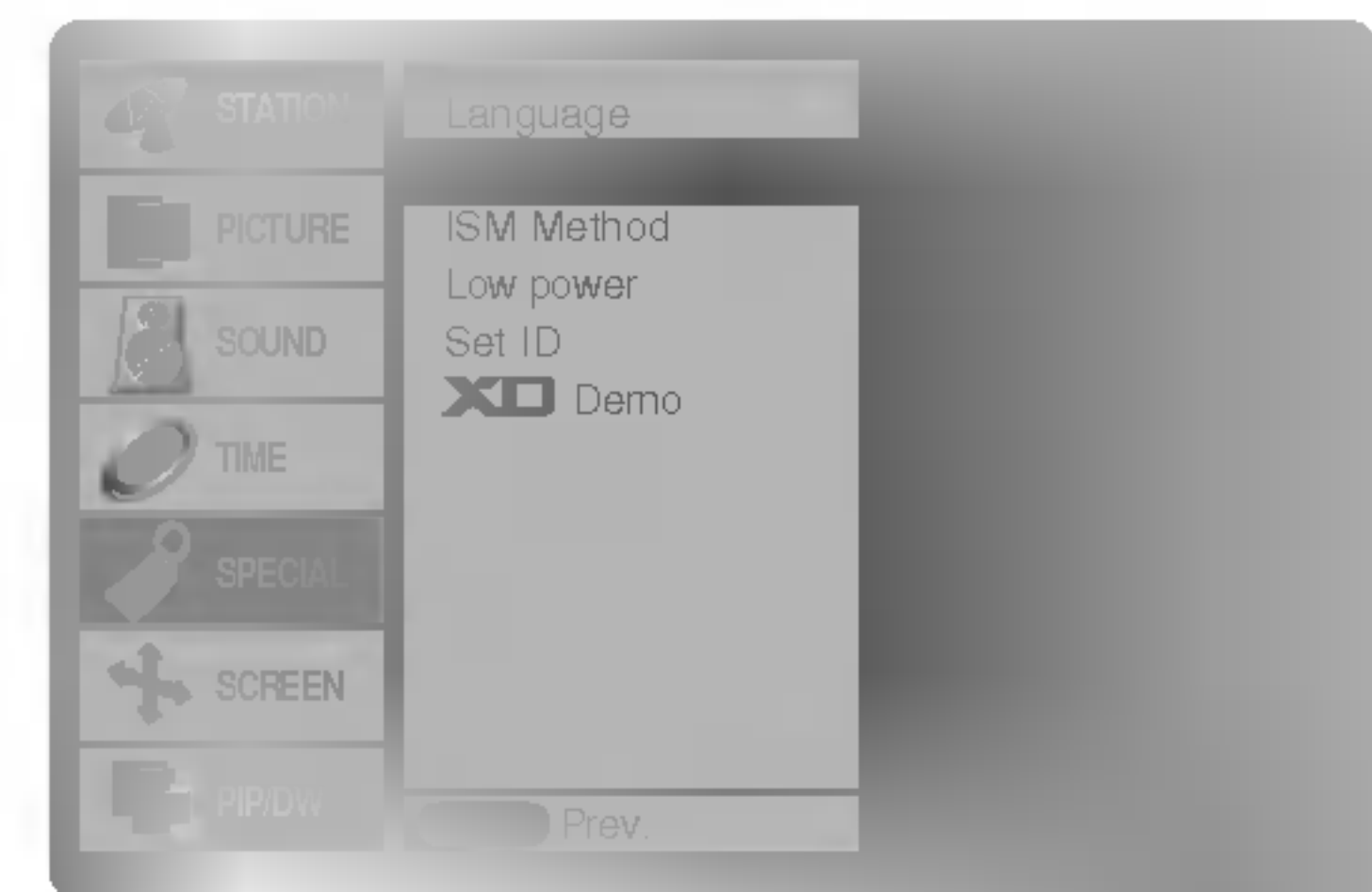

- This set programmed to remember which option it was last set to even if you turn the set off.
- In **Child lock 'On'**, if the set is turned off, press the **INPUT, PR ▲ / ▼** button on the set or **POWER, INPUT, MULTIMEDIA, PR ▲ / ▼** or **NUMBER** buttons on the remote control.
- With the **Child lock On**, the display '**▲ Child lock on**' appears on the screen if any button on the front panel is pressed while viewing the set.

## ISM (Image Sticking Minimization) Method

- Frozen still picture from a PC/video game displayed on the screen for prolonged periods will result in an ghost image remaining even when you change the image. Avoid allowing a fixed image to remain on the set's screen for a long period of time.

1. Press the **MENU** button and then use **▲ / ▼** button to select the **SPECIAL** menu.
2. Press the **▶** button and then **▲ / ▼** button to select **ISM Method**.
3. Press the **▶** button and then **▲ / ▼** button to select either **Normal**, **White wash**, **Orbiter** or **Inversion**. If you unnecessary to set this function, set **Normal**.

- **White Wash :**

White Wash removes permanent images from the screen.

**Note:** An excessive permanent image may be impossible to clear entirely with White Wash.

- **Orbiter :**

Orbiter may help prevent ghost images. However, it is best not to allow any fixed image to remain on the screen. To avoid a permanent image on the screen, the screen will move every 2 minutes.

- **Inversion :**

This is the function to invert the panel colour of the screen. The panel colour is automatically inverted every 30 minutes.

4. Press the **EXIT** button to return to normal TV viewing.

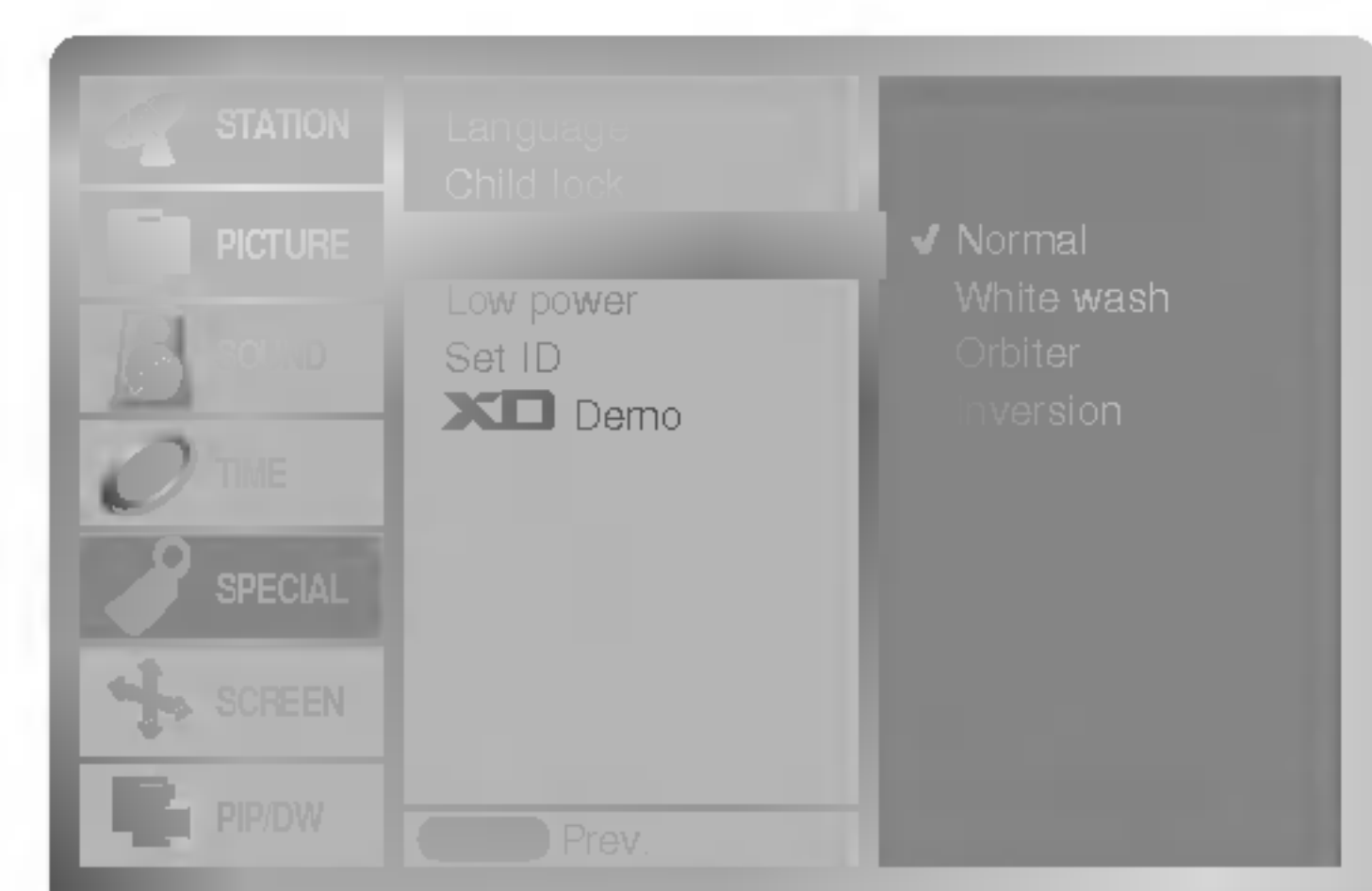



# Special Menu Options

## Low Power

- This is the function to reduce the power consumption of the set.
  1. Press the **MENU** button and then use ▲ / ▼ button to select the **SPECIAL** menu.
  2. Press the ► button and then use ▲ / ▼ button to select **Low power**.
  3. Press the ► button and then use ▲ / ▼ button to select **On** or **Off**.
  4. Press the **EXIT** button to return to normal TV viewing.

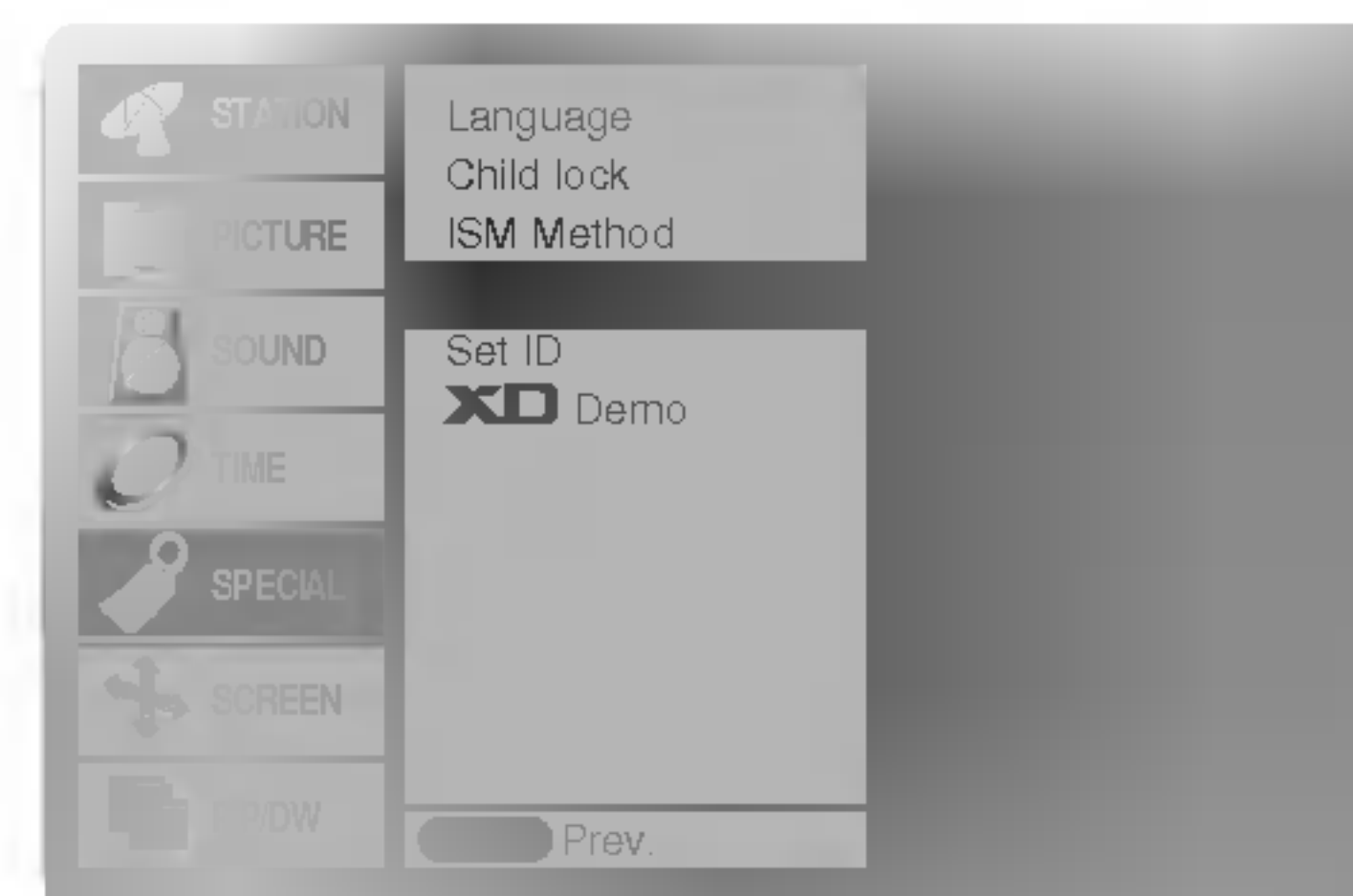

## XD Demo

- Use it to see the difference between XD demo on and XD Demo off.
- It's not available to use this function in RGB[PC], HDMI[PC] mode.
  1. Press the **MENU** button and then use ▲ / ▼ button to select the **SPECIAL** menu.
  2. Press the ► button and then use ▲ / ▼ button to select **XD Demo**.
  3. Press the ► button to begin **XD Demo**.
  4. To stop **XD Demo**, press the **EXIT** button.

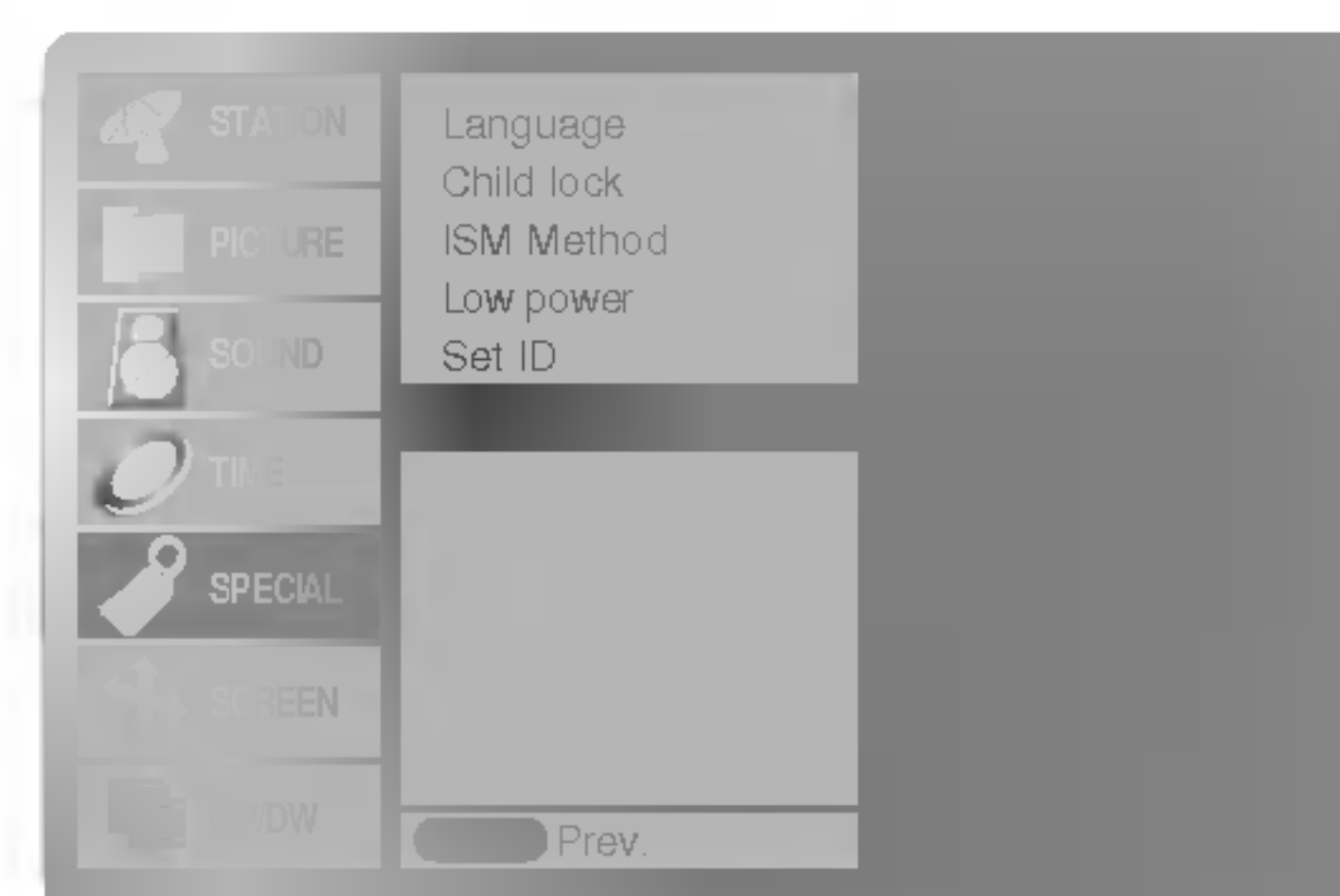

# Screen Menu Options

## Auto Configure

- Automatically adjusts picture position and minimizes image shaking.
  - This function works in the following mode : RGB[PC].
1. Press the **MENU** button and then use ▲ / ▼ button to select the SCREEN menu.
  2. Press the ► button and then use ▲ / ▼ button to select **Auto config.**
  3. Press the ► button to start **Auto config.**
    - When **Auto config.** has finished, **Ok** will be shown on screen.
    - If the position of the image is still not correct, try Auto adjustment again.
  4. If picture needs to be adjusted more after Auto adjustment in RGB (PC), you can adjust the **Manual Config.**
  5. Press the **EXIT** button to return to normal TV viewing.



- Although the image is still not correct, your set is functioning properly but needs further adjustment.
- The **Auto config.** functions don't need to be run for HDMI mode.

## Manual Configure

- If the picture isn't clear after auto adjustment and especially that characters are still trembling, adjust the picture phase manually.
  - To correct the screen size, adjust **Clock**.
  - This function works in the following mode : RGB[PC], RGB[DTV], COMPONENT (480p/576p/720p/1080i), HDMI (480p/576p/720p/1080i).
  - It's not available to use Phase, Clock function in RGB[DTV], COMPONENT (480p/576p/720p/1080i), HDMI (480p/576p/720p/1080i) mode.
1. Press the **MENU** button and then ▲ / ▼ button to select the SCREEN menu.
  2. Press the ► button and then ▲ / ▼ button to select **Manual config.**
  3. Press the ► button and then ▲ / ▼ button to select **Phase, Clock, H-Position** or **V-Position**.
  4. Press the ◀ / ▶ button to make appropriate adjustments.
  5. Press the **EXIT** button to return to normal TV viewing.

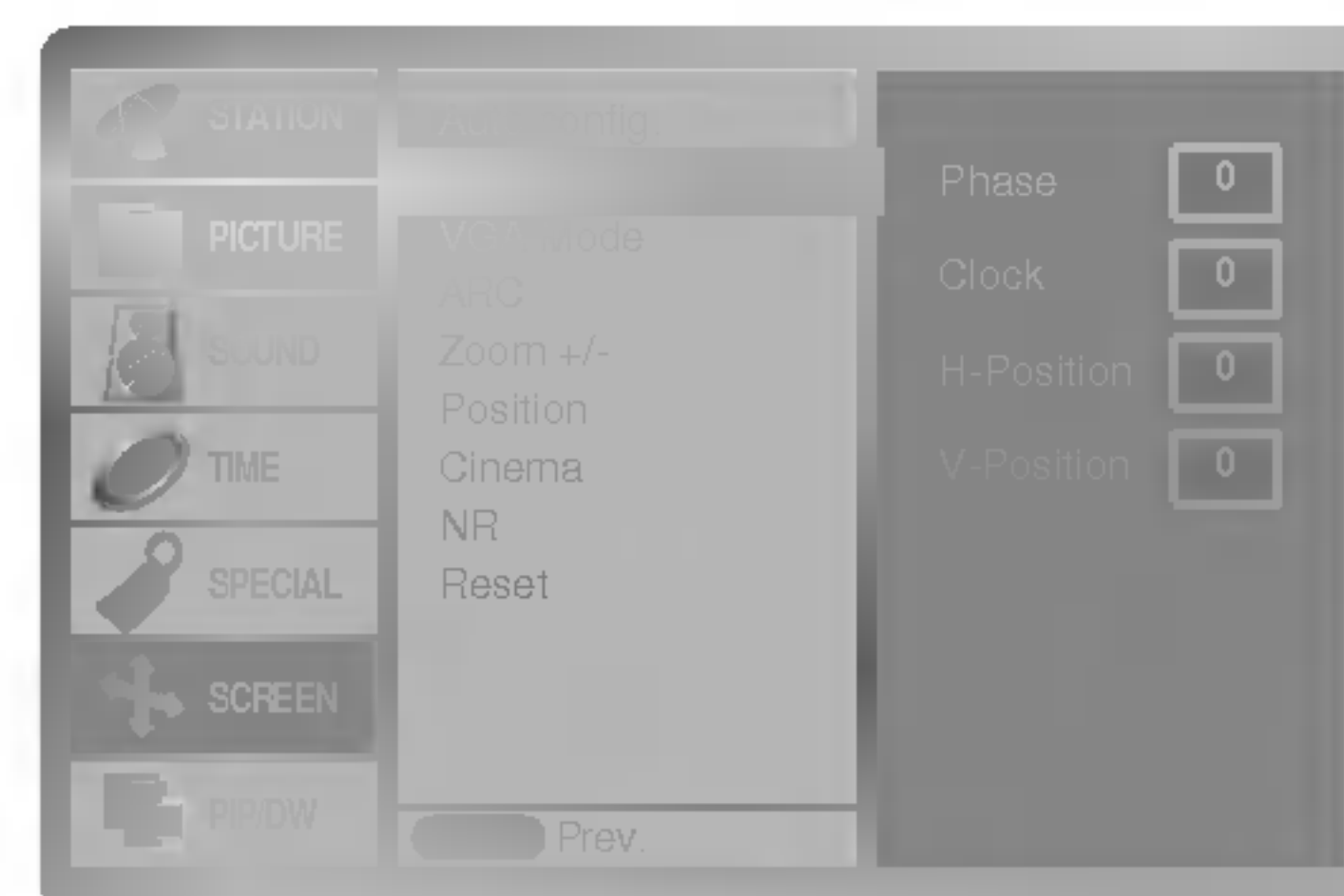

## Selecting Wide VGA/XGA mode

- To see a normal picture, match the resolution of RGB mode and selection of VGA/XGA mode.
  - In some models, it's not available to selection of XGA mode.
  - This function works in the following mode : RGB[PC].
1. Press the **MENU** button and then use ▲ / ▼ button to select the SCREEN menu.
  2. Press the ► button and then use ▲ / ▼ button to select **VGA Mode** (or **XGA Mode**).
  3. Press the ► button and then use ▲ / ▼ button to select the desired VGA/XGA resolution.
  4. Press the **EXIT** button to return to normal TV viewing.

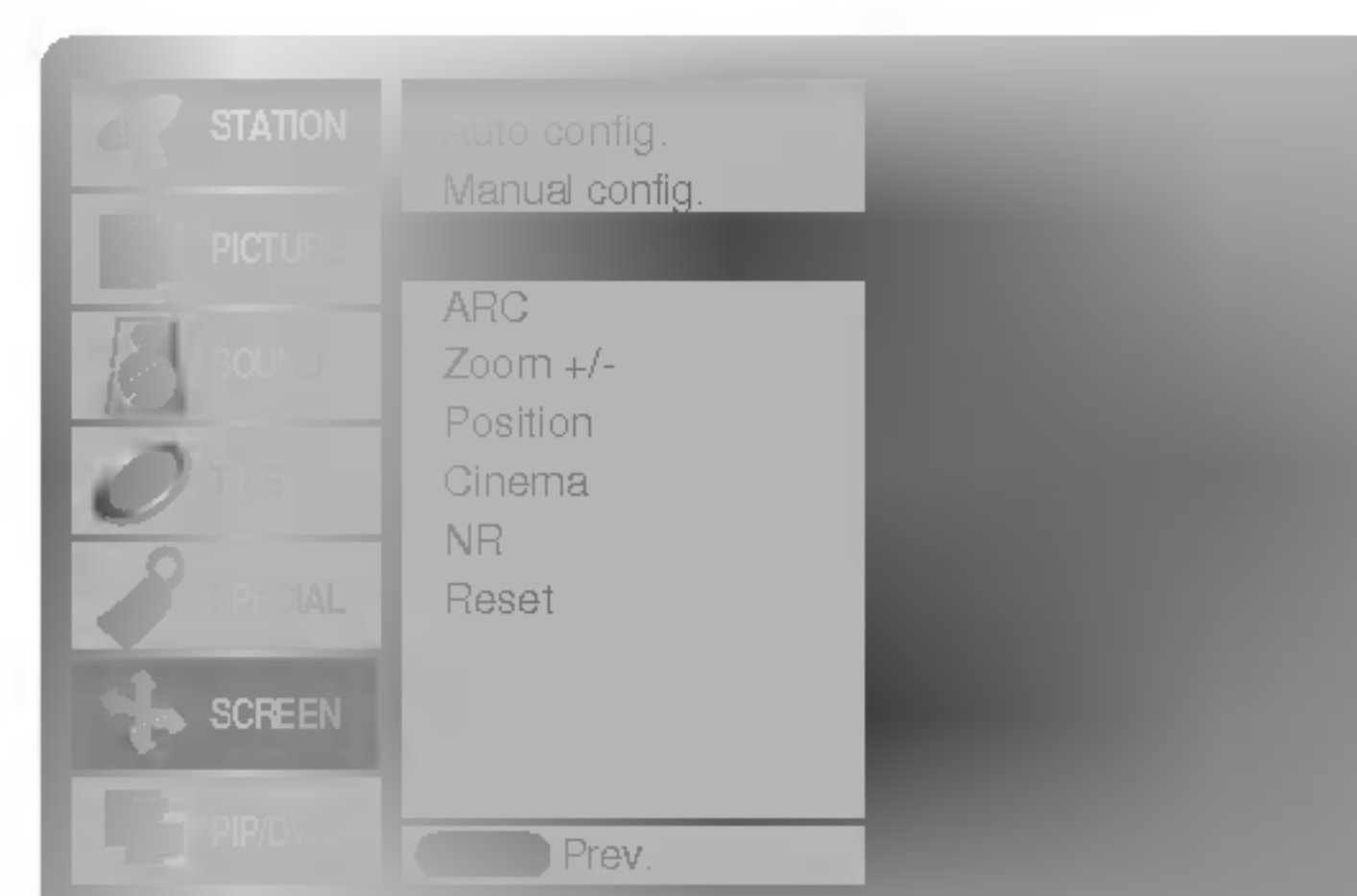

# Screen Menu Options

## Setting Picture Format

- You can watch the screen in various picture formats; **Spectacle**, **Full** (option), **Original**, **4:3**, **16:9** (Wide), **14:9** and **Zoom**.

1. Press the **MENU** button and then use **▲ / ▼** button to select the **SCREEN** menu.
2. Press the **▶** button and then use **▲ / ▼** button to select **ARC**.
3. Press the **▶** button and then use **▲ / ▼** button to select **Spectacle**, **Full** (option), **Original**, **4:3**, **16:9**, **14:9** or **Zoom**.

- **Spectacle**

When your TV receives the wide screen signal, following selection will lead you to adjust the picture horizontally, in non-linear proportion, to fill the entire screen.

- **Full** (option)

When your TV receives the wide screen signal, following selection will lead you to adjust the picture horizontally or vertically, in a linear proportion, to fill the entire screen fully.

- **Original**

When your TV receives the wide screen signal, it will be automatically changed to the picture format to be sent.

- **4:3**

Following selection will lead you to view a picture with an original 4:3 aspect ratio, with gray bars appearing at both the left and right sides.

- **16:9** (Wide)

Following selection will lead you to adjust the picture horizontally, in a linear proportion, to fill the entire screen (useful for viewing 4:3 formatted DVDs).

- **14:9**

You can enjoy the picture format of 14:9 or general TV programme through the 14:9 mode. The screen 14:9 is viewed just like that the screen 4:3 is magnified to the left / right.

- **Zoom**

Following selection will lead you to view the picture without any alternation, while filling the entire screen. However, the top and bottom portions of the picture will be cropped.

4. Press the **EXIT** button to return to normal TV viewing.

- You can only select **4:3** and **16:9** (Wide) in RGB[PC], HDMI[PC] mode only.
- You can only select **4:3**, **16:9** (Wide) and **Zoom** in RGB[DTV], HDMI[DTV], Component [DTV] mode only.
- You can only select **Spectacle**, **Full** (option), **4:3**, **16:9** (Wide), **14:9** and **Zoom** in Component [480i/576i] mode only.
- There might be uncomfortable in full mode. Then change into other mode.

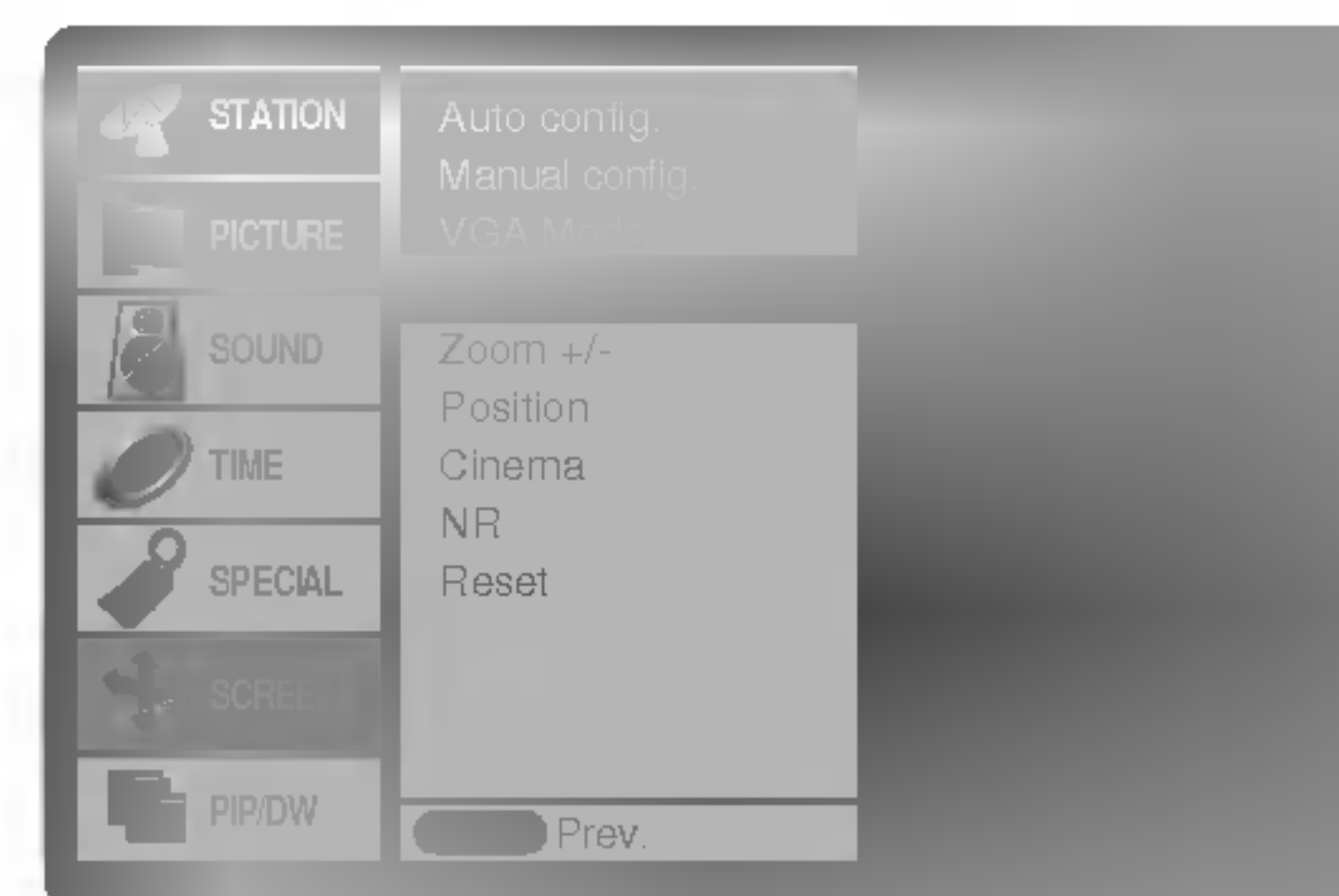

## Picture Size Zoom

- When enlarging or reducing the picture, the screen may be display unnatural picture.

1. Press the **MENU** button and then **▲ / ▼** button to select the **SCREEN** menu.
2. Press the **▶** button and then **▲ / ▼** button to select **Zoom +/-**.
3. Press the **▶** button and then **◀ / ▶** button to make appropriate adjustments.
4. Press the **EXIT** button to return to normal TV viewing.

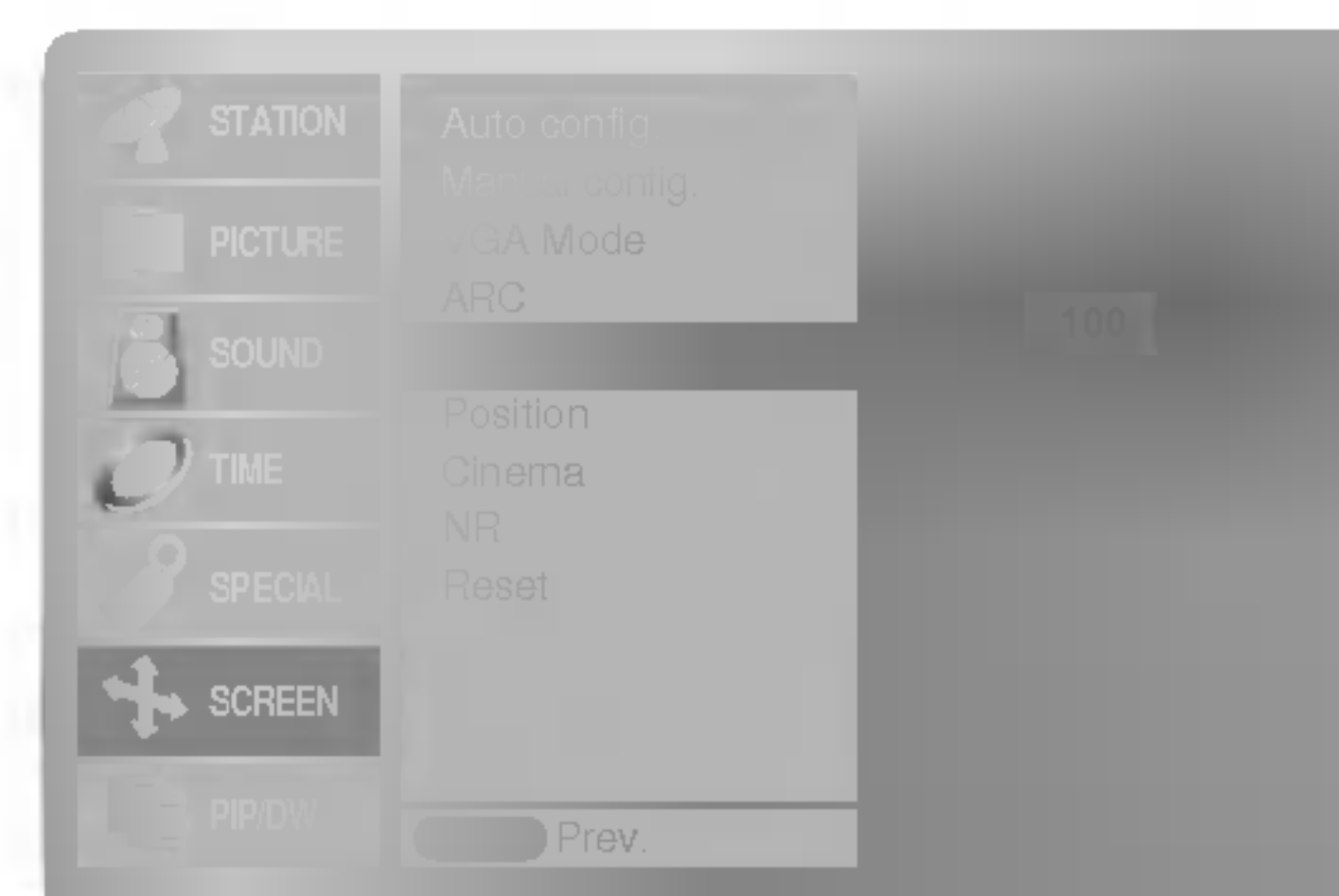



## Screen Position

- You are available to this function after adjusting Zoom In/Out.

  1. Press the **MENU** button and then ▲ / ▼ button to select the SCREEN menu.
  2. Press the ► button and then ▲ / ▼ button to select **Position**.
  3. Press the ► button and then ▲ / ▼ or ◀ / ▶ button to adjust the position.
  4. Press the **EXIT** button to return to normal TV viewing.

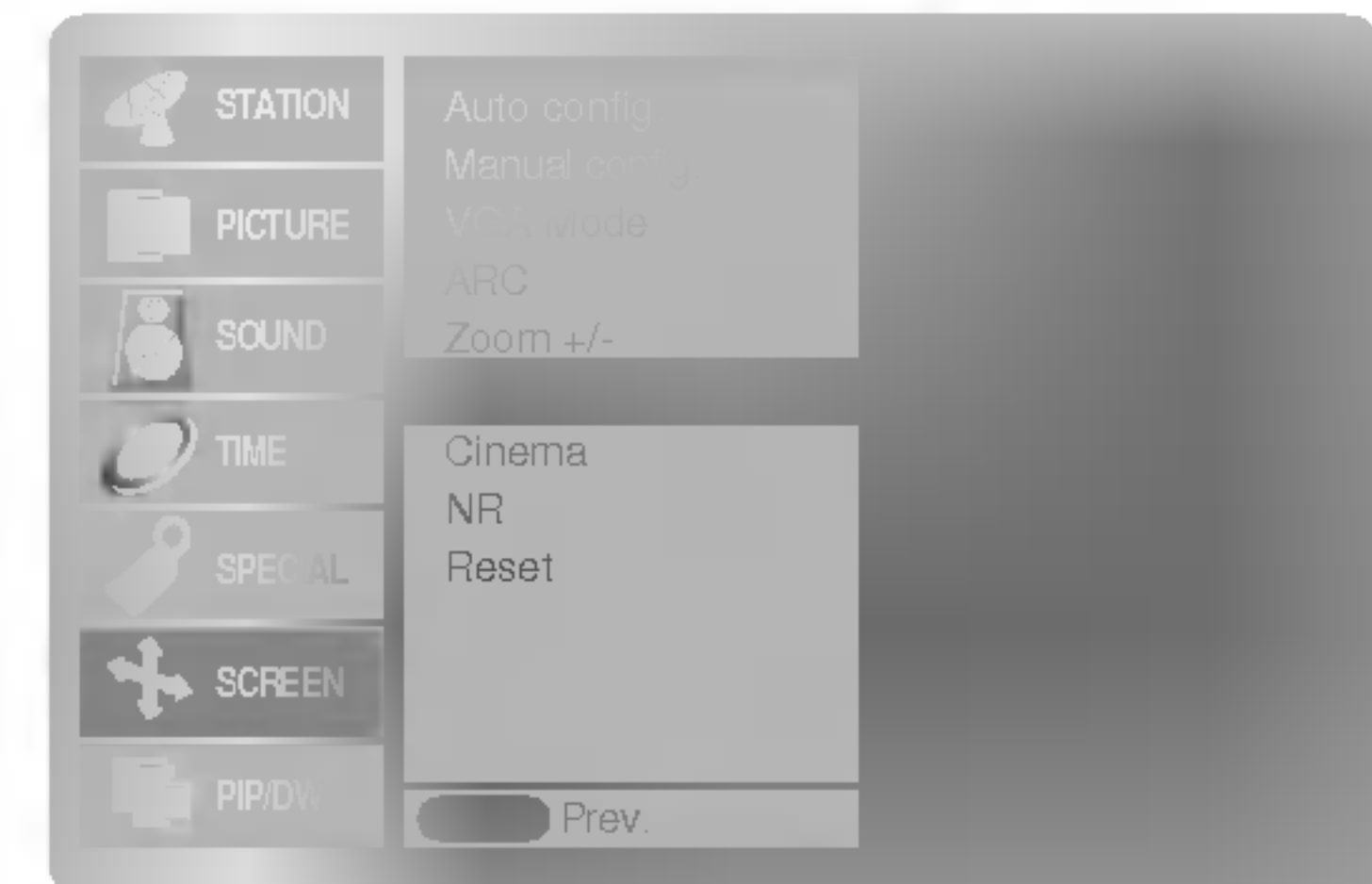

## Cinema

- When you watch the movie, this function adjusts the set to the best picture appearance.
- This function works in the following mode:  
TV, AV1, AV2, S-Video2, AV3, AV4, AV5 or COMPONENT 480i/576i.

  1. Press the **MENU** button and then use ▲ / ▼ button to select the SCREEN menu.
  2. Press the ► button and then use ▲ / ▼ button to select **Cinema**.
  3. Press the ► button and then use ▲ / ▼ button to select **On** or **Off**.
  4. Press the **EXIT** button to return to normal TV viewing.

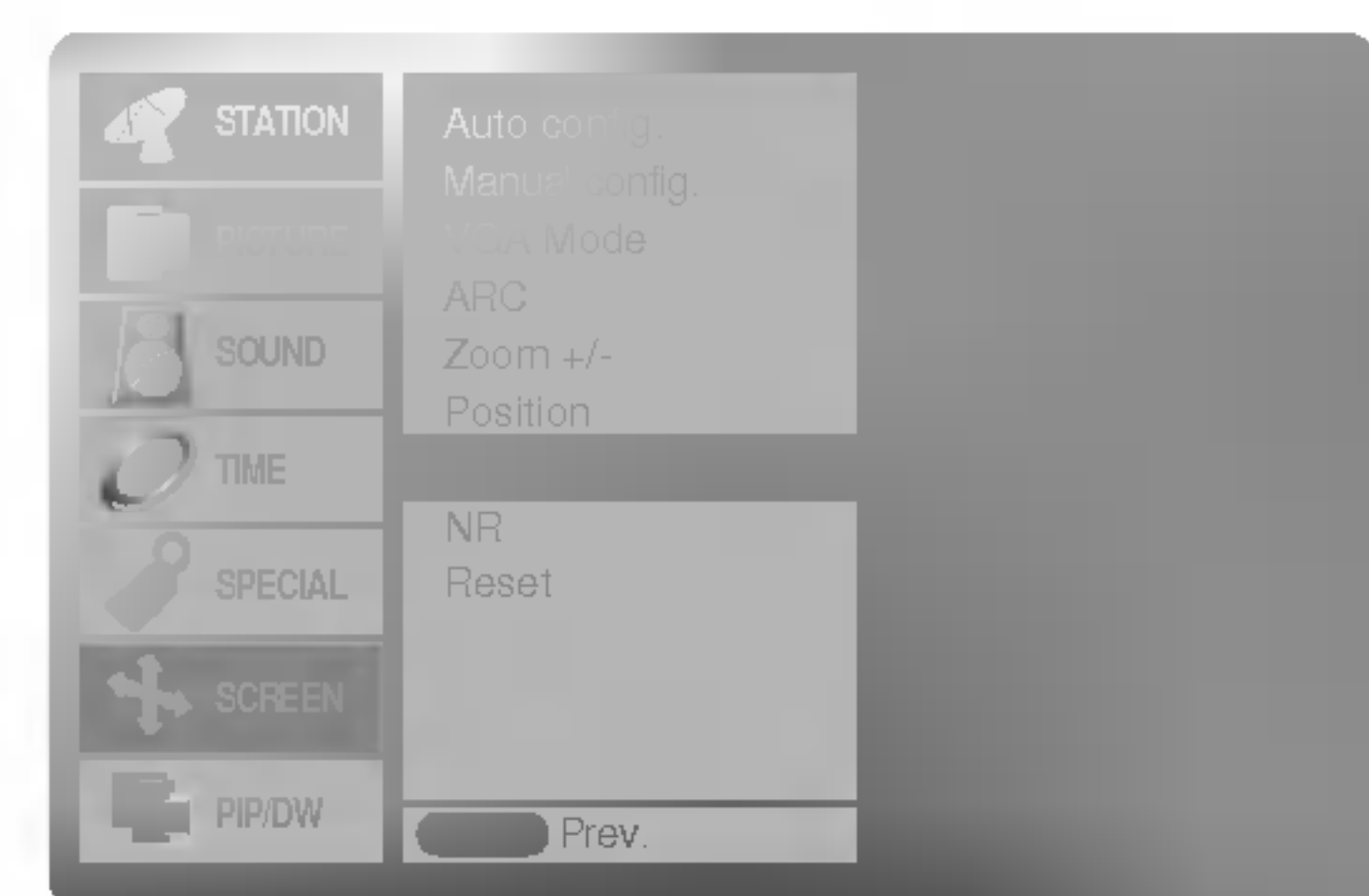

## NR (Noise Reduction)

- You can select **3D NR** or **MPEG NR** to reduce the picture noise which may appear on the screen during watching the TV.
- This function is not available for use in RGB[PC], HDMI[PC] mode.
- 3D NR is not available for use in RGB, HDMI, Component[DTV] mode.

  1. Press the **MENU** button and then use ▲ / ▼ button to select the SCREEN menu.
  2. Press the ► button and then use ▲ / ▼ button to select **NR**.
  3. Press the ► button and then use ▲ / ▼ button to select **3D NR** or **MPEG NR**.
  4. Press the ◀ / ▶ button to make appropriate adjustments.
  5. Press the **EXIT** button to return to normal TV viewing.



## Initializing (Reset to original factory value)

This function operates in current mode.  
To initialize the adjusted value

1. Press the **MENU** button and then ▲ / ▼ button to select the SCREEN menu.
2. Press the ► button and then ▲ / ▼ button to select **Reset**.
3. Press the ► button.
  - You can initialize Phase, Clock, H-Position, V-Position, Position, Zoom +/-, PIP size, PIP position, PIP Transparency and sub picture size of twin picture.

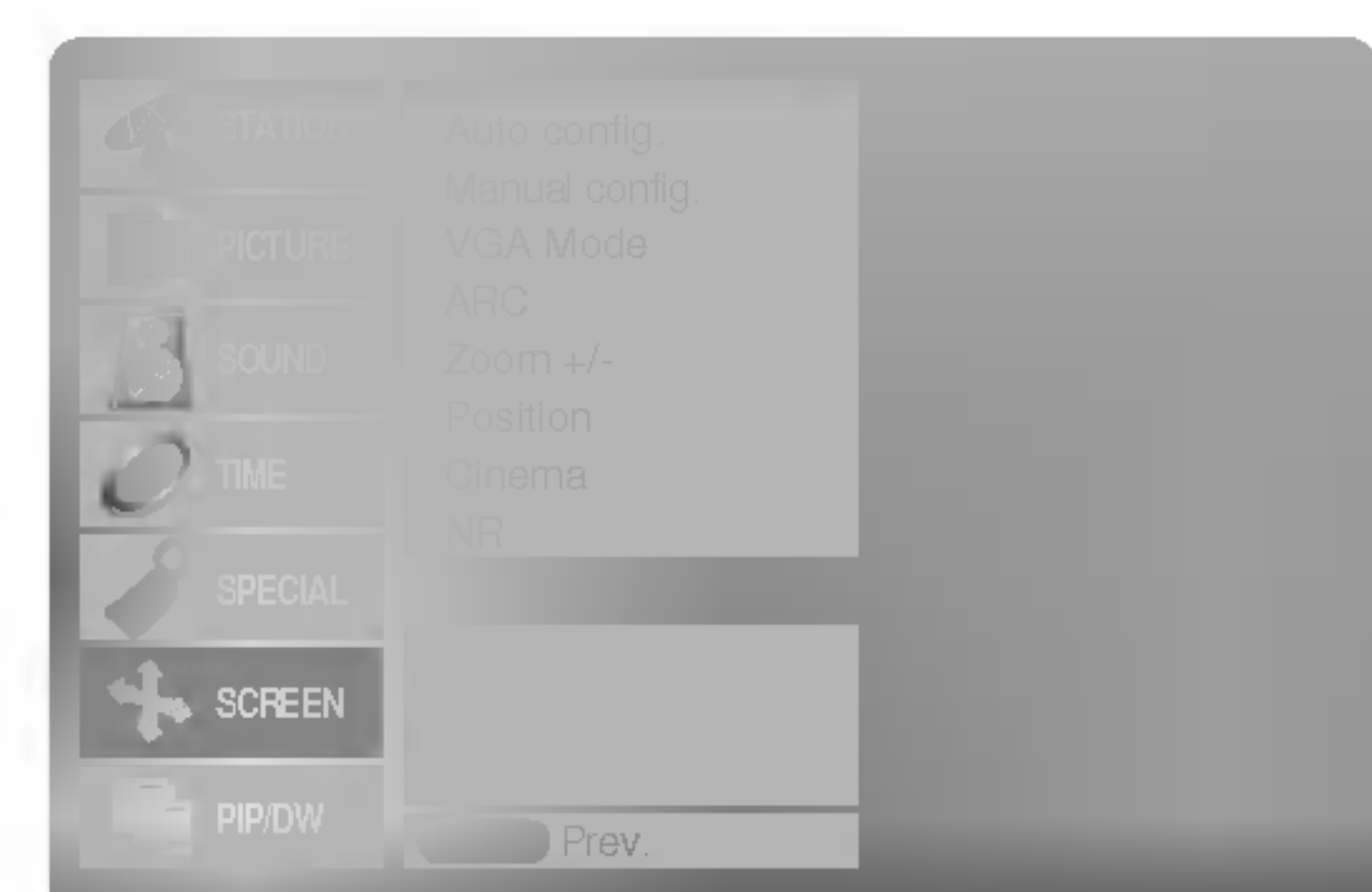

# PIP (Picture-in-Picture) Feature

- PIP lets you view 2 different inputs (sources) on your set screen at the same time.
- It's not available to use this function in TELETEXT mode.

## Watching PIP

Press the **PIP** button to show the sub picture.

- Each press of **PIP** button changes the screen display as shown below.

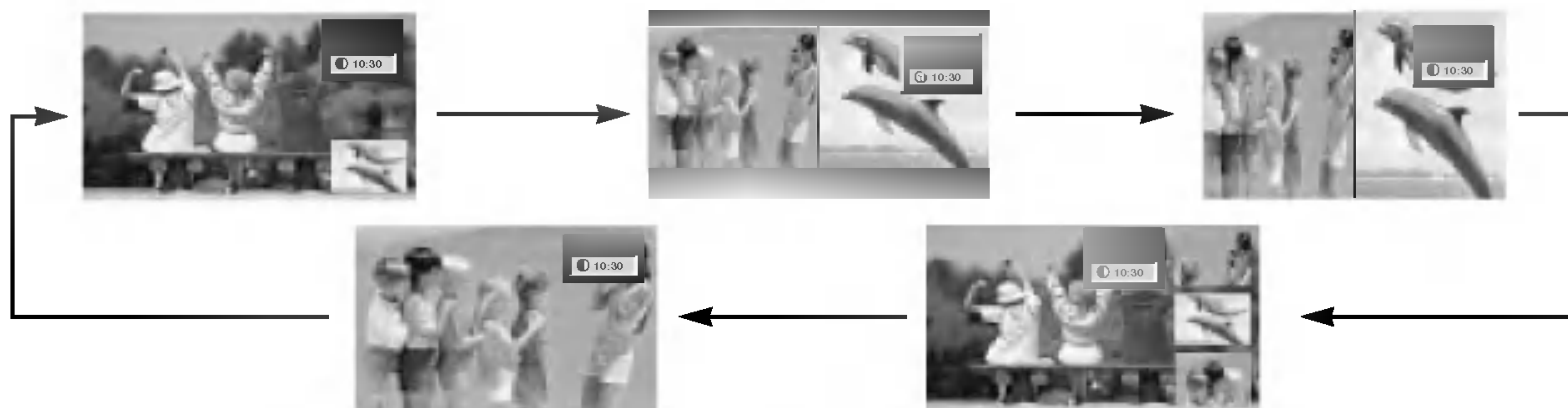

### Note :

- When the sub picture size is 1/2 of the main picture, the picture quality might get poor.
- The motion of the sub picture can be unnatural because the set displays full screen by synchronizing the main picture source when the refresh rate between the main picture source and the sub picture source is different in PIP mode.

## Programme Selection for Sub Picture

Press the **PIP PR +/-** button to select a programme for the sub picture.

## Selecting an Input Signal Source for the PIP

Press the **PIP INPUT** button to select the input source for the sub picture.

In some models, when the sub picture quality get poor for sub picture, select Auto, PAL, SECAM or NTSC in PIP System menu.



## Moving the PIP (PIP mode only)

Press the **POSITION** button.

Repeatedly press the **▲ / ▼** or **◀ / ▶** button until desired position is achieved. The sub picture moves up/down or left/right.



## Picture Size

Press the **SIZE** button and then **◀ / ▶** button to adjust the sub picture size.

With **SIZE** button in DW1, DW2 modes, main and sub picture is adjusted simultaneously. With **SIZE** button in PIP mode, sub picture is adjusted.



## POP (Picture-out-of-Picture: Channel Scan)

Use POP to search the programmes of all the memorized channels one-by-one on the 3 PIP screen display, (while the main picture source remains the current channel). The pictures of all the programmed channels are searched with the 3 POP screen.

## Adjusting PIP Transparency (PIP mode only)

1. Press the **MENU** button and then **▲ / ▼** button to select the PIP/DW menu.
2. Press the **▶** button and then **▲ / ▼** button to select **PIP Transparency**.
3. Press the **▶** button and then **◀ / ▶** button to adjust PIP transparency.
4. Press the **EXIT** button to return to normal TV viewing.

## Adjusting the screen for the PIP

- In TV or AV modes for the main picture and RGB[PC] for the sub picture, you can use Auto config and Manual config to adjust the screen of the sub picture.
- In TV or AV modes for main picture and HDMI[DTV] or Component 480p, 576p, 720p, 1080i for the sub picture, you can use Manual config to adjust the screen of the sub picture.



## Teletext (option)

- Teletext (or TOP text) is an optional function, therefore only the set with the teletext system can receive the teletext broadcast.
- Teletext is a free service broadcast by most TV stations which gives up-to-the-minute information on news, weather, television programmes, share prices and many other topics.
- The teletext decoder of this set can support the SIMPLE, TOP and FASTEXT systems. SIMPLE (standard teletext) consists of a number of pages which are selected by directly entering the corresponding page number. TOP and FASTEXT are more modern methods allowing quick and easy selection of teletext information.

### Switch on/off

Press the **TEXT/★** button to switch to teletext.

- The initial page or last page appears on the screen. Two page numbers, TV station name, date and time are displayed on the screen headline. The first page number indicates your selection, while the second shows the current page displayed.

Press the **TEXT/★** button to switch off teletext.

### SIMPLE Text (option)

#### Page selection

1. Enter the desired page number as a three digit number with the NUMBER buttons. If during selection you press a wrong number, you must complete the three digit number and then reenter the correct page number.
2. The **PR ▲ / ▼** button can also be used to select the preceding or following page.

#### Programming a colour button in LIST mode

If the TV is in SIMPLE text, TOP text or FASTEXT mode, press the **☰M** button to switch to LIST mode.

Four teletext page numbers of your choice can be colour coded and easily selected by pressing the corresponding coloured button on the remote control handset.

1. Press a coloured button.
2. Using the NUMBER buttons, select the page you wish to programme.
3. Press the **OK** button. The selected page is stored as the selected page number, blinking once to confirm this. From now on, you can select this page with the same coloured button.
4. The three other coloured buttons are programmed in this way.

### TOP Text (option)

The user guide displays four fields-red, green, yellow and blue at the bottom of the screen. The yellow field denotes the next group and the blue field indicates the next block.

#### Block / group / page selection

1. With the blue button you can progress from block to block.
2. Use the yellow button to proceed to the next group with automatic overflow to the next block.
3. With the green button you can proceed to the next existing page with automatic overflow to the next group. (Alternatively the **PR ▲** button can be used.)
4. The red button permits to return to previous selection. (Alternatively the **PR ▼** button can be used.)

#### Direct page selection

Corresponding to the SIMPLE text mode, you can select a page by entering it as a three digit number using the NUMBER buttons in TOP mode.



## FASTEXT

The teletext pages are colour coded along the bottom of the screen and are selected by pressing the corresponding coloured button.

### Page selection

1. Press the  button to select the index page.
2. You can select the pages which are colour coded along the bottom line with the same coloured buttons.
3. Corresponding to the SIMPLE text mode, you can select a page by entering its three digit page number with the NUMBER buttons in FASTEXT mode.
4. The PR ▲ / ▼ button can also be used to select the preceding or following page.

## Special Teletext Functions

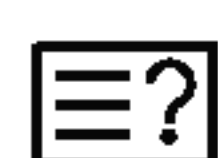

### REVEAL

Press this button to display concealed information, such as solutions of riddles or puzzles.

Press this button again to remove the information from the display.



### SIZE

Selects double height text.

Press this button to enlarge the top half of the page.

Press this button again to enlarge the bottom half of the page.

Press this button again to return to the normal display.



### UPDATE

Displays the TV picture on the screen while waiting for the new teletext page.

Press this button to view the updated teletext page.



### HOLD

Stops the automatic page change which will occur if a teletext page consists of 2 or more sub pages. The number of sub pages and the sub page displayed is, usually, shown on the screen below the time. When this button is pressed the stop symbol is displayed at the top left-hand corner of the screen and the automatic page change is inhibited.

To continue press this button again.



### MIX

Displays the teletext pages superimposed on the TV picture.

To switch the TV picture off press this button again.



### TIME

This button has two functions:

a) When viewing a TV programme, press this button to display the time at the top right hand corner of the screen. Press this button again to remove the display.

b) In teletext mode, press this button to select a sub page number. The sub page number is displayed at the bottom of the screen. To hold or change the sub page, press the RED/ GREEN or PR ▲ / ▼ buttons. Press this button again to exit this function.

# External Control Device Setup

- Connect the RS-232C input jack to an external control device (such as a computer or an A/V control system) and control the set's functions externally.

## How to connect external control equipment

- Connect the serial port of the control device to the RS-232C jack on the Monitor back panel.
- RS-232C connection cables are not supplied with the set.
- The set remote control and front panel controls (except main power) will not be functional if the Monitor is controlled by a PC computer or other external device.

< Back panel of the set >

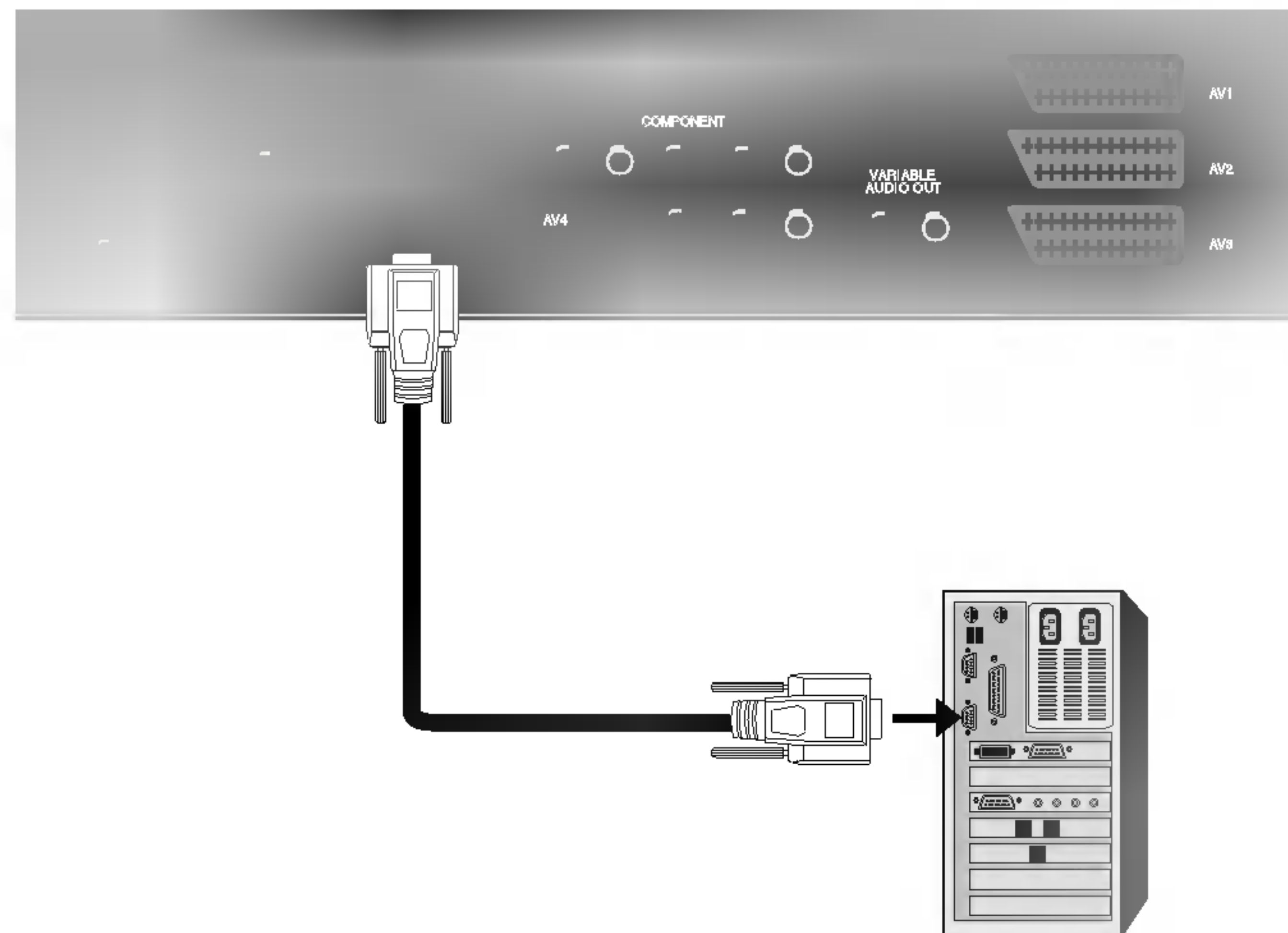

## Type of connector; D-Sub 9-pin male

No.	Pin name
1	No connection
2	RXD (Receive data)
3	TXD (Transmit data)
4	DTR (DTE side ready)
5	GND
6	DSR (DCE side ready)
7	RTS (Ready to send)
8	CTS (Clear to send)
9	No Connection

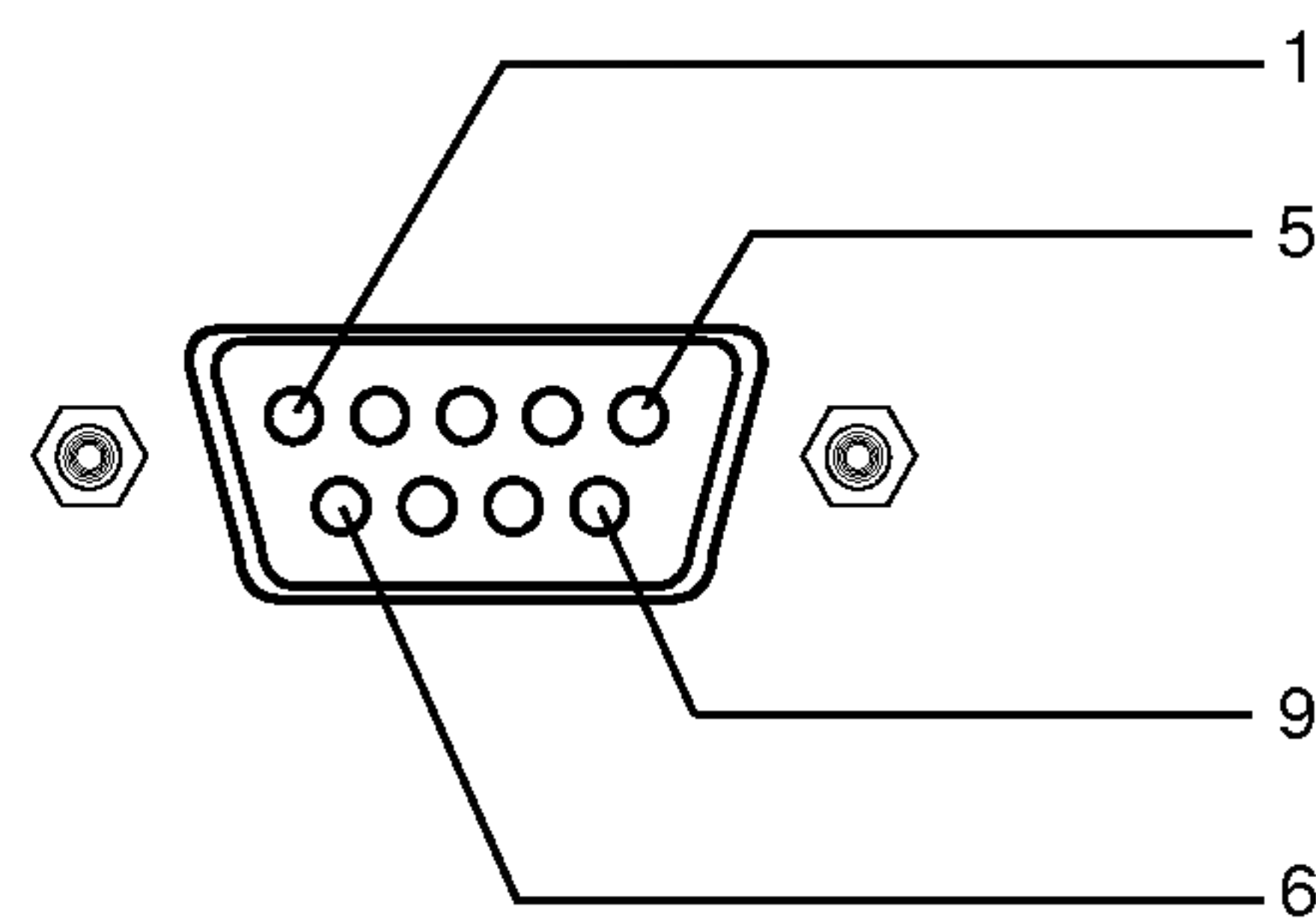

## RS-232C configurations

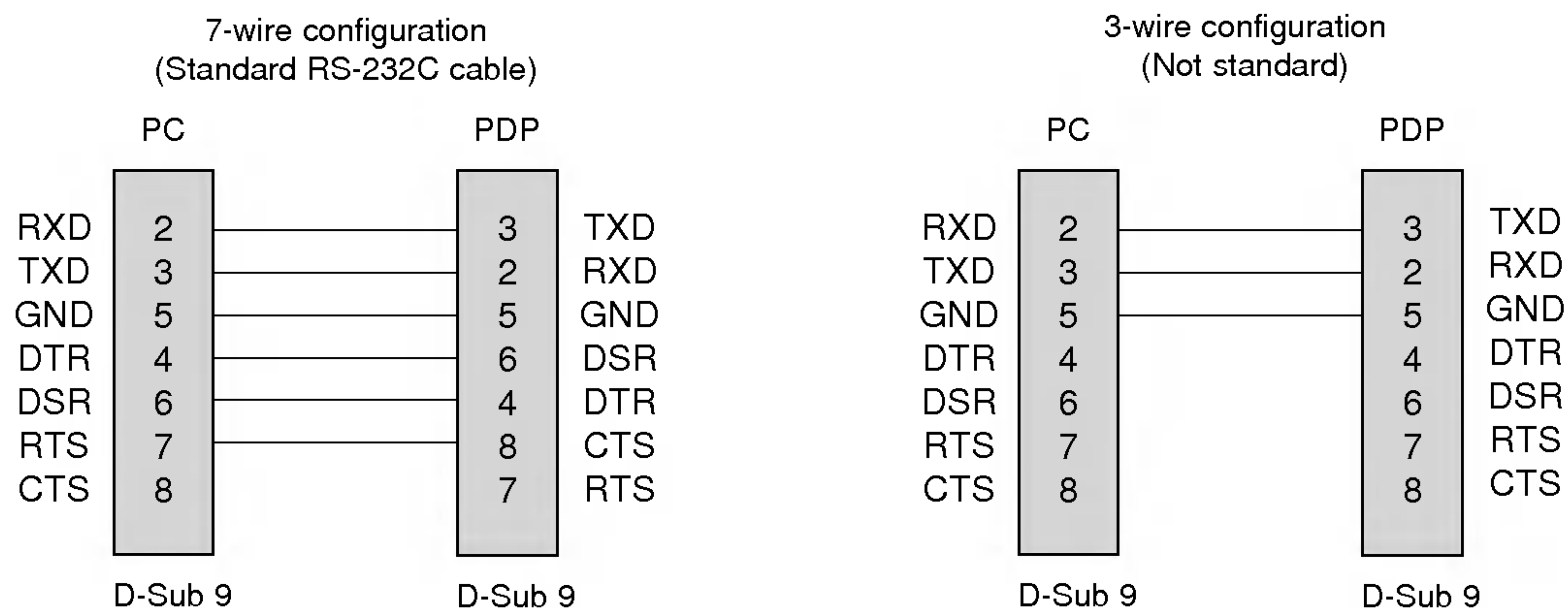

### Set ID

- Use this function to specify a set ID number.
- Refer to 'Real Data Mapping 1'. See page 40.

1. Press the **MENU** button and then use the ▲ / ▼ button to select the **SPECIAL** menu.
2. Press the ► button and then use ▲ / ▼ button to select **Set ID**.
3. Press the ► button and then use ◀ / ▶ button to adjust **Set ID** to choose the desired monitor ID number.
  - The adjustment range of **Set ID** is 1 ~ 99.
4. Press the **EXIT** button to return to normal TV viewing.

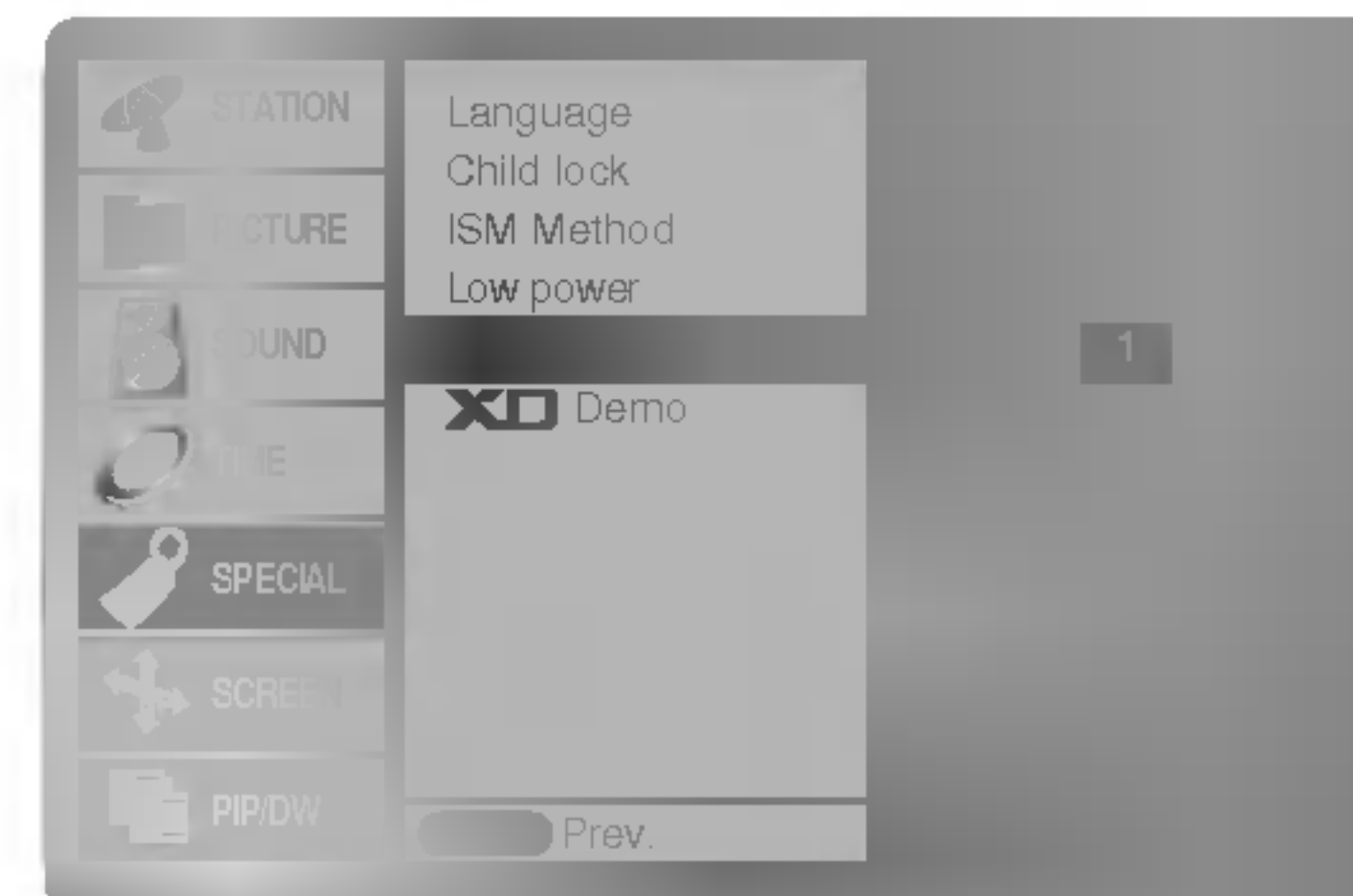

### Communication Parameters

- Baud rate : 9600 bps (UART)
- Data length : 8 bits
- Parity : None
- \* Use a crossed (reverse) cable.
- Stop bit : 1 bit
- Communication code : ASCII code

### Command Reference List

	COMMAND 1	COMMAND 2	DATA (Hexadecimal)
01. Power	k	a	0 ~ 1
02. Input Select	k	b	0 ~ 9
03. Aspect Ratio	k	c	Refer to p. 37
04. Screen Mute	k	d	0 ~ 1
05. Volume Mute	k	e	0 ~ 1
06. Volume Control	k	f	0 ~ 64
07. Contrast	k	g	0 ~ 64
08. Brightness	k	h	0 ~ 64
09. Colour	k	i	0 ~ 64
10. Tint (option)	k	j	0 ~ 64
11. Sharpness	k	k	0 ~ 64
12. OSD Select	k	l	0 ~ 1
13. Remote control lock mode	k	m	0 ~ 1
14. PIP/DW	k	n	Refer to p. 38
15. PIP Position	k	q	0 ~ 3
16. Treble	k	r	0 ~ 64
17. Bass	k	s	0 ~ 64
18. Balance	k	t	0 ~ 64
19. Colour Temperature (CSM)	k	u	0 ~ 3
20. Red Adjustment	k	v	0 ~ 50
21. Green Adjustment	k	w	0 ~ 50
22. Blue Adjustment	k	\$	0 ~ 50
23. PIP input Source	k	y	0 ~ 9
24. Abnormal Status	k	z	0 ~ a
25. ISM Method	j	p	0 ~ 3
26. Low Power	j	q	0 ~ 1
27. Orbiter Time Setting	j	r	1 ~ FE
28. Orbiter Pixel Setting	j	s	1 ~ 3
29. Picture Size	j	t	0 ~ 20
30. Auto Configure	j	u	1
31. Programme selection	m	a	0~63
32. Key	m	c	Key Code
33. Input select (Main)	x	b	Refer to p. 41
34. Input select (PIP)	x	y	Refer to p. 41

\* When setting the 23 ~ 32, a menu doesn't display on screen.

### Transmission / Receiving Protocol

#### Transmission

[Command1][Command2][ ][Set ID][ ][Data][Cr]

- \* [Command 1] : First command to control PDP set. (j or k)
- \* [Command 2] : Second command to control PDP set.
- \* [Set ID] : You can adjust the set ID to choose desired monitor ID number in special menu. Adjustment range is 1 ~ 99. When selecting Set ID '0', every connected PDP set is controlled. Set ID is indicated as decimal (1~99) on menu and as Hexa decimal (0x0~0x63) on transmission/receiving protocol.
- \* [DATA] : To transmit command data. Transmit 'FF' data to read status of command.
- \* [Cr] : Carriage Return ASCII code '0x0D'
- \* [ ] : ASCII code 'space (0x20)'

#### OK Acknowledgement

[Command2][ ][Set ID][ ][OK][Data][x]

- \* The Monitor transmits ACK (acknowledgement) based on this format when receiving normal data. At this time, if the data is data read mode, it indicates present status data. If the data is data write mode, it returns the data of the PC computer.

#### Error Acknowledgement

[Command2][ ][Set ID][ ][NG][Data][x]

- \* The Monitor transmits ACK (acknowledgement) based on this format when receiving abnormal data from non-viable functions or communication errors.

- Data 1: Illegal Code  
2: not support function  
3: Wait more time



**01. Power (Command 2 : a)**

- ▶ To control Power On/Off of the TV.

Transmission

```
[k][a][ ][Set ID][ ][Data][Cr]
```

Data 0 : Power Off                      1 : Power On

Ack

```
[a][ ][Set ID][ ][OK][Data][x]
```

- ▶ To show Power On/Off.

Transmission

```
[k][a][ ][Set ID][ ][FF][Cr]
```

Ack

```
[a][ ][Set ID][ ][OK][Data][x]
```

\* In like manner, if other functions transmit '0xFF' data based on this format, Acknowledgement data feed back presents status about each function.

**02. Input Select (Command 2 : b)**

- ▶ To select input source for the TV.  
You can also select an input source using the INPUT SELECT button on the Monitor's remote control.

Transmission

```
[k][b][ ][Set ID][ ][Data][Cr]
```

Data 0 : TV	5 : AV4
1 : AV1	6 : AV5
2 : AV2	7 : Component
3 : S-Video2	8 : RGB
4 : AV3	9 : HDMI

Ack

```
[b][ ][Set ID][ ][OK][Data][x]
```

**03. Aspect Ratio (Command 2 : c) (Main Picture Size)**

- ▶ To adjust the screen format. (Main picture format)  
You can also adjust the screen format using the ARC (Aspect Ratio Control) button on remote control or in the SCREEN menu.

Transmission

```
[k][c][ ][Set ID][ ][Data][Cr]
```

Data 1 : Normal screen (4:3)	6 : Original
2 : Wide screen (16:9)	7 : Wide screen (14:9)
3 : Spectacle	8 : Full (Option)
4 : Full screen (Zoom)	

Ack

```
[c][ ][Set ID][ ][OK][Data][x]
```

\* Using the PC input, you select either 16:9 or 4:3 screen aspect ratio.

**04. Screen Mute (Command 2 : d)**

- ▶ To select screen mute on/off.

Transmission

```
[k][d][ ][Set ID][ ][Data][Cr]
```

Data 0 : Screen mute off (Picture on)  
1 : Screen mute on (Picture off)

Ack

```
[d][ ][Set ID][ ][OK][Data][x]
```

**05. Volume Mute (Command 2 : e)**

- ▶ To control volume mute on/off.  
You can also adjust mute using the MUTE button on remote control.

Transmission

```
[k][e][ ][Set ID][ ][Data][Cr]
```

Data 0 : Volume mute off (Volume on)  
1 : Volume mute on (Volume off)

Ack

```
[e][ ][Set ID][ ][OK][Data][x]
```

**06. Volume Control (Command 2 : f)**

- ▶ To adjust volume.  
You can also adjust volume with the volume buttons on remote control.

Transmission

```
[k][f][ ][Set ID][ ][Data][Cr]
```

Data Min : 0 ~ Max : 64

\* Refer to 'Real data mapping 1'. See page 40.

Ack

```
[f][ ][Set ID][ ][OK][Data][x]
```

**07. Contrast (Command 2 : g)**

- ▶ To adjust screen contrast.  
You can also adjust contrast in the PICTURE menu.

Transmission

```
[k][g][ ][Set ID][ ][Data][Cr]
```

Data Min : 0 ~ Max : 64

\* Refer to 'Real data mapping 1'. See page 40.

Ack

```
[g][ ][Set ID][ ][OK][Data][x]
```

**08. Brightness (Command 2 : h)**

- ▶ To adjust screen brightness.  
You can also adjust brightness in the PICTURE menu.

Transmission

```
[k][h][ ][Set ID][ ][Data][Cr]
```

Data Min : 0 ~ Max : 64

\* Refer to 'Real data mapping 1'. See page 40.

Ack

```
[h][ ][Set ID][ ][OK][Data][x]
```

### 09. Colour (Command 2 : i)

- ▶ To adjust the screen colour.  
You can also adjust colour in the PICTURE menu.

Transmission

[k][i][ ][Set ID][ ][Data][Cr]

Data Min : 0 ~ Max : 64  
\* Refer to 'Real data mapping 1'. See page 40.

Ack

[i][ ][Set ID][ ][OK][Data][x]

### 10. Tint (Command 2 : j) (option)

- ▶ To adjust the screen tint.  
You can also adjust tint in the PICTURE menu.

Transmission

[k][j][ ][Set ID][ ][Data][Cr]

Data Red : 0 ~ Green : 64  
\* Refer to 'Real data mapping 1'. See page 40.

Ack

[j][ ][Set ID][ ][OK][Data][x]

### 11. Sharpness (Command 2 : k)

- ▶ To adjust the screen sharpness.  
You can also adjust sharpness in the PICTURE menu.

Transmission

[k][k][ ][Set ID][ ][Data][Cr]

Data Min : 0 ~ Max : 64  
\* Refer to 'Real data mapping 1'. See page 40.

Ack

[k][ ][Set ID][ ][OK][Data][x]

### 12. OSD Select (Command 2 : l)

- ▶ To select OSD (On Screen Display) on/off when controlling remotely.

Transmission

[k][l][ ][Set ID][ ][Data][Cr]

Data 0 : OSD off                    1 : OSD on

Ack

[l][ ][Set ID][ ][OK][Data][x]

### 13. Remote control lock mode (Command 2 : m)

- ▶ To lock the front panel controls on the monitor and remote control.

Transmission

[k][m][ ][Set ID][ ][Data][Cr]

Data 0 : Lock off                    1 : Lock on

Ack

[m][ ][Set ID][ ][OK][Data][x]

\* If you're not using the remote control, use this mode.  
When main power is on/off, external control lock is released.

### 14. PIP / DW (Command 2 : n)

- ▶ To control the PIP (Picture In picture)/DW.  
You can also control the PIP/DW using the PIP button on the remote control or in the PIP/DW menu.

Transmission

[k][n][ ][Set ID][ ][Data][Cr]

Data 0: PIP/DW off                    3: DW2  
1: PIP                                    5: POP  
2: DW1

Ack

[n][ ][Set ID][ ][OK][Data][x]

### 15. PIP Position (Command 2 : q)

- ▶ To select sub picture position for PIP.  
You can also adjust the sub picture position using POSITION button on the remote control or in the PIP/DW menu.

Transmission

[k][q][ ][Set ID][ ][Data][Cr]

Data 0 : Right down on screen  
1 : Left down on screen  
2 : Left up on screen  
3 : Right up on screen

Ack

[q][ ][Set ID][ ][OK][Data][x]

### 16. Treble (Command 2 : r)

- ▶ To adjust treble.  
You can also adjust treble in the SOUND menu.

Transmission

[k][r][ ][Set ID][ ][Data][Cr]

Data Min : 0 ~ Max : 64  
\* Refer to 'Real data mapping 1'. See page 40.

Ack

[r][ ][Set ID][ ][OK][Data][x]

### 17. Bass (Command 2 : s)

- ▶ To adjust bass.  
You can also adjust bass in the SOUND menu.

Transmission

[k][s][ ][Set ID][ ][Data][Cr]

Data Min : 0 ~ Max : 64  
\* Refer to 'Real data mapping 1'. See page 40.

Ack

[s][ ][Set ID][ ][OK][Data][x]

**18. Balance (Command 2 : t)**

- ▶ To adjust balance.  
You can also adjust balance in the SOUND menu.

Transmission

```
[k][t][ ][Set ID][ ][Data][Cr]
```

Data Min : 0 ~ Max : 64

\* Refer to 'Real data mapping 1'. See page 40.

Ack

```
[t][ ][Set ID][ ][OK][Data][x]
```

**19. Colour Temperature (Command 2 : u)**

- ▶ To adjust colour temperature.  
You can also adjust CSM in the PICTURE menu.

Transmission

```
[k][u][ ][Set ID][ ][Data][Cr]
```

Data 0: Cool 1: Normal 2: Warm 3: User

Ack

```
[u][ ][Set ID][ ][OK][Data][x]
```

**20. Red Adjustment (Command 2 : v)**

- ▶ To adjust red in colour temperature.

Transmission

```
[k][v][ ][Set ID][ ][Data][Cr]
```

Data Min : 0 ~ Max : 50

\* Refer to 'Real data mapping 2'. See page 40.

Ack

```
[v][ ][Set ID][ ][OK][Data][x]
```

**21. Green Adjustment (Command 2 : w)**

- ▶ To adjust green in colour temperature.

Transmission

```
[k][w][ ][Set ID][ ][Data][Cr]
```

Data Min : 0 ~ Max : 50

\* Refer to 'Real data mapping 2'. See page 40.

Ack

```
[w][ ][Set ID][ ][OK][Data][x]
```

**22. Blue Adjustment (Command 2 : \$)**

- ▶ To adjust blue in colour temperature.

Transmission

```
[k][$][ ][Set ID][ ][Data][Cr]
```

Data Min : 0 ~ Max : 50

\* Refer to 'Real data mapping 2'. See page 40.

Ack

```
[$][ ][Set ID][ ][OK][Data][x]
```

**23. PIP Input Select (Command 2 : y)**

- ▶ To select input source for sub picture in PIP/DW picture mode. You can also adjust input source for sub picture using PIP INPUT button on remote control.

Transmission

```
[k][y][ ][Set ID][ ][Data][Cr]
```

Data 0 : TV	5 : AV4
1 : AV1	6 : AV5
2 : AV2	7 : Component
3 : S-Video2	8 : RGB
4 : AV3	9 : HDMI

Ack

```
[y][ ][Set ID][ ][OK][Data][x]
```

**24. Abnormal State (Command 2 : z)**

- ▶ To recognize an abnormal state.

Transmission

```
[k][z][ ][Set ID][ ][FF][ ][Cr]
```

Data FF : Read

Ack

```
[z][ ][Set ID][ ][OK][Data][x]
```

Data 0: Normal (Power on and signal exist)

- 1: No signal (Power on)
- 2: Turn the TV off by remote control
- 3: Turn the TV off by sleep time function
- 4: Turn the TV off by RS-232C function
- 5: 5V down
- 6: AC down
- 7: Turn the TV off by Fan Alarm function (option)
- 8: Turn the TV off by Off time function
- 9: Turn the TV off by Auto sleep function

a: Turn the TV off by AV board detect

\* This function is "read only".

**25. ISM Method (Command 1 : j, Command 2 : p)**

- ▶ To control the ISM method. You can also adjust ISM Method in SPECIAL menu.

Transmission

```
[j][p][ ][Set ID][ ][Data][Cr]
```

Data 0 : Normal Mode	2 : Orbiter
1 : White Wash	3 : Inversion

Ack

```
[p][ ][Set ID][ ][OK][Data][x]
```



**26. Low Power**  
(Command 1 : j, Command 2 : q)

► To reduce the power consumption of the monitor. You can also adjust Low Power in SPECIAL menu.

Transmission

[j][q][ ][Set ID][ ][Data][ ][Cr]

Data 0 : Off  
1 : On

Ack

[q][ ][Set ID][ ][OK][Data][x]

**27. Orbiter Time Setting**  
(Command 1 : j, Command 2 : r)

► To adjust orbiter operation time term.

Transmission

[j][r][ ][Set ID][ ][Data][ ][Cr]

Data Min: 1 ~ Max: FE  
\* Refer to 'Real data mapping 1'.

Ack

[r][ ][Set ID][ ][OK][Data][x]

**28. Orbiter Pixel Setting**  
(Command 1 : j, Command 2 : s)

► To adjust pixel number in orbiter function.

Transmission

[j][s][ ][Set ID][ ][Data][Cr]

Data Min: 1 ~ Max: 3  
\* Refer to 'Real data mapping 1'.

Ack

[s][ ][Set ID][ ][OK][Data][x]

**29. Picture Size Setting for DW Mode**  
(Command 1 : j, Command 2 : t)

► To select the DW picture format.  
You can also select the DW picture format using the SIZE on the remote control.

Transmission

[j][t][ ][Set ID][ ][Data][Cr]

Data Min: 0 ~ Max: 20  
\* Refer to 'Real data mapping 1'.

Ack

[t][ ][Set ID][ ][OK][Data][x]

**30. Auto Configure**  
(Command 1 : j, Command 2 : u)

► To adjust picture position and minimize image shaking automatically. It works only in RGB (PC) mode.

Transmission

[j][u][ ][Set ID][ ][Data][Cr]

Data 1: To set

Ack

[u][ ][Set ID][ ][OK][Data][x]

**31. Programme selection**  
(Command 1 : m, Command 2 : a)

► To select a programme for the main picture.

Transmission

[m][a][ ][Set ID][ ][Data0][ ][Data1][ ][Data2][Cr]

Data0 Min: 0 ~ Max: 63 (0 ~ C7, 200Pr is on)  
\* Refer to 'Real data mapping 1'.

Data1 Don't care

Data2 0 : Main  
1 : Sub

Ack

[a][ ][Set ID][ ][OK][Data0][x]

* Real data mapping 1	
0	: Step 0
⋮	
A	: Step 10 (Set ID 10)
⋮	
F	: Step 15 (Set ID 15)
10	: Step 16 (Set ID 16)
⋮	
64	: Step 100
⋮	
6E	: Step 110
⋮	
73	: Step 115
74	: Step 116
⋮	
C7	: Step 199
⋮	
FE	: Step 254
FF	: Step 255

* Real data mapping 2	
0	: -40
1	: -39
2	: -38
⋮	
28	: 0
⋮	
4E	: +38
4F	: +39
50	: +40

**32. Key**  
(Command 1 : m, Command 2 : c)

► To send IR remote key code.

Transmission

[m][c][ ][Set ID][ ][Data][Cr]

Data Key code - Refer to page 43.

Ack

[c][ ][Set ID][ ][OK][Data][x]

**33. Input select (Command 1 : x, Command 2 : b)**  
(Main Picture Input)

► To select input source for TV

Transmission

[x][b][ ][Set ID][ ][Data][Cr]

Data Structure

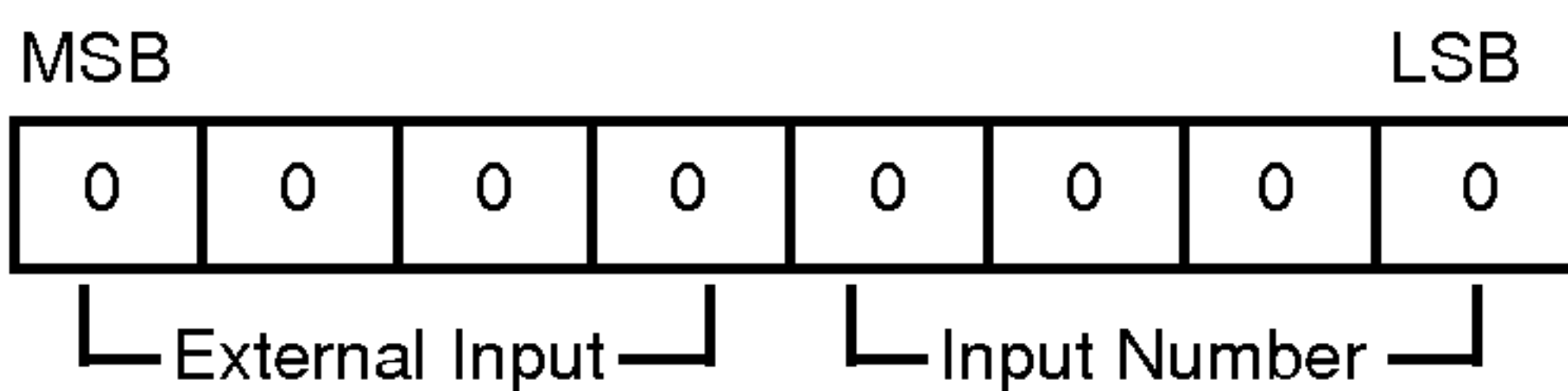

External Input				Data
0	0	0	1	Analog
0	0	1	0	AV
0	1	0	0	Component
0	1	0	1	RGB-DTV
0	1	1	0	RGB-PC
1	0	0	1	HDMI

Input Number				Data
0	0	0	0	Input1
0	0	0	1	Input2
0	0	1	0	Input3
0	0	1	1	Input4
0	1	0	0	Input5
0	1	0	1	Input6

Ack

[b][ ][Set ID][ ][OK][Data][x]

**34. Input select (Command 1 : x, Command 2 : y)**

► To adjust input source for sub picture in PIP mode

Transmission

[x][y][ ][Set ID][ ][Data][Cr]

Data Structure

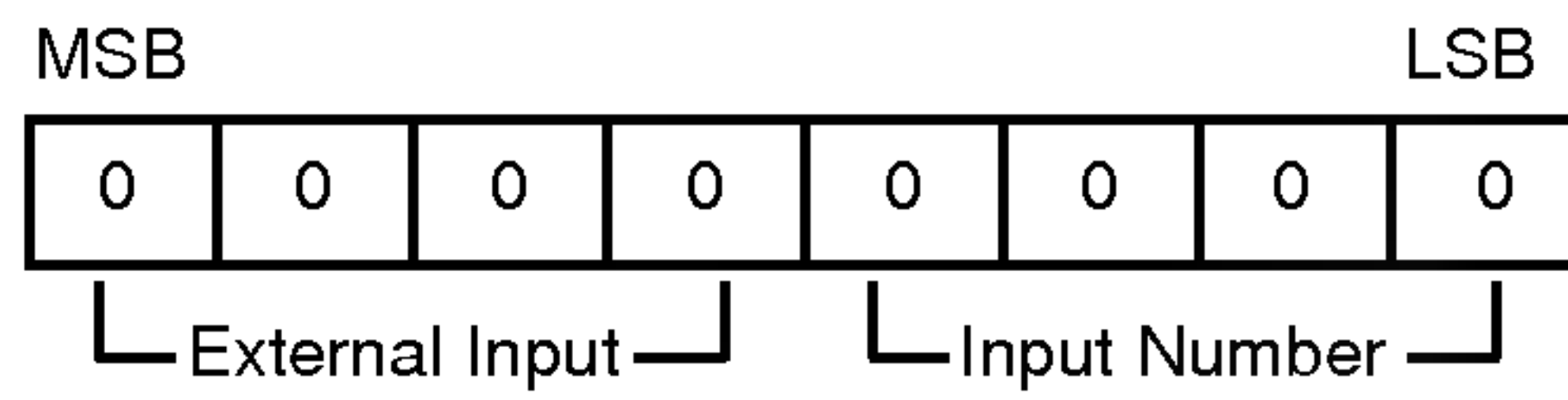

External Input				Data
0	0	0	1	Analog
0	0	1	0	AV
0	1	0	0	Component
0	1	0	1	RGB-DTV
0	1	1	0	RGB-PC
1	0	0	1	HDMI

Input Number				Data
0	0	0	0	Input1
0	0	0	1	Input2
0	0	1	0	Input3
0	0	1	1	Input4
0	1	0	0	Input5
0	1	0	1	Input6

Ack

[y][ ][Set ID][ ][OK][Data][x]

# IR Code (NEC Format)

## How to connect

- ▶ Connect your wired remote control to the Remote Control port on the Monitor.

## Remote Control IR Code (NEC Format)

### ▶ Output waveform

Single pulse, modulated with 37.917KHz signal at 455KHz

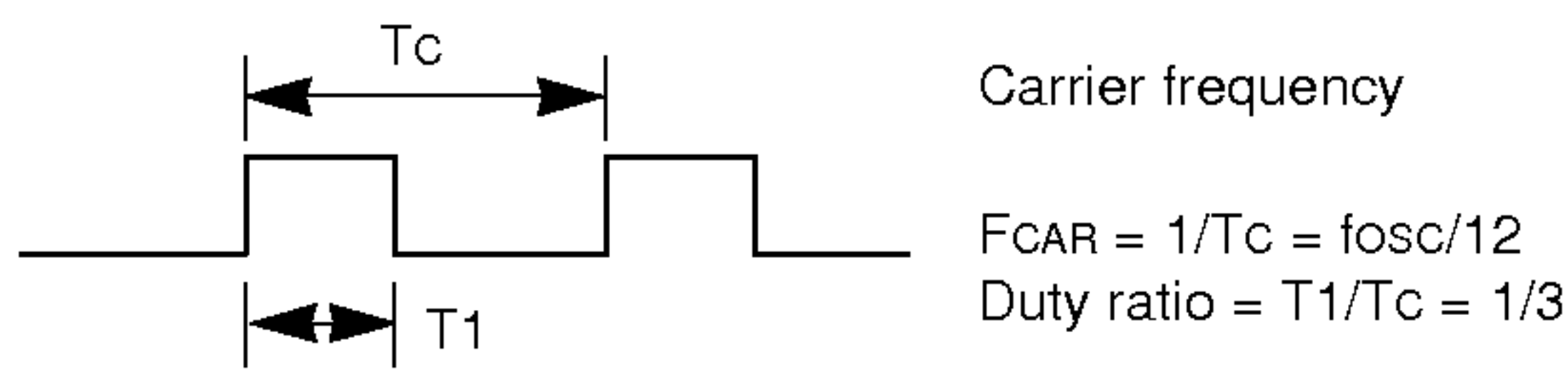

### ▶ Configuration of frame

- 1st frame

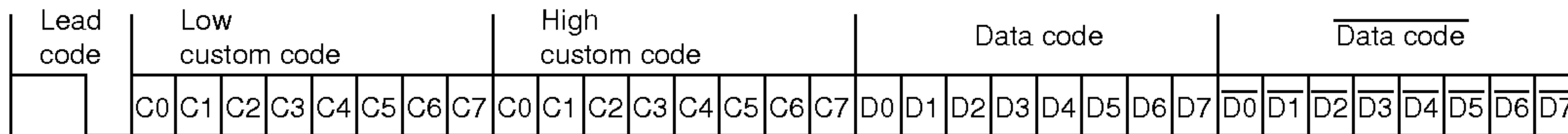

- Repeat frame

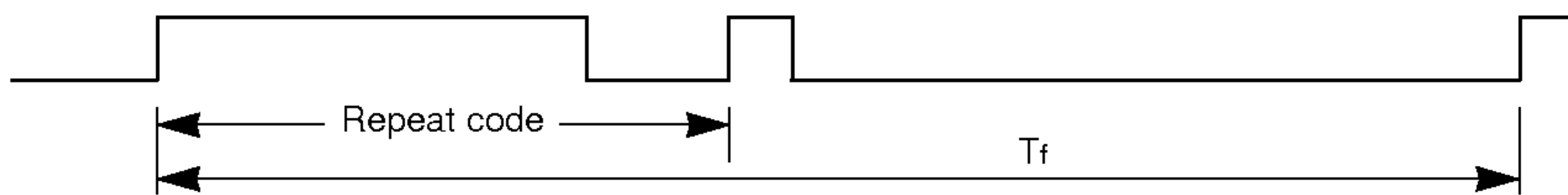

### ▶ Lead code

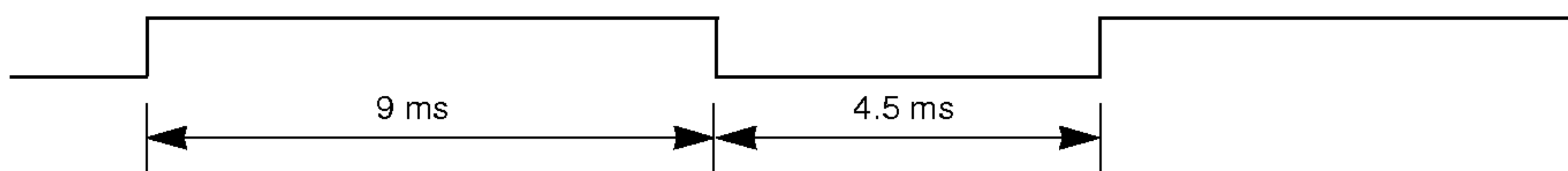

### ▶ Repeat code

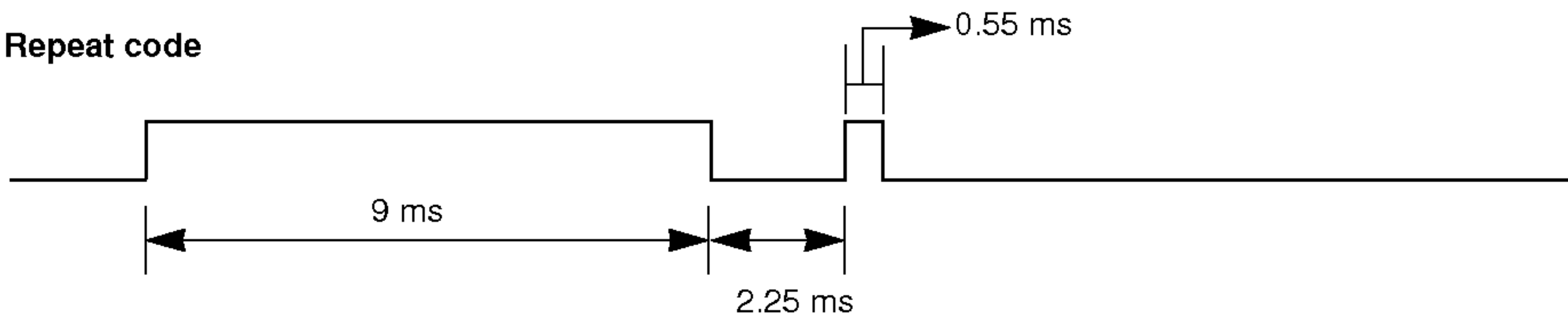

### ▶ Bit description

- Bit "0"

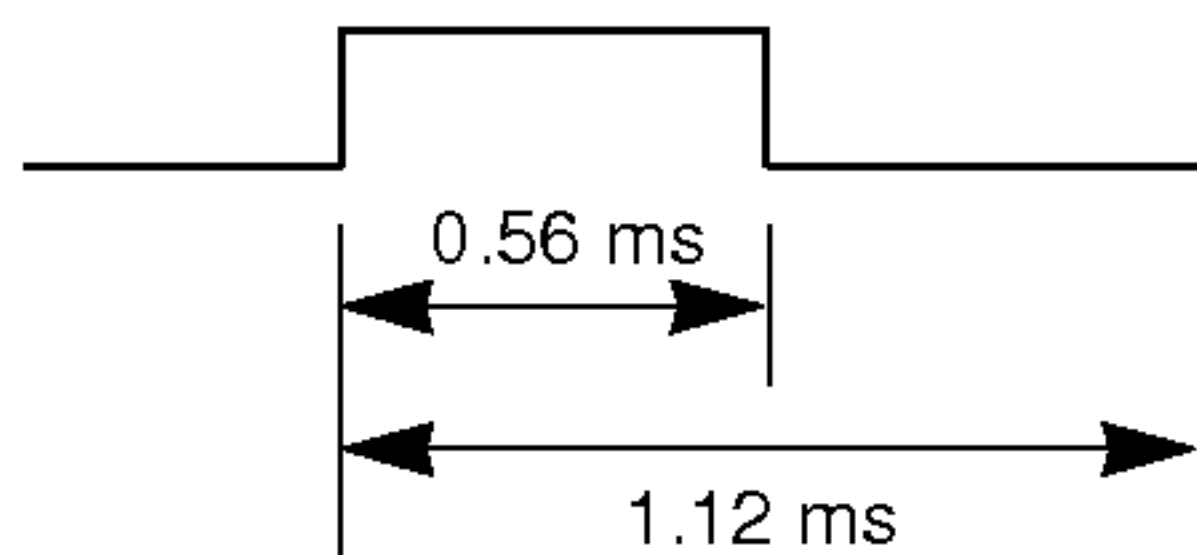

- Bit "1"

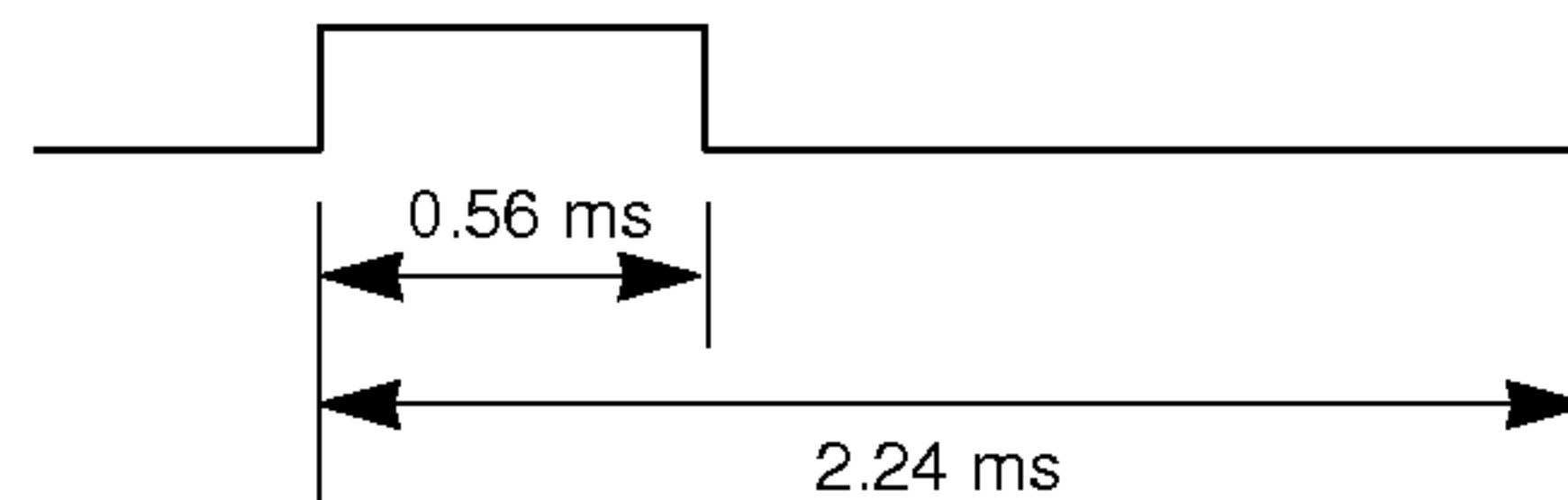

### ▶ Frame interval : Tf

The waveform is transmitted as long as a key is depressed.

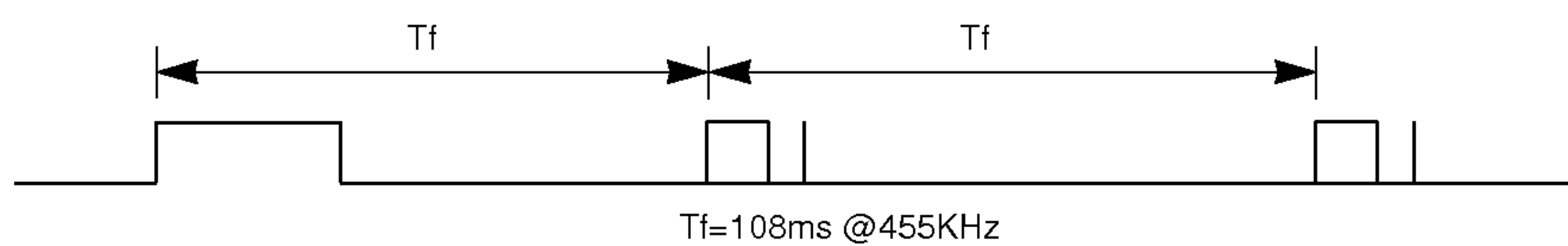



Code (Hexa)	Function	Note
00	PR+	R/C Button
01	PR-	R/C Button
02	VOL+	R/C Button
03	VOL-	R/C Button
40	▲	R/C Button
41	▼	R/C Button
06	►	R/C Button
07	◄	R/C Button
08	POWER	R/C Button (Power On/Off)
C4	POWER ON	Discrete IR Code (Only Power On)
C5	POWER OFF	Discrete IR Code (Only Power Off)
09	MUTE	R/C Button
10	Number Key 0	R/C Button
11	Number Key 1	R/C Button
12	Number Key 2	R/C Button
13	Number Key 3	R/C Button
14	Number Key 4	R/C Button
15	Number Key 5	R/C Button
16	Number Key 6	R/C Button
17	Number Key 7	R/C Button
18	Number Key 8	R/C Button
19	Number Key 9	R/C Button
0B	INPUT	R/C Button
98	MULTIMEDIA	R/C Button
BF	COMPONENT	Discrete IR Code (Input COMPONENT Selection)
C6	HDMI	Discrete IR Code (Input HDMI Selection)
D5	RGB	Discrete IR Code (Input RGB Selection)
D6	TV	Discrete IR Code (Input TV Selection)
5A	AV1	Discrete IR Code (Input AV1 Selection)
D0	AV2	Discrete IR Code (Input AV2 Selection)
D1	AV3	Discrete IR Code (Input AV3 Selection)
D2	AV4	Discrete IR Code (Input AV4 Selection)
CF	AV5	Discrete IR Code (Input AV5 Selection)
D3	S-Video2	Discrete IR Code (Input S-Video2 Selection)
1E	FAVOURITE	R/C Button
1A	Q.VIEW	R/C Button
0A	I/II	R/C Button
0E	SLEEP	R/C Button
43	MENU	R/C Button
44	OK(●)	R/C Button
4D	PSM	R/C Button
52	SSM	R/C Button
53	LIST	R/C Button
20	TEXT/*	R/C Button
2A	REVEAL	R/C Button
22	MODE	R/C Button
24	MIX	R/C Button
26	TIME	R/C Button
62	UPDATE / WIN.POSITION	R/C Button
64	SIZE / WIN.SIZE	R/C Button
65	HOLD	R/C Button
70	INDEX	R/C Button
60	PIP/DW	R/C Button
61	PIP INPUT	R/C Button
63	SWAP	R/C Button
71	PIP PR+	R/C Button
72	PIP PR-	R/C Button
5C	Zoom +	R/C Button
5D	Zoom -	R/C Button
79	ARC	R/C Button
76	ARC (4:3)	Discrete IR Code (Only 4:3 mode)
77	ARC (16:9)	Discrete IR Code (Only 16:9 mode)
AF	ARC (Zoom)	Discrete IR Code (Only Zoom mode)

## Programming the Remote

- ▶ The remote is a multi-brand or a universal remote. It can be programmed to operate most remote-controllable devices of other manufacturers.  
Note that the remote may not control all models of other brands.

### Programming a code into a remote mode

1. To find out whether your remote can operate the device without programming, turn on the device such as a VCR and press the corresponding mode button on the remote.  
After that, press the **POWER** button. If the device is turned off then it responds properly and the remote need not to be programmed. If not, the remote should be programmed to operate the device. The programming procedures are explained below.
2. Press the **MENU** and **MUTE** button continuously at the same time for 2 seconds, the current selected device button will be illuminated.  
If you don't press any button for 20 seconds, the light on the mode button will be turned off. In that case, you have to repeat from step 2.
3. Enter code numbers using the number button on the remote by referring the code table on the following pages. When pressing the button, the light blinks at a time. If the device turned off, the programming is successful.
4. Press the **MENU** button to store the code. After blinking twice, this code is stored.
5. Test the remote functions to see if the device responds properly. If not, repeat from step 2.

# Programming Codes

Brand	Codes	Brand	Codes	Brand	Codes	Brand	Codes
AIWA	034	KENWOOD	014 034 039 043	PORTLAND	108	TATUNG	039 043
AKAI	016 043 046 124		047 048	PULSAR	072	TEAC	034 039 043
	125 146	LG (GOLDSTAR)	001 012 013 020	QUARTZ	011 014	TECHNICS	031 033 070
AMPRO	072		101 106 114 123	QUASAR	033 066 075 145	TEKNIKA	019 031 033 034
ANAM	031 033 103	LLOYD	034	RCA	013 020 033 034		101
AUDIO DYNAMICS	012 023 039 043	LXI	003 009 013 014		040 041 062 063	THOMAS	034
BROKSONIC	035 037 129		017 034 101 106		107 109 140 144	TMK	006
CANON	028 031 033	MAGIN	040		145 147	TOSHIBA	008 013 042 047
CAPEHART	108	MAGNAVOX	031 033 034 041	REALISTIC	003 008 010 014		059 082 112 131
CRAIG	003 040 135		067 068		031 033 034 040	TOTEVISION	040 101
CURTIS MATHES	031 033 041	MARANTZ	012 031 033 067		053 054 101	UNITECH	040
DAEWOO	005 007 010 064		069	RICO	058	VECTOR RESEARCH	012
	065 108 110 111	MARTA	101	RUNCO	148	VICTOR	048
	112 116 117 119	MATSUI	027 030	SALORA	014	VIDEO CONCEPTS	012 034 046
DAYTRON	108	MEI	031 033	SAMSUNG	032 040 102 104	VIDEOSONIC	040
DBX	012 023 039 043	MEMOREX	003 010 014 031		105 107 109 112	WARDS	003 013 017 024
DYNATECH	034 053		033 034 053 072		113 115 120 122		031 033 034 040
ELECTROHOME	059		101 102 134 139		125		053 054 131
EMERSON	006 017 025 027	MGA	045 046 059	SANSUI	022 043 048 135	YAMAHA	012 034 039 043
	029 031 034 035	MINOLTA	013 020	SANYO	003 007 010 014	ZENITH	034 048 056
	036 037 046 101	MITSUBISHI	013 020 045 046		102 134		058 072 080 101
	129 131 138 153		049 051 059 061	SCOTT	017 037 112 129		
FISHER	003 008 009 010		151		131		
FUNAI	034	MTC	034 040	SEARS	003 008 009 010		
GE	031 033 063 072	MULTITECH	024 034		013 014 017 020		
	107 109 144 147	NEC	012 023 039 043		031 042 073 081		
GO VIDEO	132 136		048		101		
HARMAN KARDON	012 045	NORDMENDE	043	SHARP	031 054 149		
HITACHI	004 018 026 034	OPTONICA	053 054	SHINTOM	024		
	043 063 137 150	PANASONIC	066 070 074 083	SONY	003 009 031 052		
INSTANTREPLAY	031 033		133 140 145		056 057 058 076		
JCL	031 033	PENTAX	013 020 031 033		077 078 149		
JCPENNY	012 013 015 033		063	SOUNDESIGN	034		
	040 066 101	PHILCO	031 034 067	STS	013		
JENSEN	043	PHILIPS	031 033 034 054	SYLVANIA	031 033 034 059		
JVC	012 031 033 043		067 071 101		067		
	048 050 055 060	PILOT	101	SYMPHONIC	034		
	130 150 152	PIONEER	013 021 048	TANDY	010 034		

Brand	Codes	Brand	Codes	Brand	Codes	Brand	Codes
ABC	003 004 039 042	GOLDEN CHANNEL	030		065 085 090	SPRUCER	047 078
	046 052 053	HAMLIN	049 050 055	PIONEER	034 051 052 063	STARCOM	002 004 008 009
AJIN	112	HITACHI	052 055		076	STARGATE	008 030
ANTRONIK	014	HOSPITALITY	070 077	POST NEWS WEEK	016	TADIRAN	030
ARCHER	005 007 014 024	JERROLD	002 003 004 008	PRUCER	059	TAEKWANG	110
CABLE STAR	026		009 010 052 069	PTS	011 048 071 072	TAIHAN	105
CENTURION	092		074		073 074	TANDY	017
CENTURY	007	LG (GOLDSTAR)	001 106 101 005	PULSAR	100	TEXSCAN	029
CITIZEN	007	M-NET	037	RCA	047	TOCOM	039 040 056
COLOUR VOICE	065 090	MACOM	033	REGAL	049 050	TOSHIBA	100
COMBANO	080 081	MAGNAVOX	010 012 064 079	REGENCY	057	UNIKA	007 014 024
COMTRONICS	019 030	MEMOREX	100	REMBRANT	025	UNITED CABLE	004 053
DIAMOND	023	MOVIE TIME	028 032	SAMSUNG	102 107 030 068	UNIVERSAL	005 007 014 024
EAGLE	020 030 040	NSC	015 028 038 071	SCIENTIFIC ATLANTA	003 011 041 042		026 027 032 035
EASTERN	057 062 066		073		043 045 046	VIEWSTAR	012 015 018 086
ELECTRICORD	032	OAK	016 031 037 053	SHERITECH	022		087 088 089
GE	072	PANASONIC	044 047	SIGNAL	030	ZENITH	100 114 060 093
GEMINI	008 022 025 054	PARAGON	100	SIGNATURE	052		
GI	052 074	PHILIPS	006 012 013 020	SL MARX	030		



# Programming Codes

Brand	Codes	Brand	Codes	Brand	Codes	Brand	Codes
ALPHASTAR DSR	123		133 134	PACE SKY SATELLITE	143		088 090 107 130
AMPLICA	050	GENERAL INSTRUMENT	003 004 016 029	PANASONIC	060 142		137
BIRDVIEW	051 126 129		031 059 101	PANSAT	121	TOSHIBA	002 127
CHANNEL MASTER	013 014 015 018	HITACHI	139 140	PERSONAL CABLE	117	UNIDEN	016 025 042 043
	036 055	HOUSTON TRACKER	033 037 039 051	PHILIPS	071		044 045 048 049
CHAPARRAL	008 009 012 077		057 104	PICO	105		078 079 080 086
CITOH	054	HUGHES	068	PRESIDENT	019 102		101 135 136
CURTIS MATHES	050 145	JANIEL	060 147	PRIMESTAR	030 110 111	VIEWSTAR	115
DRAKE	005 006 007 010	JERROLD	061	PROSAT	072	WINEGARD	128 146
	011 052 112 116	KATHREIN	108	RCA	066 106	ZENITH	081 082 083 084
	141	LEGEND	057	REALISTIC	043 074		091 120
DX ANTENNA	024 046 056 076	LG	001	SAMSUNG	123		
ECHOSTAR	038 040 057 058	LUTRON	132	SATELLITE SERVICE CO	028 035 047 057		
	093 094 095 096	LUXOR	062 144		085		
	097 098 099 100	MACOM	010 059 063 064	SCIENTIFIC ATLANTA	032 138		
	122		065	SONY	103		
ELECTRO HOME	089	MEMOREX	057	STARCAST	041		
EUROPLUS	114	NEXTWAVE	028 124 125	SUPER GUIDE	020 124 125		
FUJITSU	017 021 022 027	NORSAT	069 070	TEECOM	023 026 075 087		

Brand	Codes	Brand	Codes	Brand	Codes	Brand	Codes
AIWA	014 028 070 096	JVC	004 013 141	PHILIPS	026 112 143		147 218
	125 129 139 229	KEC	185 186 187	PIONEER	039 042 043 063	TOSHIBA	137
	230	KENWOOD	038 050 067 089		065 091 093 094	THE	061
AKAI	163		170 171 197 206		115 123 127 250	VICTOR	088 131
ANAM	003 014 017 023		215 222	QUASAR	113	WARDS	089
	059 106 189 216	KOHEL	030	RCA	080	YAMAHA	054 055 066 092
	217 235 236	NAD	045 046	RCX	092		199
BURMECTER	252	LOTTE	014 016 036 098	REALISTIC	103 106		
CARVER	086		100 172 173 174	SAMSUNG	124 145 146 182		
CLARION	199		175 176 177 178		193 194 195 203		
DAEWOO	027 053 060 084		179 180 181 183		204 244 245 246		
	102 148 198 221		201 202 208 213	SANSUI	011 135 138 144		
DENON	015 075 130 143		214 219 223 232	SANYO	019 083 234		
FANTASIA	071		238 240	SCOTT	106 186		
FINEARTS	022	LXI	103	SHARP	031 032 051 052		
FISHER	089 099	MAGNAVOX	111		072 082 117 119		
LG(GOLDSTAR)	001 021 024 029	MARANTZ	002 018 020 025		156 184 199 200		
	087 107 108 110		034 041 081 090		206 209		
	190 191 192 210		097 112	SHERWOOD	005 006 158		
	211 212 239	MCINTOSH	049	SONY	044 045 109 114		
HAITAI	034 035 188 222	MCS	104		118 126 248 249		
HARMAN/KARDON	068	MEMOREX	107	TAEKWANG	012 020 073 074		
INKEL	037 058 062 069	NAD	046		076 077 105 161		
	078 079 095 121	ONKYO	013 040 041 047		162 163 164 165		
	122 149 150 151		048 056 057 132		166 167 168 169		
	152 153 154 155		133 140		205 231 233 242		
	157 158 159 160	OPTIMUS	158	TEAC	010 085 106 136		
	189 207 222 224	PANASONIC	007 033 064 113		185 187 237		
	225 226 227 243		142 220 241 251	TECHNICS	101 113 128 134		
	247	PENNEY	104				

Brand	Codes	Brand	Codes	Brand	Codes	Brand	Codes
APEX DIGITAL	022	MAGNAVOX	013	PHILIPS	013	SONY	007
DENON	020 014	MARANTZ	024	PIONEER	004 026	THOMPSON	005 006
GE	005 006	MITSUBISHI	002	PROCEED	021	TOSHIBA	019 008
HARMAN KARDON	027	NAD	023	PROSCAN	005 006	YAMAHA	009 018
JVC	012	ONKYO	008 017	RCA	005 006	ZENITH	010 016 025
LG	001 010 016 025	PANASONIC	003 009	SAMSUNG	011 015		

# Notes

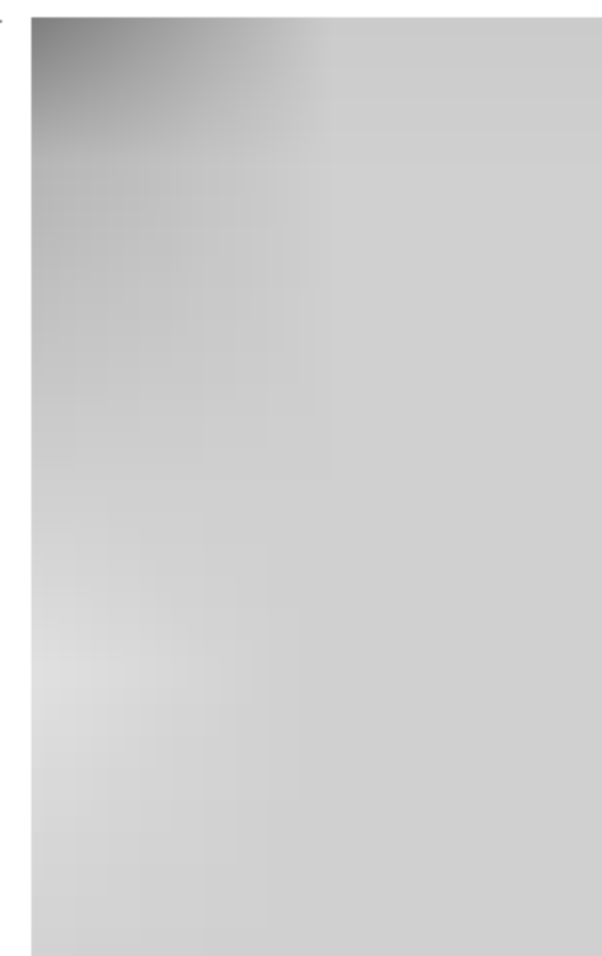

# Notes



# Notes



# Troubleshooting Checklist

<b>No picture &amp; No sound</b>	<ul style="list-style-type: none"><li>• Check whether the set is turned on.</li><li>• Power cord inserted into wall outlet?</li><li>• Plug another product's power cord into the wall outlet where the set's power cord was plugged in.</li></ul>
<b>Picture OK &amp; No sound</b>	<ul style="list-style-type: none"><li>• Press the <b>VOLUME</b> (▶) button.</li><li>• Sound muted? Press <b>MUTE</b> button.</li><li>• Check whether the TV speaker is "on" in the SOUND menu.</li></ul>
<b>The remote control doesn't work</b>	<ul style="list-style-type: none"><li>• Check to see if there is any object between the set and the remote control causing obstruction.</li><li>• Check to see if the batteries are installed with the correct polarities. (Refer to p.6)</li><li>• Check if the remote control handset is set up to correct mode.</li><li>• Install new batteries. (Refer to p.6)</li></ul>
<b>Picture appears slowly, after switching on</b>	<ul style="list-style-type: none"><li>• This is normal as the image is muted during the startup process of the set. Please contact your service centre, if the picture has not appeared after five minutes.</li></ul>
<b>No or Poor colour or Poor picture</b>	<ul style="list-style-type: none"><li>• Select <b>Colour</b> in the PICTURE menu and press the <b>VOLUME</b> (▶) button. (Refer to p.23)</li><li>• Keep a certain distance between the set and the VCR.</li><li>• Activate any function to restore the brightness of the picture. (If still picture is on the screen for more than 5 minutes, the screen gets dark.)</li></ul>
<b>Horizontal/vertical bars or picture shaking</b>	<ul style="list-style-type: none"><li>• Check for local interference such as an electrical appliance or power tool.</li></ul>
<b>No output from one of the speakers</b>	<ul style="list-style-type: none"><li>• Adjust <b>Balance</b> in the SOUND menu. (Refer to p.24)</li></ul>
<b>Unusual sound from inside the set</b>	<ul style="list-style-type: none"><li>• A change in ambient humidity or temperature may result in an unusual noise at the time of switching off or on of the set and does not indicate a fault with the set.</li></ul>

# Product Specifications

Width (inches / mm)	49.3 / 1252	49.3 / 1252	49.3 / 1252
Height (inches / mm)	27.78 / 705.5	27.78 / 705.5	27.8 / 706.5
Depth (inches / mm)	11.29 / 286.7	11.29 / 286.7	10.7 / 270.7
Weight (pounds / kg)	84.9 / 38.5	70.06 / 31.78	76.72 / 34.8
Power requirement	AC100-240V, 50/60Hz		
Operating Temperature Range	32 ~ 104°F (0 ~ 40°C)		
Operating Humidity Range	Less than 80%		

Width (inches / mm)	55.1 / 1400
Height (inches / mm)	32.3 / 821
Depth (inches / mm)	3.9 / 99
Weight (pounds / kg)	115 / 52.15
Power requirement	AC100-240V, 50/60Hz
Operating Temperature Range	32 ~ 104°F (0 ~ 40°C)
Operating Humidity Range	Less than 80%

- The specifications shown above may be changed without notice for quality improvement.



