

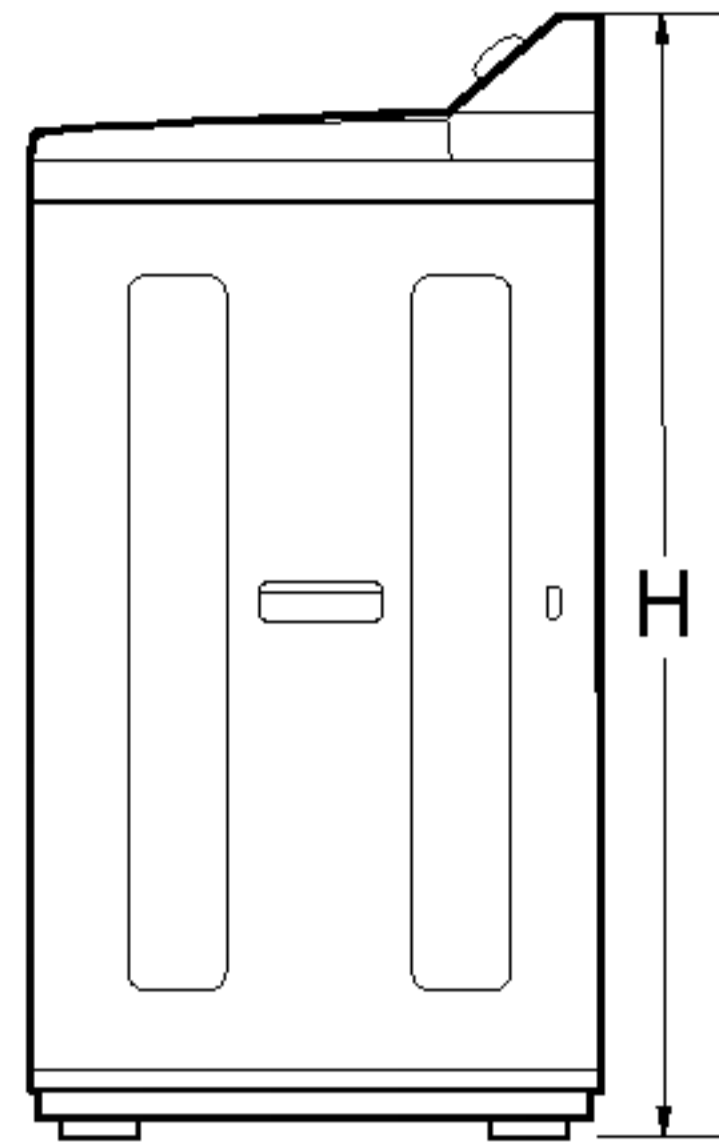

Washing Machine OWNER'S MANUAL

MODEL : □ WP-1300Q(S)(P)/WP-1310Q(S)(P)
 □ WP-1380Q(S)(P)/WP-1410Q(S)(P)
 □ WP-1500R(S)(P)/WP-1510R(S)(P)
 □ WP-1520R(S)(P)/WP-1580R(S)(P)
 □ WP-1300QB/WP-1300QPB

Please read the operating instructions carefully and thoroughly before installing and operating your washing machine.
 This washing machine is designed and manufactured for household use only.

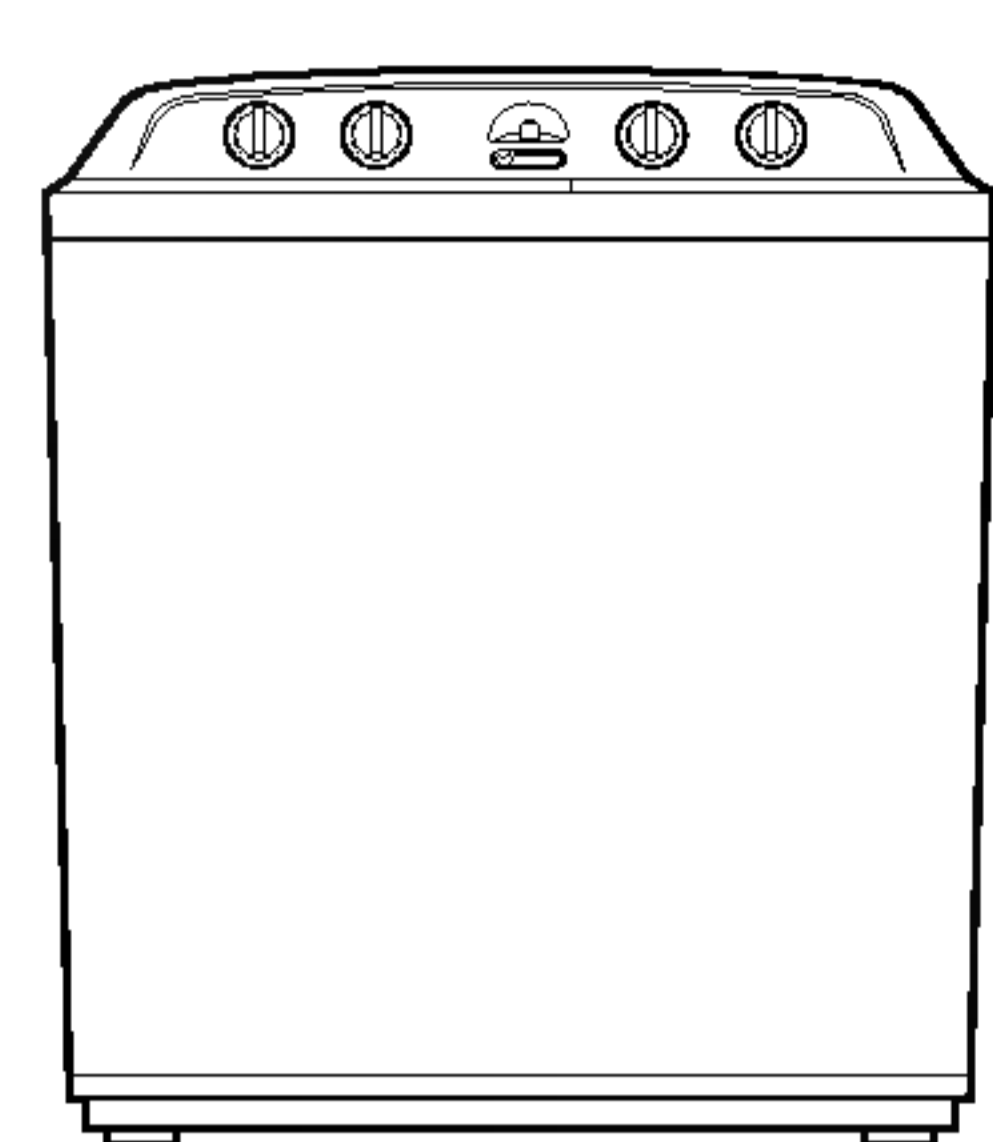
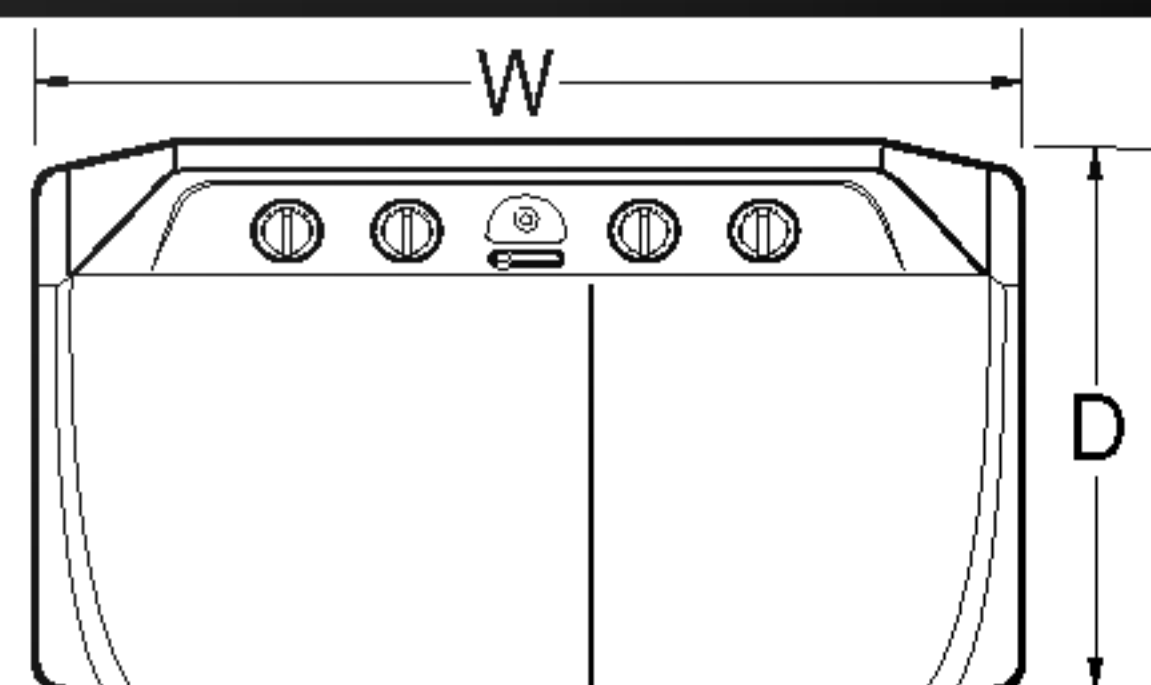

Power source	ON SPECIFICATION LABEL
Water Level	H : 88ℓ , M : 76ℓ , L : 65ℓ , S : 54ℓ
Water Pressure	Less than 100kPa (1kgf/cm ²)
Dimension	895 X 530 X 1022 mm. (W X D X H)
Weight	For Non-Pump Model 38.0 kg
	For Pump Model 38.6 kg

How to read the manufactured month and year from the label stuck on the back of the product.

EX) 4 1 2 T W 0 0 0 1
 Serial No.
 Product code
 Month
 Year (The last digit to year)

Part name
 - WASH MOTOR
 - SPIN MOTOR
 - S.D. BASKET
 - CYCLE TIMER ASSEMBLY
 - CAPACITOR
 - GEAR CASE ASM

Remark
 105 W (Output)
 105 W (Output)
 PLASTIC

P/No. : 3828EY3045A

Specification

(Q,R) : Pulsator Type
 (S) : See Through Cover Only
 (P) : Pump Model Only

CAUTION

Installation Area

● Avoid area exposed to snow, rain, or where humidity is high. It may cause electric shock.



Heat

● Avoid electric heater, candle light, cigarette light, bug smoker, etc. near the machine. It may ignite or deform plastic part.

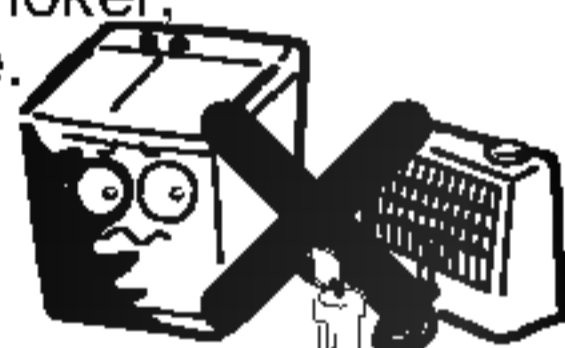

Switch Area

● Avoid watering on the switch area. It may cause electric shock or fire.



Hot water

● Avoid using hot water over 50°C. It may deform plastic parts or cause malfunction.



Volatile Material

● Do not use volatile material such as Benzene, Gasoline, bug killer. Do not leave strong alkaline substance such as bleach inside the tub. Damage on plastic surface and rubber parts may occur.

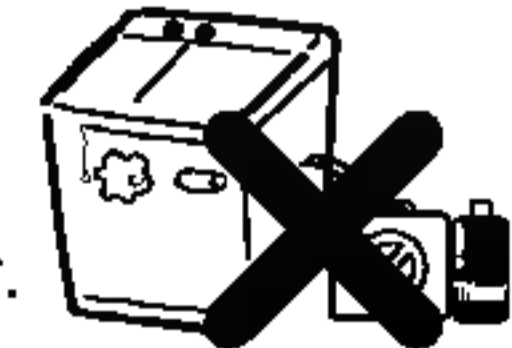

In Operation

● Do not insert the hand inside the spin dryer basket while the machine is in operation (Do not let children climb on the machine or climb into the tub. Injury may occur.)



Installation

● Install the washing machine on a horizontal support. Otherwise, it may cause vibration and noise.

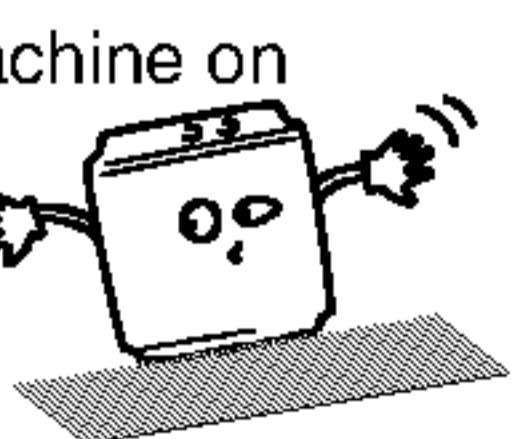

Power Cord

● If the power supply cord is damaged, it must only be replaced by the manufacture or its service agent or a similarly qualified person in order to avoid a hazard.

Electric Outlet

● Avoid connecting several electric devices to single outlet. It may cause fire.

● Be sure to earth the washer to prevent electric shock. To reduce the risk of electric shock, do not install the washer in humid spaces.



Connecting the drain hose

● Push the clamp toward the body of the washing machine as shown in the figure.

For Non-Pump Model

● Be sure to reroute the hose so that it is not kinked; kinks or sharp bending in the hose will prevent proper drainage.
 ● Make sure water is drained smoothly by placing a base under the machine or by applying other appropriate mean.

For Pump Model

● L ≤ 1 m.

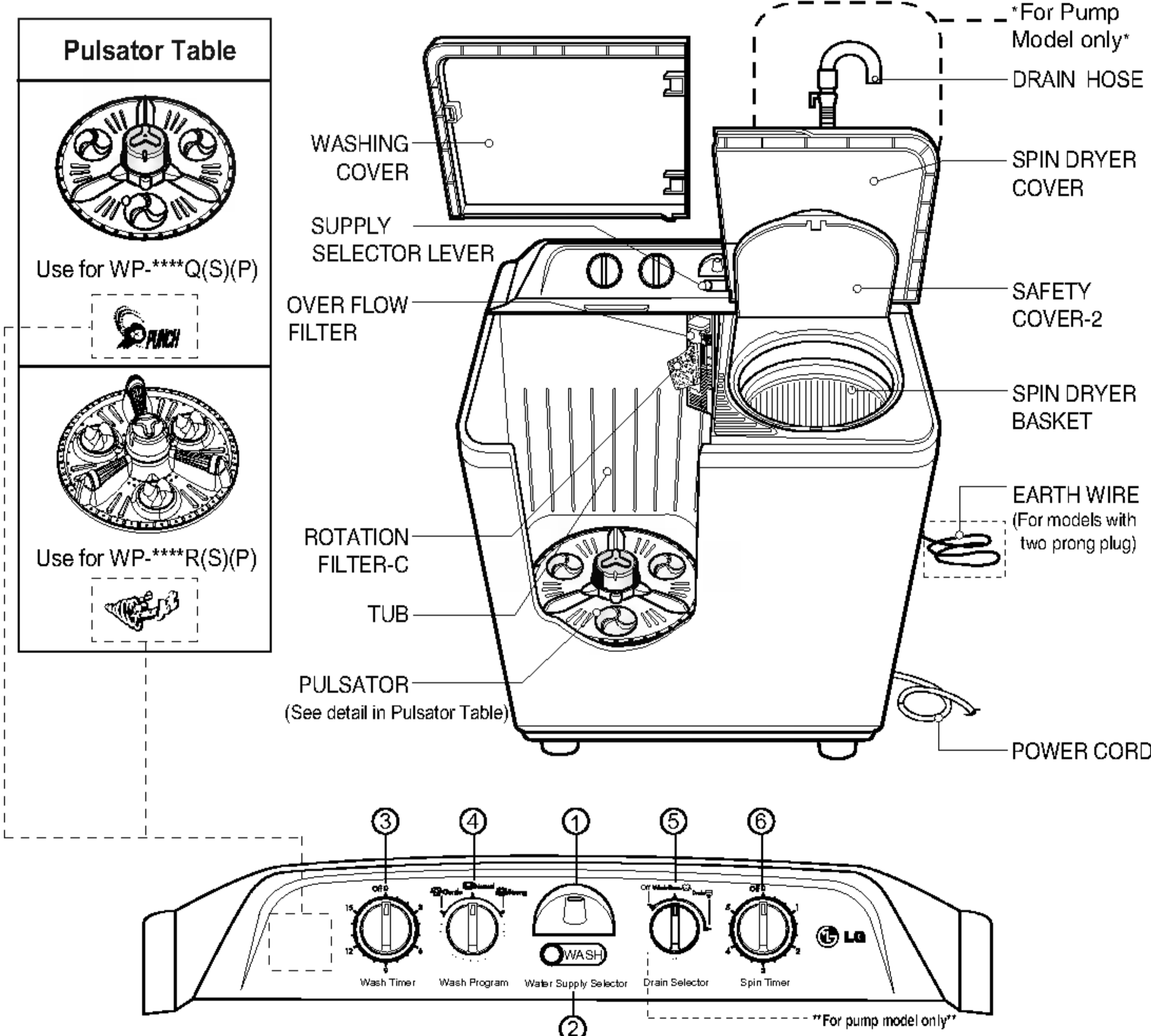
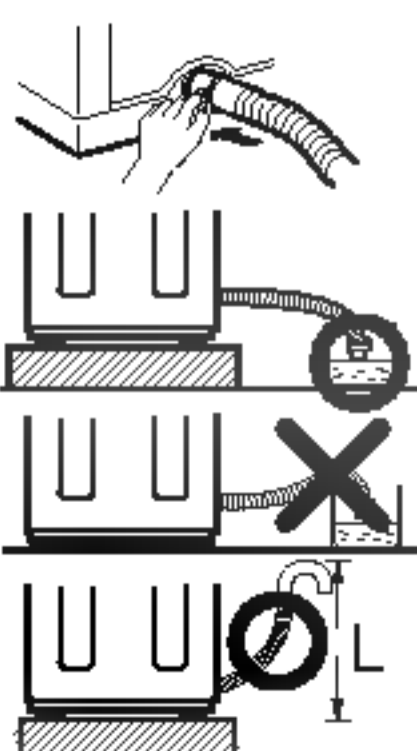

1. Water Supply Inlet

Connect here with the inlet hose from the water faucet to feed water to the tub.

2. Water Selector

Select "WASH" to supply water for washing and rinsing and "SPIN" for spin shower rinse.

3. Wash Timer

Select the desired time for washing or rinsing.

4. Wash Program

Set the program to "GENTLE", "NORMAL", "STRONG" according to kinds and quantity of the laundry.

5. Drain Selector

● For Non-Pump Model
 Select "WASH+RINSE" for washing and rinsing and "DRAIN" to drain the water out of the tub.

● For Pump Model
 Select "WASH+RINSE" for washing and rinsing and "DRAIN" to drain the water out of Cabinet, and "OFF" to turn off the drain pump.

6. Spin Timer

Connect here with the inlet hose from the water faucet to feed water to the tub.

Installation area

- Set on flat and firm floor.
- Incorrect installation may cause severe noise and break down.



- Maintain more than 10 cm. between the side of drain hose and the wall.
- A carpet must not obstruct the ventilation openings.

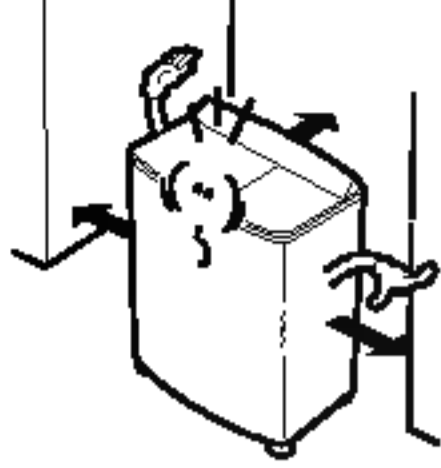

Connecting the earth wire

- Install the earth wire to prevent short-circuit due to leaking current and electric shock.
- It is attached at the back of the washer. Connect it to the metal water pipe. If the water pipe is made of plastic, it does not have the earth effect.
- Do not connect the earth wire to the gas pipe, lightning arrester, telephone connector, etc.

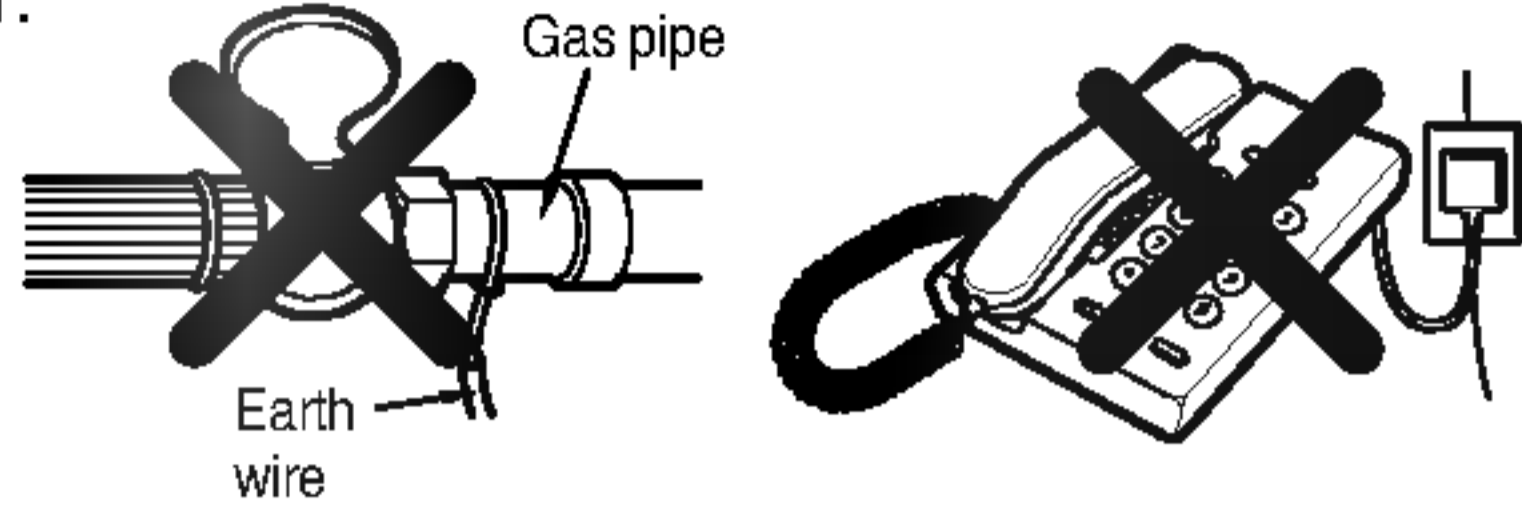

✘ Warning-the appliance with two-pronged plug must be grounded.

Connecting the power plug

- Insert the power plug into the outlet.
- Before connecting the power plug, check if the voltage setting of the washer matches the outlet voltage.
- If AC outlet with ground terminal is used, grounding is not needed. If not, never forget earthing (earthing method above).
- The appliance must be positioned so that the plug is accessible.

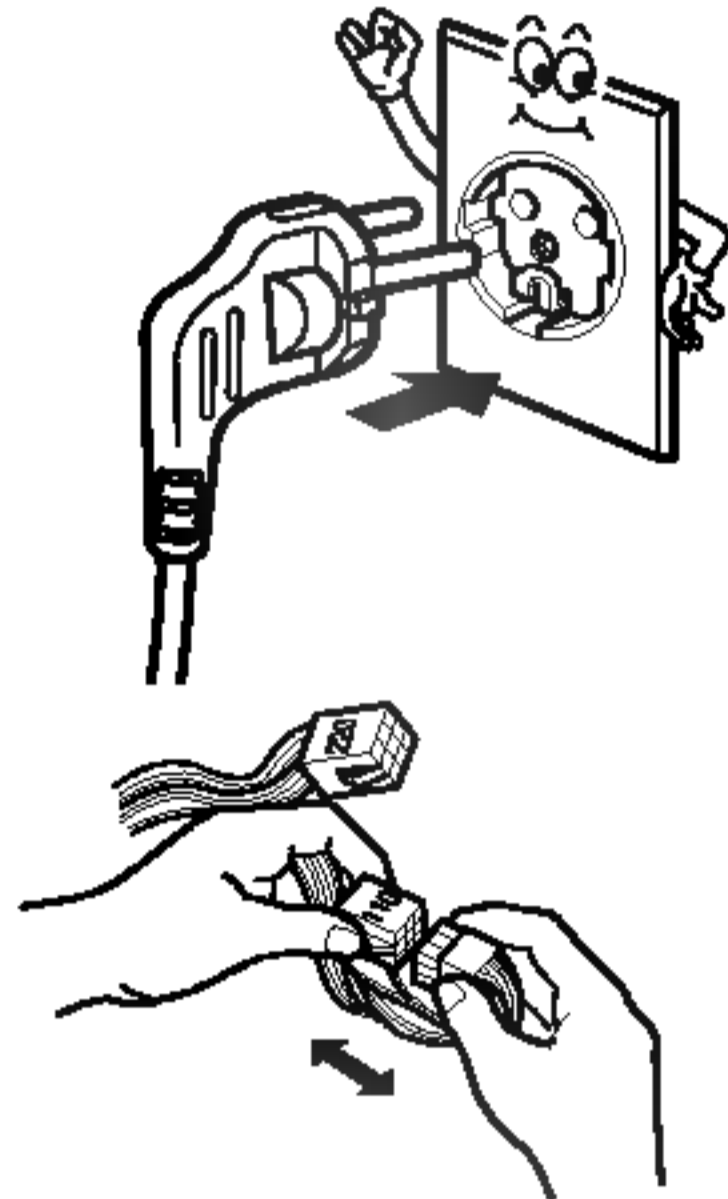

Voltage Change (only for dual voltage)

This washer is assembled for 220V, but can be changed from 220V to 110V(or 127V). Check your electrical source and follow the diagram below to convert voltage.

Other earthing method

- After connecting the earth wire to the earth copper plate, bury it at least 75cm deep under the wet ground.
- Connect to the earthing-only outlet.
- When installing it in an area where earthing is not possible, purchase a short-circuit breaker connect it to the outlet.

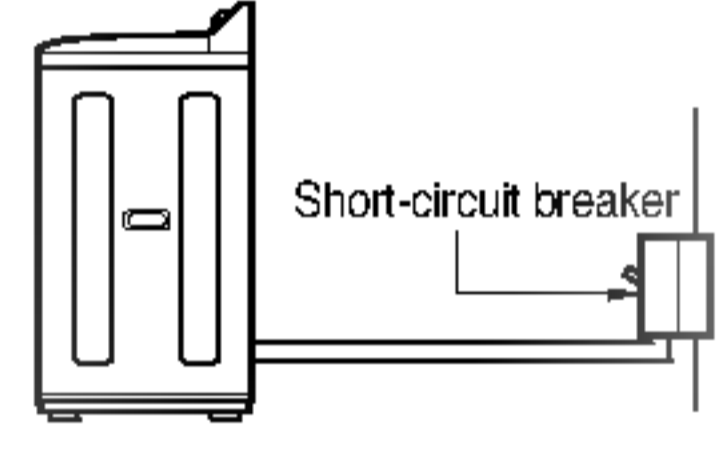
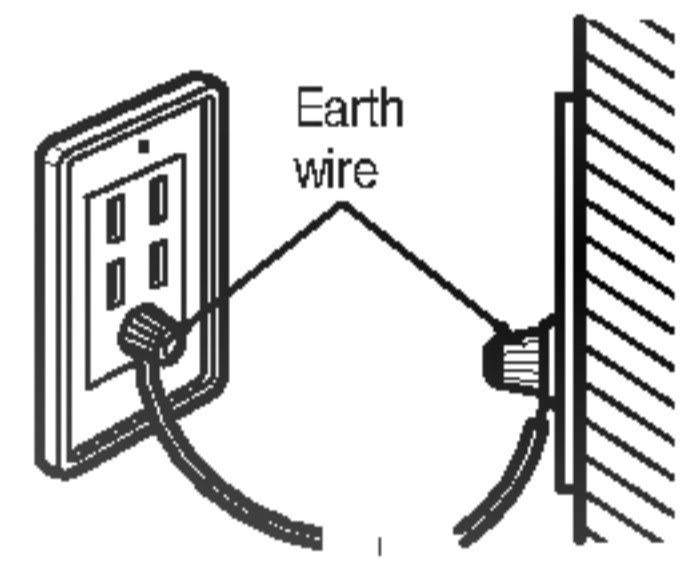
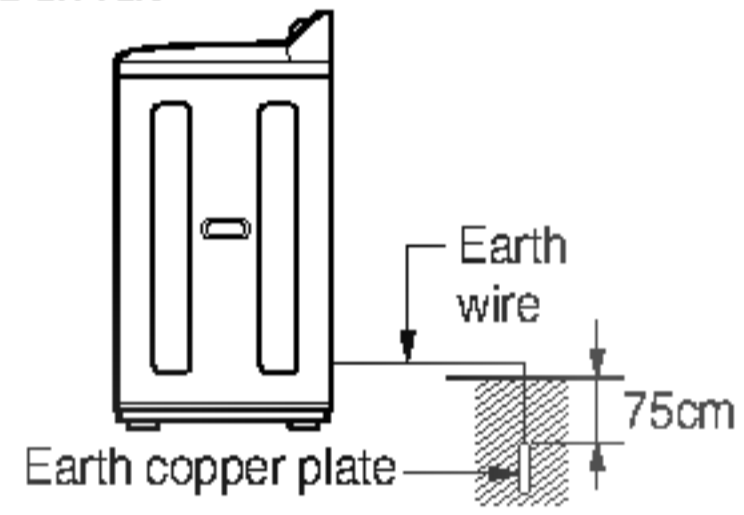

4

Before washing

1. Check the washing instruction labels on the clothing to be washed.
2. Remove all objects from the pockets of the clothing. Objects left in the pockets may damage clothing or the washing machine (could cause the drain hose to clog).
3. After separating oiled or dyed clothing, wash.
4. For your convenience hang up the wash cover on the right or left side of the washing machine tub when not in use.



Remove this before washing



How to wash

1 Set the drain selector
For Non-Pump Model Set as "WASH+RINSE" position.
For Pump Model Set as "OFF" position.

3 Open water supply and fill water till your desired level of tap mark. That is because clothes can absorb adequate amount of water and water will not short.

2 Set the water selector to "WASH"

4 Put the appropriate amount of detergent and the laundry into the wash tub. And add water to the desired water level which you want.

5 Select the wash program to "GENTLE", "NORMAL" or "STRONG" according to the kinds and quantity of the laundry. (Refer to Tabel 2)

6 Set the desired wash time.

7 When washing is finished, locate the drain selector to "DRAIN" position and drain the water out.

8 Spinning in the spin dryer basket. Move the laundry into the spin dryer basket. Put the laundry down lightly. Place the safety cover horizontally on the laundry. Set the desired spin time with the spin timer.

5

Interim spin rinse

- Interim spin rinse prior to regular rinsing helps removing sudsy water from the laundry and improve rinsing efficiency. Also is helpful to water saving.

1 After washing.
● Move the laundry into the spin dryer basket.
● Place the safety cover horizontally on the laundry.

2 Set the water selector to "SPIN".

4 After interim spin rinse, move the laundry into the wash tub for rinsing.

3 Set the desired spin flow appropriately.

Note for spinning

1. Put the laundry evenly into the spin dryer basket.
 2. Put the laundry down lightly.
 3. Place the safety cover horizontally over the laundry.
 4. Close the spin dryer cover.
- If the spin dryer basket is off-balance and vibrates excessively, stop the spinning, rearrange the clothes evenly, and then resume spinning.

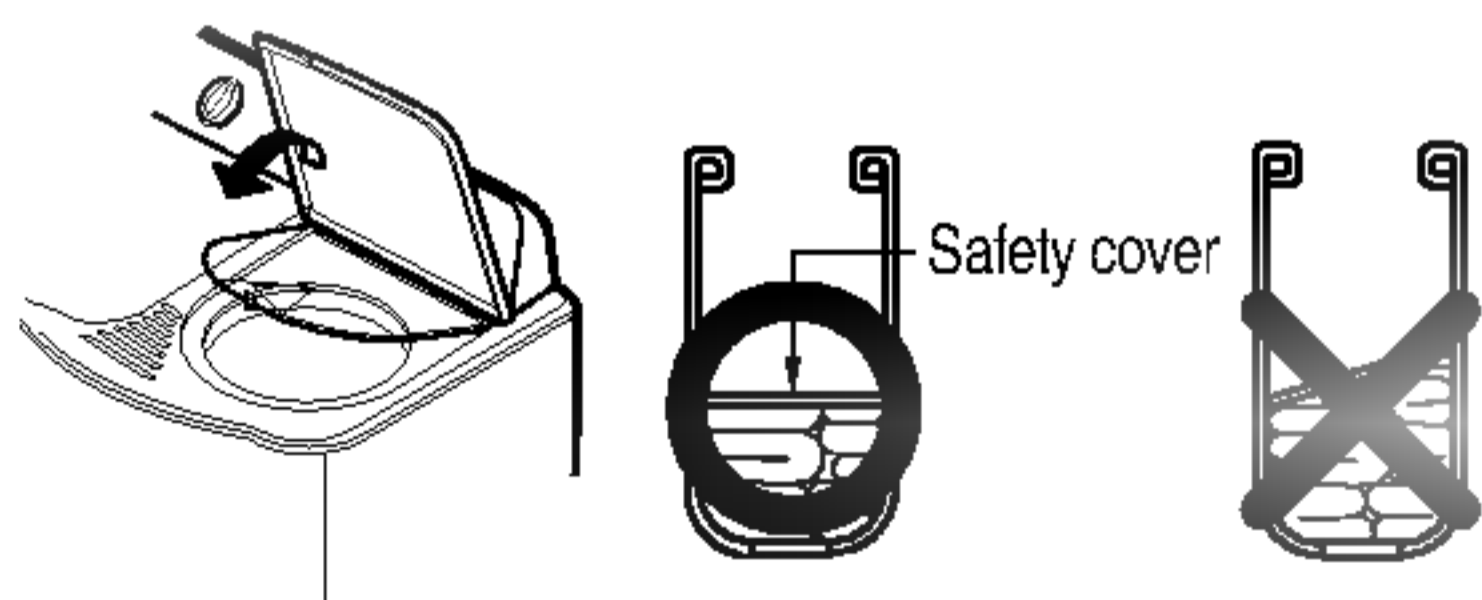

Overflow filter & Rotation filter-C

1. Lift up the area (A) of the over flow filter and take out the rotation filter-C by pulling in direction as shown.
2. Pull the overflow filter forward from the wash tub in the direction of the arrow.
3. Turn the net over and rinse in water.
4. Use a brush or hand to remove all of the lint which has adhered to the overflow filter.
5. Insert the overflow filter back into the wash tub.
6. Insert the rotation filter-C back into the overflow filter.

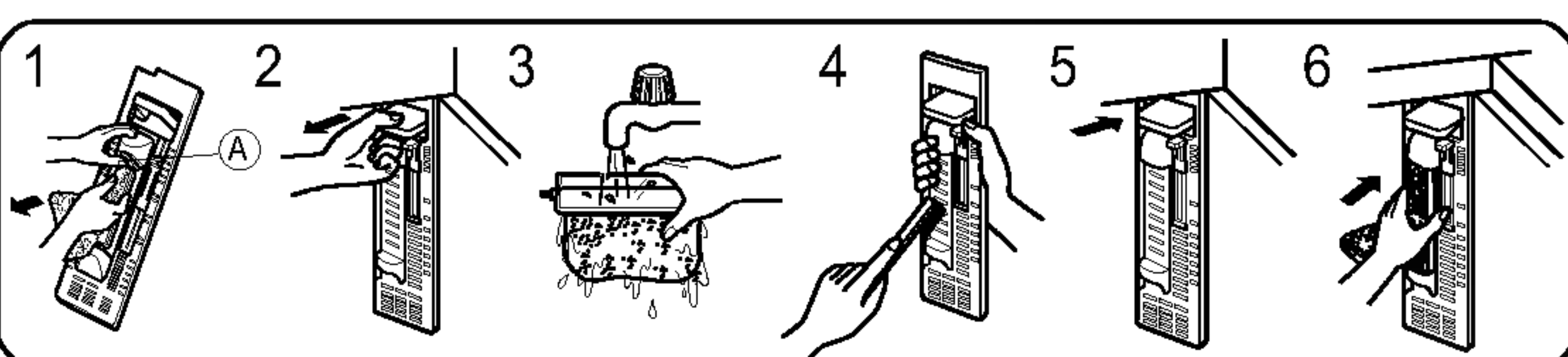

6

TABLE 1. WEIGHT GUIDE FOR CLOTHES

Type of clothing	Type of fabric	Weight per piece
Under shirt	Cotton	150g(5.3oz)
Handkerchief	Cotton	50g(1.8oz)
Bath towel	Cotton	300g(10.6oz)
Shirt	Mixed fabric	200g(7.1oz)
Socks (1 pair)	Mixed fabric	50g(1.8oz)
Pajama (shirt and pants)	Cotton	500g(17.6oz)
Winter undershirt	Cotton	600g(21.2oz)
Workclothes	Mixed fabric	800g(28.2oz)
Blouse	Mixed fabric	200g(7.1oz)

TABLE 2. GUIDE FOR WASHING

Type of fabric	Wash Selector	Wash time	Water level	Amount of laundry (Kg)	Amount of water (l)	Amount of detergent (g)
Synthetics, Silk, Woolen, Knits	GENTLE	2~5 min	S	0.5 ~ 5.4	54	54
			L	5.4 ~ 6.5	65	65
			M	6.5 ~ 7.5	76	76
Cotton, Linen	NORMAL	5~10 min	H	7.5 ~	88	88
			S	0.5 ~ 5.4	54	54
			L	5.4 ~ 6.5	65	65
Very soiled cotton and linen	STRONG	10~15 min	M	6.5 ~ 7.5	76	76
			L	5.4 ~ 6.5	65	65
			H	7.5 ~	88	88

- Amount of laundry is based on dry laundry.
- Detergent amount is based on a general synthetic detergent.
- If washing and spinning must be operated together, starting washing and spinning operation shall be done at the same time to cope with EMC requirement.

Before Requesting Service

Problem	Checking point
Motor does not operate,	<ul style="list-style-type: none"> ● Is the power cord firmly plugged in? ● Is the timer turned to a suitable point except "OFF" ?
Spin dryer basket does not operate.	<ul style="list-style-type: none"> ● Is there any clothing dropped between the basket and tub? ● Is the spin dryer cover closed? ● Is the laundry gathered to one side of the spin dryer basket?
No draining <i>For Non-Pump Model</i> <i>For Pump Model</i>	<ul style="list-style-type: none"> ● Is there lint stuck in the plunger valve? ● Is the end of the drain hose guide located at an exceed height? ● Is the drain pump operated?

7