

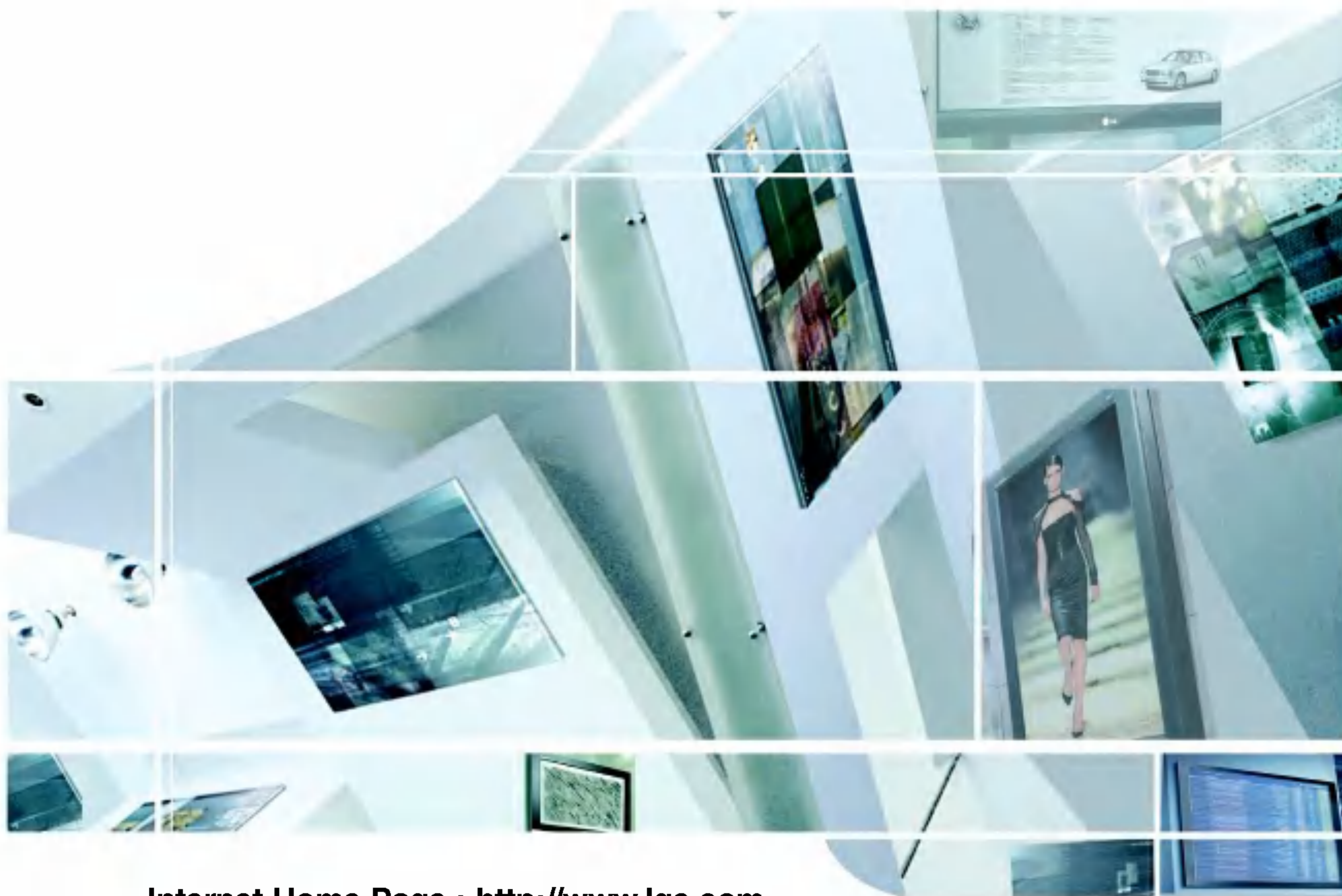

LCD TV

OWNER'S MANUAL

MODELS: 26LX1D | 32LX1D
26LX2D | 32LX2D
32LP1D | 37LP1D | 42LP1D



Internet Home Page : <http://www.lge.com>
<http://www.lg.ca>

Please read this manual carefully before operating your set.
Retain it for future reference.
Record model number and serial number of the set.
See the label attached on the back cover and quote
this information to your dealer
when you require service.



P/NO : 3828TUL309D (0508-REV04)
Printed in Korea

Warning

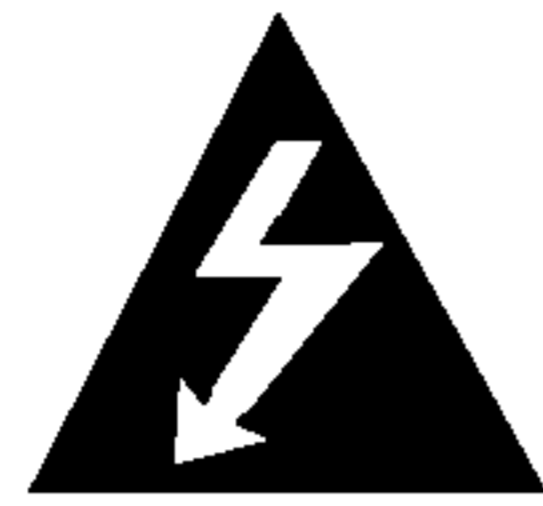

CAUTION
RISK OF ELECTRIC SHOCK
DO NOT OPEN



WARNING:

TO REDUCE THE RISK OF ELECTRIC SHOCK DO NOT REMOVE COVER (OR BACK). NO USER SERVICEABLE PARTS INSIDE. REFER TO QUALIFIED SERVICE PERSONNEL.



The lightning flash with arrowhead symbol, within an equilateral triangle, is intended to alert the user to the presence of uninsulated "dangerous voltage" within the product's enclosure that may be of sufficient magnitude to constitute a risk of electric shock to persons.



The exclamation point within an equilateral triangle is intended to alert the user to the presence of important operating and maintenance (servicing) instructions in the literature accompanying the appliance.

NOTE TO CABLE/TV INSTALLER:

This reminder is provided to call the CATV system installer's attention to Article 820-40 of the National Electric Code (U.S.A.). The code provides guidelines for proper grounding and, in particular, specifies that the cable ground shall be connected to the grounding system of the building, as close to the point of the cable entry as practical.

REGULATORY INFORMATION

This equipment has been tested and found to comply with the limits for a Class B digital device, pursuant to Part 15 of the FCC Rules. These limits are designed to provide reasonable protection against harmful interference in a residential installation. This equipment generates, uses and can radiate radio frequency energy and, if not installed and used in accordance with the instructions, may cause harmful interference to radio communications. However, there is no guarantee that interference will not occur in a particular installation. If this equipment does cause harmful interference to radio or television reception, which can be determined by turning the equipment off and on, the user is encouraged to try to correct the interference by one or more of the following measures:

- Reorient or relocate the receiving antenna.
- Increase the separation between the equipment and receiver.
- Connect the equipment into an outlet on a circuit different from that to which the receiver is connected.
- Consult the dealer or an experienced radio/TV technician for help.

Any changes or modifications not expressly approved by the party responsible for compliance could void the user's authority to operate the equipment.

CAUTION:

Do not attempt to modify this product in any way without written authorization from LG Electronics Corporation. Unauthorized modification could void the user's authority to operate this product.

U.S.A. only -----

COMPLIANCE:

The responsible party for this product's compliance is:
LG Electronics U.S.A., Inc.
1000 Sylvan Avenue, Englewood Cliffs, NJ 07632
Phone: 1-201-816-2000
<http://www.lgusa.com>

TV Guide On Screen Notices

In the United States, TV GUIDE and other related marks are registered marks of Gemstar-TV Guide International, Inc. and/or one of its affiliates. In Canada, TV GUIDE is a registered mark of Transcontinental Inc., and is used under license by Gemstar-TV Guide International, Inc.

The TV Guide On Screen system is manufactured under license from Gemstar-TV Guide International, Inc. and/or one of its affiliates.

The TV Guide On Screen system is protected by one or more of the following issued United States patents 6,498,895, 6,418,556, 6,331,877; 6,239,794; 6,154,203; 5,940,073; 4,908,713; 4,751,578; 4,706,121.

Use of the CableCARD™ TradeMark.

“CableCARD™ is a trademark of Cable Television Laboratories, Inc.”

Digital Cable Compatibility

This digital television is capable of receiving basic analog, digital basic and digital premium cable television programming by direct connection to a cable system providing such programming. A security card provided by your cable operator is required to view encrypted digital programming. Certain advanced interactive digital cable services such as video-on-demand, cable operator enhanced program the TV Guide On Screen system, and data enhanced television service may require the use of a set top box. For more information contact your local cable operator.

Safety Instructions

WARNING :

To Reduce The Risk Of Fire Or Electric Shock, Do Not Expose This Apparatus To Rain Or Moisture.

Apparatus shall not be exposed to dripping or splashing and no objects filled with liquids, such as vases, shall be placed on the apparatus.

IMPORTANT SAFETY INSTRUCTIONS

1. Read these instructions.

2. Keep these instructions.

3. Heed all warnings.

4. Follow all instructions.



5. Do not use this apparatus near water.

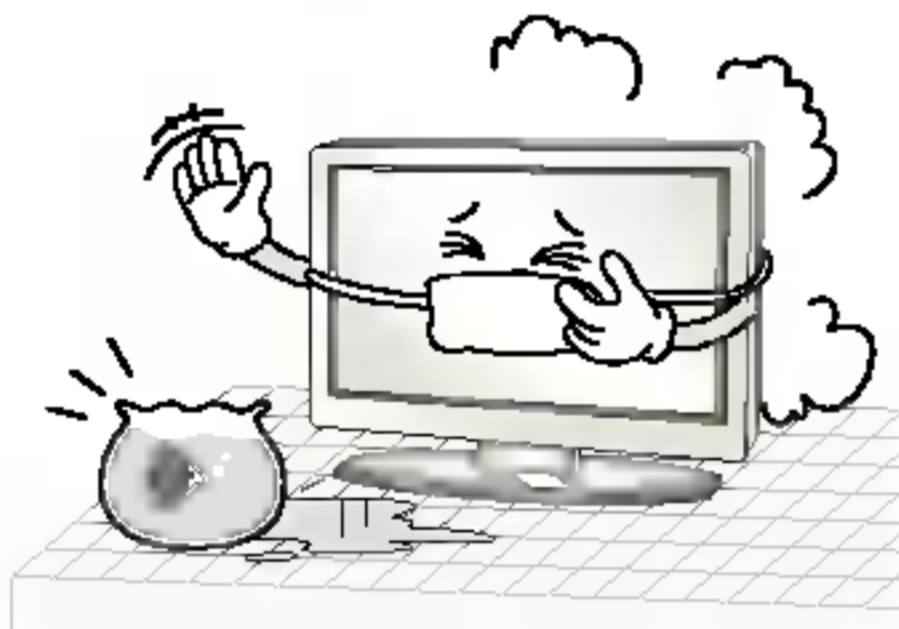

6. Clean only with a dry cloth.



7. Do not block any of the ventilation openings. Install in accordance with the manufacturer's instructions.

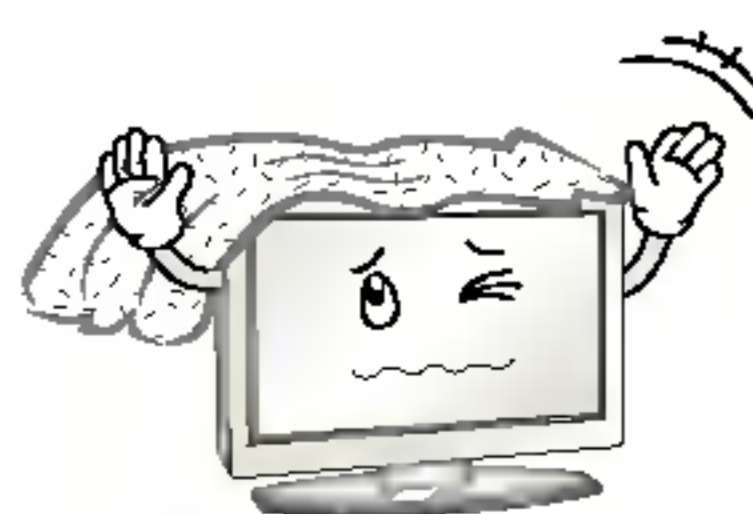

8. Do not install near any heat sources such as radiators, heat registers, stoves, or other apparatus (including amplifiers) that produce heat.



9. Do not defeat the safety purpose of the polarized or grounding type plug. A polarized plug has two blades with one wider than the other. A grounding type plug has two blades and a third grounding prong. The wide blade or the third prong is provided for your safety. When the provided plug does not fit into your outlet, consult an electrician for replacement of the obsolete outlet.

10. Protect the power cord from being walked on or pinched particularly at plugs, convenience receptacles, and the point where they exit from the apparatus.

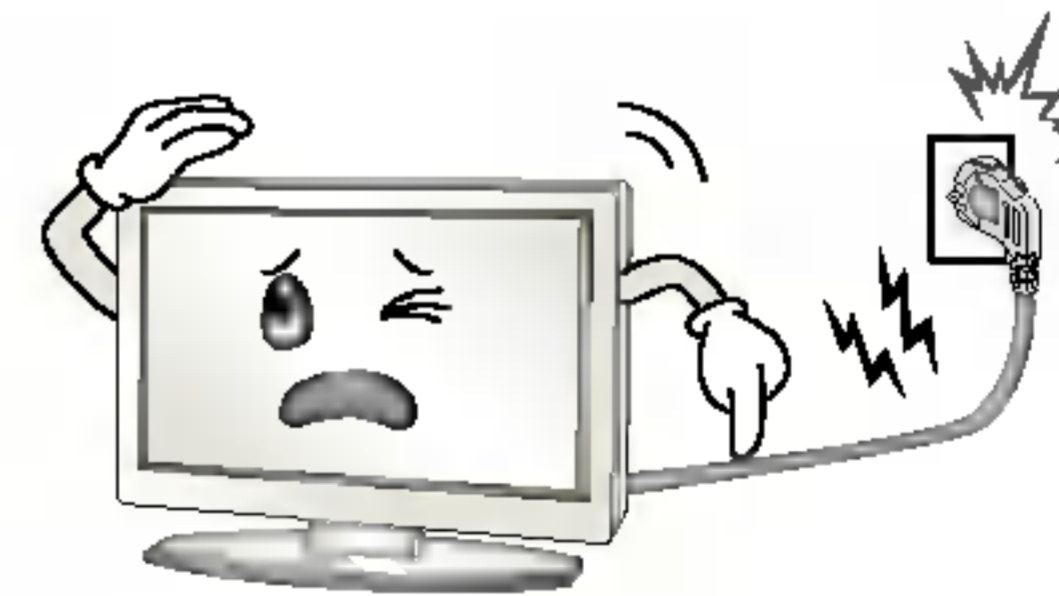

11. Only use the attachments / accessories specified by the manufacturer.

12. Use only with a cart, stand, tripod, bracket, or table specified by the manufacturer, or sold with the apparatus. When a cart is used, use caution when moving the cart / apparatus combination to avoid injury from tip-over.



13. Unplug this apparatus during lightning storms or when unused for long periods of time.



14. Refer all servicing to qualified service personnel. Servicing is required when the apparatus has been damaged in any way, such as power supply cord or plug is damaged, liquid has been spilled or objects have fallen into the apparatus, the apparatus has been exposed to rain or moisture, does not operate normally, or has been dropped.

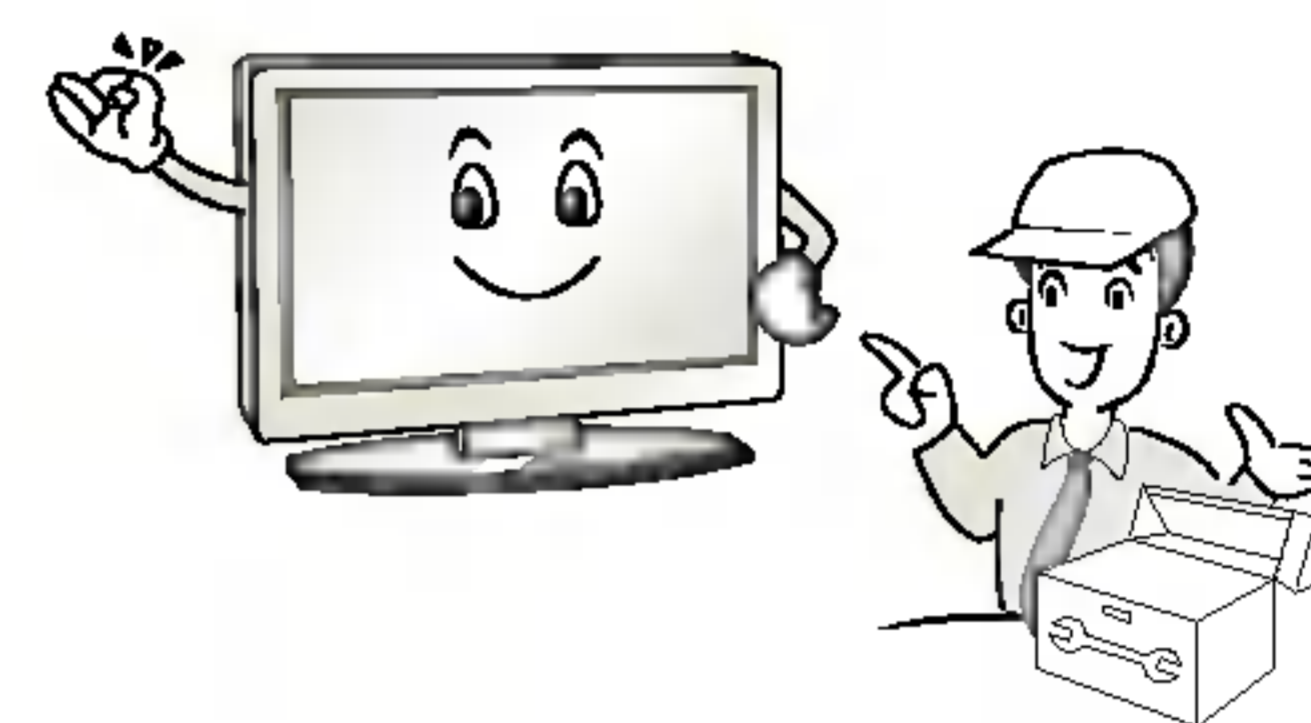

Note

- If the TV feels cold to the touch, there may be a small “flicker” when when it is turned on. This is normal, there is nothing wrong with TV.
- Some minute dot defects may be visible on the screen, appearing as tiny red, green, or blue spots. However, they have no adverse effect on the monitor's performance.
- Avoid touching the LCD screen or holding your finger(s) against it for long periods of time. Doing so may produce some temporary distortion effects on the screen.

CAUTION concerning the Power Cord

Most appliances recommend they be placed upon a dedicated circuit; that is, a single outlet circuit which powers only that appliance and has no additional outlets or branch circuits. Check the specification page of this owner's manual to be certain.

Do not overload wall outlets. Overloaded wall outlets, loose or damaged wall outlets, extension cords, frayed power cords, or damaged or cracked wire insulation are dangerous. Any of these conditions could result in electric shock or fire. Periodically examine the cord of your appliance, and if its appearance indicates damage or deterioration, unplug it, discontinue use of the appliance, and have the cord replaced with an exact replacement part by an authorized servicer.

Protect the power cord from physical or mechanical abuse, such as being twisted, kinked, pinched, closed in a door, or walked upon. Pay particular attention to plugs, wall outlets, and the point where the cord exits the appliance.

On Disposal

- a. The fluorescent lamp used in this product contains a small amount of mercury.
- b. Do not dispose of this product with general household waste.
Disposal of this product must be carried out in accordance to the regulations of your local authority.

Contents

Introduction		2	Warnings	
		3	TV Guide On Screen Notices / Digital Cable Compatibility	
		4~5	Safety Instructions	
		8	Accessories	
		9	Controls (Model Name: 32/37/42LP1D)	
		10	Connection Options (Model Name: 32/37/42LP1D)	
		11	Controls (Model Name: 26/32LX1D, 26/32LX2D)	
		12	Connection Options (Model Name: 26LX1D/2D)	
		13	Connection Options (Model Name: 32LX1D/2D)	
		14~18	Remote Control Key Functions	
Installation	Installation Instruction	19	Various Installation	
		20	How to use back cover	
		20	Swivel Stand (32/37/42LP1D, 26/32LX2D only)	
		21	Antenna or Cable Connection	
		22~23	VCR Setup	
		24~25	DVD Setup	
		26~29	HDSTB Setup	
		30	External AV Source Setup	
		30	Digital Audio Output	
		31	Monitor Out Setup (32LX1D/2D, 32/37/42LP1D only)	
		31	CableCARD™ Setup	
		32~35	PC Setup	
		36~41	IEEE1394	
		42~43	G-LINK™ Setup	
		44~50	TV Guide On Screen™ System Setup	
		51~68	TV Guide On Screen™ System Feature	
	Operation	Basic operation	69	Turning on the TV
			69	Volume Adjustment
		69	Channel Selection	
		69	On Screen Menus Language Selection	
		70	On Screen Menus Selection and Adjustment	
		71	EZ Scan (Channel Search)	
		71	Manual Scan	
		72	Channel Edit	
		73	DTV Signal Strength	
		73	Channel Label Setup	
		74	Main Picture Source Selection	
		74	Input Label	
		75	EZ Picture	
		75	APM (Adaptive Picture Mode)	
		76	Manual Picture Control (EZ Picture-Custom option)	
		76	Color Temperature Control	
		76	Video Reset	
		77	Audio Language	
		77	EZ SoundRite	
		78	EZ Sound	
	78	Manual Sound Control (EZ Sound-Custom option)		
	79	Stereo/SAP Broadcasts Setup		
	79	Front Surround		
	80	TV Speakers On/Off Setup		
	80	BBE		

Operation	Time Menu Options	81	Auto Clock Setup
		81	Manual Clock Setup
		82	On/Off Timer Setup
		82	Sleep Timer
		83	Auto Off
	Option Menu Features	84	Aspect Ratio Control
		85	Cinema 3:2 Mode Setup
		85	Caption
		86	Caption/Text
		87	Caption Option
	87	Auto Demo (Review)	
	88	Logo Light	
	88	Freeze & Magnify (DTV/CADTV 720p or 1080i mode only)	
Lock Menu Options	89~90	Parental Lock Setup	
CableCARD™ Function	91	Cable Menu Options	
	91	Scrambled Channel	
	92	Cable Channel List	
	92	Emergency Alert Message	
Brief Info.	93	Brief Info.	
PIP (Picture-in-Picture)/POP/ Twin Picture	94	Watching PIP/POP/Twin Picture	
	94	Selecting an Input Signal Source for PIP/Twin Picture	
	94	TV Program Selection for PIP	
	94	Moving the PIP Sub Picture	
	95	Adjusting Main and Sub Picture Sizes for Twin Picture	
	95	Swapping the PIP/Twin Picture	
	95	POP (Picture-out-of-Picture: Channel Scan)	
		Notes on Memory card	
	96	What is Memory Card	
	96	Precaution for Using the Memory Card	
	97	Insert/Eject Memory Card	
	98	Supported Files	
		XSTUDIO Mode	
	98	Basic Operation	
		JPEG File Viewing Options	
	99	Photo List OSD Display	
	99	Picture Selection and Popup menu	
		MP3 Files Playing Operation	
	100	Music List OSD Display	
	101	MP3 File Selection and Popup menu	
	101	Screen Saver	
Reference		102~107 External Control Device Setup	
		108~109 IR Codes	
		110 Programming the Remote	
		111~112 Programming Codes	
		113~114 Troubleshooting Checklist	
		115 Maintenance	
		115 Product Specifications	

Introduction

Accessories

Ensure that the following accessories are included with your TV. If any accessory is missing, please contact the dealer from where you purchased the product.

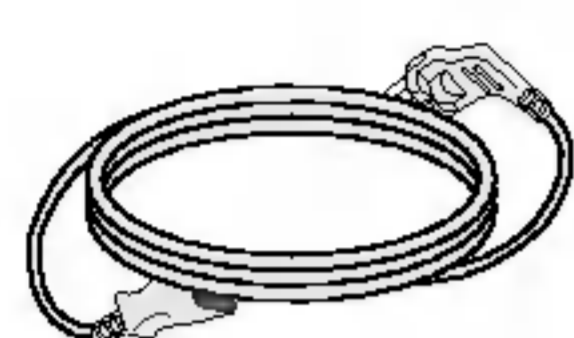

Power Cord



75Ω Round Cable



G-LINK Cable

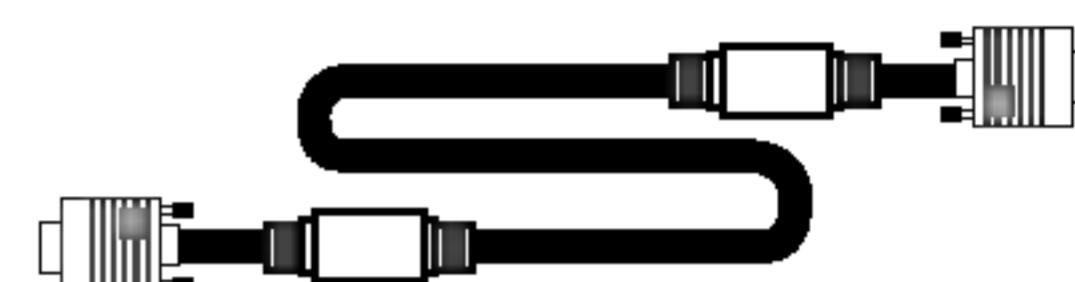

D-sub 15 pin cable



Polishing Cloth
Polish the screen with the cloth.



Twister Holder
Arrange the wires
with the twister holder.

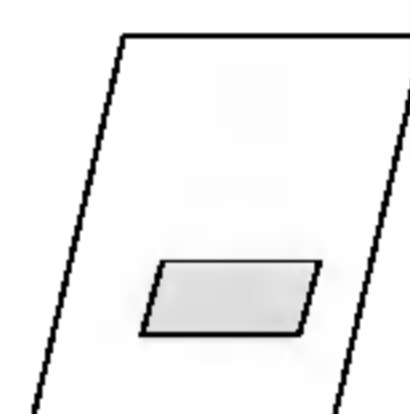

Owner's Manual

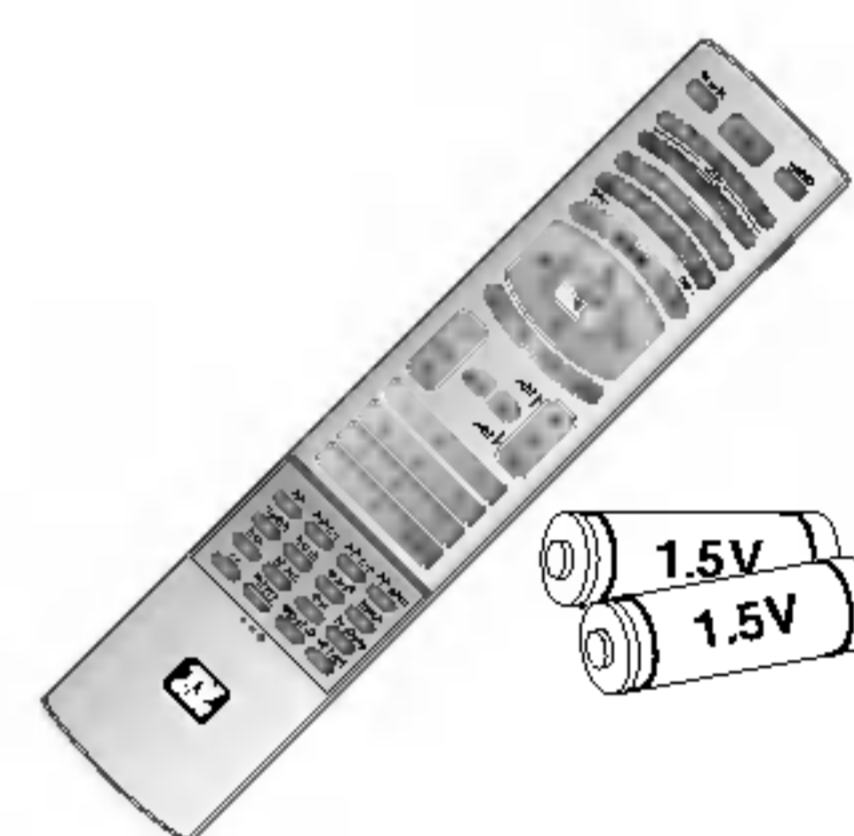

Remote Control /
Batteries

Controls (Model Name: 32/37/42LP1D)

- This is a simplified representation of front panel.
- Here shown may be somewhat different from your TV.

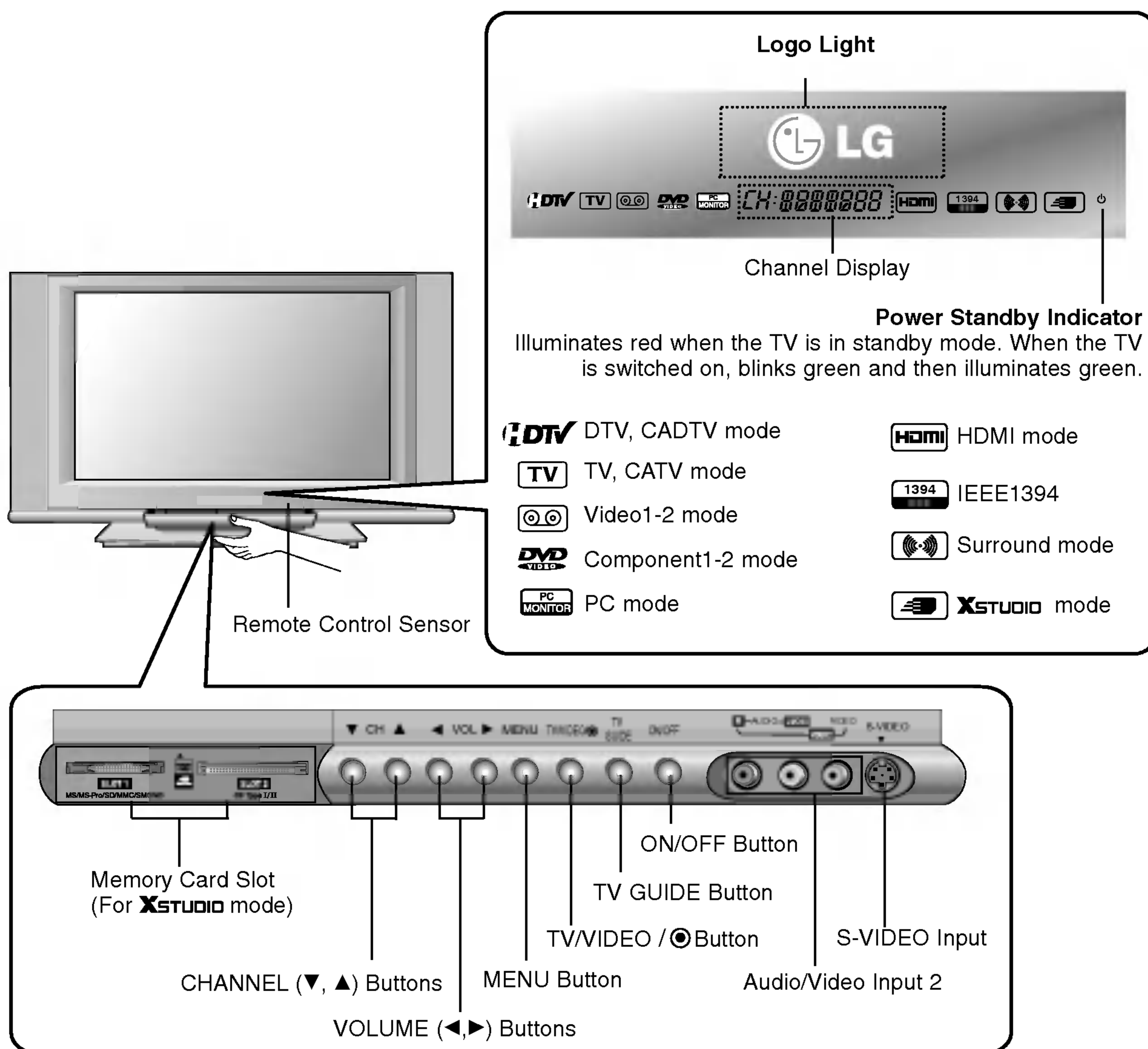

Connection Options (Model Name: 32/37/42LP1D)

- Here shown may be somewhat different from your TV.

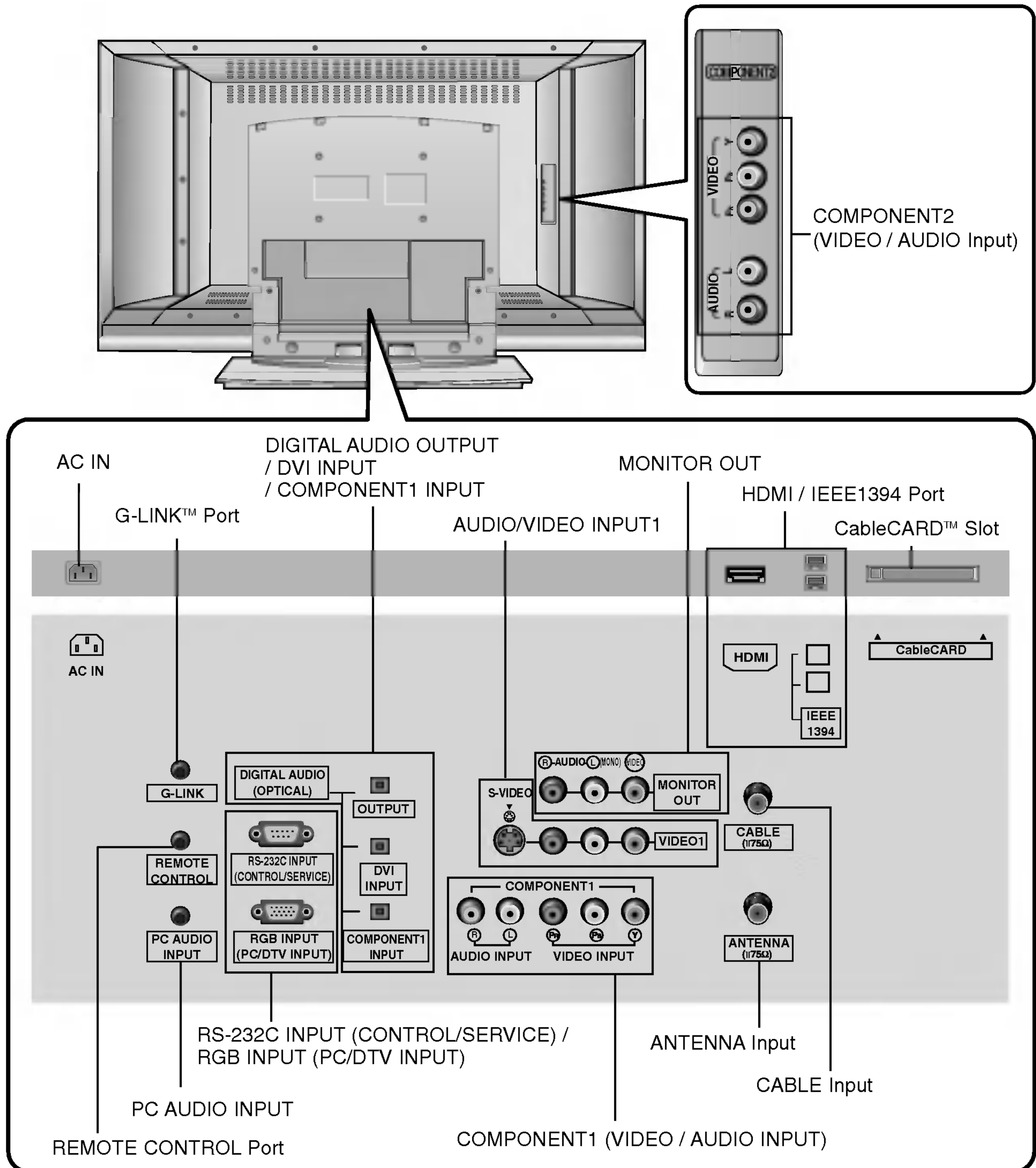

* The HDMI port can receive video via High-Definition Multimedia Interface (HDMI) or the Digital Visual Interface (DVI). Note: An adapter or special cable is required to plug DVI into an HDMI port (available at home theater or computer stores).

Controls (Model Name: 26/32LX1D, 26/32LX2D)

- This is a simplified representation of front panel.
- Here shown may be somewhat different from your TV.

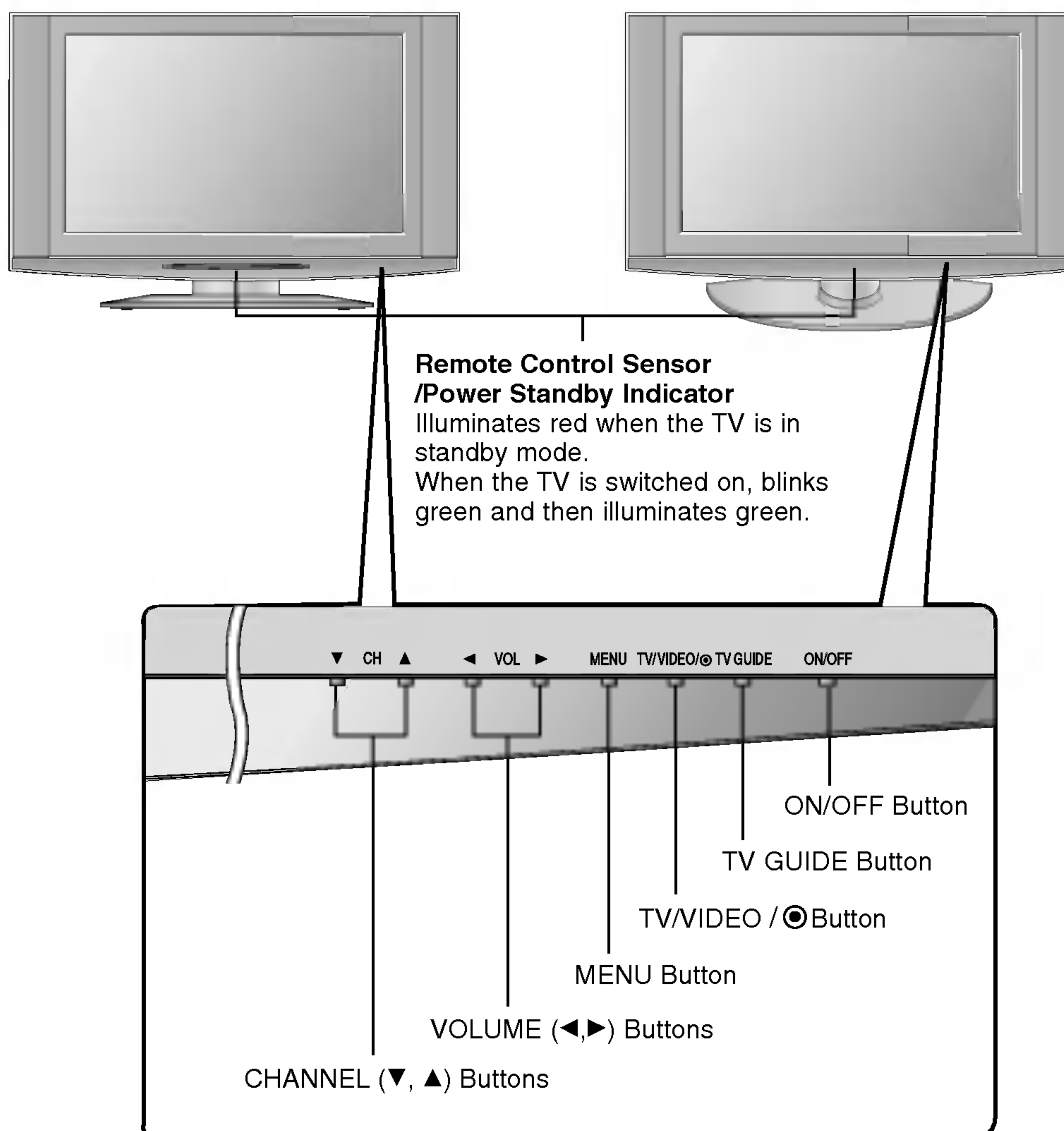

Connection Options (Model Name: 26LX1D/2D)

- Here shown may be somewhat different from your TV.

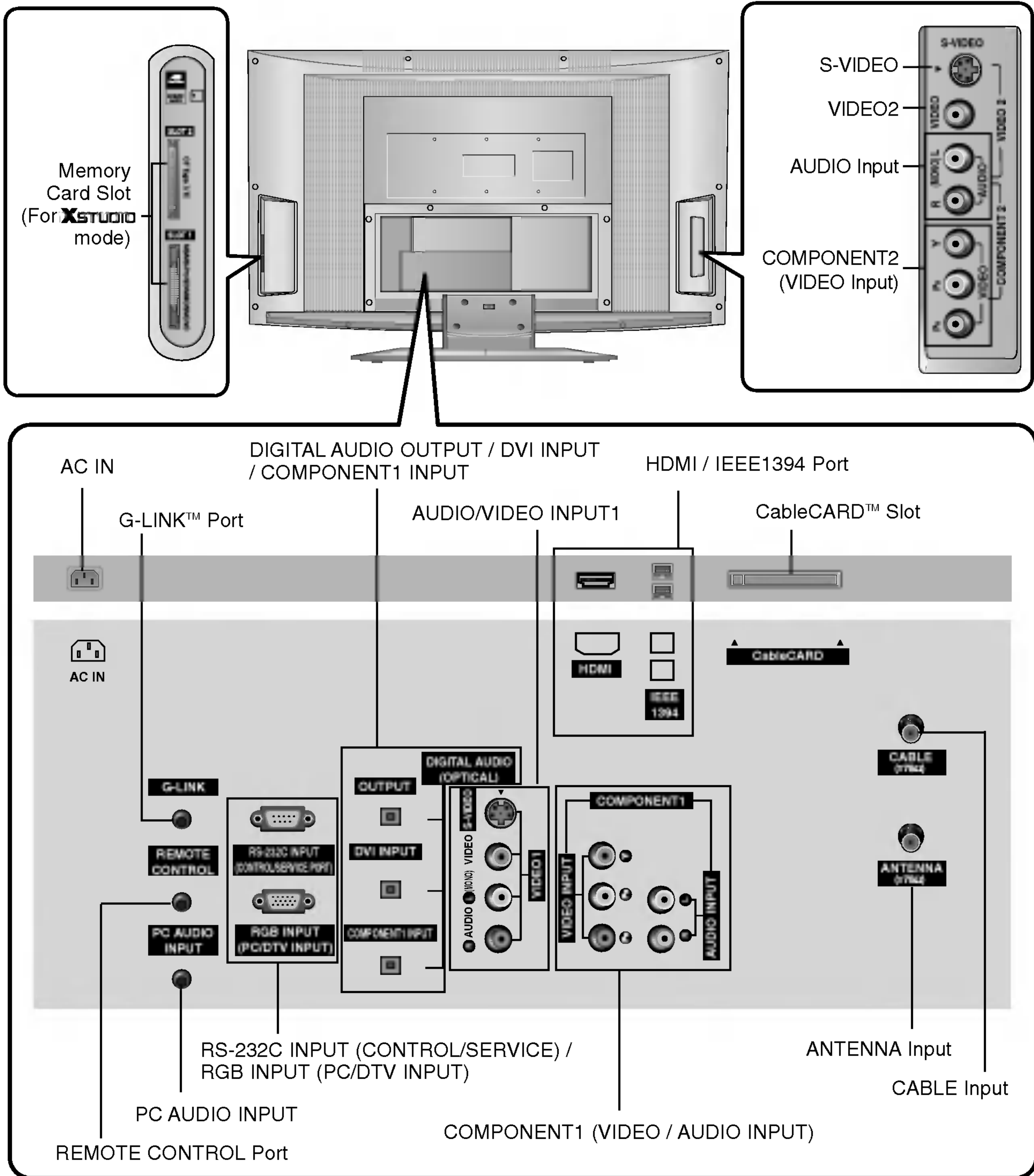

* The HDMI port can receive video via High-Definition Multimedia Interface (HDMI) or the Digital Visual Interface (DVI). Note: An adapter or special cable is required to plug DVI into an HDMI port (available at home theater or computer stores).

Connection Options (Model Name: 32LX1D/2D)

- Here shown may be somewhat different from your TV.

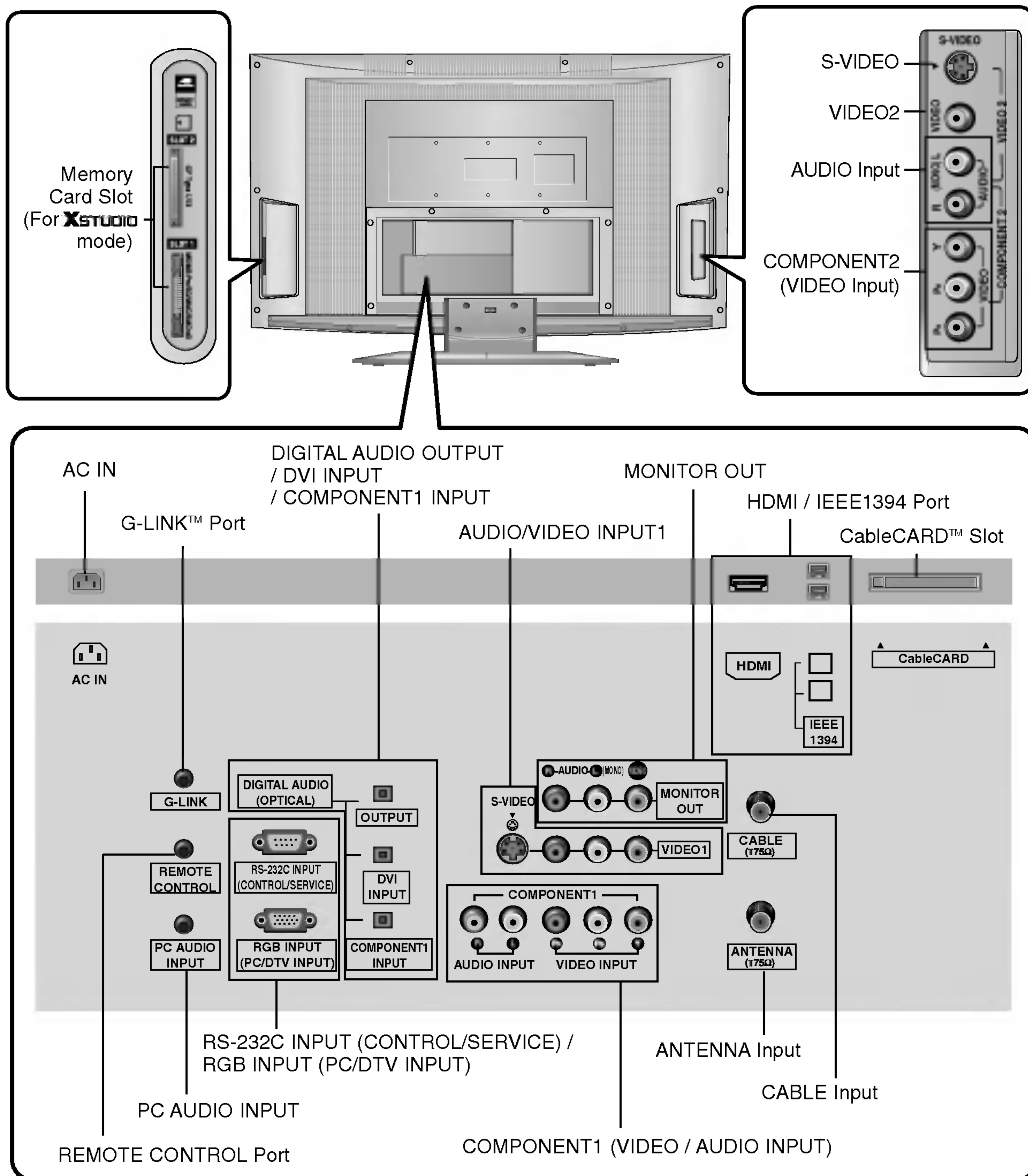

* The HDMI port can receive video via High-Definition Multimedia Interface (HDMI) or the Digital Visual Interface (DVI). Note: An adapter or special cable is required to plug DVI into an HDMI port (available at home theater or computer stores).

Remote Control Key Functions

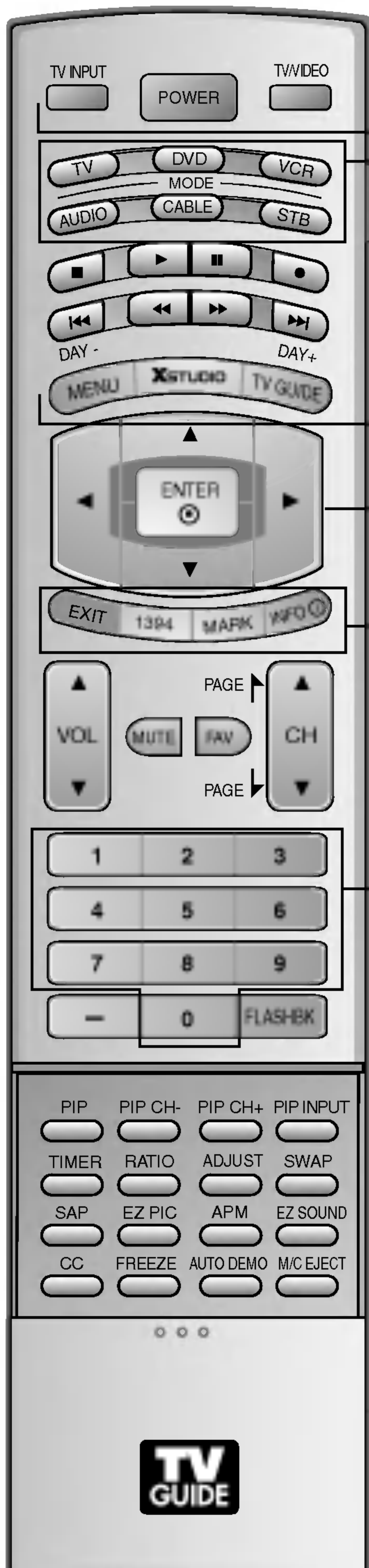

POWER

Turns your TV or any other programmed equipment on or off, depending on mode.

TV INPUT

Rotates the input mode between Antenna and Cable. In Video1-2, Component 1-2, RGB-DTV (or RGB-PC), HDMI/DVI, and IEEE1394 input sources, screen returns to the last TV channel.

TV/VIDEO (Refer to p.17)

External input modes rotate in regular sequence: Antenna, Cable, Video1-2, Component 1-2, RGB-DTV (or RGB-PC), HDMI/DVI). (Video 1-2, Component 1-2 input sources are linked automatically, Only if these are connected)

MODE

Selects the remote operating mode: TV, VCR, DVD, CABLE, STB or AUDIO.

LIGHT

Illuminates the remote control buttons.

MENU

Brings up the main menu to the screen. Enters or exits a Panel Menu in the TV Guide On Screen system.

TV GUIDE

Brings up the TV Guide On Screen system to the screen.

THUMBSTICK (Up/Down/Left/Right/ENTER)

Allows you to navigate the on-screen menus and adjust the system settings to your preference.

EXIT

Clears all on-screen displays and returns to TV viewing from any menu.

1394 (Refer to p.36~41)

Use it to operate the DVHS, MicroMV camcorder and DSTB.

INFO (Refer to p.93)

When you watch the TV, information displays on top of the screen. Not available in Component 1-2, RGB and HDMI/DVI mode.

NUMBER BUTTONS

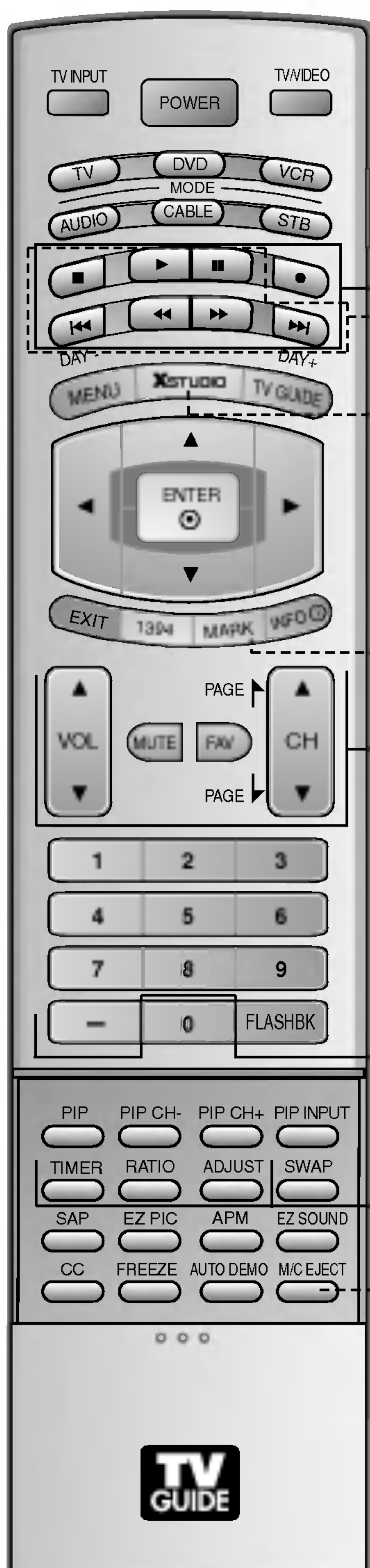

VCR/DVD/DVHS/Camcorder **BUTTONS**

Control some video cassette recorders or DVD players ("RECORD" button is not available for DVD player). Control DVHS or camcorders while in IEEE 1394 mode.

DAY + / DAY-

Moves forward or backward in 24 hour increments.

XSTUDIO Mode Control Buttons

Controls the **XSTUDIO** Mode. For further details, see the '**XSTUDIO** Mode' section.

XSTUDIO

Enter to the **XSTUDIO** Mode.

MARK

Selects a photo or music you want to view or play in **XSTUDIO** mode.

M/C EJECT

When removing the memory card, this button is used.

VOLUME UP/DOWN

Increases/decreases the sound level.

CHANNEL UP/DOWN

Selects available channels found with EZ scan and Manual scan.

PAGE UP/DOWN

Moves from one full set of screen information to the next one.

MUTE (Refer to p.18)

Switches the sound on or off.

FAV

Use to scroll the Favorite channels.

— (DASH)

Used to enter a program number for multiple program channels such as 2-1, 2-2, etc.

FLASHBK

Returns to the last channel viewed.

TIMER (Refer to p.82)

Lets you select the amount of time before your TV turns itself off automatically.

RATIO (Refer to p.84)

Changes the aspect ratio.

ADJUST (Refer to p.35)

Adjusts screen position, size, and phase in PC mode.

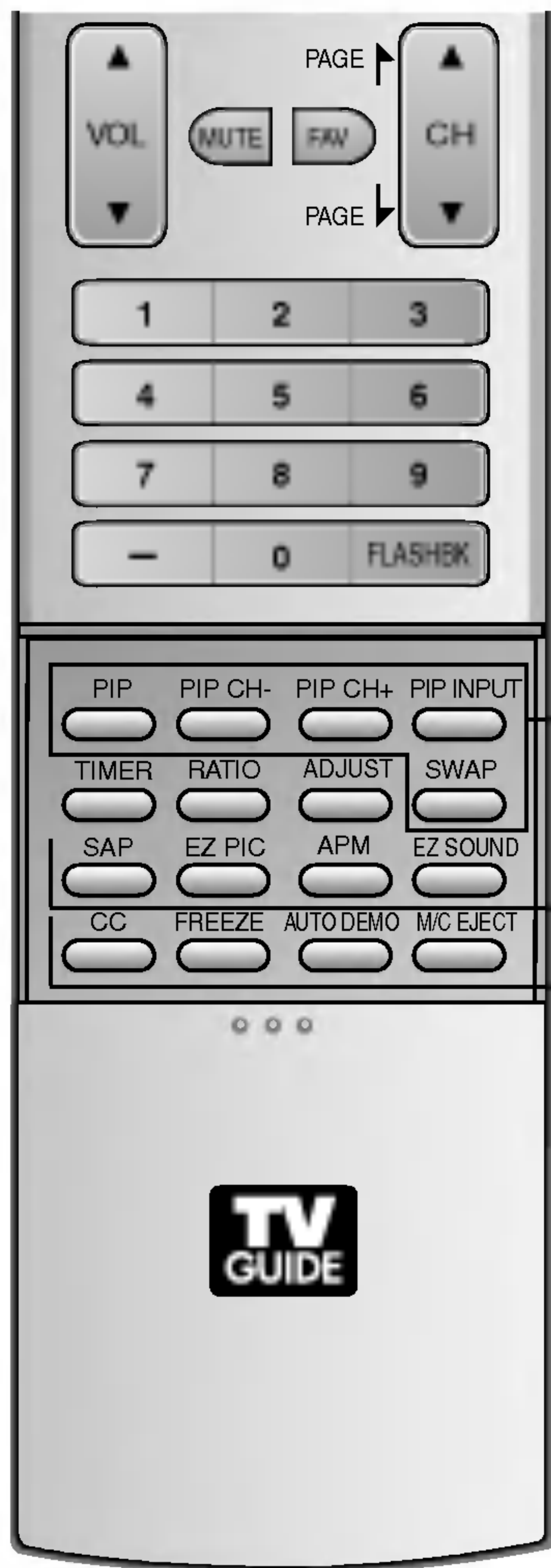

PIP (Refer to p.94)

Switches between PIP, POP (Picture-out-of-Picture) and Twin picture modes. Switches the video window locking or unlocking in the Listings Grid.

PIP CH-/PIP CH+ (Refer to p.94)

Changes to next higher/lower PIP channel.

PIP INPUT (Refer to p.94)

Selects the input source for the sub picture in PIP/Twin picture mode.

SWAP (Refer to p.95)

Exchanges the main/sub images in PIP/Twin picture mode.

SAP (Refer to p.79)

Selects MTS sound: Mono, Stereo, and SAP in analog mode. Change the audio language in DTV mode.

EZ PIC (Refer to p.75)

Selects a factory preset picture mode depending on the viewing environment.

APM (Refer to p.75)

Concurrently, compare with the Daylight, Normal, Night Time and Custom on the screen.

EZ SOUND (Refer to p.78)

Selects the sound appropriate for the program's character.

CC (Refer to p.86)

Select a closed caption: Off, CC1~4, Text1~4.

FREEZE

Freezes the currently-viewed picture. Main picture is frozen in PIP/Twin picture mode.

AUTO DEMO (Refer to p.87)

Displays the slide show to explain the main features of this TV.

Installing Batteries

1 Open the battery compartment cover on the back side.

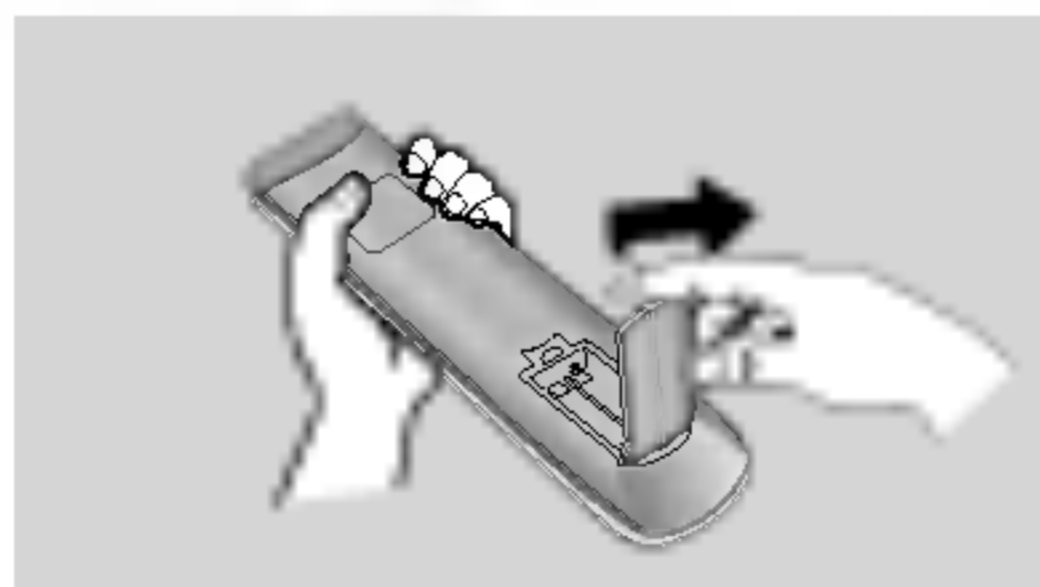

2 Insert two batteries in correct polarity (+ with +, - with -). Don't mix old or used batteries with new ones.



3 Close the cover.

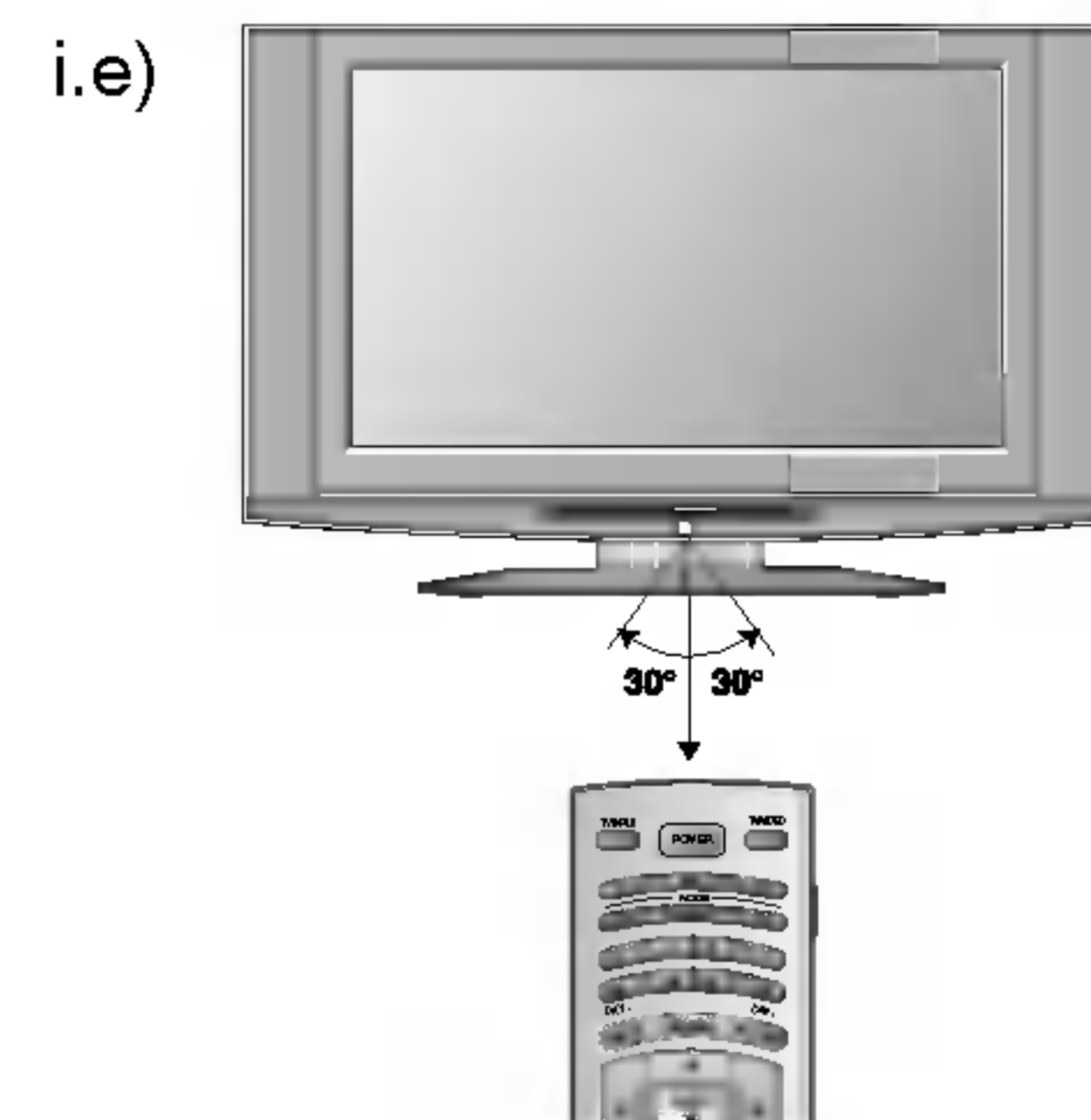
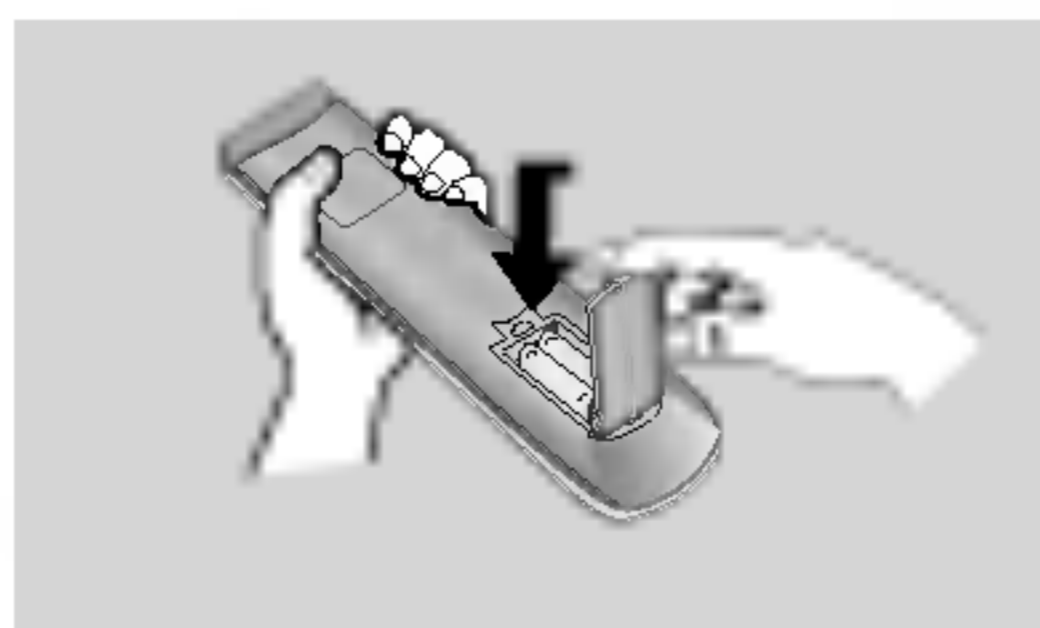

* Use a remote control 7 meter distance and 30 degree (left/right) within the receiving unit scope.

* Dispose of used batteries in a recycle bin to prevent environment.



Auto Link

1. When every external equipment is connected:

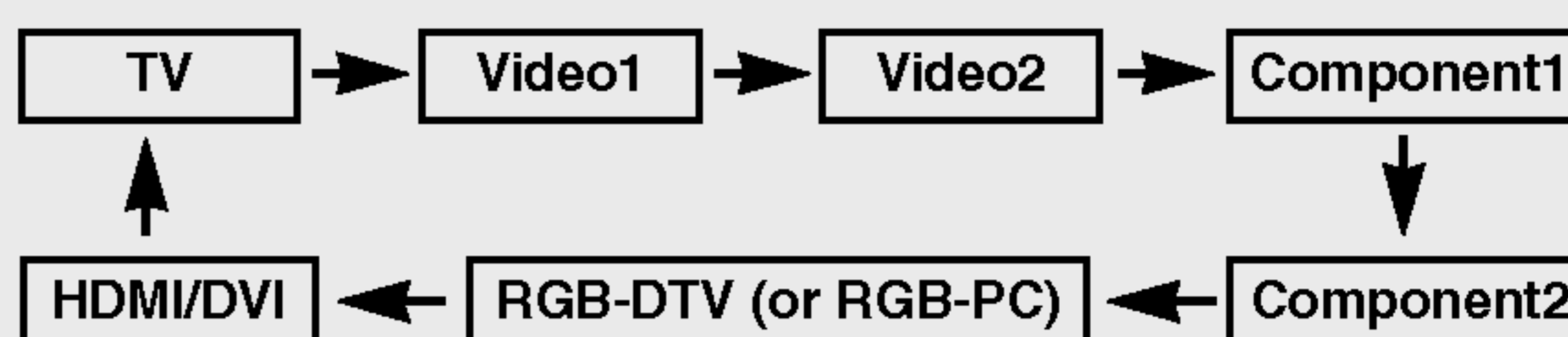

2. When any external equipment is not connected:

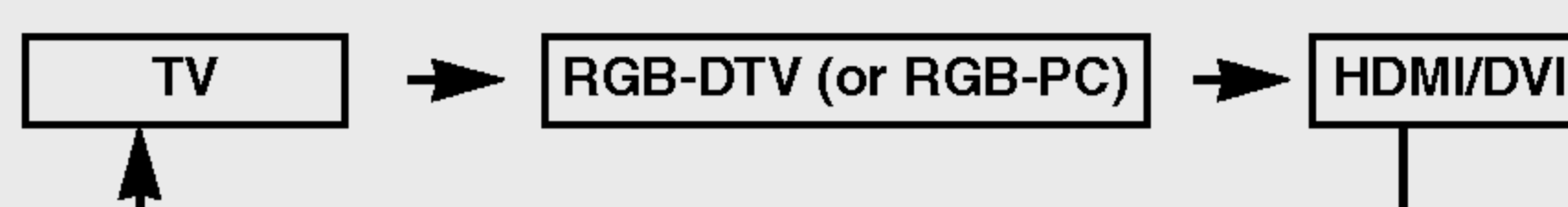

3. When some External Equipment is connected:
(ex: When connected to Video 2)



• You can also select **Main Input** in the **SETUP** menu.

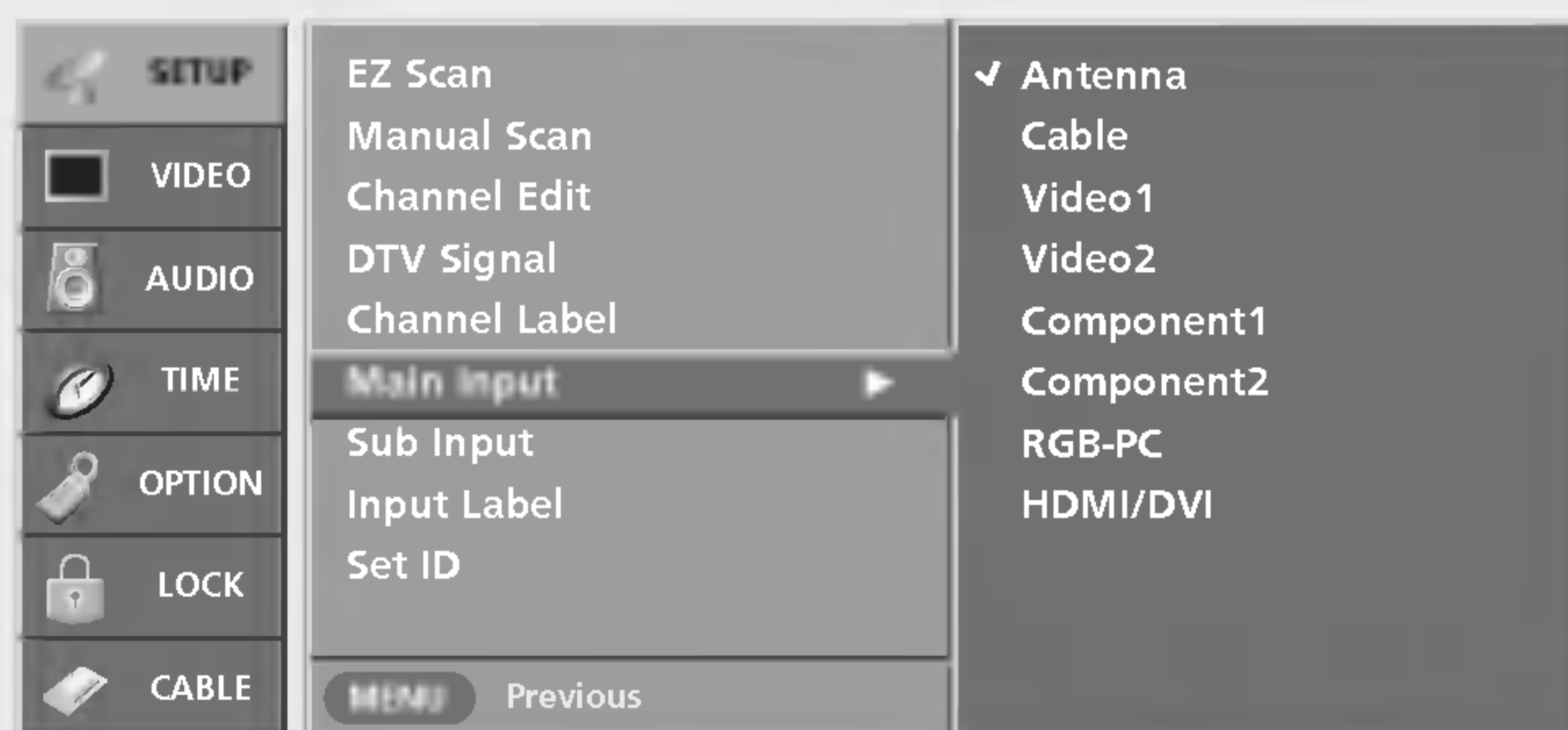

- **Antenna:** Select it when watching the TV/DTV.
- **Cable:** Select it when watching the CATV/CADTV.
- **Video1-2:** Select it when watching the VCR or external equipment.
- **Component 1-2:** Select it when using the DVD or the Digital set-top box depend on connector.
- **RGB-PC / RGB-DTV:** Select it when using PC or Digital set-top box depend on connector.
- **HDMI / DVI:** Select it when using DVD, PC or Digital set-top box depend on connector.



EZ Mute

- When you repeatedly press the **MUTE** button, the sound mode is changed in turn. (Refer to the picture below)

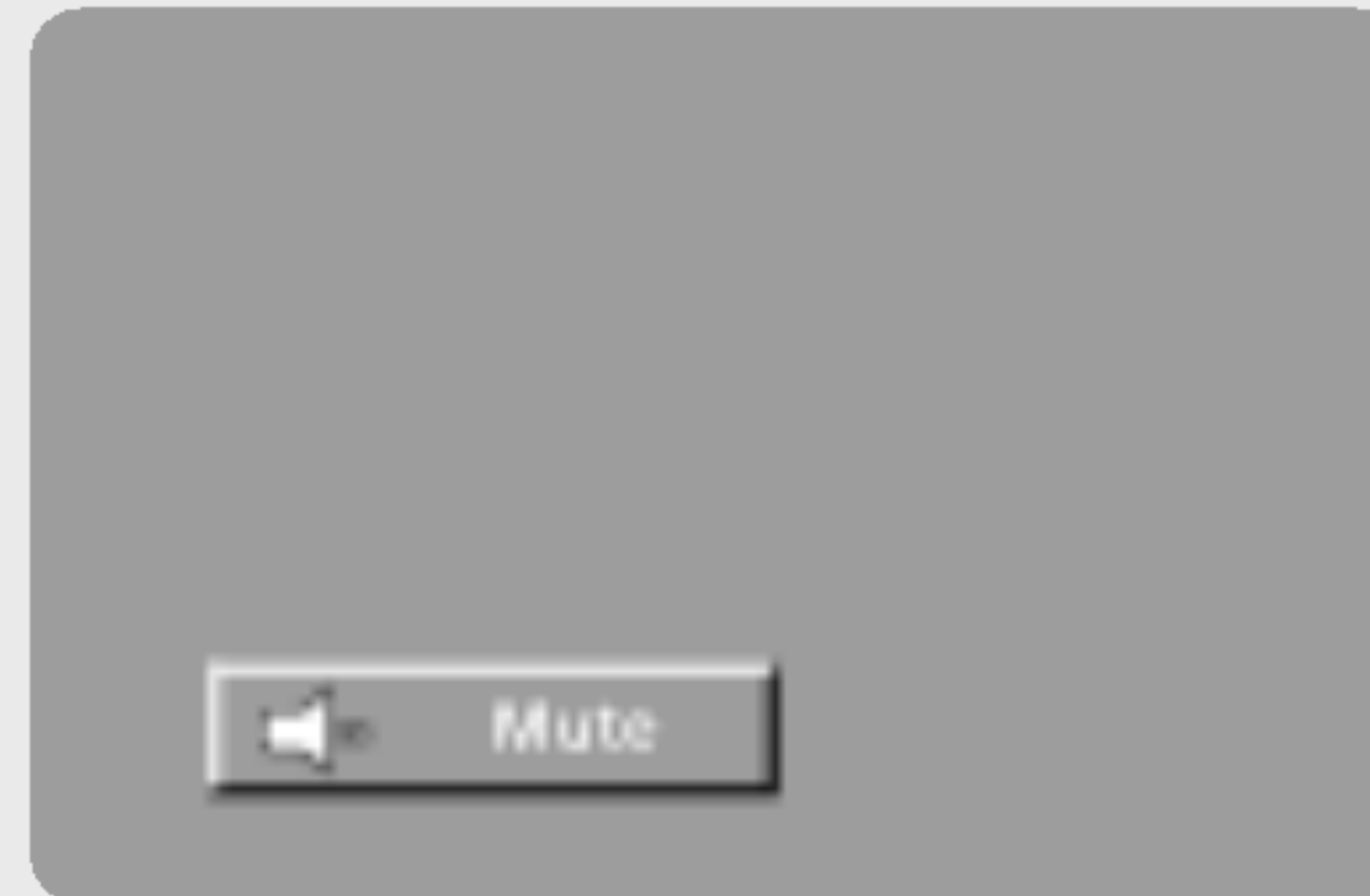

Mute: Sound is muted.

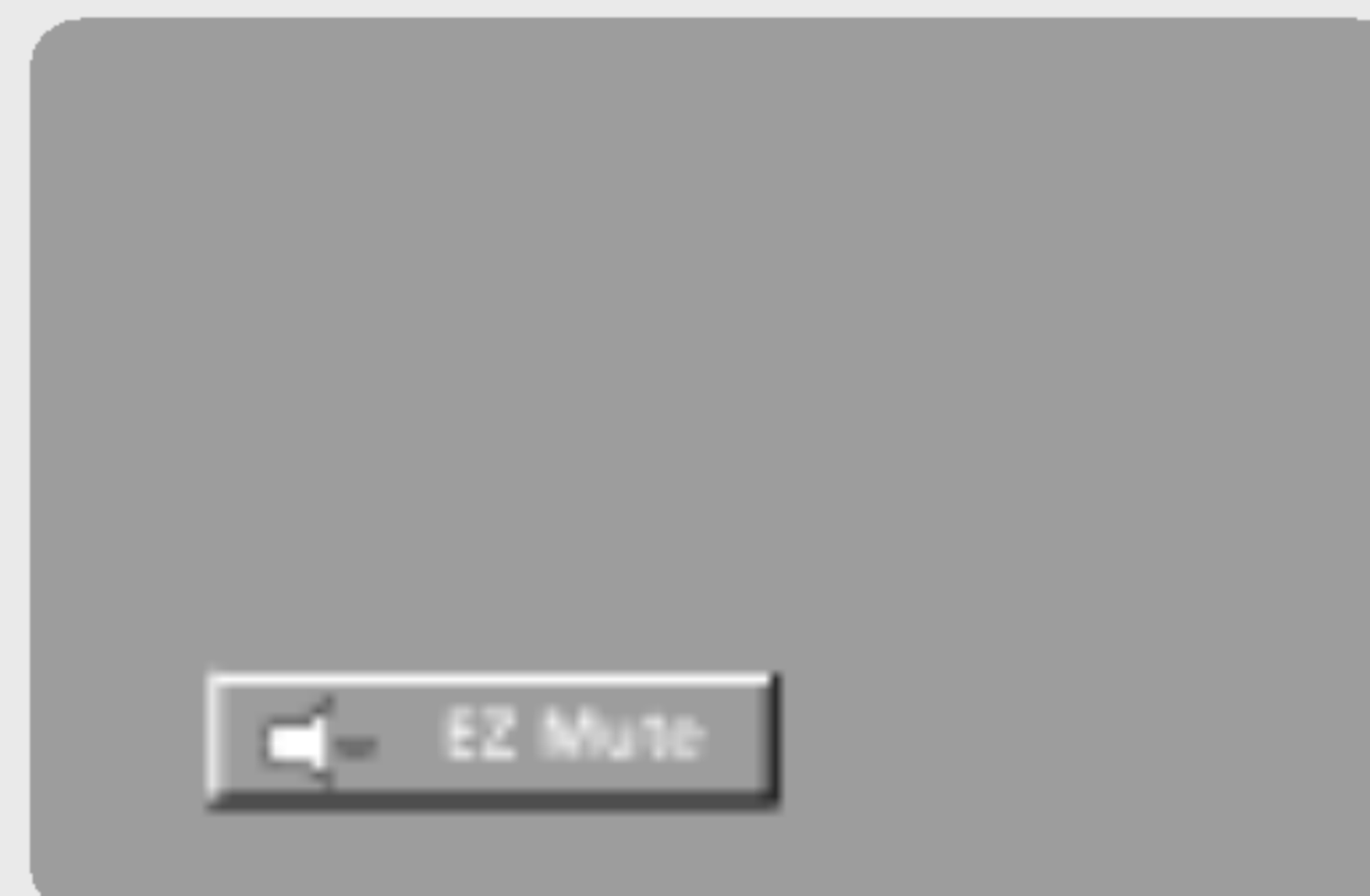

EZ Mute: A special mute mode to activate the closed caption automatically.



Mute Off: Sound is enabled.

Note: EZ Mute does not operate in Component/RGB/HDMI/DVI modes.

Installation

Various Installation

Wall Mount: Horizontal installation

For proper ventilation, allow a clearance of 4" on each side and from the wall. Detailed installation instructions are available from your dealer, see the optional Tilt Wall Mounting Bracket Installation and Setup Guide.

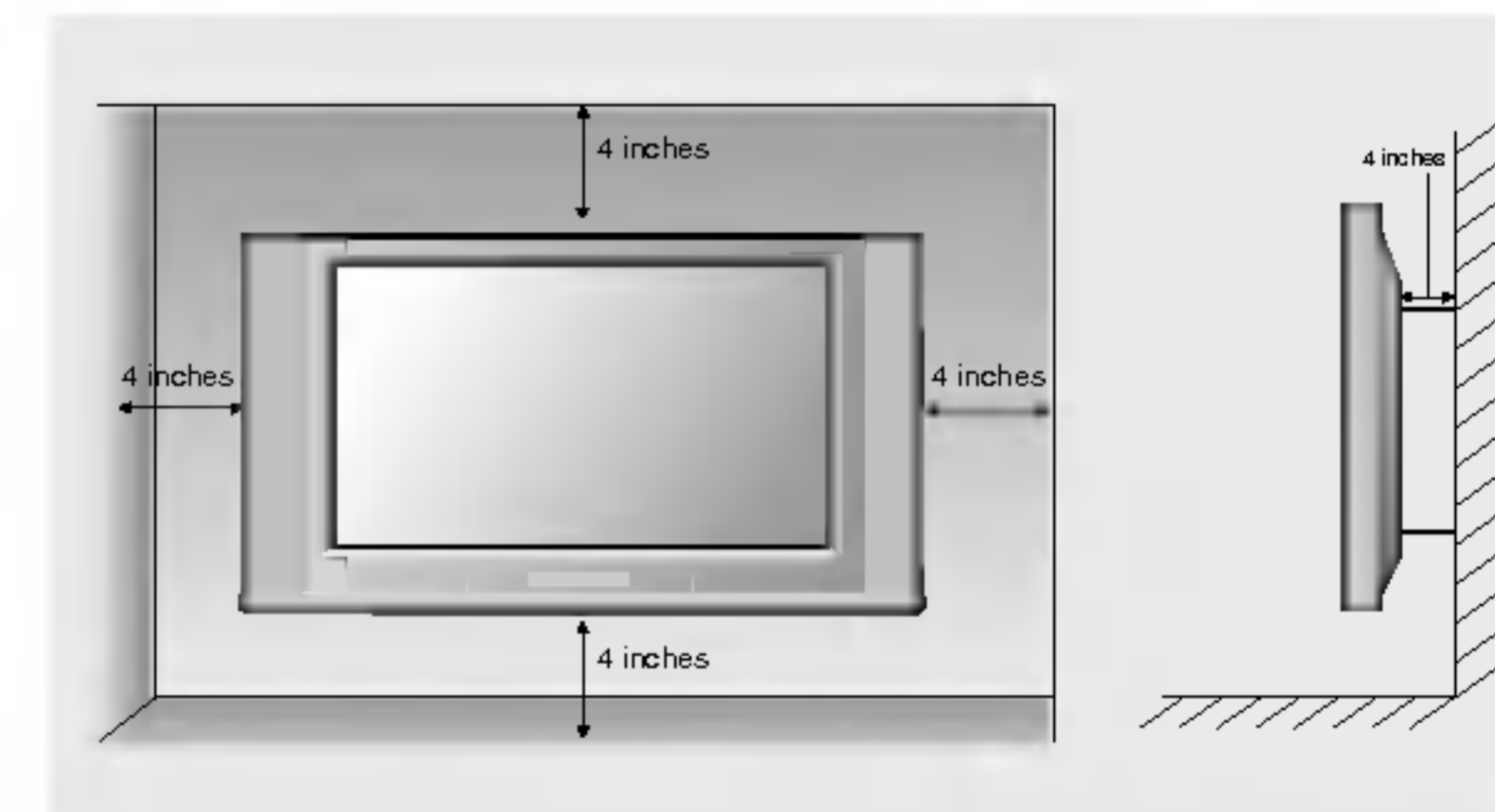
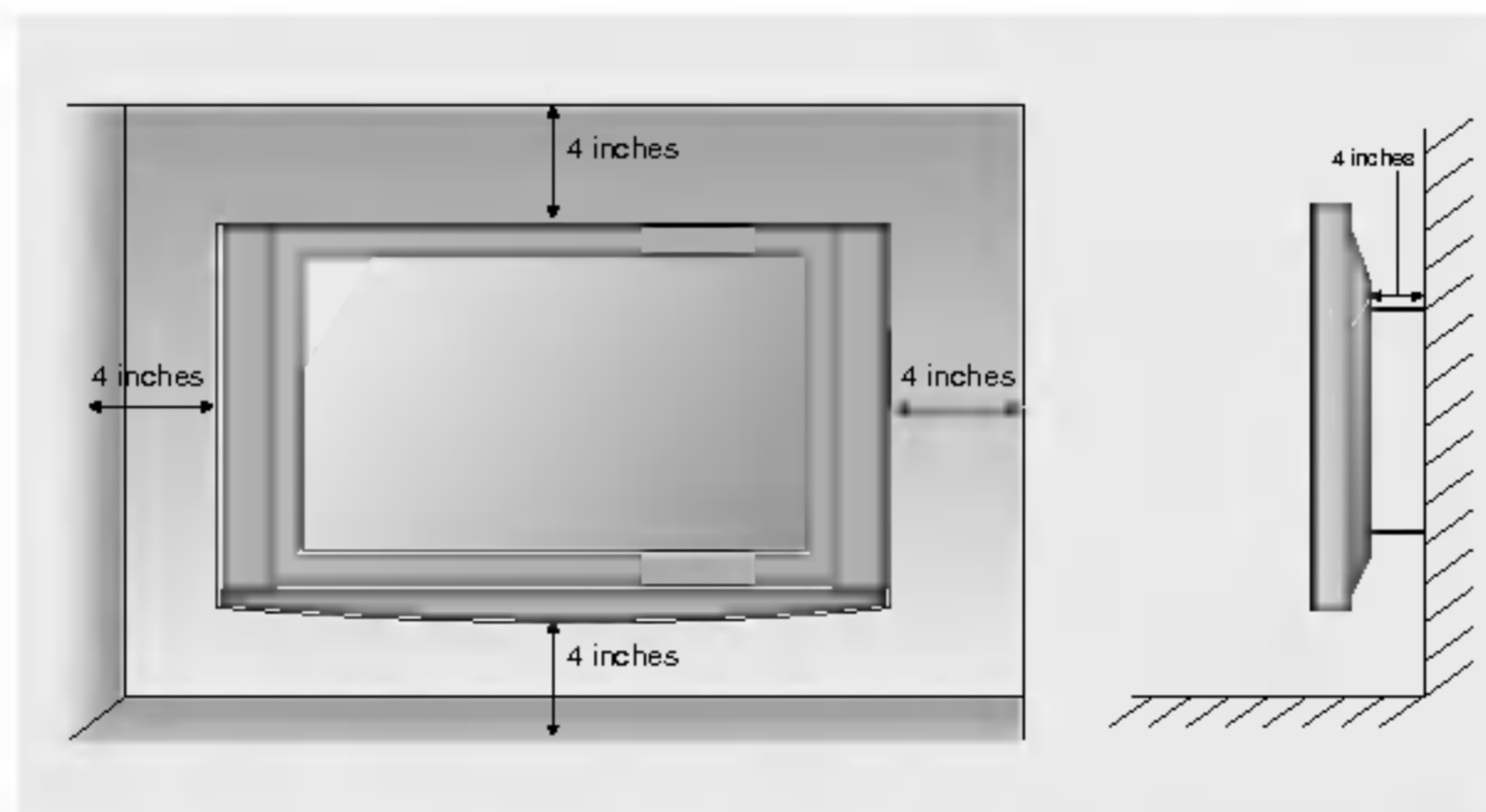
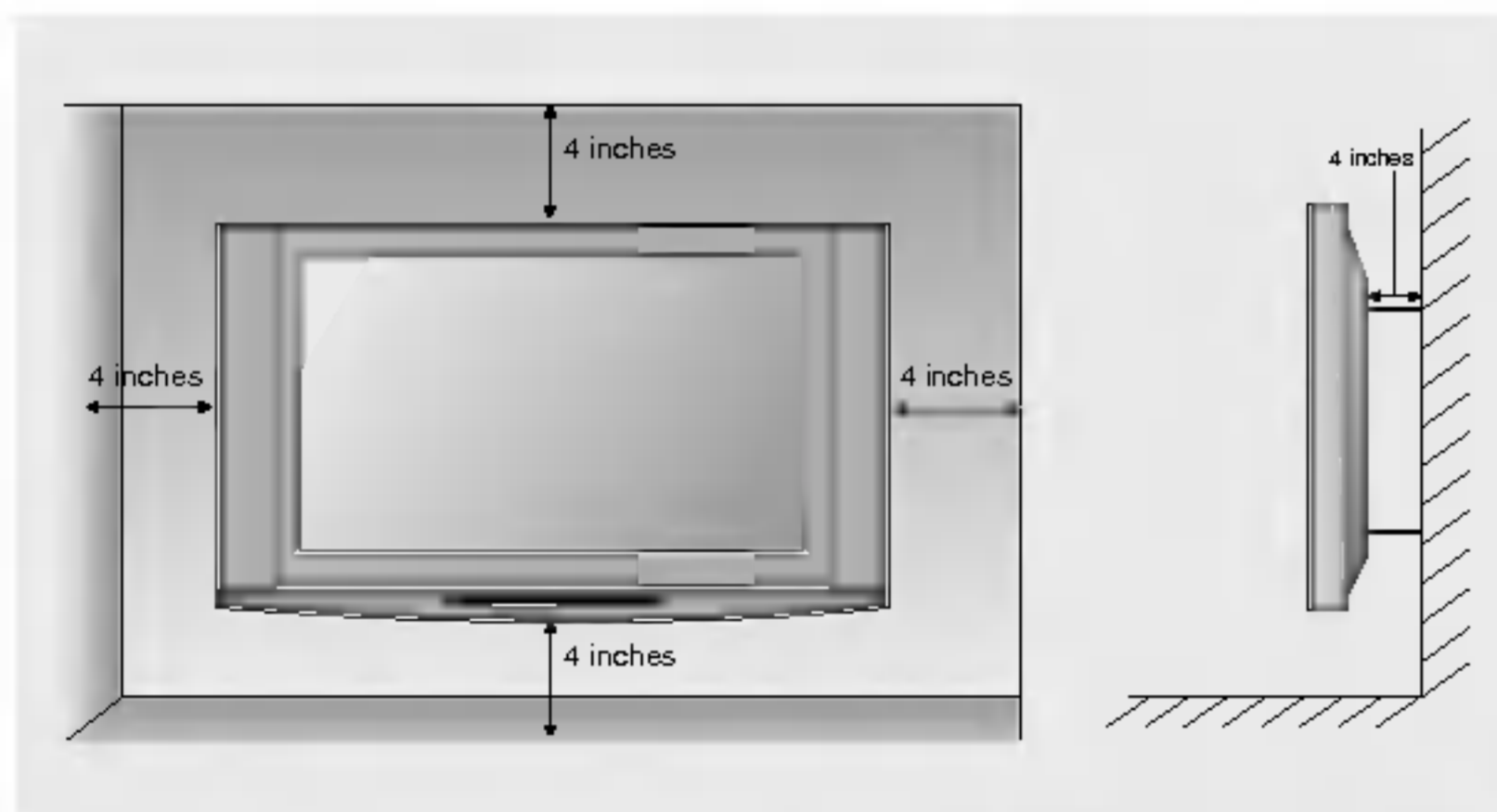
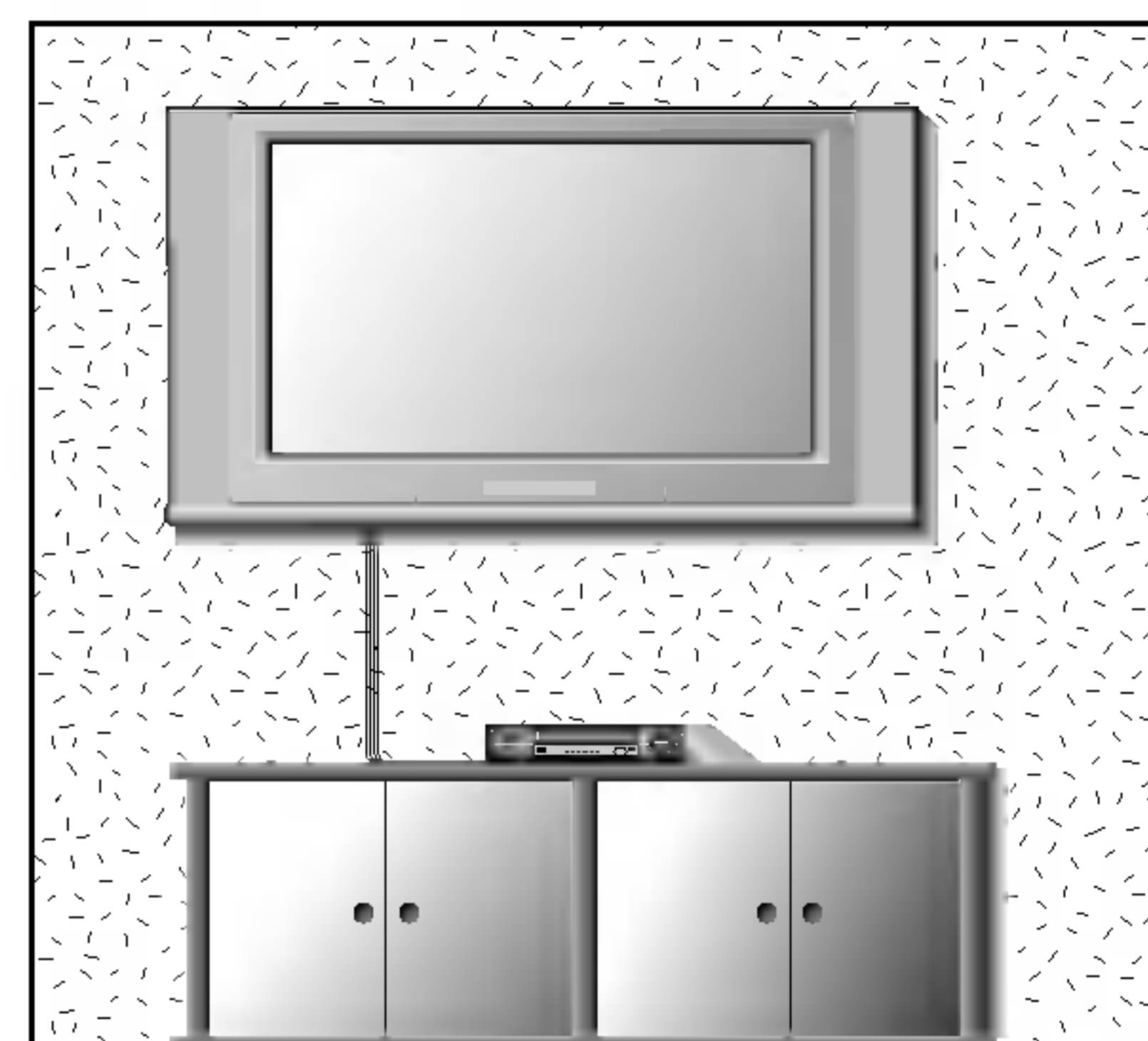
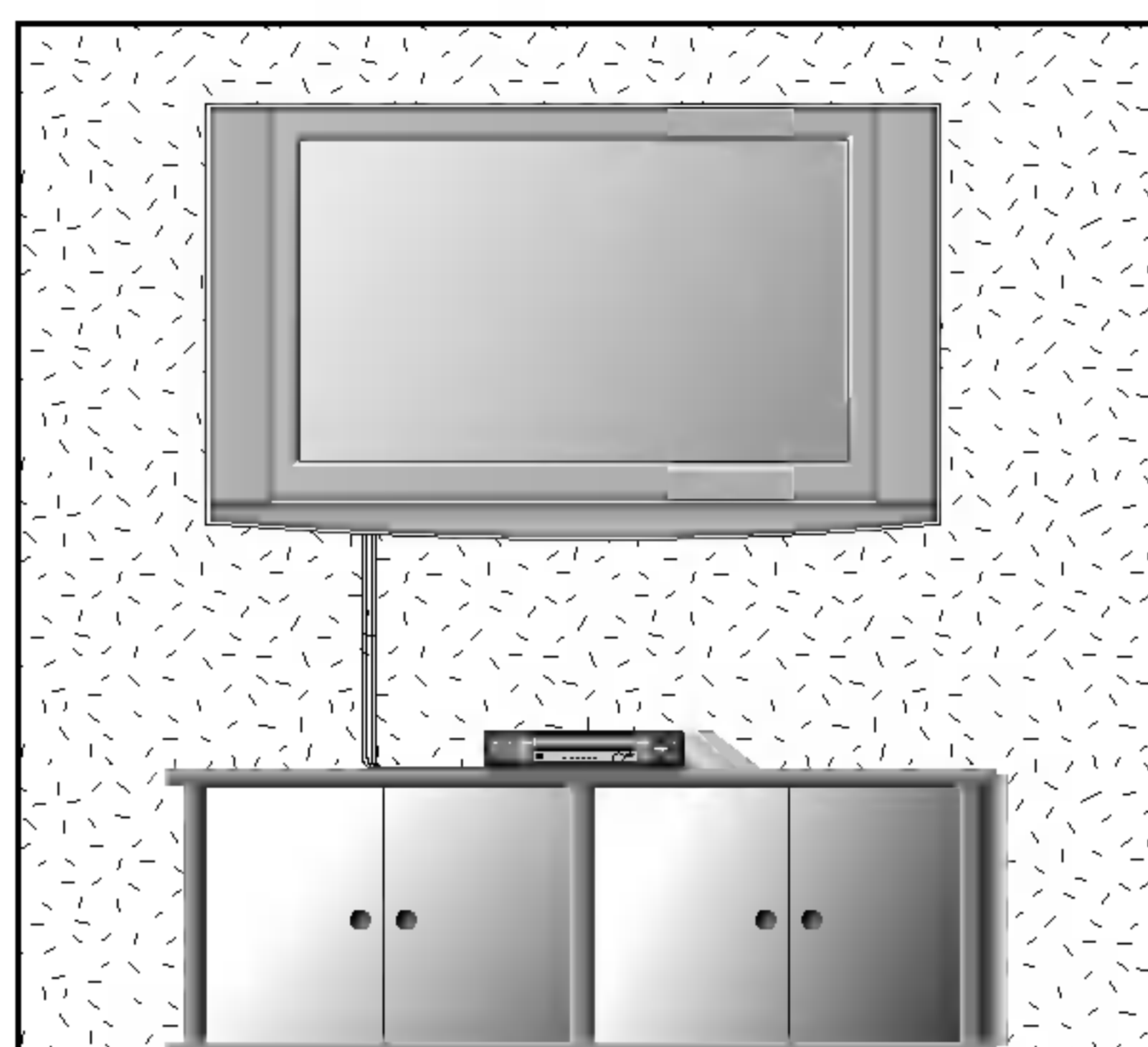
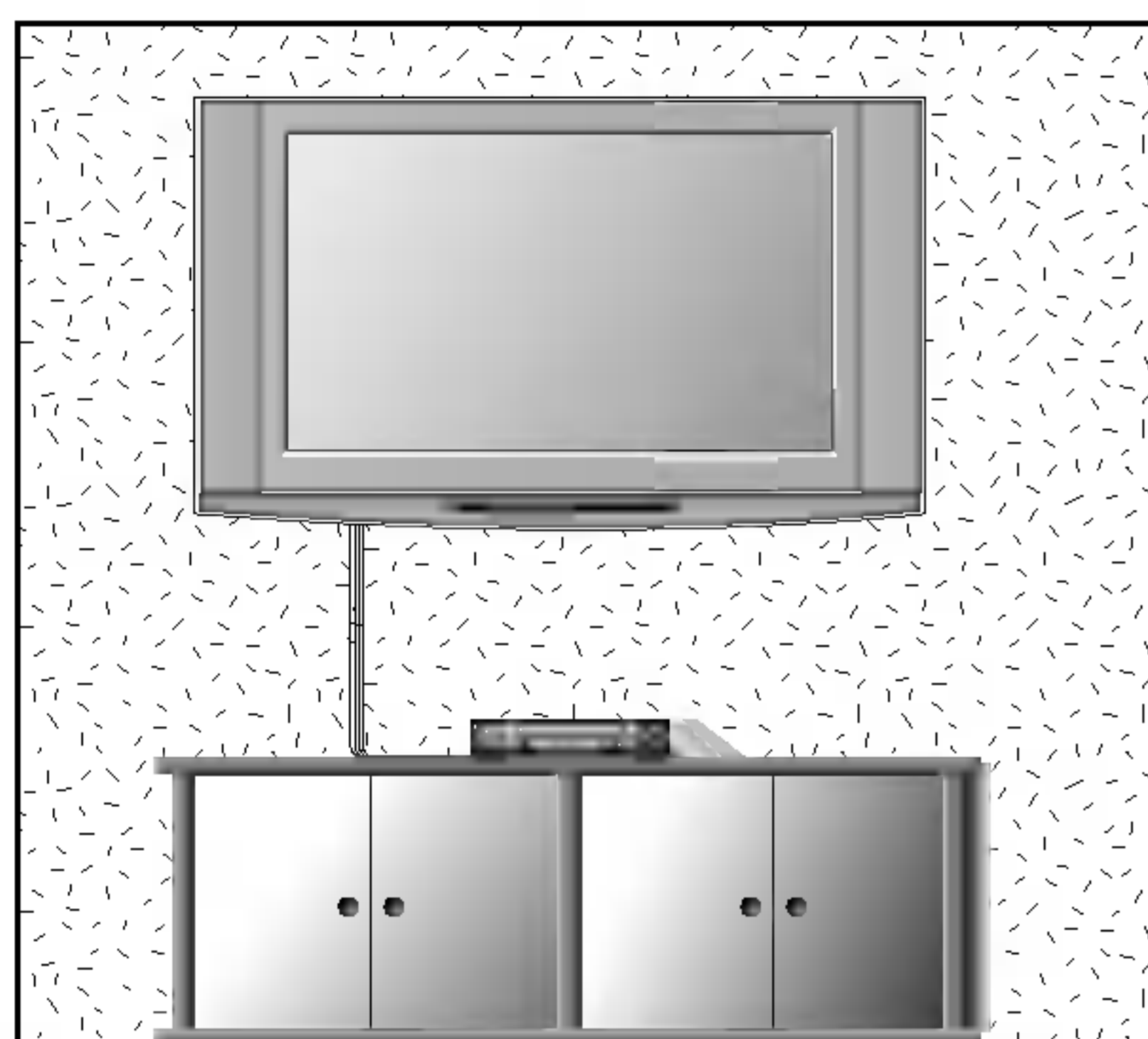

Desktop Pedestal Installation

For proper ventilation, allow a clearance of 4" on each side and from the wall.

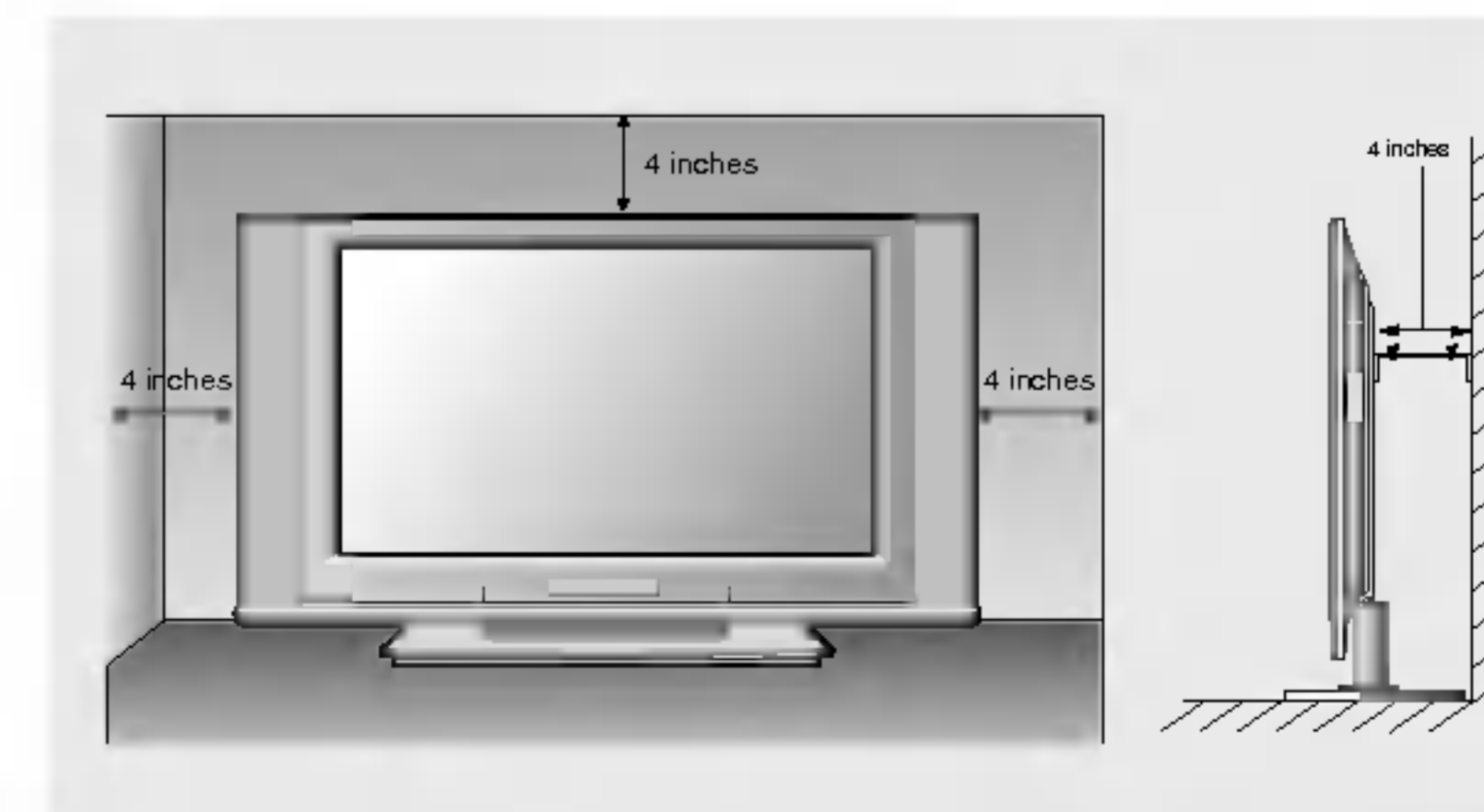
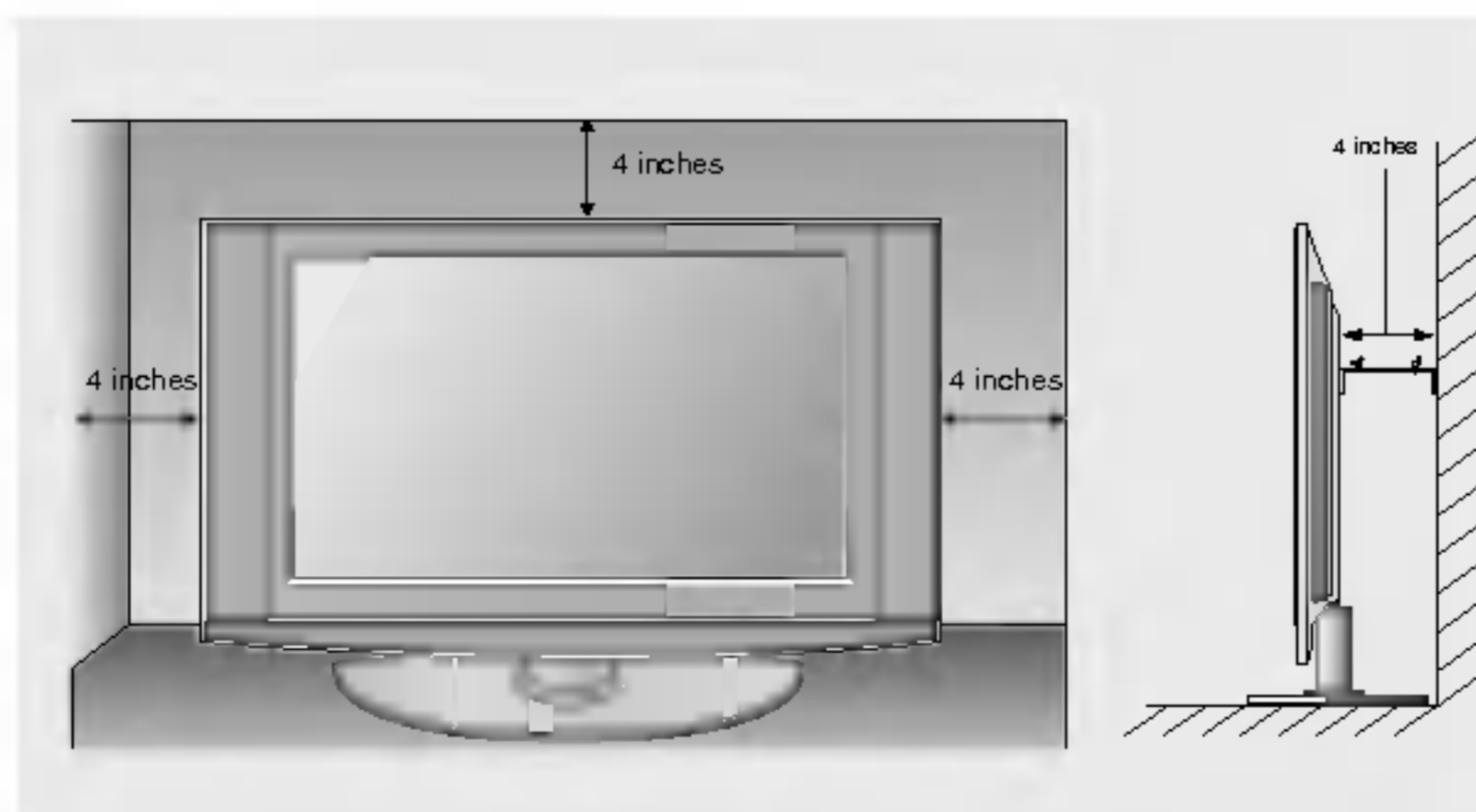
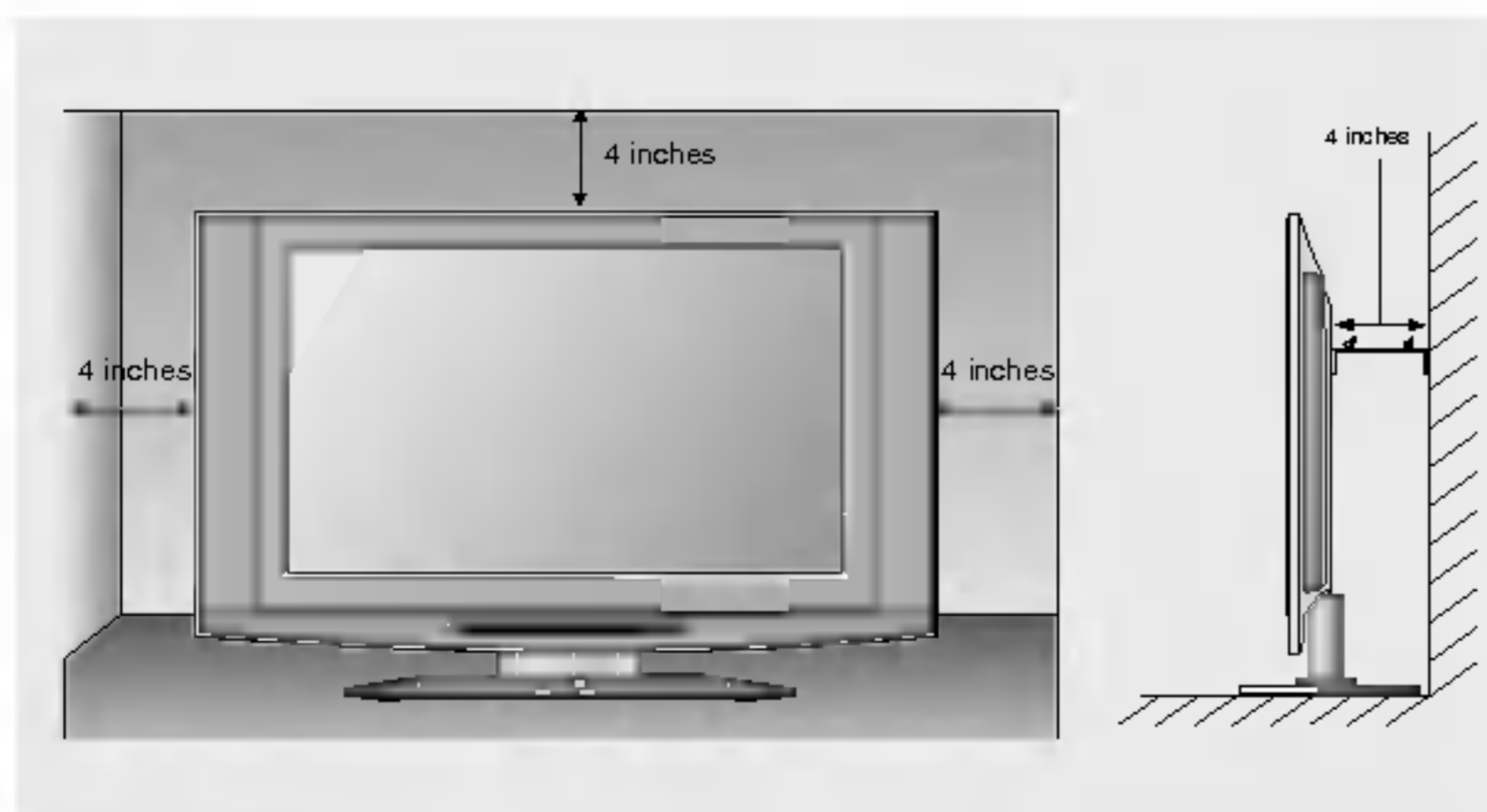
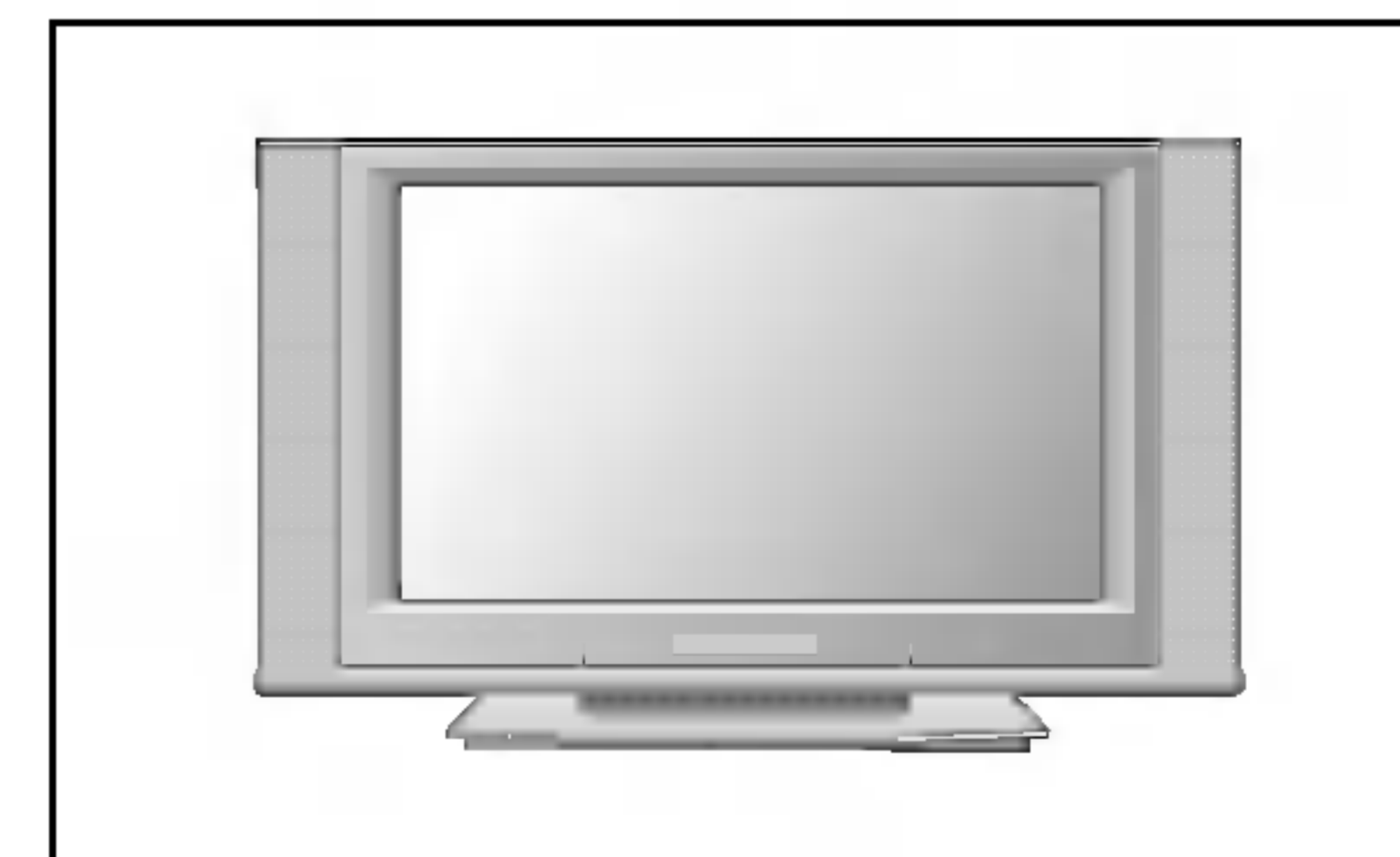
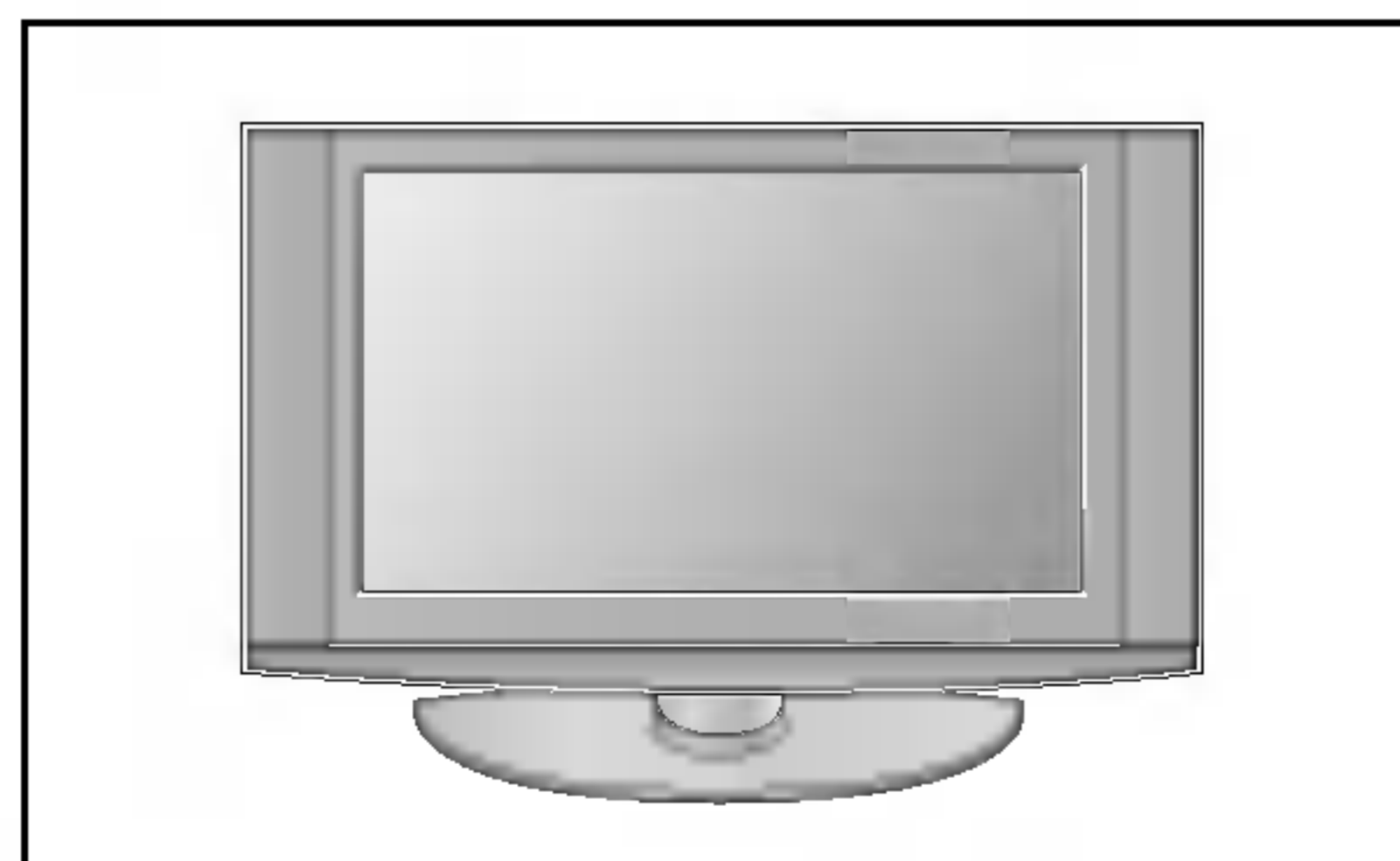

How to use back cover

1 Hold the cover with both hands and pull it backward.

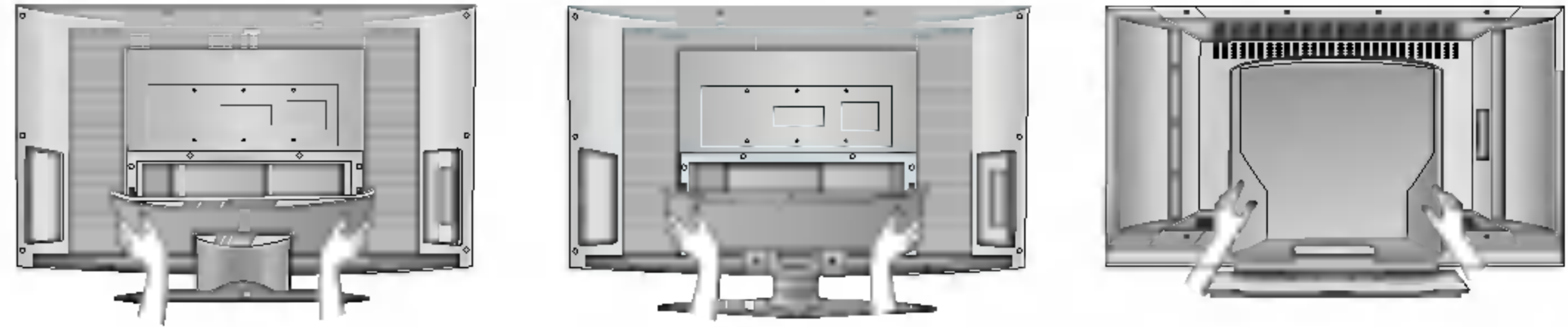

2 Install wires as necessary.
(To install various wires, refer to p.21~41.)

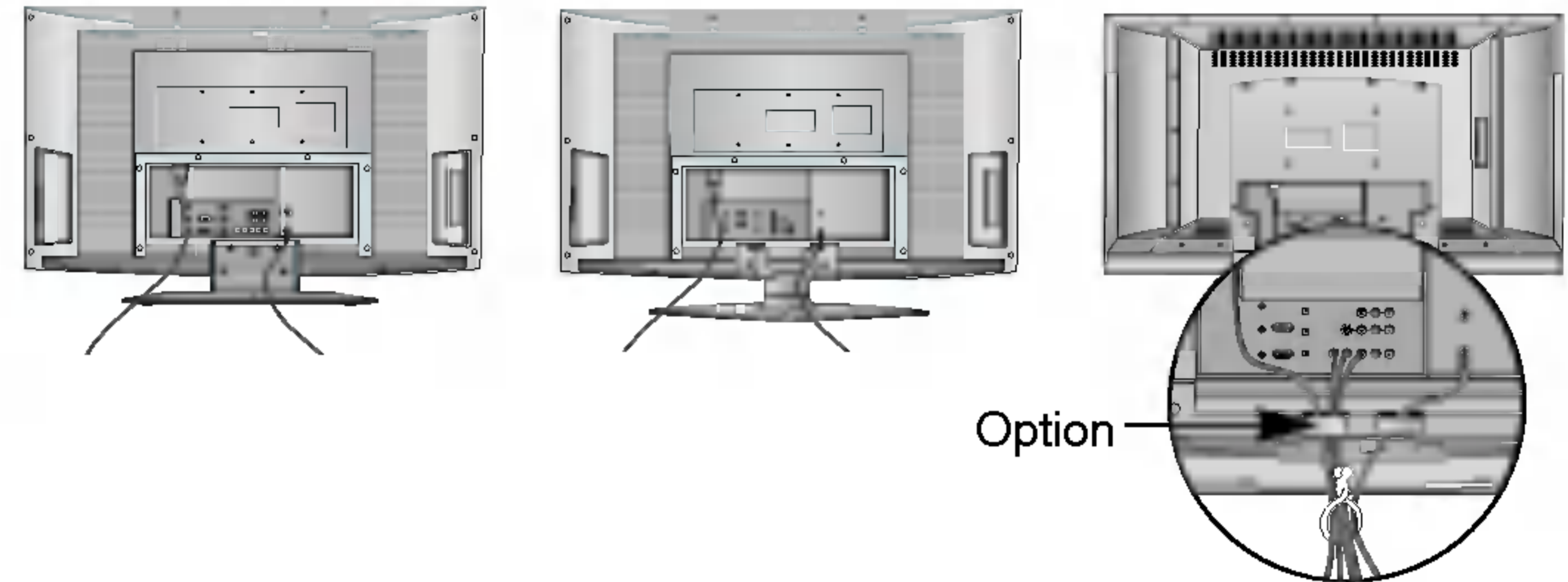

Option

* Arrange the signal input cable and the power cord by holder, as shown.

3 Align the holes on the TV back panel with the protuberances on the back cover and insert.

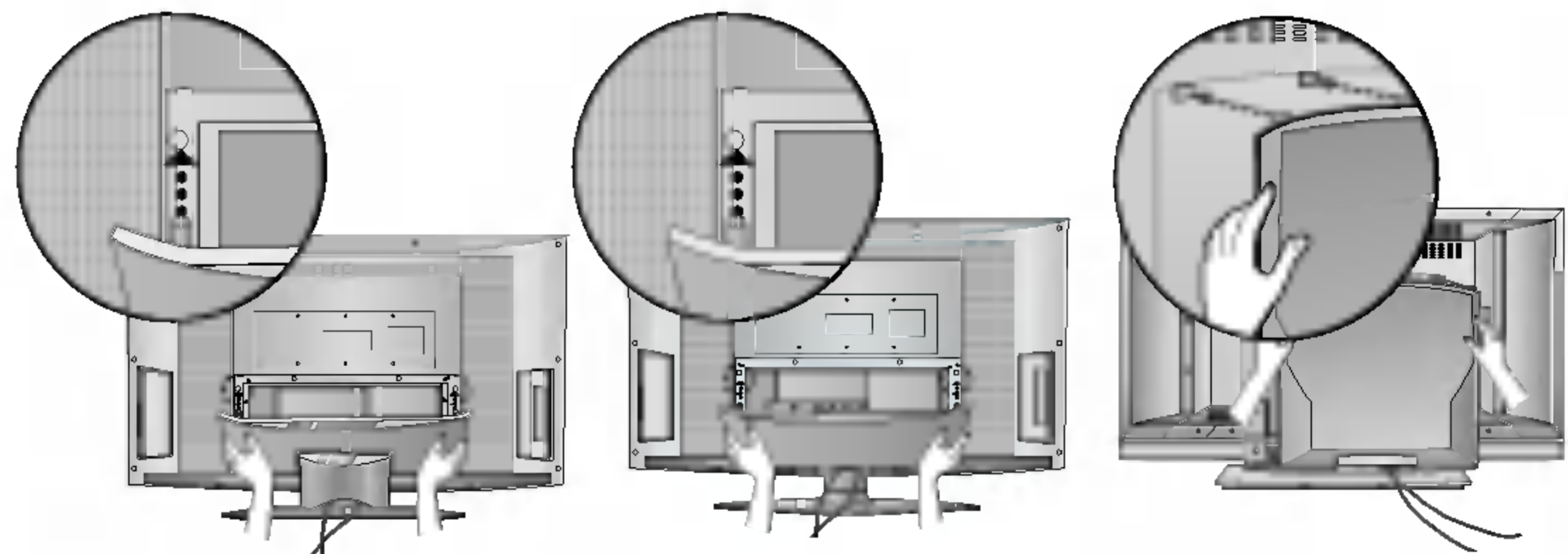

4 Reinstall the cover.

Wire Arrangement

- Pull the cables through the hole on the set.

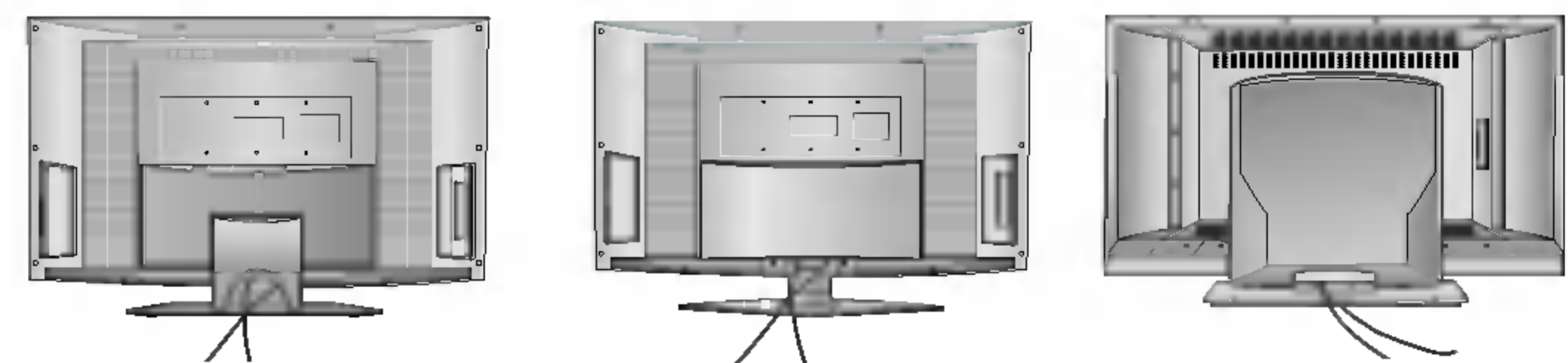

Swivel Stand (32/37/42LP1D, 26/32LX2D only)

- The TV can be conveniently swivelled on its stand 30° to the left or right to provide the optimum viewing angle.

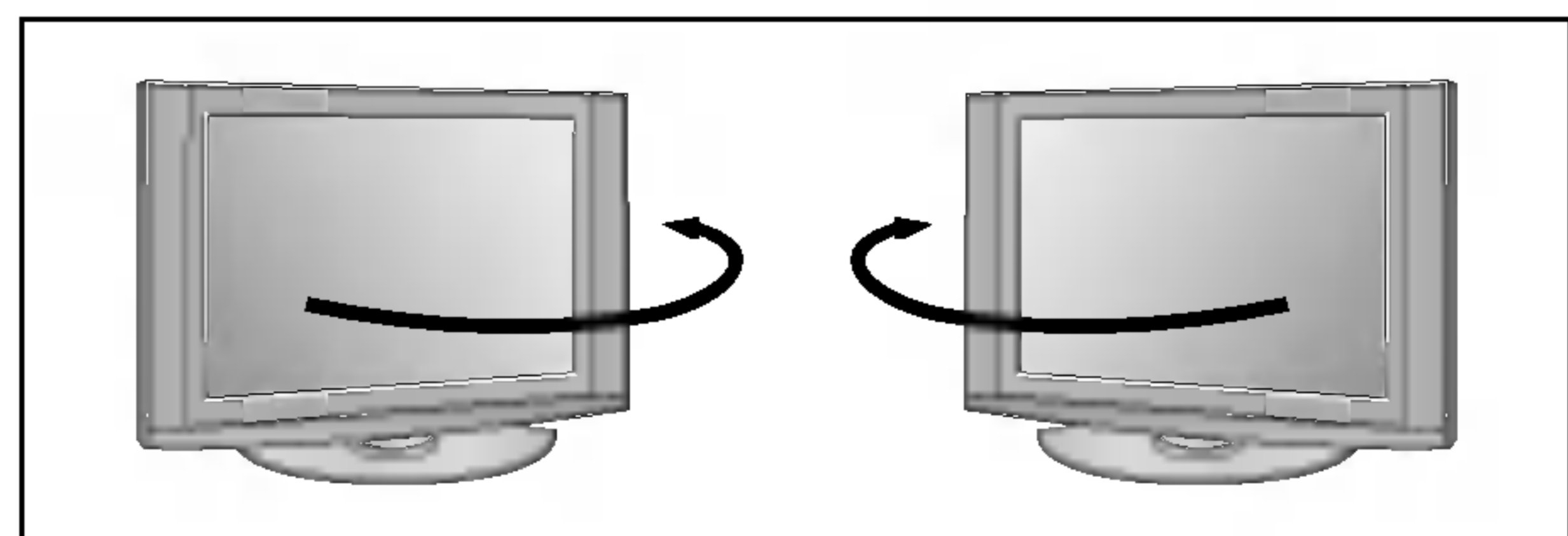
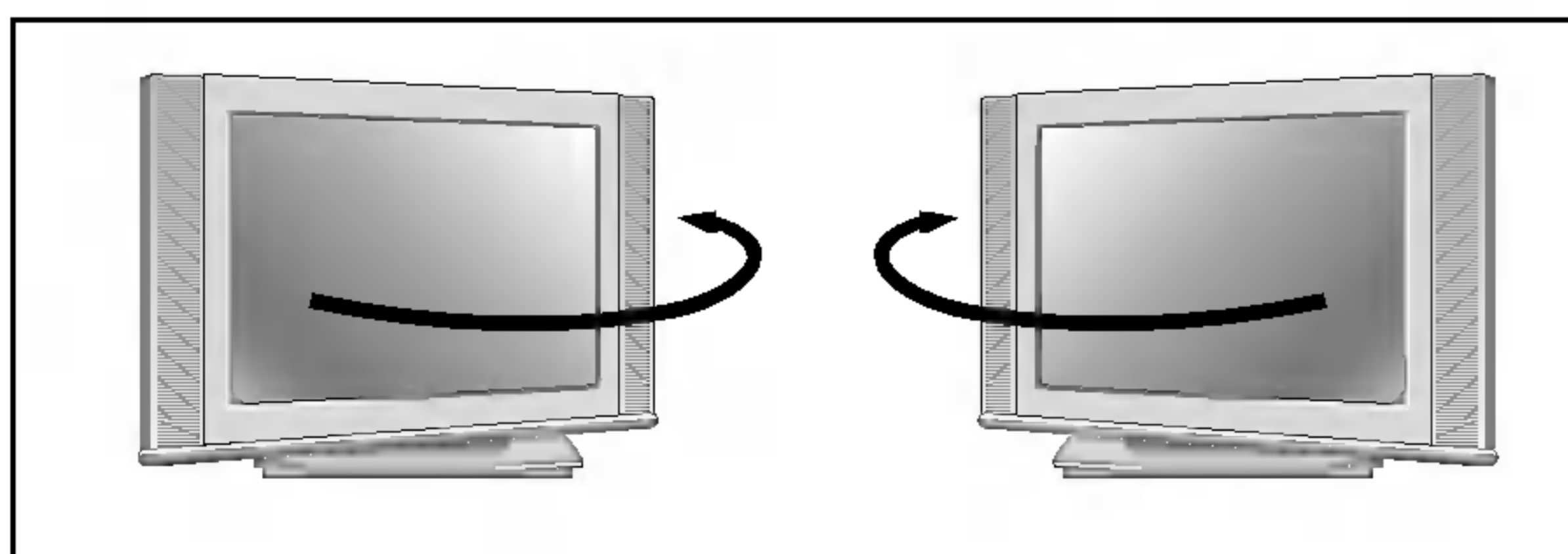

External Equipment Connections

NOTE: All cables shown are not included with the TV

Antenna or Cable Connection

Analog and Digital TV signals provided on antenna

- Antenna or Cable Service without a Cable Box Connection.
- For optimum picture quality, adjust antenna direction if needed.



Multi-family Dwellings/Apartments
(Connect to wall antenna socket)

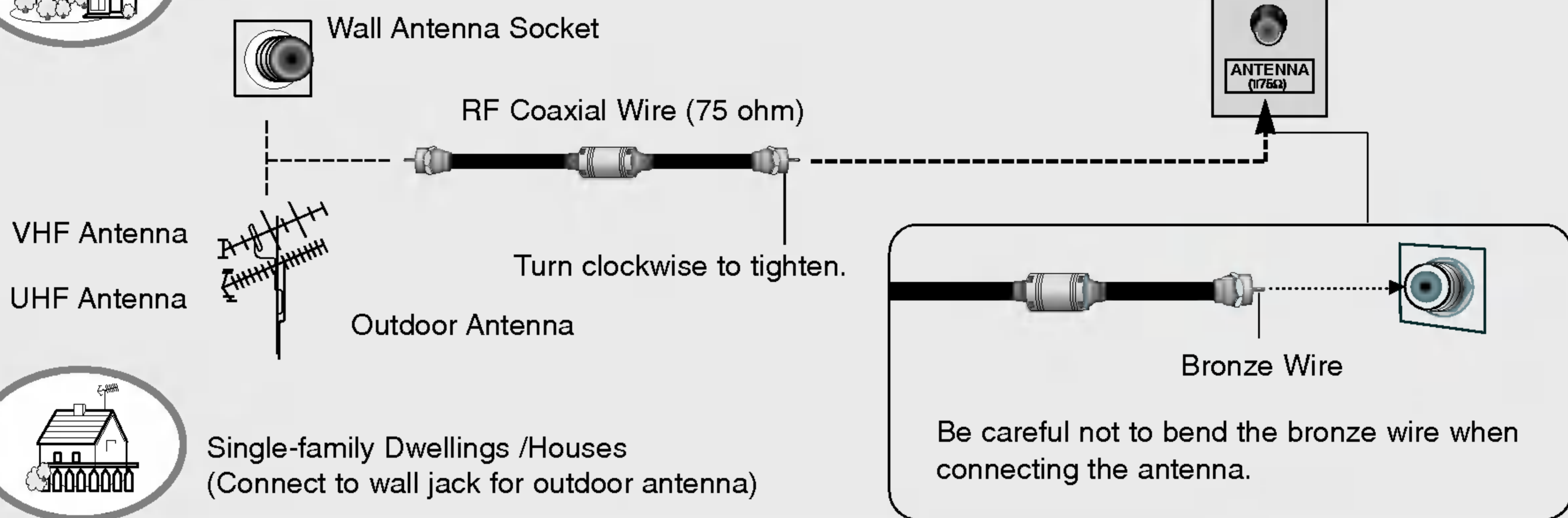

Single-family Dwellings /Houses
(Connect to wall jack for outdoor antenna)

Analog and Digital TV signals provided on cable

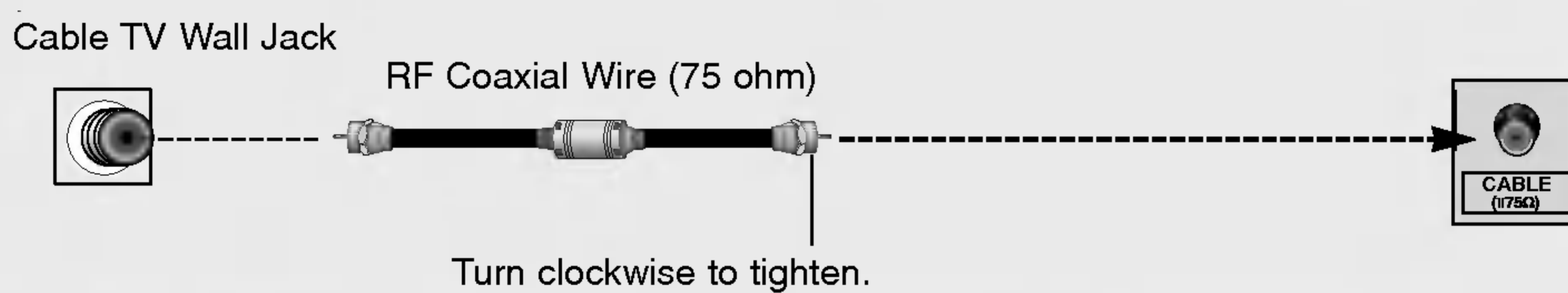
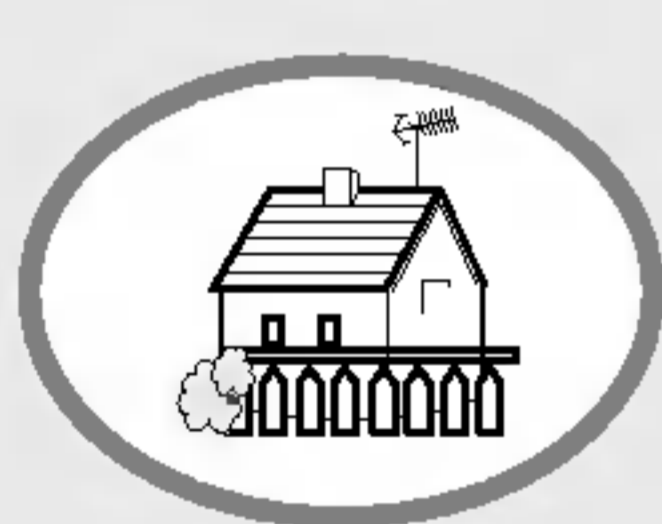

Analog and Digital TV signals provided on cable and antenna

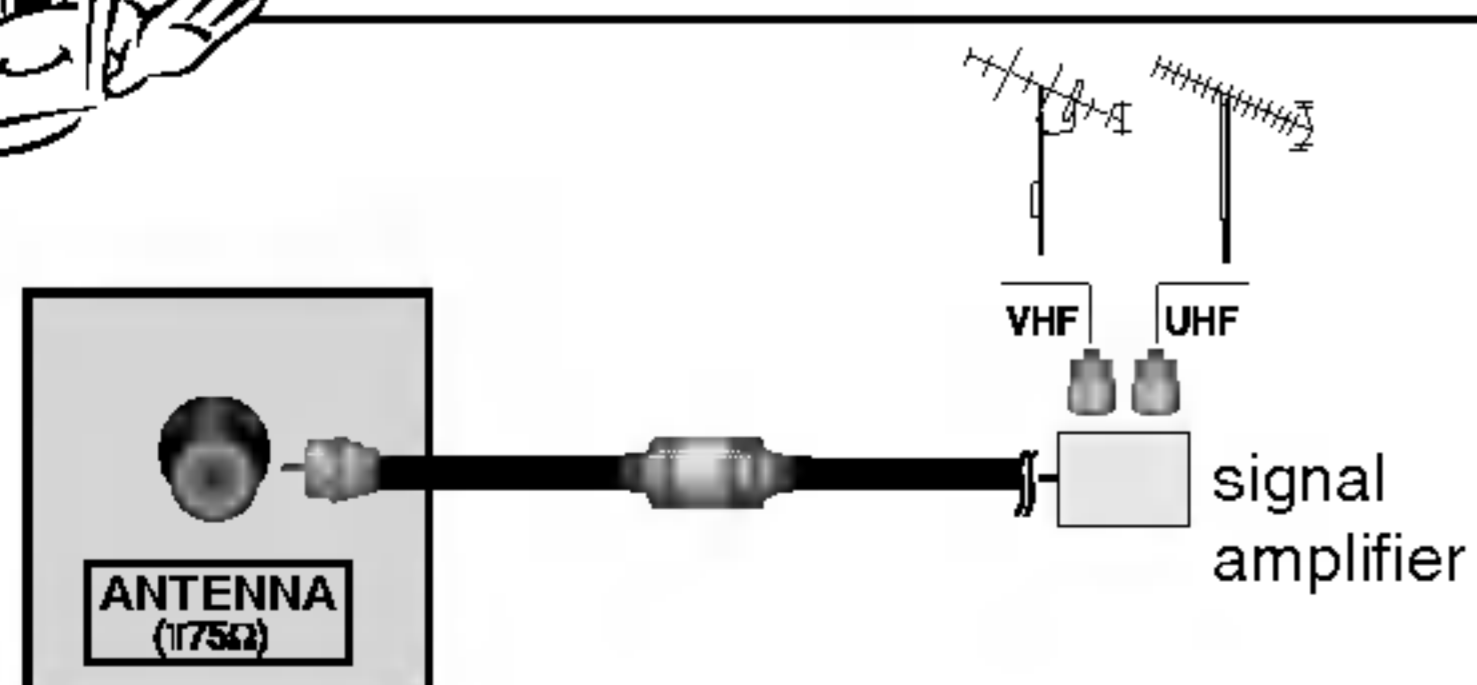
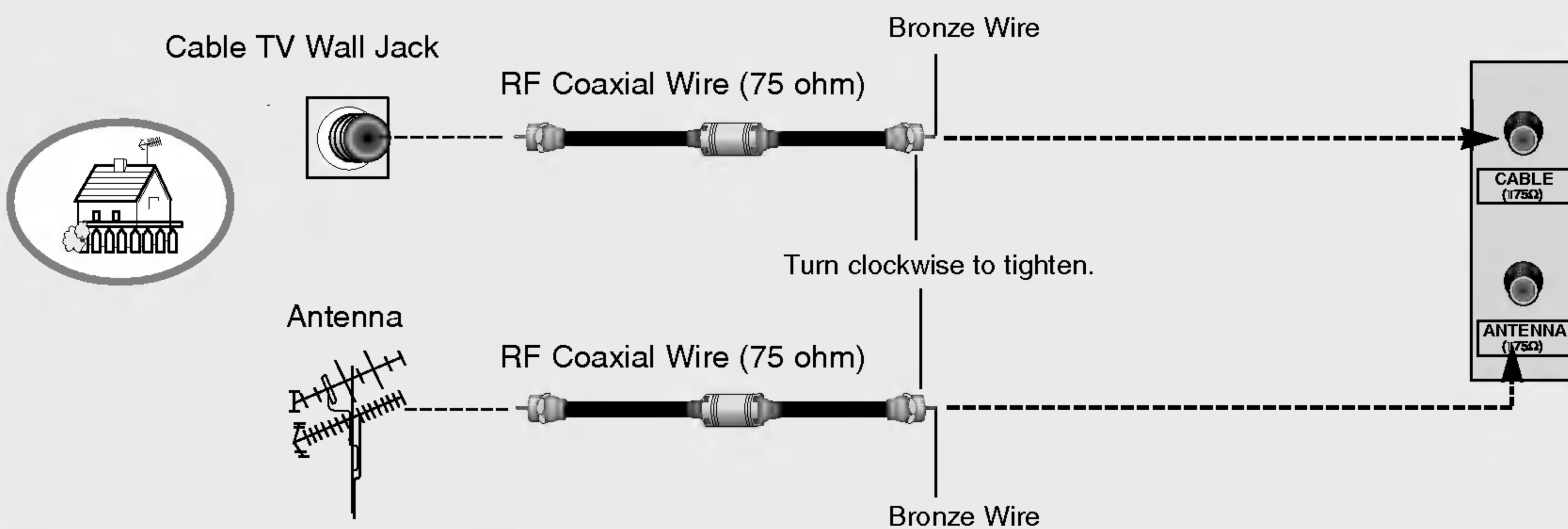

- In a poor signal area to improve picture quality, purchase and install a signal amplifier.
- If the antenna needs to be split for two TV's, install a "2-Way Signal Splitter" in the connections.
- If the antenna is not installed properly, contact your dealer for assistance.

VCR Setup

- To avoid picture noise (interference), leave an adequate distance between the VCR and TV.
- Typically a frozen still picture from a VCR. If the 4:3 picture format is used; the fixed images on the sides of the screen may remain visible on the screen.

When connecting with an antenna

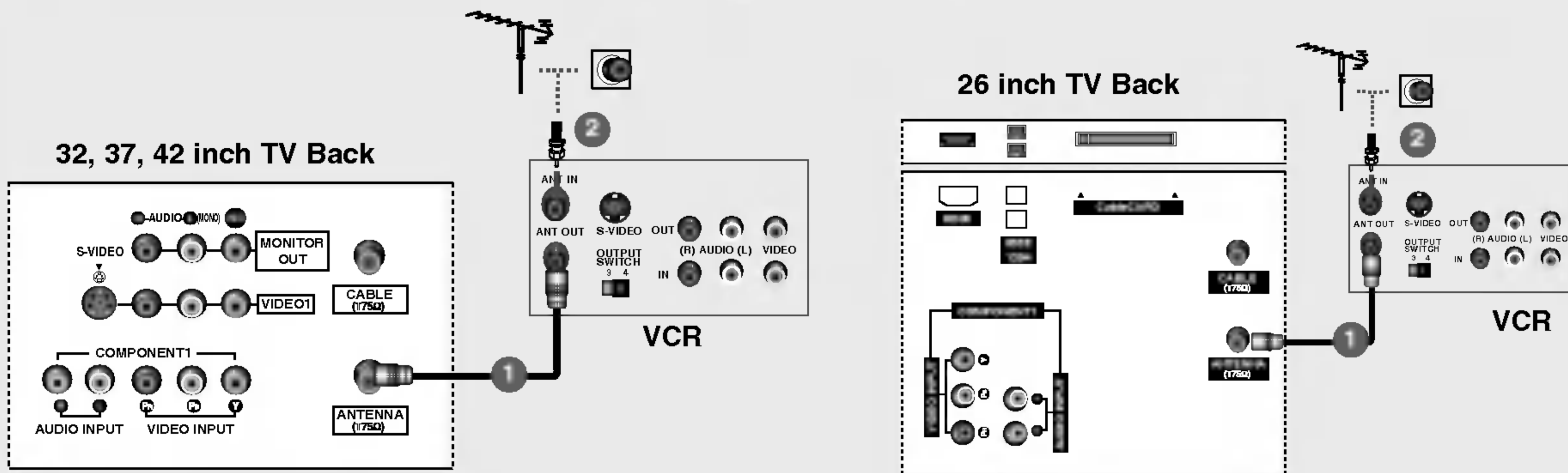

- 1 Connect the RF antenna out socket of the VCR to the **Antenna** socket on the set.
- 2 Connect the antenna cable to the RF antenna in socket of the VCR.
- 3 Set VCR output switch to 3 or 4 and then tune TV to the same channel number.
- 4 Insert a video tape into the VCR and press PLAY on the VCR. (Refer to the VCR owner's manual.)

When connecting with a RCA cable

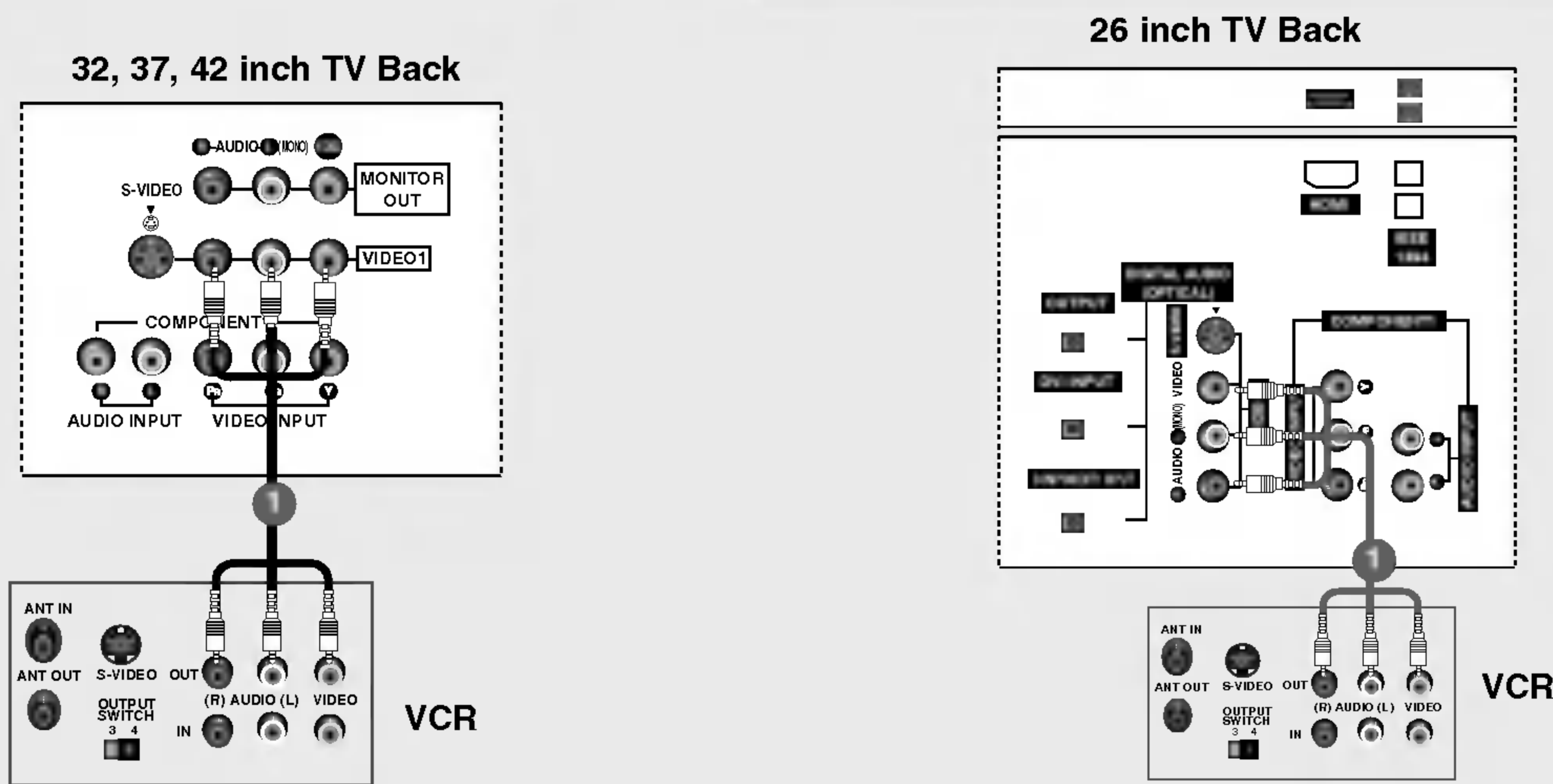

- 1 Connect the **AUDIO/VIDEO** jacks between TV and VCR. Match the jack colors (Video = yellow, Audio Left = white, and Audio Right = red)
- 2 Insert a video tape into the VCR and press PLAY on the VCR. (Refer to the VCR owner's manual.)
- 3 Select **Video1** input source using the **TV/VIDEO** button on the remote control.
 - If connected to **VIDEO2**, select **Video2** input source.

• If you have a mono VCR, connect the audio cable from the VCR to the **AUDIO L/MONO** jack of the set.

When connecting with an S-Video cable

32, 37, 42 inch TV Back

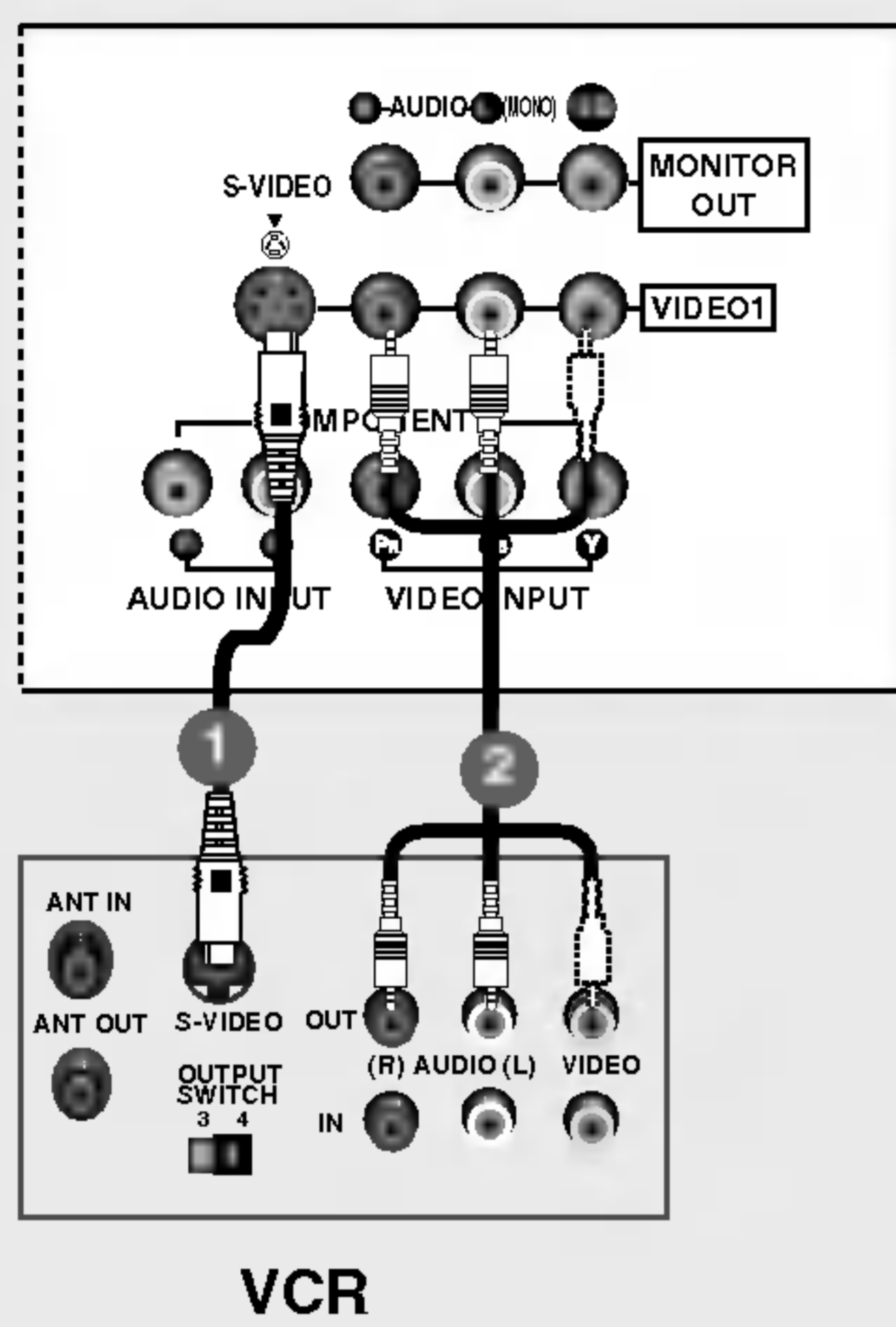

VCR

26 inch TV Back

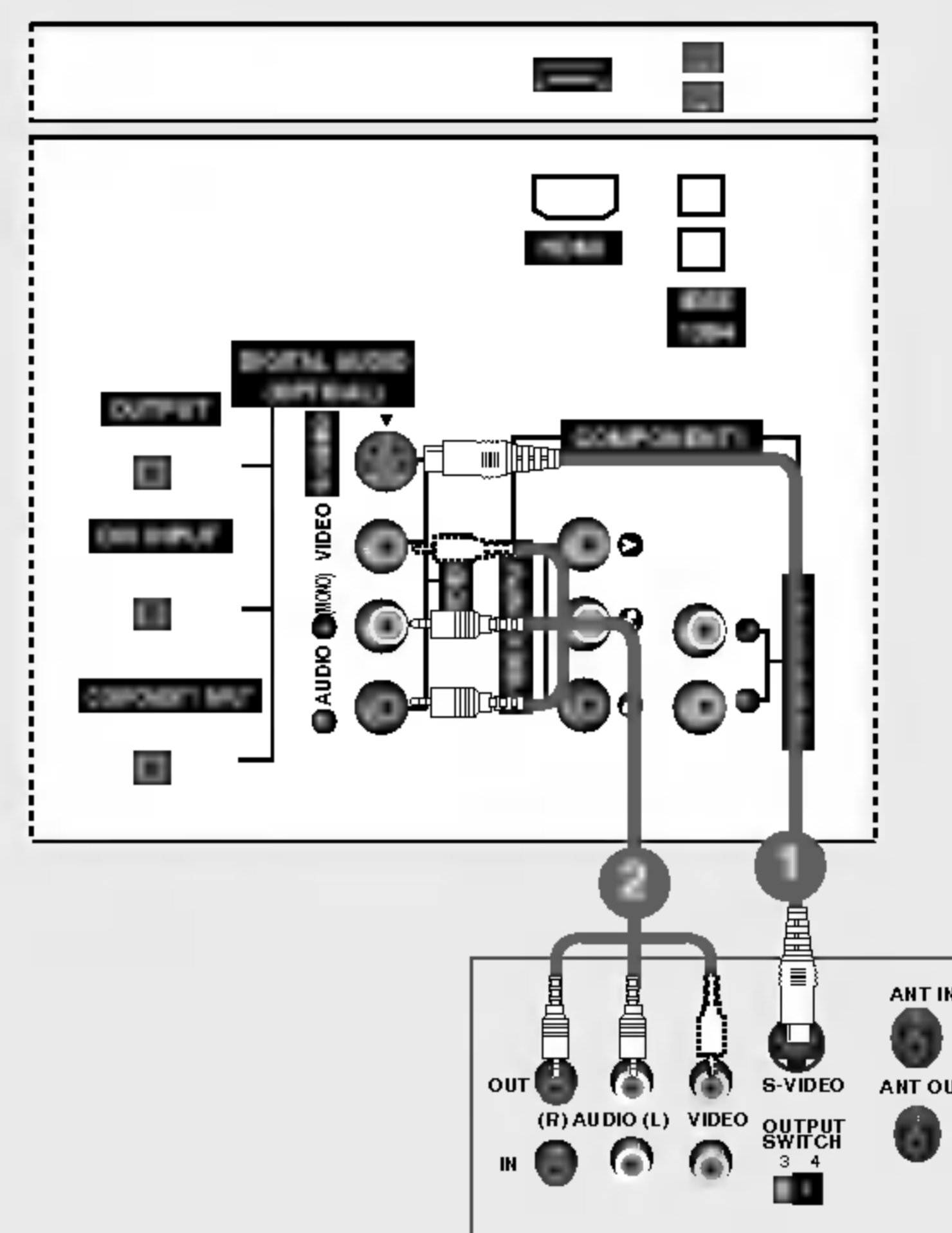

VCR

- ❶ Connect the S-VIDEO output of the VCR to the **S-VIDEO** input on the set. The picture quality is improved; compared to normal composite (RCA cable) input.
- ❷ Connect the audio outputs of the VCR to the **AUDIO** input jacks on the set.
- ❸ Insert a video tape into the VCR and press PLAY on the VCR. (Refer to the VCR owner's manual.)
- ❹ Select **Video1** input source with using the **TV/VIDEO** button on the remote control.
- If connected to **VIDEO2**, select **Video2** input source.



Do not connect to both Video and S-Video at the same time.

DVD Setup

When connecting with a S-Video cable

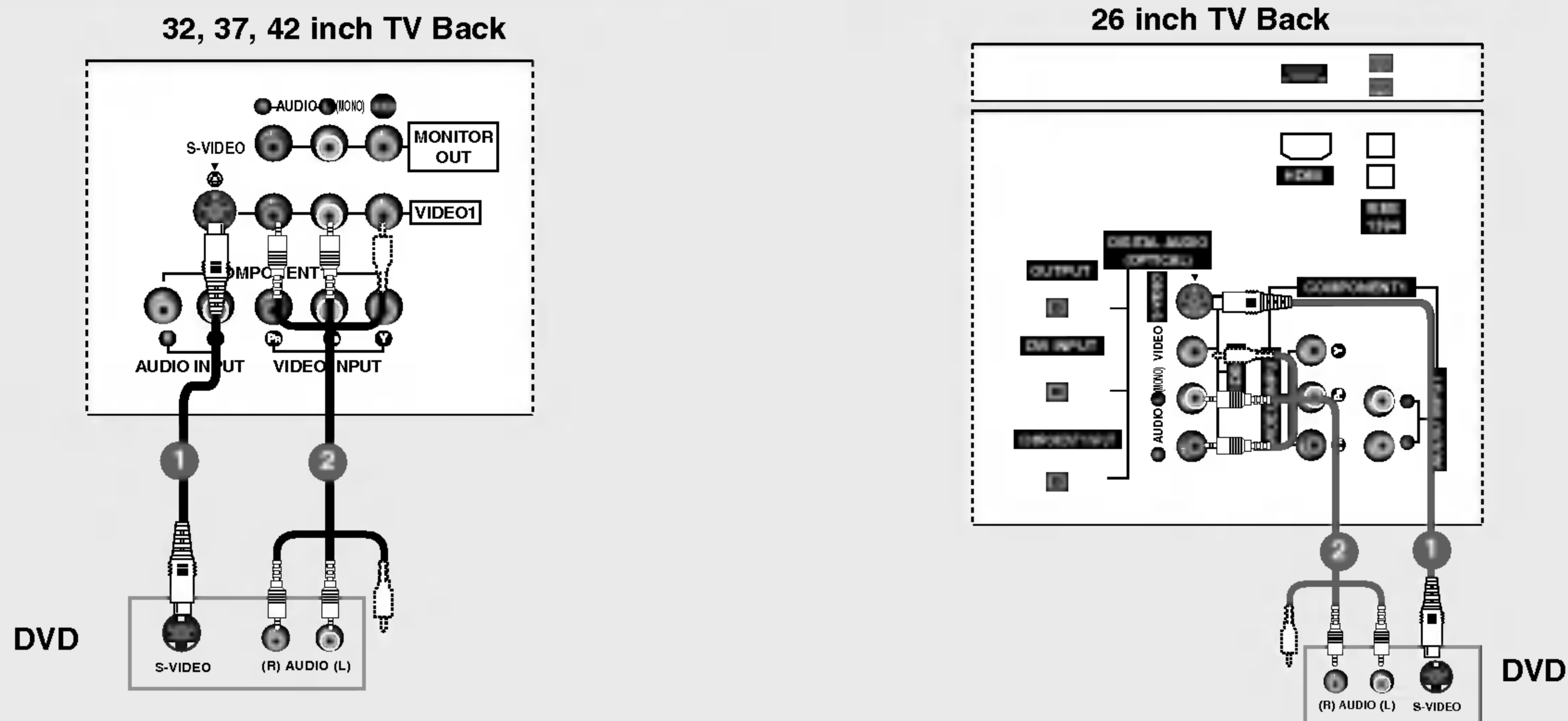

- 1 Connect the S-VIDEO output of the DVD to the **S-VIDEO** input on the set.
- 2 Connect the audio outputs of the DVD to the **AUDIO** input jacks on the set.
- 3 Turn on the DVD player, insert a DVD.
- 4 Select **Video1** input source with using the **TV/VIDEO** button on the remote control.
- If connected to **VIDEO2**, select **Video 2** input source.
- 5 Refer to the DVD player's manual for operating instructions.

When connecting with a HDMI cable

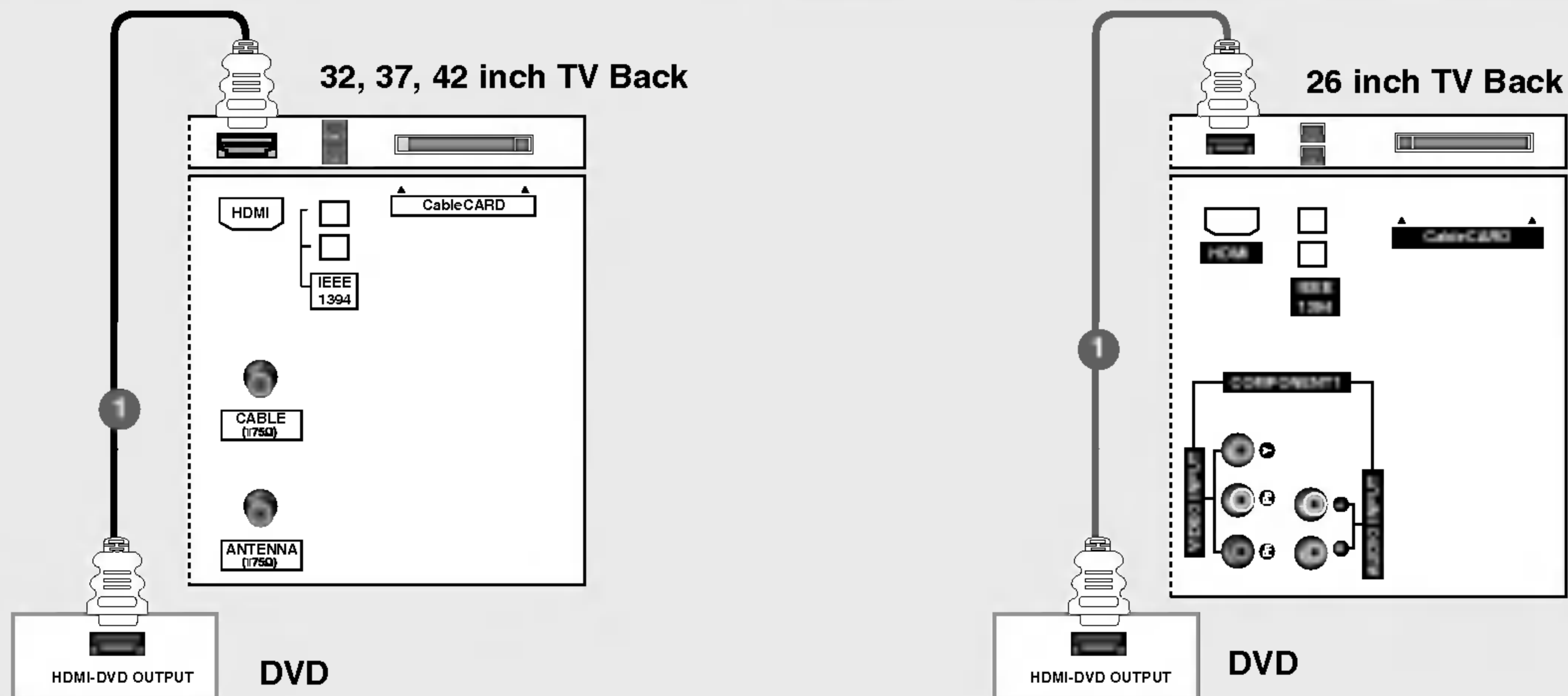

- 1 Connect the HDMI output of the DVD to the **HDMI** jack on the set.
- 2 Select **HDMI** input source with using the **TV/VIDEO** button on the remote control.
- 3 Refer to the DVD player's manual for operating instructions.

TV can receive the video and audio signal simultaneously with using a HDMI cable.

- If the DVD supports Auto HDMI function, the DVD output resolution will be automatically set to 1280x720p.
- If the DVD does not support Auto HDMI, you need to set the output resolution appropriately. To get the best picture quality, adjust the output resolution of the DVD to 1280x720p.

When connecting with a component cable

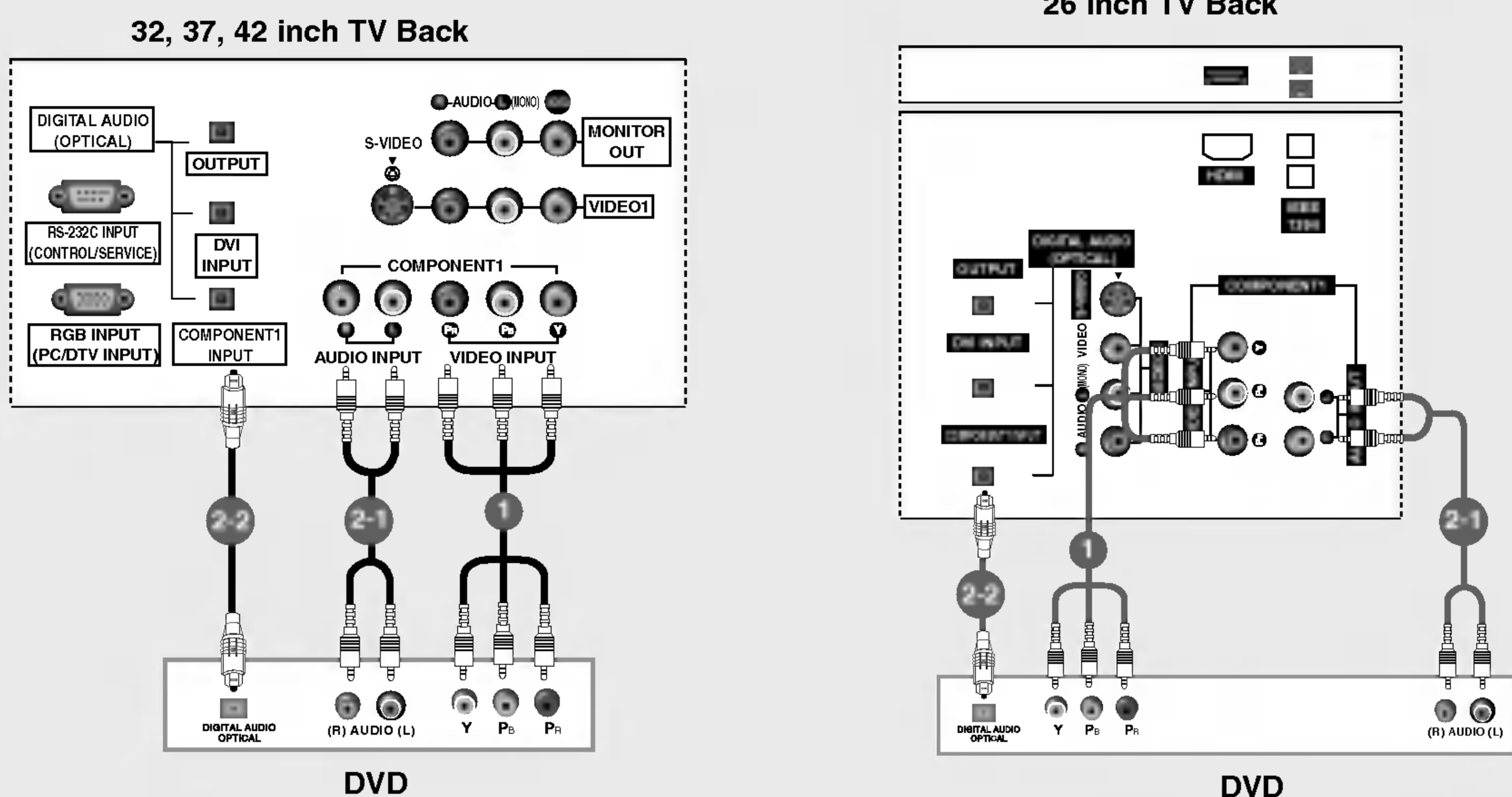

Select 2-1 or 2-2, depending on your DVD connector.

- 1 Connect the video outputs (Y, Pb, Pr) of the DVD to the **COMPONENT1 VIDEO INPUT** jacks on the set.
- 2-1 Connect the audio outputs of the DVD to the **COMPONENT1 AUDIO INPUT** jacks on the set.
- 2-2 Connect the optical audio output of the DVD to the **DIGITAL AUDIO COMPONENT1 INPUT** jack on the set.
- 3 Turn on the DVD player, insert a DVD.
- 4 Select **Component 1** input source with using the **TV/VIDEO** button on the remote control.
- If connected to **COMPONENT2** input, select **Component 2** input source.
- 5 Refer to the DVD player's manual for operating instructions.



Component Input ports

To get better picture quality, connect a DVD player to the component input ports as shown below.

Component ports on the TV	Y	Pb	Pr
Video output ports on DVD player	Y	Pb	Pr
	Y	B-Y	R-Y
	Y	Cb	Cr
	Y	PB	PR

- Digital Audio will not work for Component 2 input source.
- Digital Audio operation has priority if Digital Audio and AUDIO L/R are connected at the same time.

HDSTB Setup

- This TV can receive Digital Over-the-air/Cable signals without an external digital set-top box. However, if you do receive Digital signals from a digital set-top box or other digital external device, refer to the figure as shown below.

When connecting with a D-sub 15 pin cable

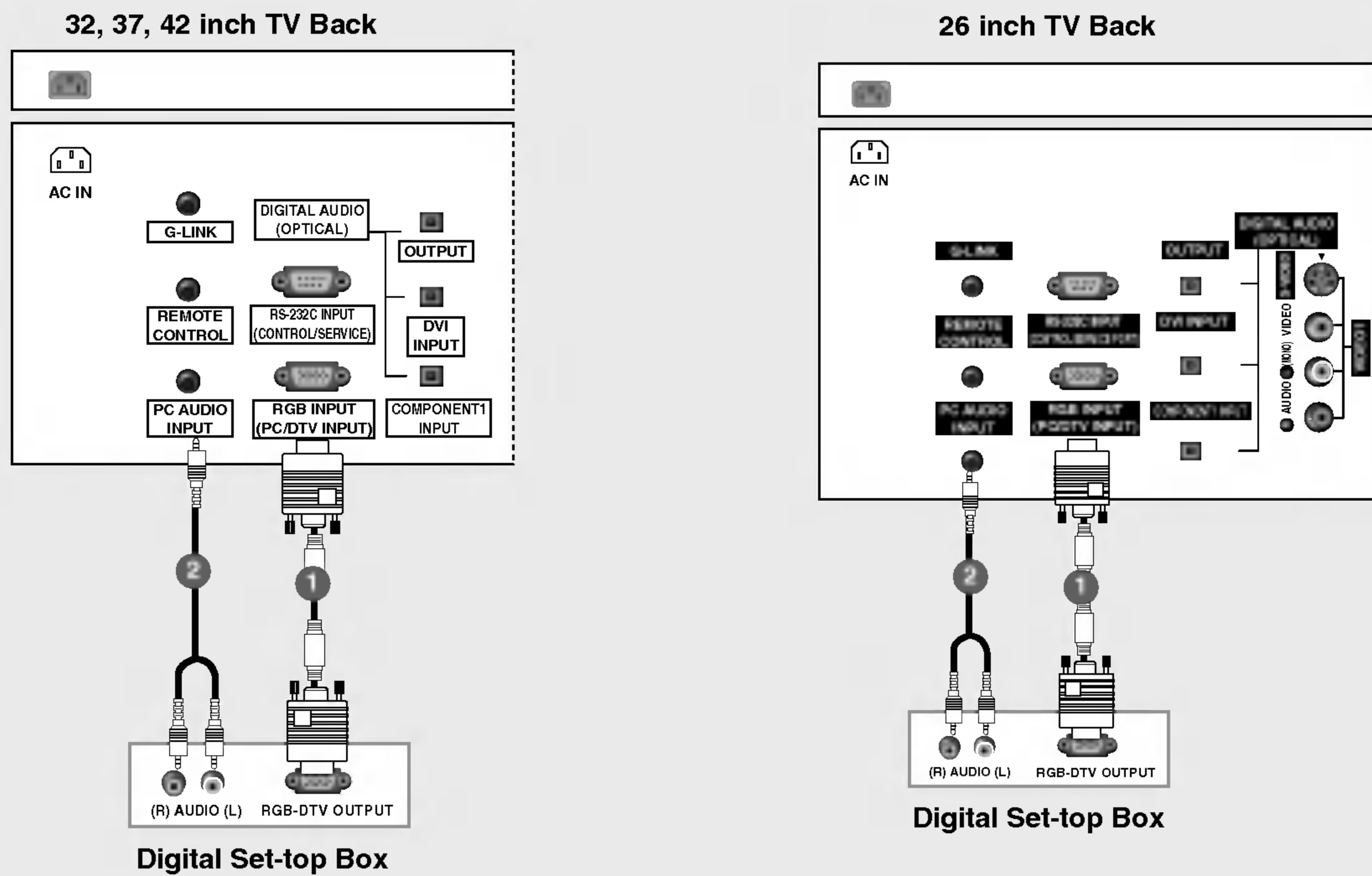

- 1 Connect the RGB output of the digital set-top box to the **RGB INPUT (PC/DTV INPUT)** jack on the set.
- 2 Connect the audio outputs of the set-top box to the **PC AUDIO INPUT** jack on the set.
- 3 Turn on the digital set-top box. (Refer to the owner's manual for the digital set-top box.)
- 4 Select **RGB-DTV** input source with using the **TV/VIDEO** button on the remote control.

When connecting with a Component cable

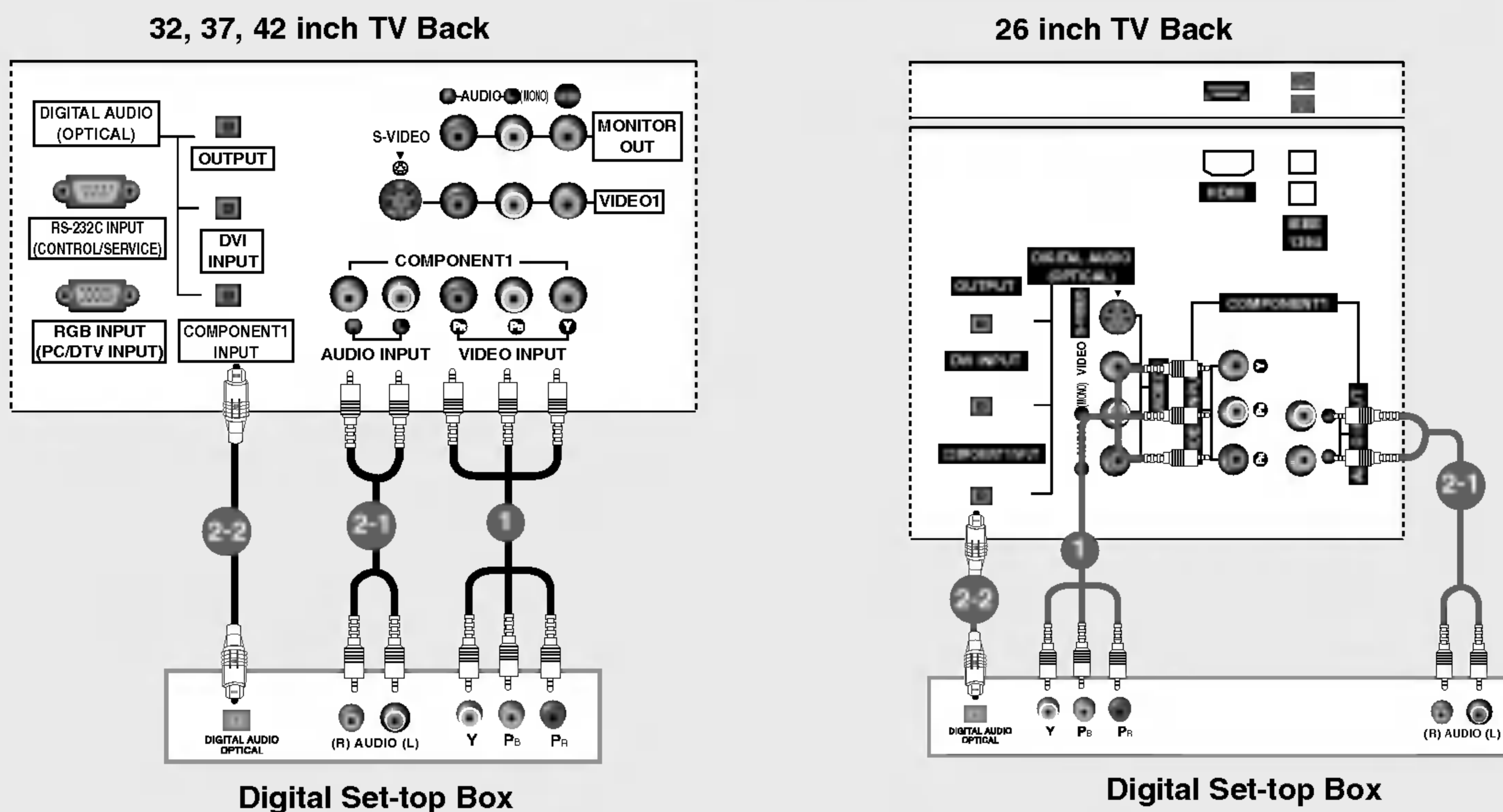

Select **2-1** or **2-2** , depending on your digital set-top box connector.

- 1 Connect the video outputs (Y, PB, PR) of the digital set-top box to the **COMPONENT1 VIDEO INPUT** jacks on the set.
- 2-1 Connect the audio output of the digital set-top box to the **COMPONENT1 AUDIO INPUT** jacks on the set.
- 2-2 Connect the optical audio output of the digital set-top box to the **DIGITAL AUDIO COMPONENT1 INPUT** jack on the set.
- 3 Turn on the digital set-top box. (Refer to the owner's manual for the digital set-top box.)
- 4 Select **Component 1** input source with using the **TV/VIDEO** button on the remote control.
- If connected to COMPONENT2 input, select **Component 2** input source.



Signal	Component1/2	RGB-DTV, HDMI/DVI
480i	Yes	No
480p/720p/1080i	Yes	Yes

When connecting with a HDMI cable

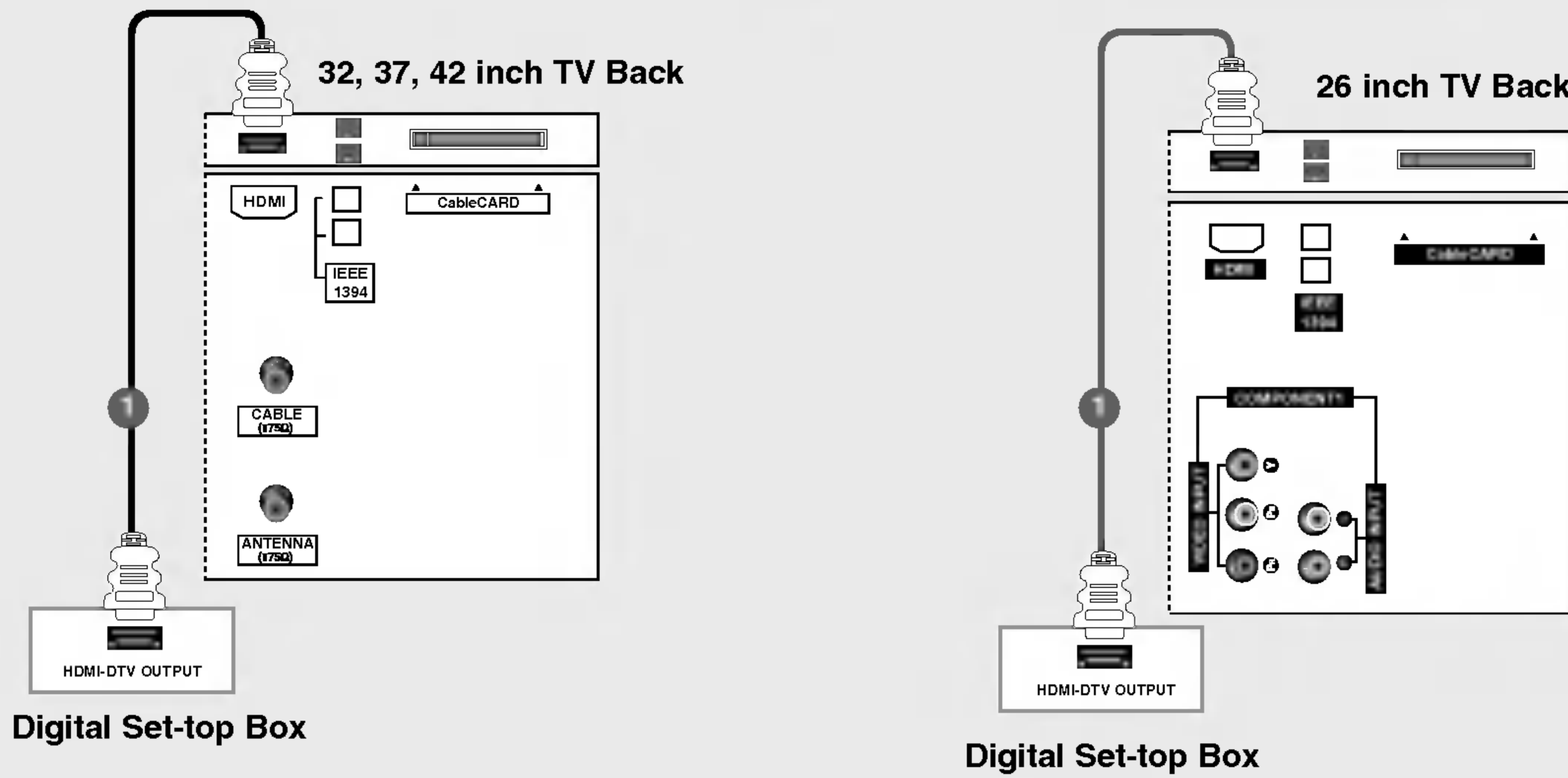

- 1 Connect the HDMI output of the digital set-top box to the **HDMI** jack on the set.
- 2 Select **HDMI/DVI** input source with using the **TV/VIDEO** button on the remote control.
- 3 Turn on the digital set-top box. (Refer to the owner's manual for the digital set-top box.)



- TV can receive the video and audio signal simultaneously with using a HDMI cable.
- If the digital set-top box supports Auto HDMI function, output resolution of the digital set-top box will be automatically set to 1280x720p.
- If the digital set-top box does not support Auto HDMI, you need to set the output resolution appropriately. To get the best picture quality, adjust the output resolution of the digital set-top box to 1280x720p.

When connecting with a HDMI to DVI cable

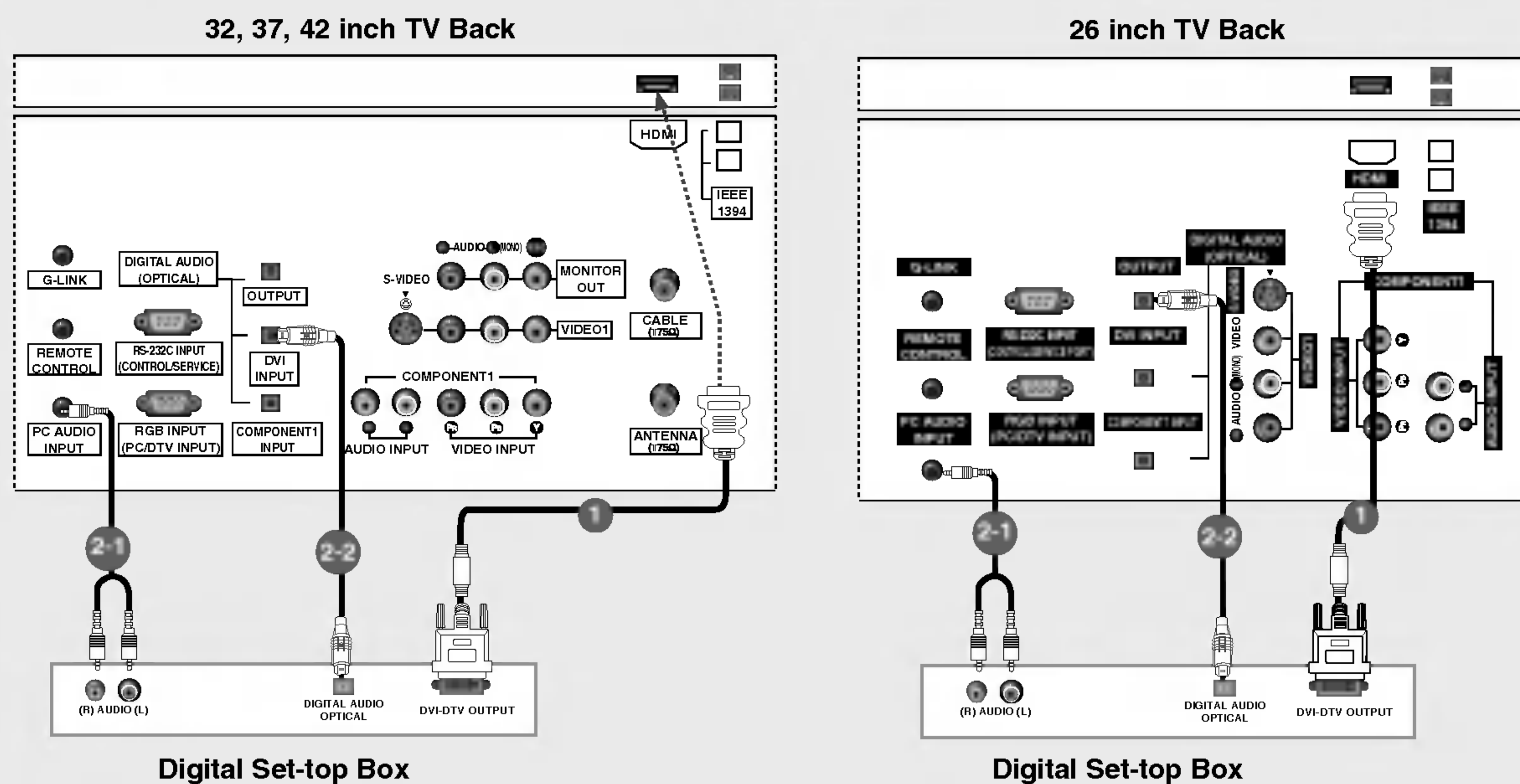

Select **2-1** or **2-2**, depending on your digital set-top box connector.

- 1 Connect the DVI output of the digital set-top box to the **HDMI** jack on the set.
- 2-1 Connect the audio output of the digital set-top box to the **PC AUDIO INPUT** jack on the set.
- 2-2 Connect the optical audio output of the digital set-top box to the **DIGITAL AUDIO DVI INPUT** jack on the set.
- 4 Turn on the digital set-top box. (Refer to the owner's manual for the digital set-top box.)
- 5 Select **HDMI/DVI** input source with using the **TV/VIDEO** button on the remote control.



- If the digital set-top box has a DVI output and no HDMI output, a separated audio connection is necessary.
- If the digital set-top box supports Auto DVI function, the output resolution of the digital set-top box will be automatically set to 1280x720p.
- If the digital set-top box does not support Auto DVI, you need to set the output resolution appropriately. To get the best picture quality, adjust the output resolution of the digital set-top box to 1280x720p.

External AV Source Setup

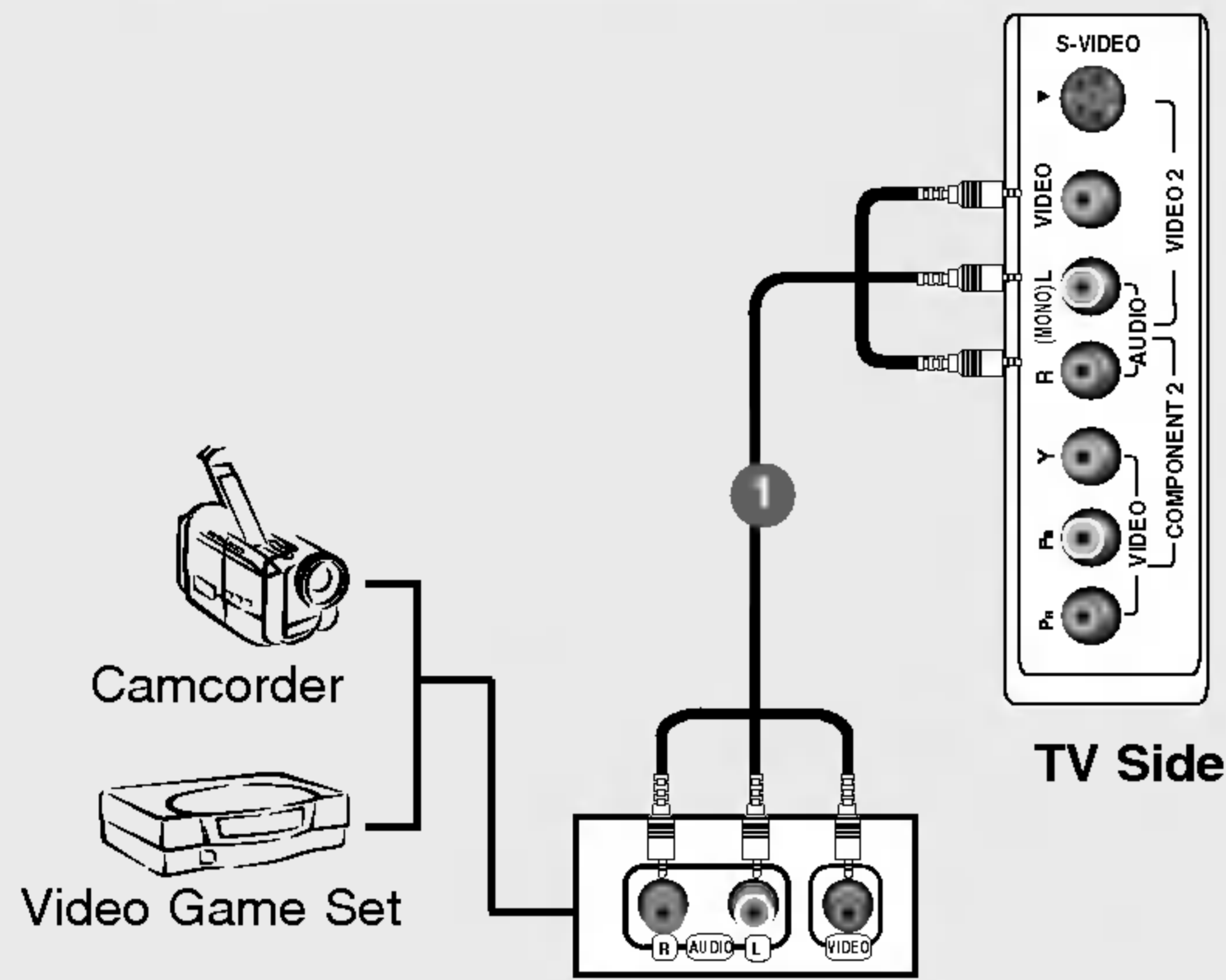

- 1 Connect the **AUDIO/VIDEO** jacks between TV and external equipment. Match the jack colors (Video = yellow, Audio Left = white, and Audio Right = red).
- 2 Select **Video2** input source with using the **TV/VIDEO** button on the remote control.
- If connected to **VIDEO1** input, select **Video1** input source.
- 3 Operate the corresponding external equipment. Refer to external equipment operating guide. For connection instructions to operate the TV Guide On Screen system, see page 42~43.

Digital Audio Output

- Send the TV's audio to external audio equipment (stereo system) via the Digital Audio Output Optical port.

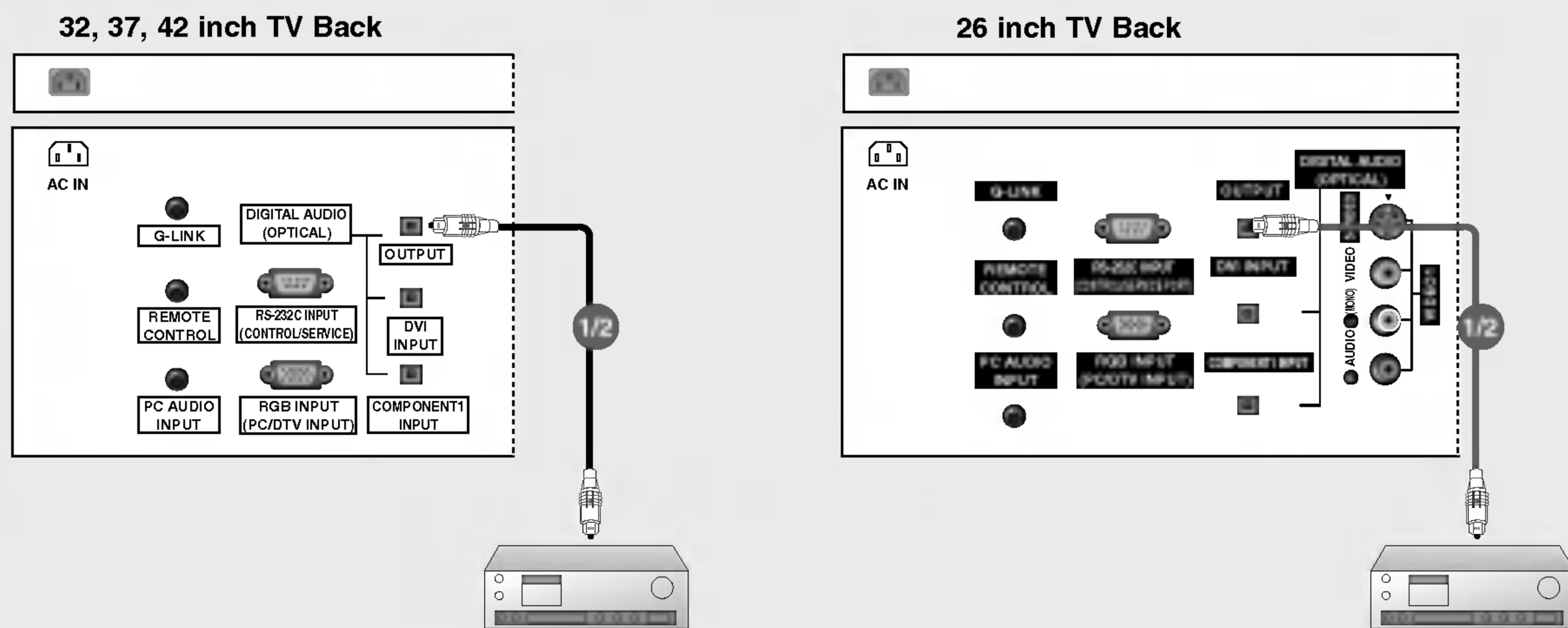

- 1 Connect one end of an optical cable to the TV Digital Audio Optical Output port.
- 2 Connect the other end of the optical cable to the digital audio optical input on the audio equipment.
- 3 See the external audio equipment instruction manual for operation. When connecting with external audio equipments, such as amplifiers or speakers, please turn the TV speakers off. (Refer to p.80)



CAUTION

Do not look into the optical output port. Looking at the laser beam may damage your vision.

Monitor Out Setup (32LX1D/2D, 32/37/42LP1D only)

- The TV has a special signal output capability which allows you to hook up a second TV or monitor.

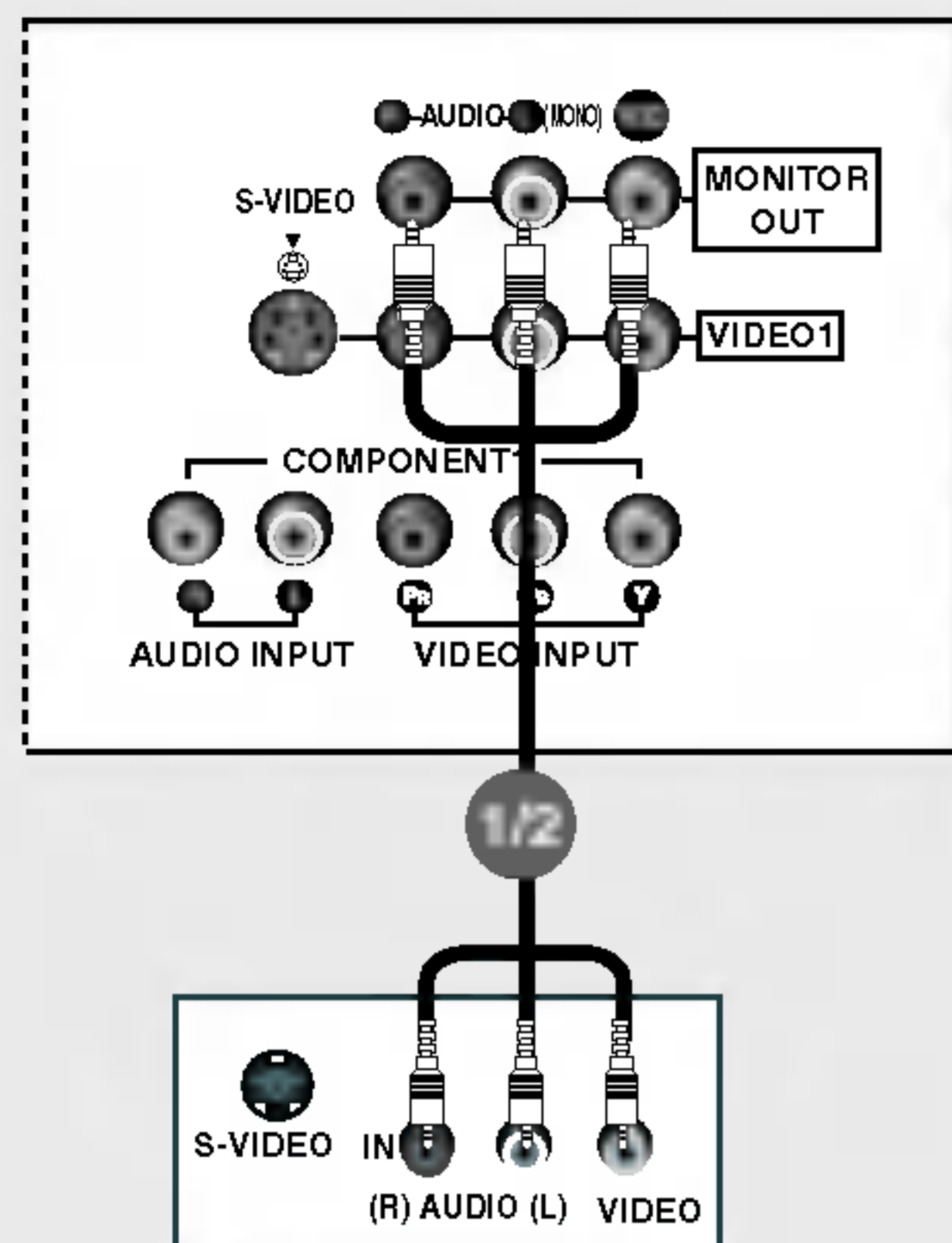

- 1 Connect the second TV or monitor to the TV's **MONITOR OUTPUT** jacks.
- 2 See the Operating Manual of the second TV or monitor for further details regarding that device's input settings.



- Component 1-2, RGB-PC/RGB-DTV, HDMI/DVI input sources can be used for Monitor out.
- When connecting with external audio equipments, such as amplifiers or speakers, please turn the TV speakers off. (Refer to p.80)

CableCARD™ Setup

32, 37, 42 inch TV Back

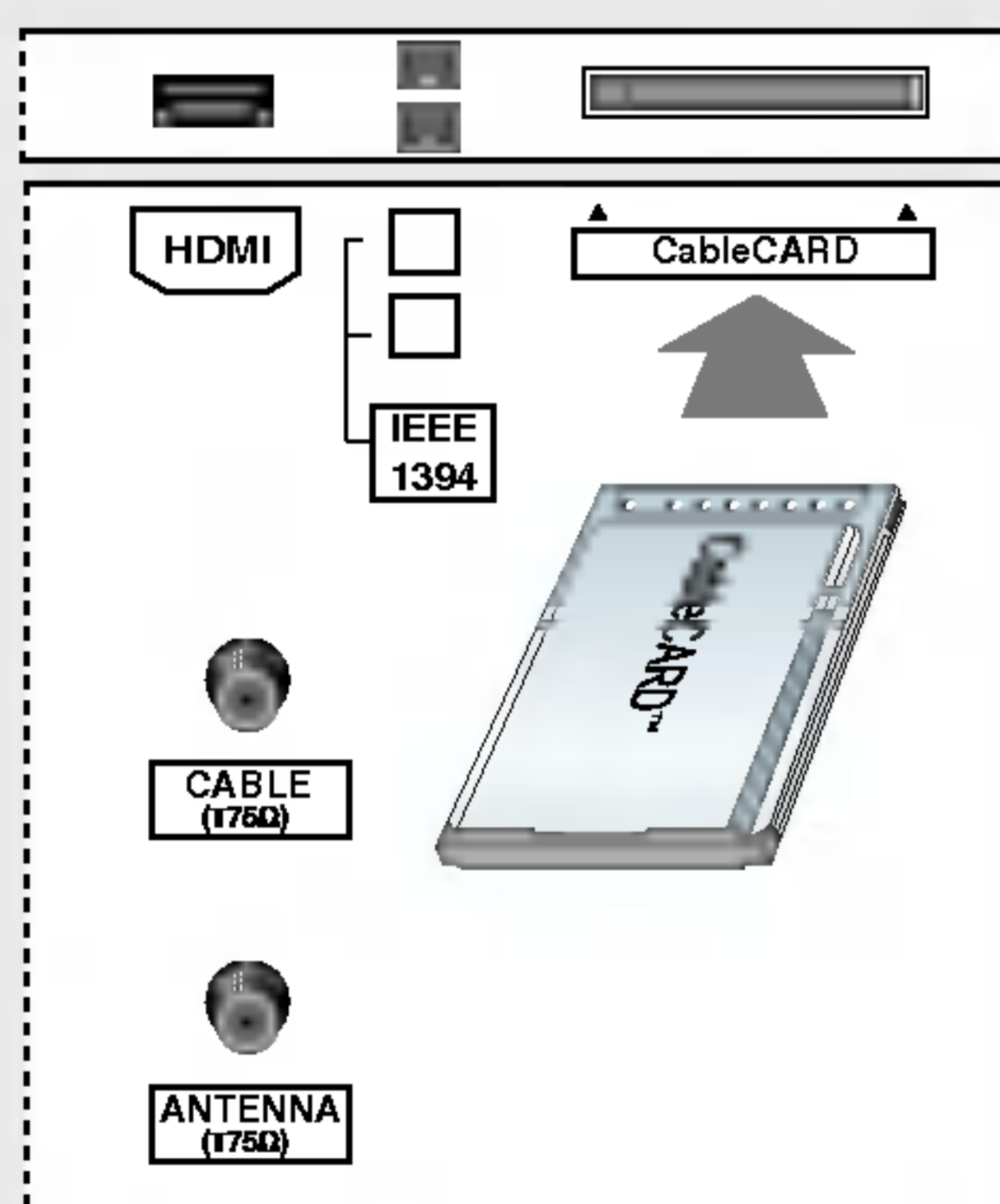

26 inch TV Back

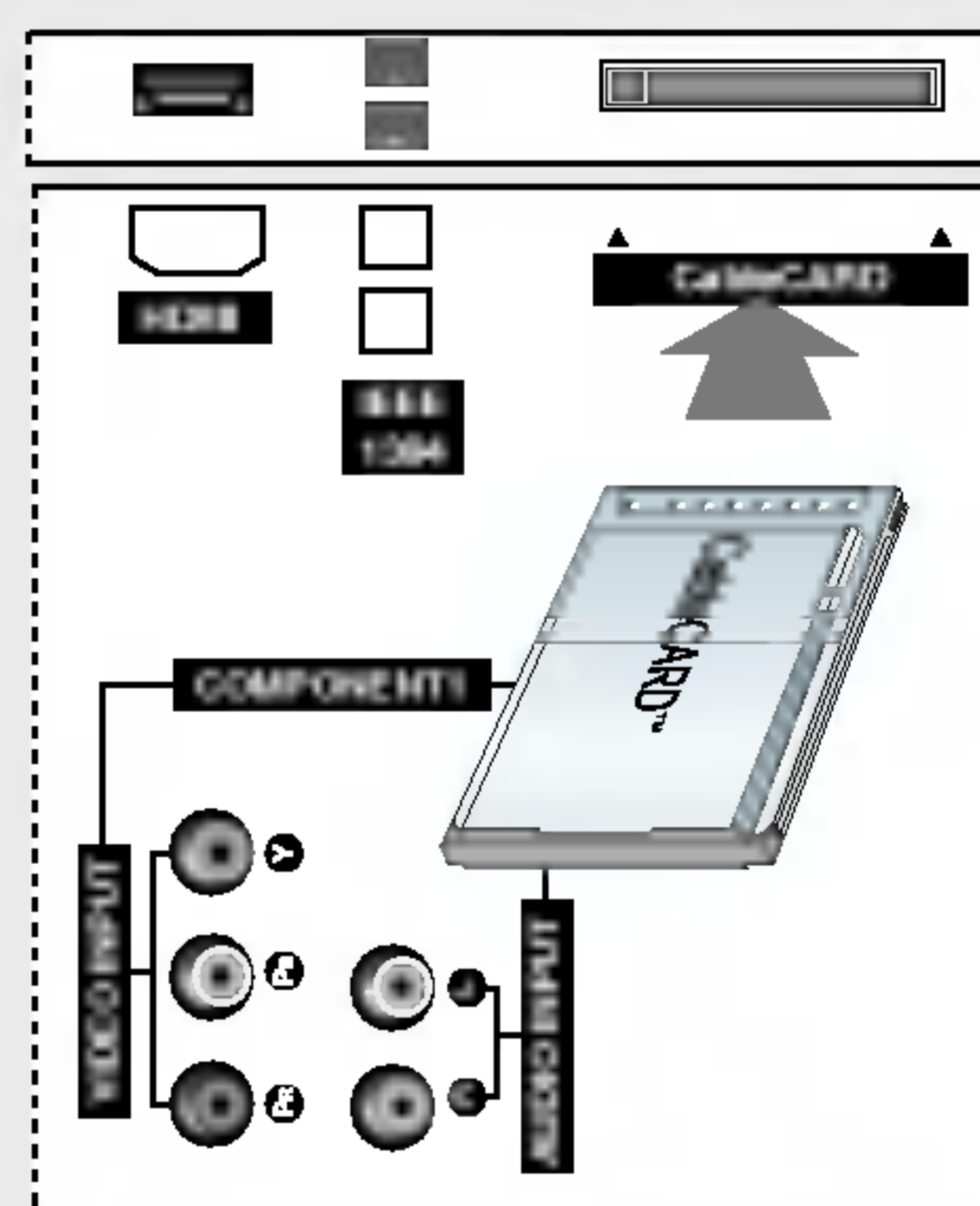

- To view the premium stations

Insert the CableCARD™ received from Cable Service provider to **CableCARD** slot of TV as shown. If the pairing information about this TV and the CableCARD is automatically displayed on the screen, contact with Cable service provider by phone.



Caution:

When removing the CableCARD™, do not drop it as this may cause damage to the card.



- Different card types can be used with this unit (Motorola, Scientific Atlanta, SCM, etc.).

PC Setup

- This TV provides Plug and Play capability, meaning that the PC adjusts automatically to the TV's settings.

When connecting with a D-sub 15 pin cable

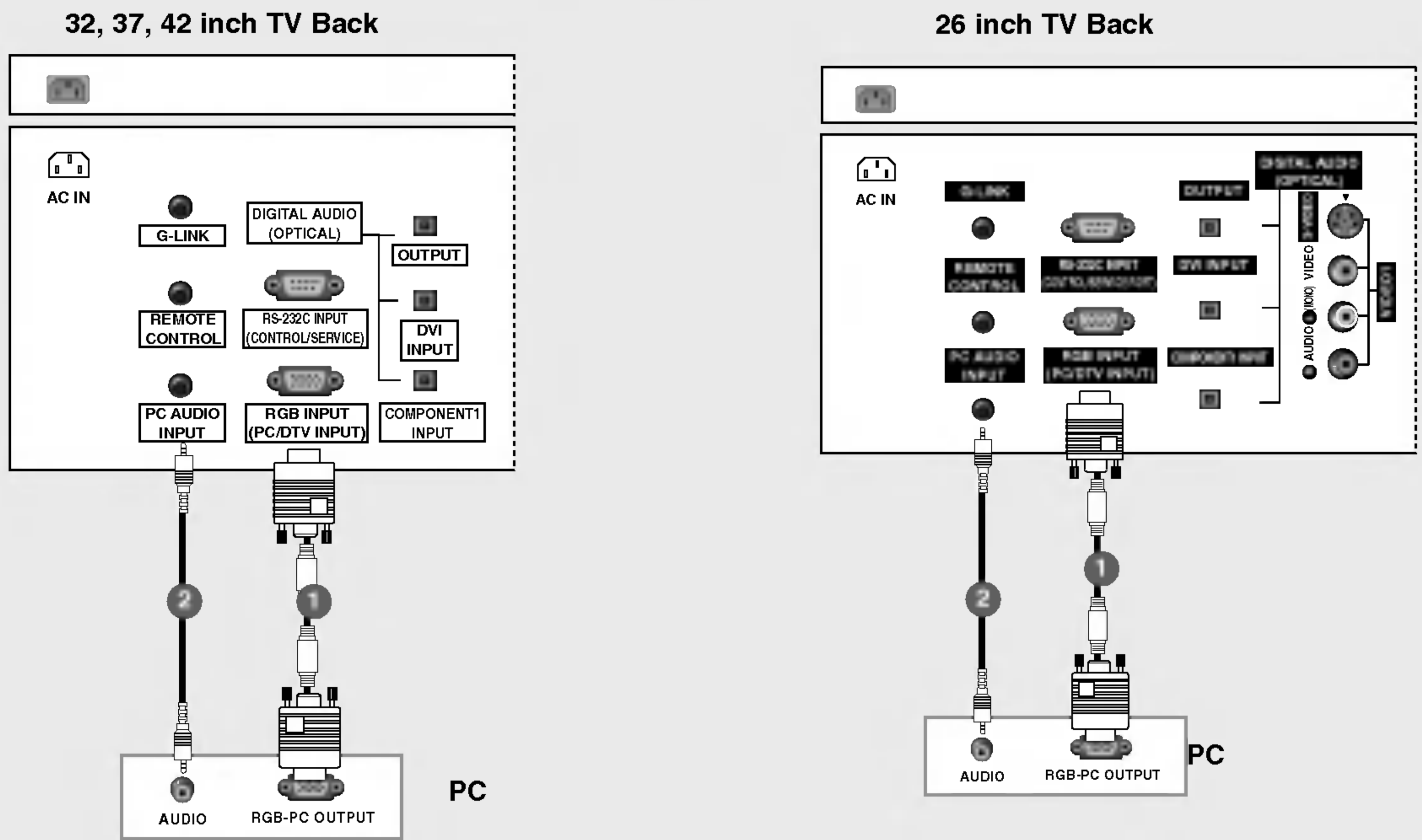

- 1 Connect the RGB output of the PC to the **RGB INPUT (PC/DTV INPUT)** jack on the set.
- 2 Connect the PC audio output to the **PC AUDIO INPUT** jack on the set.
- 3 Turn on the PC and the set.
- 4 Select **RGB-PC** input source with using the **TV/VIDEO** button on the remote control.

When connecting with a HDMI to DVI cable

32, 37, 42 inch TV Back

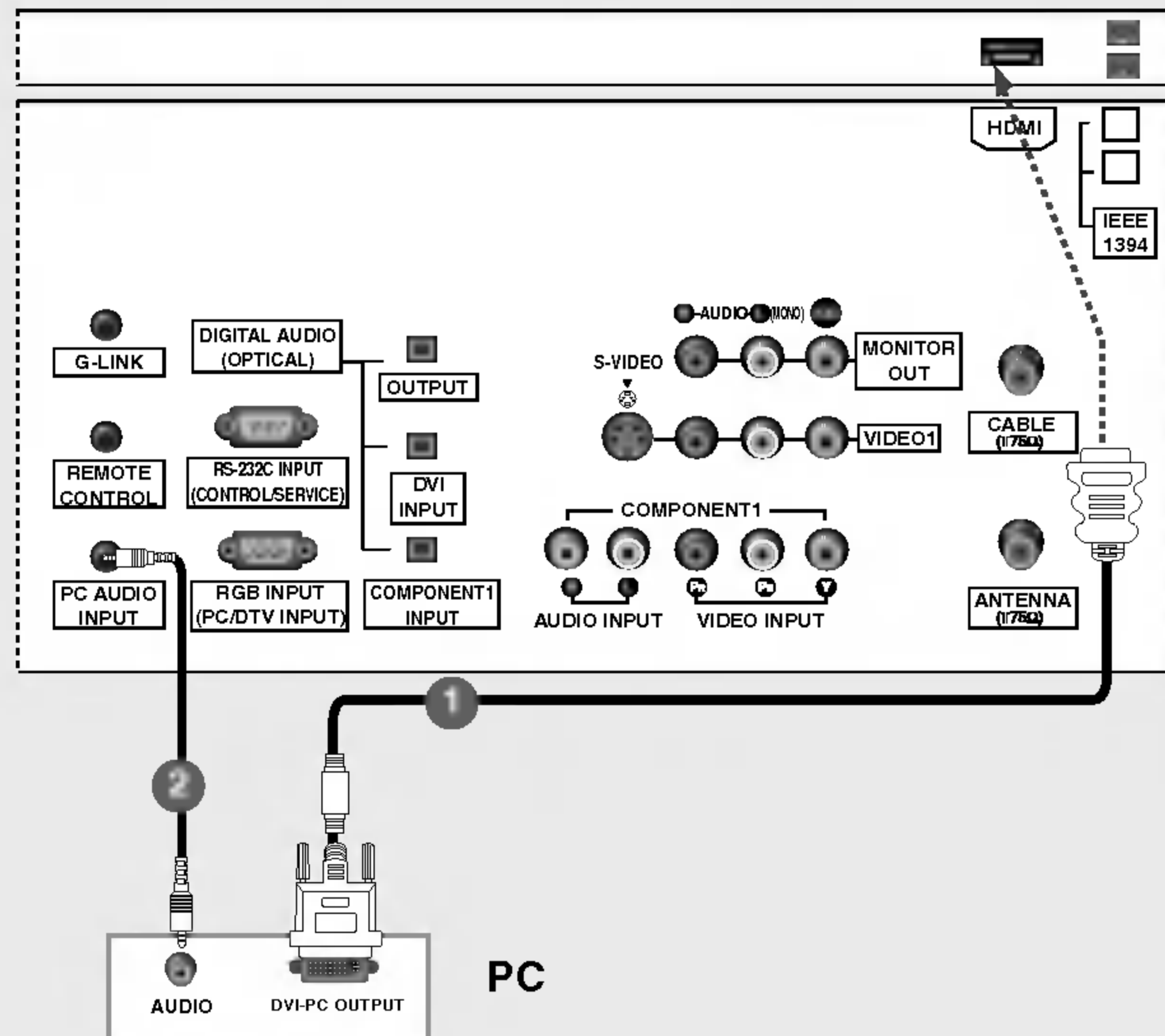

26 inch TV Back

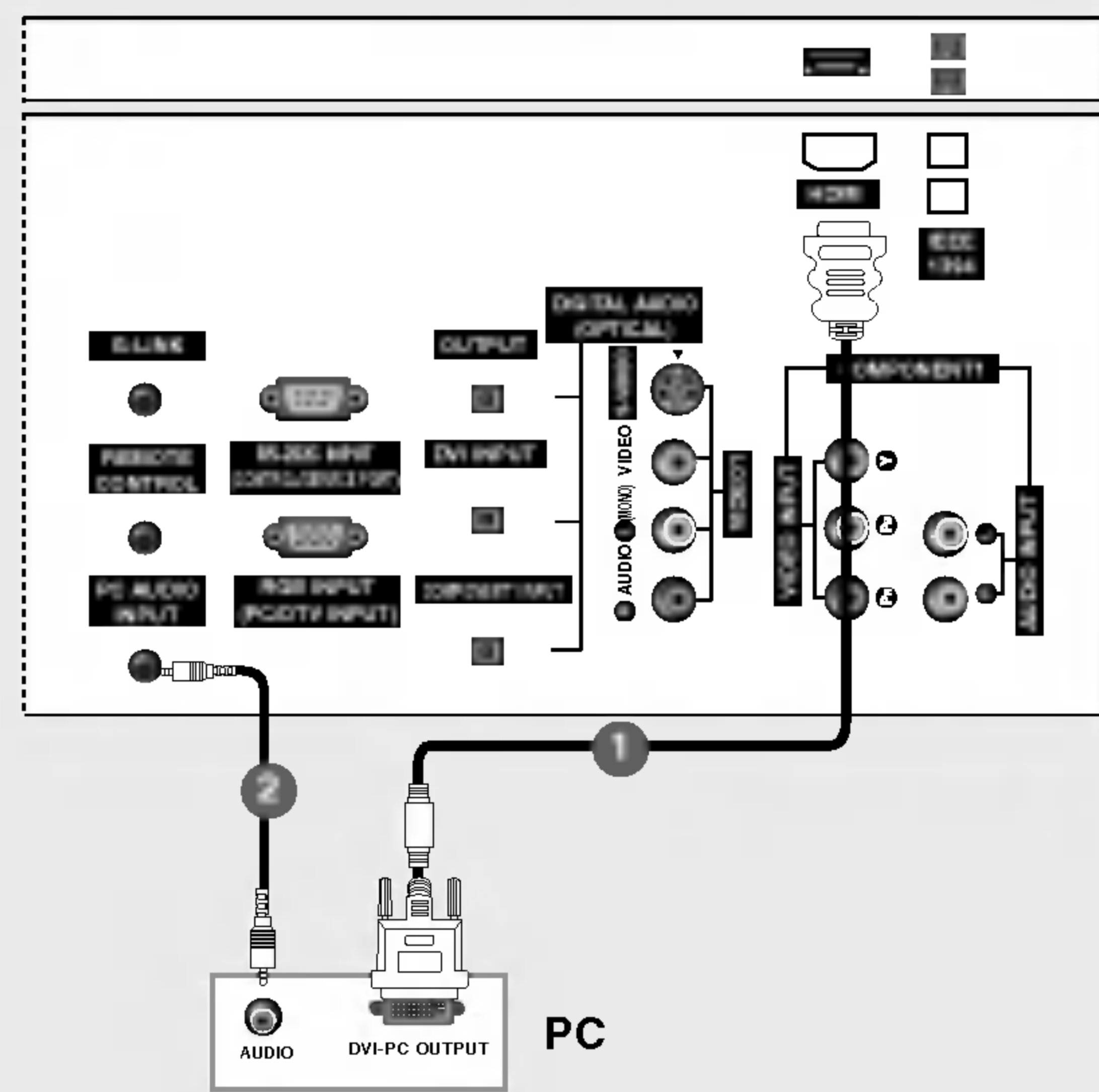

- 1 Connect the DVI output of the PC to the **HDMI** jack on the set.
- 2 Connect the PC audio output to the **PC AUDIO INPUT** jack on the set.
- 3 Turn on the PC and the set.
- 4 Select **HDMI/DVI** input source with using the **TV/VIDEO** button on the remote control.



- If the PC has a DVI output and no HDMI output, a separated audio connection is necessary.
- If the PC does not support Auto DVI, you need to set the output resolution appropriately. To get the best picture quality, adjust the output resolution of PC graphics card's output resolution to 1024x768, 60Hz.



1. To get the best picture quality, adjust the PC graphics card to 1024x768, 60Hz.
2. Depending on the graphics card, DOS mode may not work if a HDMI to DVI Cable is in use.
3. When Source Devices connected with HDMI1/DVI Input, output PC Resolution (VGA, SVGA, XGA), Position and Size may not fit to Screen. Press the ADJUST button to adjust the screen Position of TV SET and contact an PC graphics card service center.
4. When Source Devices connected with HDMI/DVI Input, output TV SET Resolution (480p, 720p, 1080i) and TV SET Display fit EIA/CEA-861-B Specification to Screen. If not, refer to the Manual of HDMI/DVI Source Devices or contact your service center.
5. In case HDMI/DVI Source Devices is not connected Cable or poor cable connection, "NO SIGNAL" OSD display in HDMI1/DVI Input. In case that Video Resolution is not supported TV SET output in HDMI/DVI Source Devices, "INVALID FORMAT" OSD display. Refer to the Manual of HDMI1/DVI Source Devices or contact your service center.
6. Check the image on your TV. There may be noise associated with the resolution, vertical pattern, contrast or brightness in PC, HDMI/DVI mode. If noise is present, change the PC or HDMI/DVI mode to another resolution, change the refresh rate to another rate or adjust the brightness and contrast on the menu until the picture is clear. If the refresh rate of the PC graphic card can not be changed, change the PC graphic card or consult the manufacturer of the PC graphic card.
7. Avoid keeping a fixed image on the TV's screen for a long period of time. The fixed image may become permanently imprinted on the screen.
8. The synchronization input form for Horizontal and Vertical frequencies is separate.

**Supported Display Resolution
(RGB-PC, HDMI/DVI Mode)**

Resolution	Horizontal Frequency (kHz)	Vertical Frequency (Hz)
640x350	31.468	70.09
720x400	31.469	70.08
640x480	31.469	59.94
	37.861	72.80
	37.500	75.00
800x600	35.156	56.25
	37.879	60.31
	48.077	72.18
	46.875	75.00
1024x768	48.363	60.00
	56.476	70.06
	60.023	75.02

**Supported Display Resolution
(RGB-DTV, HDMI/DVI Mode)**

Resolution	Horizontal Frequency (kHz)	Vertical Frequency (Hz)
1280x720p	45	60
1920x1080i	33.75	60
720x480p	31.5	60

Screen Setup for PC mode

- When RGB connect to PC input and select the RGB-PC in Main Input, this function is used.
- When HDMI/DVI connect to PC input and select HDMI/DVI input, this function is used.
- In RGB-DTV mode, SIZE and PHASE is not available.
- In HDMI/DVI-PC mode, PHASE is not available.
- After connecting RGB-PC or HDMI/DVI to PC input and checking the screen quality.

* Adjustment for screen Position, Size, and Phase

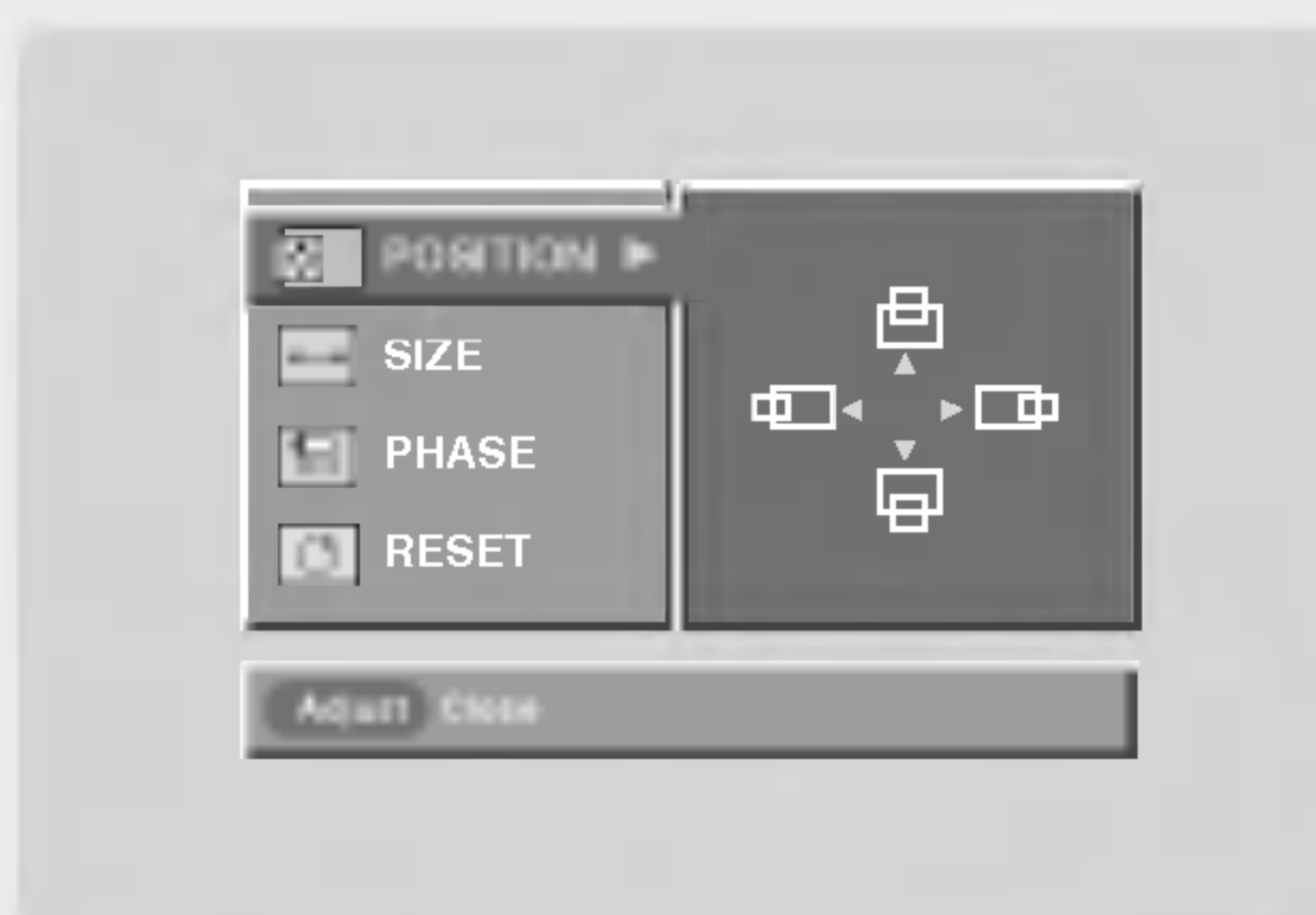

Mini Glossary

- Position** This function is to adjust picture to left/right and up/down as you prefer.
- Size** This function is to minimize any vertical bars or stripes visible on the screen background. And the horizontal screen size will also change.
- Phase** This function allows you to remove any horizontal noise and clear or sharpen the image of characters.

- 1 Press the **ADJUST** button and then use **▲ / ▼** button to select **POSITION**, **SIZE**, or **PHASE**.
- 2 Press **ENTER** button and then use **▲ / ▼ / ◀ / ▶** buttons to make appropriate adjustments.
 - The **PHASE** adjustment range is -16 ~ +16.
 - The **SIZE** adjustment range is -50 ~ +50.
- 3 Press **ENTER** button.

* Initializing (Reset to original factory values)



- To initialize the adjusted values
- 1 Press the **ADJUST** button and then use **▲ / ▼** button to select the **RESET** option.
 - 2 Press **ENTER** button and then use **◀ / ▶** button to select **Yes**.
 - 3 Press **ENTER** button.

IEEE 1394

- It's available to communicate to either direction and you can give and take a image, sound, or each control command with one cable.

How to connect the 1394

- To operate the IEEE1394, these methods are available as shown below.

(a) TV ↔ DVHS

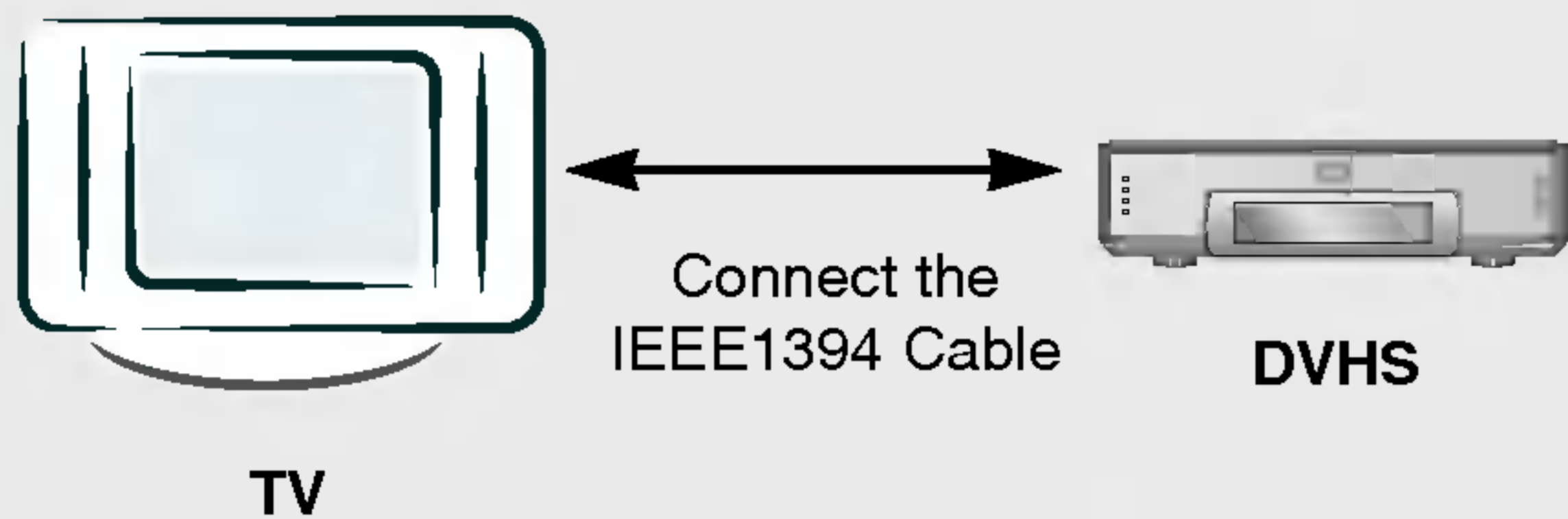

- 1 When connecting the DVHS or the MicroMV Camcorder, as shown in the (a) or (b) figure, press the **1394** button to show the control panel.

(b) TV ↔ MicroMV Camcorder

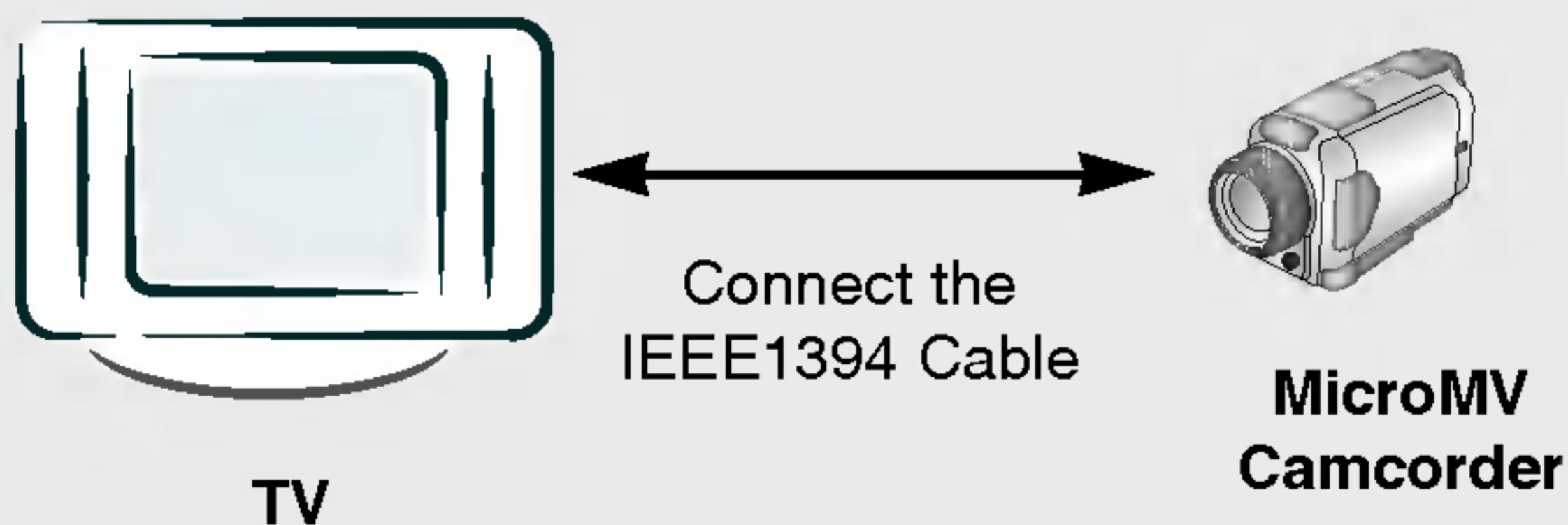

Note:
When connecting the DVHS and the MicroMV Camcorder, in case of showing 'input error' on the MicroMV Camcorder window, it's okay.

(c) TV ↔ DVHS + MicroMV Camcorder

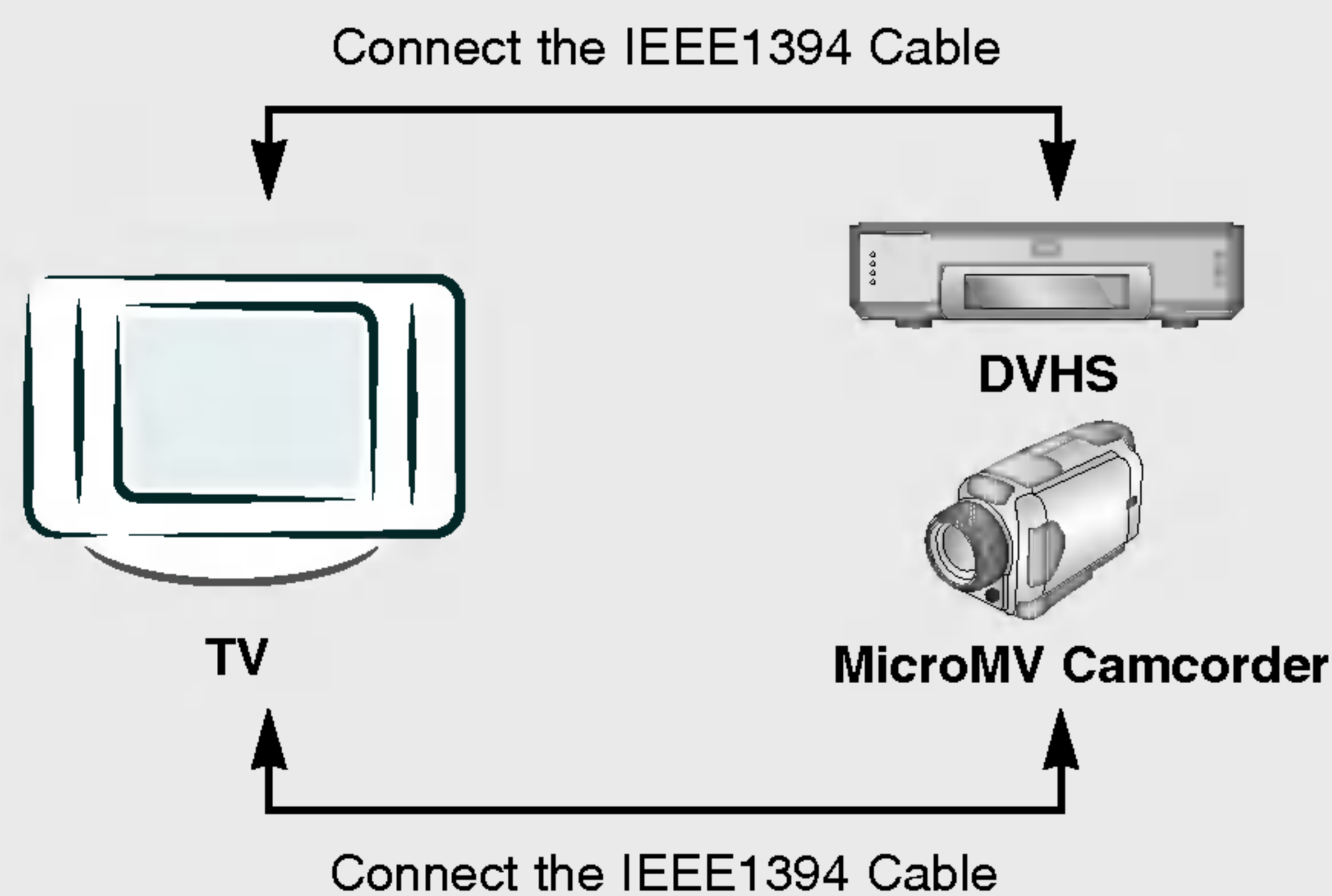

- 2 When connecting the DVHS and the MicroMV Camcorder, as shown in the (c) or (d) figure, press the **1394** button to show the control panel and then select the DVHS or the MicroMV Camcorder.

- When connecting the 1394 and then playing, you must use the original DVHS tape. If not, it may occur errors.
- If the operation normally doesn't work on Daisy Chain connection, please change an arrangement of connected device.

(d) Daisy Chain Connection

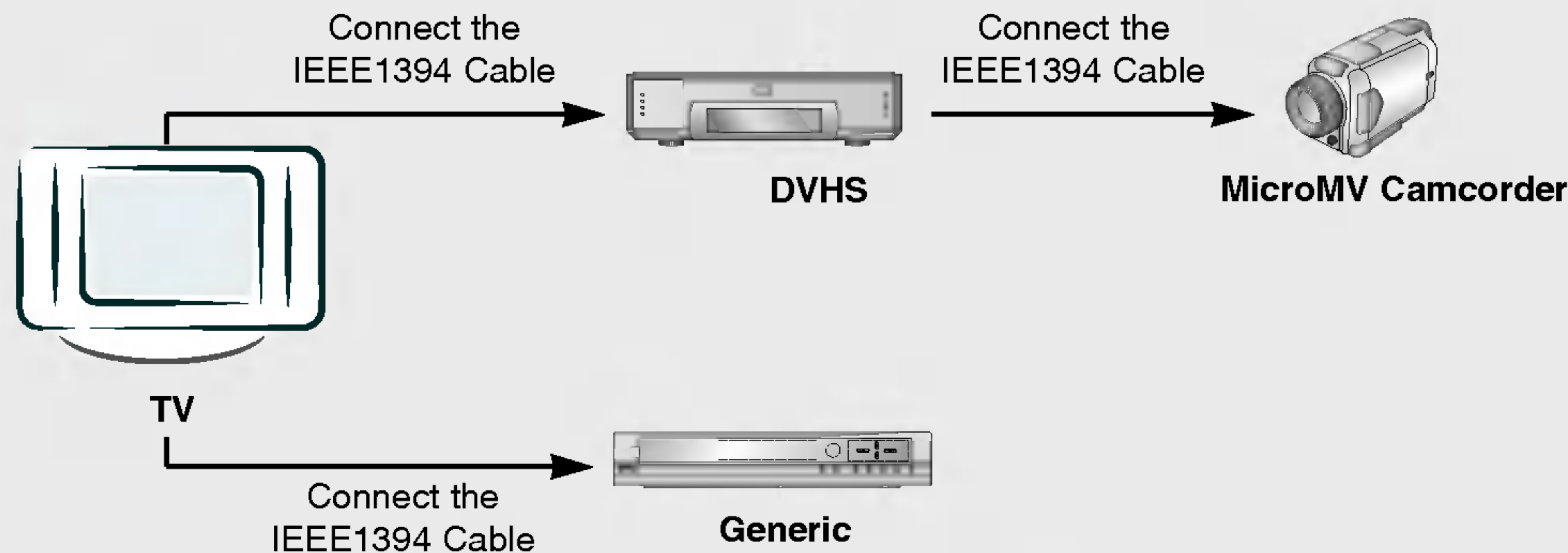

When connecting DVHS

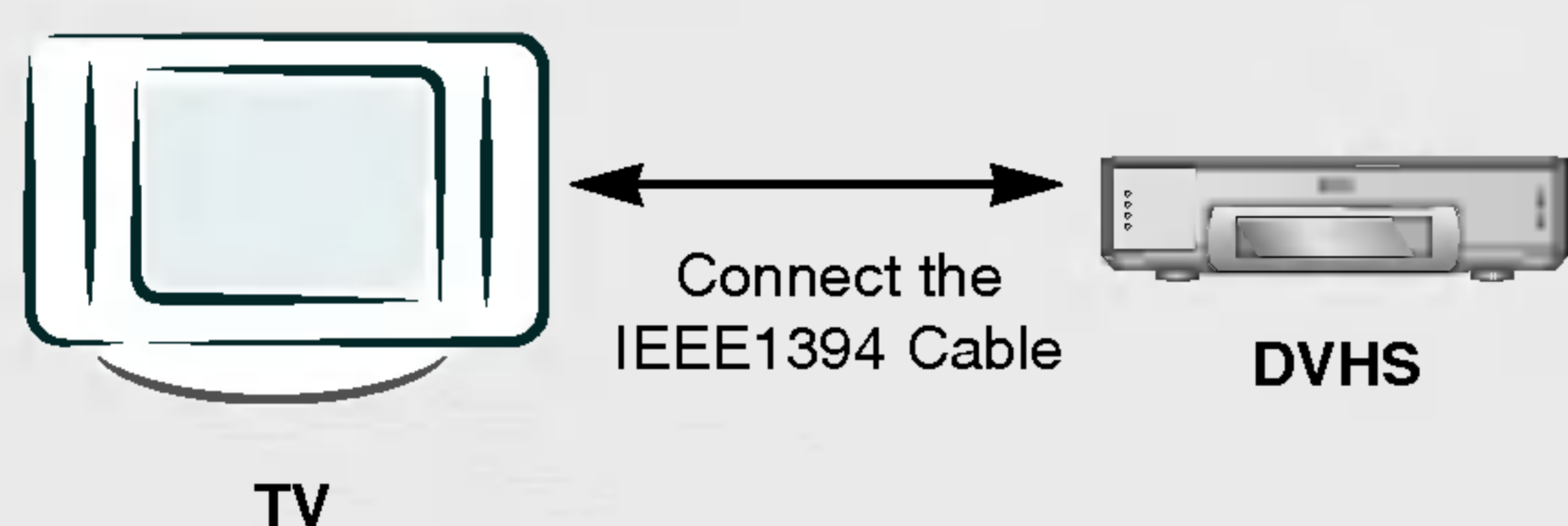

1 Connect the IEEE 1394 jack of the TV to the **IEEE 1394** jack of the DVHS with IEEE 1394 Cable.

2 When watching the TV, press the **1394** button. The control panel OSD of DVHS is displayed.

Supported DVHS List

- JVC (HM-DH40000K)
- JVC (HM-DH40000U)
- JVC (HM-DH5U)
- MITSUBISHI (HV-HD1000)
- PANASONIC (NV-DH2)

• The other DVHS device can work a basic operation.

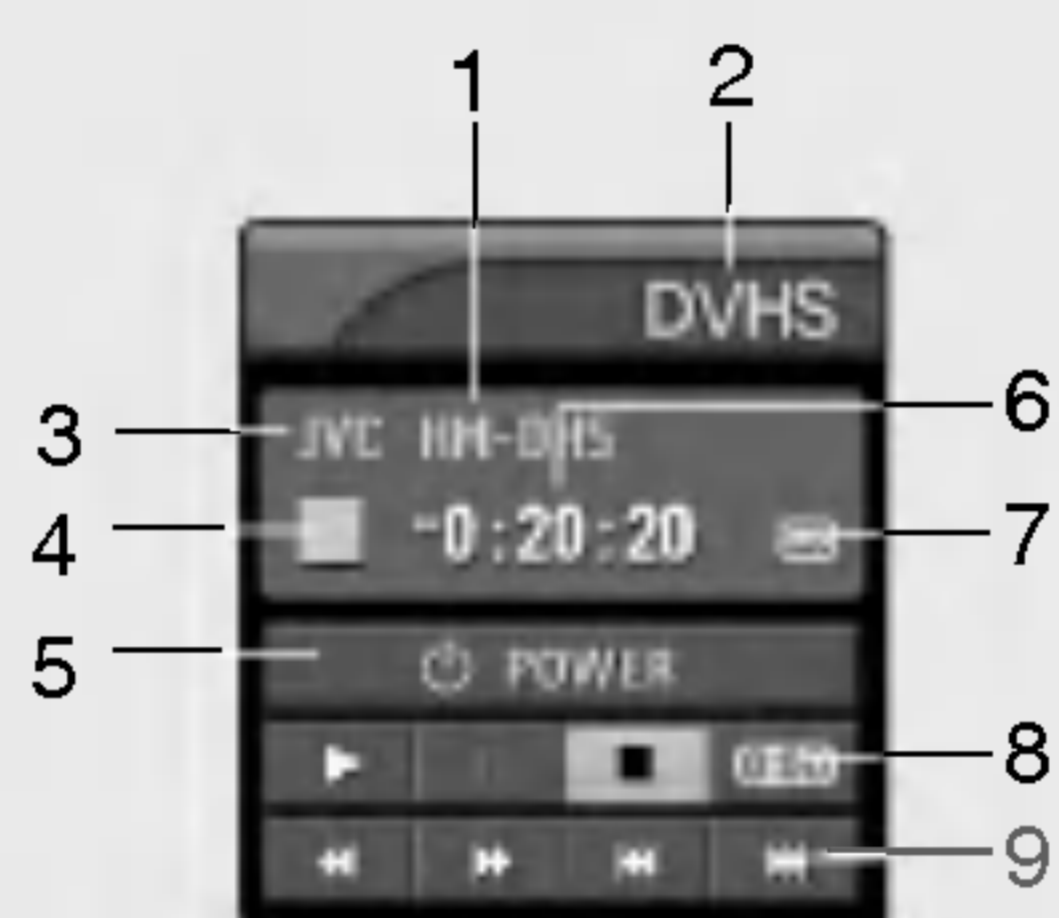

* Depending on the connected equipment, control panel may differ.

- 1. DVHS Model
 - 2. Connected Equipment to the 1394
 - 3. DVHS Company
 - 4. DVHS Operating Status
 - 5. Power On/Off
 - 6. DVHS Play Time
 - 7. Tape Status
 - Tape shape Icon - Tape in or not
 - Lock shape Icon - Writable or not
 - 8. Initializing Play Time
 - 9. DVHS Play, Pause, Stop, Search, Skip.
- * **Note:**
- Skip- This function is for a fast search. It searches the program's start point and then plays. On skipping, Search (◀▶), Pause (||) and Play (▶) are displayed on the Control Panel. In some models, it's not available to operate the Skipping (◀▶) function.



- In case the DVHS have a incorrect recognition to Generic, the power of DVHS is completely pull out and then connect again.
- When searching the screen (◀▶) , the DVHS may be strangely seen. And also the DVHS may late respond by devices.

When connecting MicroMV Camcorder

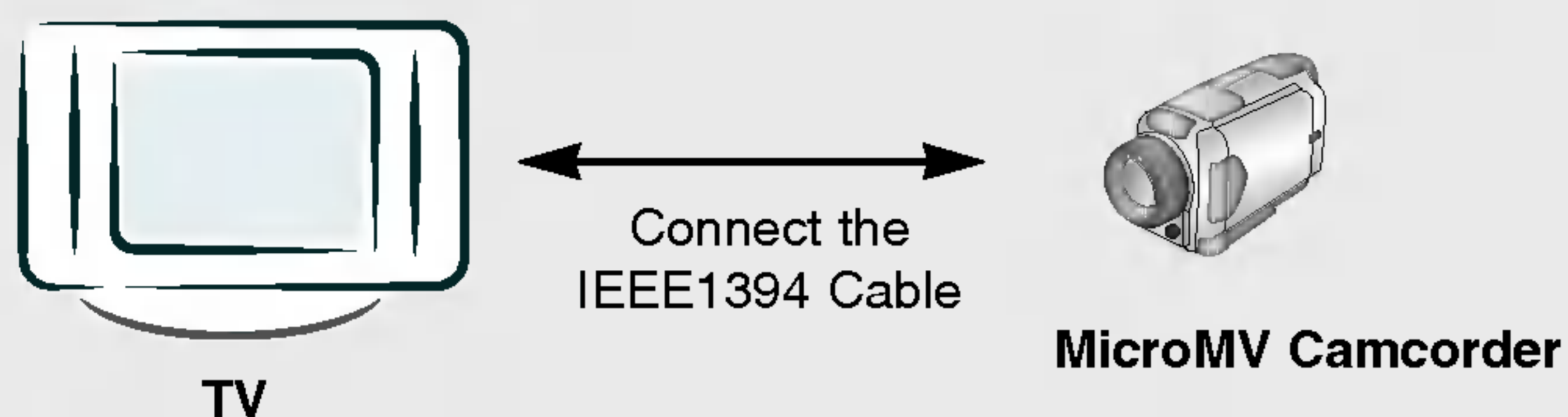

1 Connect the IEEE 1394 jack of the TV to the **IEEE 1394** jack of the MicroMV Camcorder with IEEE 1394 Cable.

2 When watching the TV, press the **1394** button. The control panel OSD of MicroMV Camcorder is displayed.

• In camera mode of MicroMV Camcorder, this control panel is showed.



Supported MicroMV Camcorder List

- SONY DCR IP-1
- SONY DCR IP-5
- SONY DCR IP-45
- SONY DCR IP-210

• The other DVHS device can work a basic operation.



- 1. MicroMV Camcorder Model
- 2. Connected Equipment to the 1394
- 3. MicroMV Camcorder Company
- 4. MicroMV Camcorder Operating Status
- 5. MicroMV Camcorder Play Time

- 6. Tape Status
 - Tape shape Icon - Tape in or not
 - Lock shape Icon - Writable or not
- 7. MicroMV Camcorder Play, Search, Pause or Stop
- 8. Initializing Play Time

* Depending on the connected equipment, control panel may differ.



- In memory mode of MicroMV Camcorder, it doesn't apply to connect the IEEE1394.
- Regardless of a mode of MicroMV Camcorder, if the tape is ejected, it doesn't apply to connect the IEEE1394.

When connecting DVHS and MicroMV Camcorder

- 1 Synchronously, connect the IEEE 1394 jack of the TV to the IEEE 1394 jack of the DVHS and the MicroMV Camcorder with IEEE 1394 Cable.



- 2 Press the ▲ / ▼ button to select device, then press **ENTER** button to play it. And then selected device will be showed OSD.



DTV Link

- DTV Link applies to 1394 connection of device labeled DTV Link logo.
- It is normal standard of CEA which restricts by a remote and displays OSD and plays to stream of a remote control by using a connection of IEEE1394.

◆ How to play the DTV Link

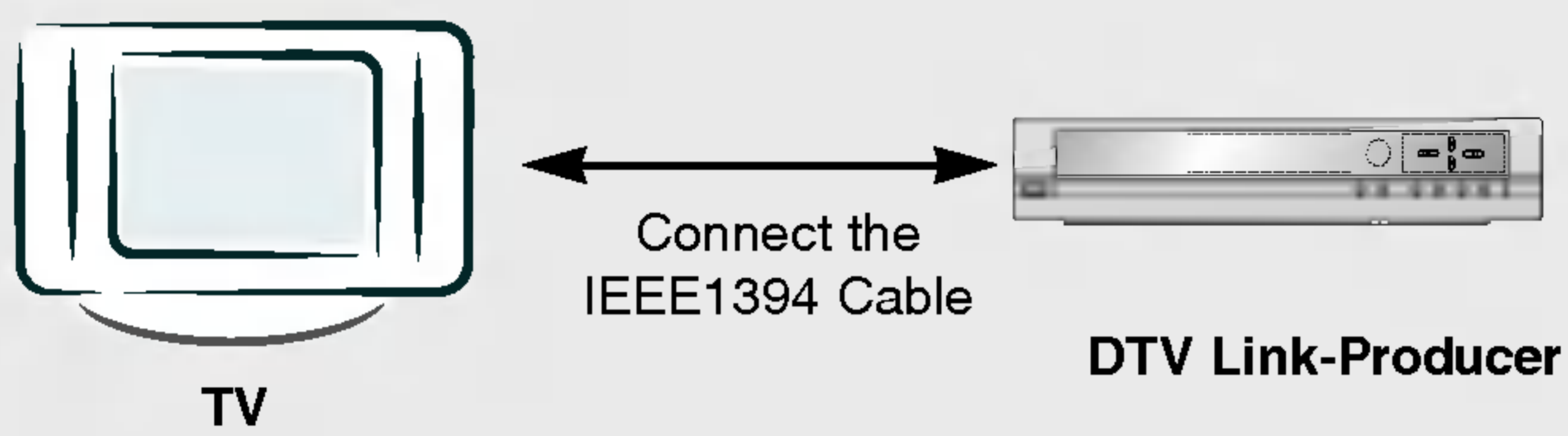

- 1 Connect the IEEE 1394 jack of the TV to the IEEE 1394 jack of the DTV Link supported device IEEE 1394 Cable.



- 2 When watching the TV, press the **1394** button and then **▲ / ▼** buttons to select the DTV Link supported device and then use the **ENTER** button.

- 3 Press the **TV INPUT** button to stop the IEEE1394 function.



- On a condition of connecting the IEEE 1394, you can control the DTV Link device while watching the OSD through DTV and DTV remote control.
(ex: change of channel, play, record, a show of recording list etc.)
- Analog channel is not supported.

Don't connect!

- When connecting with these 2 methods, the **IEEE1394** will not work properly.

(a) LOOP Connection

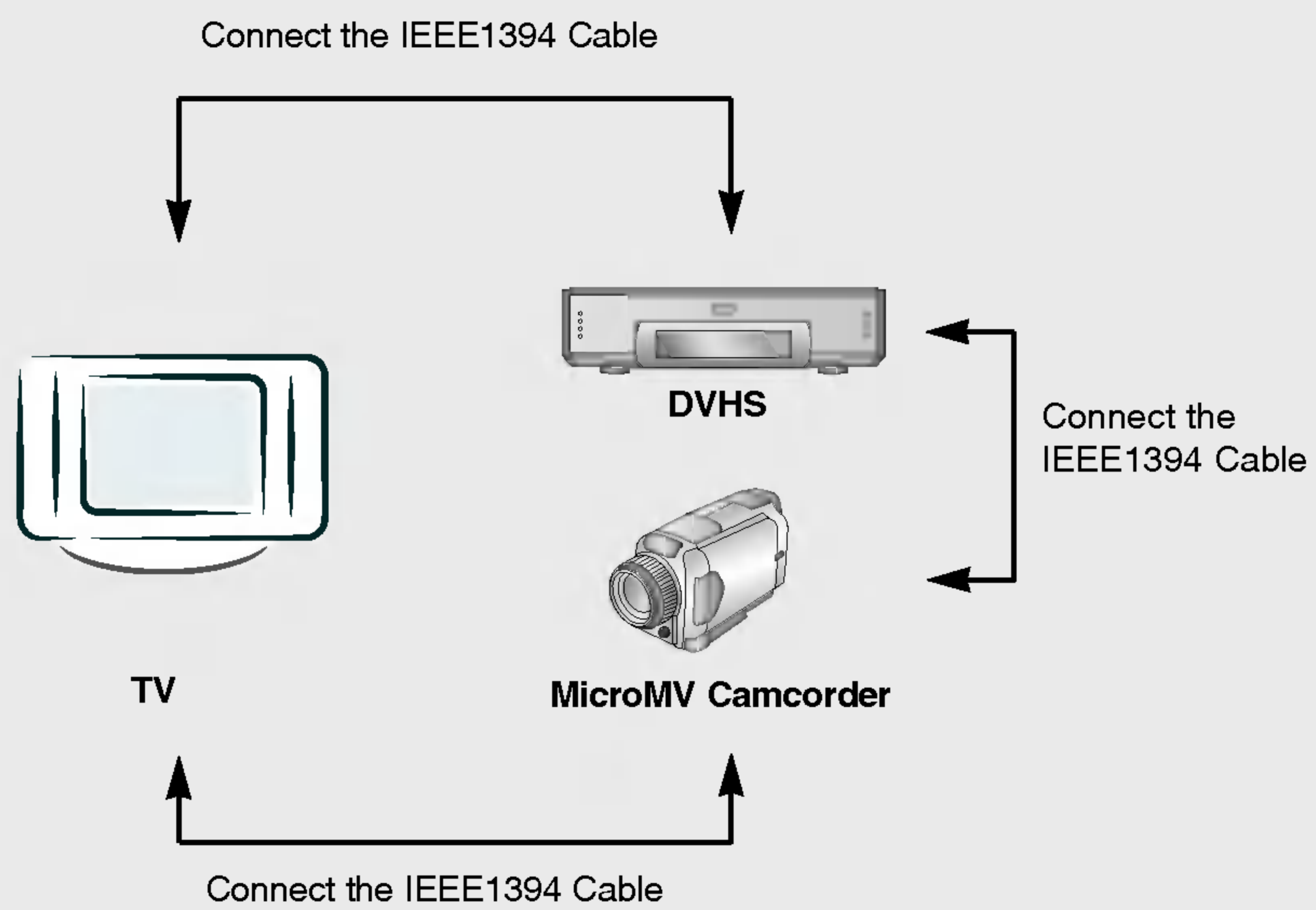

(b) When connecting the 4 devices and over, the 1394 will not work properly.



- When the same devices connect with 2 devices and over, it's undesirable.

G-LINK™ Setup

- The G-LINK™ cable is necessary for the TV Guide On Screen system to work with your Cable Box and VCR. See page 44~50 for information on setting up the TV Guide On Screen system.

1. Antenna Service

32, 37, 42 inch TV Back

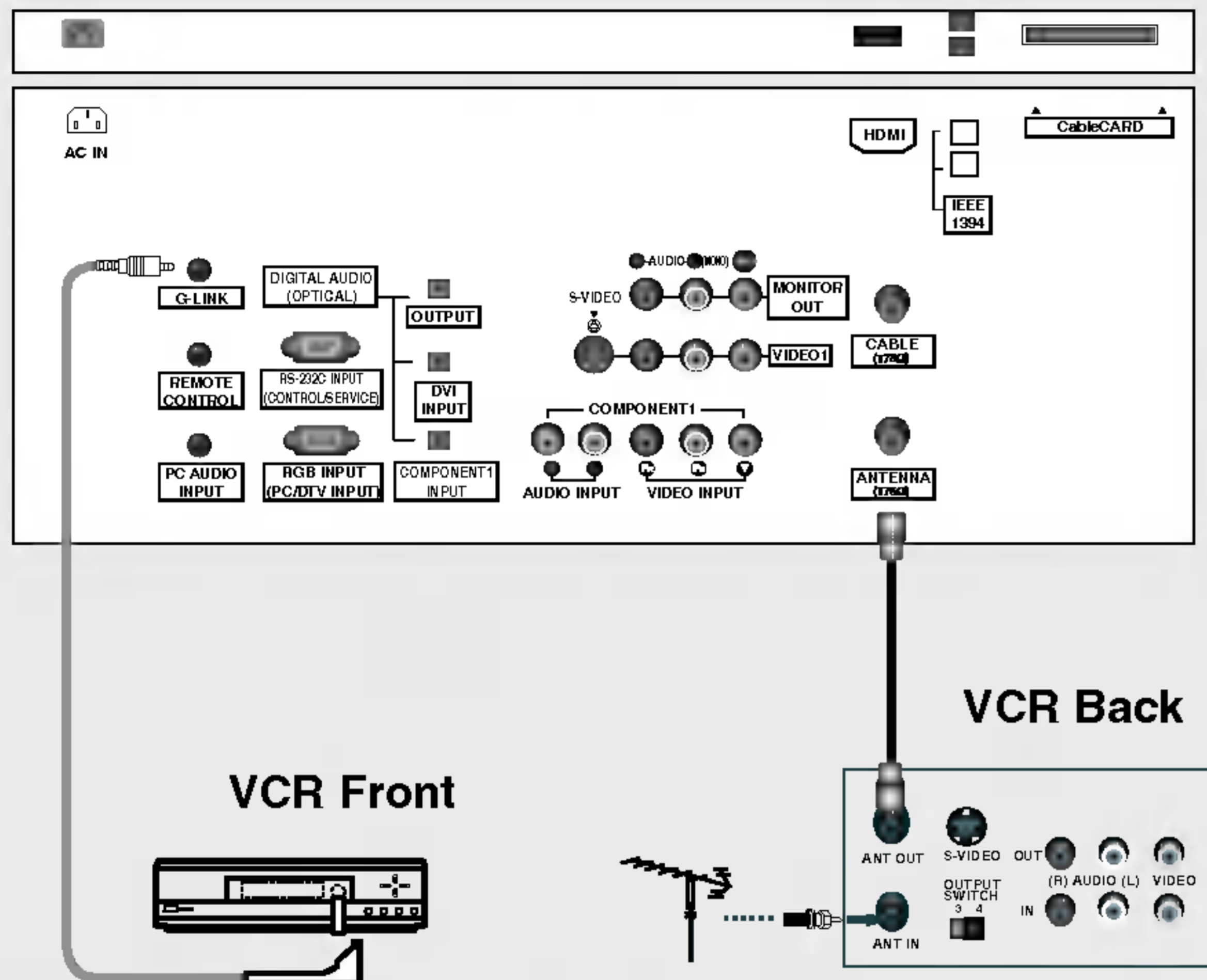

26 inch TV Back

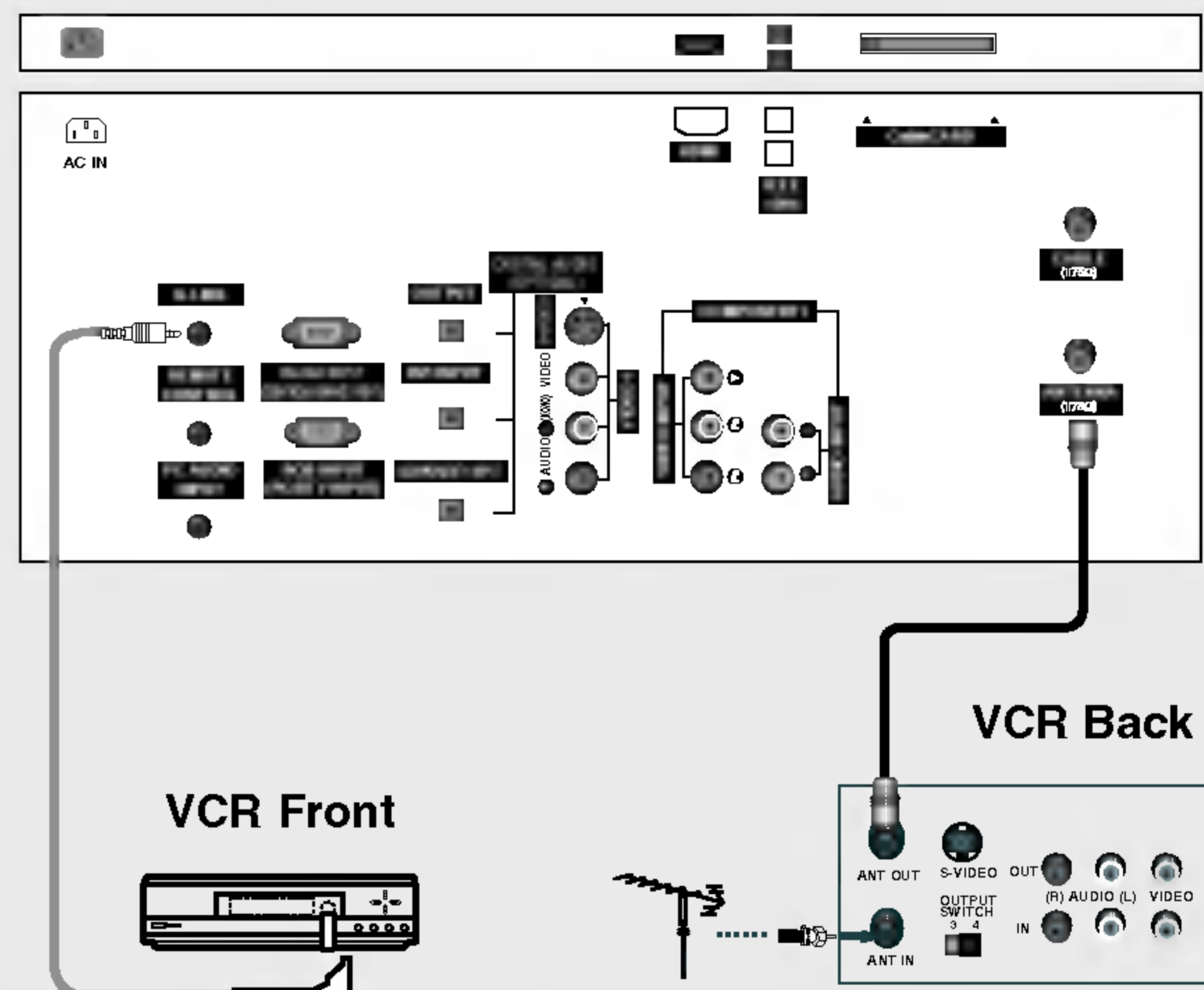

2. Cable Service without a Cable Box

32, 37, 42 inch TV Back

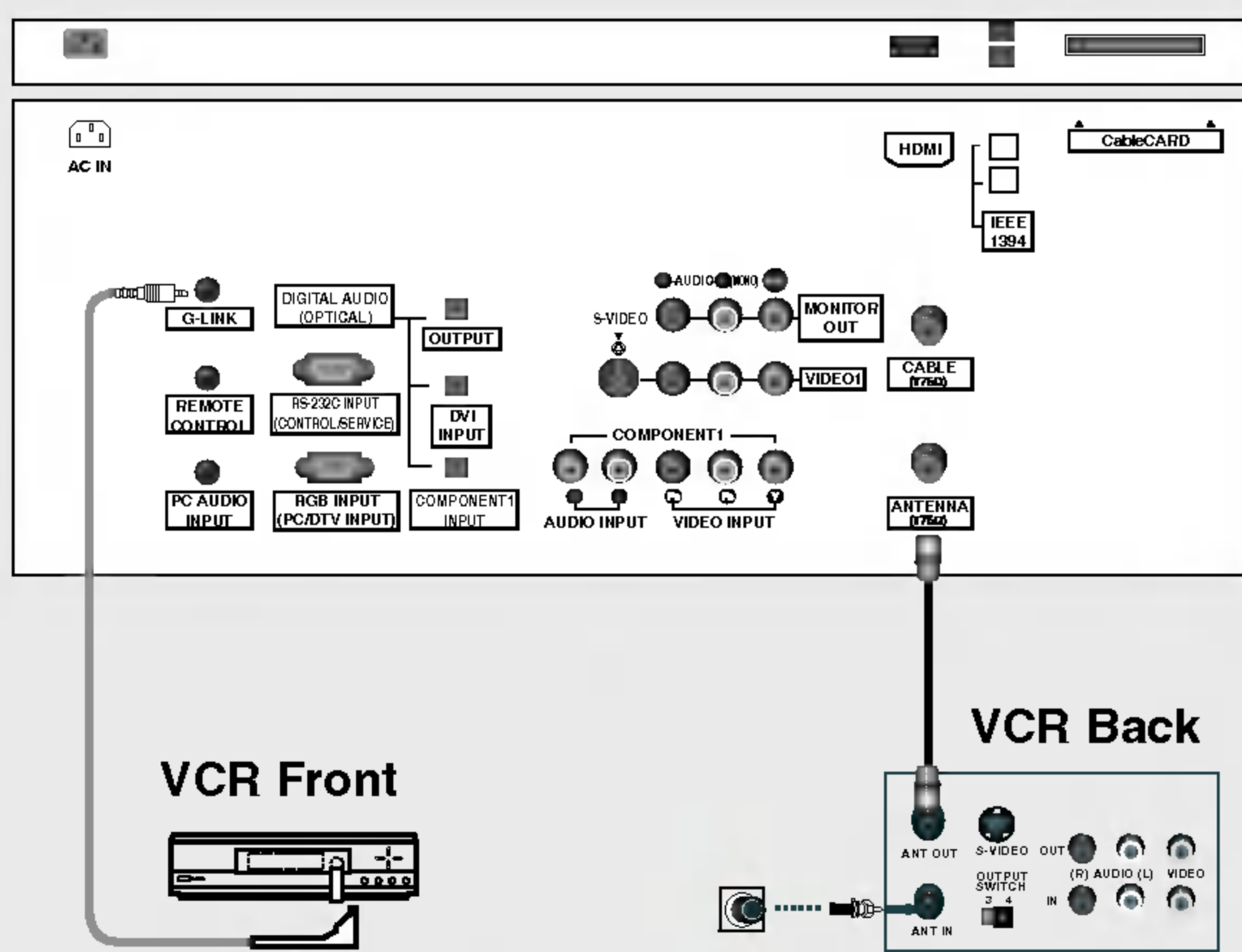

26 inch TV Back

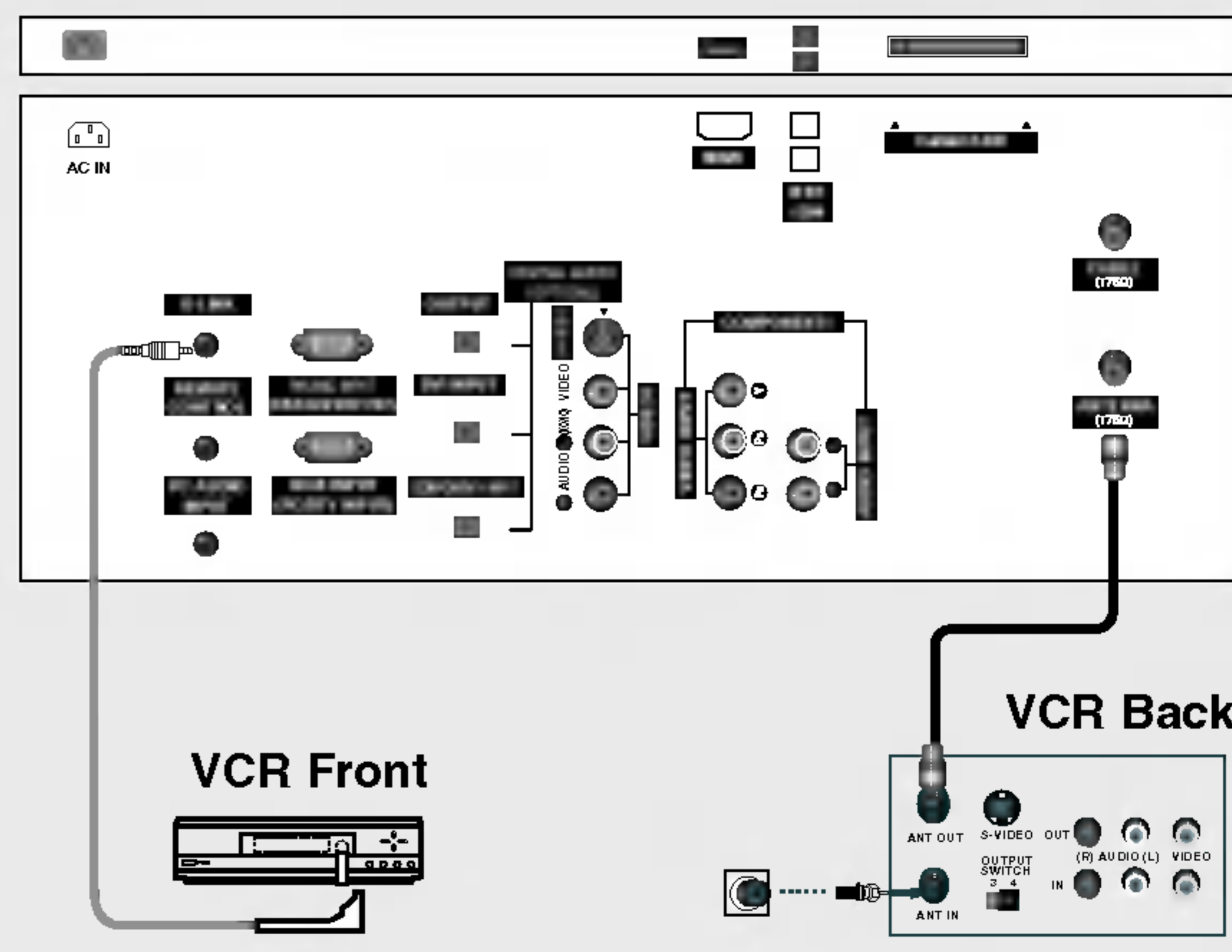

3. Cable Service with a Cable Box

32, 37, 42 inch TV Back

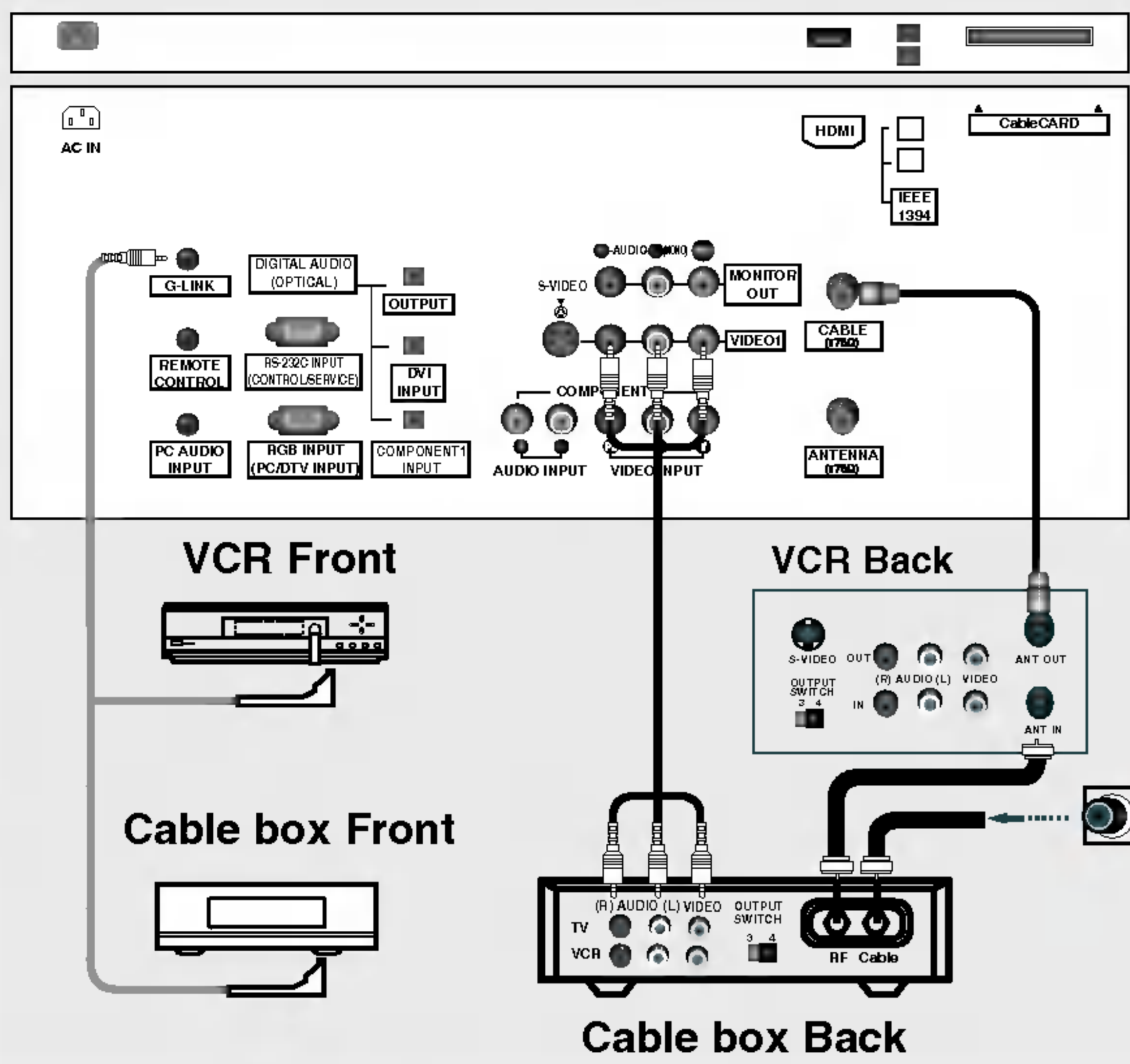

26 inch TV Back

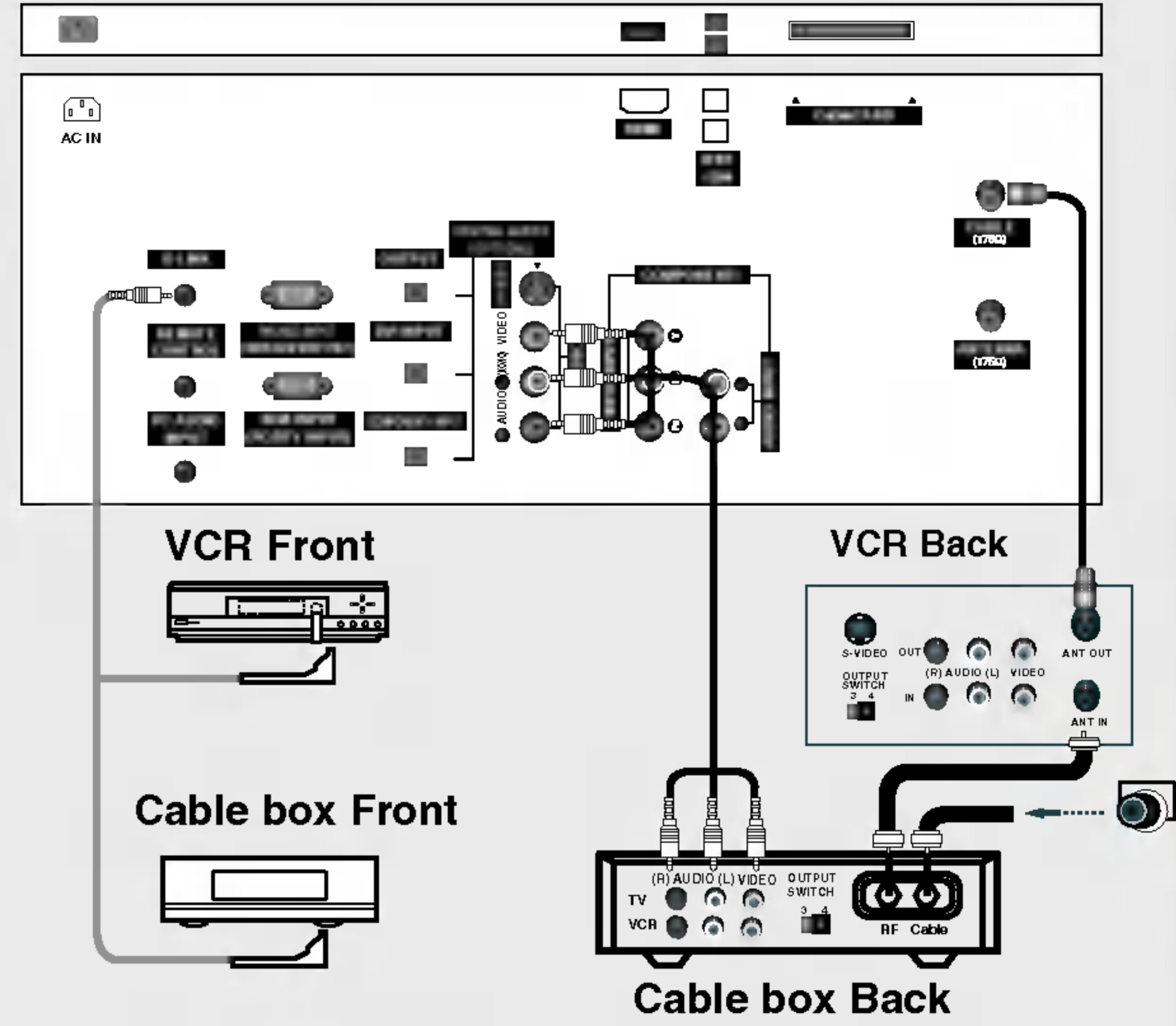

4. Antenna and Cable Service without a Cable Box

32, 37, 42 inch TV Back

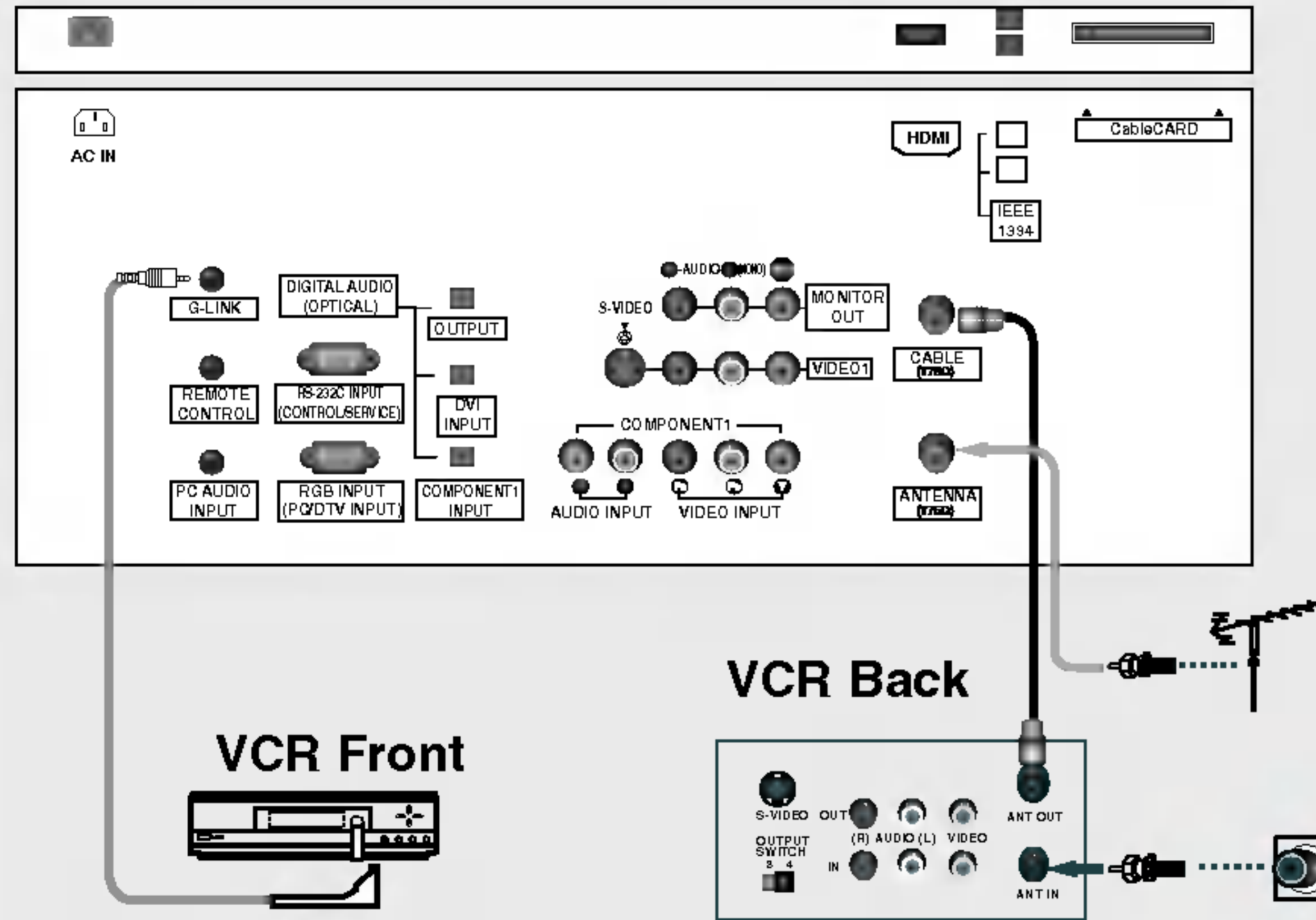

26 inch TV Back

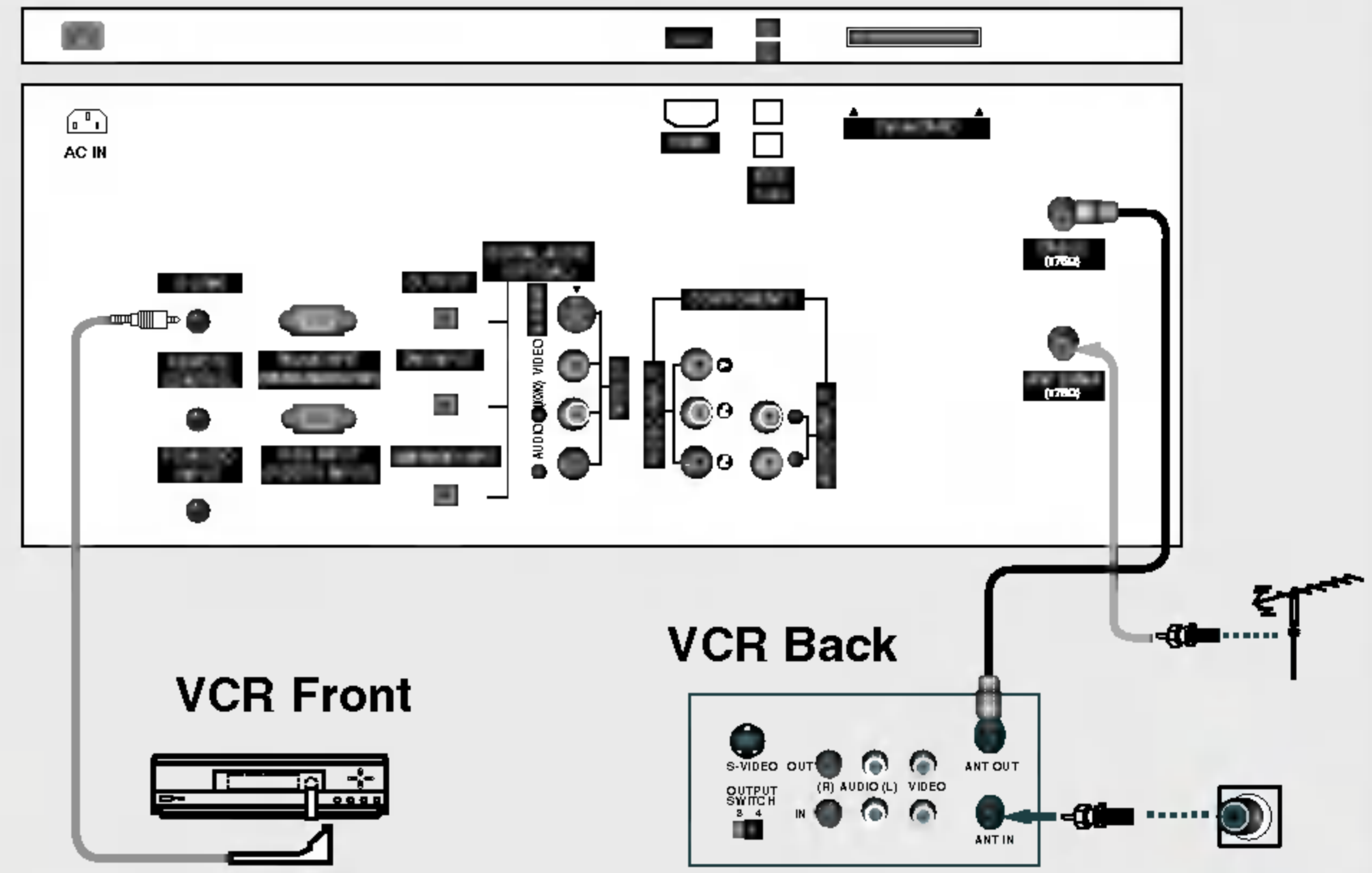

5. Antenna and Cable Service with a Cable Box

32, 37, 42 inch TV Back

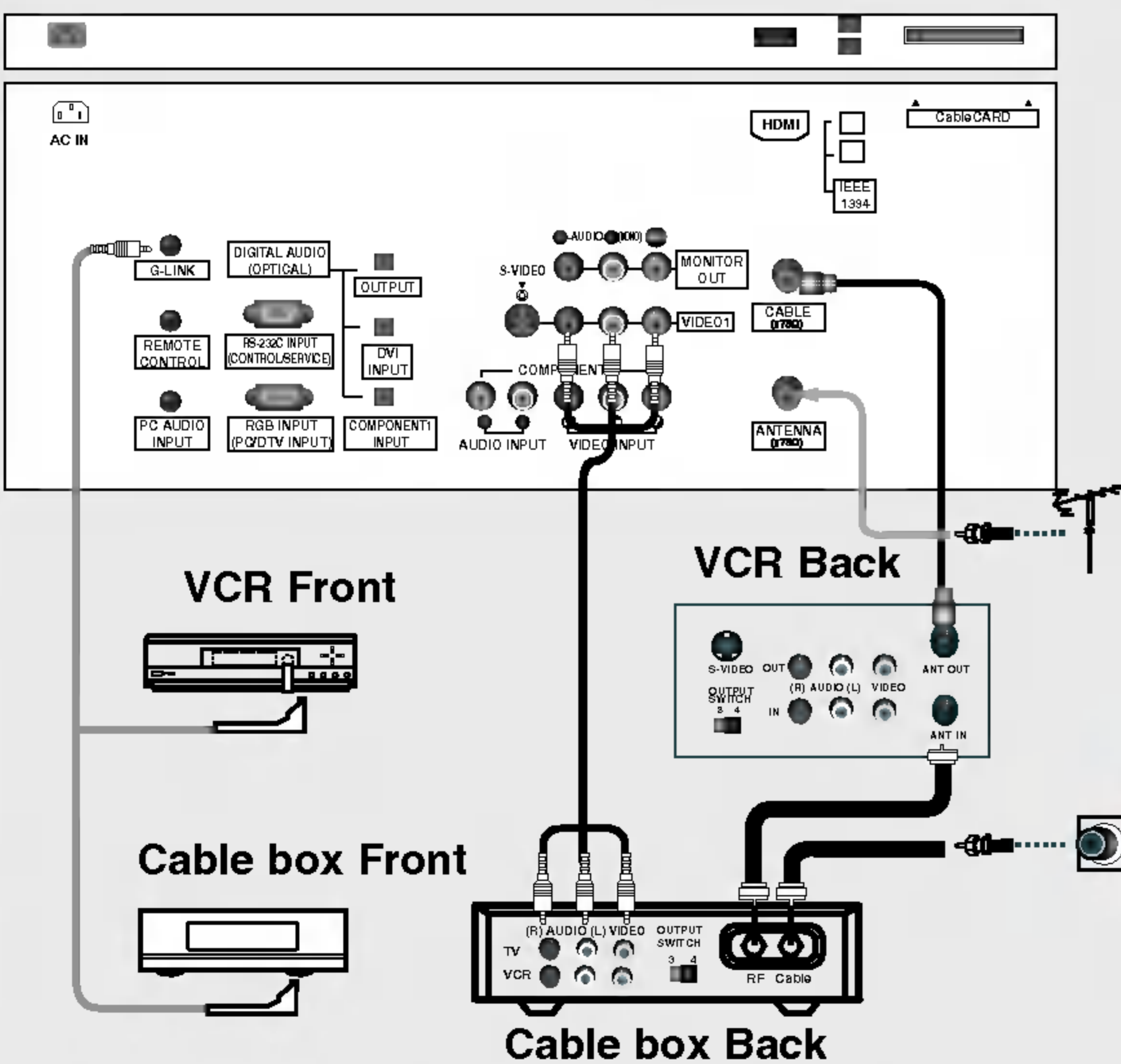

26 inch TV Back

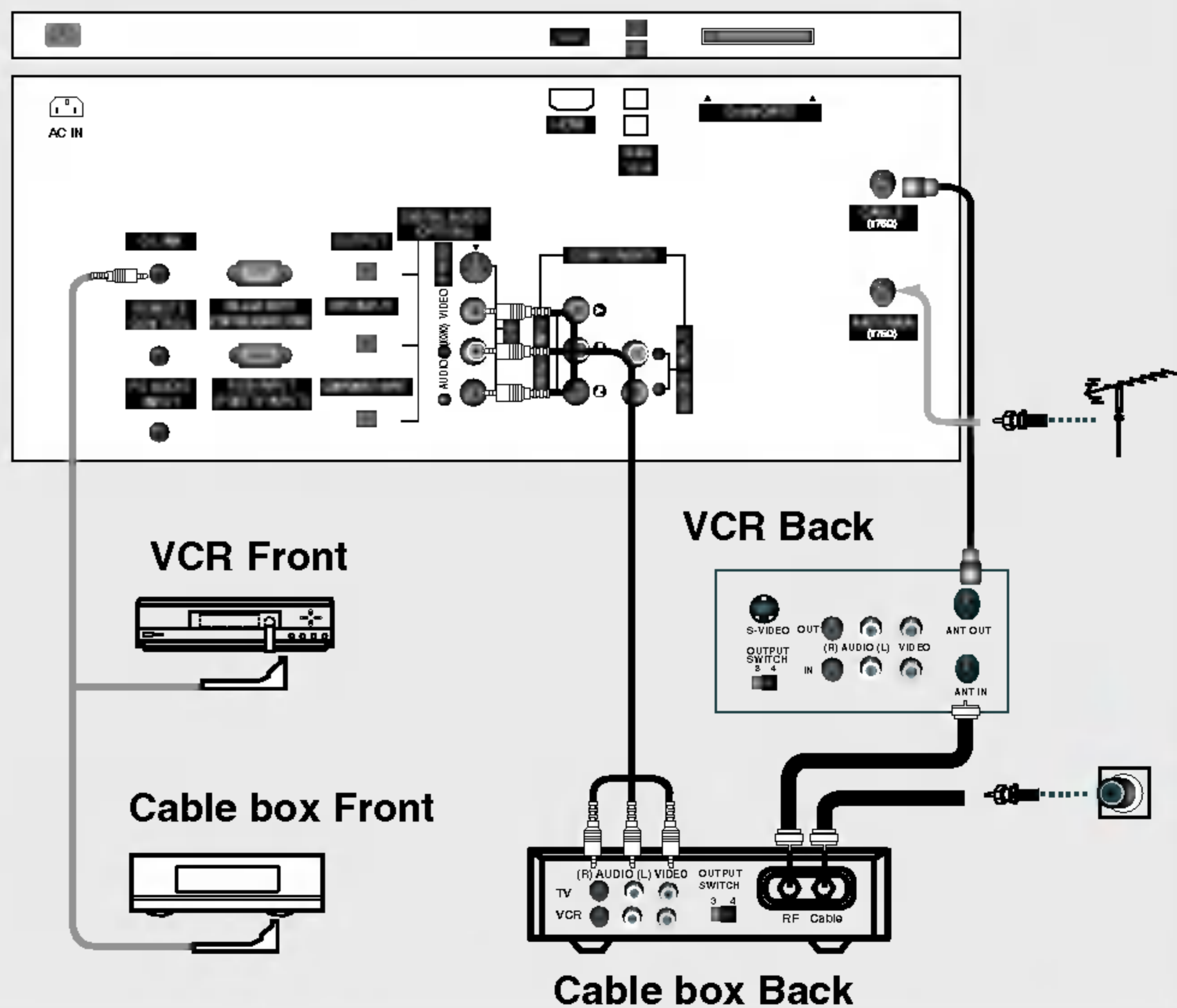

TV Guide On Screen™ System

TV Guide On Screen™ System Setup

- The TV Guide On Screen system uses Setup information to provide you with show listings and lineups in your area—which are updated several times a day.
- Once you set up the TV, you are ready to set up the TV Guide On Screen system. You will need to connect the G-LINK™ cable for the TV Guide On Screen system to work with your Cable Box and VCR. See page 42 for information on connecting the G-LINK™ cable.

*Note: The TV Guide On Screen system provides listings for cable-ready, cable box, and digital cable services as well as over-the-air broadcast. It does not provide listings for satellite services.

Note

- The TV Guide On Screen system receives program listings data through your cable or over-the-air video signal. In order to receive regular program listings, please remember to do the following:
 1. Turn OFF your TV when it is not in use. (Do not unplug the power cord.)
 2. If you have a Cable box connected, leave it ON.
 3. If you have a VCR connected, turn it OFF when not in use. (Do not unplug the power cord.)
 4. If you have more than one Cable system in your area, you may be prompted to select which Cable system's program data to download. If so prompted, please follow the on-screen instructions.

Ready to setup

1 Reminder Screen

The TV Guide On Screen system's Reminder Screen appears:

- after initial TV set up
- if you power Off the TV and then power it back On

To make a selection, use the ▲ / ▼ button to highlight an option, and press **ENTER** button.

- “Set up TV Guide On Screen now”, displays the Welcome Screen. Press **ENTER** button to begin Setup.
- “Remind me to set up later” returns you to watching TV.
- “Don't remind me again” returns you to watching TV and stops the reminder screen from appearing upon power On.

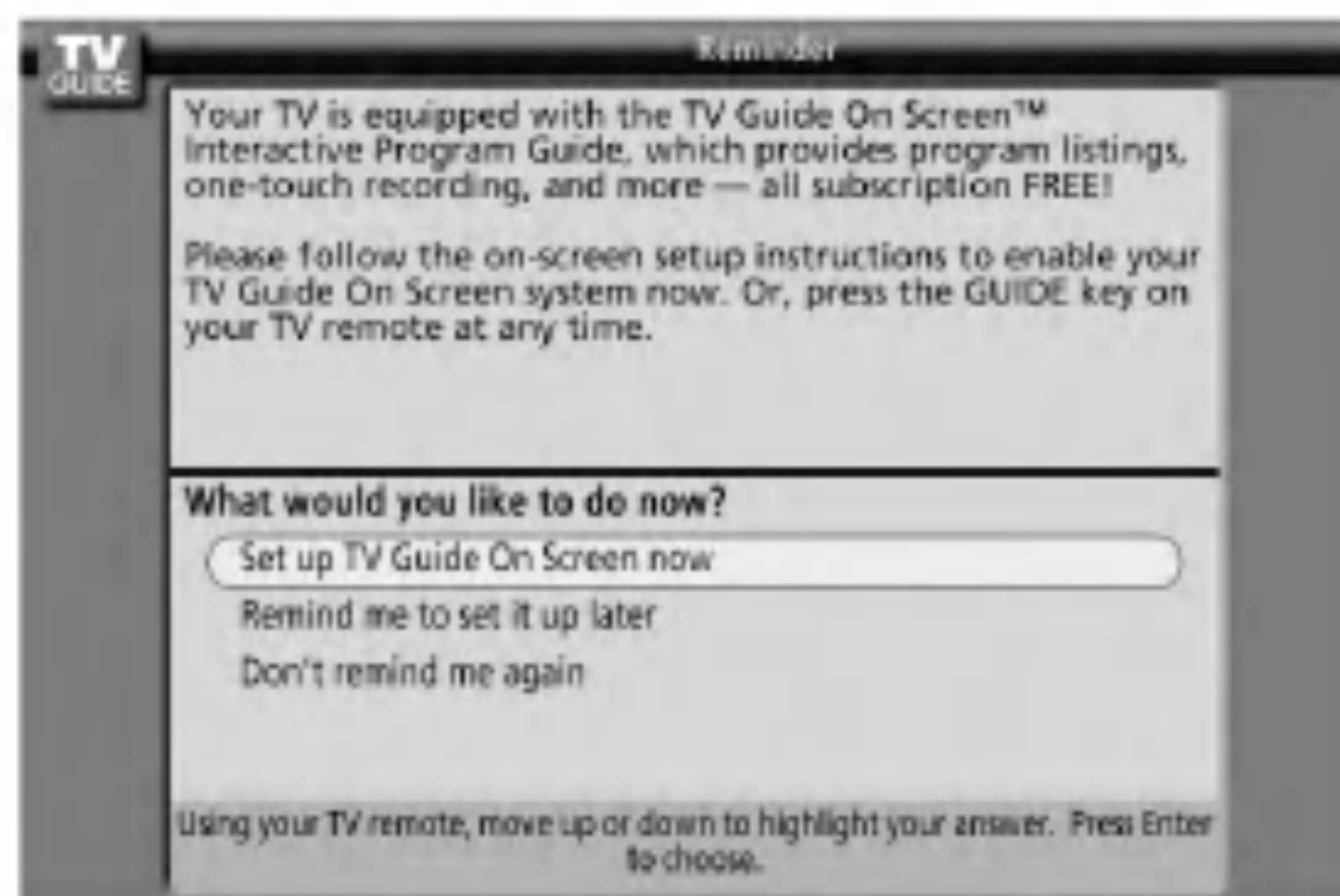

2 Welcome Screen

The TV Guide On Screen system's Welcome Screen appears:

- by pressing the **TV GUIDE** button
- when you select "Set up TV Guide On Screen now" on the Reminder Screen.

The Welcome Screen highlights features of the TV Guide On Screen system. Press **ENTER** button to begin Setup.



How to use

1 Screen 1: Country

- This screen asks you the location of your TV.
- Use the ▲ / ▼ button to highlight a country.
- Press **ENTER** button to display Screen 2.

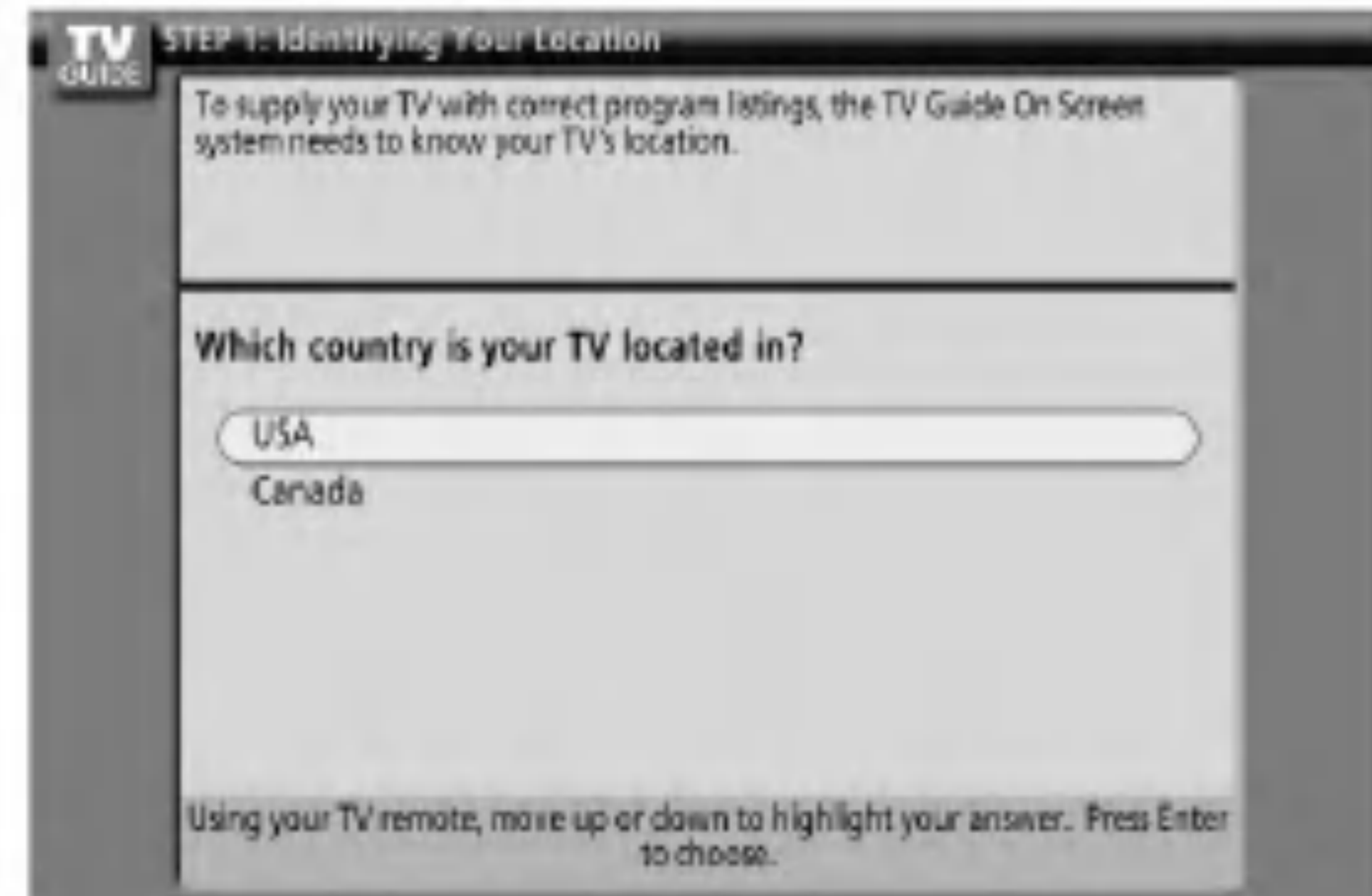

2 Screen 2: Enter ZIP or Postal Code

Option 1

- If you selected USA in Screen 1, you see the ZIP Code screen.
- You input numbers by either pressing the number keys on the remote or using the ▲ / ▼ button to display a number, and then the ◀ / ▶ button to move to another field.
- Press **ENTER** button to display Screen 3.

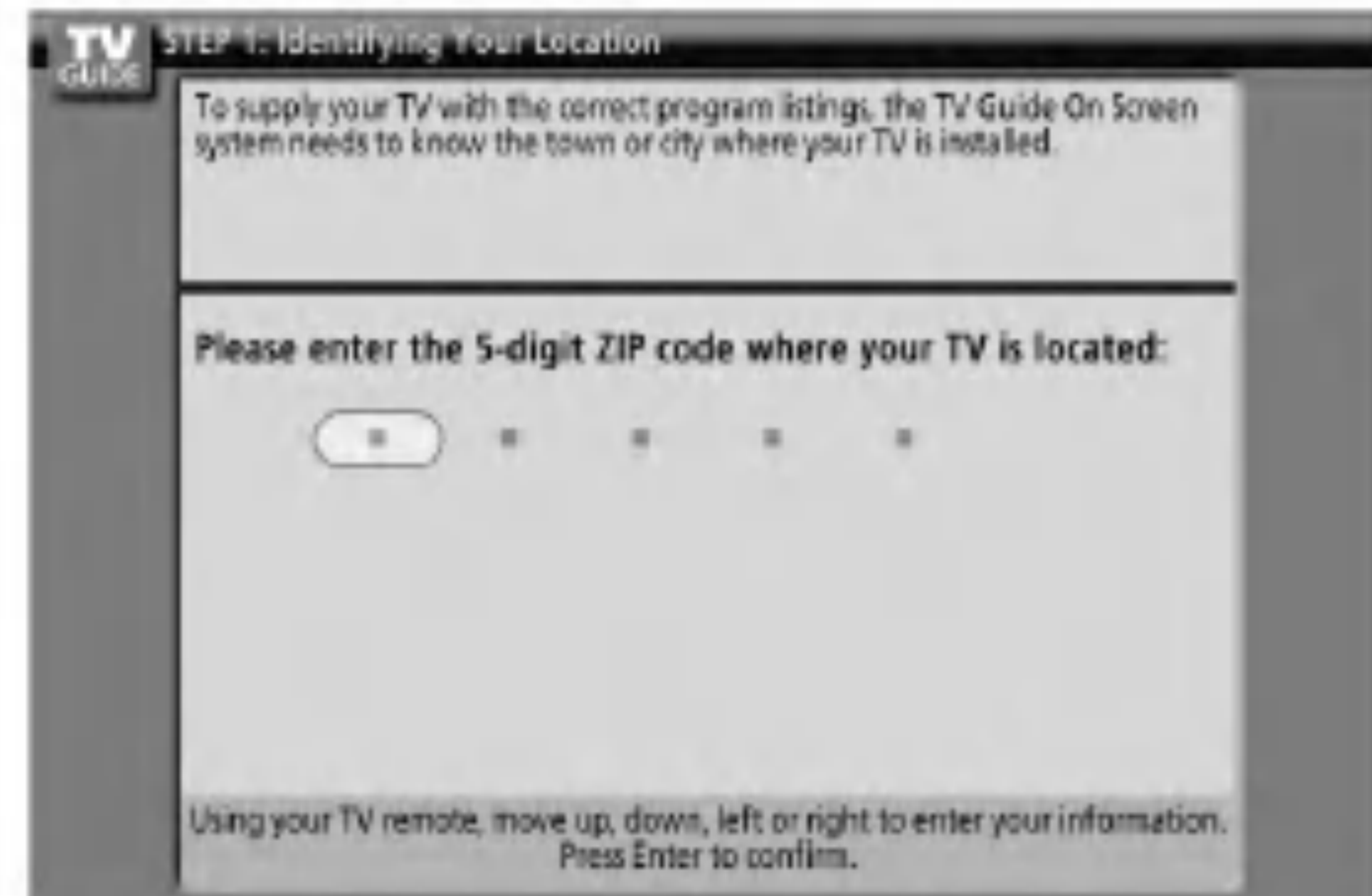

Option 2

- If you selected Canada in Screen 1, you see the Postal Code screen.
- You input characters by using the ▲ / ▼ button, and then the ◀ / ▶ button to move to another field.
- Press **ENTER** button to display Screen 3.

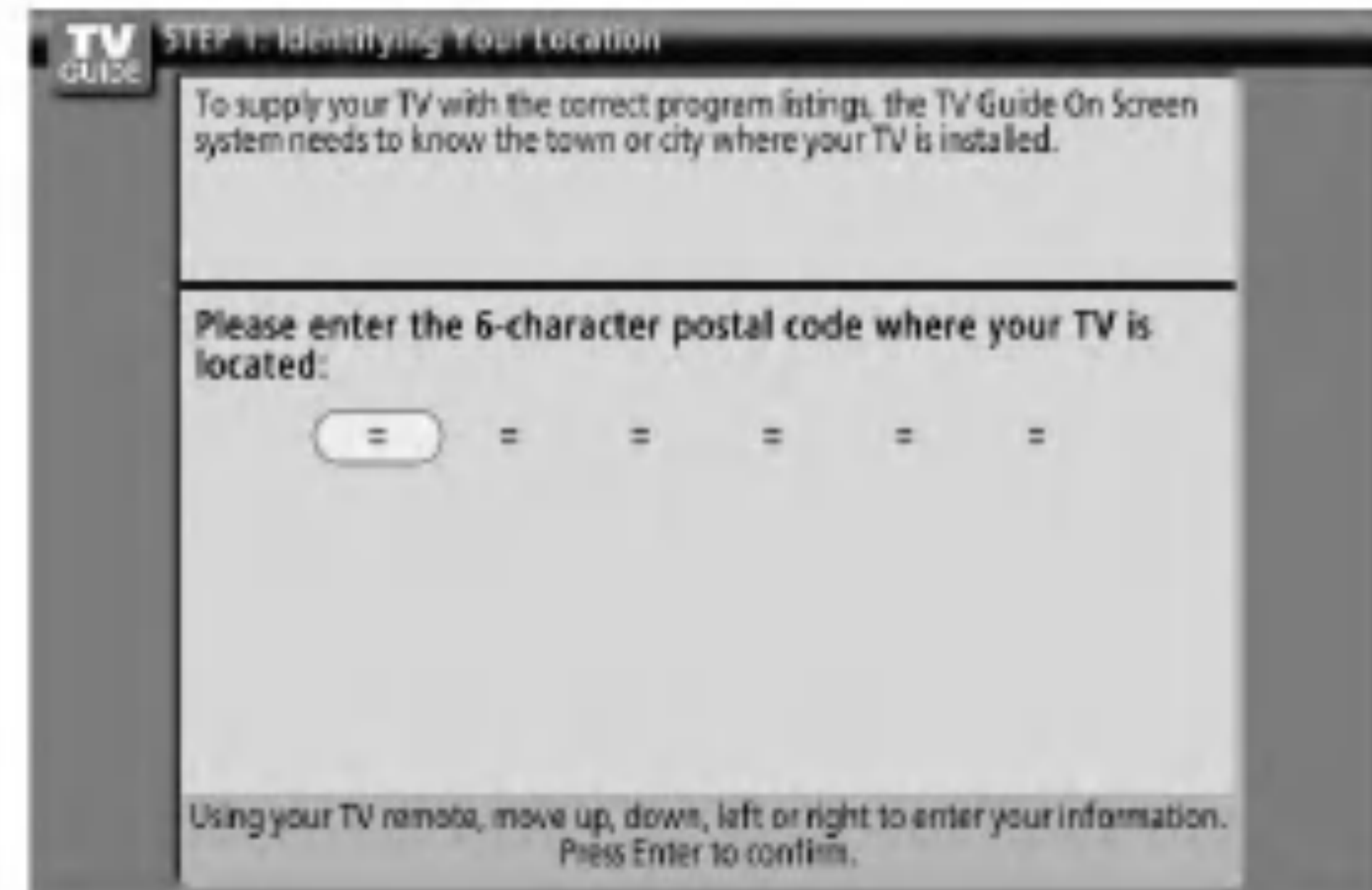

3 Screen 3: Do you have Cable Service connected?

- If you select Yes, you see Screen 4.
- If you select No, you see Screen 12.

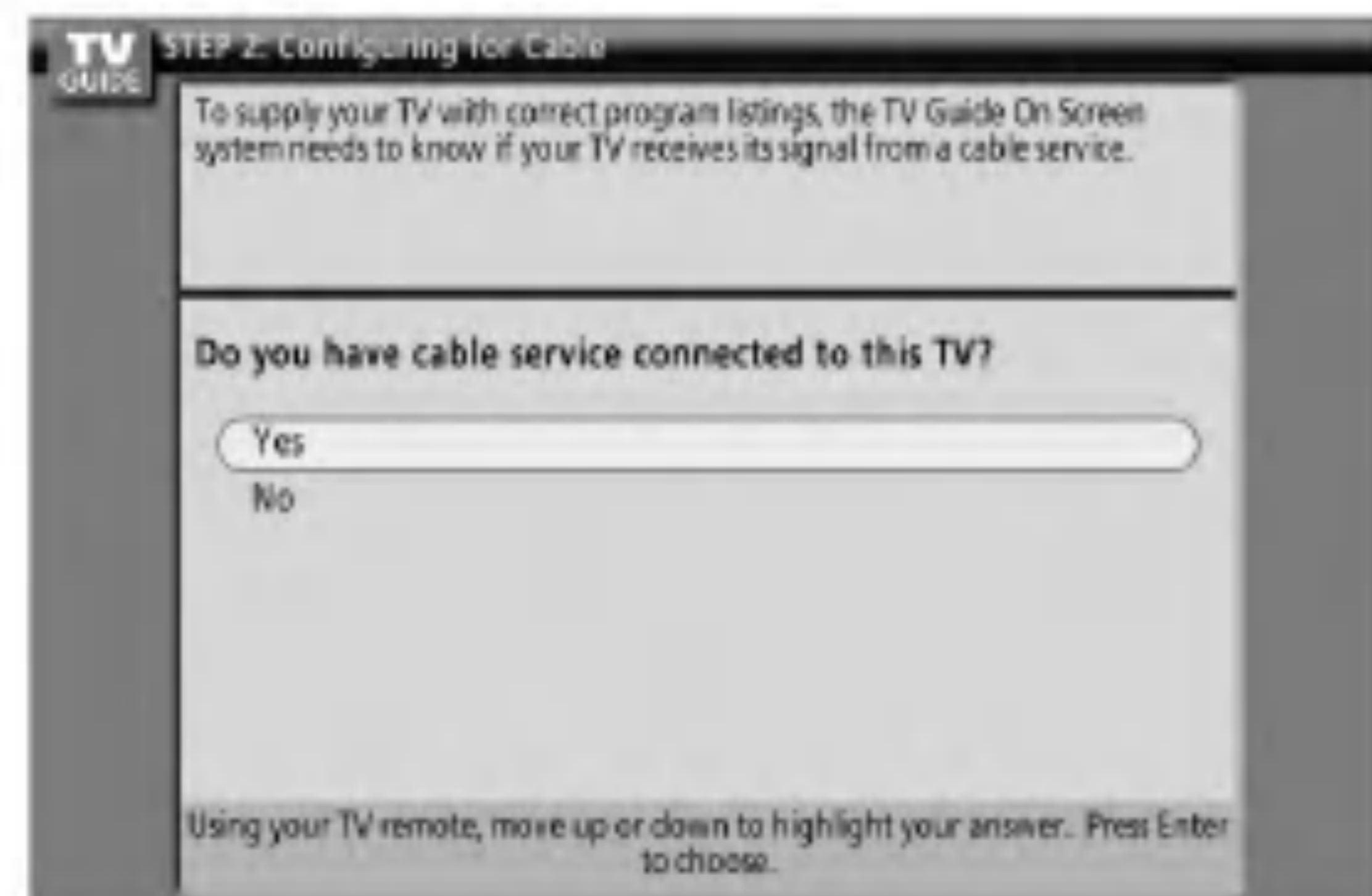

4 Screen 4: Do you have a Cable Box?

- If you select Yes, you see Screen 5.
- If you select No, you see Screen 12.

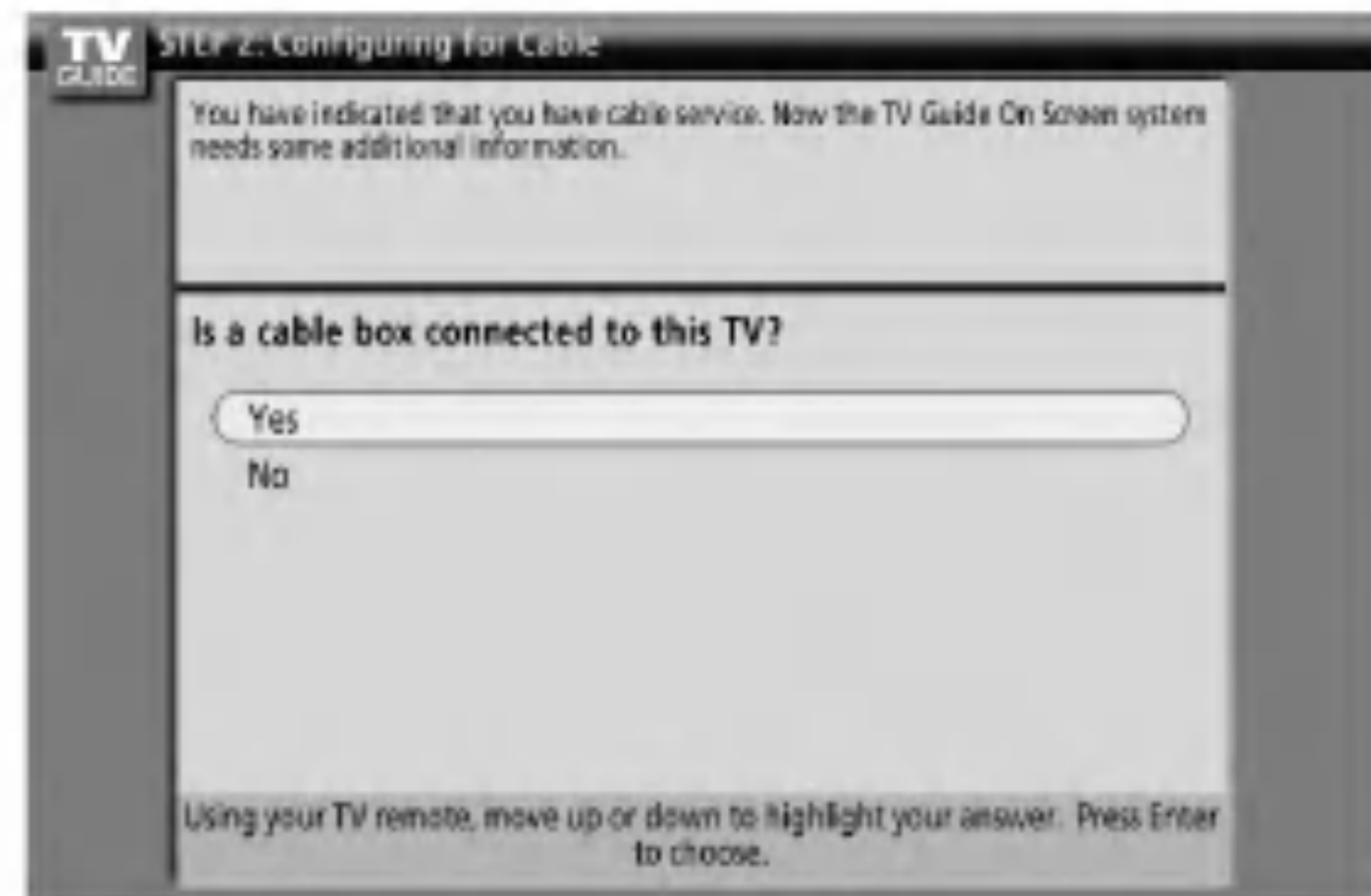

5 Screen 5: Which TV input is the cable box plugged into?

- If you select Cable, you see Screen 6.
- If you make any other choice, you see Screen 7.

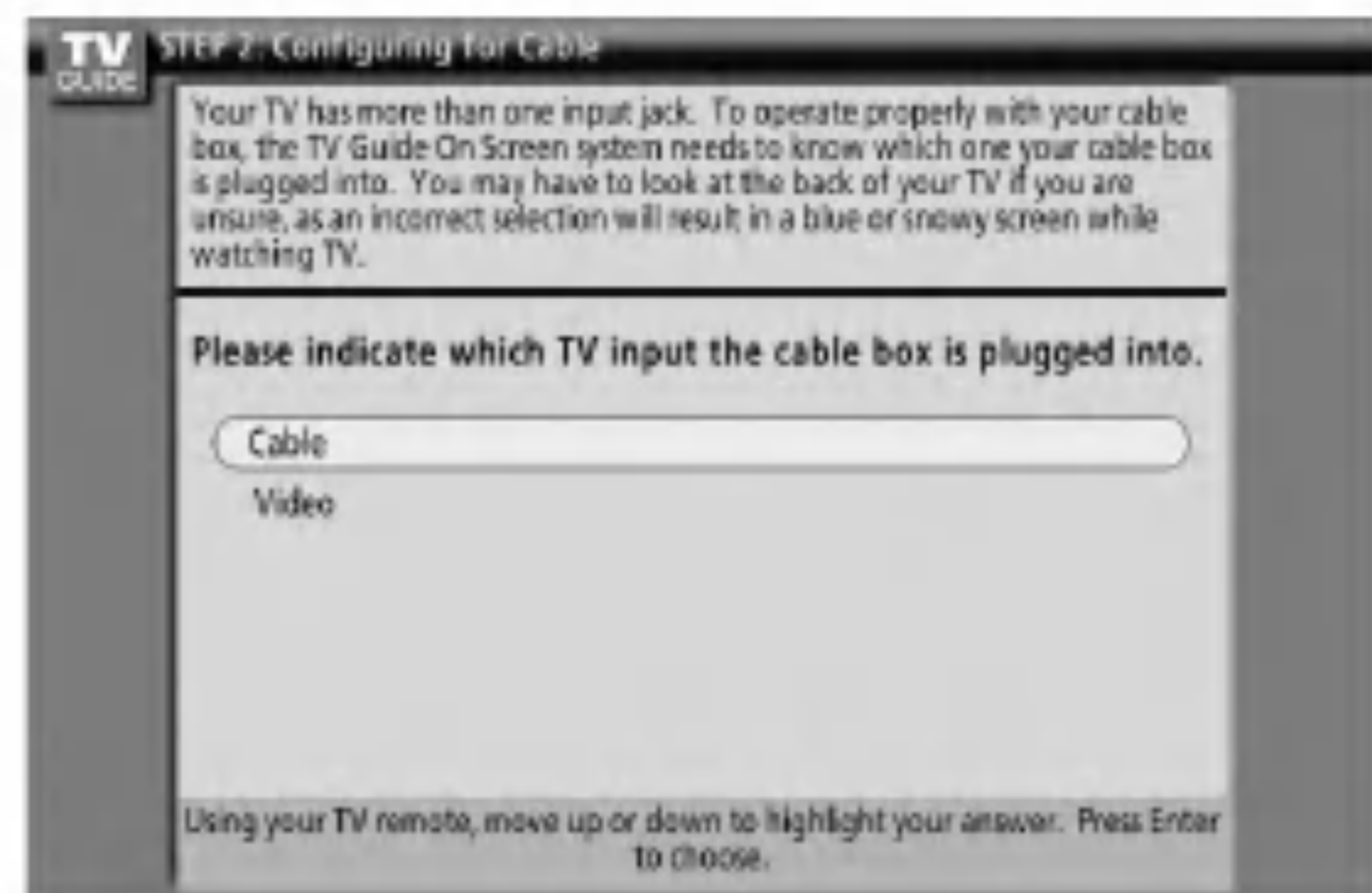

6 Screen 6: Cable Box Tuning Channel

- Select the channel used for the cable box.
- Press **ENTER** button to display Screen 7.

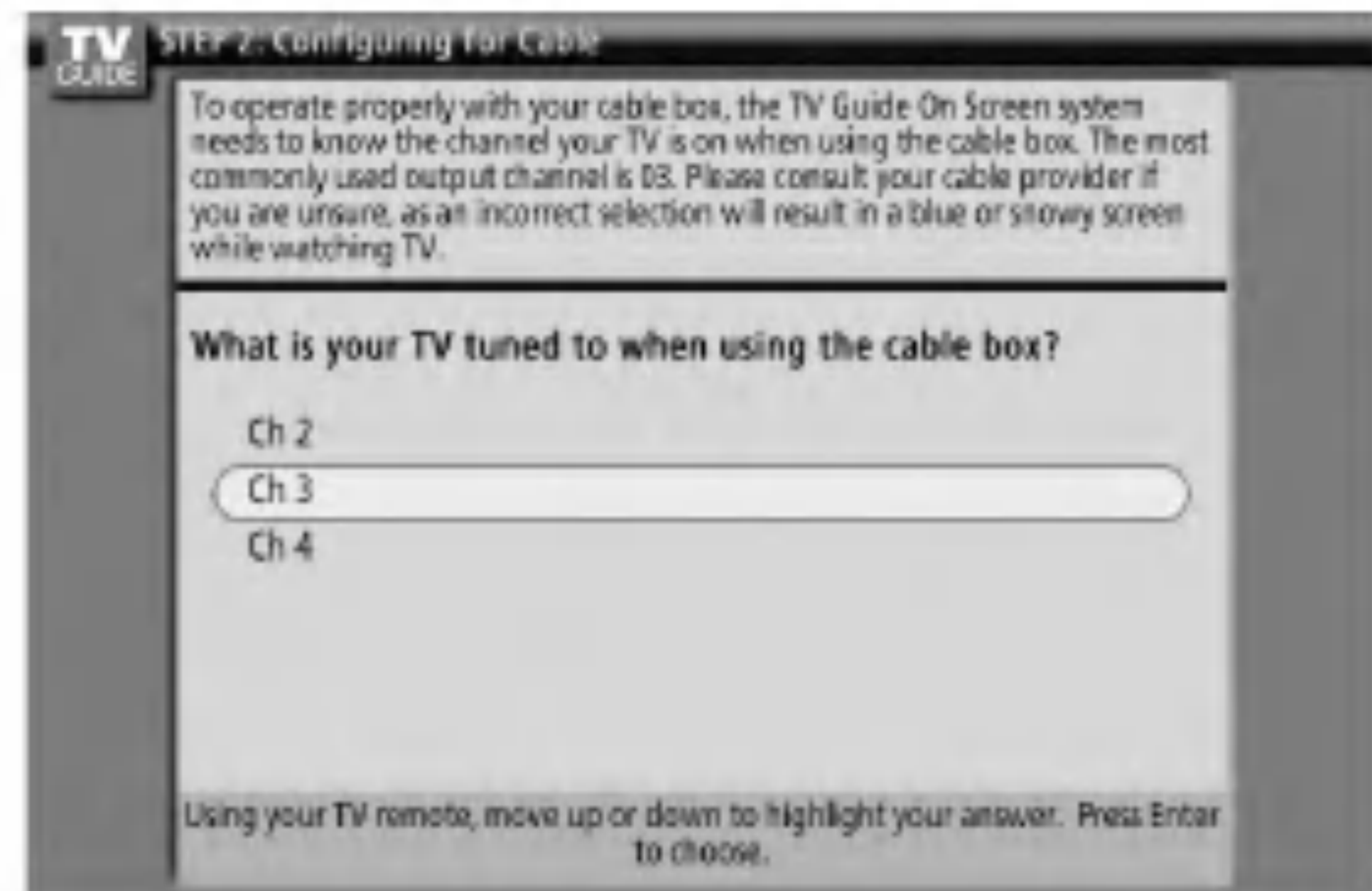

7 Screen 7: Cable Box Configuration Diagram

- The diagram shows the correct way to install the G-LINK™ Cable from the back of the device to the cable box. Make sure the G-LINK™ Cable is properly installed.
- Press **ENTER** button to display Screen 8.

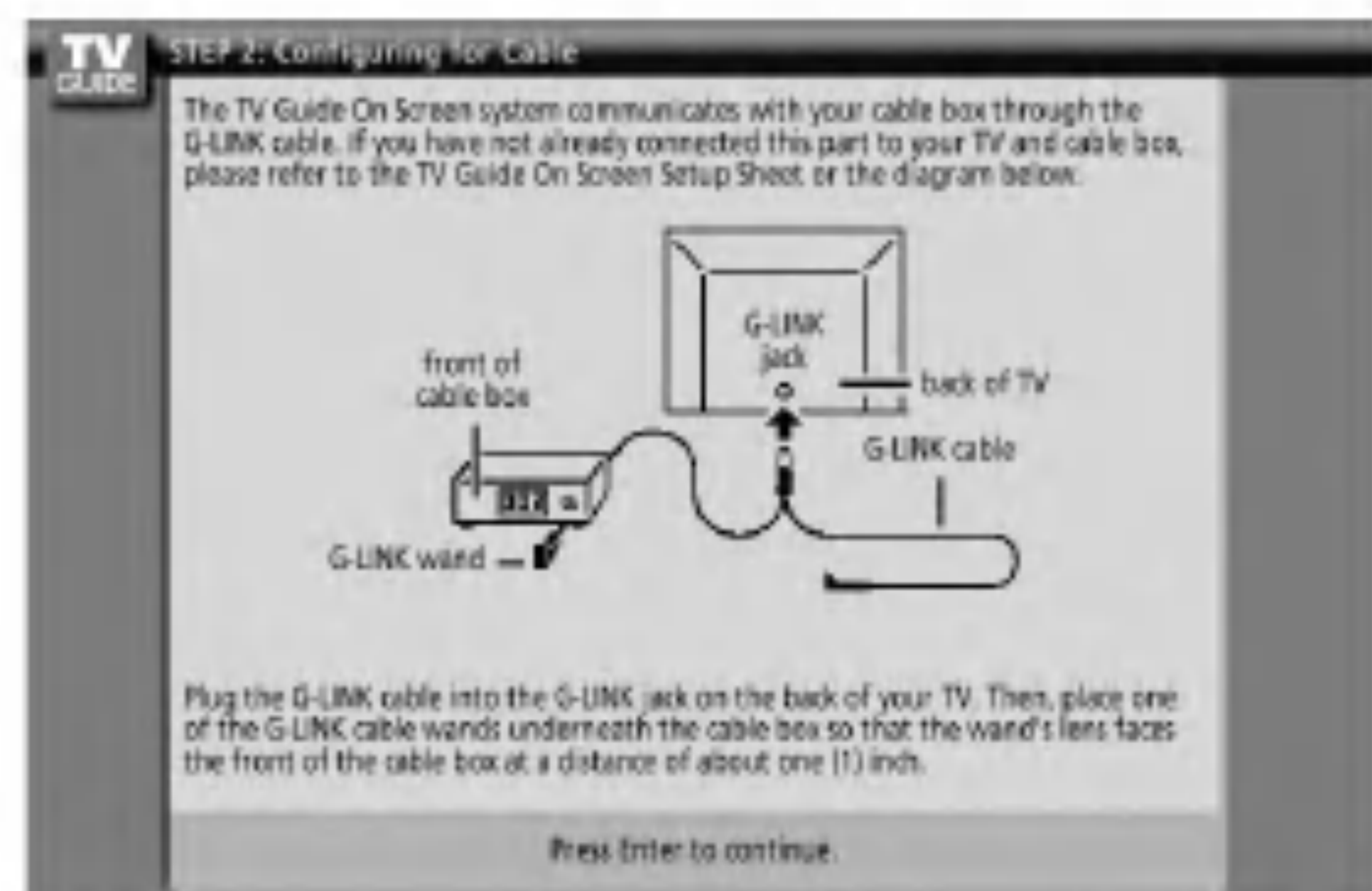

8 Screen 8: Cable Box Brand Name

- Use the ▲ / ▼ button to select a cable box brand.
- Press **ENTER** button to display Screen 9.

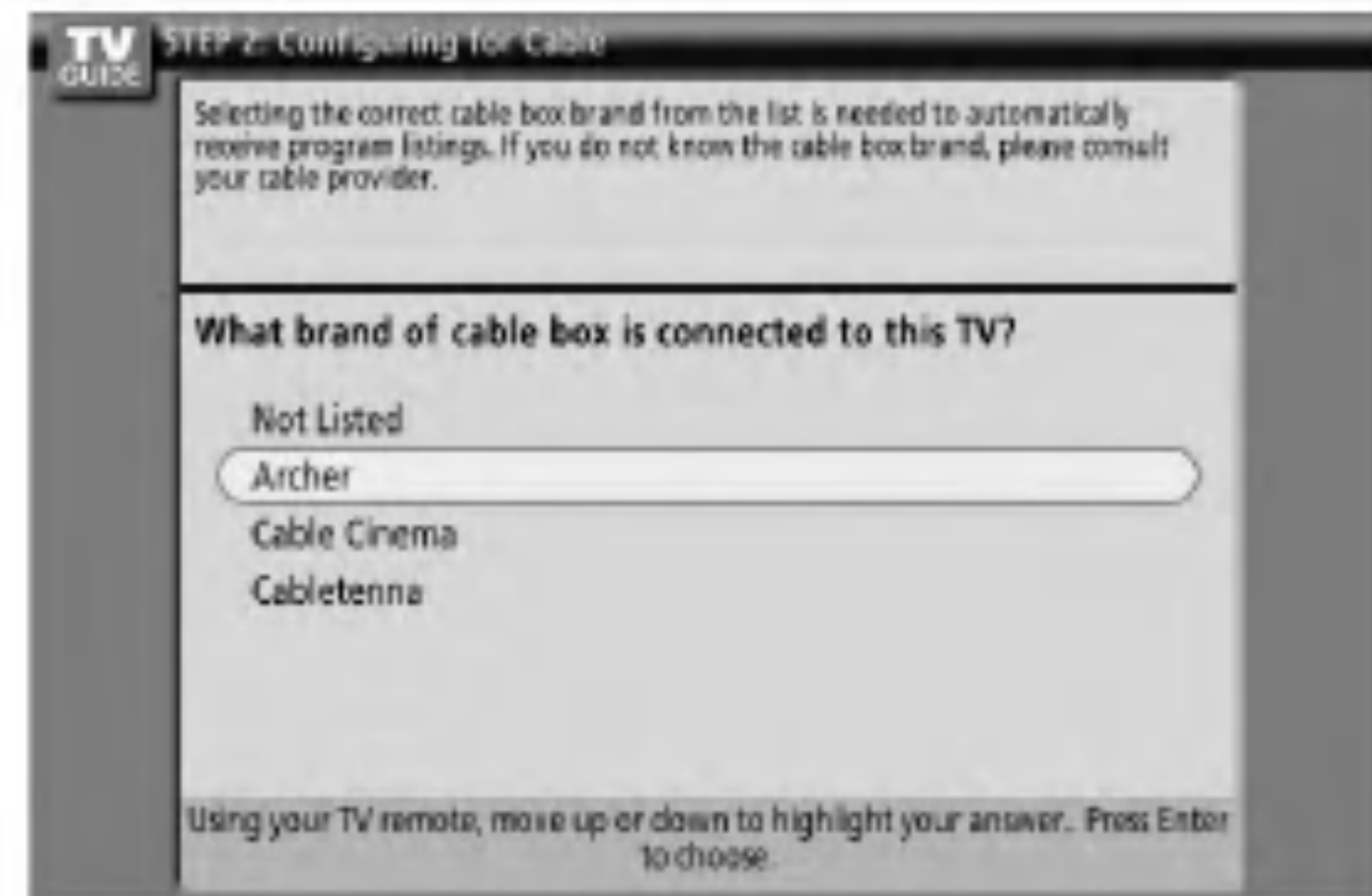

9 Screen 9: Cable Box Preparation

- Follow the on-screen instructions, and press **ENTER** button to display Screen 10.

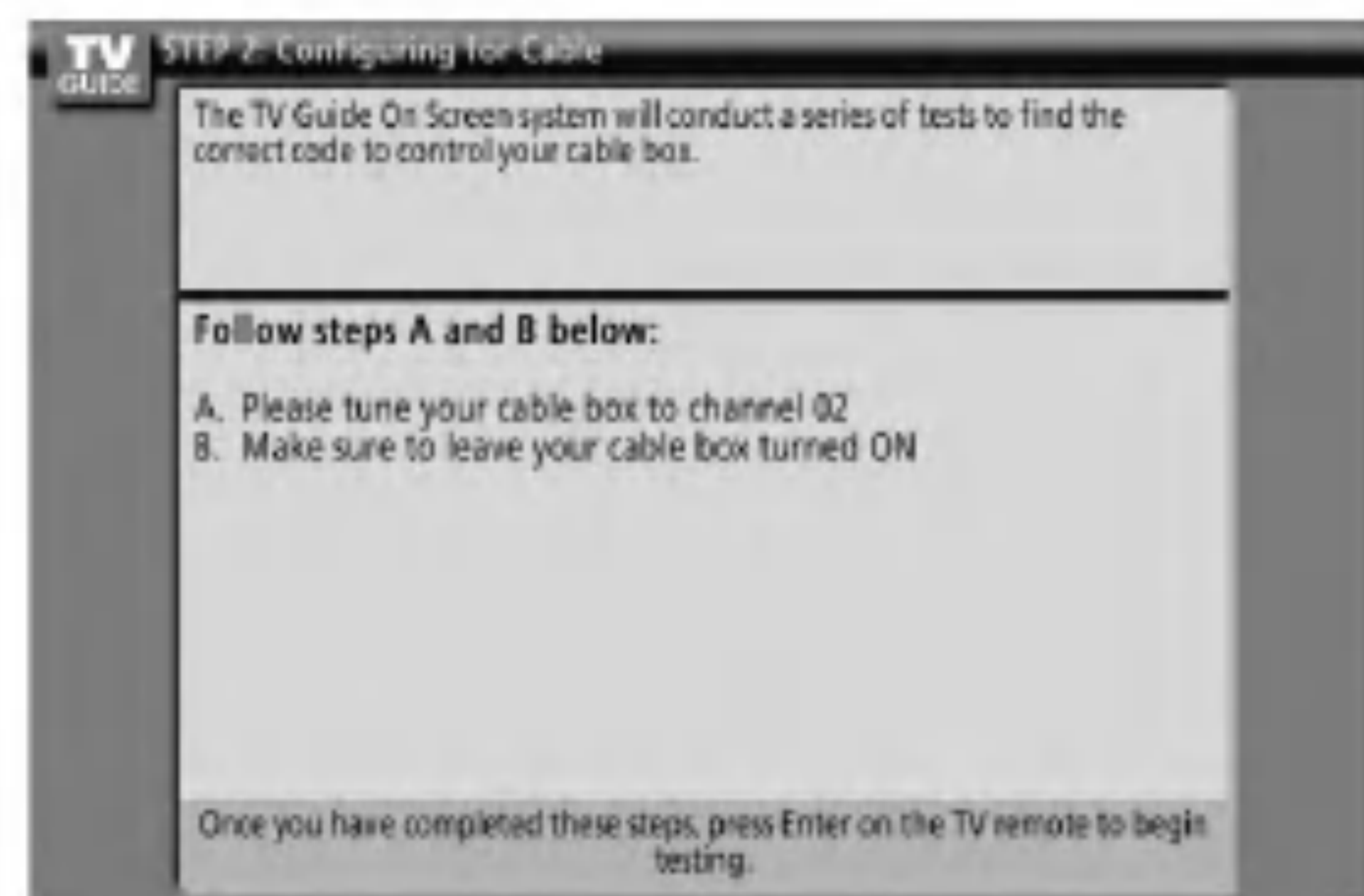

10 Screen 10: Cable Box Code Testing

- When testing is done, Screen 11 displays automatically.

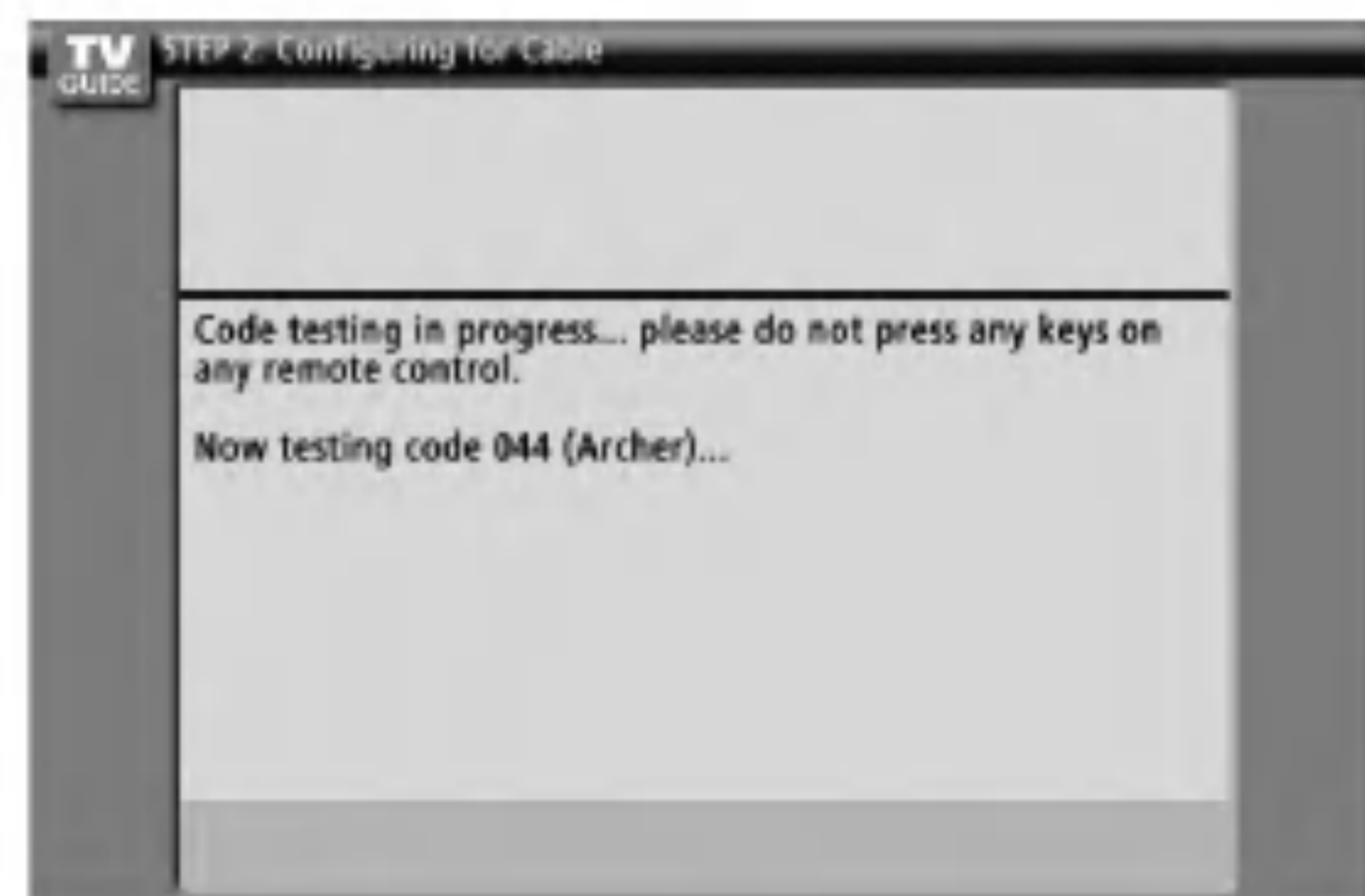

11 Screen 11: Cable Box Tuned to Channel 9?

- If you select Yes, you see Screen 12.
- If you select No, a different code is tested in Screen 10.

- Many Cable Boxes require testing more than one code.
- If you select Test this code again, the same code is tested again in Screen 10.

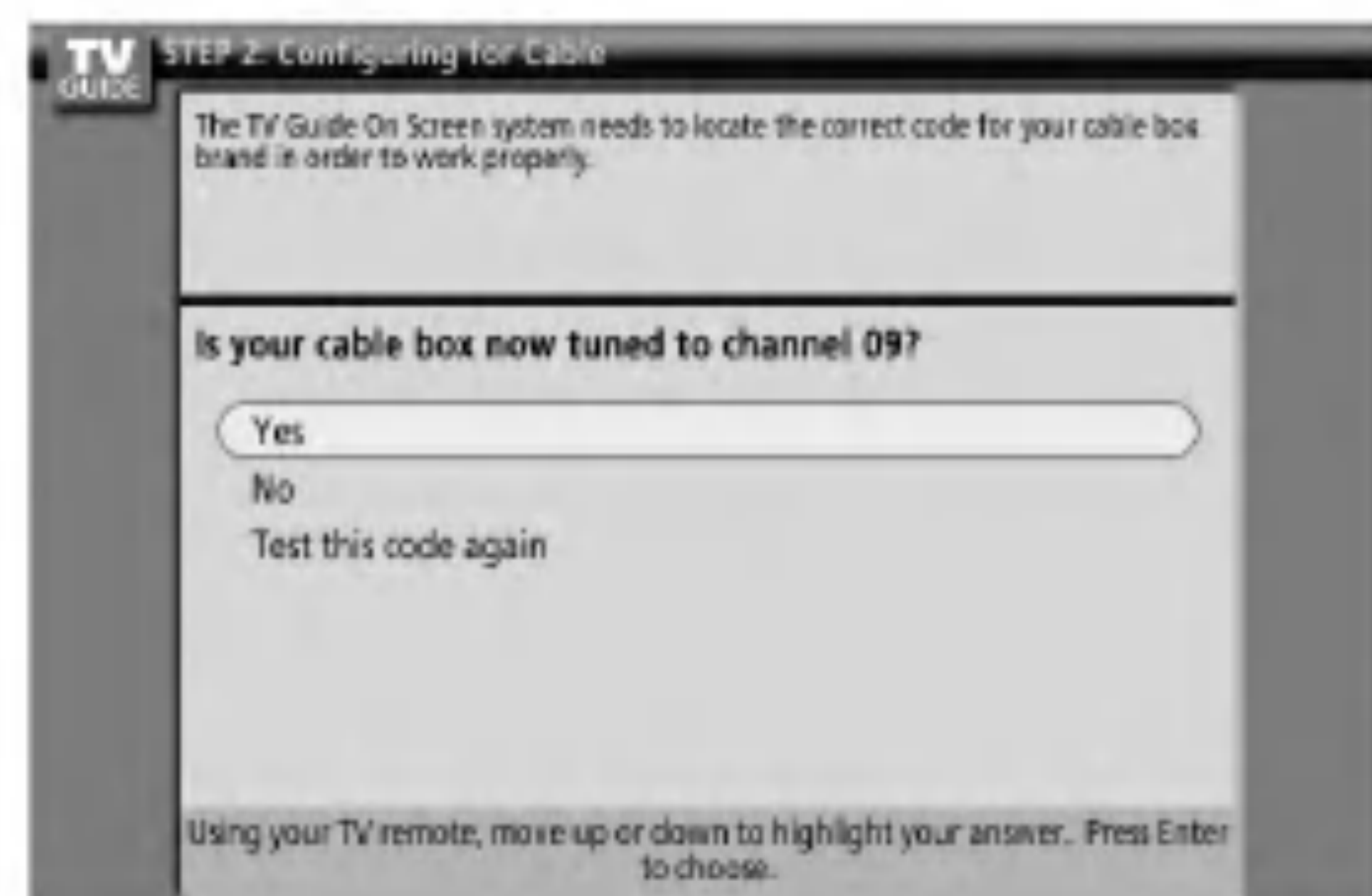

12 Screen 12: Do you have an antenna connected?

- If you select Yes, you see Screen 13.

- If you selected No in Screen 3 then you must select Yes in this screen to receive a channel lineup and listings.
- If you select No, you see Screen 13.

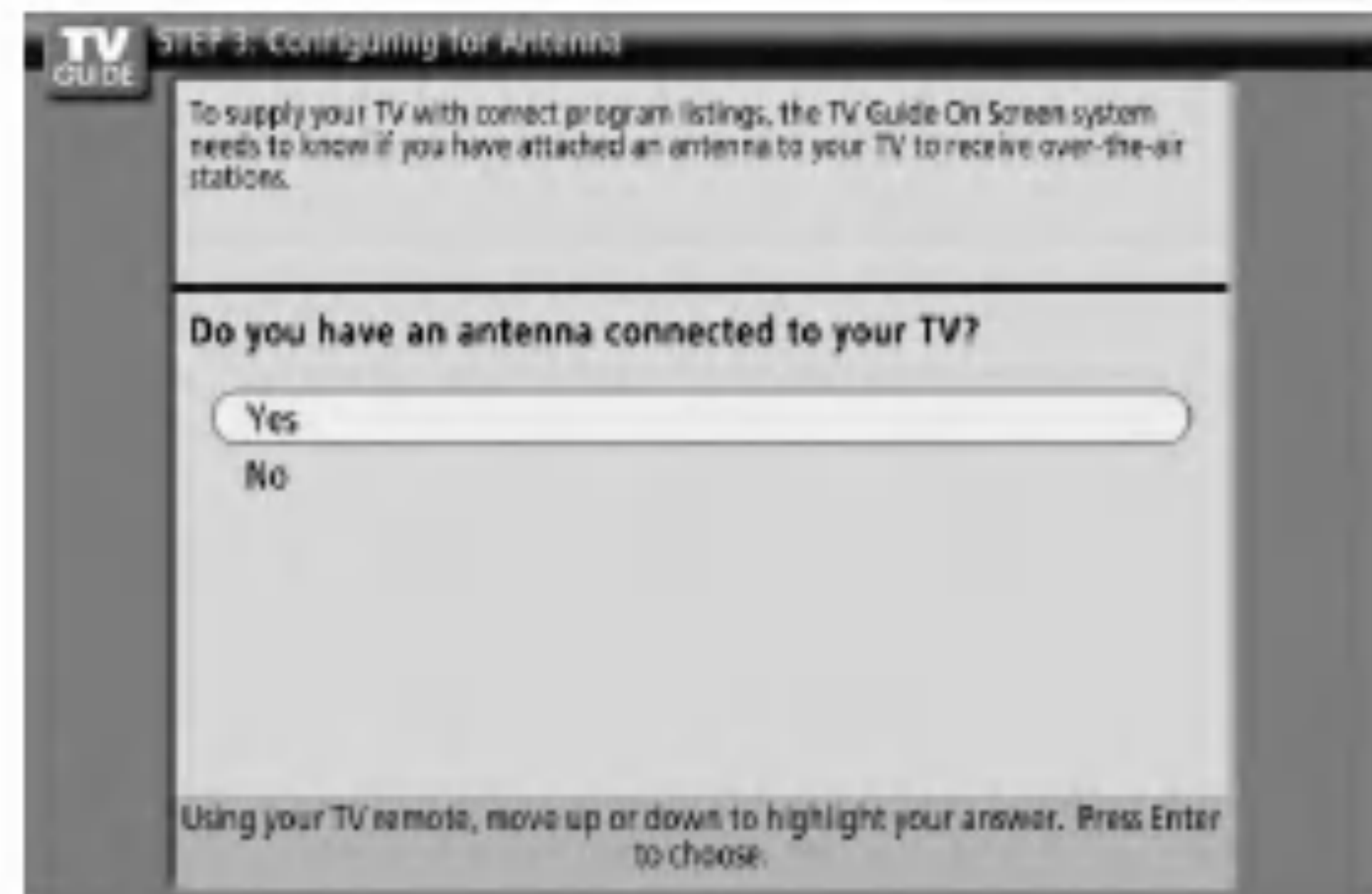

13 Screen 13: Are your basic settings correct?

- If you select Yes, you see Screen 14.
- If you select No, you see Screen 1.

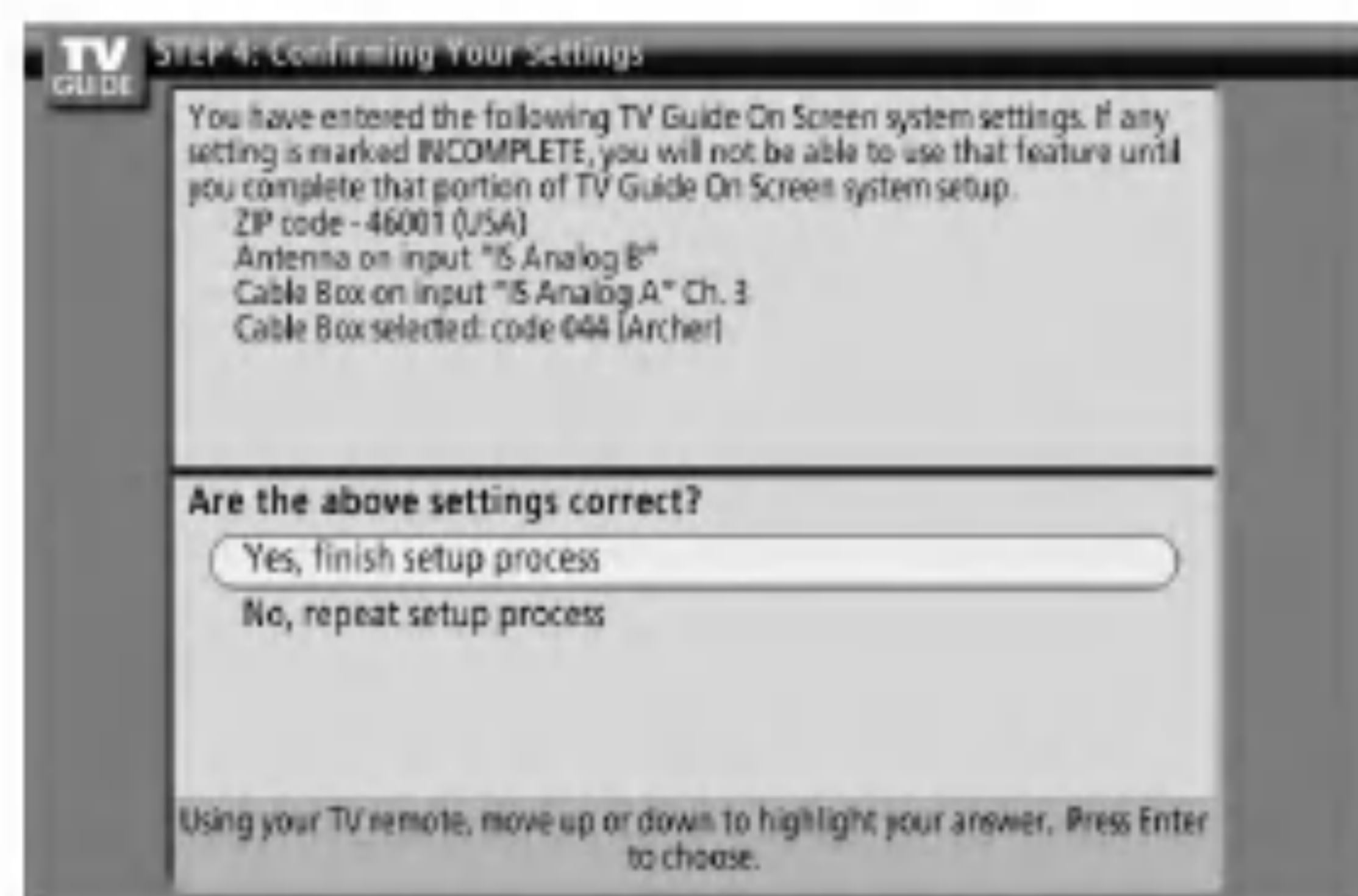

14 Screen 14: Congratulations

- Press ENTER button to display Screen 15.

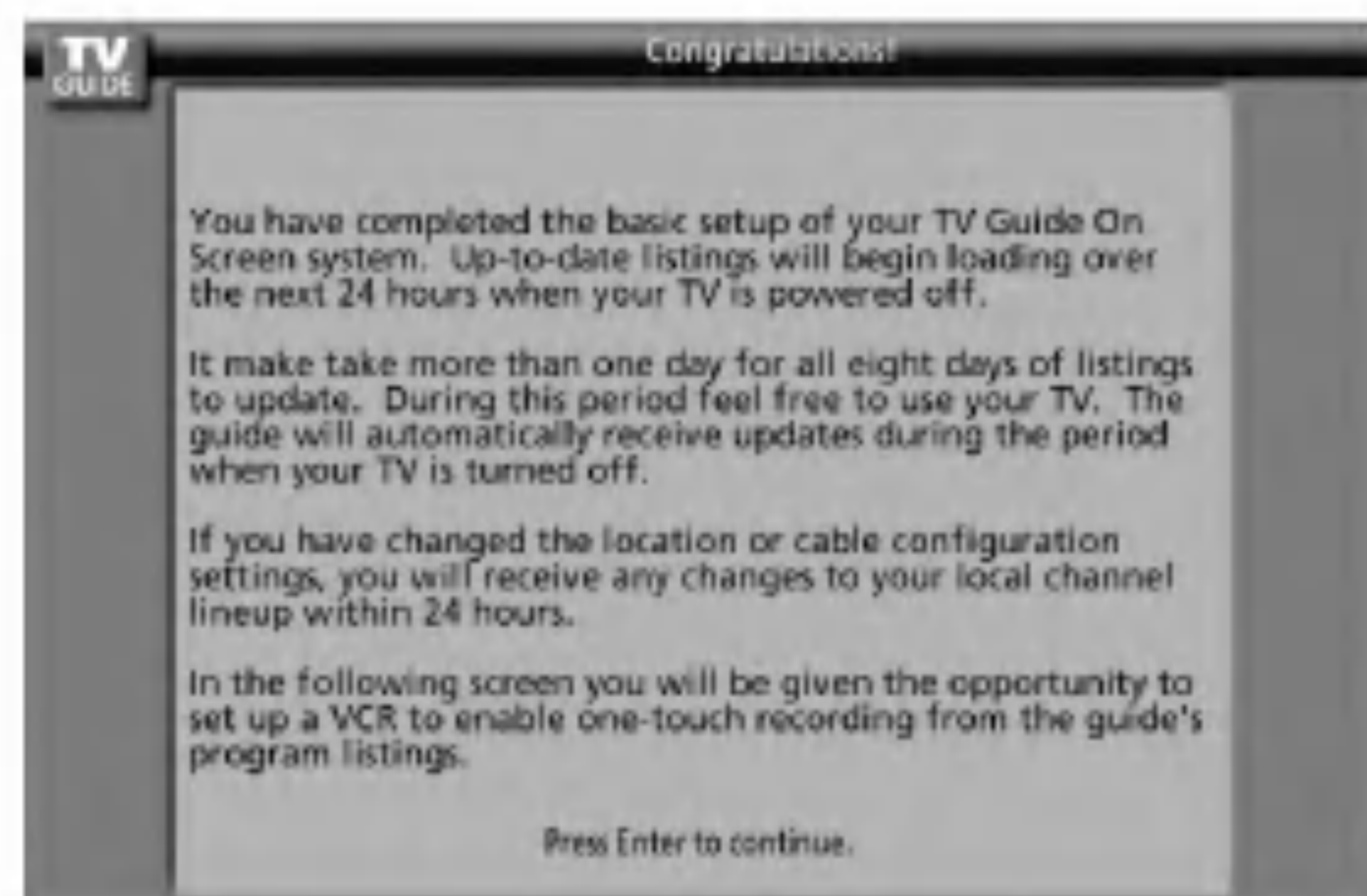

15 Screen 15: Is a VCR Connected?

- If you select Yes, you see Screen 16.
- If you select No, you see Screen 21.

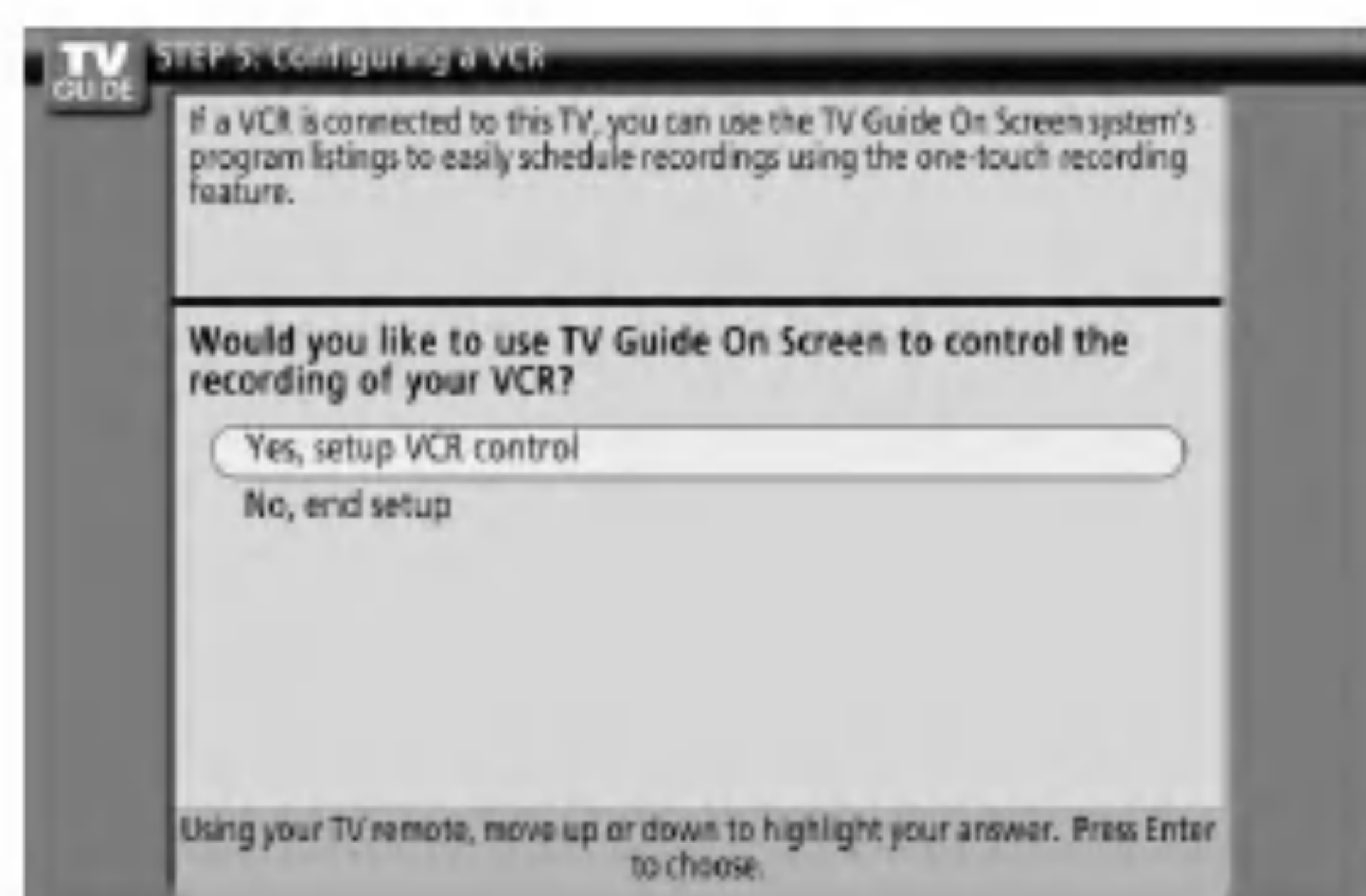

16 Screen 16: VCR Configuration Diagram

- This screen shows the correct way to install the G-LINK™ Cable from the back of the TV to the Recording device.
- **Make sure the G-LINK™ Cable is properly installed.**
- Press **ENTER** button, and you see Screen 17.

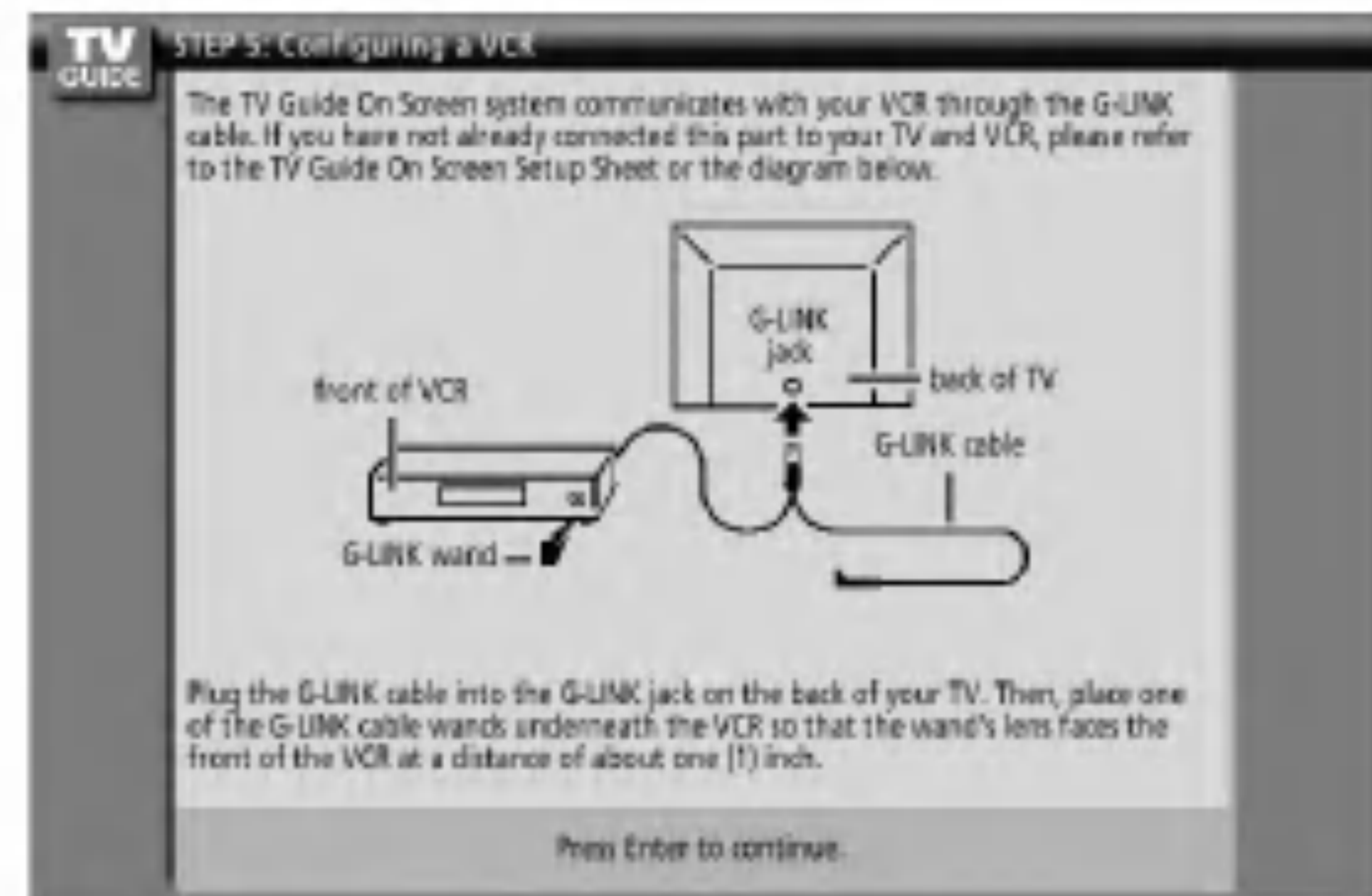

17 Screen 17: VCR Brand Name

- Use the **▲ / ▼** button to select the brand of the recording device.
- Press **ENTER** button, and you see Screen 18.

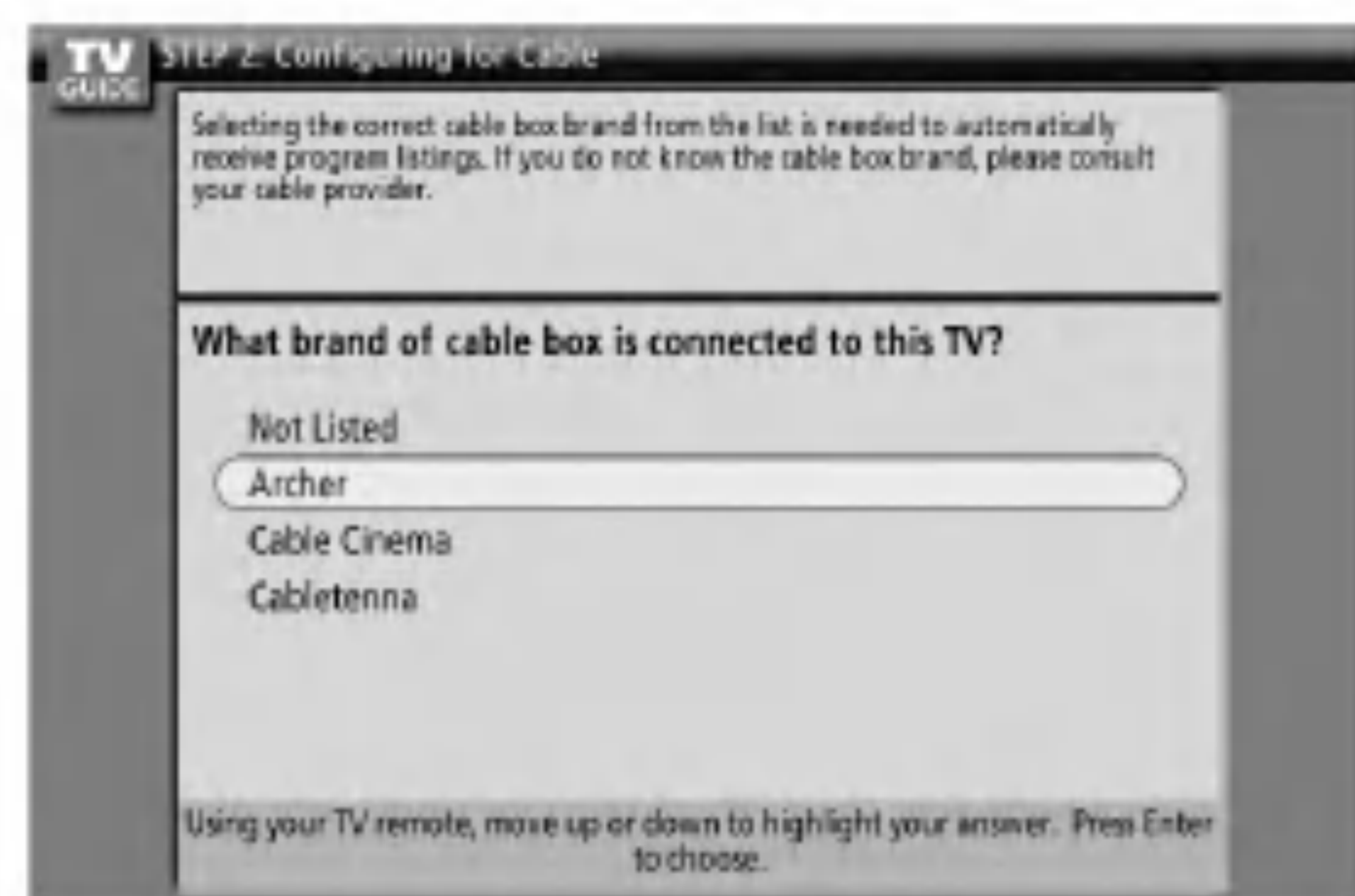

18 Screen 18: VCR Preparation

- Follow the on-screen instructions, and press **ENTER** button to display Screen 19.

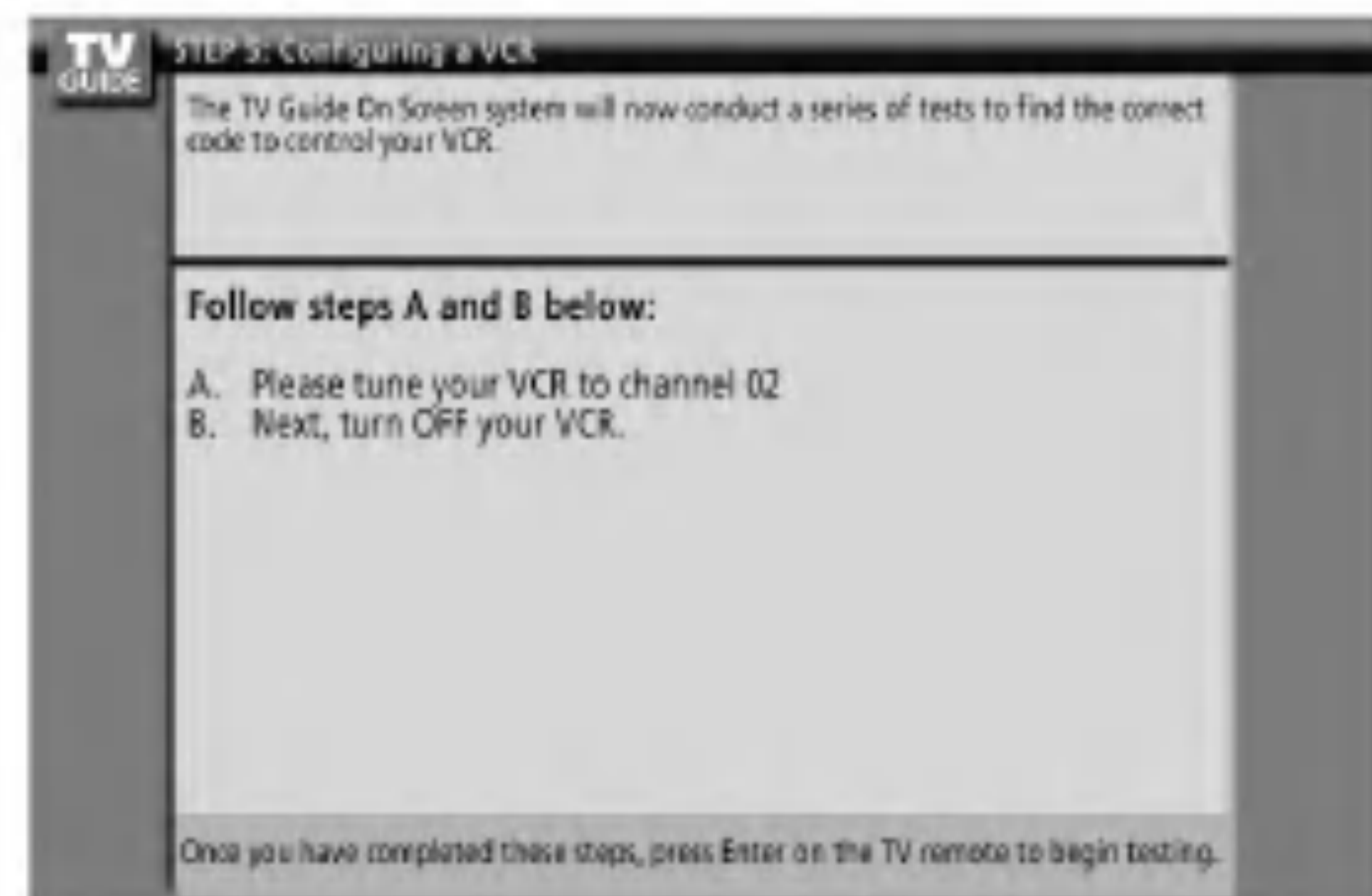

19 Screen 19: VCR Code Testing

- When testing is done, Screen 20 displays automatically.



20 Screen 20: VCR Tuned to Channel 9?

- If you select Yes, you see Screen 21.
- If you select No, a different code is tested in Screen 19.

- Many VCRs require testing more than one code.
 - If you select Test this code again, the same code is tested again in Screen 19.

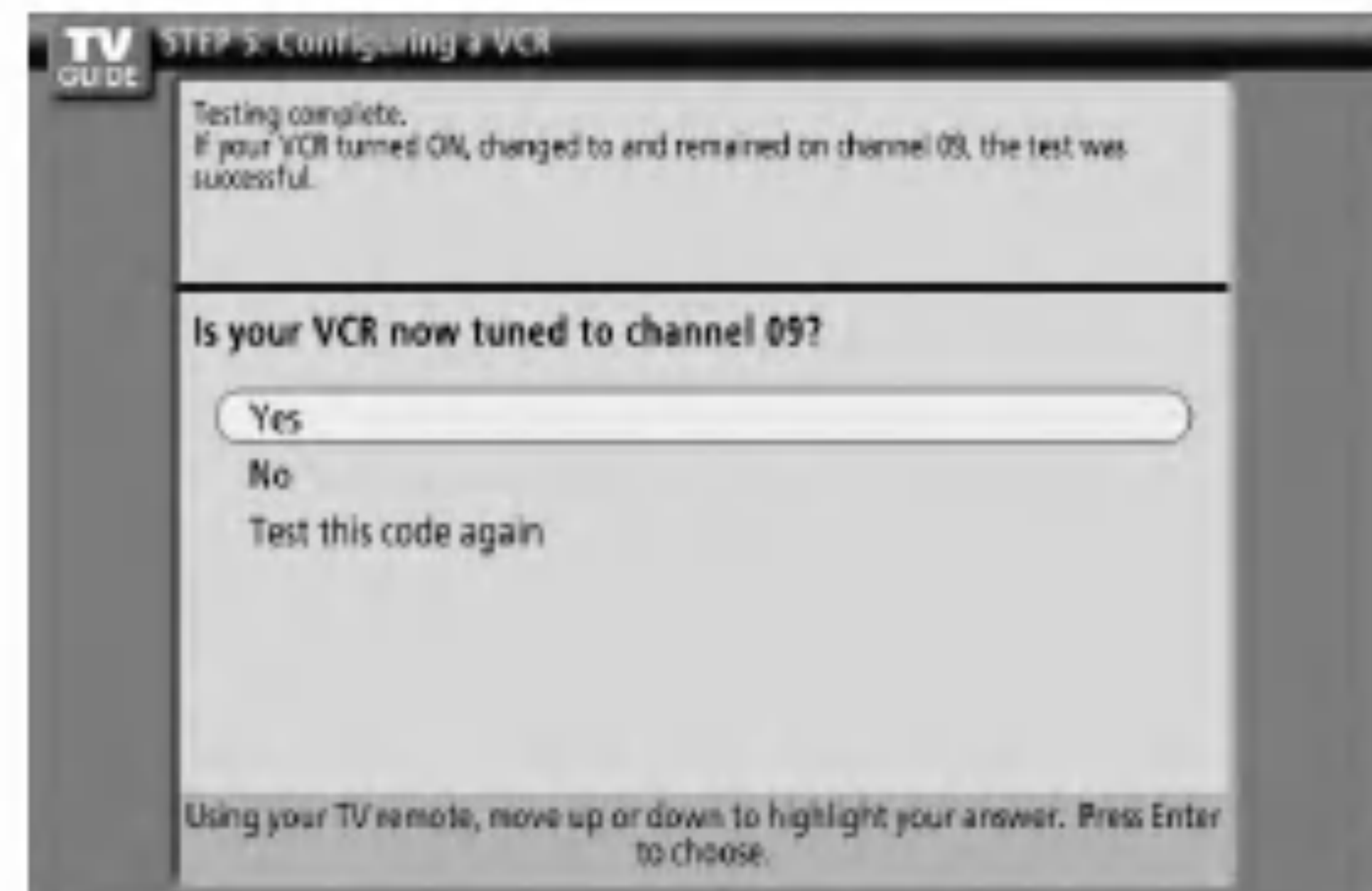

21 Screen 21: Confirming Your Settings

- Verify the Setup information is correct.
- If it is, select Yes, end setup, and you see Screen 22.
- If it is not, select No, repeat setup process, and you see Screen 1.

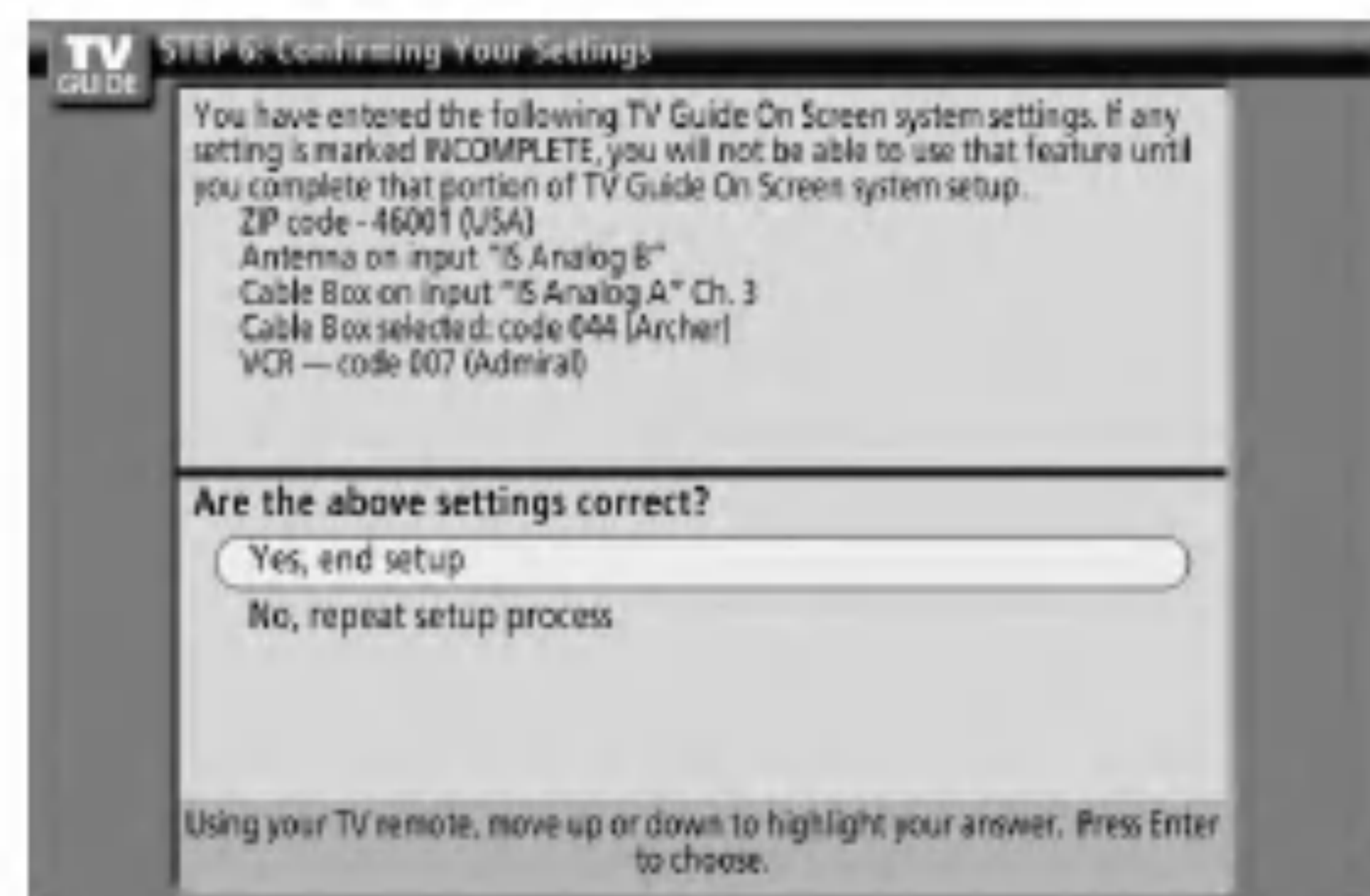

22 Screen 22: Congratulations

- You have successfully completed Setup!
- Press **ENTER** button and you see Screen 23.

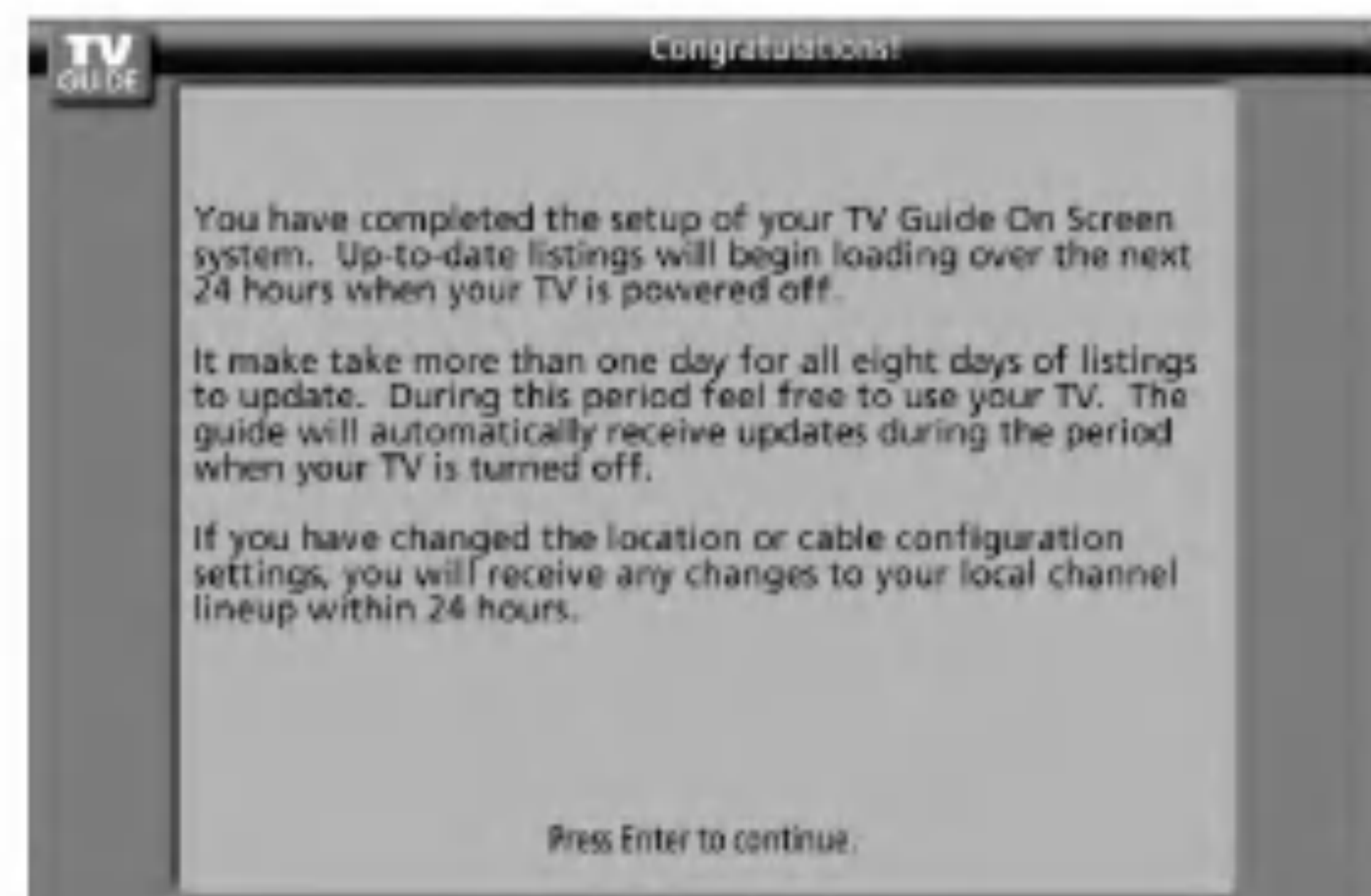

23 Screen 23: Helpful Information

- This screen tells you valuable information on using your Guide.
- Press **ENTER** button to watch TV.

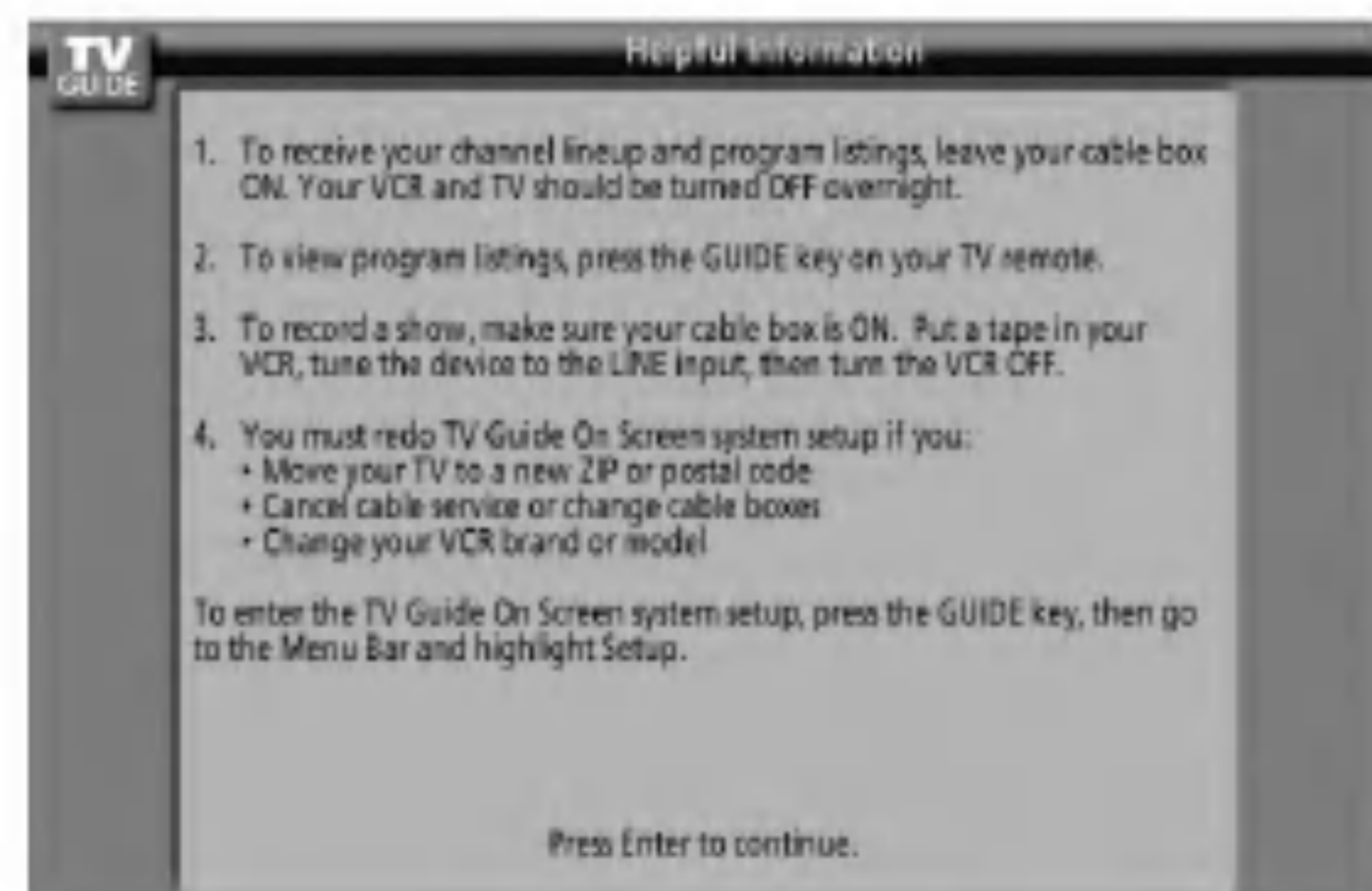

TV Guide On Screen™ System Feature

- Your new TV contains the TV Guide On Screen Interactive Program Guide.
- The TV Guide On Screen system has features that help you get the most out of your viewing experience.

TV Guide On Screen Overview

- The TV Guide On Screen system has the following features:
 - Eight days of show listings (today plus seven days).
 - Icons that indicate show rating, stereo, HDTV, new episode, etc.
 - Intuitive up/down/left/right navigation using your remote control.
 - Set shows to Record.
 - Schedule show Reminders.
 - Search shows by category (e.g., Movies, Sports, Children, etc.).
 - Search for shows based on keywords or alphabetically by title.
 - Direct tuning to a channel.
 - Show information while watching TV.
 - Streamlined System Setup and default setting options.
 - Channel lineup customization.
 - Help screens while in the Guide.

Screen Components

- The screens displayed in the TV Guide On Screen system share many of the same components, as shown in the following figure:

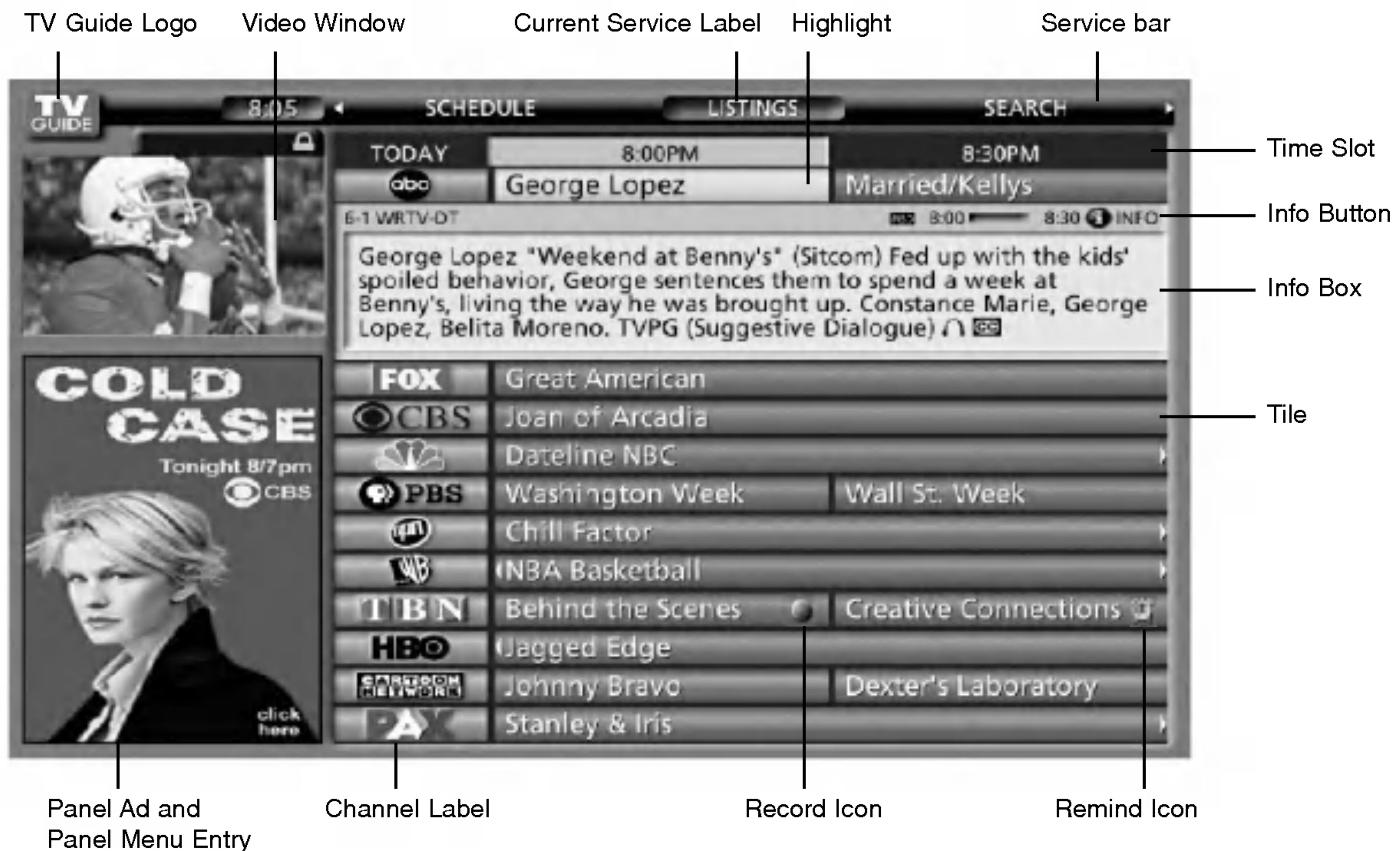

- **Video Window**- displays TV video while the Guide is displayed.
- **Service Bar**- provides access to the 4 main Guide Services.
- **Current Service Label**- indented to indicate current Service displayed.
- **Tile**- displays show title
- **Highlight**- indicates an active tile
- **INFO Box**- provides information for a highlighted item
- **INFO Button**- cycles through the various Info Box sizes
- **Channel Logo**- identifies network
- **Record/Remind Icons**- indicates a show is set to Record or set as a Reminder
- **Panel Ad**- location where show- or product-specific information appears (and also where Panel Menu appears)

Panel Menu



- A Panel Menu appears when the Menu key is pressed on a highlighted tile and additional options are available. It also appears when you press **ENTER** button on a show starting in the future.
- When a Panel Menu appears, the highlighted tile changes color to indicate the Panel Menu relates to this tile.
- The Panel Menu displays below the Video Window.
- Help is available for a displayed Panel Menu by pressing the **INFO** button.
- The **▲ / ▼** button move between the options within the Panel Menu.
- The left and right arrows move to adjacent options unless the highlight is on an odometer, where these arrows change the odometer choice.
- Pressing **ENTER** button from an odometer or number entry box moves the highlight to the default command button of that Panel Menu, for example, Schedule Reminder.
- Pressing **ENTER** button from a highlighted command button executes the action and closes the Panel Menu (e.g., Schedule Reminder, Cancel).
- Select Cancel to cancel any changes and press **ENTER** button to close this menu.
- Pressing Menu is a shortcut to Cancel. Press Menu to cancel any changes and close the menu.
- If a Panel Menu contains more menu options than can be displayed on a single screen, **▲ / ▼** button appear at the top or bottom of a menu. Simply scroll down to access these options.

Main Services

Listings

- Access Listings by pressing the TV Guide button on your remote or on the front panel of your TV.
- Listings is always the first Service displayed in the Guide.
- With Listings highlighted, press the Info button to display a Help screen. Press the Info button again to close the screen.

Use the ▲ / ▼ / ◀ / ▶ button to move the highlight within Listings to:

- View 8 days of show listings
- Read show descriptions
- Tune directly to a show currently airing
- Set a show to Remind
- Set a show to Record
- Lock and unlock the Video Window
- Access Panel and Channel Ads

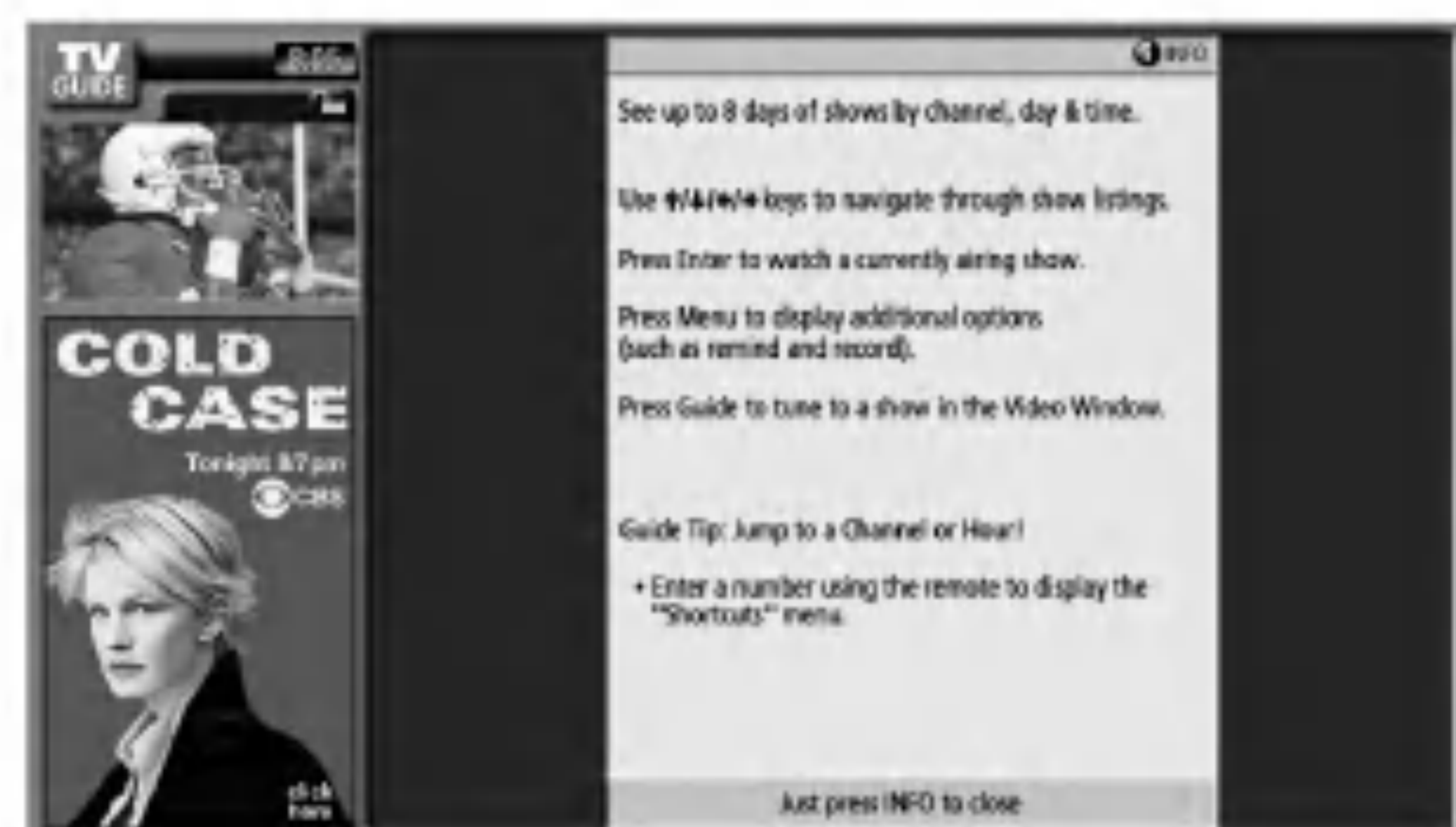

- There may be times when the TV Guide On Screen system could display partial or no program listings. The reasons for this include:

1. Program schedule information was not provided to TV Guide On Screen.
2. The transmission of the program listings was interrupted.
3. The phrase "No Listings" will be replaced with program information during the next transmission, which should occur within the next 24 hours.
4. Please remember to turn off your TV when not in use in order to receive program listings.



Search

- Search lets you find shows by category (Alphabetical, Movies, Sports, Children, Educational, News, Variety, Series, HDTV) or by Keyword.
- With Search highlighted, press the **INFO** button to display a Help screen. Press the **INFO** button again to close the screen.

• **Category Search Example: Movies**

1. From Search, use the ▼ button to highlight Movies.

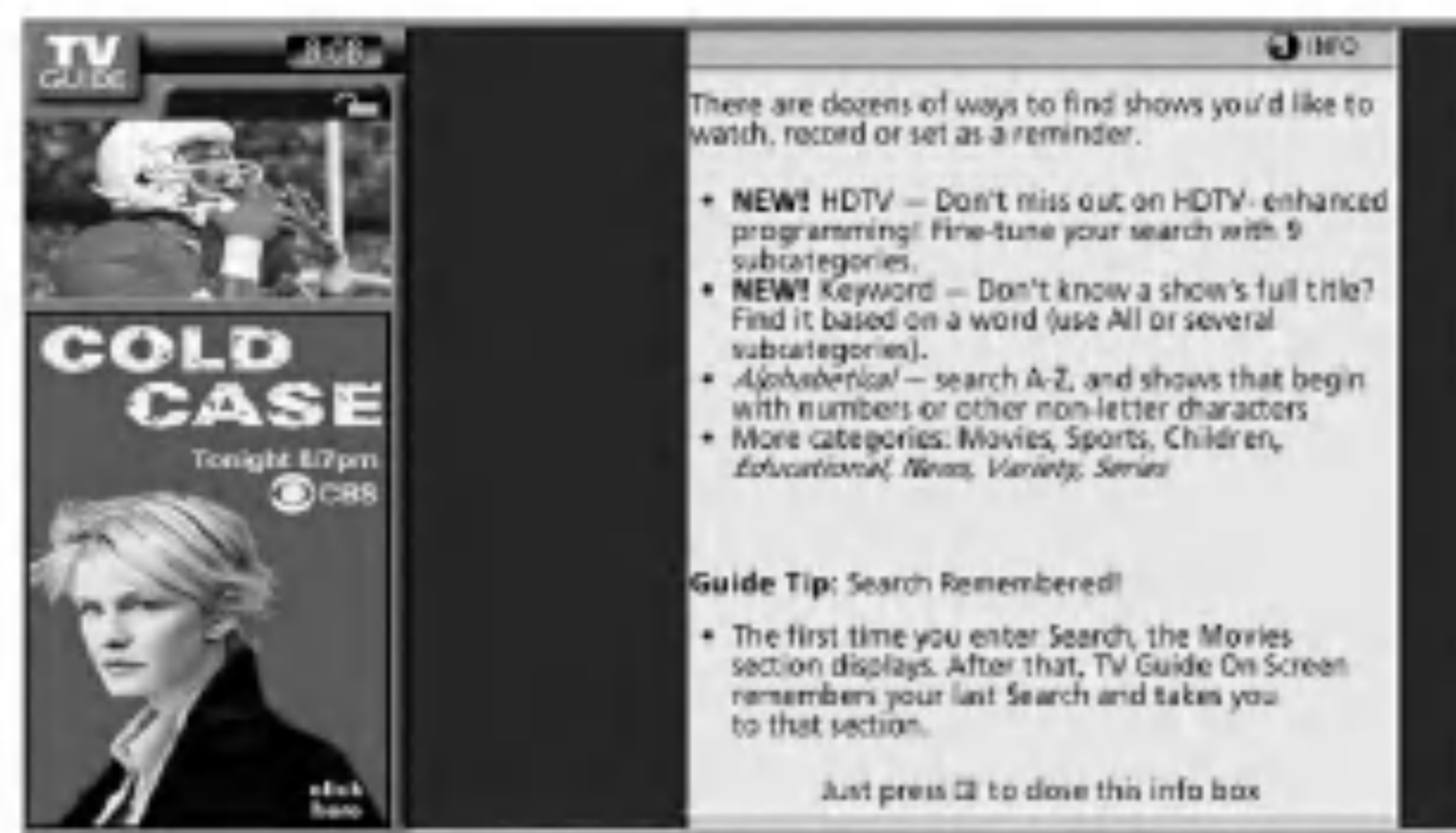

2. Use the ▼ button to highlight a subcategory (for example, All).
3. Press ENTER button to display a list of all Movies, organized by date and time.



4. Highlight a show and press ENTER button to watch (if on now) or the MENU button to display the Episode Options menu.



You can choose to set a recording, a reminder, or tune to the channel.

Go to Service Bar- closes the menu, changes no information, and returns to the Search Service Bar.

Tune to Channel- exits the Guide and tunes to the channel of the highlighted show (show airs in the future). * Note: This option reads Watch Now if the show is currently airing.

Set Recording- displays the Record Options menu, from which you can set frequency, start and end time, etc.

Set Reminder- displays the Remind Options menu, from which you can set frequency, when, automatically power On, and auto-tune the TV.

Cancel- closes the menu, changes no information, and returns to the highlighted show.



• **Keyword Search**

- Keyword search lets you enter a word(s) to look for a particular show by category or for every show title that matches.

1. Highlight the Keyword navigation label, and press **ENTER** button to display the Keyword Search menu.
2. Highlight New Search, and press **ENTER** button.



3. The Search Options menu is displayed.
4. Highlight Category, and use the ◀ / ▶ button to select a category to search (e.g. All, HDTV, Children, Sports, etc.). When finished, use the ▼ button to highlight Enter Keyword.
5. Highlight Enter Keyword, and press **ENTER** button. Then the keyboard is displayed.



6. Use the ▲ / ▼ / ◀ / ▶ button to highlight a character, and press **ENTER** button to display it. When complete, highlight Done and press **ENTER** button.

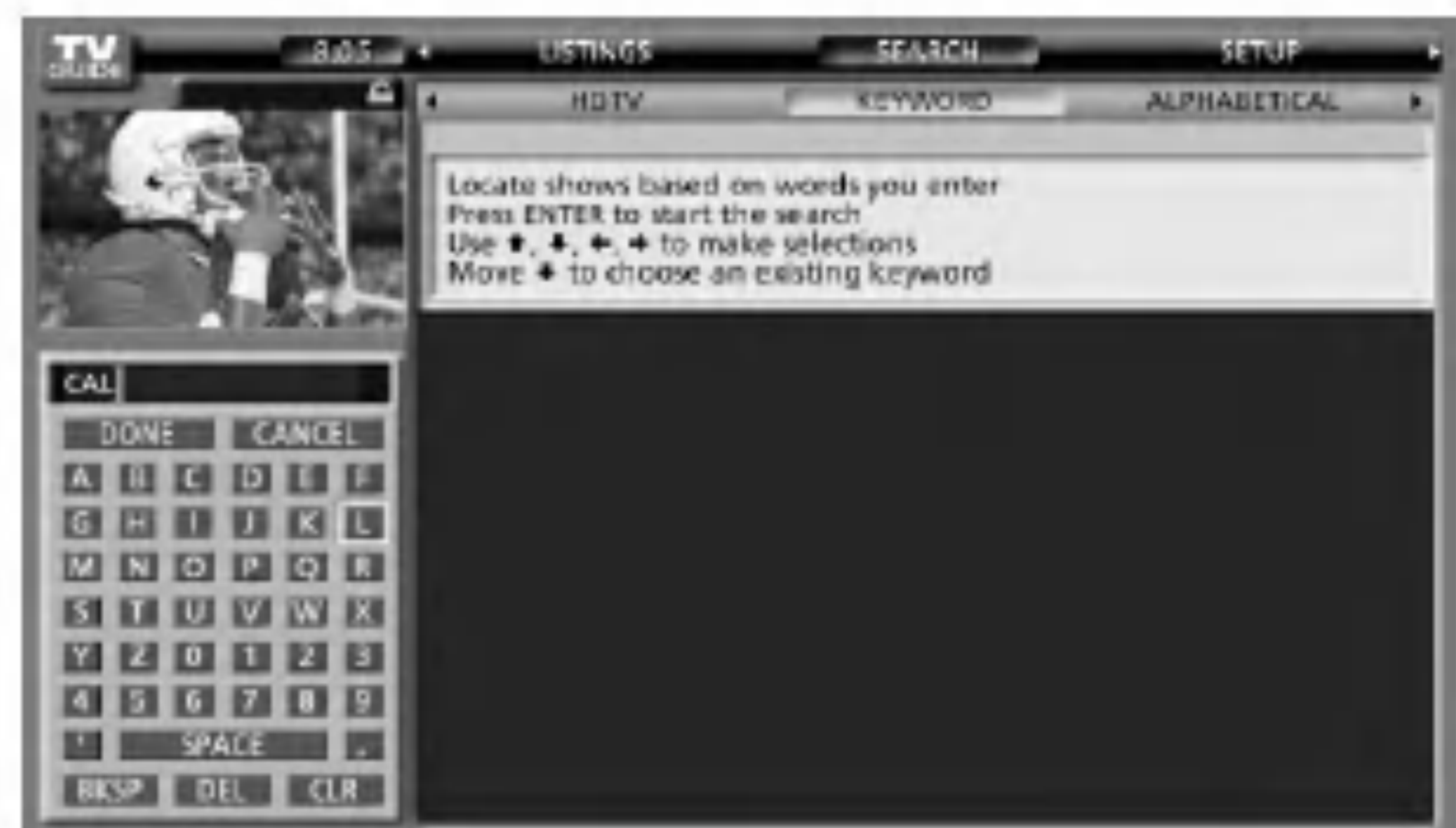

7. A list of all matching shows for that keyword is displayed.

You can highlight a show, and press **ENTER** button to display all airings. You can then highlight a specific listing and press **ENTER** button to watch (if On now) or the **MENU** button to display the Episode Options menu.

From the Episode Options menu, choose to set a recording, a reminder, or tune to the channel, as previously described.



The TV Guide On Screen system stores all the keywords you create. To edit or delete a keyword, highlight the keyword and press the **MENU** button. A Search Options menu is displayed.

Go to Service Bar- closes the menu, changes no information, and returns to the Search Service Bar.

Edit Search- displays the keyboard, where you can change the keyword.

Delete Search- A Confirm menu is displayed.

- Yes- deletes the Search
- No- closes the panel menu



Cancel- closes the menu, changes no information, and returns to the highlighted show.



Schedule



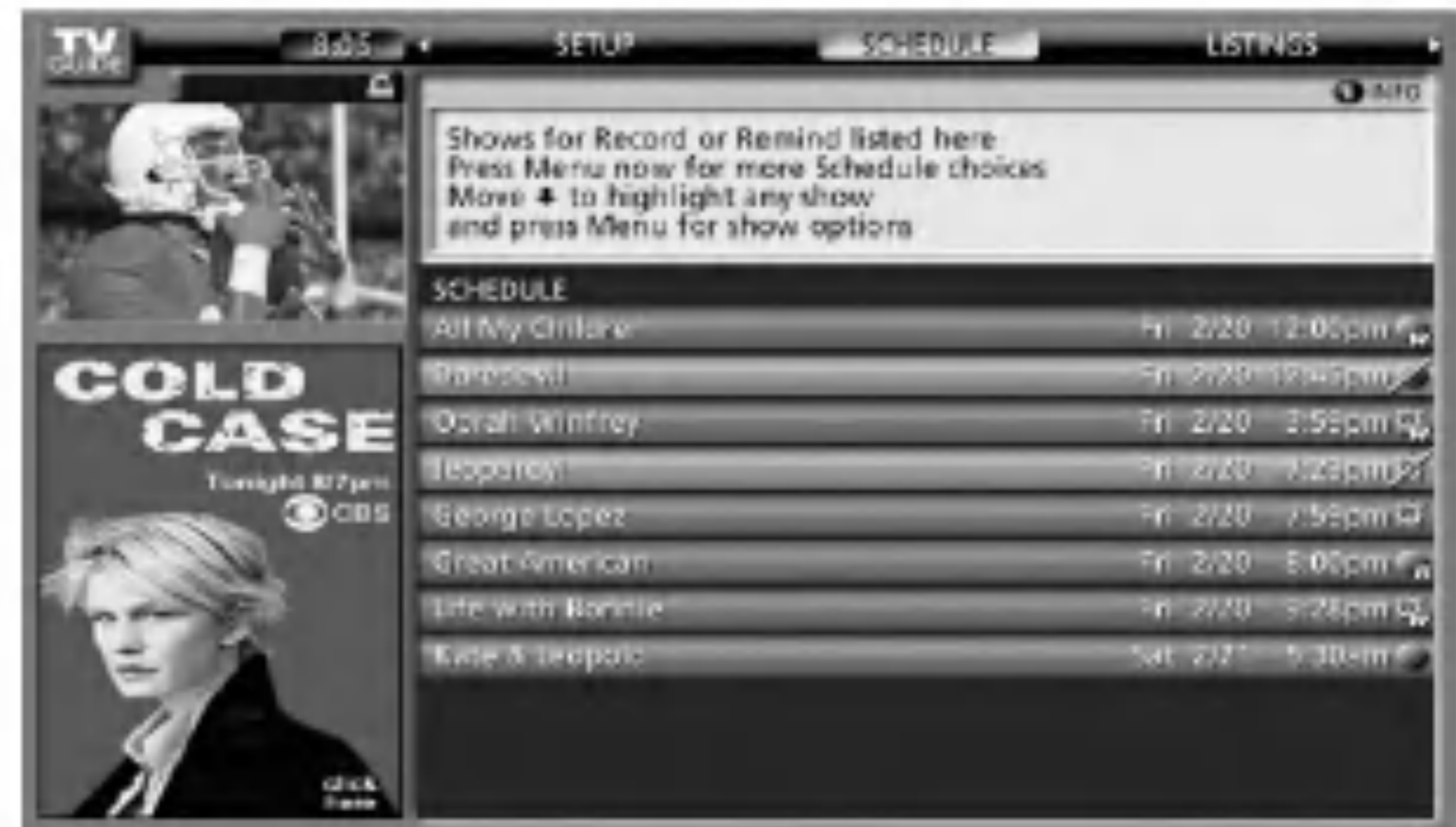

- Schedule lets you review, edit, or delete Record and Remind events that you set previously.
- With Schedule highlighted, press the **INFO** button to display a Help screen. Press the **INFO** button again to close the screen.
- An icon identifies the event type:

Record

Once 	Records the show one time.
Regularly 	Records the show every time the show airs on the same channel and starts at the same time.
Daily 	Records the show every time the show airs on the same channel and starts at the same time.
Weekly 	Records the show each time the show airs on the same day of the week, on the same channel and starts at the same time.
Off 	Keeps the show in the list but will not record this show until the frequency is changed.



Remind

Once 	Sets a show reminder one time.
Regularly 	Sets a show reminder every time the show airs on the same channel and starts at the same time.
Daily 	Sets a show reminder every time the show airs on the same channel and starts at the same time.
Weekly 	Sets a show reminder each time the show airs on the same day of the week, on the same channel and starts at the same time.
Off 	Keeps the show in the list but will not remind until the frequency is changed.



Highlight an event, and press the Menu key for options.

Go to Service Bar- Closes the menu, changes no information, and returns to the Schedule Service Bar.

Tune to channel- Exits the TV Guide On Screen system and tunes to the highlighted show.

Delete Recording- Removes the recording from the Schedule, after a Confirm screen.

Edit Recording- Opens a menu from which you can change existing recording information.

Set Reminder- Opens a menu from which you can set a Reminder for the show (Record is not cancelled).

Cancel- Closes the menu, changes no information, and returns to the highlighted show.



Setup

- After you initially complete Guide Setup, you can make changes to Guide settings in the following areas:

- **Change System Settings**
- **Change Channel Display**
- **Change Default Options**

Highlight a choice, press **ENTER** button, and follow the on-screen instructions.

With Setup highlighted, press the **INFO** button to display a Help screen. Press the **INFO** button again to close the screen.

• **Change System Settings**

This option appears after you have completed the initial Guide Setup process.

Press **ENTER** button to display the Confirming Your Settings screen. You see your current settings.

Choose one of the options, press **ENTER** button, and follow the on-screen instructions.

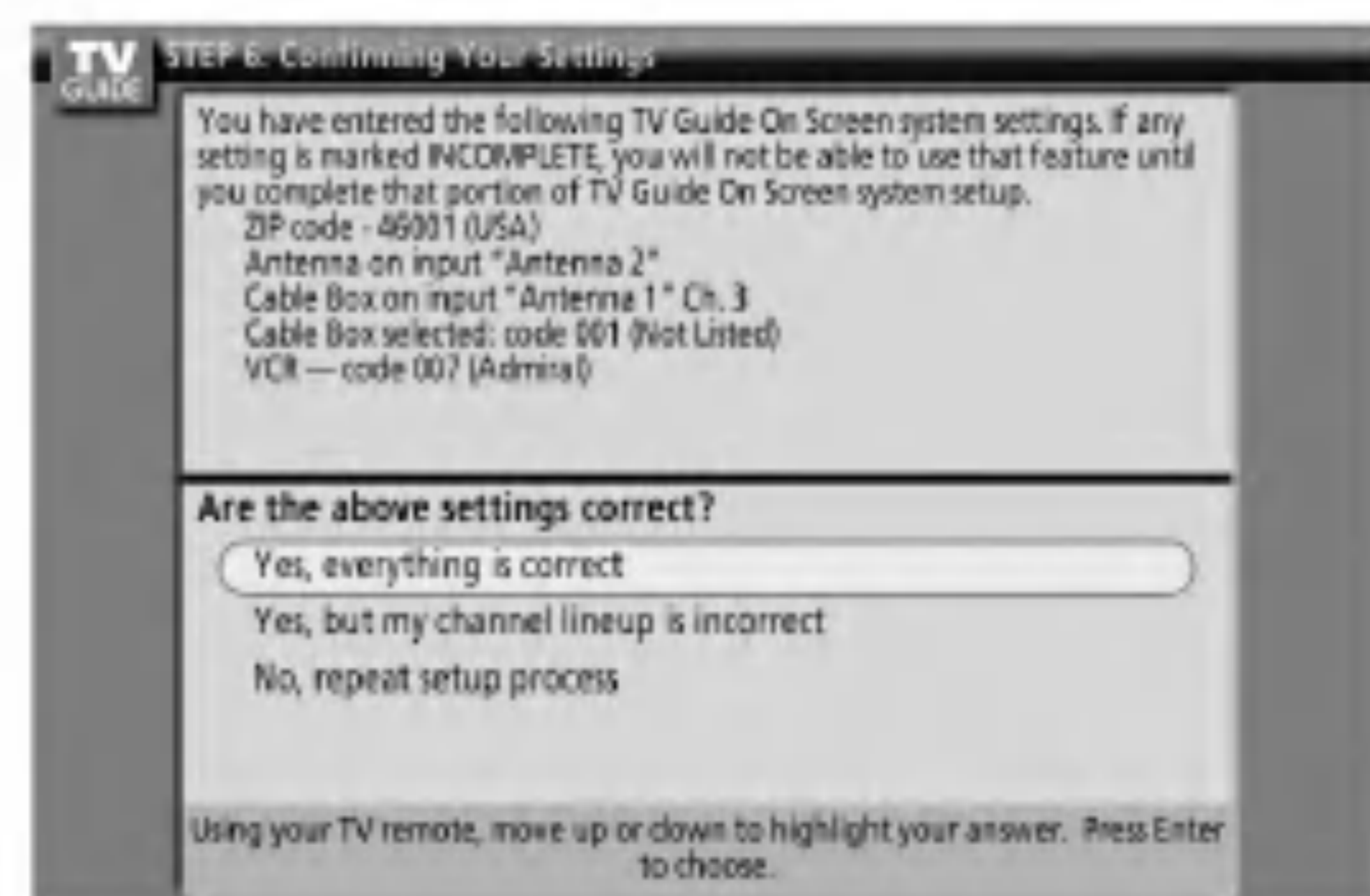
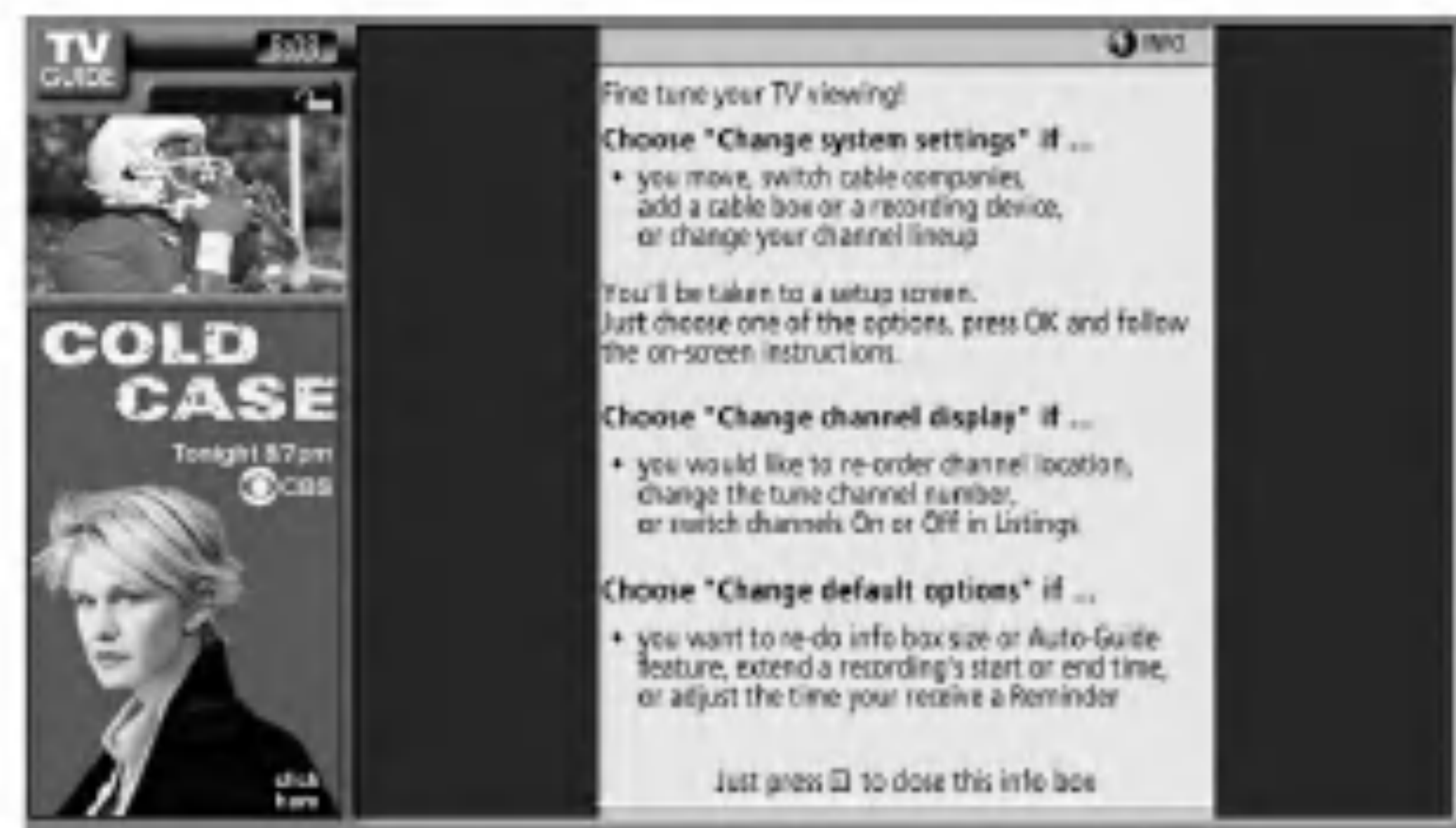

• **Change Channel Display**

Change Channel Display lets you edit channel information that appears in Listings. With Change Channel Display you can :

- Re-order the position of the channel in Listings
- Change the tune channel number
- Switch a channel
 - : On - the channel is always displayed
 - : Off - the channel is never displayed
 - : Auto-Hide - the channel is only displayed when program information is available.

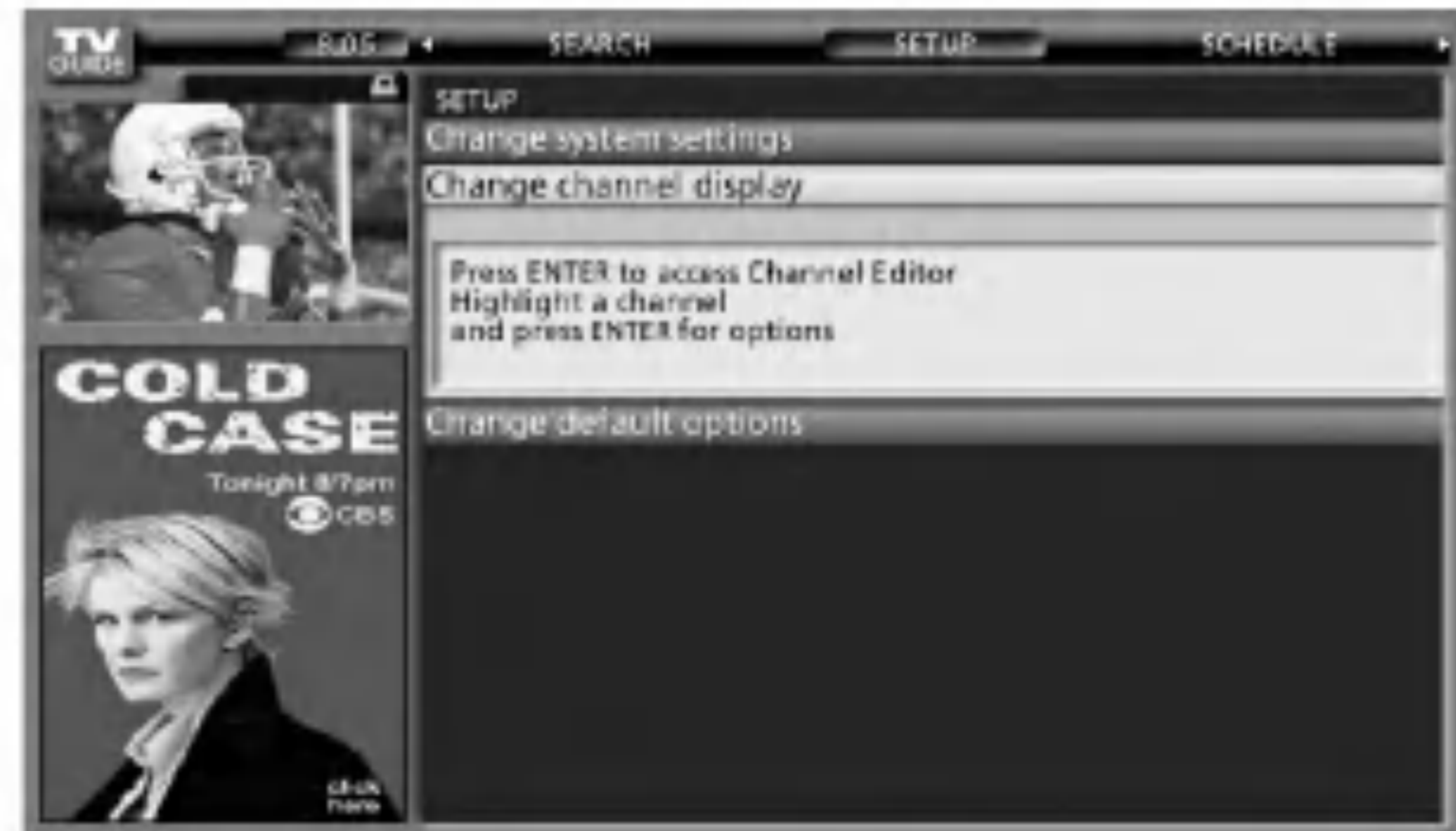

Press **ENTER** button to display the Channel Editor screen.

Then, highlight a channel and press **MENU** button. A Grid Options menu is displayed.

Highlight Go Back to Setup to close the menu, change no information, and return to the Setup Service Bar.

Or make changes and when finished, press **ENTER** button to highlight Done. Press **ENTER** button again to close the menu and accept the changes.

Highlight Cancel to close the menu, change no information, and return to the highlighted channel.



• Change Default Options

Change Default Options lets you change default settings in the following categories:

- 1) General Default Options
- 2) Record Defaults
- 3) Remind Defaults

Highlight Change Default Options, and press **ENTER** button.



1) General Default Options

General Default Options lets you set defaults for the following:

- The initial Info Box size when the TV Guide On Screen system is entered. Choices are No, Small, Large, and Last Used (Default = Last Used).
- The Info Box size rotation when the **INFO** button is pressed while in the TV Guide On Screen system. Choices are No only, Small only, Large only, No & Small, No & Large, Small & Large, All (Default = All)
- Automatic entry into the TV Guide On Screen system (Auto-Guide) when the TV is powered On. Choices are On and Off (Default = On). Highlight General Default Options, and press the Menu key to display the General Default Options menu.

Highlight Go to Service Bar to close the menu, change no information, and return to the Setup Service Bar.

When finished, press **ENTER** button to highlight Done. Press **ENTER** button again to close the menu and accept the changes.

Highlight Cancel to close the menu, change no information, and return to the highlighted option.



2) Record Defaults

Record Default Options lets you set defaults for the following:

- When to start the record event. Choices are 120 minutes early to 120 minutes late, to On time. (Default = On time)
- When to end the record event. Choices are 120 minutes early to 120 minutes late, to On time. (Default = On time)
- Recorder choice: Please choose the VCR only. This TV does not provide other devices with a recording feature.

Highlight Record Defaults, and press the **MENU** button to display the Record Default Options menu.

Highlight Go to Service Bar to close the menu, change no information, and return to the Setup Service Bar.



3) Remind Defaults

Remind Default Options lets you set defaults for the following:

- Power On the TV, if Off, when a Reminder is scheduled. Choices are Yes and No. (Default = No)
- Automatically tune the TV to the channel (TV must be On), when a Reminder is scheduled. Choices are Yes and No. (Default = No)
- When to display the reminder screen. Choices are 30 seconds to 15 minutes early, to 30 seconds to 15 minutes late, to On time. (Default = 1 min early)

Highlight Remind Defaults, and press the Menu key to display the Remind Default Options menu.

Highlight Go to Service Bar to close the menu, change no information, and return to the Setup Service Bar.

When finished, press **ENTER** button to highlight Done. Press **ENTER** button again to close the menu and accept the changes.

Highlight Cancel to close the menu, change no information, and return to the highlighted option.

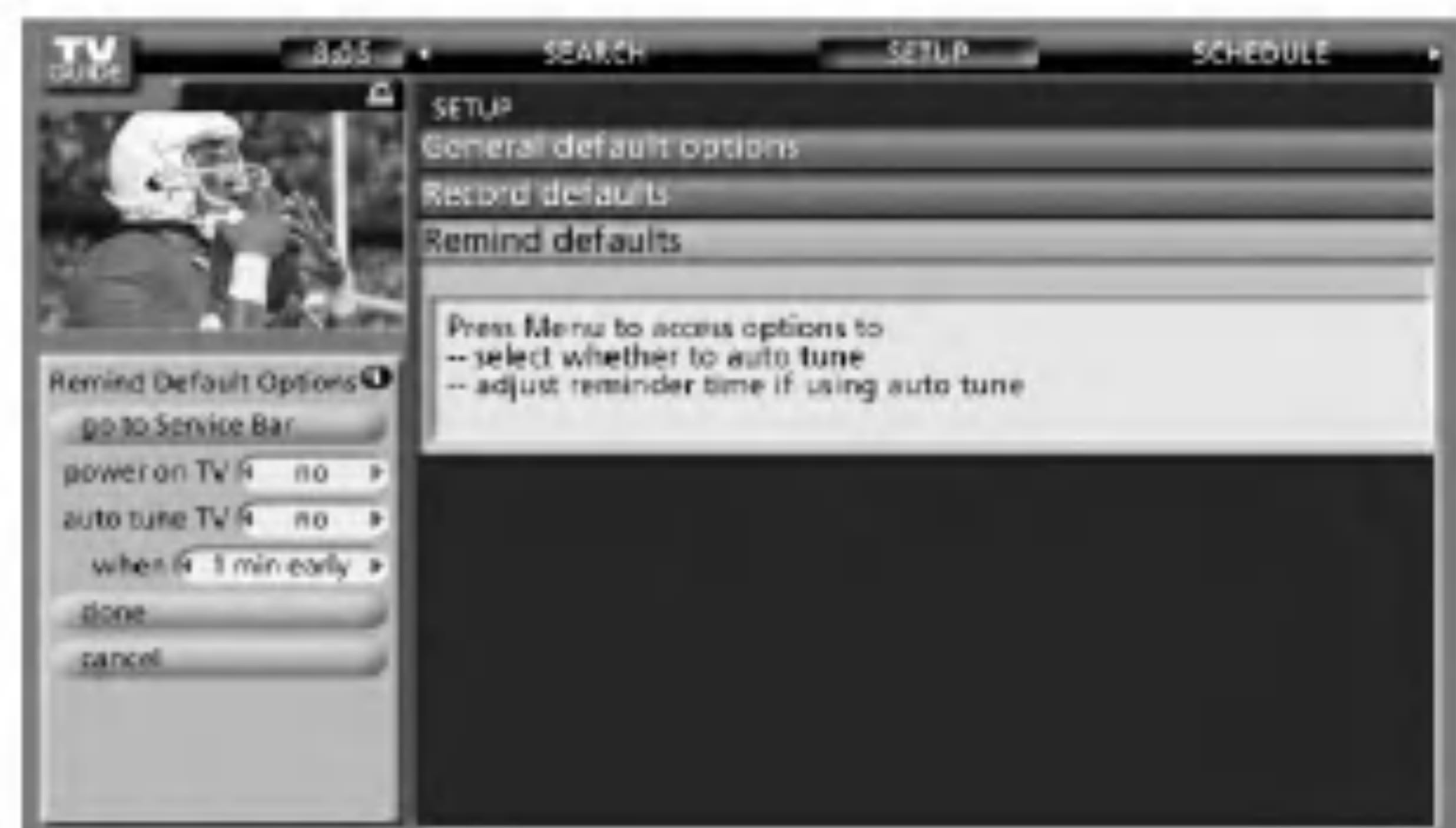
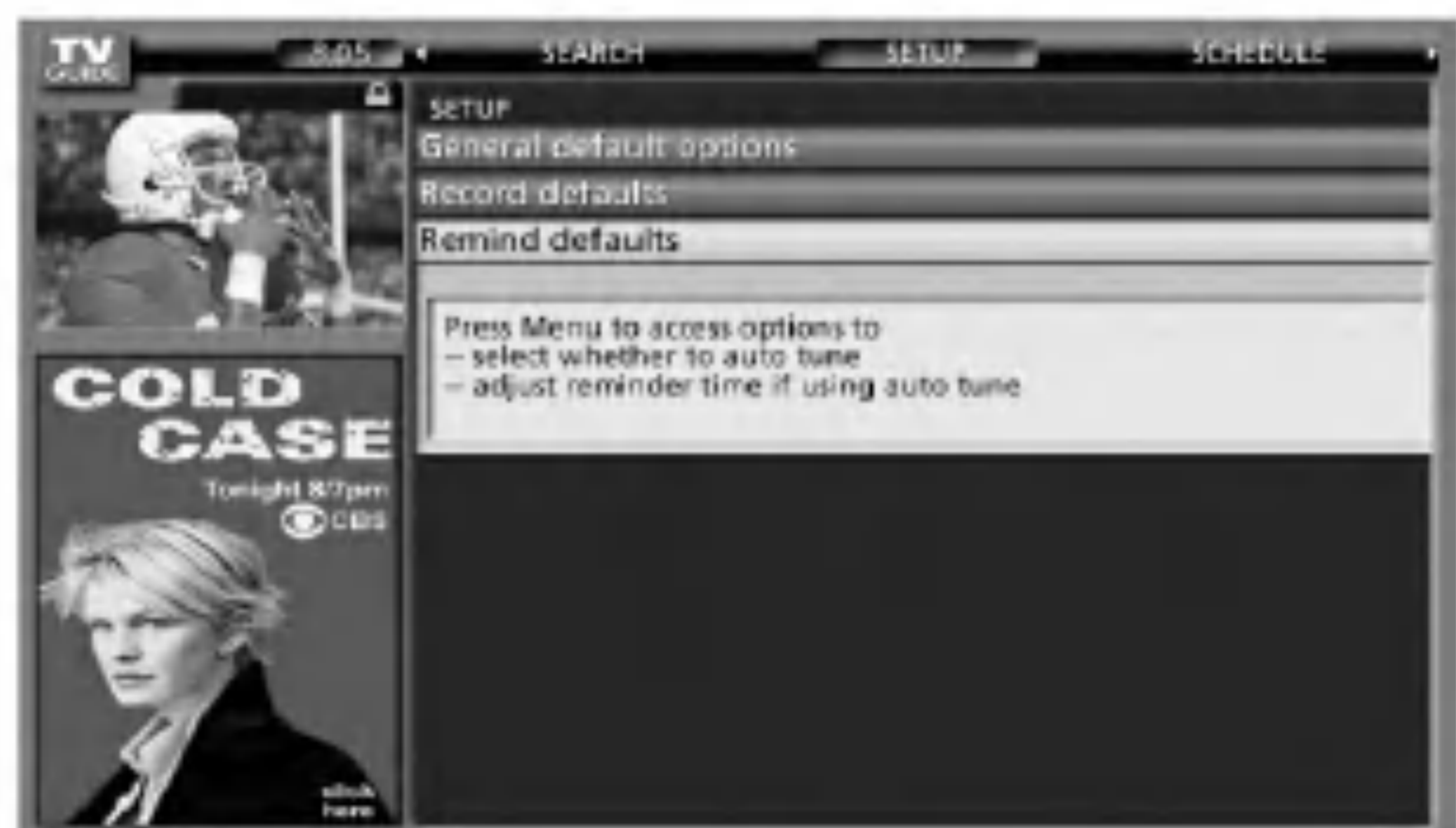

Record And Remind Features





Record

You can set a show to Record in Listings, Search, and Schedule or change Record settings for a show in Schedule. There are 3 ways to set a show to Record:

1) Using the Record Button on the Remote

- Press the **Record** button on the remote to record the show Once with current default settings (Start and End recording On Time). Each time you press the **Record** button, you change the record frequency (but not the default settings) among Once (default), Regularly, Off, Weekly and then Cancel.

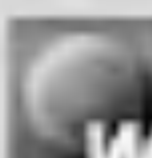
* **Note:** The proper Record icon appears on the show tile, as the **RECORD** button is pressed.

Once 	Records the show one time.
Regularly 	Records the show every time the show airs on the same channel and starts at the same time.
Weekly 	Records the show each time the show airs on the same day of the week, on the same channel and starts at the same time.
Off 	Keeps the show in the list but will not record this show until the frequency is changed.
Cancel (no icon displayed)	Does not record

2) From a Panel Menu

- Highlight a show, and press **MENU** button to display the Episode Options menu.
- Highlight Set Recording, and press **ENTER** button to display the Record Options menu.
- Highlight the Frequency option, and use the left and right arrows to choose among Once, Regularly, Weekly, and Off, as previously described.
- Recorder choice: Please choose the VCR only. This TV does not provide other devices with a recording feature.

* **Note:** Video Window Lock is operated to on or off using **PIP** button in Listings mode.



When finished, press **ENTER** button to highlight Schedule Recording.

Press **ENTER** button again to close the menu. You see a Record icon for the selected frequency next to the show title.

Highlight Cancel to close the menu, change no information, and return to the highlighted show.



3) Manual Recording



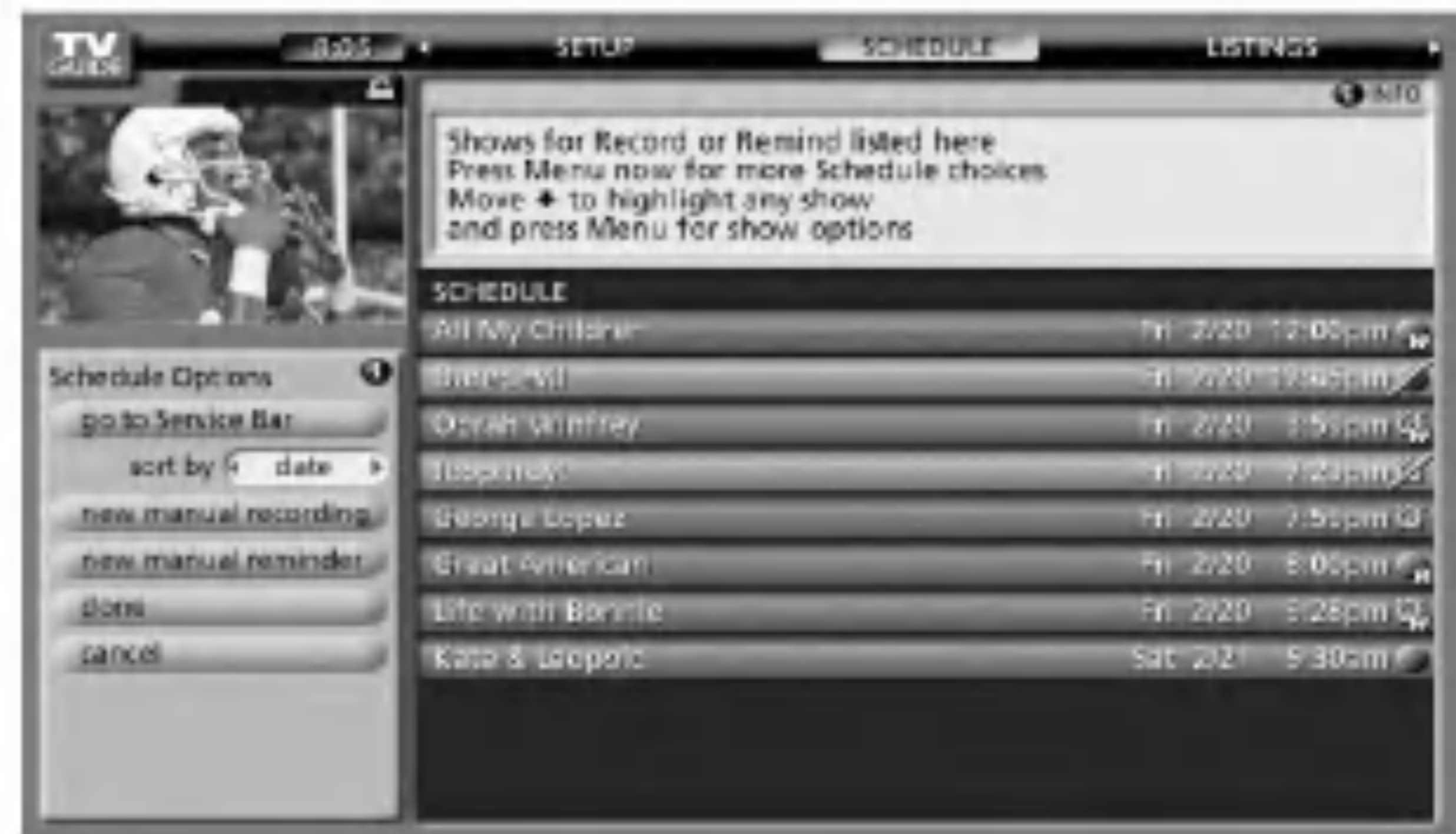

- Highlight the Schedule Service label, and press **MENU** button to display the Schedule Options menu.
- Use the **▲ / ▼ / ◀ / ▶** button to move through the options. Use the number or the **▲ / ▼ / ◀ / ▶** button to change the information, as necessary.
- Highlight New Manual Recording and press **ENTER** button to display the Record Options menu.



- Current information (i.e., date, start and end times, channel, input) is displayed.
- Recorder choice: Please choose the VCR only. This TV does not provide other devices with a recording feature.



- Use the ◀ / ▶ button to choose between Once, Daily, Weekly, and Off, as follows.

Once 	Records the time, channel, input, recorder combination one time.
Daily 	Records the time, channel, input, recorder combination Monday through Friday.
Weekly 	Records the time, channel, input, recorder combination once a week on this selected day of the week
Off (not cancel) 	Keeps the time, channel, input, recorder combination in the list without recording until the frequency is changed.



When finished, press **ENTER** button to highlight Schedule Recording.

Press **ENTER** again to close the menu. You see a Record icon for the selected frequency next to the show title.

* **Note:** Manual recording is listed by channel number.

Highlight Cancel to close the menu, change no information, and return to the highlighted show.

Before a recording begins, a notification screen appears if your TV is On. At that time, you can choose to start or cancel recording. If the TV is not On, the recording occurs as scheduled. If there is no activity for 3 minutes, the notification screen automatically closes and completes the highlighted item.

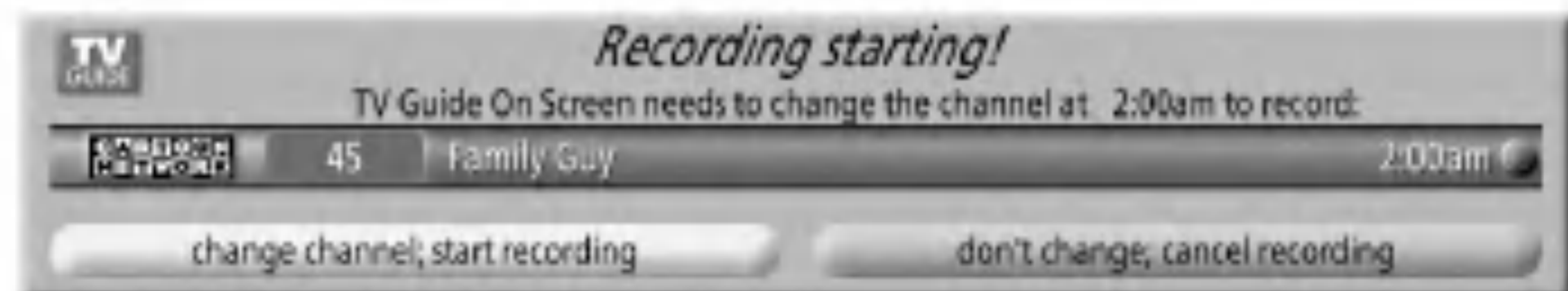

Record Conflict

A conflict message appears for the following reasons:

- A show set to Record overlaps with any part of another show previously set to Record,
- A show set to Record overlaps with a show previously set to auto tune

Select one of these options:

- Record anyway - this show will override an existing show set to Record or auto-tune
- Don't record this show - cancel the Recording

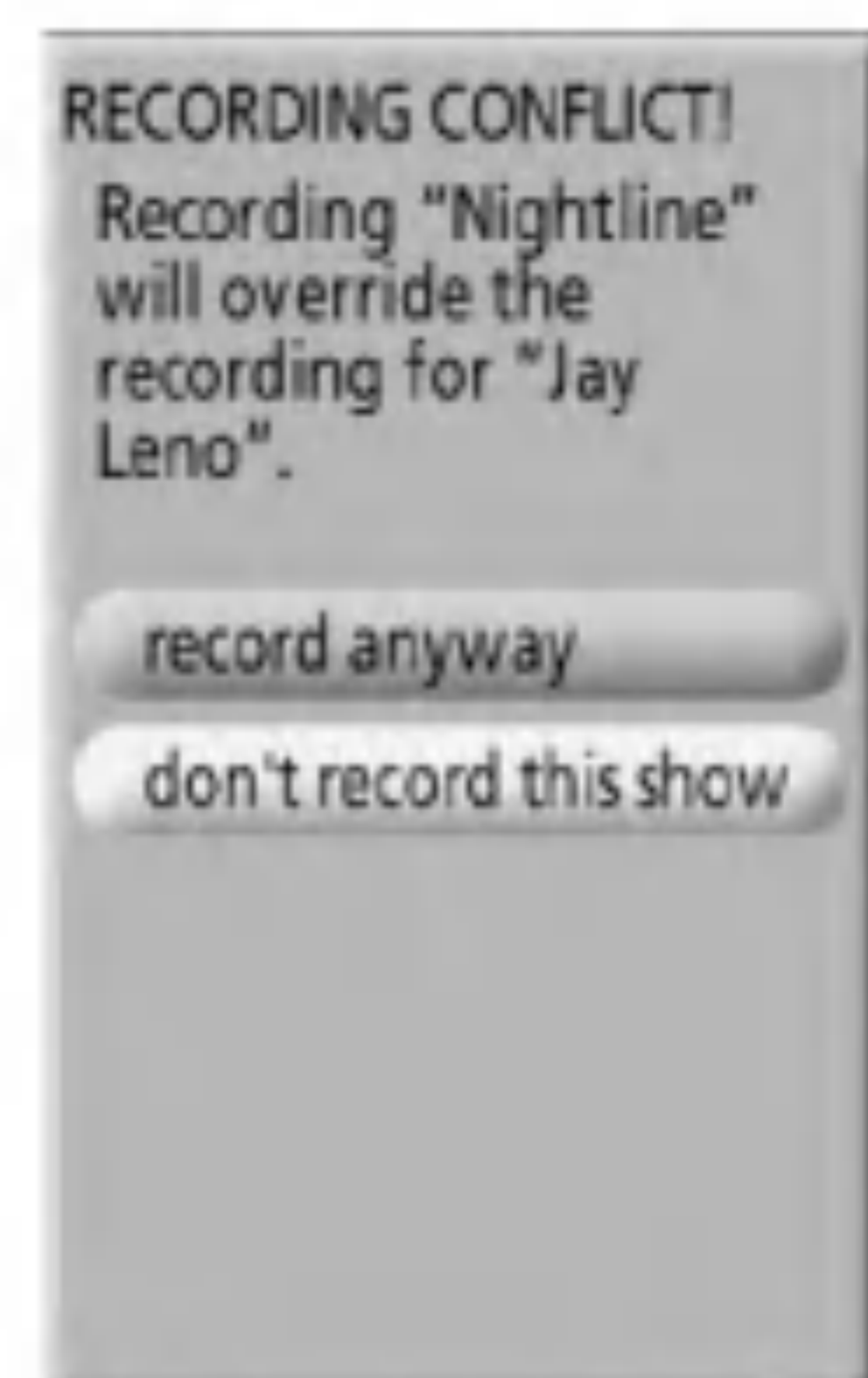
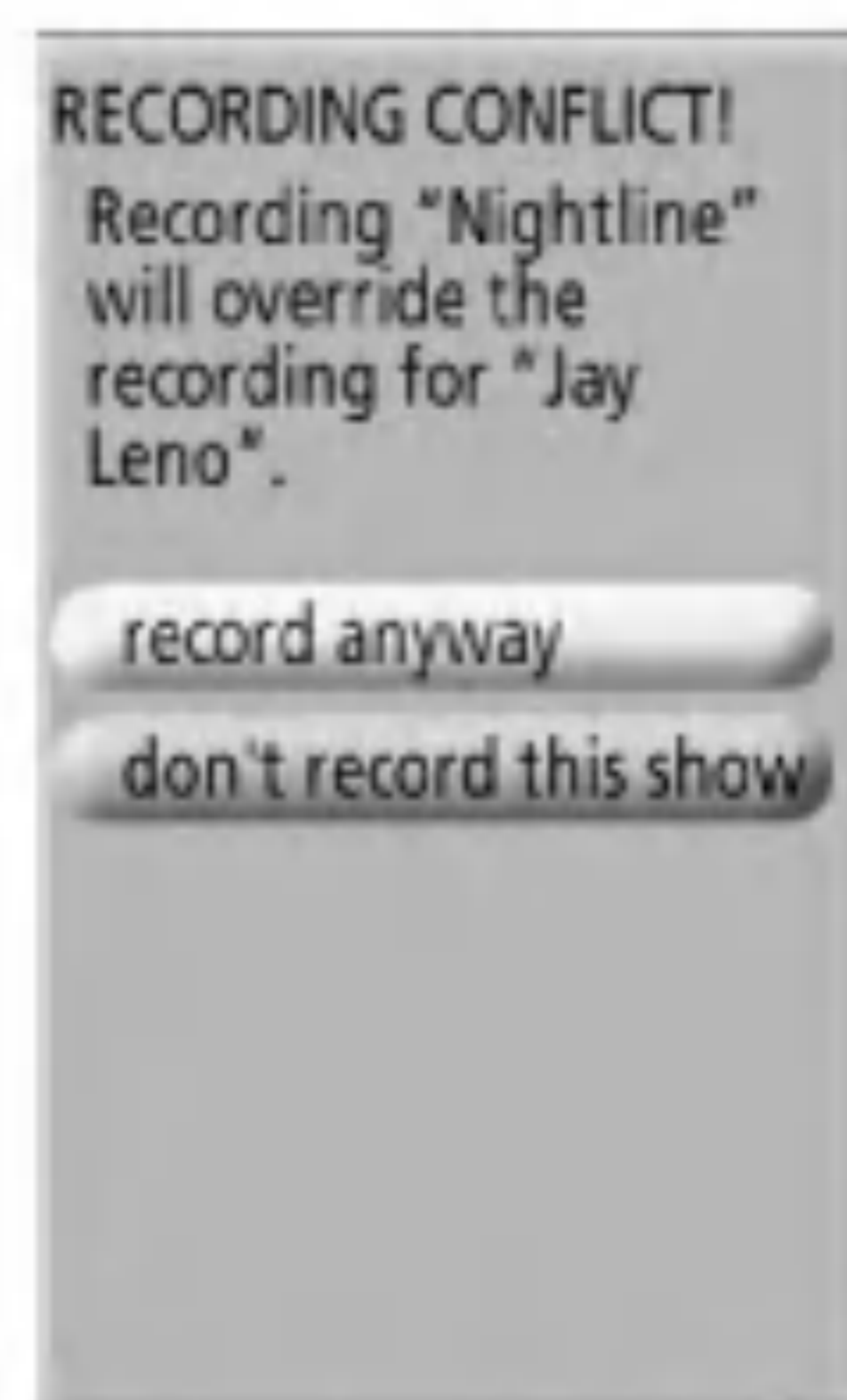

Remind





You can set a show Reminder in Listings, Search, and Schedule or change Reminder settings for a show in Schedule. There are 2 ways to set a show Reminder:

1) From a Panel Menu

- Highlight a show, and press **MENU** button to display the Episode Options menu.
- Highlight Set Reminder, and press **ENTER** button to display the Remind Options menu.



- Highlight the Frequency option, and use the left and right arrows to choose between:

Once 	Sets a show reminder one time
Regularly 	Sets a show reminder every time the show airs on the same channel and starts at the same time
Weekly 	Sets a show reminder each time the show airs on the same day of the week, on the same channel and starts at the same time
Off 	Keeps the show in the list but will not remind until the frequency is changed







- Power On the TV, if Off, when a Reminder is scheduled. Choices are Yes and No. (Default = No)
- Automatically tune the TV to the channel (TV must be On), when a Reminder is scheduled. Choices are Yes and No. (Default =No)
- When to display the reminder screen. Choices are 30 seconds to 15 minutes early, to 30 seconds to 15 minutes late, to On time. (Default = 1 min early)



When finished, press **ENTER** button to highlight Schedule Reminder. Press **ENTER** button again to close the menu. You see a Remind icon for the selected frequency next to the show title. Highlight Cancel to close the menu, change no information, and return to the highlighted show.

2) Manual Reminder

- Highlight the Schedule Service label, and press the Menu key to display the Schedule Options menu.
- Use the ▲ / ▼ / ◀ / ▶ button to move through the options. Use the number or ▲ / ▼ / ◀ / ▶ button to change the information, as necessary.
- Highlight New Manual Reminder and press the ENTER button to display the Remind Options menu.
- Current information (i.e., date, start and end times, channel, input, frequency, etc.) is displayed.
- Highlight the Frequency option, and use the ◀ / ▶ button to choose among Once, Daily, Weekly, and Off, as follows.

Once 	Sets a show reminder for the time, channel, input combination one time
Daily 	Reminds for the time, channel, input combination Monday through Friday.
Weekly 	Sets a show reminder for the time, channel, input combination once a week on this selected day of the week.
Off (not cancel) 	Keeps the time, channel, input combination in the list without reminding until the frequency is changed.

- Power On the TV, if Off, when a Reminder is scheduled. Choices are Yes and No (Default =No).
- Automatically tune the TV to the channel (TV must be On), when a Reminder is scheduled. Choices are Yes and No (Default = No).

When finished, press ENTER button to highlight Schedule Reminder. Press ENTER button again to close the menu. You see a Remind icon for the selected frequency next to the show title.

* **Note:** Manual reminder is listed by channel number.

Highlight Cancel to close the menu, change no information, and return to the highlighted show.



Based on your option settings, a notification screen will appear, if your TV is On at the reminder time. You can then choose to hide the reminder, or highlight the show, and press **ENTER** button to tune to the show. If there is no activity for 3 minutes, the notification screen automatically closes and completes the highlighted item (hide reminders).

If you choose Hide Reminders, the window closes for the show or shows, but does not affect other Reminders you set.

Note: If more than 2 reminders are set for the same time, arrows appear on the Reminder screen. Use the **▲ / ▼** button to view the shows.

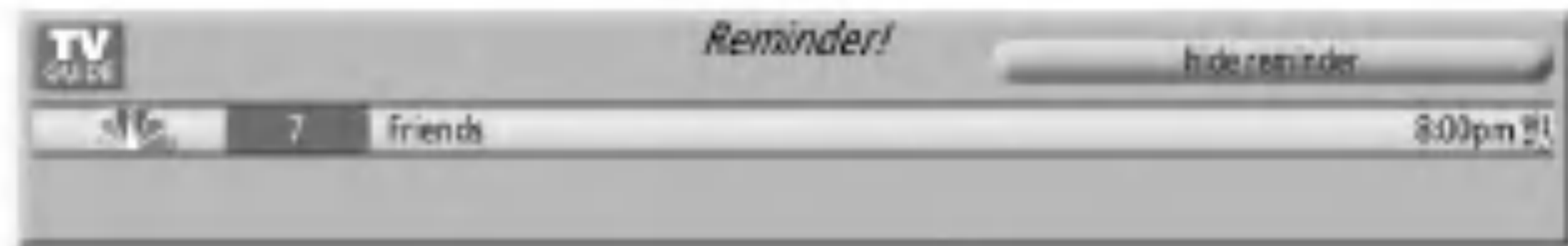
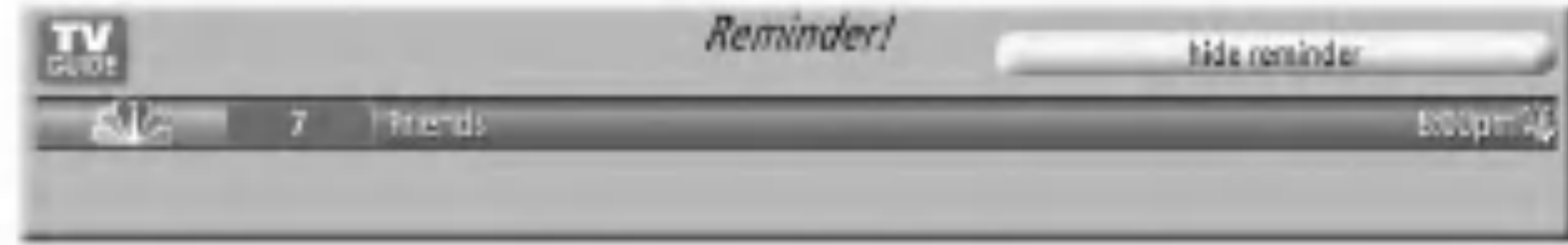

Remind Conflict

A conflict message appears for the following reasons:

- A show set with an Auto-Tune Reminder has the same start time as an existing Auto-Tune Reminder.
- If you are using a cable box, a show set with an Auto-Tune Reminder overlaps with a Recording already scheduled.

Select one of these options:

- Auto-tune anyway - this show will override an existing show set to auto-tune
- Proceed, no auto-tune - set the show as a Reminder but do not auto-tune
- Don't set this reminder - cancel the Reminder

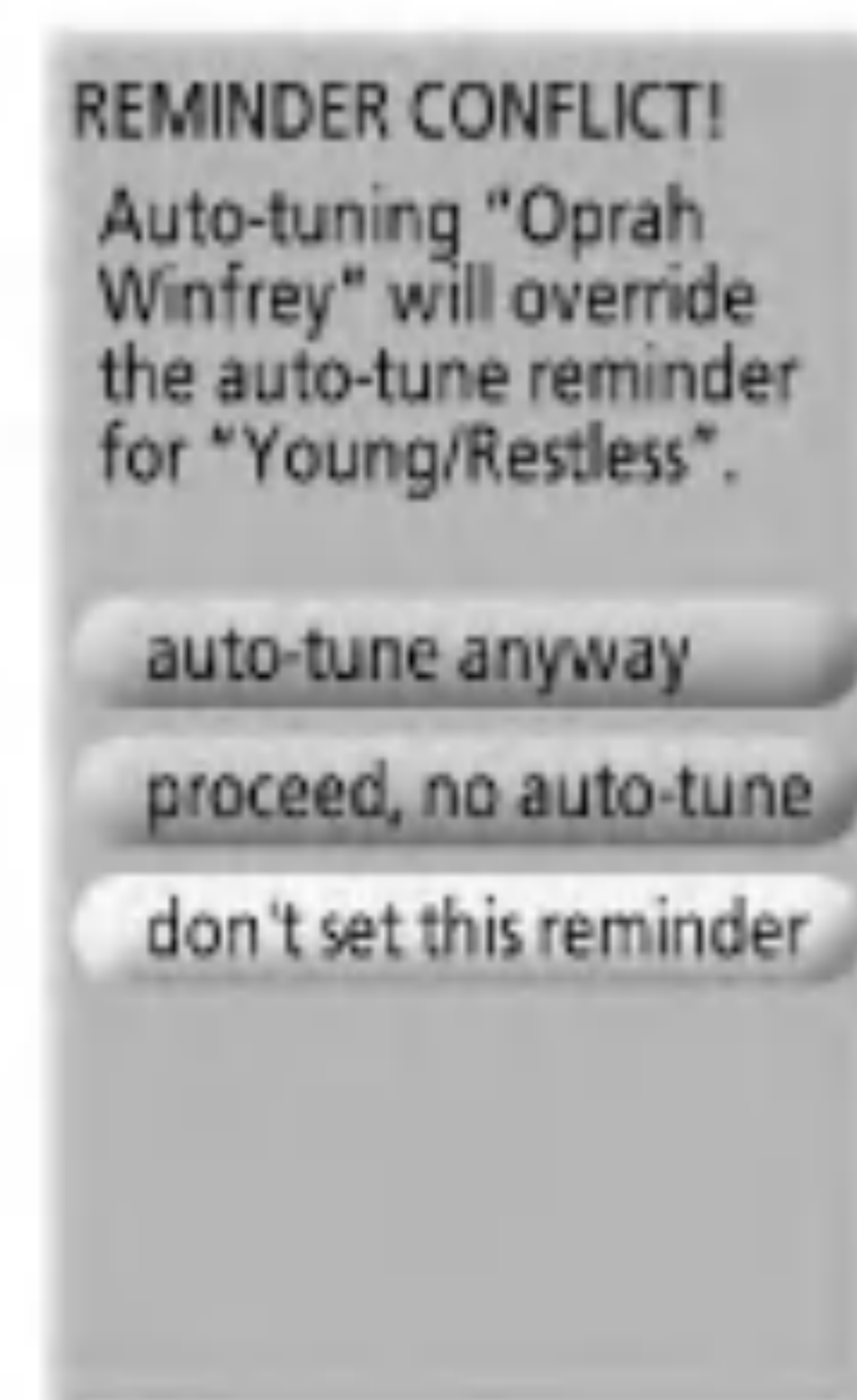
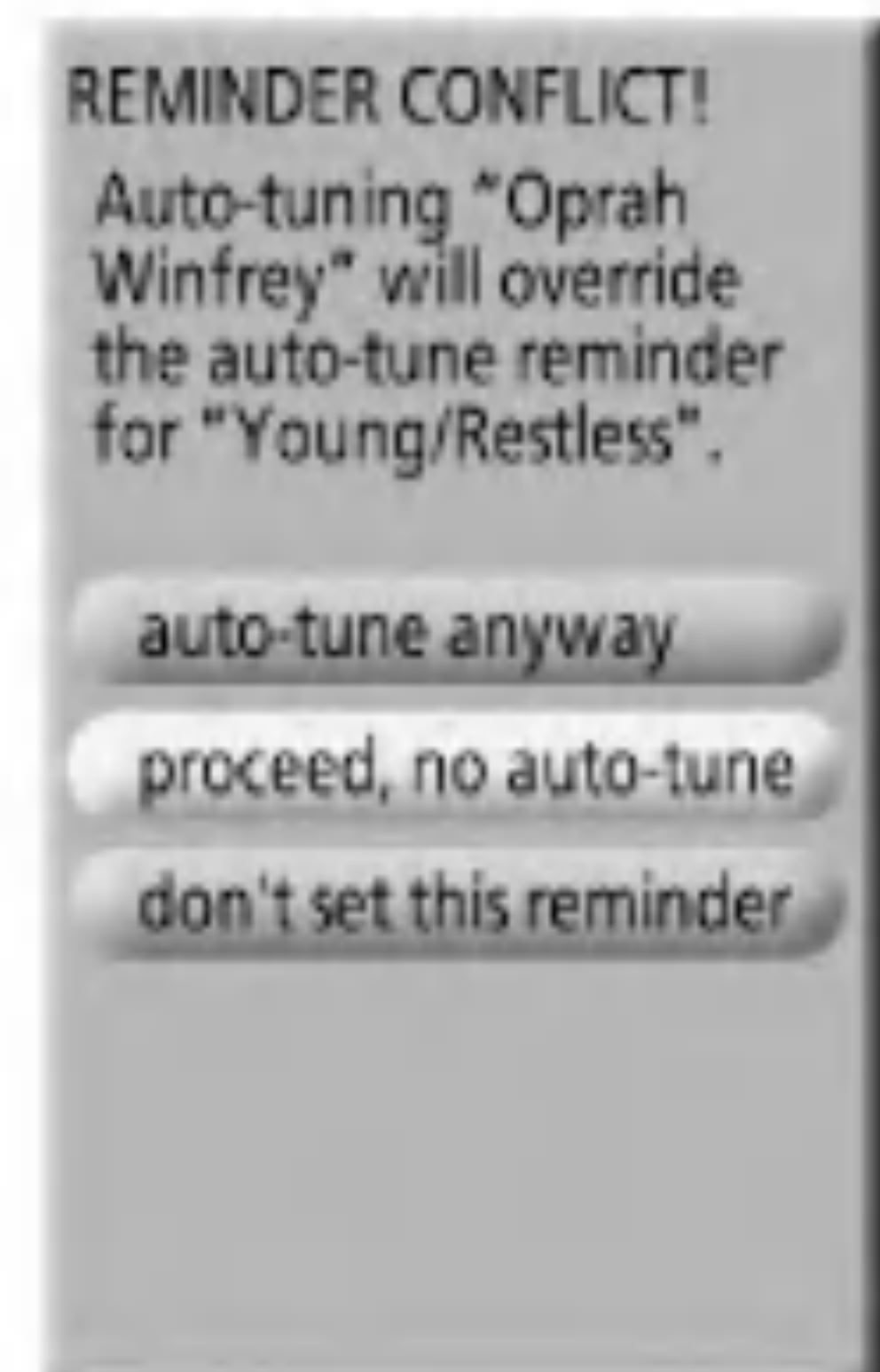
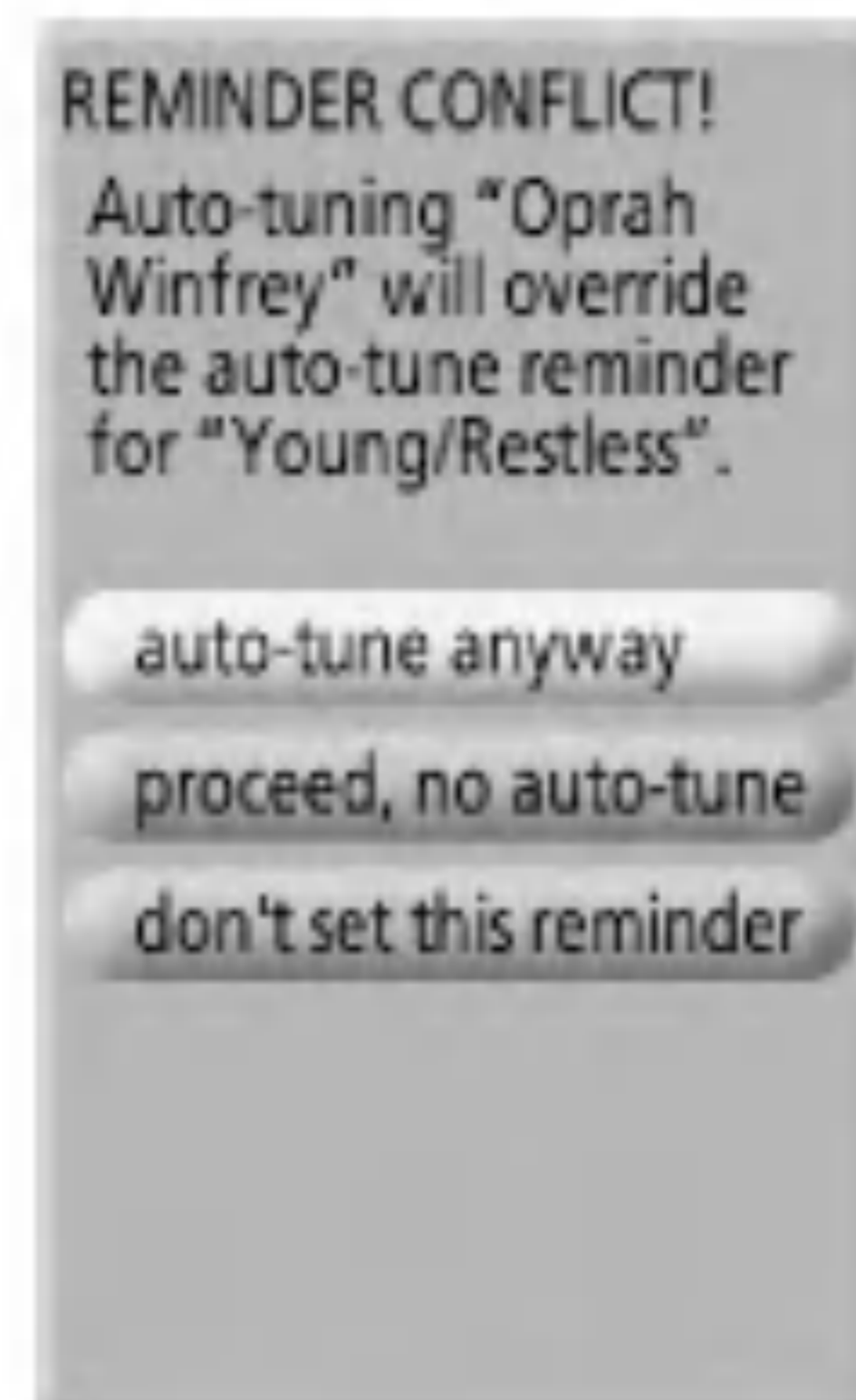

Operation

Basic operation

Turning on the TV

1. First, connect power cord correctly. At this moment, the TV switches to standby mode.
In standby mode to turn TV on, press the **ON/OFF**, **TV/VIDEO**, **CH ▲ / ▼** button on the TV or press the **POWER**, **TV INPUT**, **TV/VIDEO**, **CH ▲ / ▼**, Number (0 ~ 9) button on the remote control .
2. Select the viewing source by using **TV INPUT**, **TV/VIDEO** button on the remote control.
This TV is programmed to remember which power state it was last set to, even if the power cord is out.
3. When finished using the TV, press the **POWER** button on the remote control. The TV reverts to standby mode.

Volume Adjustment

1. Press the **VOL ▲ / ▼** button to adjust the volume.
2. If you want to switch the sound off, press the **MUTE** button.
3. You can cancel this function by pressing the **MUTE** or **VOL ▲ / ▼** button.

Channel Selection

Press the **CH ▲ / ▼** or **NUMBER** buttons to select a channel number.



- If you intend to be away on vacation, disconnect the power plug from the wall power outlet.
- After turning on the TV, it will take up to a week for the TV Guide On Screen system to receive full listings data.
- When the TV is turned On, the TV Guide On Screen system is automatically displayed. The screen may be slightly delayed if the TV was unplugged and then powered On.

On Screen Menus Language Selection

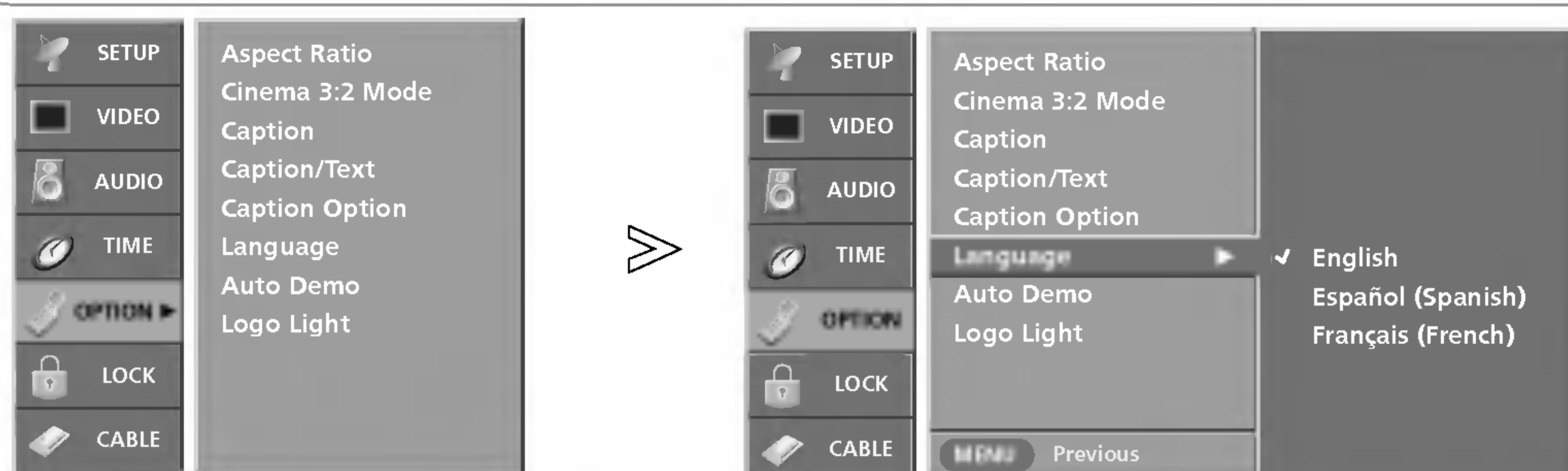

- The menus can be shown on the screen in the selected language. First select your language.

- 1 Press the **MENU** button and then use **▲ / ▼** button to select the **OPTION** menu.
- 2 Press the **▶** button and then use **▲ / ▼** button to select **Language**.
- 3 Press the **▶** button and then use **▲ / ▼** button to select your desired language. From this point on, the on-screen menus will be shown in the selected language.
- 4 Press **EXIT** button to return to TV viewing or press **MENU** button to return to the previous menu.

On Screen Menus Selection and Adjustment

How to adjust the OSD screen

1. Press the **MENU** button and then **▲ / ▼** button to select each menu.
2. Press the **▶** button and then use **▲ / ▼ / ◀ / ▶** button to display the available menus.

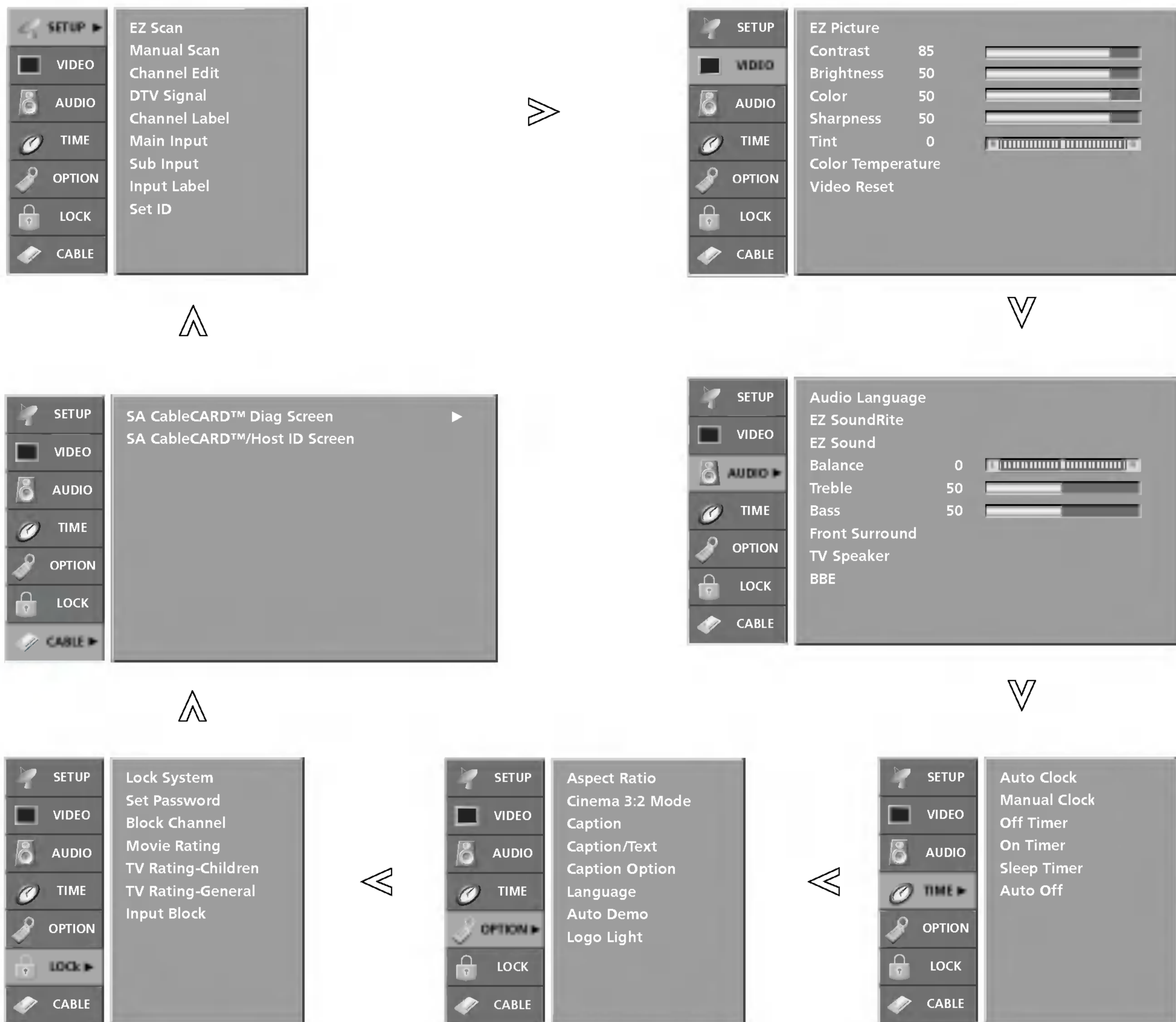

• Your TV's OSD (On Screen Display) may differ slightly from what is shown in this manual.

Setup Menu Options

EZ Scan (Channel Search)



- Automatically finds all channels available through antenna or cable inputs, and stores them in memory on the channel list.
- Run EZ Scan again after any Antenna/Cable connection changes.
- A password is required to gain access to EZ Scan menu if the Lock System is turned on.

- 1 Press the **MENU** button and then use **▲ / ▼** button to select the **SETUP** menu.
- 2 Press the **▶** button and then use **▲ / ▼** button to select **EZ Scan**.
- 3 Press the **ENTER** button to begin the channel search. Allow EZ Scan to complete the channel search cycle for ANTENNA, and CABLE.

Manual Scan

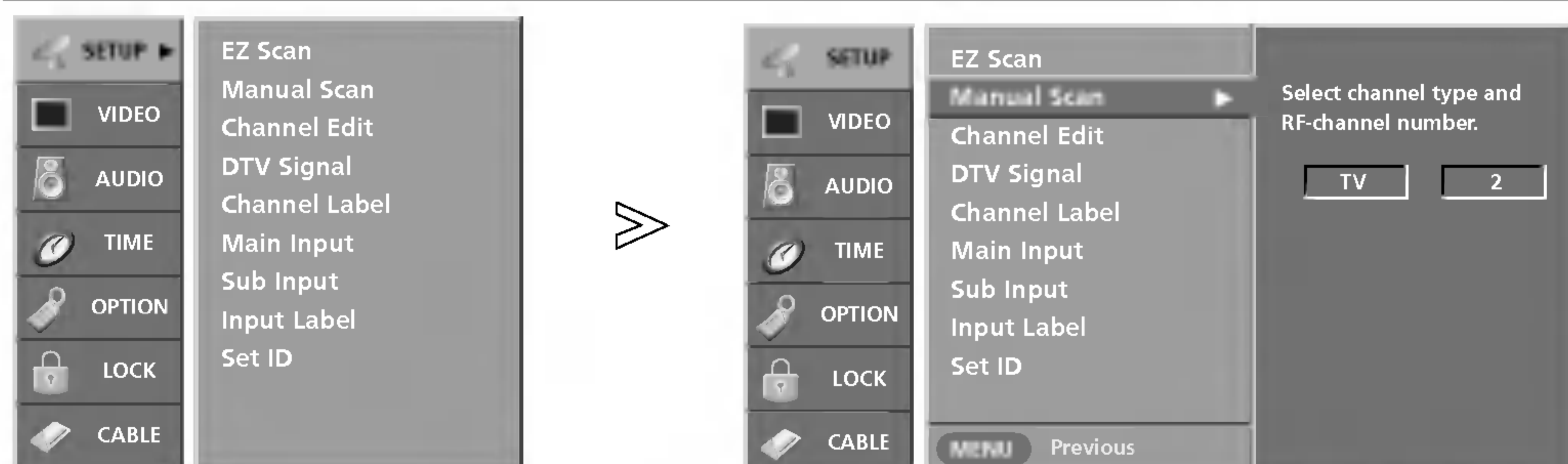

- A password is required to gain access to Manual Scan menu if the Lock System is turned on.
- This channel number is a physical channel number, which is different from normal channel number showed in Channel Edit.
- When a cable box connects to the physical channel 2,3 or 4 in TV Guide On Screen system Setup, cable channels (CATV or CADTV) will not be scanned by EZ Scan or Manual Scan.
- When inserting the CableCARD™, CATV, CADTV is not working in Manual Scan.

- 1 Press the **MENU** button and then use **▲ / ▼** button to select the **SETUP** menu.
- 2 Press the **▶** button and then use **▲ / ▼** button to select **Manual Scan**.
- 3 Press the **▶** button and then use **▲ / ▼** button to select TV, DTV, CATV, and CADTV.
- 4 Press the **▶** button and then use **▲ / ▼** button to select channel number you want to add or delete.
- 5 Press the **ENTER** button to add or delete for the channel number.
- 6 Press **EXIT** button to return to TV viewing or press **MENU** button to return to the previous menu.

Mini Glossary

TV Analog antenna (over-the-air) TV signal
DTV Digital antenna (over-the-air) TV signal

CATV Analog cable TV signal
CADTV Digital cable TV signal



Setup Menu Options continued



- Create two different types of channel lists in memory: "Custom list" and "Favorite channel list" from the default channel list created from the EZ Scan channel search.
- A custom list can be created by toggling each channel on or off with **ENTER** button. The channels in the Custom List are displayed in black color, and the channels deleted from the Custom List are displayed in gray color. Once a channel is highlighted you can add or delete the channel by referring to the small window at the top-left corner of the screen.
- You can create your own favorite channel list.
Use the **FAV** button on the remote control when a channel is highlighted and then you can add or delete the channel to/from the Favorite List.
- When a cable box connects to the physical channel 2, 3, or 4 in TV Guide On Screen system Setup, cable channels (CATV or CADTV) will not be editable by Channel Edit. Instead, use the cable box's Channel Edit if available.

- 1 Press the **MENU** button and then use **▲ / ▼** button to select the **SETUP** menu.
- 2 Press the **▶** button and then use **▲ / ▼** button to select **Channel Edit**.
- 3 Press the **▶** button. You will now see a screen filled with channel numbers and a preview picture.
- 4 Use **▲ / ▼ / ◀ / ▶** button to select a channel and then use the **ENTER** button to add or delete it. Press **FAV** button to add the channel to the Favorite List. The heart-mark will appear in front of that channel number.
- 5 Press **EXIT** button to return to TV viewing or press **MENU** button to return to the previous menu.

DTV Signal Strength

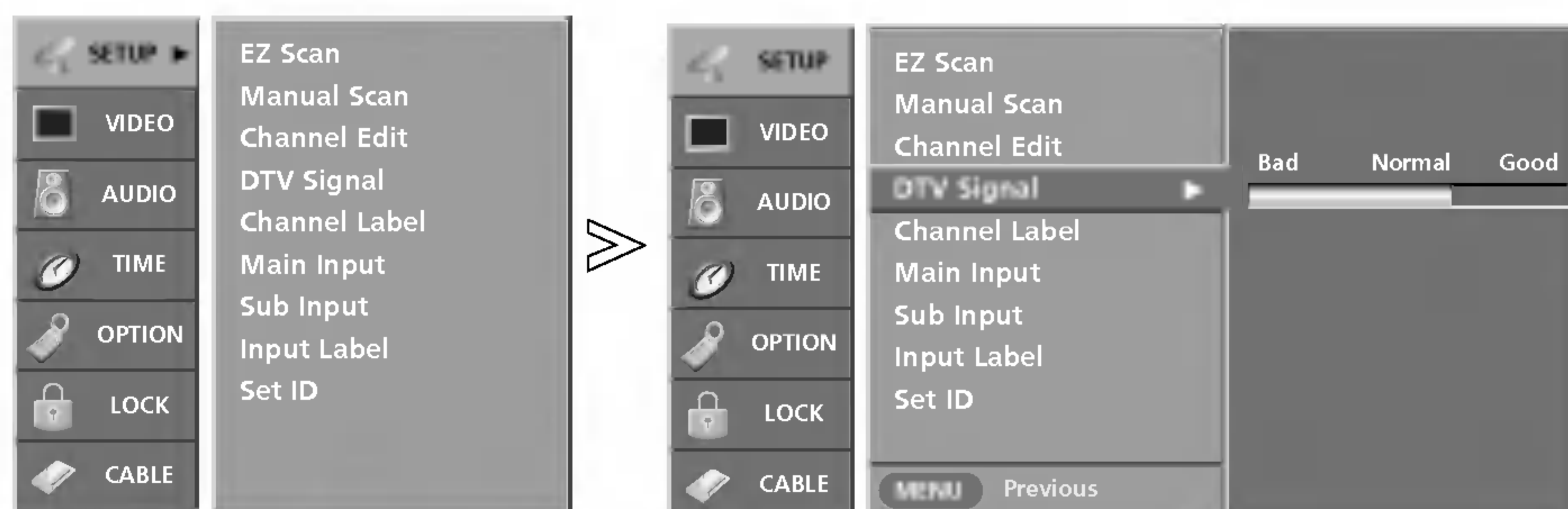

- Shows how strong your DTV signal is and whether you need to adjust your antenna or digital cable input. The higher the signal strength, the less likely you are to experience picture degradation.
- DTV Signals: Only when the input signal is DTV or CADTV, this function is available.

- 1 Press the **MENU** button and then use **▲ / ▼** button to select the **SETUP** menu.
- 2 Press the **▶** button and then use **▲ / ▼** button to select **DTV Signal**.
- 3 View the on-screen signal strength monitor to see the quality of the signal being received.
- 4 Press **EXIT** button to return to TV viewing or press **MENU** button to return to the previous menu.

Channel Label Setup

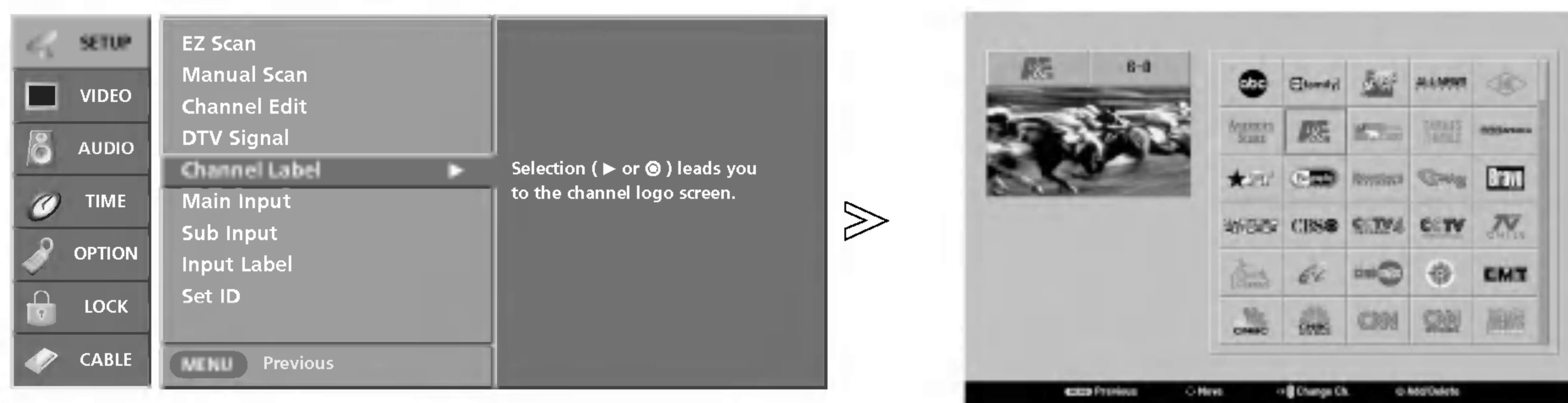

- Choose preset labels for your channels.
- If a channel label is provided on the signal from the broadcasting station, the TV displays a short name for a channel: even if you didn't preset a label for the channel.
- If you press **ENTER** button in TV viewing mode, you will see the channel banner.

- 1 Press the **MENU** button and then use **▲ / ▼** button to select the **SETUP** menu.
- 2 Press the **▶** button and then use **▲ / ▼** button to select **Channel Label**.
- 3 Press the **▶** button. You will now see a screen filled with Labels and a preview screen.
- 4 Use the **CH ▲ / ▼** button to select a channel to Label.
- 5 Use **▲ / ▼ / ◀ / ▶** button to select the appropriate label for the channel, then press **ENTER** button to set the Label to the selected channel.



Setup Menu Options continued

Main Picture Source Selection

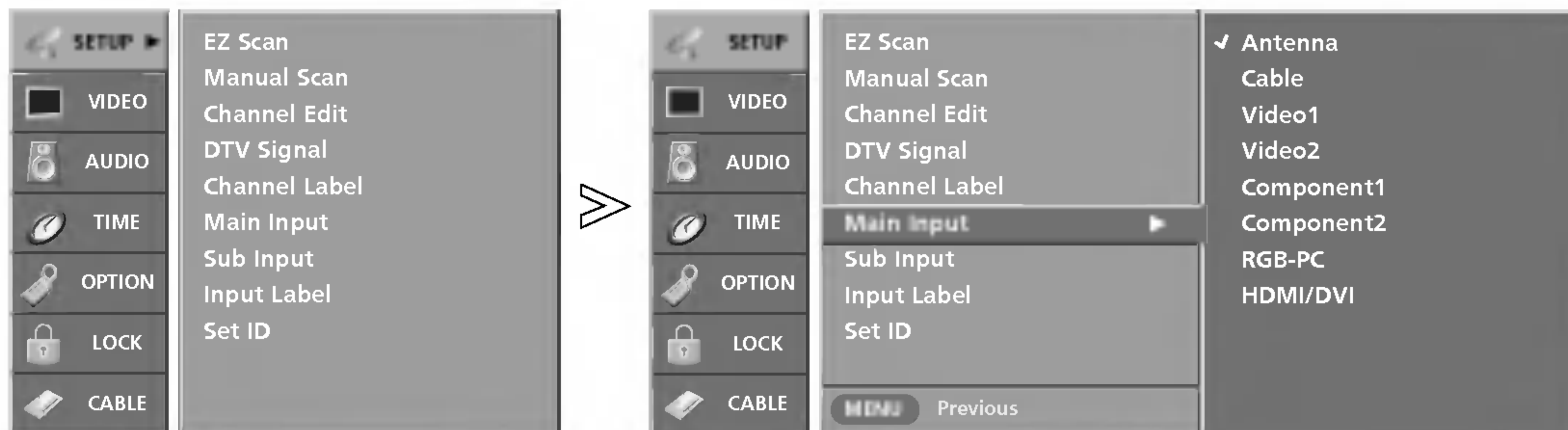

- Changes the picture source so you can watch your TV, cable TV, VCR, DVD, or any other devices that are connected to your TV.

- 1 Press the **MENU** button and then use **▲ / ▼** button to select the **SETUP** menu.
- 2 Press the **▶** button and then use **▲ / ▼** button to select **Main Input**.
- 3 Press the **▶** button and then use **▲ / ▼** button to select the source: Antenna, Cable, Video1, Video2, Component1, Component2, RGB-DTV (or RGB-PC), or HDMI/DVI.
 - To toggle RGB-DTV and RGB-PC, select RGB-DTV(or RGB-PC) and press **▶** button.
- 4 Press **EXIT** button to return to TV viewing or press **MENU** button to return to the previous menu.

Input Label

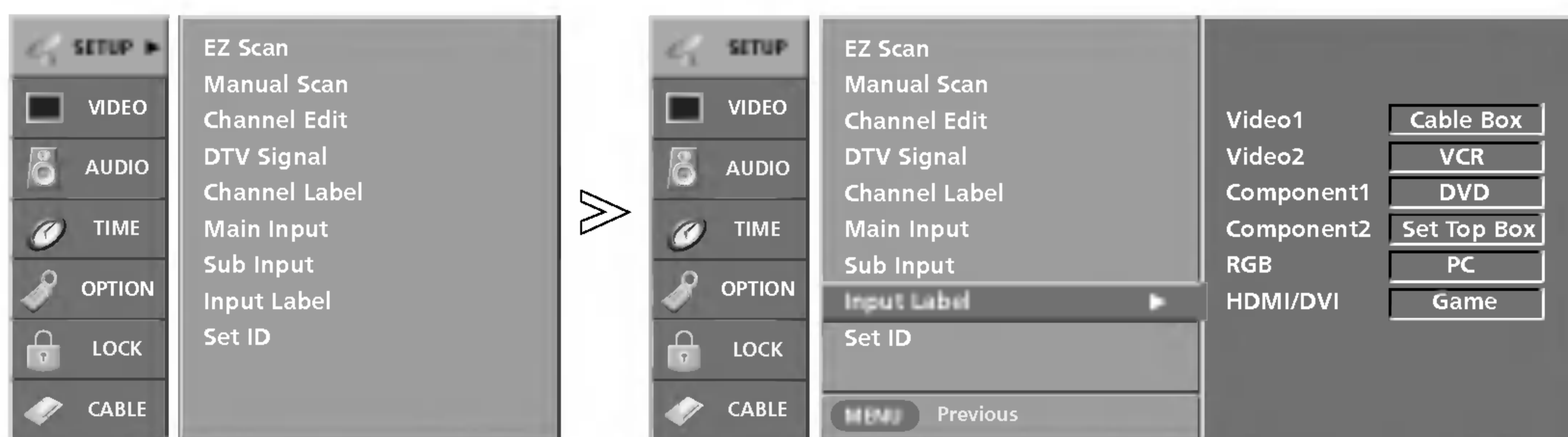

- Sets a label to each input source or lets you skip the input source which is not in use when you press **TV/VIDEO** button.

- 1 Press the **MENU** button and then use **▲ / ▼** button to select the **SETUP** menu.
- 2 Press the **▶** button and then use **▲ / ▼** button to select **Input Label**.
- 3 Press the **▶** button and then use **▲ / ▼** button to select the source: Video1-2, Component1-2, RGB, or HDMI/DVI.
- 4 Press the **◀ / ▶** button to select the label.
- 5 Press **EXIT** button to return to TV viewing or press **MENU** button to return to the previous menu.

Video Menu Options

EZ Picture

- EZ Picture adjusts the TV for the best picture appearance. Select the preset value in the EZ Picture menu based on the program category.
 - When adjusting Video menu options (contrast, brightness, color, sharpness, tint, and color temperature) manually, EZ Picture automatically changes to **Custom**.
 - **Daylight, Normal, Night Time, Movie, Video Game, and Sports** settings are preset for optimum picture quality at the factory and are not adjustable.
- 1** Press the **EZ PIC** button repeatedly to select the picture appearance setup option as shown below: **Custom** (your own settings), **Daylight, Normal, Night Time, Movie, Video Game, and Sports**.
 - You can also adjust **EZ Picture** in the **VIDEO** menu.
 - 2** Press the **EXIT** button to save and return to TV viewing.

APM (Adaptive Picture Mode)

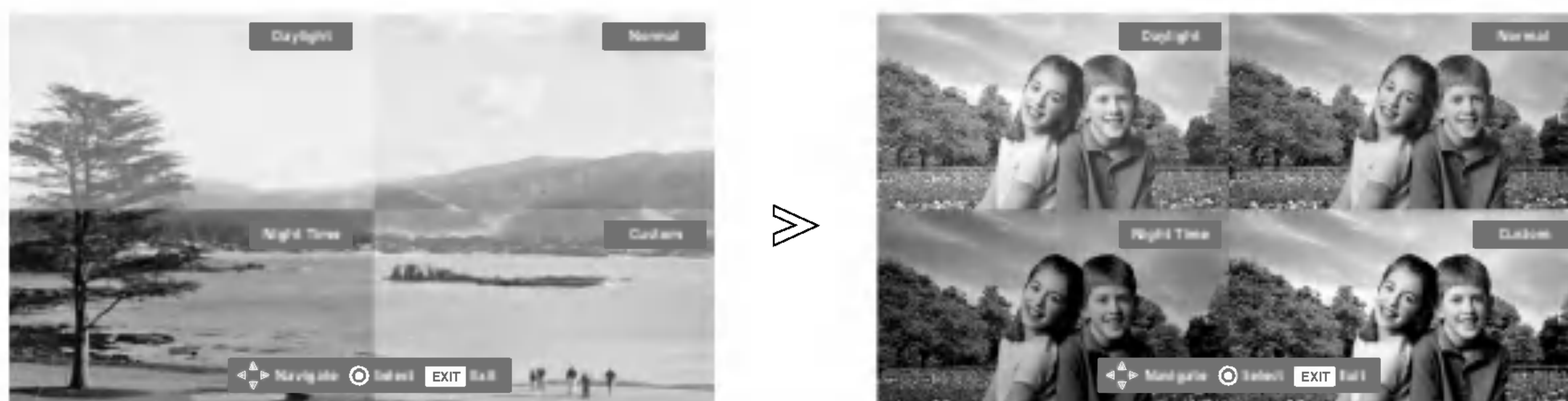

- It allows a viewer to select their preferred mode after comparing picture (Daylight, Normal, Night Time and Custom) settings.
 - Note: While operating the 4-split, any button except **APM, ENTER, EXIT, VOLUME ▲/▼, MUTE** button on the remote control are not available.
- 1** Press the **APM** button at once. The screen is divided to 4-split.
 - 2** Press the **▲ / ▼ / ◀ / ▶** button to navigate 4 EZ Pictures. By pressing the **ENTER** button, you can select the desired mode.
 - 3** Press the **EXIT** button to save and return to TV viewing.
-
- 1** Press the **APM** button twice time. The 4-same screens are displayed. You can easily compare with 4 modes.
 - 2** Press the **▲ / ▼ / ◀ / ▶** button to navigate 4 EZ Pictures. By pressing the **ENTER** button, you can select the desired mode.
 - 3** Press the **EXIT** button to save and return to TV viewing.

Video Menu Options Continued

Manual Picture Control (EZ Picture-Custom option)

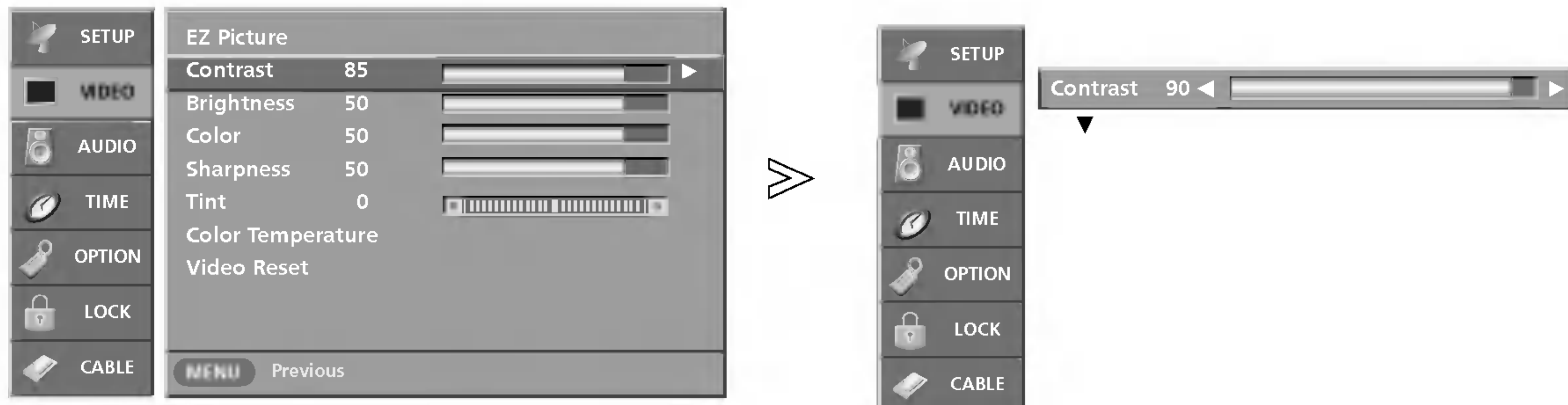

- Adjust the picture appearance to suit your preference and viewing situations.

- 1** Press the **MENU** button and then use **▲ / ▼** button to select the **VIDEO** menu.
- 2** Press the **▶** button and then use **▲ / ▼** button to select the desired picture option (**Contrast**, **Brightness**, **Color**, **Sharpness**, or **Tint**).
- 3** Press the **▶** button and then use **◀ / ▶** button to make appropriate adjustments.
- 4** Press **EXIT** button to return to TV viewing or press **MENU** button to return to the previous menu.

Color Temperature Control

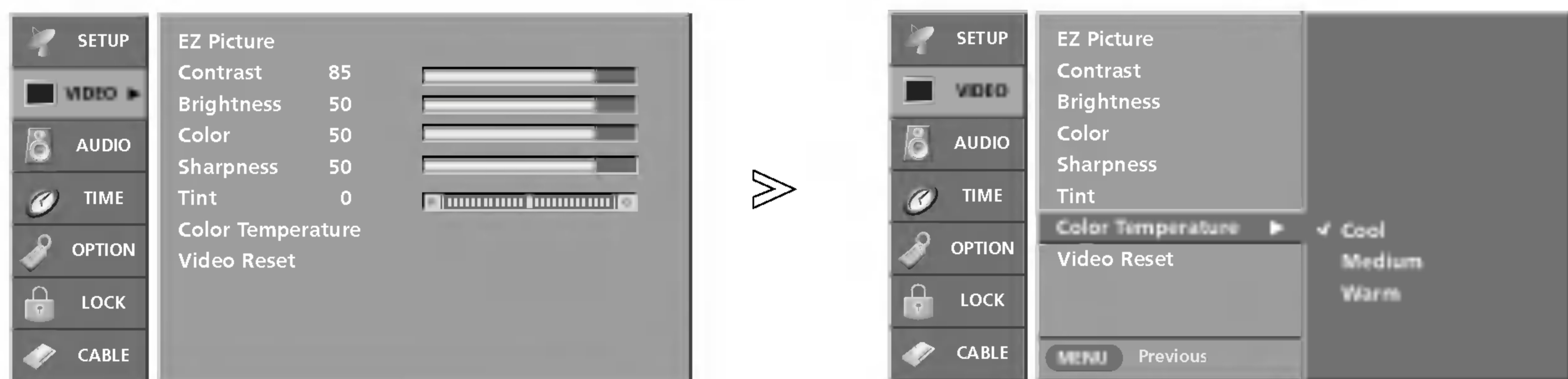

- Choose one of three automatic color adjustments. Set to warm to enhance hotter colors such as red, or set to cool to see less intense colors with more blue.

- 1** Press the **MENU** button and then use **▲ / ▼** button to select the **VIDEO** menu.
- 2** Press the **▶** button and then use **▲ / ▼** button to select **Color Temperature**.
- 3** Press the **▶** button and then use **▲ / ▼** button to select either **Cool**, **Medium**, or **Warm**.
- 4** Press **EXIT** button to return to TV viewing or press **MENU** button to return to the previous menu.

Video Reset

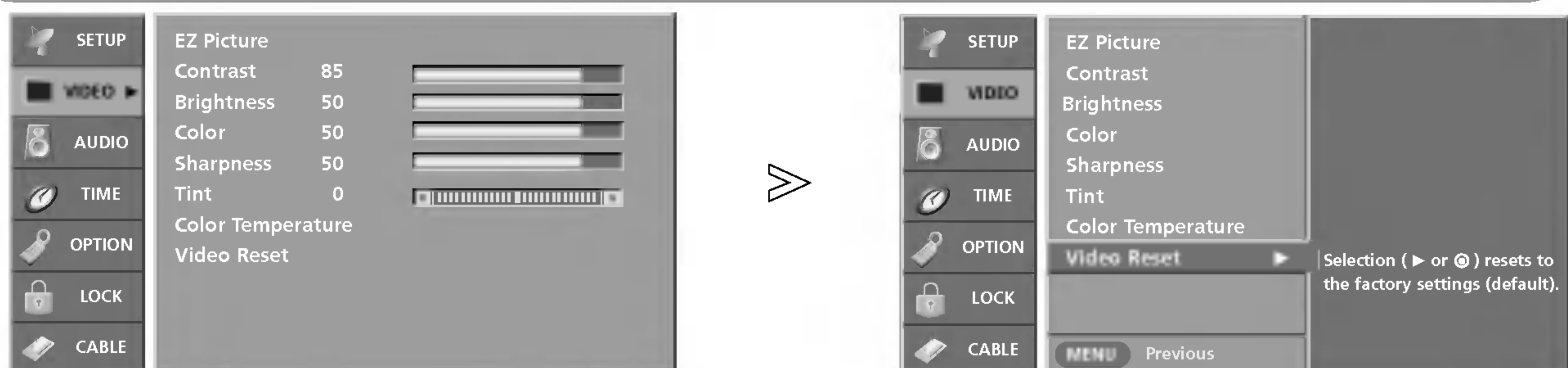

- Use to quickly reset all the Video menu options to their original factory preset values.

- 1** Press the **MENU** button and then use **▲ / ▼** button to select the **VIDEO** menu.
- 2** Press the **▶** button and then use **▲ / ▼** button to select **Video Reset**.
- 3** Press the **▶** button to reset the Video menu options to original values.



Audio Menu Options

Audio Language

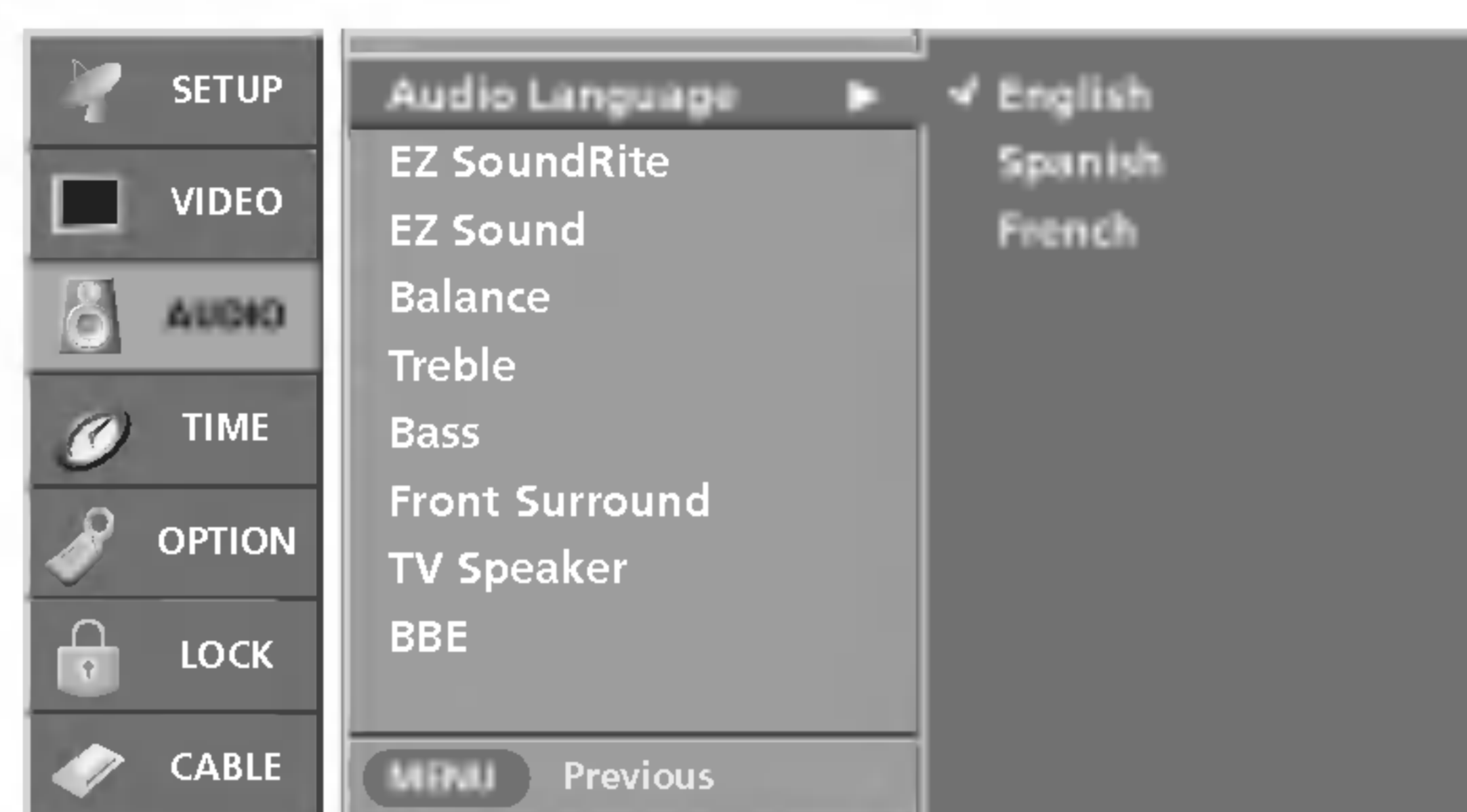
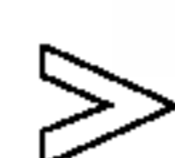
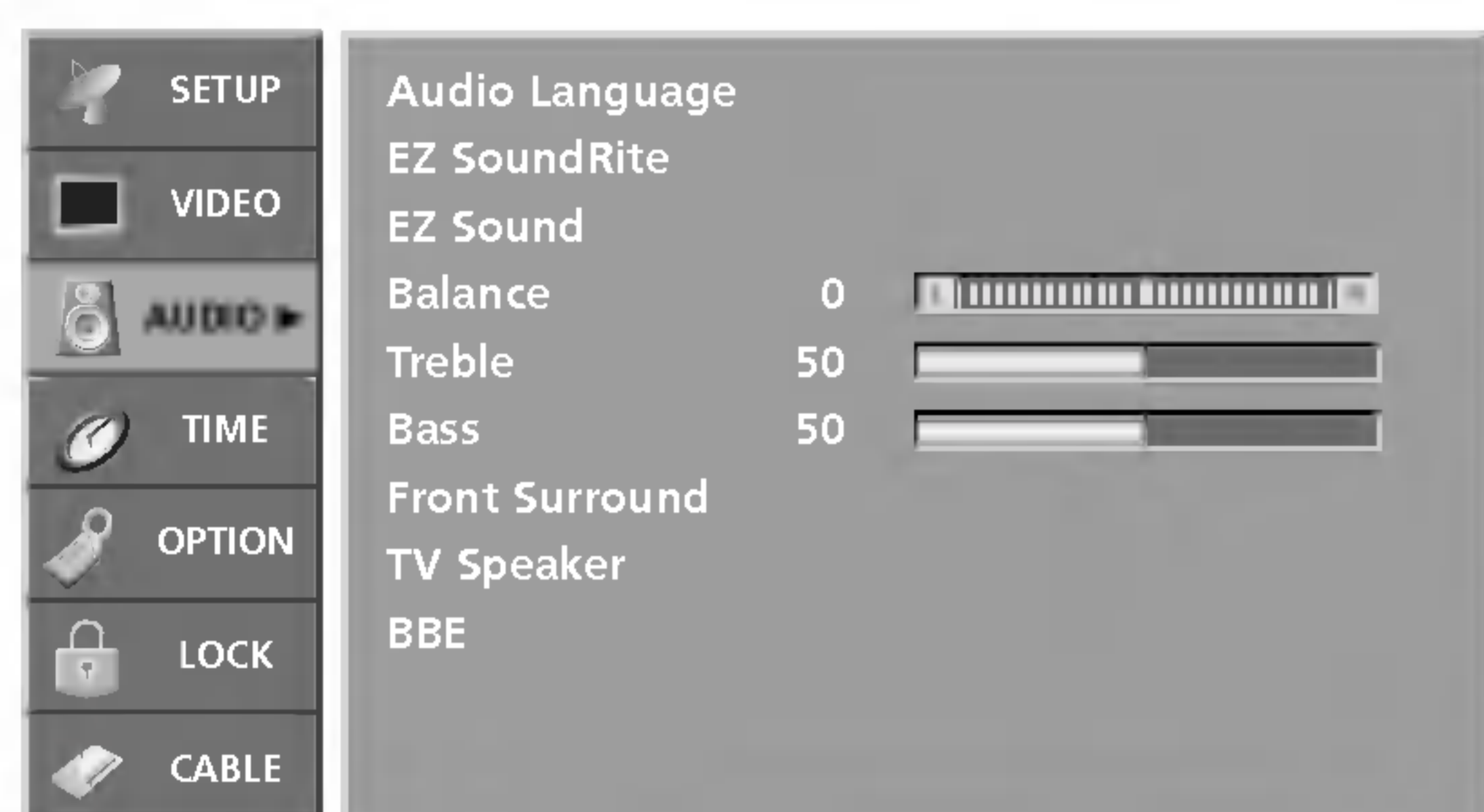

- Other languages may be available if a digital signal is provided by the broadcasting station.

- 1 Press the **MENU** button and then use **▲ / ▼** button to select the **AUDIO** menu.
- 2 Press the **▶** button and then use **▲ / ▼** button to select **Audio Language**.
- 3 Press the **▶** button and then use **▲ / ▼** button to select: English, Spanish, or French.
- 4 Press **EXIT** button to return to TV viewing or press **MENU** button to return to the previous menu.

EZ SoundRite

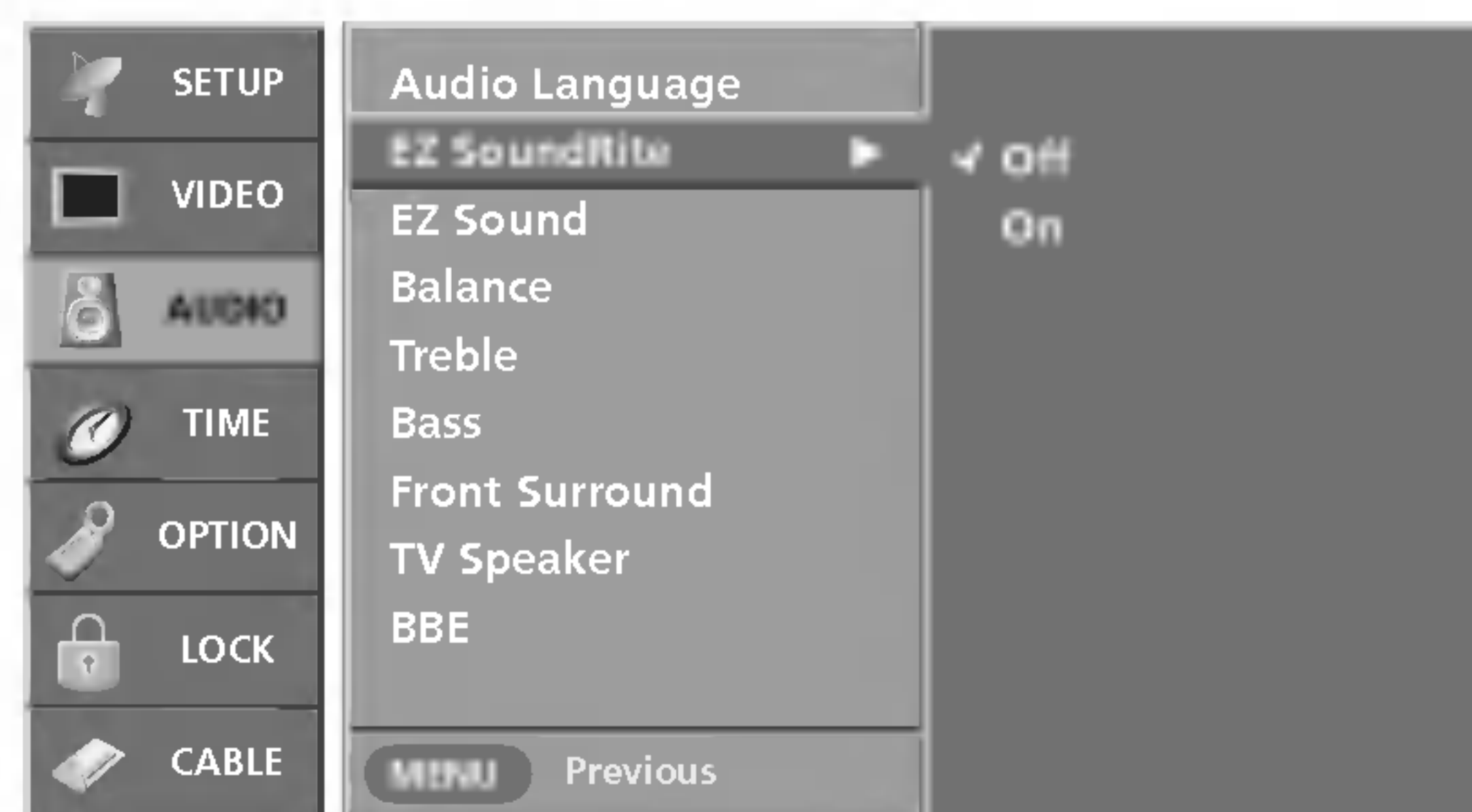
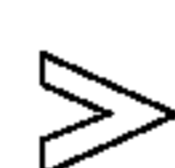
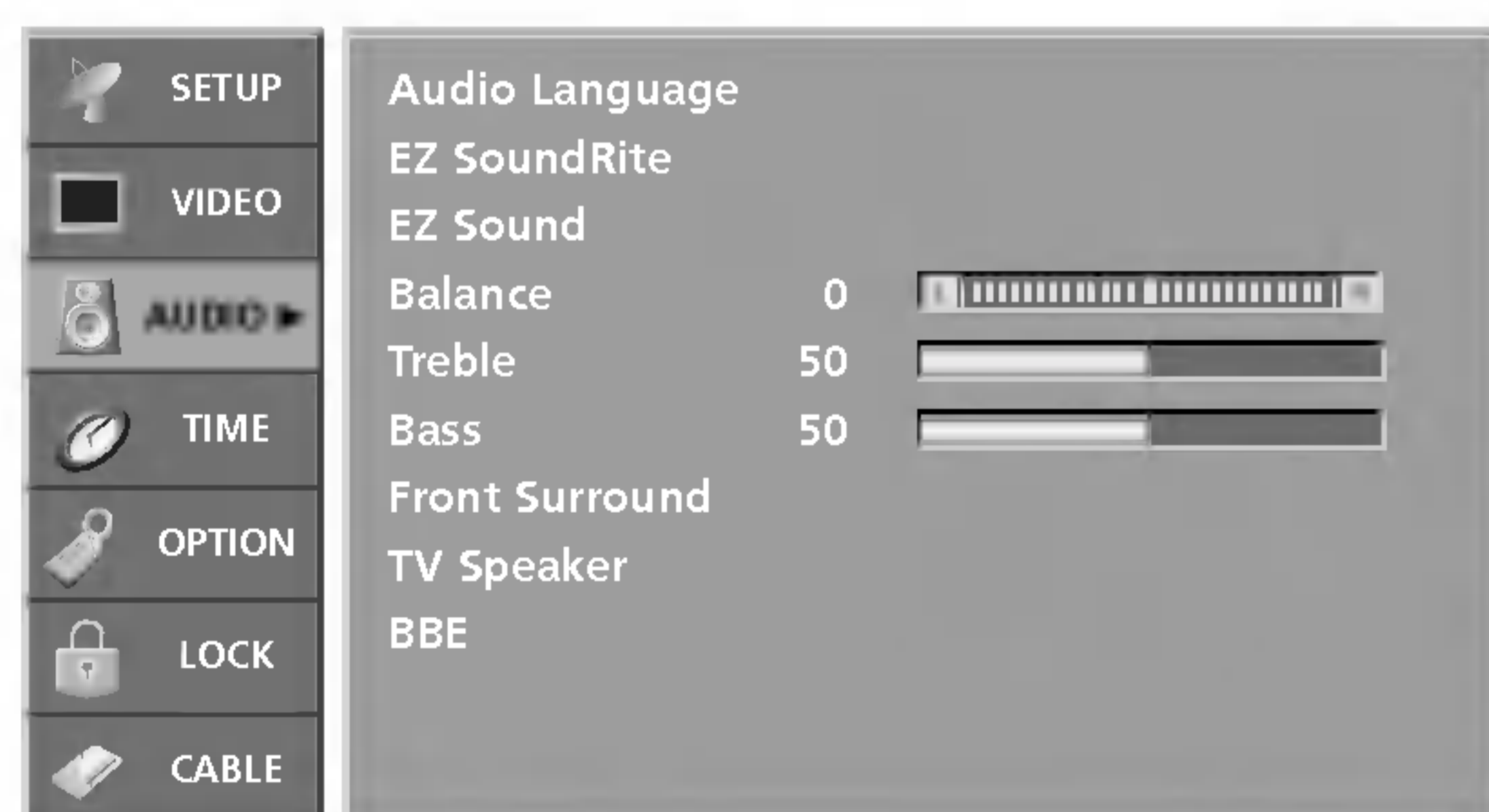

- Scans for changes in sound level during commercials, then adjusts the sound to match the specified audio level. EZ SoundRite makes sure that the volume level remains consistent whether you are watching a commercial or a regular TV program.

- 1 Press the **MENU** button and then use **▲ / ▼** button to select the **AUDIO** menu.
- 2 Press the **▶** button and then use **▲ / ▼** button to select **EZ SoundRite**.
- 3 Press the **▶** button and then use **▲ / ▼** button to select **Off** or **On**.
- 4 Press **EXIT** button to return to TV viewing or press **MENU** button to return to the previous menu.



Audio Menu Options continued

EZ Sound

- EZ Sound lets you enjoy the best sound without any special adjustment because the TV sets the appropriate sound options based on the program content.
 - When adjusting sound options (treble, bass, and front surround) manually, EZ Sound automatically switches **Custom**.
 - **Normal, Stadium, News, Music, and Theater** are preset for good sound quality at the factory and are not adjustable.
- 1** Press the **EZ SOUND** button repeatedly to select the appropriate sound setup as shown below: **Custom** (your own settings), **Normal, Stadium, News, Music, and Theater**.
 - You can also adjust **EZ Sound** in the **AUDIO** menu.
 - 2** Press **EXIT** button to save and return to TV viewing.

Manual Sound Control (EZ Sound-Custom option)

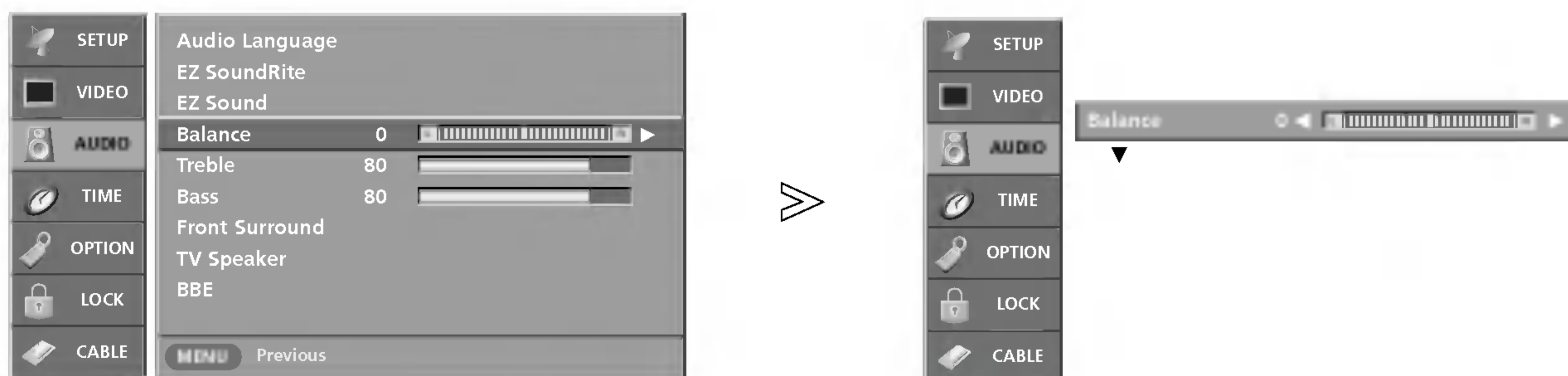



- Adjust the sound to suit your taste and room situations.
- 1** Press the **MENU** button and then use **▲ / ▼** button to select the **AUDIO** menu.
 - 2** Press the **▶** button and then use **▲ / ▼** button to select the desired sound option (**Balance, Treble, or Bass**).
 - 3** Press the **▶** button and then use **◀ / ▶** button to make appropriate adjustments.
 - 4** Press **EXIT** button to return to TV viewing or press **MENU** button to return to the previous menu.

Stereo/SAP Broadcasts Setup

- This TV can receive MTS stereo programs and any SAP (Secondary Audio Program) that accompanies the stereo program; if the station transmits an additional sound signal as well as the original one.
 - When having selected Stereo or SAP button on the remote control, this TV can only receive the signal in case that the TV station transmits the proper signals.
 - Mono sound is automatically received if the broadcast is only in Mono; even though Stereo or SAP has been selected.
 - Select Mono if you want to listen to the mono sound in remote fringe areas during stereo/SAP broadcasting.
 - Stereo or SAP can be received in Analog channel.
- 1** Use the **SAP** button to select your desired MTS mode in analog signal. Each time you press the **SAP** button, **Mono**, **Stereo**, or **SAP** appear in turn.
 - If other languages available on the digital signal, select them with the **SAP** button.
 - 2** Press **EXIT** button to save and return to TV viewing.

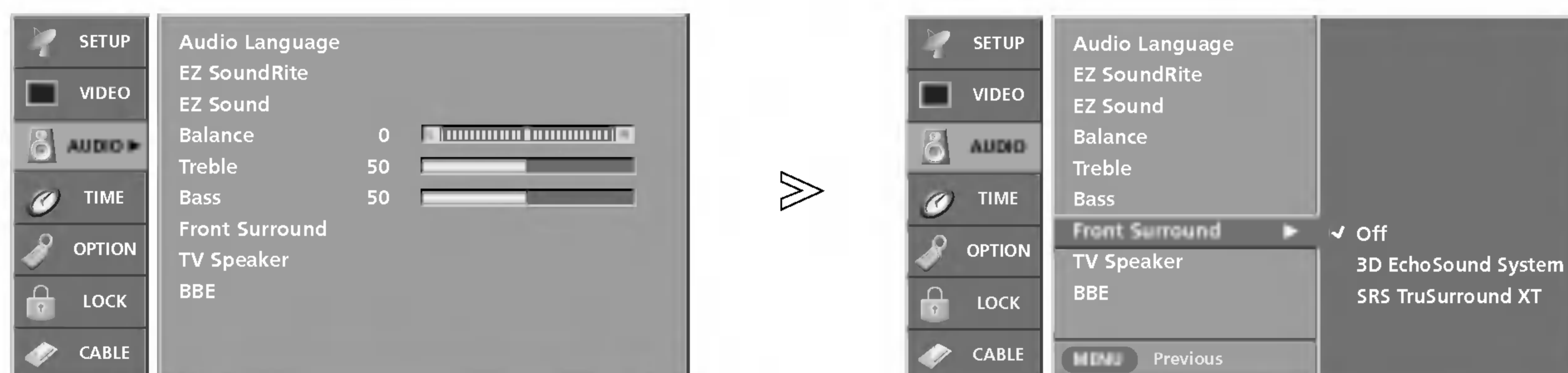
Front Surround



-  is a trademark of SRS Labs, Inc.
 - TruSurround XT technology is incorporated under license from SRS Labs, Inc.
 - Manufactured under license from Dolby Laboratories. "Dolby" and the double-D symbol are trademarks of Dolby Laboratories.
- 1** Press the **MENU** button and then use **▲ / ▼** button to select the **AUDIO** menu.
 - 2** Press the **▶** button and then use **▲ / ▼** button to select **Front Surround**.
 - 3** Press the **▶** button and then use **▲ / ▼** button to select **Off**, **3D EchoSound System** or **SRS** (Sound Retrieval System) **TruSurround XT**.
 - 4** Press **EXIT** button to return to TV viewing or press **MENU** button to return to the previous menu.

Mini Glossary

SRS TruSurround XT

Takes advantage of any multi-channel format without needing to add extra speakers or equipment. Dialog clarity, bass enrichment, and the addition of stereo audio enhancement that produces an immersive sound experience from standard stereo material.

3D EchoSound System

Creates a stunning simulated stereo effects from any mono sound and a realistic three-dimensional sound with a very wide and deep sound stage from stereo sound.



Audio Menu Options continued

TV Speakers On/Off Setup

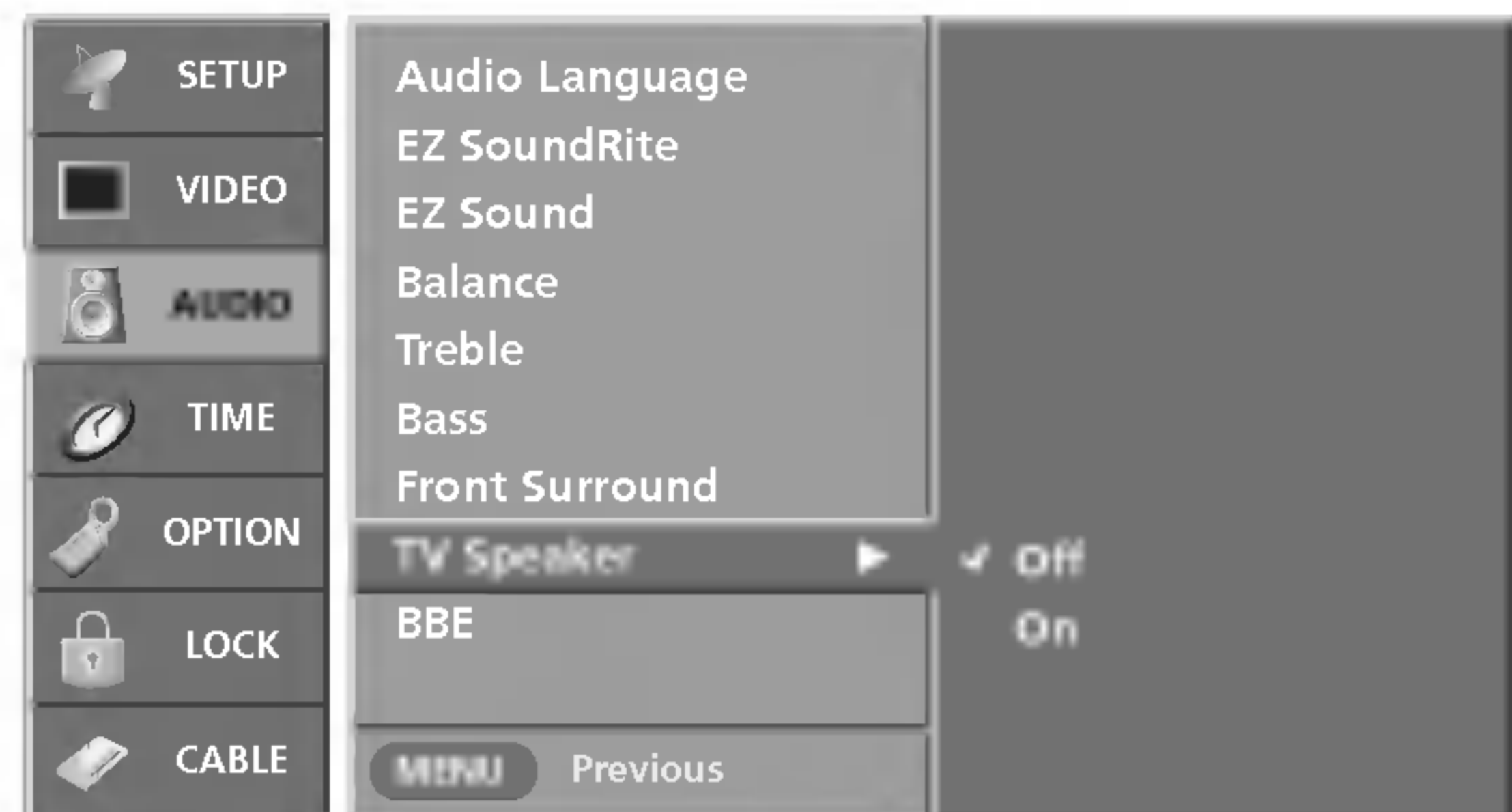
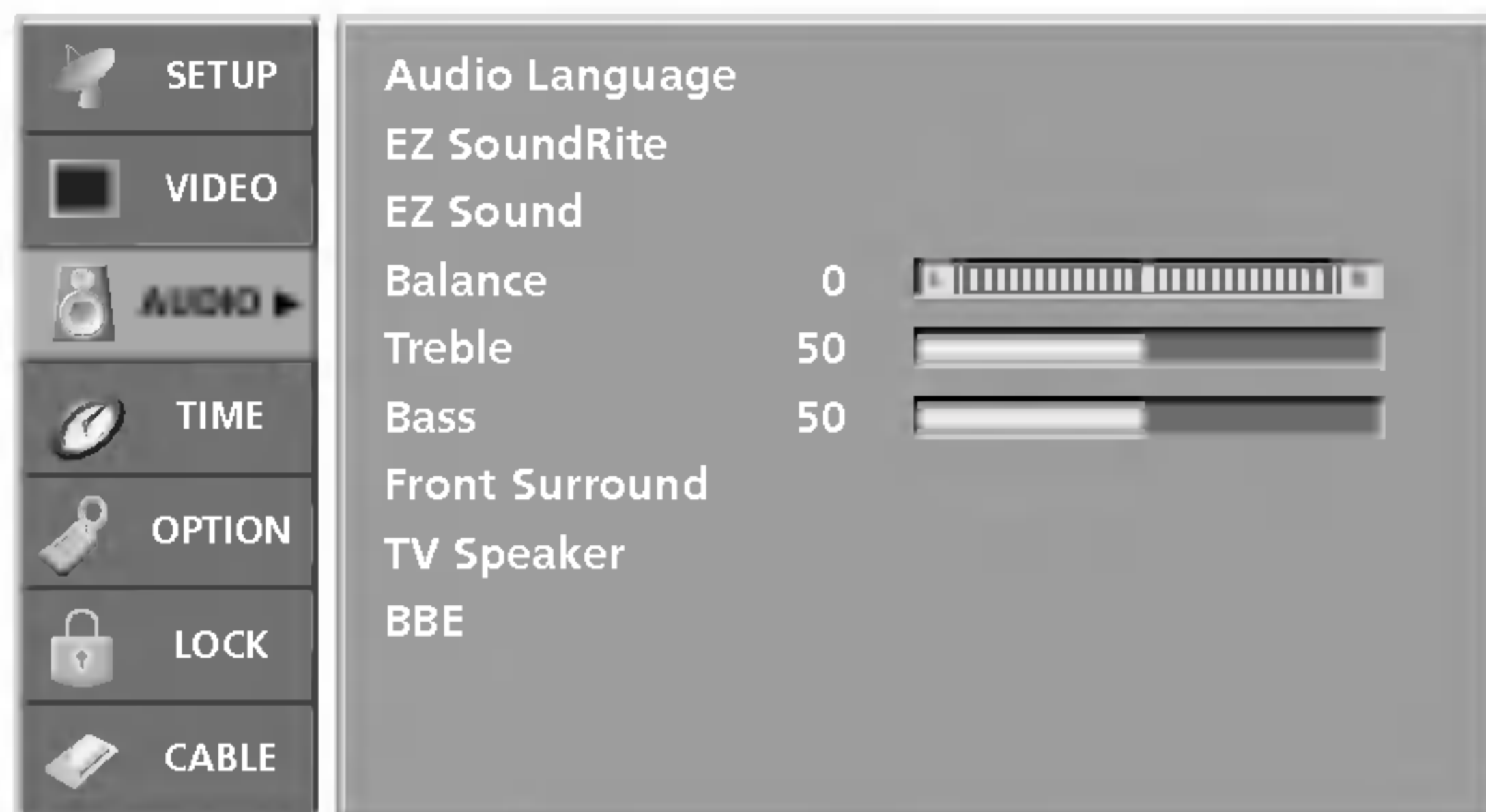

- Turn TV speakers off if using external audio equipment. Feature turns the TV Speakers option On or Off.

- 1 Press the **MENU** button and then use **▲ / ▼** button to select the **AUDIO** menu.
- 2 Press the **▶** button and then use **▲ / ▼** button to select **TV Speaker**.
- 3 Press the **▶** button and then use **▲ / ▼** button to select **Off** or **On**.
- 4 Press **EXIT** button to return to TV viewing or press **MENU** button to return to the previous menu.

BBE

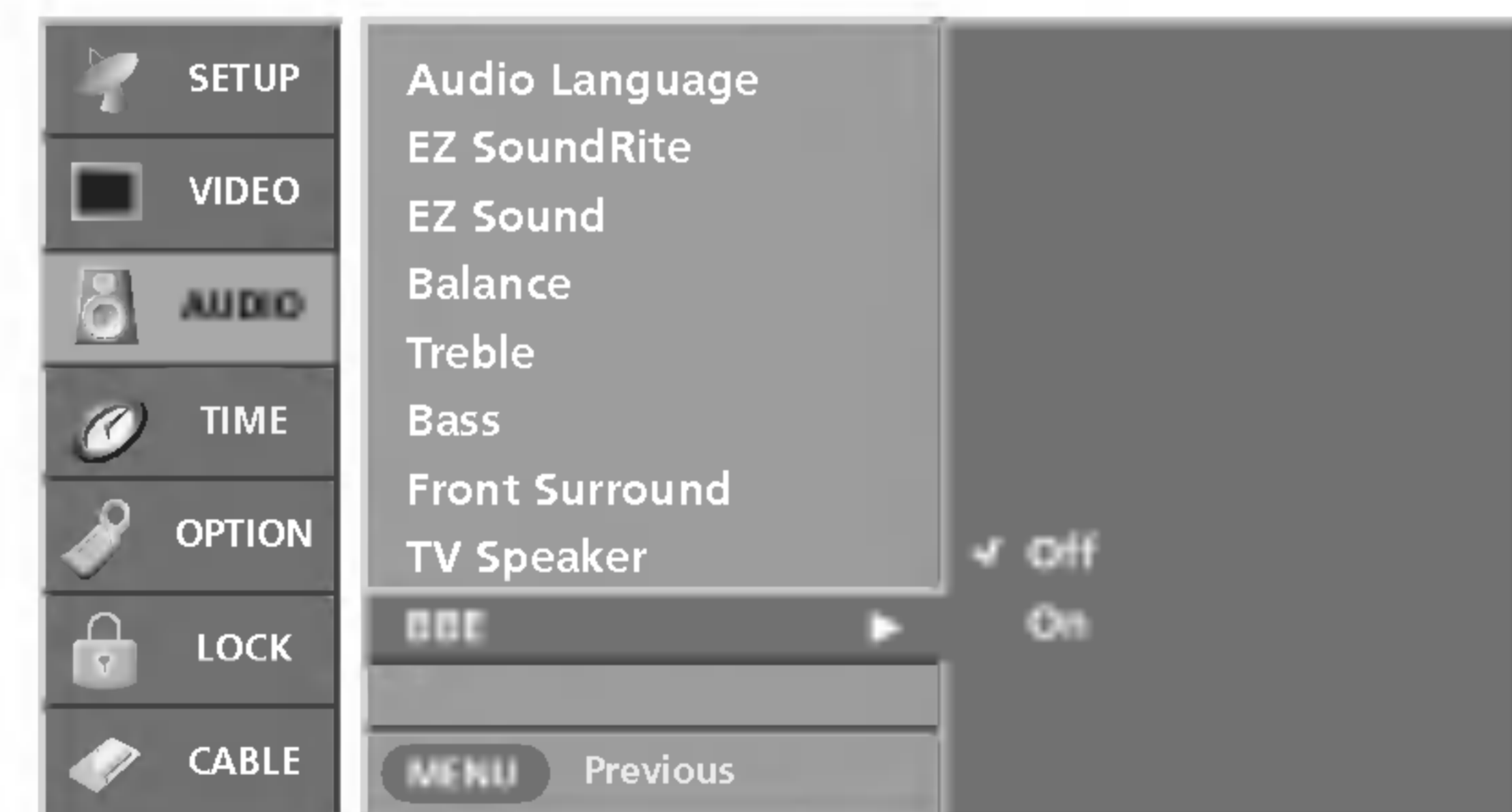
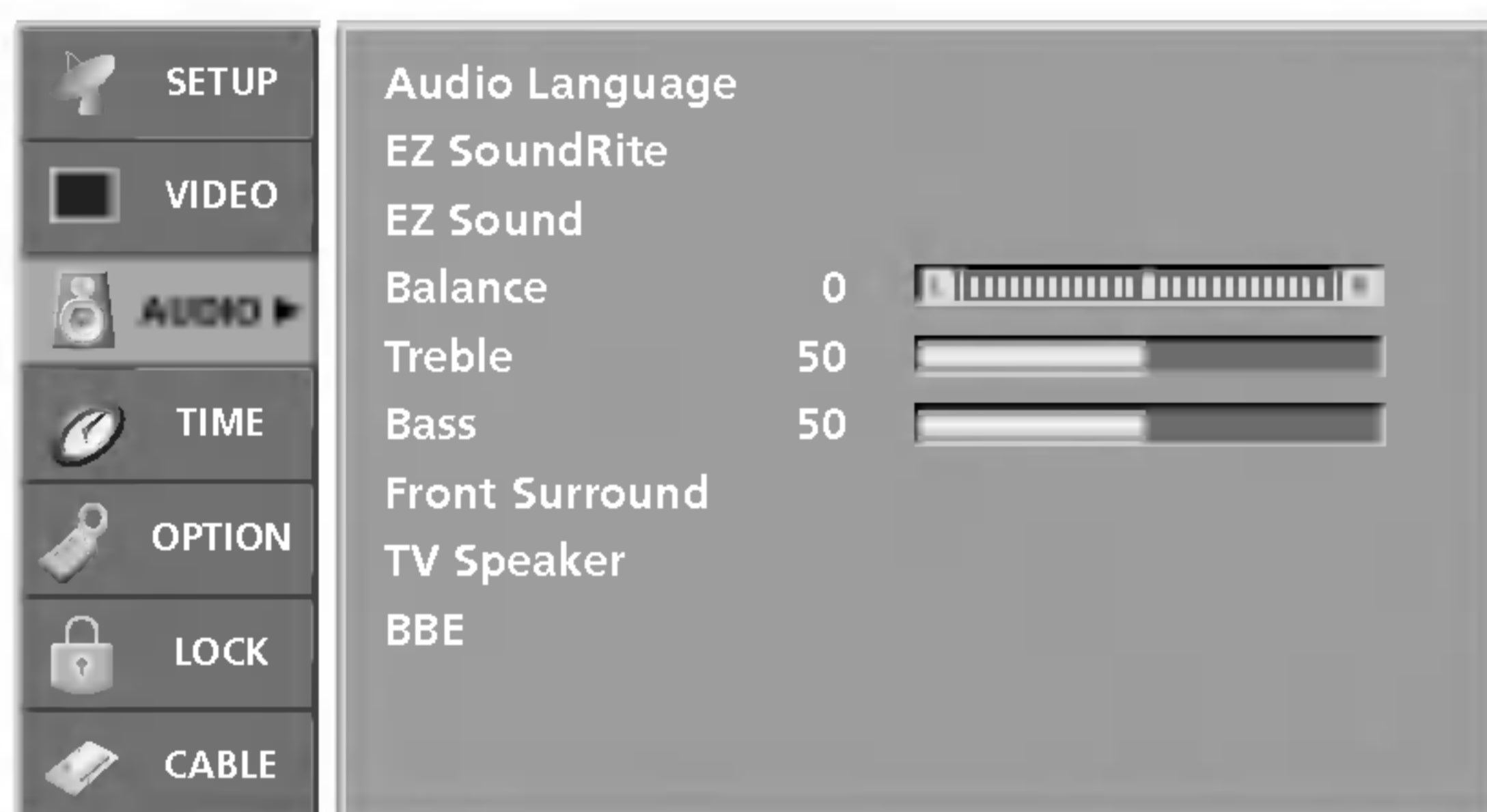

- *BBE High Definition Sound restores clarity and presence for better speech intelligibility and music realism.*

- 1 Press the **MENU** button and then use **▲ / ▼** button to select the **AUDIO** menu.
- 2 Press the **▶** button and then use **▲ / ▼** button to select **BBE**.
- 3 Press the **▶** button and then use **▲ / ▼** button to select **Off** or **On**.
- 4 Press **EXIT** button to return to TV viewing or press **MENU** button to return to the previous menu.

- **BBE**®. Manufactured under license from BBE Sound, Inc.
- Treble, Bass or BBE aren't suitable for SRS TSXT mode.

Time Menu Options

Auto Clock Setup



- The time is set automatically from a digital channel signal.
- The digital channel signal includes information for the current time provided by the broadcasting station.
- Set the clock manually, if the current time is set incorrectly by the auto clock function.
- When you set up TV Guide On Screen system, **Auto Clock** menu is not selected.

- 1** Press the **MENU** button and then use **▲ / ▼** button to select the **TIME** menu.
- 2** Press the **▶** button and then use **▲ / ▼** button to select **Auto Clock**.
- 3** Press the **▶** button and then use **▲ / ▼** button to select **On**.
- 4** Press the **▶** button and then use **▲ / ▼** button to select your viewing area time zone.
 - U.S.A: **Eastern, Central, Mountain, Pacific, Alaska, or Hawaii.**
 - Canada: **Eastern, Central, Mountain, Pacific, Nfld, or Atlantic.**
- 5** Press the **▶** button and then use **▲ / ▼** button to select **Auto, Off, On**, depending on whether or not your viewing area observes Daylight Saving time.
- 6** Press **EXIT** button to return to TV viewing or press **MENU** button to return to the previous menu.

Manual Clock Setup



- If current time setting is wrong, reset the clock manually.
- When you set up TV Guide On Screen system, **Manual Clock** menu is not selected.

- 1** Press the **MENU** button and then use **▲ / ▼** button to select the **TIME** menu.
- 2** Press the **▶** button and then use **▲ / ▼** button to select **Manual Clock**.
- 3** Press the **▶** button and then use **◀ / ▶** button to select either the year, date, or time option. Once selected, use the **▲ / ▼** button to set the year, date, and time options.
- 4** Press **EXIT** button to return to TV viewing or press **MENU** button to return to the previous menu.

Time Menu Options continued

On/Off Timer Setup

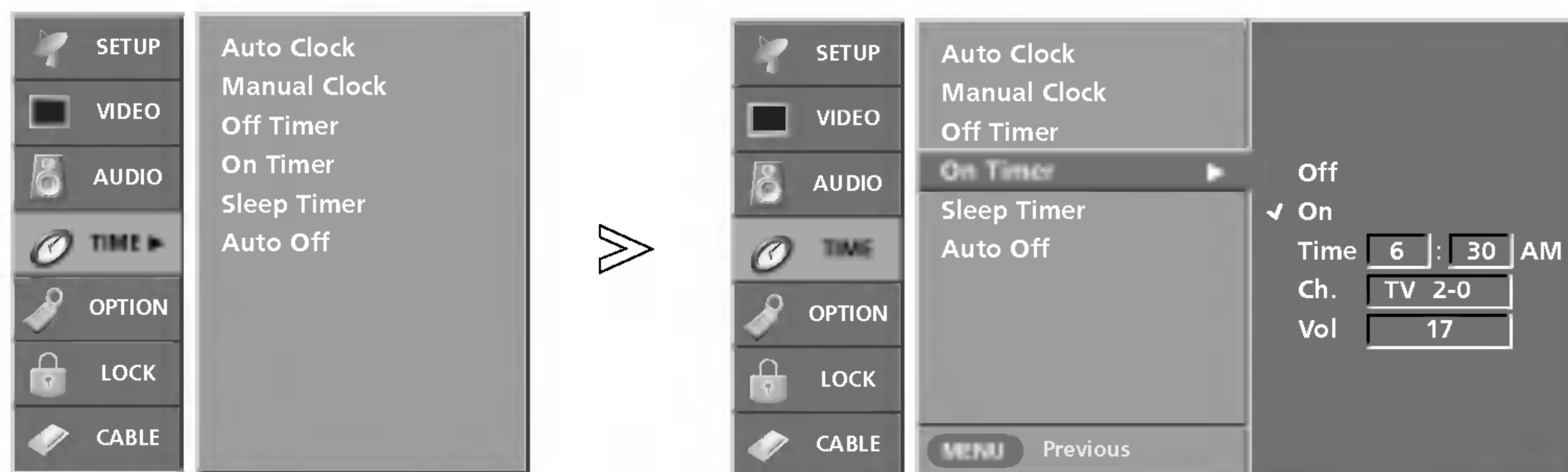

- Timer function operates only if current time has been set.
- Off-Timer function overrides On-Timer function if they are set both set to the same time.
- The TV must be in standby mode for the On-Timer to work.
- If you do not press any button within 2 hours after the TV turns on with the On Timer function, the TV will automatically revert to standby mode.

- 1** Press the **MENU** button and then use **▲ / ▼** button to select the **TIME** menu.
- 2** Press the **▶** button and then use **▲ / ▼** button to select **Off Timer** or **On Timer**.
- 3** Press the **▶** button and then use **▲ / ▼** button to select **On**.
 - To cancel **On/Off Timer** function, select **Off**.
- 4** Press the **▶** button and then use **▲ / ▼** button to set the hour.
- 5** Press the **▶** button and then use **▲ / ▼** button to set the minutes.
- 6 For only On Timer function**
 - Press the **▶** button and then use **▲ / ▼** button to select the channel at turn-on.
 - Press the **▶** button and then use **▲ / ▼** button to set the sound level at turn-on.
- 7** Press **EXIT** button to return to TV viewing or press **MENU** button to return to the previous menu.

Sleep Timer

- The Sleep Timer turns the TV off at the preset time. Note that this setting is cleared when the TV is turned off.
- You can also set up the **Sleep Timer** in the **TIME** menu.

- 1** Press the **TIMER** button repeatedly to select the number of minutes. First the **Off** option appears on the screen, followed by the following sleep timer options: 10, 20, 30, 60, 90, 120, 180, and 240 minutes.
- 2** When the number of minutes you want is displayed on the screen, press the **ENTER** button. The timer begins to count down from the number of minutes selected.
- 3** To check the remaining minutes before the TV turns off, press the **TIMER** button once.
- 4** To cancel the Sleep Timer, press the **TIMER** button repeatedly to select **Off**.

Auto Off



- If set to on and there is no input signal, the TV turns off automatically after 10 minutes.

- 1** Press the **MENU** button and then use **▲ / ▼** button to select the **TIME** menu.
- 2** Press the **▶** button and then use **▲ / ▼** button to select **Auto Off**.
- 3** Press the **▶** button and then use **▲ / ▼** button to select **Off** or **On**.
- 4** Press **EXIT** button to return to TV viewing or press **MENU** button to return to the previous menu.



Option Menu Features

Aspect Ratio Control

- Lets you choose the way an analog picture with a 4:3 aspect ratio is displayed on your TV with a 16:9 ratio picture format. When you receive an analog picture with a 4:3 aspect ratio on your 16:9 TV, you need to specify how the picture is to be displayed.
- If you are viewing a picture with a 16:9 aspect ratio, you can't use the Horizon aspect ratio option.
- Horizon aspect ratio is not available for Component 1-2 (720p/1080i), RGB-DTV (720p/1080i), HDMI/DVI-DTV(720p/1080i), DTV (720p/1080i) input source.
- RGB-PC/DVI-PC input source use 4:3 or 16:9 aspect ratio.
- If a fixed image is displayed on the screen for a long time, that fixed image may become imprinted on the screen and remain visible.

- 1 Press the **RATIO** button repeatedly to select the desired picture format.
 - You can also adjust **Aspect Ratio** in the **OPTION** menu.
 - **Set By Program**
Selects the proper picture proportion to match the source's image. (4:3 → 4:3, 16:9 → 16:9)
 - **4:3**
Choose **4:3** when you want to view a picture with an original 4:3 aspect ratio, with black bars appearing at both the left and right sides.
 - **16:9**
Choose **16:9** when you want to adjust the picture horizontally, in a linear proportion to fill the entire screen.
 - **Horizon**
Choose **Horizon** when you want to adjust the picture in a non-linear proportion, that is, more enlarged at both sides, to create a panorama view.
 - **Zoom 1**
Choose **Zoom 1** when you want to view the picture without any alteration. However, the top and bottom portions of the picture will be cropped.
 - **Zoom 2**
Choose **Zoom 2** when you want the picture to be altered, both horizontally extended and vertically cropped. The picture taking a halfway trade off between alteration and screen coverage.
 - **Cinema Zoom**
Choose **Cinema Zoom** when you want to enlarge the picture in correct proportion. Note: When enlarging or reducing the picture, the image may become distorted.
You can adjust the enlarge proportion of Cinema Zoom using ▲ / ▼ button. The adjustment range is 1~16.

Cinema 3:2 Mode Setup



- Most movies are 24 frames/sec, but TV signal is 30 frames/sec.
- This option lets the TV do 3:2 pull-down operation for you to watch movies at the best motion appearance.
- This feature operates only in 480i mode.

- 1 Press the **MENU** button and then use **▲ / ▼** button to select the **OPTION** menu.
- 2 Press the **▶** button and then use **▲ / ▼** button to select **Cinema 3:2 Mode**.
- 3 Press the **▶** button and then use **▲ / ▼** button to select **Off** or **On**.
- 4 Press **EXIT** button to return to TV viewing or press **MENU** button to return to the previous menu.

Caption



- 1 Press the **MENU** button and then use **▲ / ▼** button to select the **OPTION** menu.
- 2 Press the **▶** button and then use **▲ / ▼** button to select **Caption**.
- 3 Press the **▶** button and then use **▲ / ▼** button to select **Off** or **On**.
- 4 Press **EXIT** button to return to TV viewing or press **MENU** button to return to the previous menu.



Option Menu Features continued

Caption/Text

* Analog Broadcasting System Captions



- Select a caption mode for displaying captioning information if provided on a program.
- Analog caption displays information at any position on the screen.
- Text displays information, usually at the bottom position and is used for a data service.
- Caption/Text, if provided by the broadcaster, would be available for both digital and analog channels on the Antenna/Cable.
- This TV is programmed to remember the caption/text mode it was last set to, when you turn the power off.

- 1** Use the **CC** button repeatedly to select Caption **Off**, **CC1**, **CC2**, **CC3**, **CC4**, **Text1**, **Text2**, **Text3**, or **Text4**.
 - **EZ Mute** shows the selected captions option (if available on program) when the TV sound is muted.
- 2** Press **EXIT** button to save and return to TV viewing.

- 1** Press the **MENU** button and then use **▲ / ▼** button to select the **OPTION** menu.
- 2** Press the **▶** button and then use **▲ / ▼** button to select **Caption/Text**.
- 3** Press the **▶** button and then use **▲ / ▼** button to select caption: **CC1**, **CC2**, **CC3**, **CC4**, **Text1**, **Text2**, **Text3**, or **Text4**.
 - **CAPTION**
The term for the words that scroll across the bottom of the TV screen; usually the audio portion of the program provided for the hearing impaired.
 - **TEXT**
The term for the words that appear in a large black frame and almost cover the entire screen; usually messages provided by the broadcaster.
- 4** Press **EXIT** button to return to TV viewing or press **MENU** button to return to the previous menu.

* Digital Broadcasting System Captions

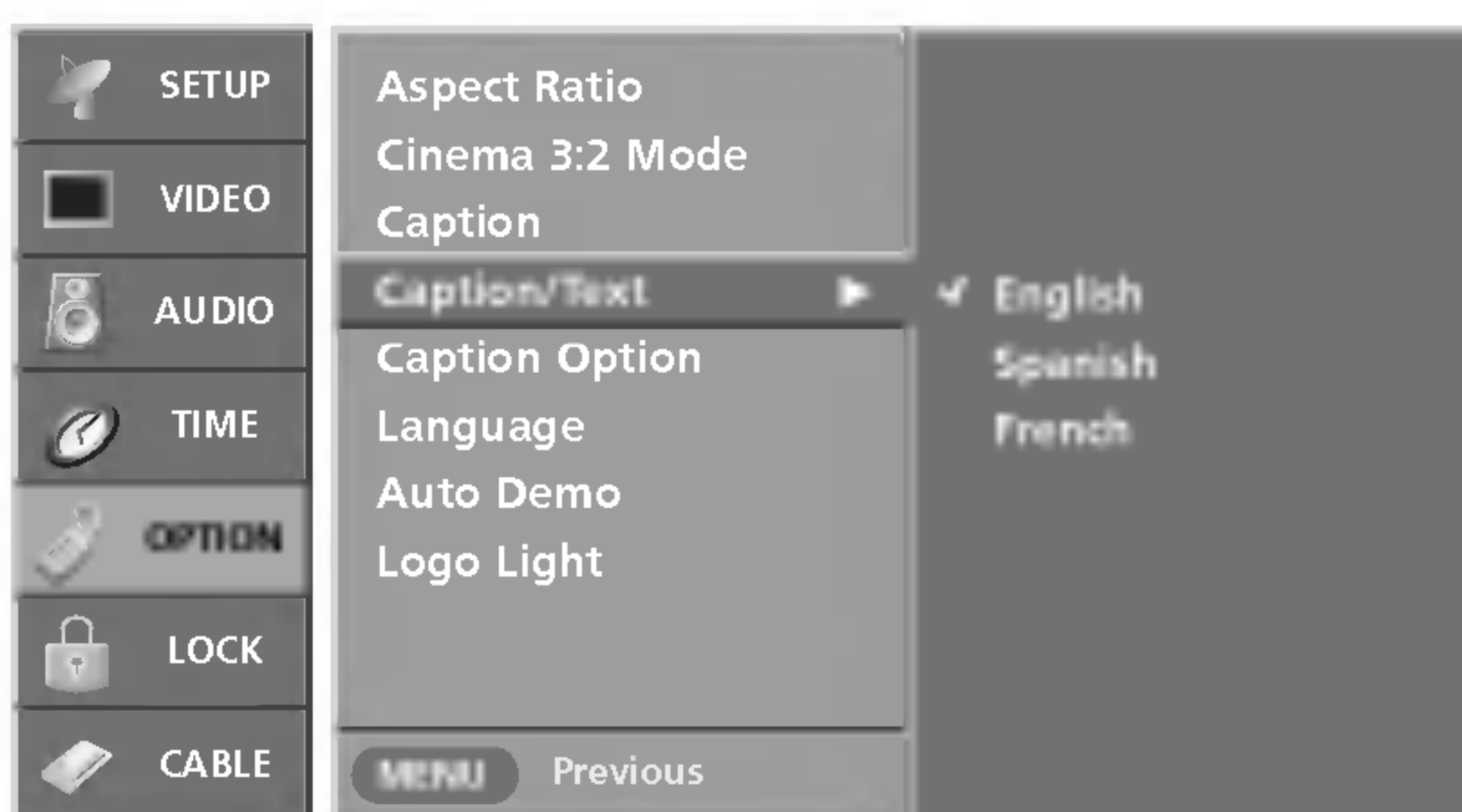
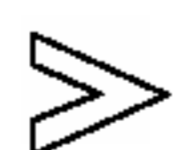
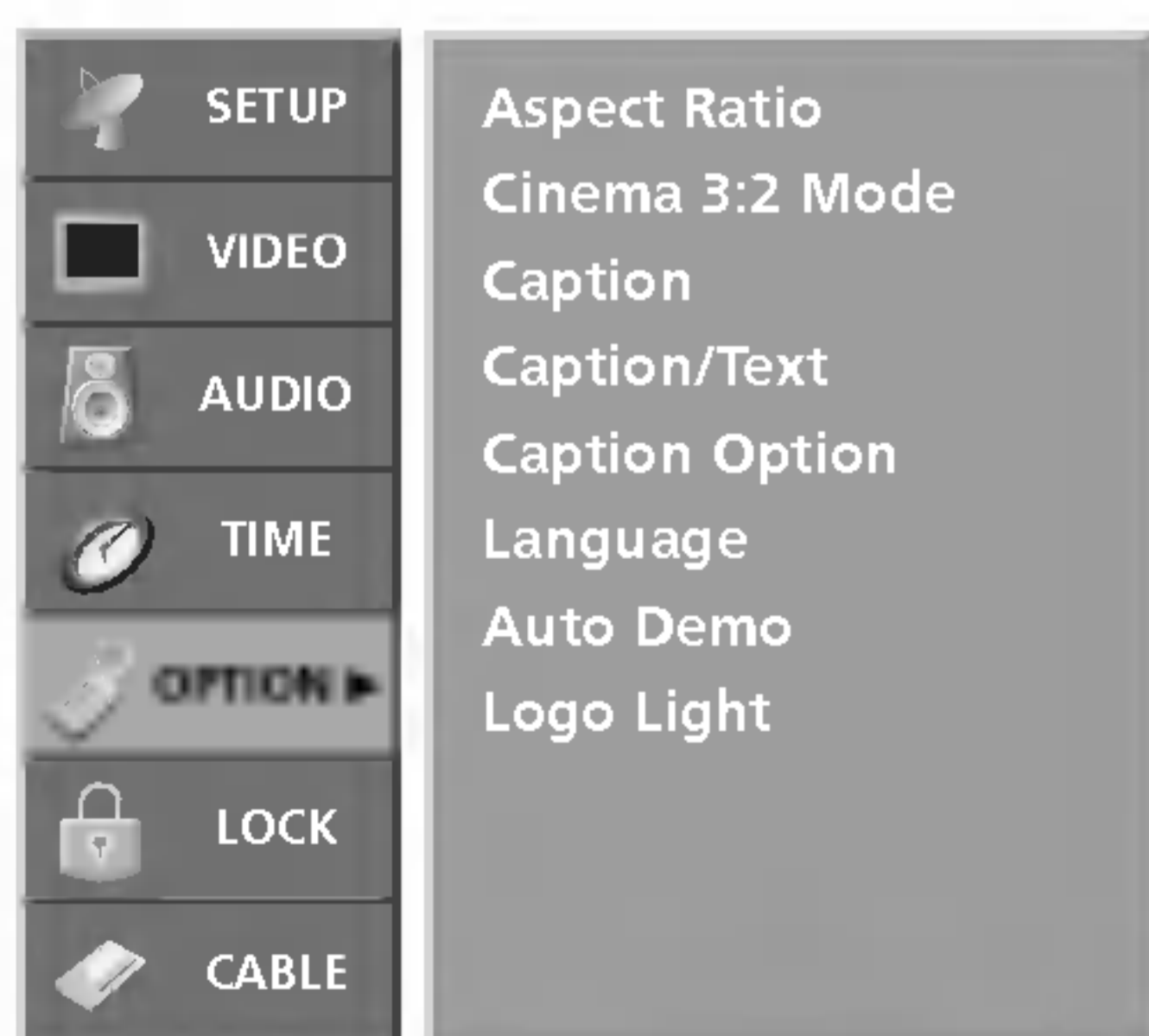

- Choose the language you want the DTV/CADTV Captions to appear in.
- Other languages can be chosen for digital sources only if they are included on the program.

- 1** Press the **MENU** button and then use **▲ / ▼** button to select the **OPTION** menu.
- 2** Press the **▶** button and then use **▲ / ▼** button to select **Caption/Text**.
- 3** Press the **▶** button and then use **▲ / ▼** button to select available caption languages: **English**, **Spanish**, or **French**.
- 4** Press **EXIT** button to return to TV viewing or press **MENU** button to return to the previous menu.

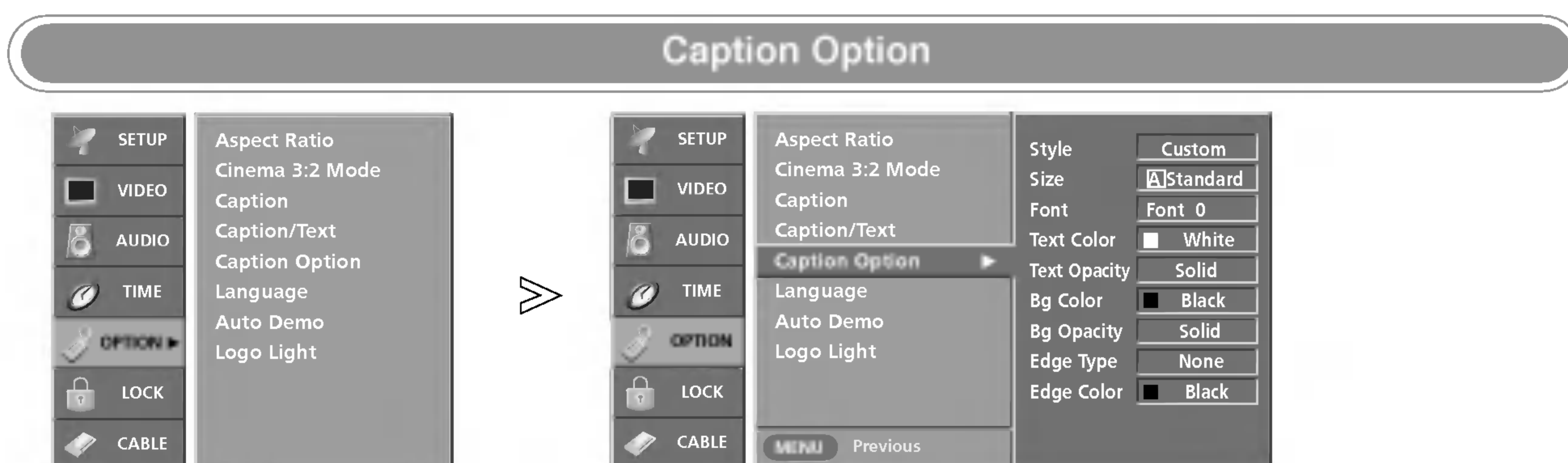

- Customize the DTV/CADTV captions that appear on your screen.

- 1 Press the **MENU** button and then use **▲ / ▼** button to select the **OPTION** menu.
- 2 Press the **▶** button and then use **▲ / ▼** button to select **Caption Option**.
- 3 Press the **▶** button and then use **◀ / ▶** button to select **Custom**.
- 4 Use **▲ / ▼** button to customize the Style, Font, etc., to your preference. A preview icon is provided at the bottom of the screen, use it to see the caption language.
 - **Size**: Set the size the words will appear in.
 - **Font**: Select a typeface for the words.
 - **Text Color**: Choose a color for the text.
 - **Text Opacity**: Specify the opacity for the text color.
 - **Bg (Background) Color**: Select a background color.
 - **Bg (Background) Opacity**: Select the opacity for the background color.
 - **Edge Type**: Select an edge type.
 - **Edge Color**: Select a color for the edges.
- 5 Press **EXIT** button to return to TV viewing or press **MENU** button to return to the previous menu.

Auto Demo (Review)

- Displays the slide show to explain the main features of this TV.
- You can also set up the **Auto Demo** in the **OPTION** menu.
- **Note**: The images on the Auto demo may differ from the actual products.

- 1 Press the **AUTO DEMO** button.
- 2 The auto demonstration to starts.
- 3 Press **EXIT** button to stop Auto Demo.

Option Menu Features continued

Logo Light

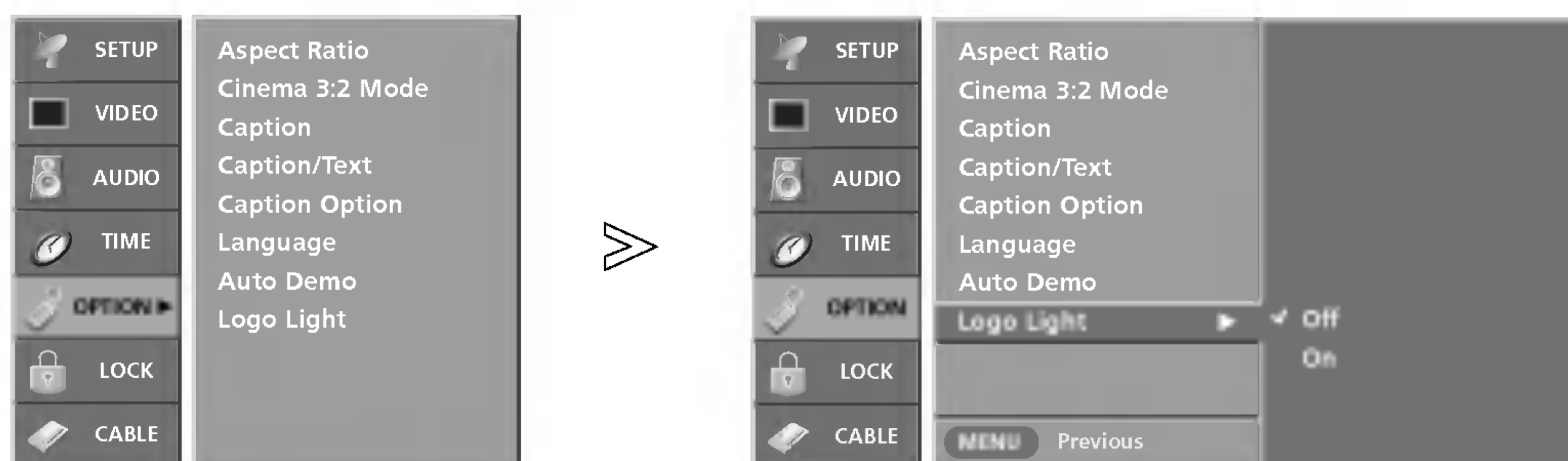

- If you select on, LG logo or "Liquid Crystal Display" of TV front panel turns on.

- 1** Press the **MENU** button and then use **▲ / ▼** button to select the **OPTION** menu.
- 2** Press the **▶** button and then use **▲ / ▼** button to select **Logo Light**.
- 3** Press the **▶** button and then use **▲ / ▼** button to select **Off** or **On**.
- 4** Press **EXIT** button to return to TV viewing or press **MENU** button to return to the previous menu.

Freeze & Magnify (DTV/CADTV 720p or 1080i mode only)



- Enlarges the picture with correct proportions.
- When enlarging the picture, the image may become distorted.
- The Magnify feature is available only in 720p or 1080i mode, but the **FREEZE** button works in all video formats.

- 1** Press the **FREEZE** button in 720p, or 1080i modes.
- 2** Use the **▲ / ▼ / ◀ / ▶** buttons to select the screen section to be magnified.
- 3** To return to normal viewing, press the **FREEZE** button again.

Lock Menu Options

Parental Control can be used to block specific channels, ratings and other viewing sources.

The Parental Control Function (V-Chip) is used to block program viewing based on the ratings sent by the broadcasting station. The default setting is to allow all programs to be viewed. Viewing can be blocked by the type of program and by the categories chosen to be blocked. It is also possible to block all program viewing for a time period. To use this function, the following must be done :

1. Set ratings and categories to be blocked.
2. Specify a password
3. Enable the lock

V-Chip rating and categories

Rating guidelines are provided by broadcasting stations. Most television programs and television movies can be blocked by TV Rating and/or Individual Categories. Movies that have been shown at the theaters or direct-to-video movies use the Movie Rating System (MPAA) only.

For USA

Ratings for Movies previously shown in theaters:

Movie Ratings :

- Blocking Off (Permits all programs)
- G (General audience)
- PG (Parental guidance suggested)
- PG-13 (Parents strongly cautioned)
- R (Restricted)
- NC-17 (No one 17 and under admitted)
- X (Adult only)

If you set PG-13 : G and PG movies will be available, PG-13, R, NC-17 and X will be blocked.

Ratings for Television programs including made-for-TV movies :

- TV-G (General audience)
- TV-PG (Parental guidance suggested)
- TV-14 (Parents strongly cautioned)
- TV-MA (Mature audience only)
- TV-Y (All children)
- TV-Y7 (Children 7 years older)

TV Rating-Children:

- Age (applies to TV-Y, TV-Y7)
- Fantasy Violence (applies to TV-Y7)

TV Rating-General:

- Age (applies to TV-G, TV-PG, TV-14, TV-MA)
- Dialogue- sexual dialogue (applies to TV-PG, TV-14)
- Language- adult language (applies to TV-PG, TV-14, TV-MA)
- Sex- sexual situations (applies to TV-PG, TV-14, TV-MA)
- Violence (applies to TV-PG, TV-14, TV-MA)

Input Block

- Video 1, 2 (On, Off)
- Component 1, 2 (On, Off)
- RGB and HDMI/DVI (On, Off)

For Canada

TV Rating-English:

- E (Exempt)
- C (Children)
- C8+ (8 years and up)
- G (General programming. Suitable for all audiences)
- PG (Parental guidance suggested)
- 14+ (Viewers 14 years and up)
- 18+ (Adult programming)
- Blocking off (Permits all programming)

TV Rating-French:

- E (Exempt)
- G (General)
- 8 ans+ (8 years and up)
- 13 ans+ (13 years and up)
- 16 ans+ (16 years and up)
- 18 ans+ (Adults only)
- Blocking off (Permits all programming)

Input Block

- Video 1, 2 (On, Off)
- Component 1, 2 (On, Off)
- RGB and HDMI/DVI (On, Off)

Parental Lock Setup

** For U.S.A.*

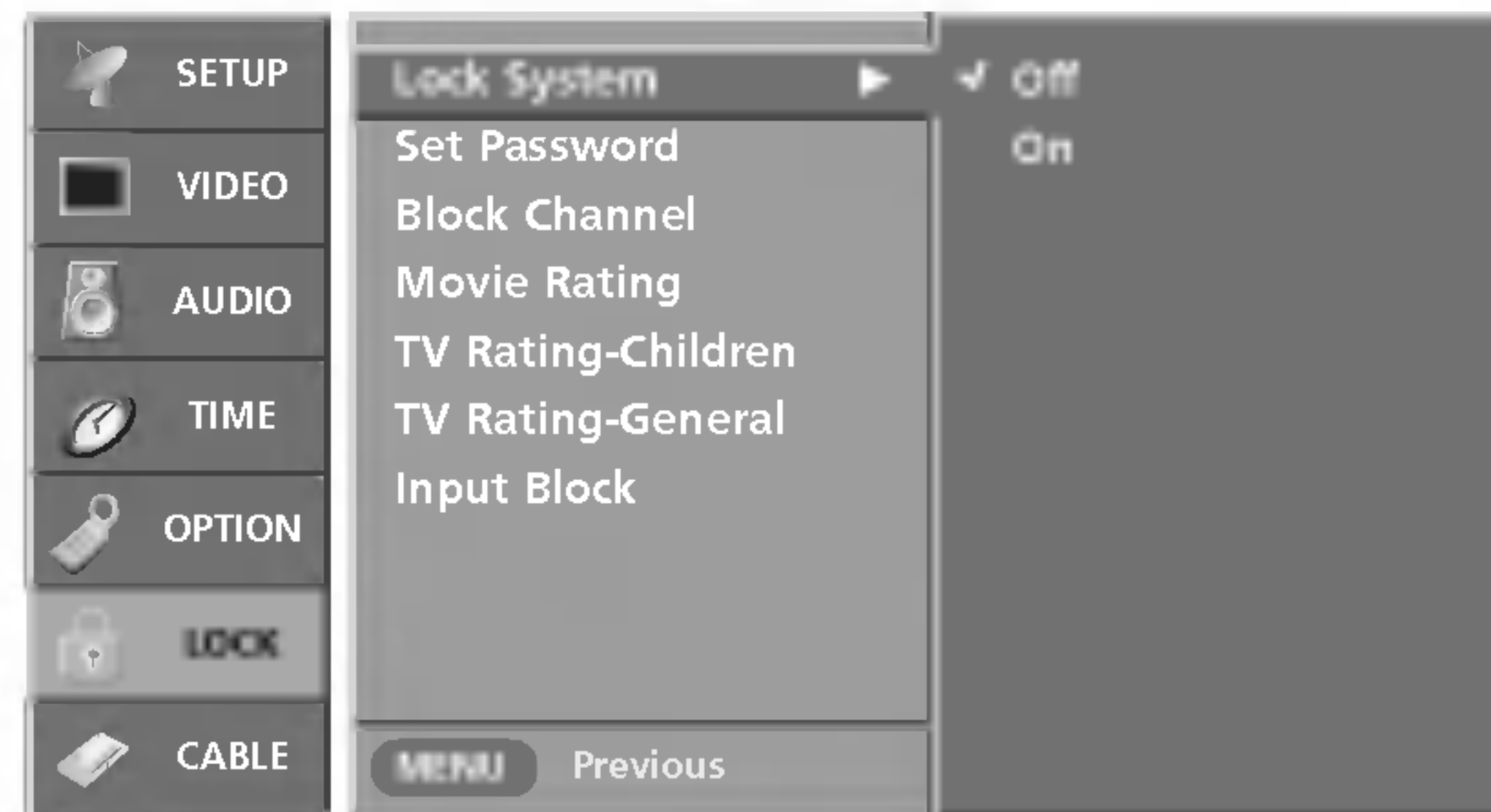

** For Canada*

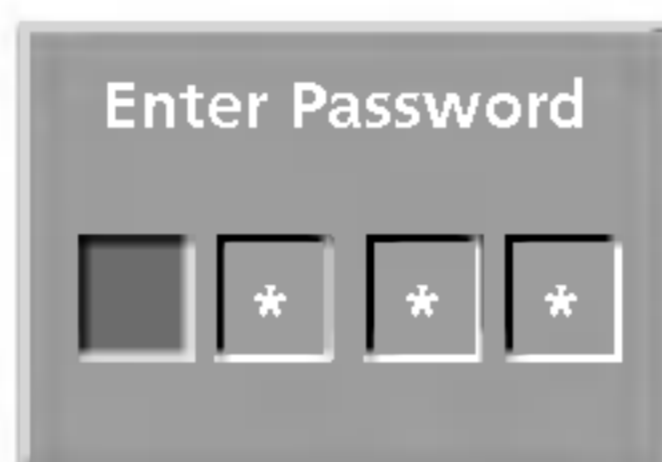

- Set up blocking schemes to block specific channels, ratings, and external viewing sources.
- A password is required to gain access to this menu if the Lock System is turned on.

- 1** Press the **MENU** button and then use **▲ / ▼** button to select the **LOCK** menu. Then, press the **▶** button
 - If **Lock** is already set, enter the password as requested.
 - The TV is set up with the initial password "0-0-0-0".
- 2** Use the **▲ / ▼** button to choose from the following Lock Menu options. Once the option is selected, change the settings to your preference.
 - **Lock System:** Activates or disables the blocking scheme you set up previously.
 - **Set Password:** Change the password by inputting a new password twice.
 - **Block Channel.:** Select a channel number that you wish to block.
 - **Input block:** Enables you to select a source to block from the external source devices you have hooked up.
 - ◆ **For USA**
 - **Movie Rating (MPPA):** Blocks movies according to the movie ratings limits specified, so children cannot view certain movies. You can set the ratings limit by blocking out all the movies with the ratings above a specified level. Keep in mind that the movie ratings limit only applies to movies shown on TV, not TV programs, such as soap operas.
 - **TV Rating-Children:** Prevents children from watching certain children's TV programs, according to the ratings limit set. The children rating does not apply to other TV programs. Unless you block certain TV programs intended for mature audiences in the TV Rating - sub menu, your children can view those programs.
 - **TV Rating-General:** Based on the ratings, blocks certain TV programs that you and your family do not want to view.
 - ◆ **For Canada**
 - **TV Rating-English / TV Rating-French:** Selecting canadian English /French language rating system.
- 3** Press **EXIT** button to return to TV viewing or press **MENU** button to return to the previous menu.



- If you ever forget your password, key in '7', '7', '7', '7' on the remote control.

CableCARD™ Function

- Your TV's OSD (On Screen Display) may differ slightly from what is shown in this manual.

Cable Menu Options

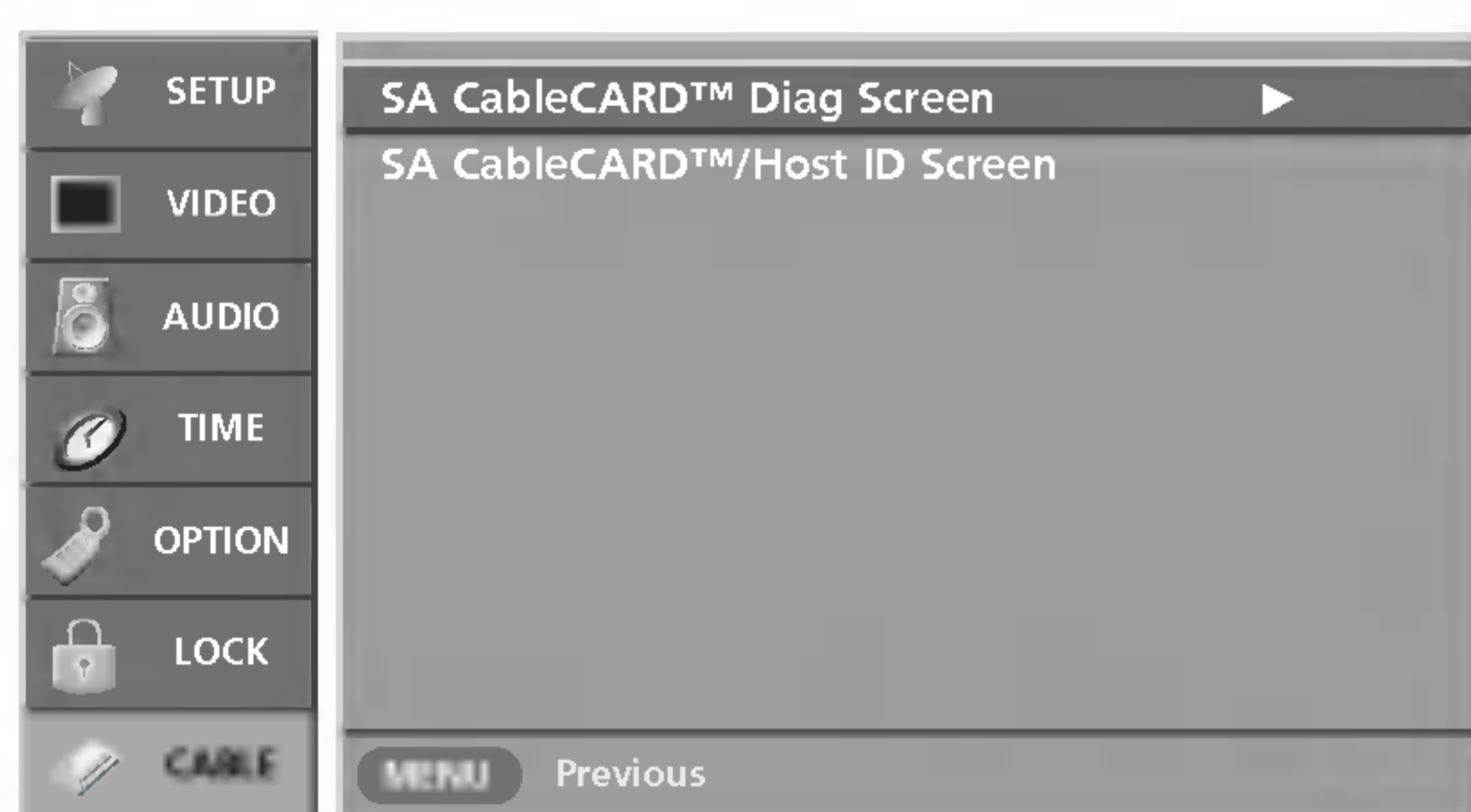

In case of Scientific Atlanta CableCARD™



i.e) CableCARD™/ Host ID Screen

As shown, the pairing number means your TV and CableCARD™ ID. For further information regarding cable TV service, contact your local cable TV service provider(s).

- The Cable sub menu displays when inserting the CableCARD™ to the TV.

1 Press the **MENU** button and then use **▲ / ▼** button to select the **CABLE** menu.

- The CableCARD™ type is Motorola, Scientific Atlanta (SA), or SCM etc. The OSD (On screen display) is different from your TV according to your CableCARD™ type.

2 Press the **▶** button and then use **▲ / ▼** button to select to select your desired item.

3 Press the **▶** button.

4 Press **EXIT** button to return to TV viewing.

Scrambled Channel

- Insert the CableCARD™. It takes about 1 minute to exchange the data between the TV and the CableCARD™. Then the screen displays as shown to the right.
- Let your cable TV service provider know your CableCARD ID and Host ID.
- Once the card is registered with the cable TV service provider, you can watch the premium or high value channel without a message.



- If the certificate doesn't match between the TV and the CableCARD™, the OSD (On screen display) displays as shown left.



CableCARD™ Function continued

Cable Channel List

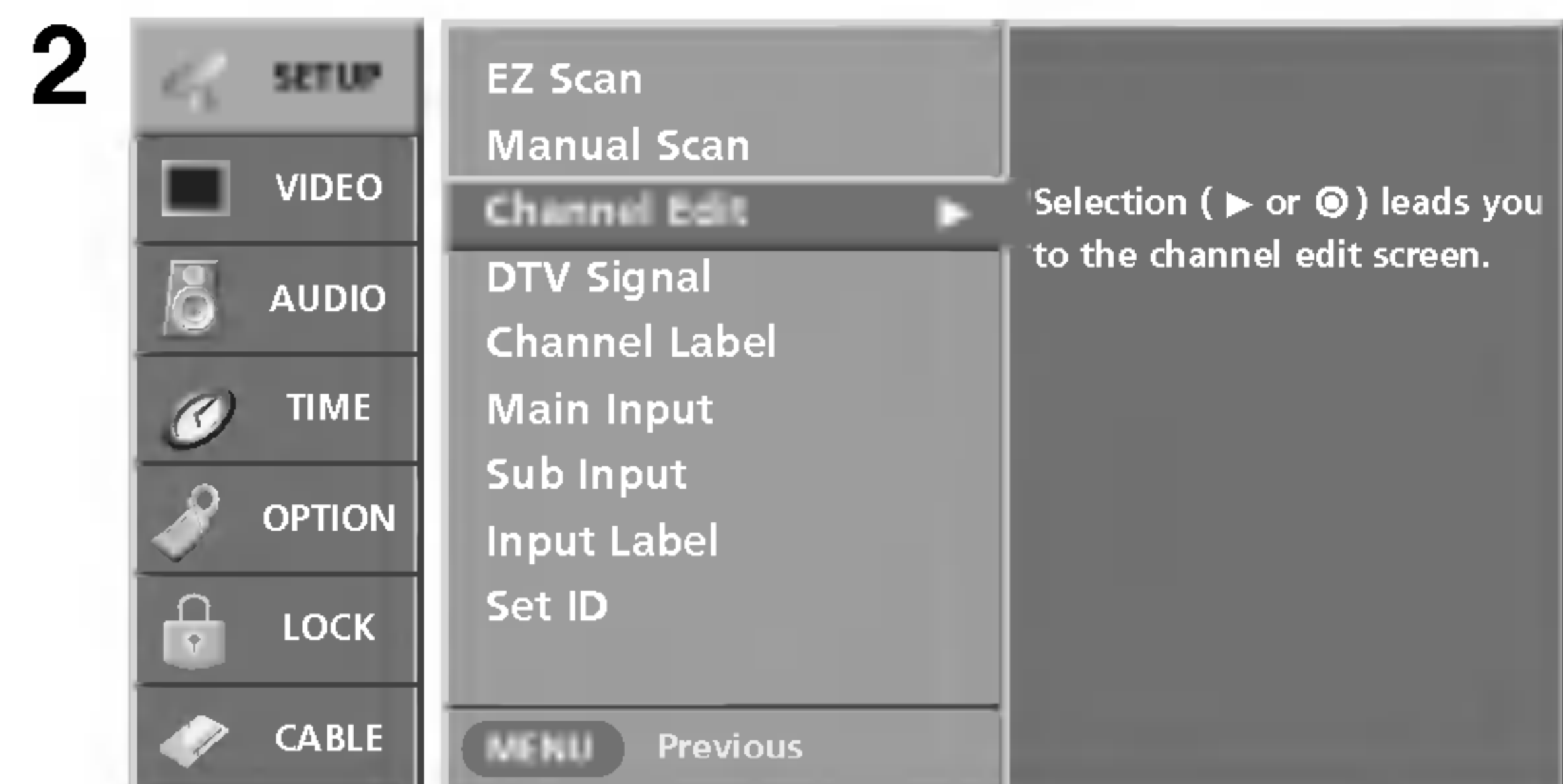
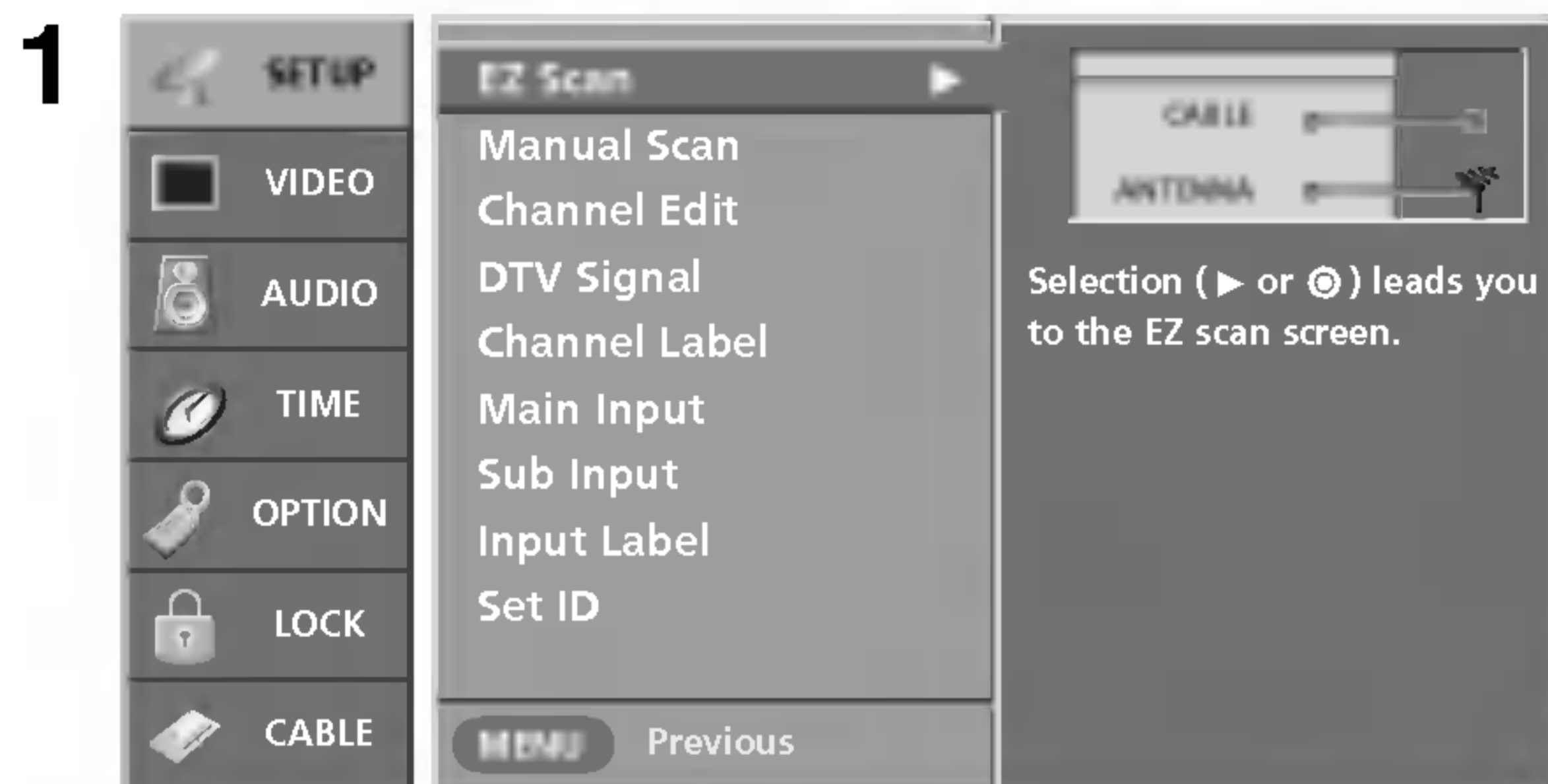

- 1** If you enter the **Channel Edit** after running the EZ Scan without CableCARD™, you can see the cable channel list as shown in the picture 3 above.
- 2** Insert the CableCARD™. The TV receive a new cable channel list. It takes about 2-3 minutes to gather the cable channel list after inserting the CableCARD™ (It will occasionally will take longer).

Emergency Alert Message

- If an emergency situation occurs while watching TV/DTV/CATV/CADTV, you will receive a message from the cable TV service provider(s).
- When receiving an emergency message, the message is displayed on the screen as shown or the channel is changed automatically to a channel for more information. The message will automatically disappear after a short time and return to the last channel.



Brief Info.

What is Brief Info?

- : Brief Info shows the present screen information.
- : On Watching with the upper Input signal, press the **INFO** button.

How to use?

1. Press the **INFO** button to show the Brief Info on the screen.
 2. Press the **INFO** button or **EXIT** button to exit.
- The **INFO** button does not work in Component1, Component2, RGB, and HDMI/DVI modes.

This function works in the following mode:

- Watching TV/DTV/CATV/CADTV
- Watching Video1, Video2
- Watching IEEE 1394

The diagram shows a Brief Info overlay on a video of dolphins. The overlay contains the following information:

- Program title:** Brief Info Title Test Brief Info T tle Test Brief Inf...
- Day, Month, Year:** SAT, Jan 20, 2005
- Program start time:** 7:00PM
- Program progress bar:** A progress bar showing the current position.
- Program finish time:** 6:55AM
- Present time:** 11:43AM
- Banner information:** DTV 2-1, Dolby Digital, HD, and a character set ABCDEFGHIJ...
- Icons:** Multilingual, Caption, 1080i, TV-PG, D L S V.

Legend:

- 4:3** The original aspect ratio of the video is 4:3
- 16:9** The original aspect ratio of the video is 16:9 (wide)
- 480i** The video resolution is 720x480i
- 480p** The video resolution is 720x480p
- 720p** The video resolution is 1280x720p
- 1080i** The video resolution is 1920x1080i
- Multilingual** Multilingual: The program contains two or more audio services. Press the **SAP** button to select wanted Audio.
- CC** Caption: The program contains one or more caption services. Press the **CC** button to select wanted Closed caption.
- TV-PG** The program contains V-Chip information. Refer to the **LOCK** menu: D (Dialogue), L (Language), S (Sex), V (Violence), FV (Fantasy Violence)

PIP (Picture-In-Picture)/POP/Twin Picture

- PIP lets you view 2 different inputs (sources) on your TV screen at the same time. One source will be large, and the other source will show a smaller inset image.
- Twin Picture mode splits the screen into 2, allowing 2 picture sources to be shown on the TV screen at the same time. Each source is given half the screen.

Watching PIP/POP/Twin Picture

Press the **PIP** button to access the sub picture. Each press of PIP changes the PIP options as shown below.



Selecting an Input Signal Source for PIP/Twin Picture

Use the **PIP INPUT** button to select the input source for the sub picture. Each press of **PIP INPUT** button changes the PIP source. You can also select sources for the **Sub Input** in the **SETUP** menu.

Main Picture Source	Available Sub Picture Sources
DTV Signal	Analog, Video1, and Video2
Analog Signal	DTV, Analog, Video1, and Video2

TV Program Selection for PIP

1. Press the **PIP** button.
2. Select the Antenna or Cable option on the Sub input menu or with the **PIP INPUT** button. Use the **PIPCH+** / **PIPCH-** button to select a channel for the sub picture. (You can't select DTV for main and sub picture simultaneously).

Moving the PIP Sub Picture



In PIP mode, press the **▲ / ▼ / ◀ / ▶** button to move the sub picture to a different location on the screen.

Adjusting Main and Sub Picture Sizes for Twin Picture

Use the ▲ / ▼ / ◀ / ▶ button to change main and sub picture sizes in Twin Picture mode.

i.e)



If screen is adjusted to the maximal size, the large screen is filled with entire screen vertically as shown.

Swapping the PIP/Twin Picture

Use the **SWAP** button to switch the main and sub pictures.

- Component 1, Component 2, RGB-PC (or RGB-DTV), HDMI/DVI input sources for the main picture can't be used to swap the main and sub pictures.

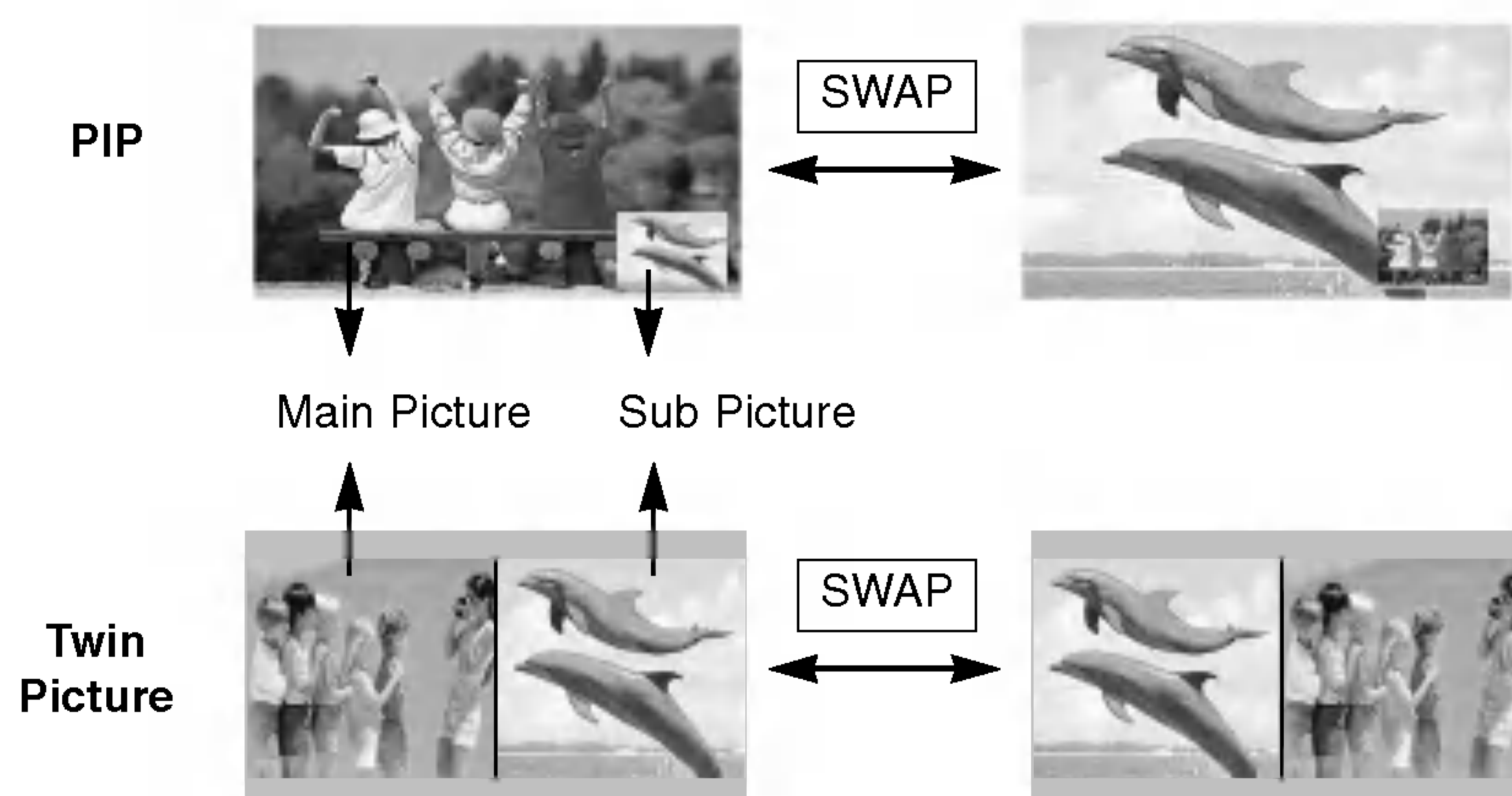

POP (Picture-out-of-Picture: Channel Scan)

- Use POP to search the programs of all the memorized channels one-by-one on the 3 PIP screen display, (while the main picture source remains the current channel). The pictures of all the programmed channels are searched with the 3 POP screen.
- Run EZ Scan channel search before using POP mode.
- When Sub pictures are changed from the TV/DTV to CATV/CADTV in POP mode, it may make a noise from the Tuner switch.

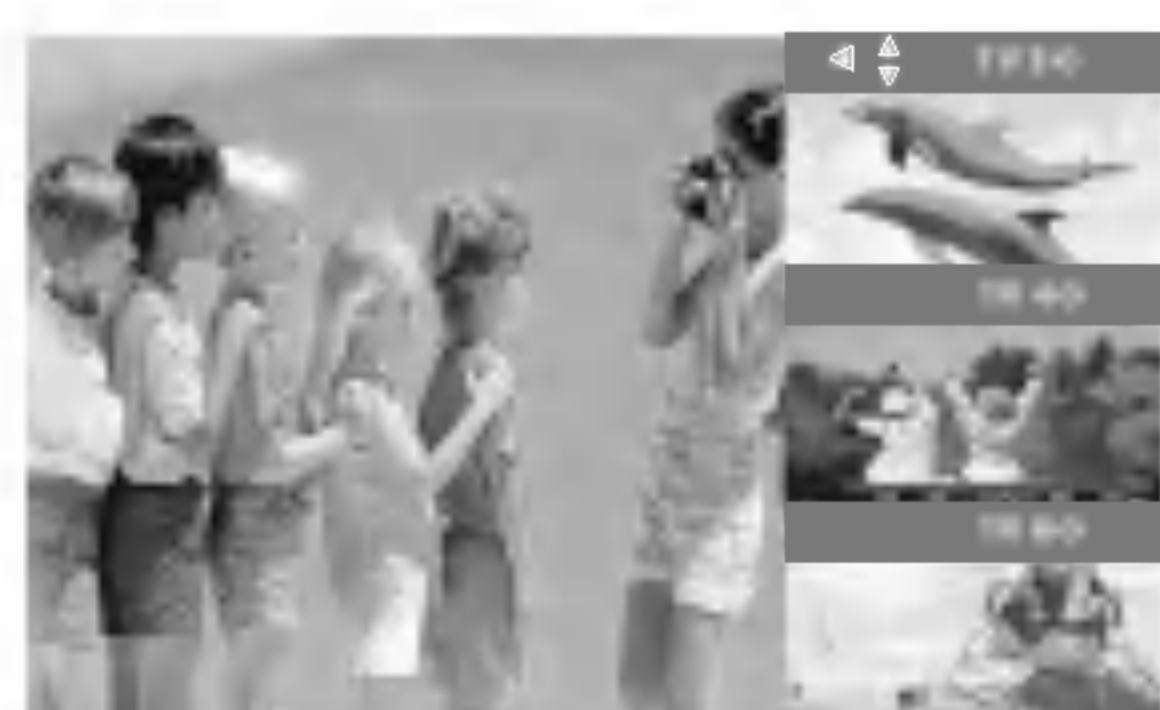

1. Press the **PIP** button to activate the POP mode while in PIP mode.
 - **Channel selection:** Use ◀ button to enlarge the selected channel being searched on the PIP screen to shift it for viewing on the Main screen.
 - **PIP selection:** Use ▲ / ▼ button to select one of 3 PIP screen pictures in POP mode.
 - When watching TV on Main picture, TV or DTV on Sub pictures are in channel scanning. However, when watching DTV on Main picture, only TV on Sub picture is in channel scanning.
2. Press the EXIT button to cancel POP mode.

Notes on Memory card

What is Memory Card

This TV will display images or play music from a memory card from a digital camera, camcorder, MP3 player, notebook or PDA.

Precaution for Using the Memory Card

- Insert the memory card correctly.
- Don't insert metal substances into the slots of the memory card.
- Do not bend, drop or allow a strong shock to memory card.
- After pulling the memory card out from the TV, please keep the it in a appropriate case to prevent static shock.
- Stored data may be changed or lost as a result of misuse, static electricity.
- Do not turn the power off while using the memory card (loading or erasing).
- Don't eject the memory card while using the it. Otherwise, it may cause data loss or card damage.
- Only Insert one card to each slot.
- To prevent a change or loss for stored data, don't misuse the TV or don't let static electricity or electrical noise for TV.
- This Company takes no responsibility for problems such as the damage or malfunction that occurs while using the TV set, inappropriate TV settings, or any other reasons, except for defects or malfunctions intrinsic to the product.
- Ensure to use a memory card that lists the manufacturers name and serial number.
- The manufacturer shall not be responsible for damaged data. Be careful to avoid data damage, and back up your files.
- Make sure to comply with the following steps when ejecting a memory card.

Insert/Eject Memory Card

32/37/42LP1D Models Front Panel

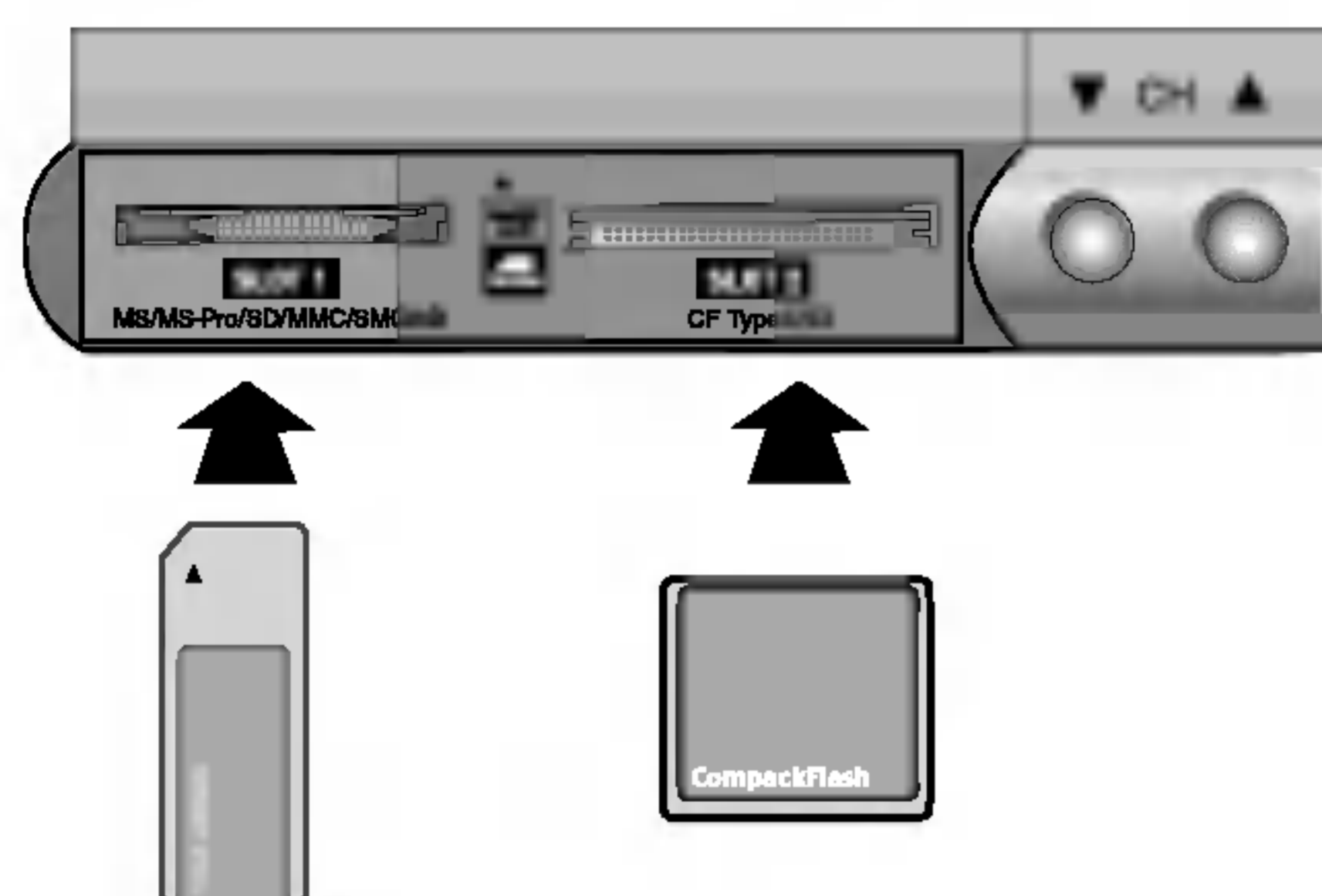

26/32LX1D, 26/32LX2D Models Side Panel

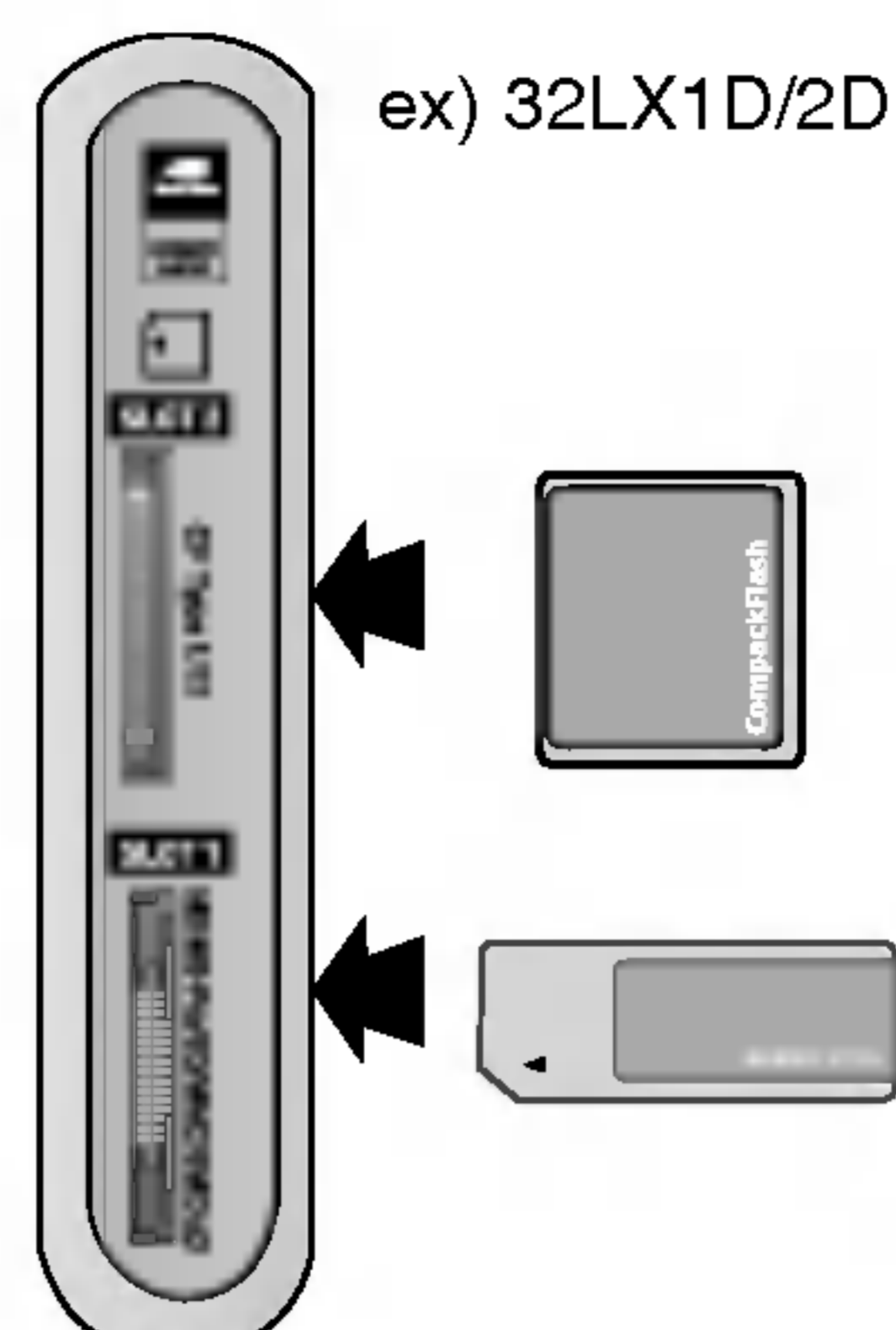

■ Insert card

1. Insert the card into the Slot 1 and/or Slot 2 with the hand softly and slowly.
2. Two slots support different types of the Memory Cards.
3. If Memory Card is not inserted, each slot is disable.

■ Eject card



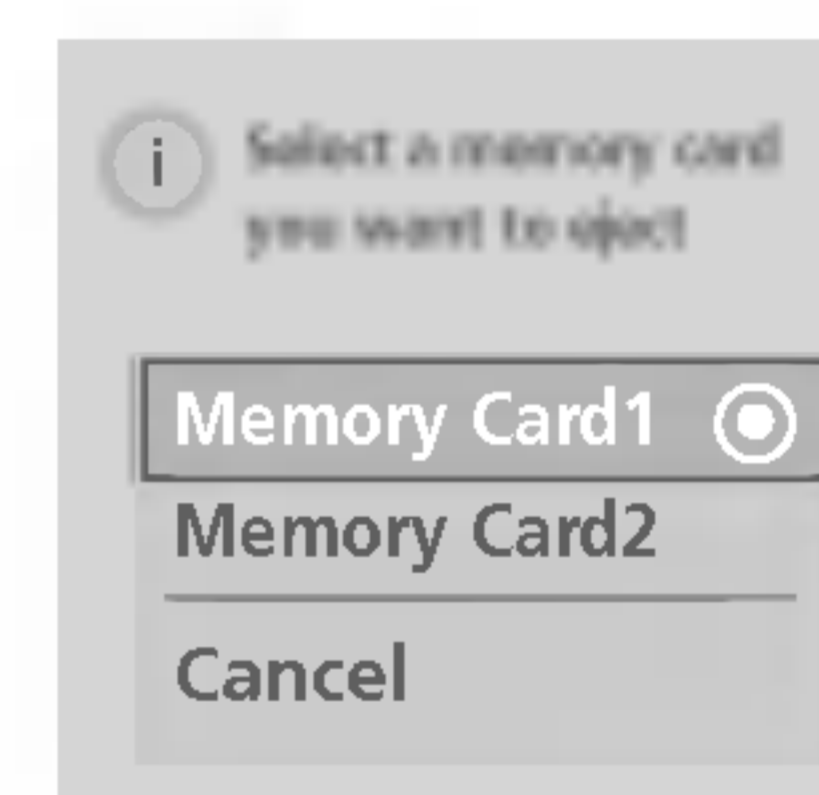



1. Press the **M/C EJECT** button on the remote control.
2. Press **▲ / ▼** button to select the **Memory Card 1** or **Memory Card 2** based on the inserted card location.
If **Cancel** is selected, OSD will disappear.
3. Press **ENTER** button and then eject the card from the slot.



- Do not insert or eject a card in one slot while the card in the other slot (slot 1 or slot 2) is in use, the product may run abnormally.
- Before you remove the memory card from the slot, don't forget to press the **M/C EJECT** button on the remote control, or the memory card may be damaged.

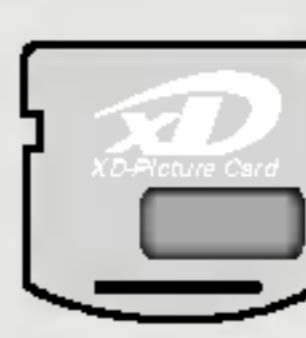

- Use the specified card based on the slot location.
- 9 types of Memory Card can be used for this TV.
- Some MagicStor Plus card is not complied with the TV.

Slot 1					Slot 2		
							
MMC <small>(MultiMedia Card)</small>	SD <small>(Secure Digital)</small>	SMC <small>(Smart Media Card)</small>	xD <small>(xD-Picture Card)</small>	MS / MS-Pro <small>(Memory Stick /Memory Stick Pro)</small>	CF I <small>(CompactFlash)</small>	CF II <small>(MD, Microdrive)</small>	CF II <small>(Magicstor)</small>

Supported Files

A sort of file	Photo Image (JPEG)	Music File (MP3)
Compatibility	*.jpg	*.mp3
Memory card capacity	CF: 4GB MD (Microdrive): 4GB CF+II (MagicStor): 2.2GB SD (Secure Digital): 1GB MMC (MultiMedia Card): 1GB An error may occur if you use a memory card with greater than the specified capacity.	MS (Memory Stick): 128MB MS Pro (Memory Stick Pro): 1GB SMC (Smart Media Card): 128MB xD (Extream Digital Picture Card): 512MB
Unsupported or damaged file	Unsupported or damaged JPEG or MP3 files can cause errors. Do not try to change the file extension of unsupported file types to the file extension of supported file types.	

XSTUDIO

- When you plug the Memory Card, this screen is displayed, automatically.

Basic Operation

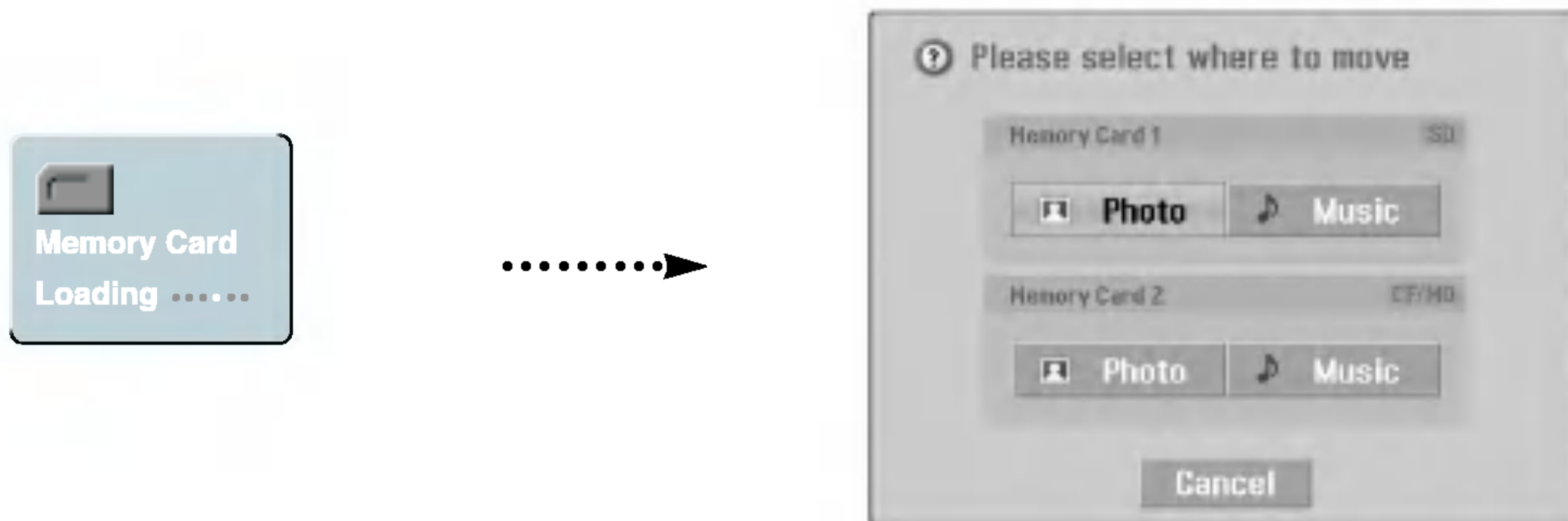

- When you plug a memory card or press the **XSTUDIO** button, the above screens will be displayed.

- **Note:** In 30 seconds later, "Loading" message is disappeared.

- 1** Insert the memory card to Slot 1 and/or Slot 2 on the TV.
- 2** Press ▲ / ▼ / ◀ / ▶ button to select photo or music for slot1/2.
- 3** Press the **ENTER** button to enter the photo or music media.
- 4** Press EXIT button or **XSTUDIO** button to return to TV viewing.

JPEG File Viewing Options

- When you select **Photo** in entry menu, you will now see a screen filled with thumbnail photos.

* In this manual, the OSD (On Screen Display) may be different from your TV's because it is just an example to help you with the TV operation.

Photo List OSD Display

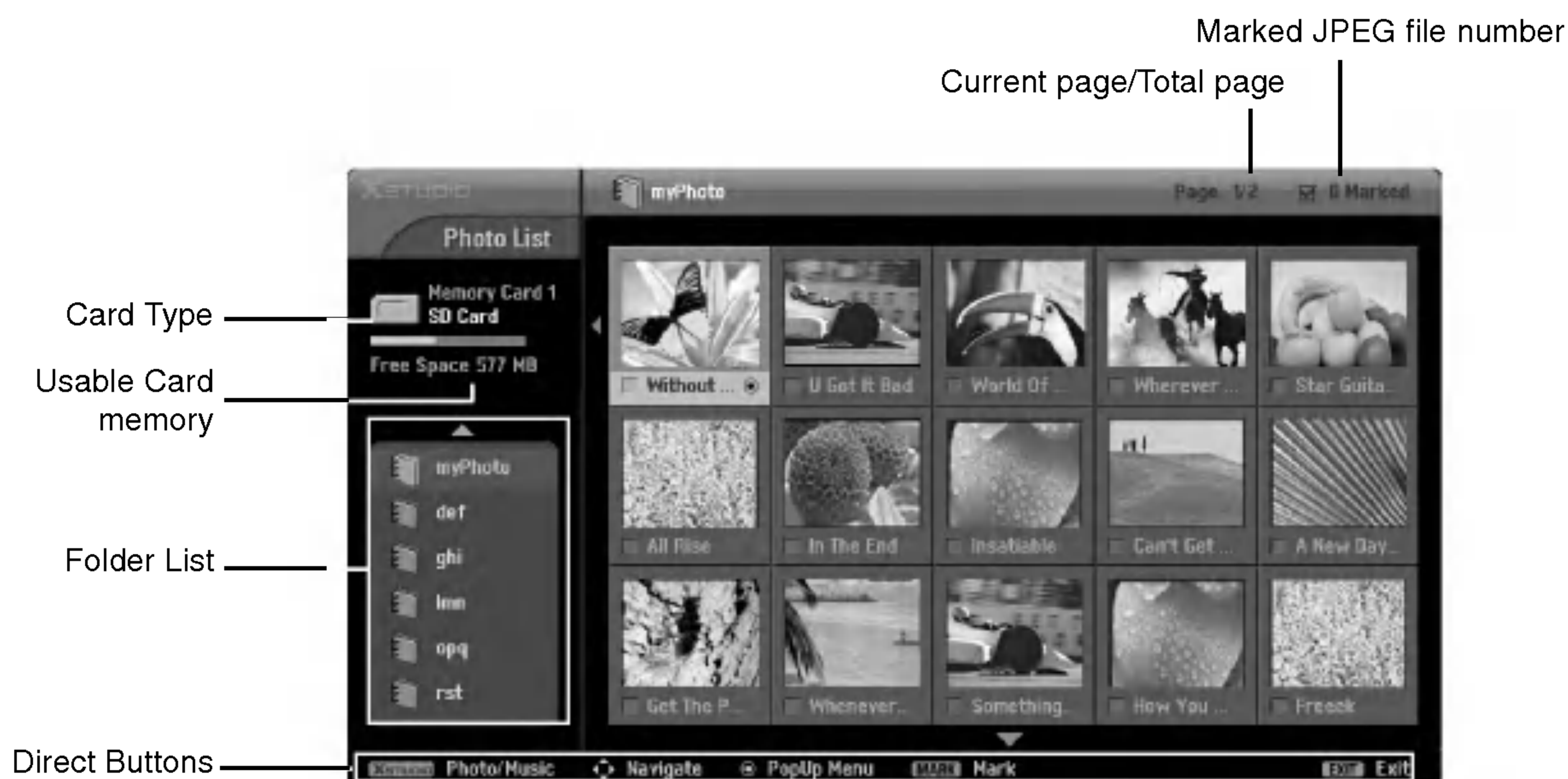

Picture Selection and Popup menu



- If you don't press any button for 40 seconds when using the JPEG file, the TV returns to the previous step.

- 1 Use the **CH ▲ / ▼** button to navigate thumbnail photos in pages.
- 2 Use **MARK** button to mark or unmark a photo. When one or more photos are marked, you can view or slideshow only the marked ones. If no photo is marked, you can view or slideshow all photos in the folder.
- 3 Use **▲ / ▼ / ◀ / ▶** button to navigate the appropriate thumbnail photos, then press the **ENTER** button to show the PopUp menu.
 - **View:** See the selected item to the full screen. View state change to slide show state by pressing the **PLAY (▶)** button.
 - **Slide Show:** Start a slide show with all photos in the folder. The slide show state can be changed to the view state by pressing the **Pause (||)** button. Before starting a slide show, you can choose the slide show interval (3,6 or 9 seconds). **Note:** 4 hours later, Slide Show is ended, automatically.
 - **Mark All:** Mark all photos on the screen.
 - **Unmark All:** Unmark all marked photos.
 - **Cancel:** Hide the pop-up menu.
- 4 Repeatedly, press **EXIT** button to return to TV viewing or press **XSTUDIO** button to return to the previous menu.

MP3 Files Playing Operation

- When you select **Music** in the entry menu, you will now see a screen filled with music titles.
- **Purchased MP3/music files may contain copyright restrictions. Playback of these files may not be supported by this model.**

Music List OSD Display

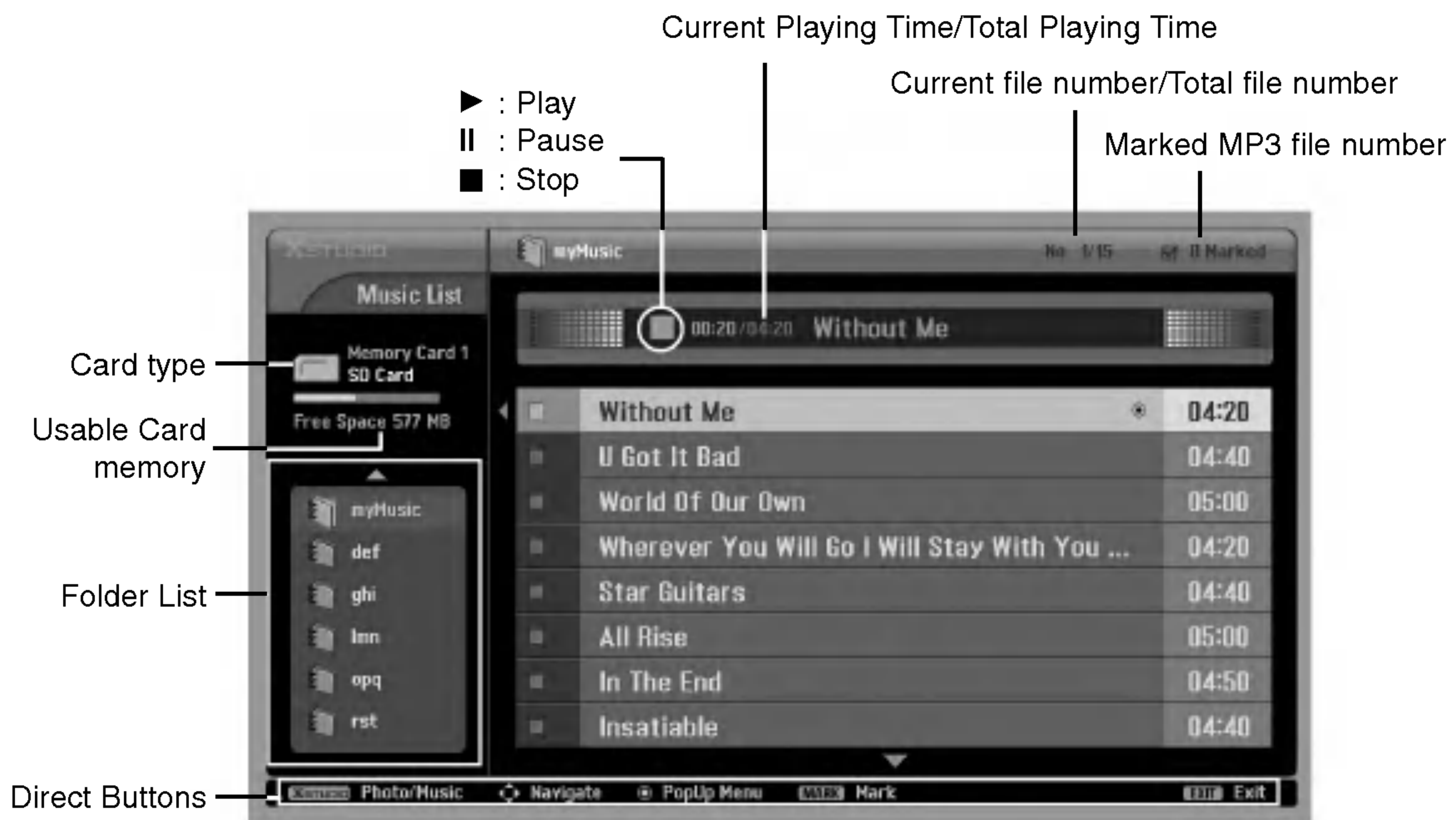

MP3 File Selection and Popup menu



- 1 Use the **CH ▲ / ▼** button to navigate music titles in pages.
- 2 Use **MARK** button to mark or unmark a music title. When one or more music titles are marked, the marked music will be played by turns. For example, if you want to listen to only one music repeatedly, just mark the music only and play it. If no music title is marked, all the music in the folder will be played in sequence.
- 3 Use **▲ / ▼** button to navigate the appropriate music titles, then press the **ENTER** button to set the pop-up menu.
 - **Play:** Play the selected music.
 - **Stop Play:** Stop the play.
 - **Play With Photo:** Start playing the selected music by turns and then move to the Photo List.
 - **Mark All:** Mark all music titles in the folder.
 - **Unmark All:** Unmark all marked music.
 - **Cancel:** Hide the pop-up menu.
- 4 Repeatedly, press **EXIT** button to return to TV viewing or press **XSTUDIO** button to return to the previous menu.

Screen Saver

- The screen saver prevents a fixed image from staying on the screen.

■ While playing music

- If you don't press any button for 40 seconds, the play information box (as shown in the below) will float as a screen saver.

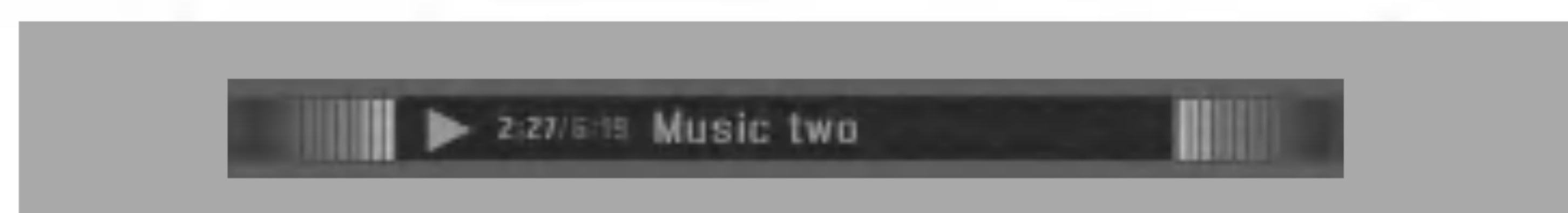

• If you press any button except **VOL ▲ / ▼**, **MUTE**, **▶**, **||**, **■**, **◀◀**, **▶▶** buttons, screen saver is stopped.

■ While stopping music

- If you don't press any button for 40 seconds, the TV returns to the previous step.



- When music is playing, **♪** is displayed in front of the music title.
- The **▶**, **||**, **■**, **◀◀**, **▶▶** buttons on the remote control are also available in this mode.

External Control Device Setup

- Connect the RS-232C input jack to an external control device (such as a computer or an A/V control system) and control the Monitor's functions externally.
- Connect the serial port of the control device to the RS-232C jack on the TV back panel.
- RS-232C connection cables are not supplied with the TV.

RS-232C Setup

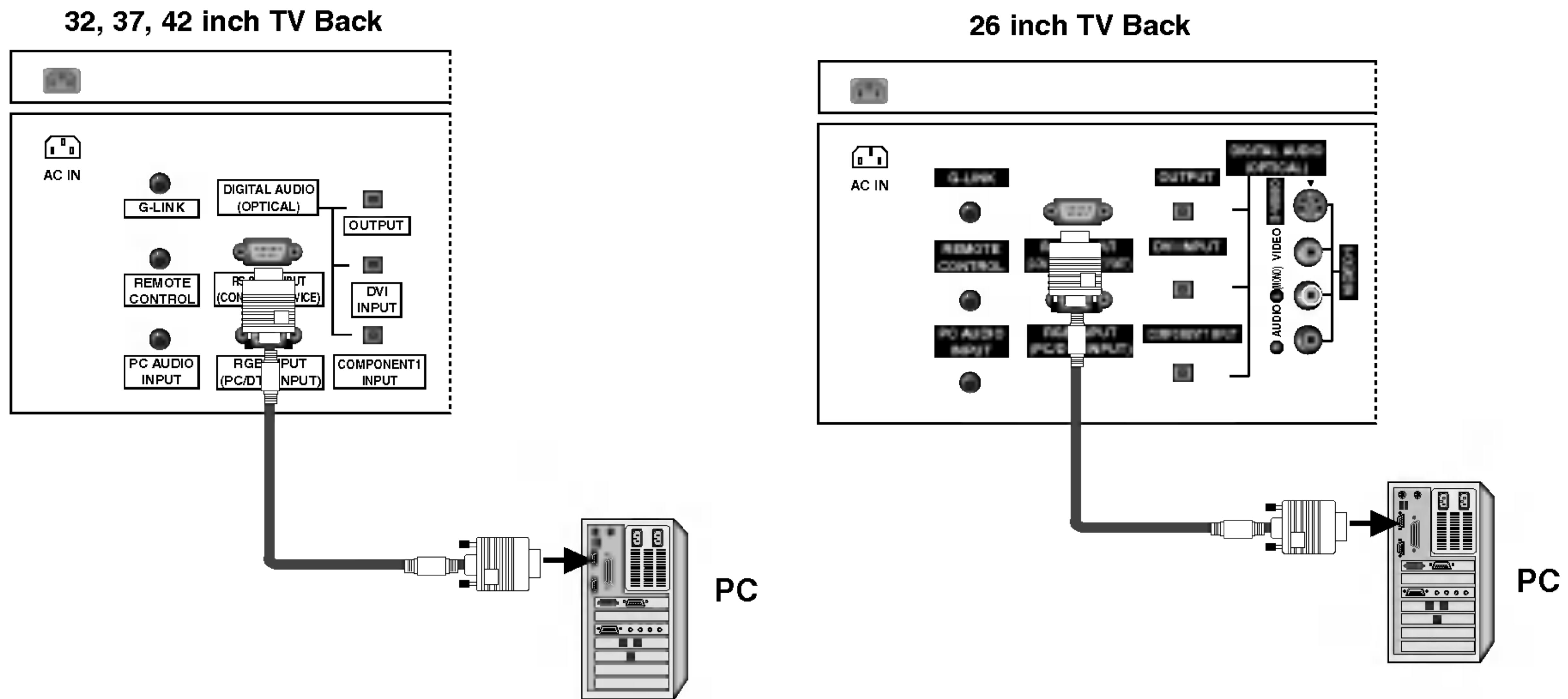

Type of Connector; D-Sub 9-Pin Male

No.	Pin Name
1	No connection
2	RXD (Receive data)
3	TXD (Transmit data)
4	DTR (DTE side ready)
5	GND
6	DSR (DCE side ready)
7	RTS (Ready to send)
8	CTS (Clear to send)
9	No Connection

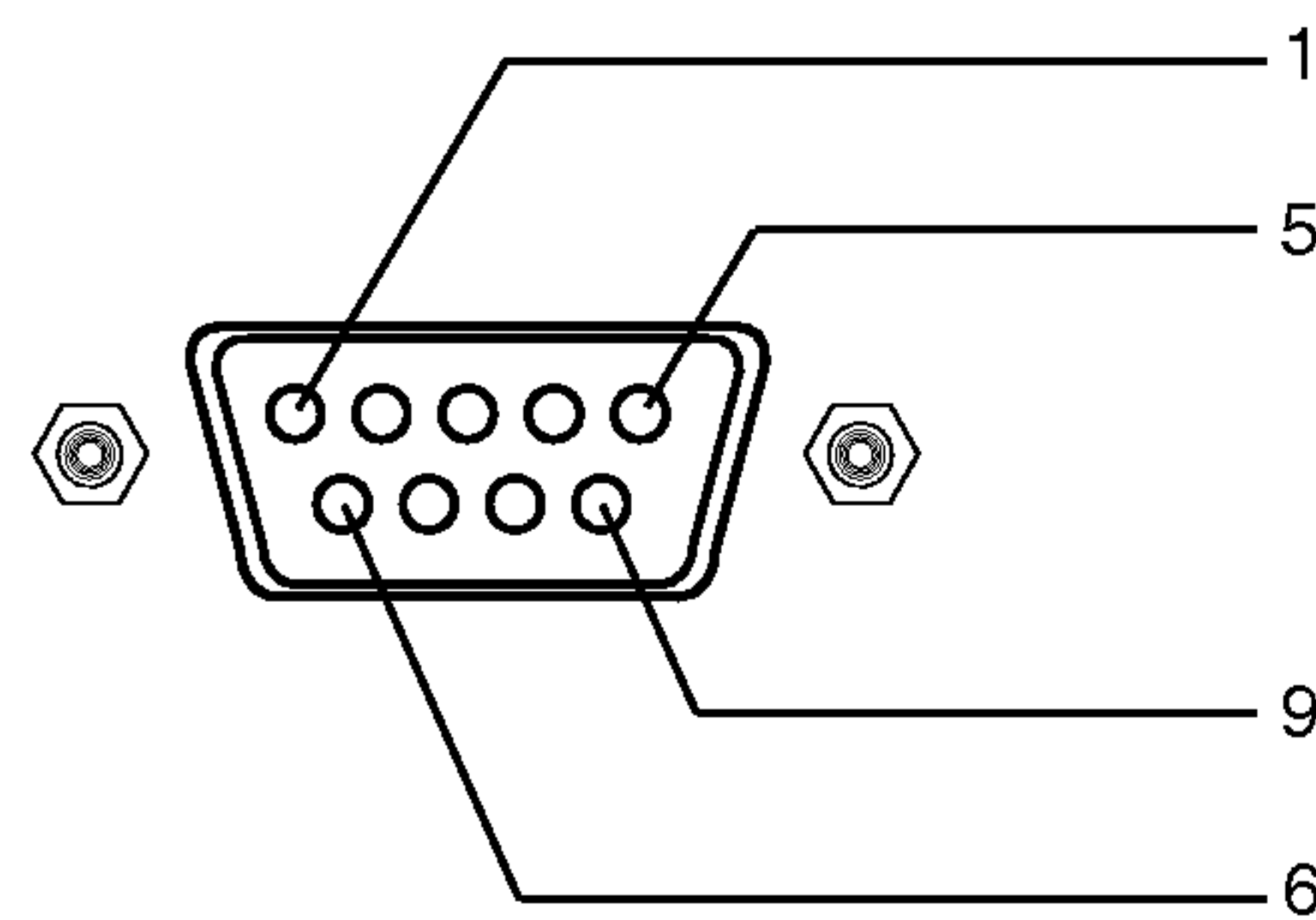

RS-232C Configurations

7-Wire Configurations
(Serial female-female NULL modem cable)

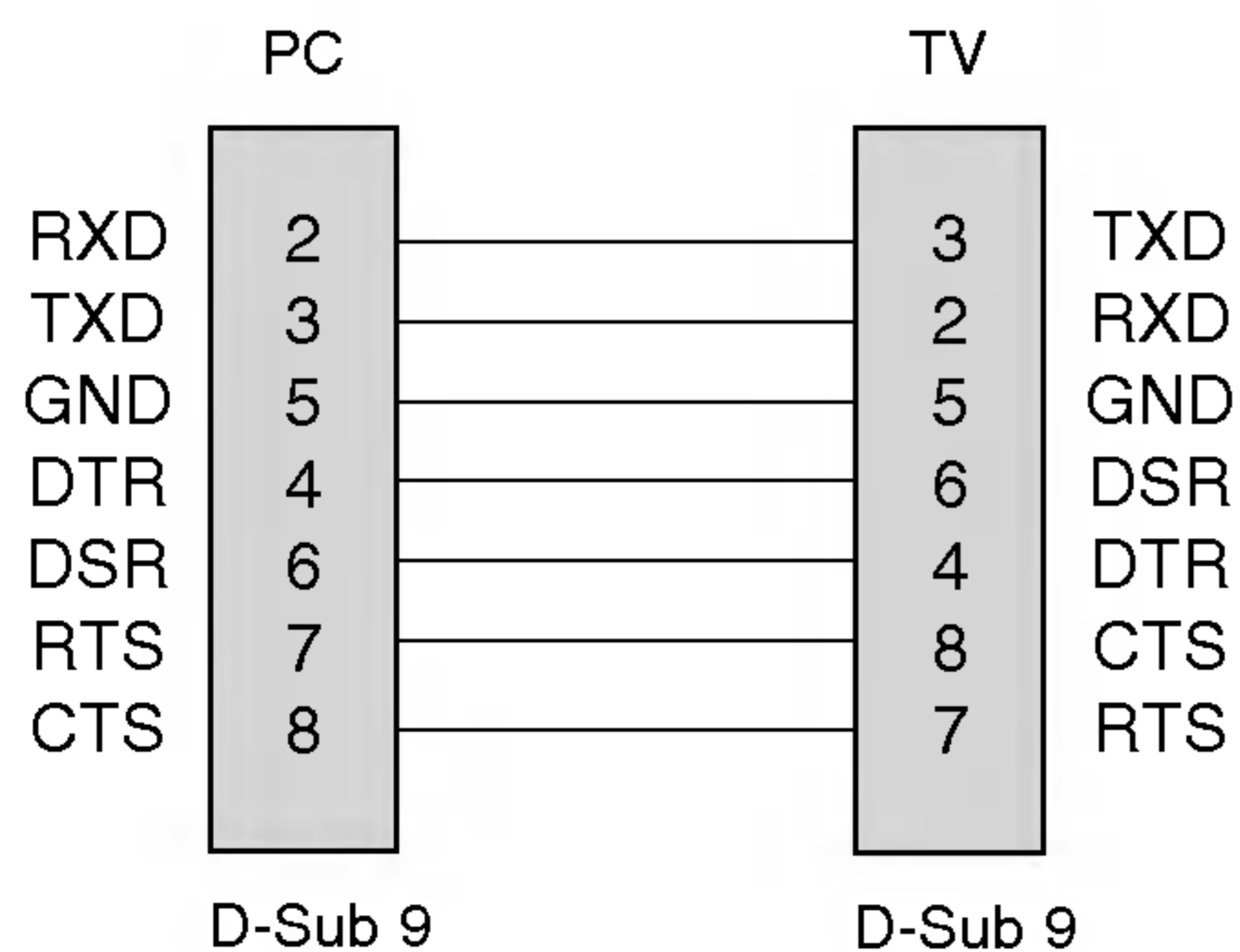

3-Wire Configurations
(Not standard)

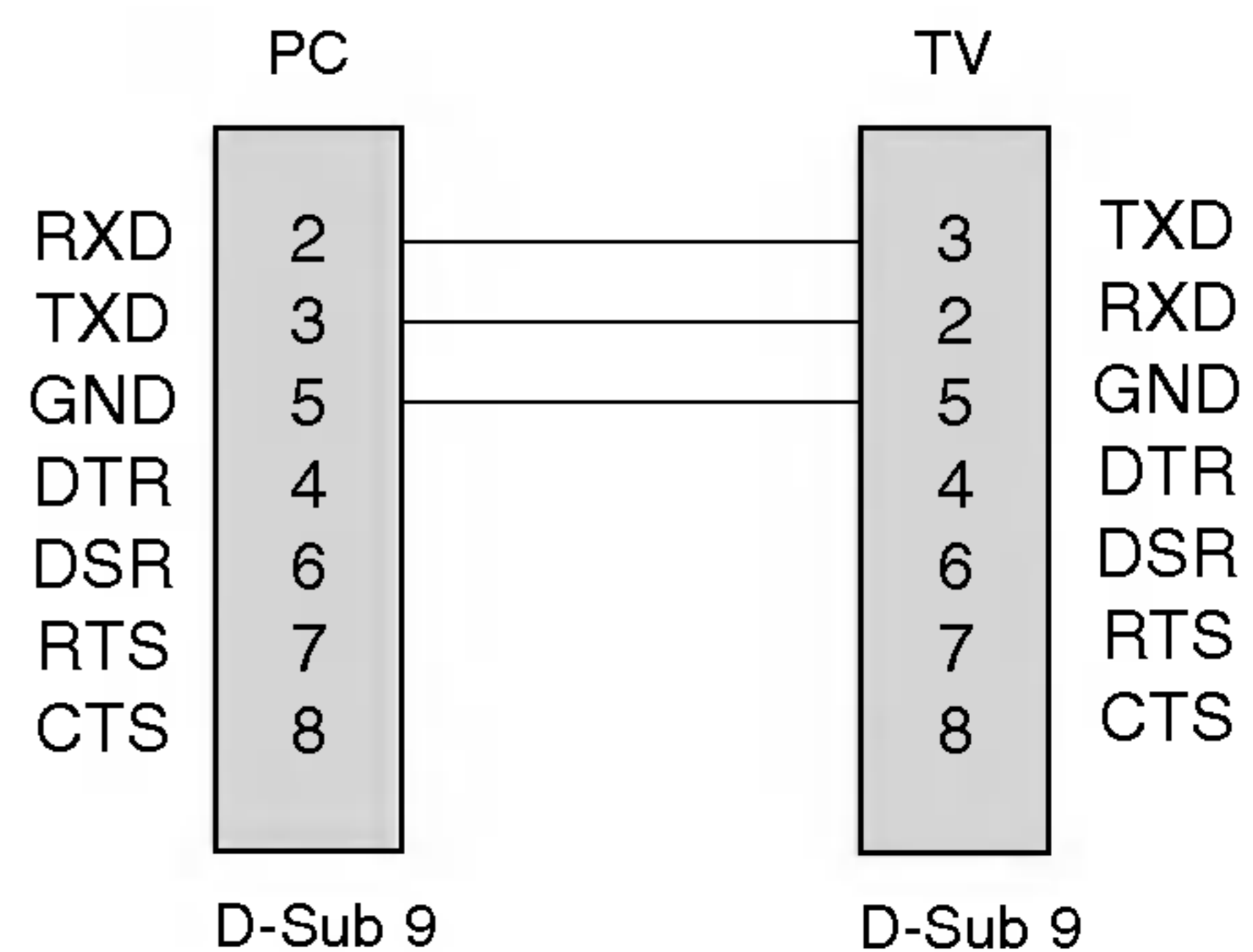

Set ID

- Use this function to specify a TV ID number.
- Refer to 'Real Data Mapping'. See page 104.

1. Press the **MENU** button and then use ▲ / ▼ button to select the **SETUP** menu.
2. Press the ► button and then use ▲ / ▼ button to select **SET ID**.
3. Press the ► button and then use ▲ / ▼ button to adjust **SET ID** to choose the desired TV ID number. The adjustment range of **SET ID** is 1 ~ 99.
4. Press **EXIT** button to return to TV viewing or press **MENU** button to return to the previous menu.



Communication Parameters

- Baud rate : 9600 bps (UART)
- Data length : 8 bits
- Parity : None
- Stop bit : 1 bit
- Communication code : ASCII code

* Use a crossed (reverse) cable.

Command Reference List

	COMMAND 1	COMMAND 2	DATA (Hexadecimal)
01. Power	k	a	0 ~ 1
02. Input Select	k	b	0 ~ 8
03. Aspect Ratio	k	c	*
04. Screen Mute	k	d	0 ~ 1
05. Volume Mute	k	e	0 ~ 2
06. Volume Control	k	f	0 ~ 64
07. Contrast	k	g	0 ~ 64
08. Brightness	k	h	0 ~ 64
09. Color	k	i	0 ~ 64
10. Tint	k	j	0 ~ 64
11. Sharpness	k	k	0 ~ 64
12. OSD Select	k	l	0 ~ 1
13. Remote Control Lock Mode	k	m	0 ~ 1
14. PIP/POP/Twin Picture	k	n	0,1,2,5
15. PIP Position	k	q	0 ~ 3
16. Treble	k	r	0 ~ 64
17. Bass	k	s	0 ~ 64
18. Balance	k	t	0 ~ 64
19. Color Temperature	k	u	0 ~ 2
20. PIP Input Source	k	y	0 ~ 3
24. Input Select	x	b	*
25. PIP Input Select	x	y	*

	COM- MAND 1	COM- MAND 2	DATA 0 (Hexadecimal)	DATA 1 (Hexadecimal)	DATA 2 (Hexadecimal)	DATA 3 (Hexadecimal)	DATA 4 (Hexadecimal)	DATA 5 (Hexadecimal)
21. Channel Tuning	m	a	01 ~ 87	01 ~ 87	00 ~ FE	00 ~ FE	00 ~ FE	00 ~ FE
22. Channel Add/Del	m	b	00 ~ 01					
23. Key	m	c	*					

Transmission / Receiving Protocol

Transmission

[Command1][Command2][][Set ID][][Data][Cr]

- * [Command 1]: First command to control the set. (j or k)
- * [Command 2]: Second command to control the set.
- * [Set ID]: You can adjust the set ID to choose desired monitor ID number in Setup menu. Adjustment range is 1 ~ 99. When selecting Set ID '0', every connected the TV is controlled. Set ID is indicated as decimal (1~99) on menu and as Hexa decimal (0x0~0x63) on transmission/receiving protocol.
- * [DATA]: To transmit command data.
Transmit 'FF' data to read status of command.
- * [Cr]: Carriage Return
ASCII code '0x0D'
- * []: ASCII code 'space (0x20)'

OK Acknowledgement

[Command2][][Set ID][][OK][Data][x]

- * The Monitor transmits ACK (acknowledgement) based on this format when receiving normal data. At this time, if the data is data read mode, it indicates present status data. If the data is data write mode, it returns the data of the PC computer.

Error Acknowledgement

[Command2][][Set ID][][NG][Data][x]

- * The Monitor transmits ACK (acknowledgement) based on this format when receiving abnormal data from non-viable functions or communication errors.

Data 1: Illegal Code
2: Not supported function
3: Wait more time

09. Color (Command2:i)

- ▶ To adjust the screen color.
You can also adjust color in the Video menu.

Transmission

```
[k][i][ ][Set ID][ ][Data][Cr]
```

Data Min : 0 ~ Max : 64

- Refer to 'Real data mapping'. See page 104.

Acknowledgement

```
[i][ ][Set ID][ ][OK][Data][x]
```

10. Tint (Command2:j)

- ▶ To adjust the screen tint.
You can also adjust tint in the Video menu.

Transmission

```
[k][j][ ][Set ID][ ][Data][Cr]
```

Data Red : 0 ~ Green : 64

- Refer to 'Real data mapping'. See page 104.

Acknowledgement

```
[j][ ][Set ID][ ][OK][Data][x]
```

11. Sharpness (Command2:k)

- ▶ To adjust the screen sharpness.
You can also adjust sharpness in the Video menu.

Transmission

```
[k][k][ ][Set ID][ ][Data][Cr]
```

Data Min: 0 ~ Max: 64

- Refer to 'Real data mapping'. See page 104.

Acknowledgement

```
[k][ ][Set ID][ ][OK][Data][x]
```

12. OSD Select (Command2:l)

- ▶ To select OSD (On Screen Display) on/off.

Transmission

```
[k][l][ ][Set ID][ ][Data][Cr]
```

Data 0: OSD off 1: OSD on

Acknowledgement

```
[l][ ][Set ID][ ][OK][Data][x]
```

13. Remote Control Lock Mode (Command2:m)

- ▶ To lock the remote control and the front panel controls on the set.

Transmission

```
[k][m][ ][Set ID][ ][Data][Cr]
```

Data 0: Lock off 1: Lock on

Acknowledgement

```
[m][ ][Set ID][ ][OK][Data][x]
```

14. PIP/POP/Twin Picture (Command2:n)

- ▶ To control the PIP (Picture-in-Picture)/POP/Twin picture.
You can also control the PIP/POP/Twin picture using the PIP button on the remote control.

Transmission

```
[k][n][ ][Set ID][ ][Data][Cr]
```

Data 0: PIP off 2: Twin Picture
1: PIP 5: POPAcknowledgement

```
[n][ ][Set ID][ ][OK][Data][x]
```

15. PIP Position (Command2:q)

- ▶ To select sub picture position for PIP.

Transmission

```
[k][q][ ][Set ID][ ][Data][Cr]
```

Data 0: Right down on screen
1: Left down on screen
2: Left up on screen
3: Right up on screenAcknowledgement

```
[q][ ][Set ID][ ][OK][Data][x]
```

16. Treble (Command2:r)

- ▶ To adjust treble.
You can also adjust treble in the Audio menu.

Transmission

```
[k][r][ ][Set ID][ ][Data][Cr]
```

Data Min: 0 ~ Max: 64

- Refer to 'Real data mapping'. See page 104.

Acknowledgement

```
[r][ ][Set ID][ ][OK][Data][x]
```

17. Bass (Command2:s)

- ▶ To adjust bass.
You can also adjust bass in the Audio menu.

Transmission

```
[k][s][ ][Set ID][ ][Data][Cr]
```

Data Min: 0 ~ Max: 64

- Refer to 'Real data mapping'. See page 104.

Acknowledgement

```
[s][ ][Set ID][ ][OK][Data][x]
```

18. Balance (Command2:t)

- ▶ To adjust balance.
You can also adjust balance in the Audio menu.

Transmission

```
[k][t][ ][Set ID][ ][Data][Cr]
```

Data Min: 0 ~ Max: 64

- Refer to 'Real data mapping'. See page 104.

Acknowledgement

```
[t][ ][Set ID][ ][OK][Data][x]
```

19. Color Temperature (Command2:u)

► To adjust color temperature.
You can also adjust color temperature in the Video menu.

Transmission

```
[k][u][ ][Set ID][ ][Data][Cr]
```

Data 0: Medium 1: Cool 2: Warm

Acknowledgement

```
[u][ ][Set ID][ ][OK][Data][x]
```

20. PIP Input Select (Command2:y)

► To select input source for sub picture in PIP/Twin picture mode.

Transmission

```
[k][y][ ][Set ID][ ][Data][Cr]
```

Data 0: DTV
1: Analog
2: Video 1
3: Video 2

Acknowledgement

```
[y][ ][Set ID][ ][OK][Data][x]
```

21. Channel Tuning (Command: m a)

► To tune channel to following physical/major/minor number

Transmission

```
[m][a][ ][Set ID][ ][Data0][ ][Data1][ ][Data2][ ][Data3][ ][Data4][ ][Data5][Cr]
```

Data 0: Physical channel number (Transmit by Hexadecimal code)
* NTSC air: 02 ~ 45
NTSC cable: 01, 0E ~ 7D
ATSC air: 01 ~ 45
ATSC cable: 01 ~ 87

Data 1, 2: Major channel number(two part)/channel number(One part)
* Data1: High byte
Data2: Low byte
Two part channel number: Major number-Minor number
One part channel number: If the channel band is ATSC digital cable, it can be used. In case of using one part channel number, minor channel does not need.

Data 3, 4: Minor Channel Number
* Data3: High byte
* Data4: Low byte

Data 5:

7	Main/Sub Picture	6	Two/One Part Channel	5	Using Physical Channel	4	3	2	1	0	Step
0	Main	0	Two	0	Use	x	0	0	0	0	NTSC Air
1	Sub	1	One	1	No Use	x	0	0	0	1	NTSC Cable
						x	0	0	1	0	ATSC Air
						x	0	0	1	1	ATSC cable_std
						x	0	1	0	0	ATSC cable_hrc
						x	0	1	0	1	ATSC cable_irc
						x	0	1	1	0	ATSC cable auto
						x	0	1	1	1	Reserved
						x	x	x	x	x	...
						x	1	1	1	1	Reserved

* All data are transmitted by Hexadecimal code
* Two/One part Channel: 6th bit
This bit is used in a cable-ready system.

*Using physical channel: 5th bit
If the channel band is NTSC air or NTSC cable, channel tuning can be done by only physical channel. In this case, using physical channel bit must be low(0).
But if the channel band is ATSC air or ATSC cable, there are two cases that physical channel enable or disable.
If the physical channel sending is meaningful, you should set this bit low(0). If the physical channel sending is meaningless, you should set this bit high(1).

Example)

- Analog channel: NTSC cable, channel number(35), main picture
Command: ma 00 23 xx xx xx xx 01
attribute(0x01): main picture, two part(it's not mandatory), using physical channel, NTSC cable
'xx' data: don't care major and minor channel number in case analog channel tuning
- Digital channel: ATSC air, channel number(don't know physical channel, major(30), minor(3)), sub picture
Command: ma 00 xx 00 1E 00 03 A2
attribute(0xA2): sub picture, two part, not using physical channel, ATSC air
'xx' data: don't care analog channel number in case digital channel tuning.
- Digital channel: ATSC air, channel number(physical(20), major(30), minor(3)), sub picture
Command: ma 00 14 00 1E 00 03 82
attribute(0x82): sub picture, two part, using physical channel, ATSC air

Acknowledgement

```
[a][ ][Set ID][ ][OK][Data0][Data1][Data2][Data3][Data4][Data5][x]  
[a][ ][Set ID][ ][NG][Data0][x]
```

22. Channel Add/Del (Command: m b)

► To add and delete the channels

Transmission

```
[m][b][ ][Set ID][ ][Data][Cr]
```

Data 0: Channel Delete
1: Channel Add

Acknowledgement

```
[b][ ][Set ID][ ][OK][Data][x]  
[b][ ][Set ID][ ][NG][Data][x]
```

23. Key (Command: m c)

► To send IR remote key code

Transmission

```
[m][c][ ][Set ID][ ][Data][Cr]
```

Data Key code: See page 109.

Acknowledgement

```
[c][ ][Set ID][ ][OK][Data][x]
```

24. Input Select (Command:x b) (Main Picture Input)

► To select input source for TV.

Transmission

```
[x][b][ ][Set ID][ ][Data][Cr]
```

Data Structure

INPUT	DATA(Hex)
DTV (Antenna)	00
DTV (Cable)	01
Analog (Antenna)	10
Analog (Cable)	11
Video 1	20
Video 2	21
Component 1	40
Component 2	41
RGB-DTV	50
RGB-PC	60
HDMI/DVI	90

Acknowledgement

```
[b][ ][Set ID][ ][OK/NG][Data][x]
```

25. PIP Input Select (Command:x y)

► To adjust the input source for sub picture in PIP mode

Transmission

```
[x][y][ ][Set ID][ ][Data][Cr]
```

Data Structure

INPUT	DATA(Hex)
DTV (Antenna)	00
DTV (Cable)	01
Analog (Antenna)	10
Analog (Cable)	11
Video 1	20
Video 2	21

Acknowledgement

```
[y][ ][Set ID][ ][OK/NG][Data][x]
```

IR Codes

How to Connect

- ▶ Connect your wired remote control to the Remote Control port on the TV.

Remote Control IR Codes

▶ Output waveform

Single pulse, modulated with 37.917KHz signal at 455KHz

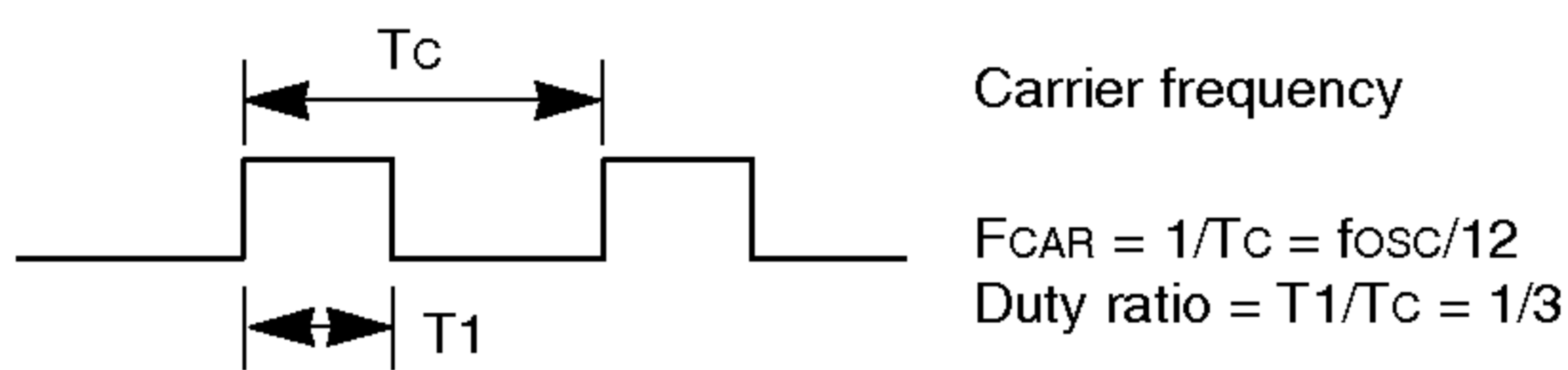

▶ Configuration of frame

- 1st frame

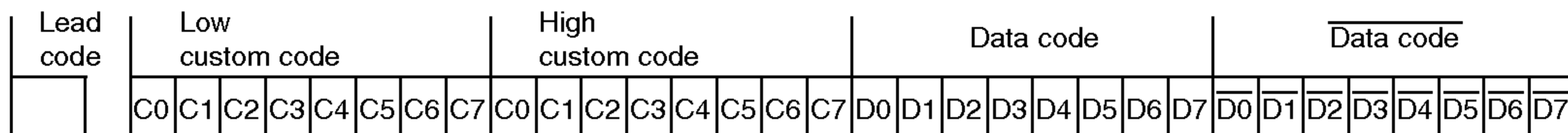

- Repeat frame

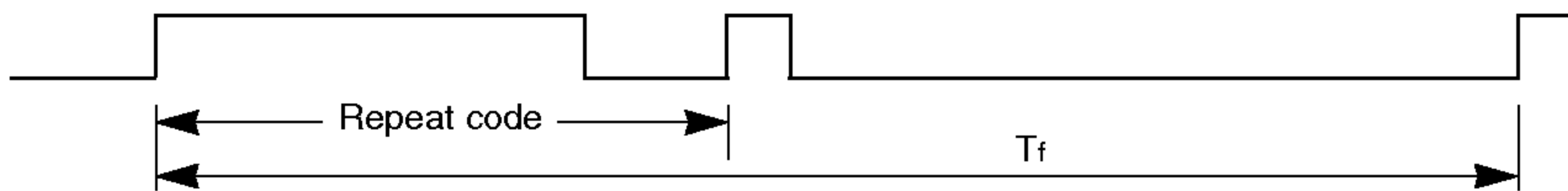

▶ Lead code

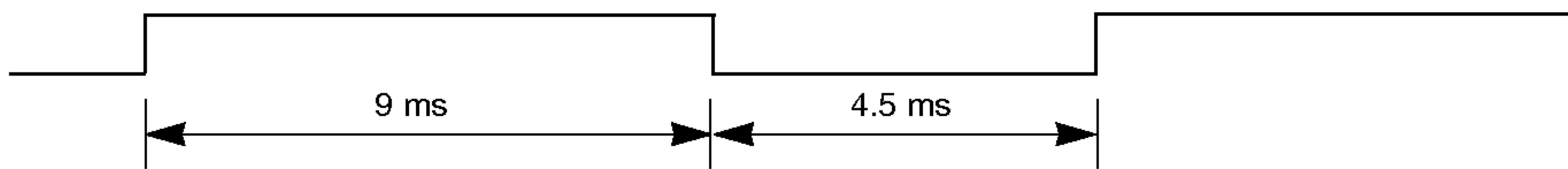

▶ Repeat code

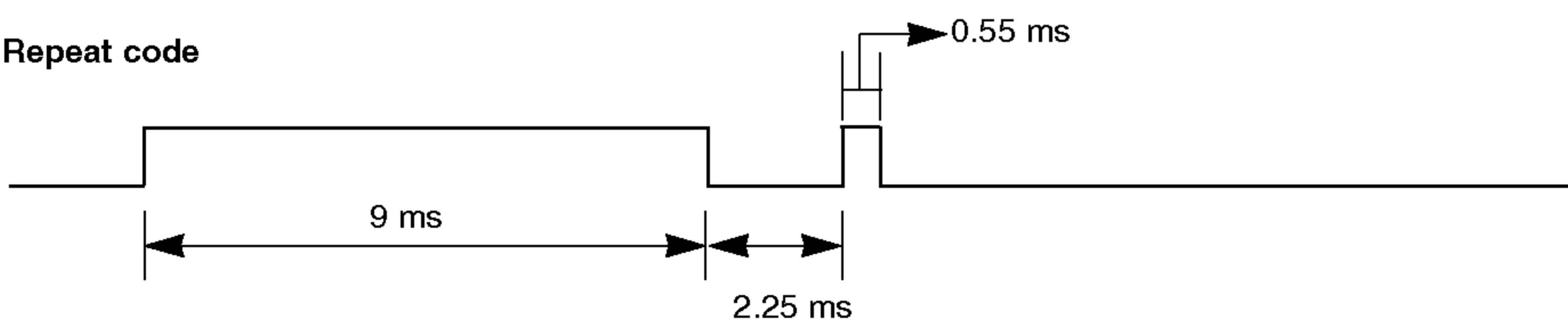

▶ Bit description

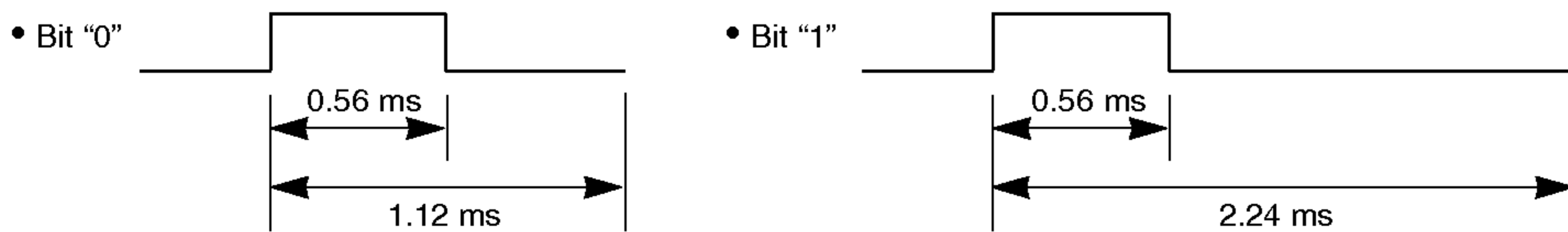

▶ Frame interval : Tf

The waveform is transmitted as long as a key is depressed.

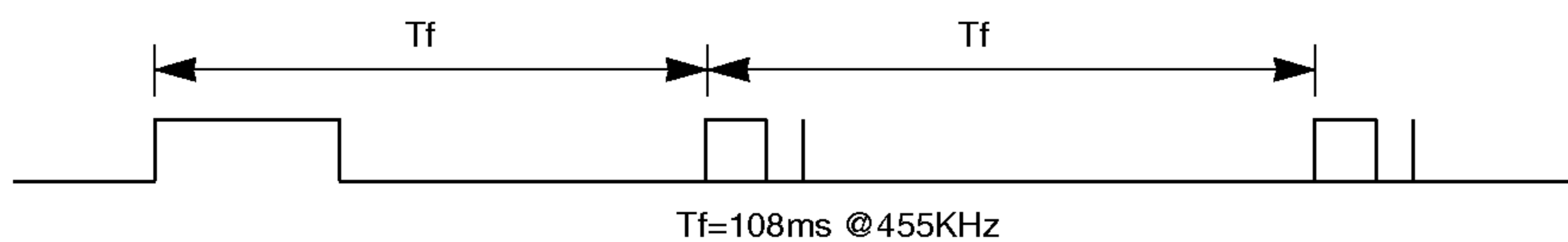

Code (Hexa)	Function	Note
0B	TV/VIDEO	Remote Control Button
08	POWER	R/C Button (Power On/Off)
C4	POWER ON	Discrete IR Code (Only Power On)
C5	POWER OFF	Discrete IR Code (Only Power Off)
79	RATIO	Remote Control Button
0E	TIMER	Remote Control Button
10 ~ 19	Number Key 0~ 9	Remote Control Button
4C	- (Dash)	Remote Control Button
1A	FLASHBK	Remote Control Button
09	MUTE	Remote Control Button
02	VOL▲	Remote Control Button
03	VOL▼	Remote Control Button
00	CH▲	Remote Control Button
01	CH▼	Remote Control Button
1E	FAV	Remote Control Button
AA	INFO	Remote Control Button
39	CC	Remote Control Button
40	▲	Remote Control Button
41	▼	Remote Control Button
07	◀	Remote Control Button
06	▶	Remote Control Button
44	ENTER	Remote Control Button
43	MENU	Remote Control Button
52	EZ SOUND	Remote Control Button
4D	EZ PIC	Remote Control Button
5B	EXIT	Remote Control Button
60	PIP	Remote Control Button
72	PIP CH-	Remote Control Button
71	PIP CH+	Remote Control Button
61	PIP INPUT	Remote Control Button
63	SWAP	Remote Control Button
65	FREEZE	Remote Control Button
0A	SAP	Remote Control Button
CB	ADJUST	Remote Control Button
D6	TV	Discrete IR Code (TV Input Selection)
5A	Video 1	Discrete IR Code (Video1 Input Selection)
D0	Video 2	Discrete IR Code (Video2 Input Selection)
BF	Component 1	Discrete IR Code (Component1 Input Selection)
D4	Component 2	Discrete IR Code (Component2 Input Selection)
D5	RGB-PC	Discrete IR Code (RGB-PC Input Selection)
D7	RGB-DTV	Discrete IR Code (RGB-DTV Input Selection)
C6	HDMI/DVI	Discrete IR Code (HDMI/DVI Input Selection)
76	Ratio 4:3	Discrete IR Code (Only 4:3 Mode)
77	Ratio 16:9	Discrete IR Code (Only 16:9 Mode)
AF	Ratio Zoom	Discrete IR Code (Only Zoom1 Mode)
70	POP	Discrete IR Code (Channel Search)
87	1394	Remote Control Button
B0	PLAY	Remote Control Button
BA	PAUSE	Remote Control Button
B1	STOP	Remote Control Button
BD	REC	Remote Control Button
8F	REW	Remote Control Button
8E	FF	Remote Control Button
B2	GO TO PREV	Discrete IR Code
B3	GO TO NEXT	Discrete IR Code
A9	TV GUIDE	Remote Control Button
92	APM	Remote Control Button
CA	M/C EJECT	Remote Control Button
80	AUTO DEMO	Remote Control Button
C8	X STUDIO	Remote Control Button
7D	MARK	Remote Control Button

Programming the Remote

- ▶ The remote control is a multi-brand or universal remote control. It can be programmed to operate most remote-controllable devices of other manufacturers.

Note that the remote control may not control all models of other brands.

Programming a code into a remote mode



- 1 Test your remote control.
To find out whether your remote control can operate the component without programming, turn on the component such as a VCR and press the corresponding **MODE** button (VCR) on the remote control, while illuminating on the selected component. Test the **POWER** button to see if the component responds properly. If not, the remote requires programming to operate the device.
- 2 Turn on the component to be programmed, then press the corresponding **MODE** button on the remote control.
- 3 Press the **MENU** and **MUTE** buttons simultaneously for 2 seconds, the button selected component lights on the remote control. If you don't press any button for 20 seconds, the button selected component will turn off on the remote control. At a moment, you have to repeat from step 2.
- 4 Enter a code number using the number buttons on the remote. When pressing the button, the light is blinked at a time. Programming code numbers for the corresponding component can be found on the following pages. Again, if the code is correct, the device will turn off.
- 5 Press the **MENU** button to store the code. After blinking twice, this code is stored.
- 6 Test the remote control functions to see if the component responds properly. If not, repeat from step 2.

Programming Codes

VCRs

Brand	Codes	Brand	Codes	Brand	Codes	Brand	Codes
AIWA	034	KENWOOD	014 034 039 043	PORTLAND	108	TATUNG	039 043
AKAI	016 043 046 124		047 048	PULSAR	072	TEAC	034 039 043
	125 146	LG (GOLDSTAR)	001 012 013 020	QUARTZ	011 014	TECHNICS	031 033 070
AMPRO	072		101 106 114 123	QUASAR	033 066 075 145	TEKNIKA	019 031 033 034
ANAM	031 033 103	LLOYD	034	RCA	013 020 033 034		101
AUDIO DYNAMICS	012 023 039 043	LXI	003 009 013 014		040 041 062 063	THOMAS	034
BROKSONIC	035 037 129		017 034 101 106		107 109 140 144	TMK	006
CANON	028 031 033	MAGIN	040		145 147	TOSHIBA	008 013 042 047
CAPEHART	108	MAGNAVOX	031 033 034 041	REALISTIC	003 008 010 014		059 082 112 131
CRAIG	003 040 135		067 068		031 033 034 040	TOTEVISION	040 101
CURTIS MATHES	031 033 041	MARANTZ	012 031 033 067		053 054 101	UNITECH	040
DAEWOO	005 007 010 064		069	RICO	058	VECTOR RESEARCH	012
	065 108 110 111	MARTA	101	RUNCO	148	VICTOR	048
	112 116 117 119	MATSUI	027 030	SALORA	014	VIDEO CONCEPTS	012 034 046
DAYTRON	108	MEI	031 033	SAMSUNG	032 040 102 104	VIDEOSONIC	040
DBX	012 023 039 043	MEMOREX	003 010 014 031		105 107 109 112	WARDS	003 013 017 024
DYNATECH	034 053		033 034 053 072		113 115 120 122		031 033 034 040
ELECTROHOME	059		101 102 134 139		125		053 054 131
EMERSON	006 017 025 027	MGA	045 046 059	SANSUI	022 043 048 135	YAMAHA	012 034 039 043
	029 031 034 035	MINOLTA	013 020	SANYO	003 007 010 014	ZENITH	034 048 056
	036 037 046 101	MITSUBISHI	013 020 045 046		102 134		058 072 080 101
	129 131 138 153		049 051 059 061	SCOTT	017 037 112 129		
FISHER	003 008 009 010		151		131		
FUNAI	034	MTC	034 040	SEARS	003 008 009 010		
GE	031 033 063 072	MULTITECH	024 034		013 014 017 020		
	107 109 144 147	NEC	012 023 039 043		031 042 073 081		
GO VIDEO	132 136		048		101		
HARMAN KARDON	012 045	NORDMENDE	043	SHARP	031 054 149		
HITACHI	004 018 026 034	OPTONICA	053 054	SHINTOM	024		
	043 063 137 150	PANASONIC	066 070 074 083	SONY	003 009 031 052		
INSTANTREPLAY	031 033		133 140 145		056 057 058 076		
JCL	031 033	PENTAX	013 020 031 033		077 078 149		
JCPENNY	012 013 015 033		063	SOUNDESIGN	034		
	040 066 101	PHILCO	031 034 067	STS	013		
JENSEN	043	PHILIPS	031 033 034 054	SYLVANIA	031 033 034 059		
JVC	012 031 033 043		067 071 101		067		
	048 050 055 060	PILOT	101	SYMPHONIC	034		
	130 150 152	PIONEER	013 021 048	TANDY	010 034		

Cable Box

Brand	Codes	Brand	Codes	Brand	Codes	Brand	Codes
ABC	003 004 039 042	GOLDEN CHANNEL	030		065 085 090	SPRUCER	047 078
	046 052 053	HAMLIN	049 050 055	PIONEER	034 051 052 063	STARCOM	002 004 008 009
AJIN	112	HITACHI	052 055		076	STARGATE	008 030
ANTRONIK	014	HOSPITALITY	070 077	POST NEWS WEEK	016	TADIRAN	030
ARCHER	005 007 014 024	JERROLD	002 003 004 008	PRUCER	059	TAEKWANG	110
CABLE STAR	026		009 010 052 069	PTS	011 048 071 072	TAIHAN	105
CENTURION	092		074		073 074	TANDY	017
CENTURY	007	LG (GOLDSTAR)	001 106 101 005	PULSAR	100	TEXSCAN	029
CITIZEN	007	M-NET	037	RCA	047	TOCOM	039 040 056
COLOUR VOICE	065 090	MACOM	033	REGAL	049 050	TOSHIBA	100
COMBANO	080 081	MAGNAVOX	010 012 064 079	REGENCY	057	UNIKA	007 014 024
COMTRONICS	019 030	MEMOREX	100	REMBRANT	025	UNITED CABLE	004 053
DIAMOND	023	MOVIE TIME	028 032	SAMSUNG	102 107 030 068	UNIVERSAL	005 007 014 024
EAGLE	020 030 040	NSC	015 028 038 071	SCIENTIFIC ATLANTA	003 011 041 042		026 027 032 035
EASTERN	057 062 066		073		043 045 046	VIEWSTAR	012 015 018 086
ELECTRICORD	032	OAK	016 031 037 053	SHERITECH	022		087 088 089
GE	072	PANASONIC	044 047	SIGNAL	030	ZENITH	100 114 060 093
GEMINI	008 022 025 054	PARAGON	100	SIGNATURE	052		
GI	052 074	PHILIPS	006 012 013 020	SL MARX	030		

Digital Cable/Satellite Box

Brand	Codes	Brand	Codes	Brand	Codes	Brand	Codes
ALPHASTAR DSR	123		133 134	PACE SKY SATELLITE	143		088 090 107 130
AMP LICA	050	GENERAL INSTRUMENT	003 004 016 029	PANASONIC	060 142		137
BIRDVIEW	051 126 129		031 059 101	PANSAT	121	TOSHIBA	002 127
CHANNEL MASTER	013 014 015 018	HITACHI	139 140	PERSONAL CABLE	117	UNIDEN	016 025 042 043
	036 055	HOUSTON TRACKER	033 037 039 051	PHILIPS	071		044 045 048 049
CHAPARRAL	008 009 012 077		057 104	PICO	105		078 079 080 086
CITOH	054	HUGHES	068	PRESIDENT	019 102		101
CURTIS MATHES	050 145	JANIEL	060 147	PRIMESTAR	030 110 111	UNIDEN	135 136
DRAKE	005 006 007 010	JERROLD	061	PROSAT	072	VIEWSTAR	115
	011 052 112 116	KATHREIN	108	RCA	066 106	WINEGARD	128 146
	141	LEGEND	057	REALISTIC	043 074	ZENITH	081 082 083 084
DX ANTENNA	024 046 056 076	LG	001	SAMSUNG	123		091 120
ECHOSTAR	038 040 057 058	LUTRON	132	SATELLITE SERVICE CO	028 035 047 057		
	093 094 095 096	LUXOR	062 144		085		
	097 098 099 100	MACOM	010 059 063 064	SCIENTIFIC ATLANTA	032 138		
	122		065	SONY	103		
ELECTRO HOME	089	MEMOREX	057	STARCAST	041		
EUROPLUS	114	NEXTWAVE	028 124 125	SUPER GUIDE	020 124 125		
FUJITSU	017 021 022 027	NORSAT	069 070	TEECOM	023 026 075 087		

Audio

Brand	Codes	Brand	Codes	Brand	Codes	Brand	Codes
AIWA	014 028 070 096	JVC	004 013 141	PHILIPS	026 112 143	TOSHIBA	137
	125 129 139 229	KEC	185 186 187	PIONEER	039 042 043 063	THE	061
	230	KENWOOD	038 050 067 089		065 091 093 094	VICTOR	088 131
AKAI	163		170 171 197 206	QUASAR	113	WARDS	089
ANAM	003 014 017 023		215 222	RCA	080	YAMAHA	054 055 066 092
	059 106 189 216	KOHEL	030	RCX	092		199
	217 235 236	NAD	045 046	REALISTIC	103 106		
BURMECTER	252	LOTTE	014 016 036 098	SAMSUNG	124 145 146 182		
CARVER	086		100 172 173 174		193 194 195 203		
CLARION	199		175 176 177 178		204 244 245 246		
DAEWOO	027 053 060 084		179 180 181 183	SANSUI	011 135 138 144		
	102 148 198 221		201 202 208 213	SANYO	019 083 234		
DENON	015 075 130 143		214 219 223 232	SCOTT	106 186		
FANTASIA	071		238 240	SHARP	031 032 051 052		
FINEARTS	022	LXI	103		072 082 117 119		
FISHER	089 099	MAGNAVOX	111		156 184 199 200		
LG(GOLDSTAR)	001 021 024 029	MARANTZ	002 018 020 025	SHERWOOD	206 209		
	087 107 108 110		034 041 081 090	SONY	005 006 158		
	190 191 192 210	MCINTOSH	049		044 045 109 114		
	211 212 239	MCS	104		118 126 248 249		
HAITAI	034 035 188 222	MEMOREX	107	TAEKWANG	012 020 073 074		
HARMAN/KARDON	068	NAD	046		076 077 105 161		
INKEL	037 058 062 069	ONKYO	013 040 041 047		162 163 164 165		
	078 079 095 121		048 056 057 132		166 167 168 169		
	122 149 150 151		133 140	TEAC	205 231 233 242		
	152 153 154 155	OPTIMUS	158		010 085 106 136		
	157 158 159 160	PANASONIC	007 033 064 113		185 187 237		
	189 207 222 224		142 220 241 251	TECHNICS	101 113 128 134		
	225 226 227 243	PENNEY	104		147 218		
	247						

DVD

Brand	Codes	Brand	Codes	Brand	Codes	Brand	Codes
APEX DIGITAL	022	MAGNAVOX	013	PHILIPS	013	SONY	007
DENON	020 014	MARANTZ	024	PIONEER	004 026	THOMPSON	005 006
GE	005 006	MITSUBISHI	002	PROCEED	021	TOSHIBA	019 008
HARMAN KARDON	027	NAD	023	PROSCAN	005 006	YAMAHA	009 018
JVC	012	ONKYO	008 017	RCA	005 006	ZENITH	010 016 025
LG	001 010 016 025	PANASONIC	003 009	SAMSUNG	011 015		

Troubleshooting Checklist

The operation does not work normally.	
The remote control doesn't work	<ul style="list-style-type: none"> • Check to see if there is any object between the product and the remote control causing obstruction. • Are batteries installed with correct polarity (+ to +, - to -)? • Correct remote operating mode set: TV, VCR etc.? • Install new batteries.
Power is suddenly turned off	<ul style="list-style-type: none"> • Is the sleep timer set? • Check the power control settings. Power interrupted • No broadcast on station tuned with Auto off activated.

The video function does not work.	
No picture & No sound	<ul style="list-style-type: none"> • Check whether the product is turned on. • Try another channel. The problem may be with the broadcast. • Is the power cord inserted into wall power outlet? • Check your antenna direction and/or location. • Test the wall power outlet, plug another product's power cord into the outlet where the product's power cord was plugged in.
Picture appears slowly after switching on	<ul style="list-style-type: none"> • This is normal, the image is muted during the product startup process. Please contact your service center, if the picture has not appeared after five minutes.
No or poor color or poor picture	<ul style="list-style-type: none"> • Adjust Color in menu option. • Keep a sufficient distance between the product and the VCR. • Try another channel. The problem may be with the broadcast. • Are the video cables installed properly? • Activate any function to restore the brightness of the picture.
Horizontal/vertical bars or picture shaking	<ul style="list-style-type: none"> • Check for local interference such as an electrical appliance or power tool.
Poor reception on some channels	<ul style="list-style-type: none"> • Station or cable product experiencing problems, tune to another station. • Station signal is weak, reorient antenna to receive weaker station. • Check for sources of possible interference.
Lines or streaks in pictures	<ul style="list-style-type: none"> • Check antenna (Change the direction of the antenna).

The audio function does not work.	
Picture OK & No sound	<ul style="list-style-type: none"> • Press the VOL or VOLUME button. • Sound muted? Press MUTE button. • Try another channel. The problem may be with the broadcast. • Are the audio cables installed properly?
No output from one of the speakers	<ul style="list-style-type: none"> • Adjust Balance in menu option.
Unusual sound from inside the product	<ul style="list-style-type: none"> • A change in ambient humidity or temperature may result in an unusual noise when the product is turned on or off and does not indicate a fault with the product.

There is a problem in PC mode. (Only PC mode applied)	
The signal is out of range.	<ul style="list-style-type: none"> • Adjust resolution, horizontal frequency, or vertical frequency. • Check it whether the signal cable is connected or loose. • Check the input source.
Vertical bar or stripe on back- ground & Horizontal Noise & Incorrect position	<ul style="list-style-type: none"> • Work the Auto configure or adjust clock, phase, or H/V position. (Option)
Screen color is unstable or single color	<ul style="list-style-type: none"> • Check the signal cable. • Reinstall the PC video card.

Maintenance

- Early malfunctions can be prevented. Careful and regular cleaning can extend the amount of time you will have your new TV. Be sure to turn the power off and unplug the power cord before you begin any cleaning.

Cleaning the Screen

1. Here's a great way to keep the dust off your screen for a while. Wet a soft cloth in a mixture of lukewarm water and a little fabric softener or dish washing detergent. Wring the cloth until it's almost dry, and then use it to wipe the screen.
2. Make sure the excess water is off the screen, and then let it air-dry before you turn on your TV.

Cleaning the Cabinet

To remove dirt or dust, wipe the cabinet with a soft, dry, lint-free cloth. Please be sure not to use a wet cloth.

Extended Absence



If you expect to leave your TV dormant for a long time (such as a vacation), it's a good idea to unplug the power cord to protect against possible damage from lightning or power surges.

Product Specifications

MODEL	26LX1D	26LX2D	32LX1D	32LX2D
Width (inches / mm)	31 / 787.7	31 / 787.7	36.3 / 922	36.3 / 922
Height (inches / mm)	20 / 510	19.2 / 487	23.6 / 599.7	24.1 / 613.4
Depth (inches / mm)	7.6 / 193.4	10 / 253	8.6 / 218.5	11.3 / 287.5
Weight (pounds / kg)	41.2 / 18.7	40 / 18.1	54 / 24.5	56.2 / 25.2
Power requirement	AC 100-240V~ 50/60Hz 1.5A		AC 100-240V~ 50/60Hz 2.0A	
Television System	NTSC-M, ATSC			
Program Coverage	VHF 2 ~ 13, UHF 14 ~ 69, CATV 1 ~ 135, CADTV 1 ~ 135, DTV 2 ~ 69			
External Antenna Impedance	75 Ω			

MODEL	32LP1D	37LP1D	42LP1D
Width (inches / mm)	40 / 1016	45.6 / 1158	50.8 / 1290
Height (inches / mm)	24.7 / 627.5	28.3 / 719	31.7 / 804
Depth (inches / mm)	8.03 / 204	8.4 / 213.1	9.7 / 247.5
Weight (pounds / kg)	70.5 / 32	91.5 / 41.5	101.4 / 46
Power requirement	AC 100-240V~ 50/60Hz 2.0A	AC 100-240V~ 50/60Hz 2.4A	AC 100-240V~ 50/60Hz 3.5A
Television System	NTSC-M, ATSC		
Program Coverage	VHF 2 ~ 13, UHF 14 ~ 69, CATV 1 ~ 135, CADTV 1 ~ 135, DTV 2 ~ 69		
External Antenna Impedance	75 Ω		

- The specifications shown above may be changed without prior notice for quality improvement.

