



PLASMA TV OWNER'S MANUAL

Please read this manual carefully before operating your set.
Retain it for future reference.
Record model number and serial number of the set.
See the label attached on the back cover and quote this information to your dealer when you require service.

Model number :
Serial number :

P/NO : 3828VA0565M (MF056B, 141K TX)

Safety Instructions

WARNING

Do not place the set in direct sunlight or near heat sources such as heat registers, stove and so on.

- This may cause a fire.

Do not use the set in damp place such as a bathroom or any place where it is likely to get wet.

- This may cause a fire or could give an electric shock.

Bend antenna cable between inside and outside building to prevent rain from flowing in.

- This may cause water damaged inside the set and could give an electric shock.

Earth wire should be connected.

- If the earth wire is not connected, there is possible a danger of electric shock caused by the current leakage.
- If grounding methods are not possible, a separate circuit breaker should be employed and installed by a qualified electrician.

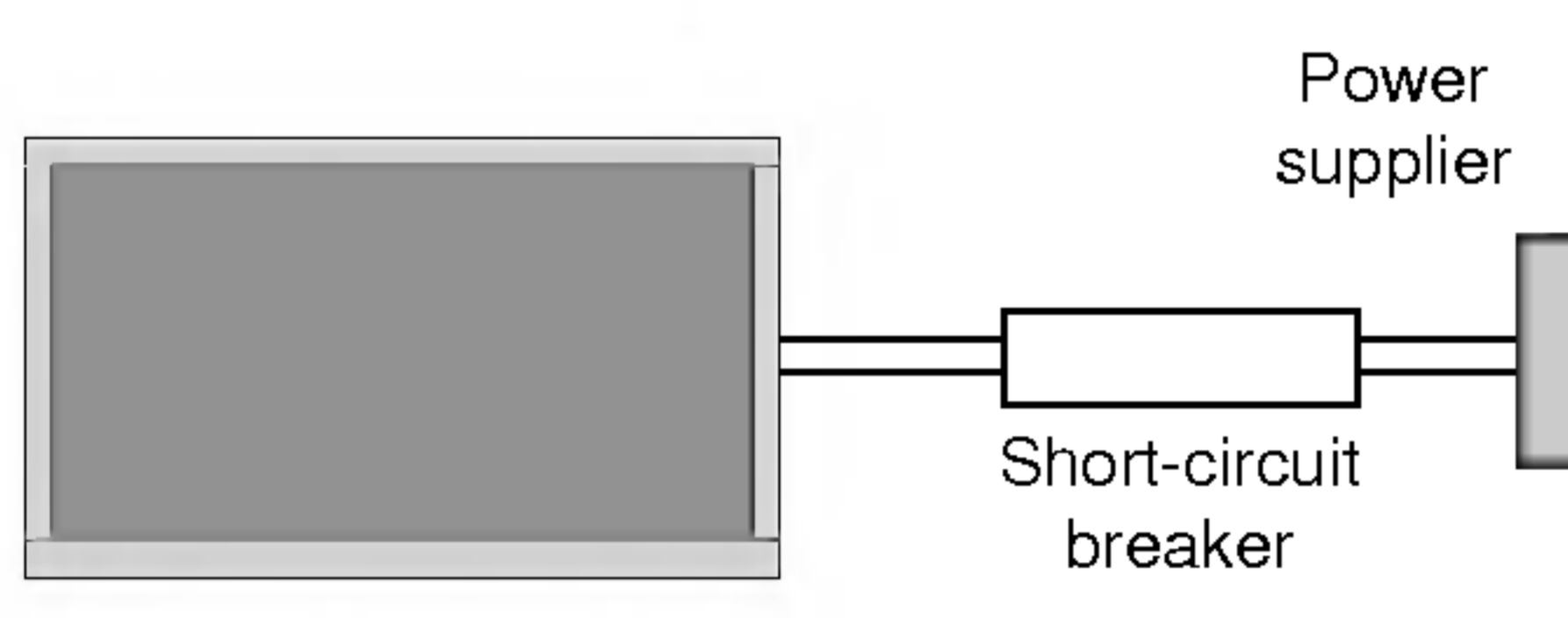

- Do not connect ground to telephone wires, lightning rods or gas pipe.

Apparatus shall not be exposed to dripping or splashing and no objects filled with liquids, such as vases, shall be placed on the apparatus.

- This may cause a fire or could give an electric shock.

Do not insert any object into the exhaust vent.

- This may cause a fire or could give an electric shock.

Do not place heavy objects on the set.

- This may cause serious injury to a child or adult.

Do not use water while cleaning the set.

- This may cause damaged the set or could give an electric shock.

In case of smoke or strange smell from the set, switch it off ,unplug it from the wall outlet and contact your dealer or service centre.

- This may cause a fire or could give an electric shock.

Do not attempt to service the set yourself. Contact your dealer or service centre.

- This may cause damaged the set or could give an electric shock.

During storm activity, unplug the set from the wall outlet and don't touch the antenna cable.

- This may cause damaged the set or could give an electric shock.

DISCONNECTING DEVICE FROM MAINS

- Mains plug is the disconnecting device. The plug must remain readily operable.

WARNING

TO REDUCE THE RISK OF FIRE AND ELECTRIC SHOCK, DO NOT EXPOSE THIS PRODUCT TO RAIN OR MOISTURE.

* Safety instructions have two kinds of information, and each meaning of it is as below.

⚠ WARNING The violation of this instruction may cause serious injuries and even death.

⚠ NOTES The violation of this instruction may cause light injuries or damage of the product.

⚠ Take care of danger that may happen under specific condition.

⚠ NOTES

Never touch the power plug with a wet hand.

- This may cause an electric shock.

Disconnect from the mains and remove all connections before moving.

Do not place the set in a built-in installation such as a bookcase or rack.

- Ventilation required.

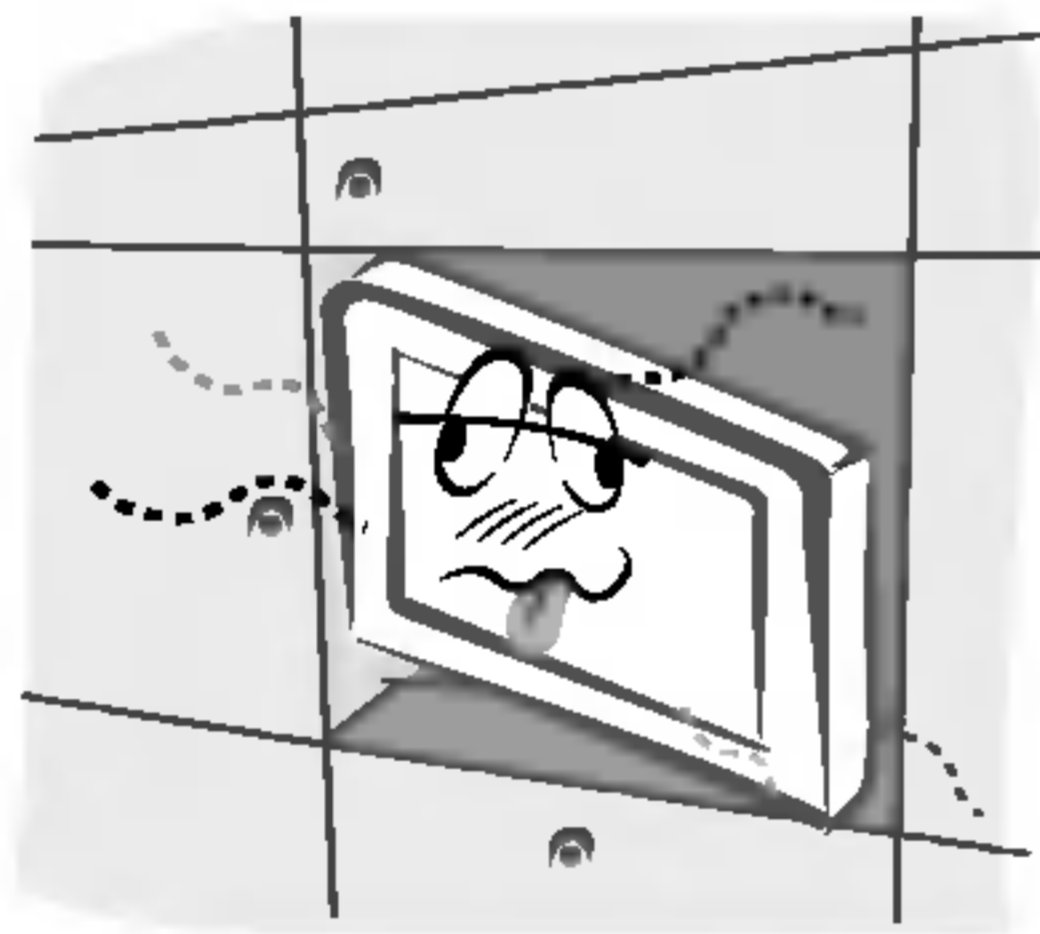

When installing the set on a table, be careful not to place the edge of its stand on the end of the table.

- This may cause the set to fall, causing serious injury to a child or adult, and serious damage to the set.

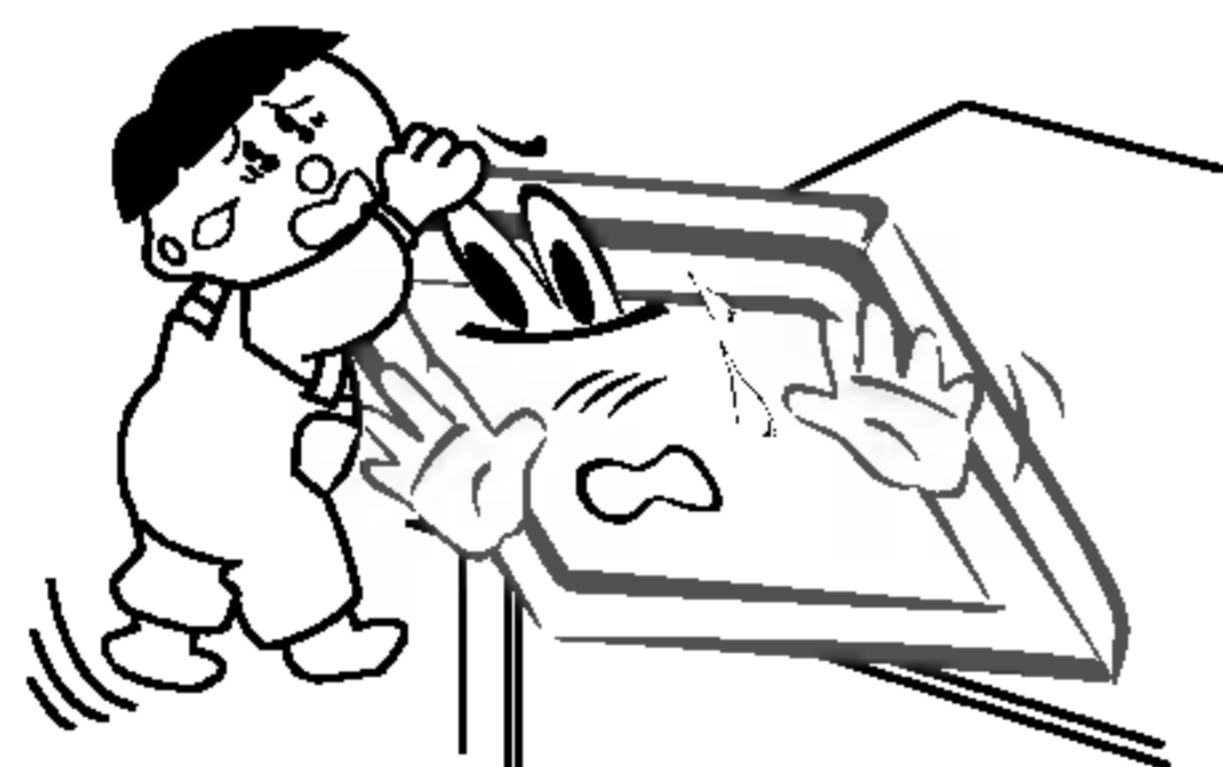

Do not place an outside antenna in the vicinity of overhead power lines or other electric light or power circuits.

- This may cause an electric shock.

There should be enough distance between an outside antenna and power lines to keep the former from touching the latter even when the antenna falls.

- This may cause an electric shock.

Do not pull the plug not the cord when disconnecting.

- This may cause a fire.

Ensure the power cord doesn't trail across any hot objects like a heater.

- This may cause a fire or an electric shock.

Do not plug in unit if power cord or plug is damaged or the connecting part of the power outlet is loose.

- This may cause a fire or an electric shock.

Dispose of used batteries carefully to prevent a child from eating them.

- In case of a child eating them, contact doctor immediately.

When moving the set assembled with speakers do not carry holding the speakers.

- This may cause the set to fall, causing serious injury to a child or adult, and serious damage to the Monitor.

Unplug this product from the wall outlet before cleaning. Do not use liquid cleaners or aerosol cleaners.

- This may cause damage the set or could give an electric shock.

Contact the service centre once a year to clean the internal part of the set.

- Accumulated dust can cause mechanical failure.

The distance between eyes and the screen should be approx. 5 ~ 7 times the diagonal length of the screen away.

- If not, eyes will strain.

Unplug the set from the wall outlet when it is left unattended and unused for long periods of time or in the occurrence of a state of emergency.

- Accumulated dust may cause a fire or an electric shock from deterioration through electric leakage.

Contents

Safety Warnings		
Safety Instructions	2~3
Introduction		
Remote Control Key Functions	5
Location and Function of Controls	6~7
Installation		
External Equipment Viewing Setups	8
Displayable Monitor Specification	9
HDMI	10
Accessories	11
Installation Options	12
Operation		
Turning on the Set	13
On-Screen Menu Language Selection (option)	13
On screen menus	14
Channel Menu Options		
Auto Programme Tuning	15
Manual Programme Tuning	15
Fine Tuning	15
Assigning a Station Name	16
Booster (option)	16
Programme Edit	16
Favourite Programme	16
Calling up the Programme Table	16
Picture Menu Options		
PSM (Picture Status Memory)	17
CSM (Colour Status Memory)	17
Manual Colour Temperature Control	17
XD	17
sRGB	17
ACM (Active Colour Management)	17
Manual Picture Control	17
Sound Menu Options		
SSM (Sound Status Memory)	17
BBE	17
AVL (Auto Volume Leveler)	17
Adjusting Sound Control	17
TV speaker	18
Stereo/Dual Reception	18
NICAM Reception (option)	18
Time Menu Options		
Setting the Clock	18
Setting the On/Off Timer	18
Auto Sleep	18
Sleep Timer	18
Special Menu Options		
Child Lock	19
ISM (Image Sticking Minimization) Method	19
Low Power	19
XD Demo	19
Index	19
Screen Menu Options		
Auto Configure	19
Manual Configure	19
Selecting Wide VGA/XGA mode	19
Setting Picture Format	20
Picture Size Zoom	20
Screen Position	20
Cinema	20
NR (Noise Reduction)	20
Initializing (Reset to original factory value)	20
Teletext (option)		
Teletext Language Selection	20
Switch on/off	20
SIMPLE Text (option)	21
TOP Text (option)	21
FASTEXT	21
Special Teletext Functions	21
PIP (Picture-in-Picture) Feature		
Watching PIP	22
Programme Selection for Sub Picture	22
Selecting an Input Signal Source for the PIP	22
Moving the PIP (PIP mode only)	22
POP (Picture-out-of-Picture: Channel Scan)	22
Picture Size	22
Adjusting the screen for the PIP	22
Adjusting PIP Transparency (PIP mode only)	22
XSTUDIO		
Notes on Memory Card	23~25
JPEG File Viewing Options	26~30
MP3 File Playing Operation	31~34
Miscellaneous		
Programming the Remote (option)	35
Programming Codes (option)	36~37
Troubleshooting Checklist	38
Product Specifications	39

After reading this manual, keep it in a place where the user can refer to easily.

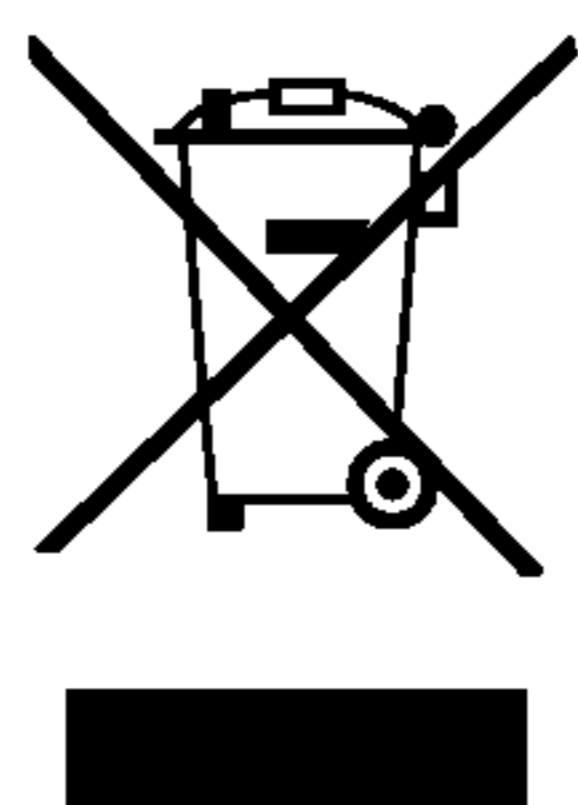

Disposal of your old appliance

1. When this crossed-out wheeled bin symbol is attached to a product it means the product is covered by the European Directive 2002/96/EC.
2. All electrical and electronic products should be disposed of separately from the municipal waste stream via designated collection facilities appointed by the government or the local authorities.
3. The correct disposal of your old appliance will help prevent potential negative consequences for the environment and human health.
4. For more detailed information about disposal of your old appliance, please contact your city office, waste disposal service or the shop where you purchased the product.

Remote Control Key Functions

- When using the remote control aim it at the remote control sensor of the set.
- There maybe a defect in consecutive operation of remote control in a specified brightness according to this set.

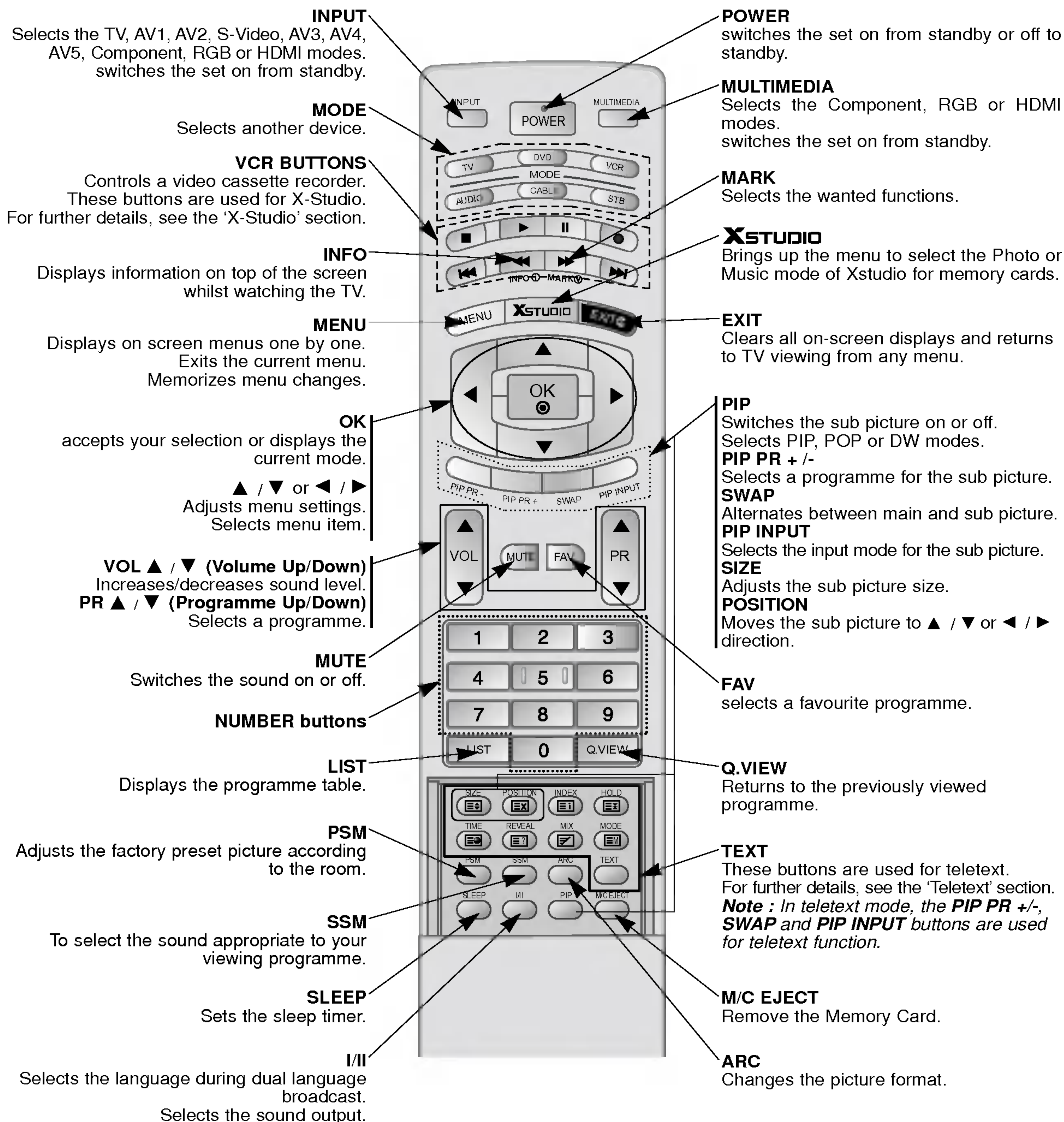

Installing Batteries

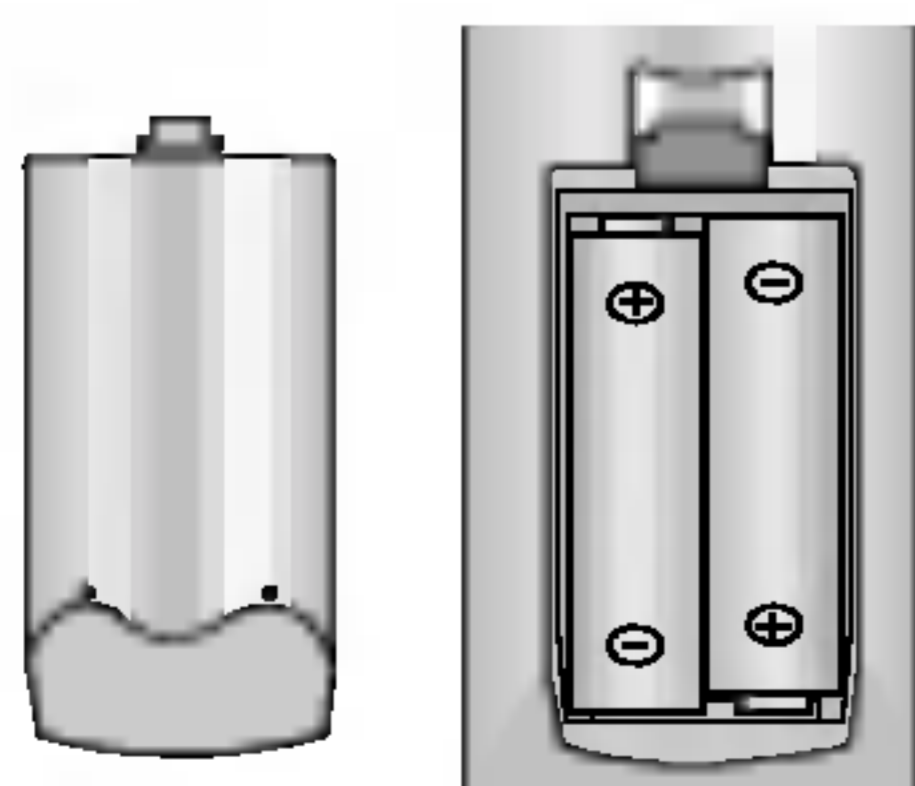

- Open the battery compartment cover on the back side and insert the batteries with correct polarity.
- Install two 1.5V alkaline batteries of AA type. Don't mix used batteries with new batteries.

Location and Function of Controls

- Shown is a simplified representation of the set.
- Here shown may be somewhat different from your set.

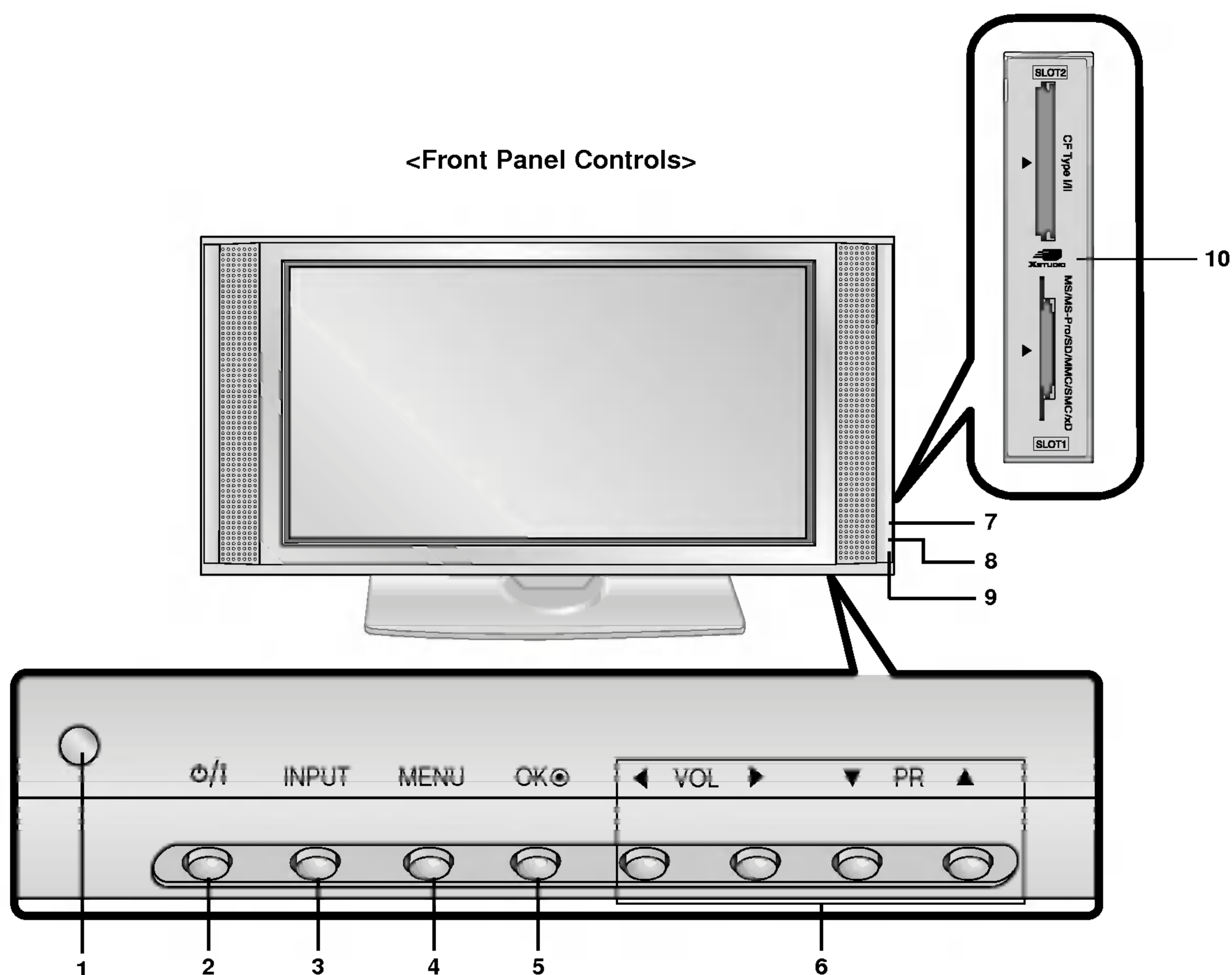

- | | |
|---|--|
| <ol style="list-style-type: none"> 1. Remote Control Sensor 2. Power Button
Switches the set on from standby or off to standby. 3. INPUT Button
Selects the TV, AV1, AV2, S-Video, AV3, AV4, AV5, Component, RGB or HDMI modes. switches the set on from standby. 4. MENU
Displays on screen menus one by one.
Exits the current menu.
Memorizes menu changes. 5. OK
Accepts your selection or displays the current mode. | <ol style="list-style-type: none"> 6. ▲ / ▼ (Programme Up/Down)
Selects a programme or a menu item.
Switches the set on from standby. ◀ / ▶ (Volume Up/Down)
Adjusts the volume.
Adjusts menu settings. 7. INDEX
Switches FRONT Display on or off. 8. Power Indicator
Illuminates red in standby mode, illuminates green when the set is turned on. 9. Intelligent Eye
Adjusts picture according to the surrounding conditions. 10. Memory Card Slots 1, 2 |
|---|--|

Location and Function of Controls

<Back Panel>

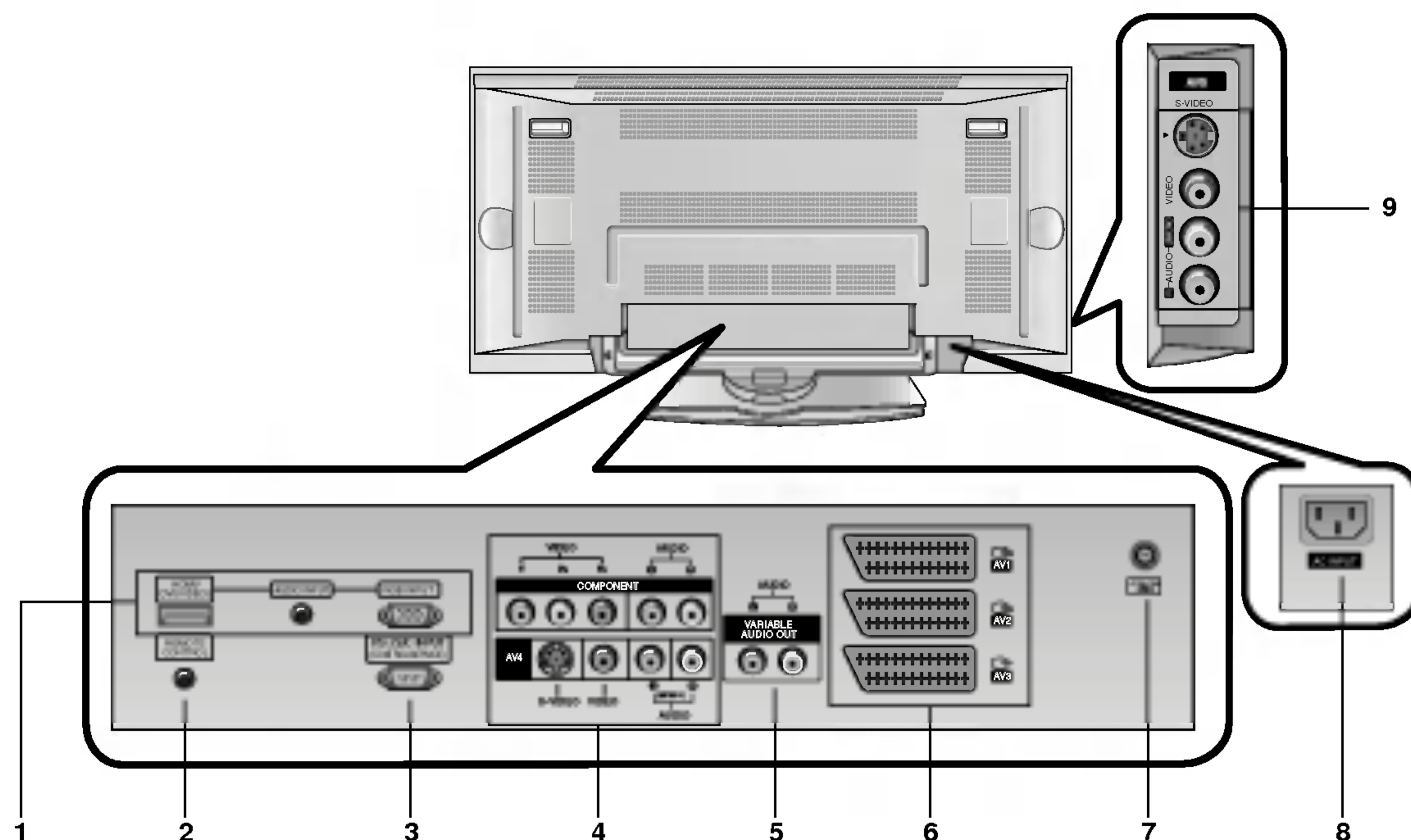

1. HDMI(DVI VIDEO) / AUDIO INPUT / RGB INPUT

Connect the monitor output socket of the PERSONAL COMPUTER, DVD or STB to this socket.

Note:

If you want to use RGB/DVI audio, we strongly recommend that you use the cable that has a core, or the EMI Filter core along with separate cable.

2. REMOTE CONTROL

3. RS-232C INPUT(CONTROL/SERVICE) PORT

Connect to the RS-232C port on a PC.

4. COMPONENT INPUT

Connect DVD video outputs to Y, P_B, P_R of COMPONENT INPUT and audio outputs to Audio sockets of AUDIO INPUT.

AUDIO/VIDEO IN SOCKETS (AV4)

Connect the audio/video out sockets of external equipment to these sockets.

S-VIDEO/AUDIO IN SOCKETS

Connect the S-VIDEO out socket of an VCR to the S-VIDEO socket.

Connect the audio out sockets of the VCR to the audio sockets as in AV4.

5. VARIABLE AUDIO OUTPUT

6. EURO SCART SOCKET

Connect the euro scart socket of the VCR to these sockets.

Note:

a. If you want to use the EURO scart cable, you have to use the signal shielded Euro scart cable.

b. If the S-VIDEO(Y/C) signal is received through the Euro scart socket 2 (AV 2), you must change to the S-Video 2 (Y/C) mode.

7. ANTENNA INPUT

8. POWER CORD SOCKET

This Monitor operates on AC power. The voltage is indicated on the Specifications page. Never attempt to operate the set on DC power.

9. AUDIO/VIDEO INPUT (AV5)

S-VIDEO/AUDIO IN SOCKETS

External Equipment Viewing Setups

<Back Panel>

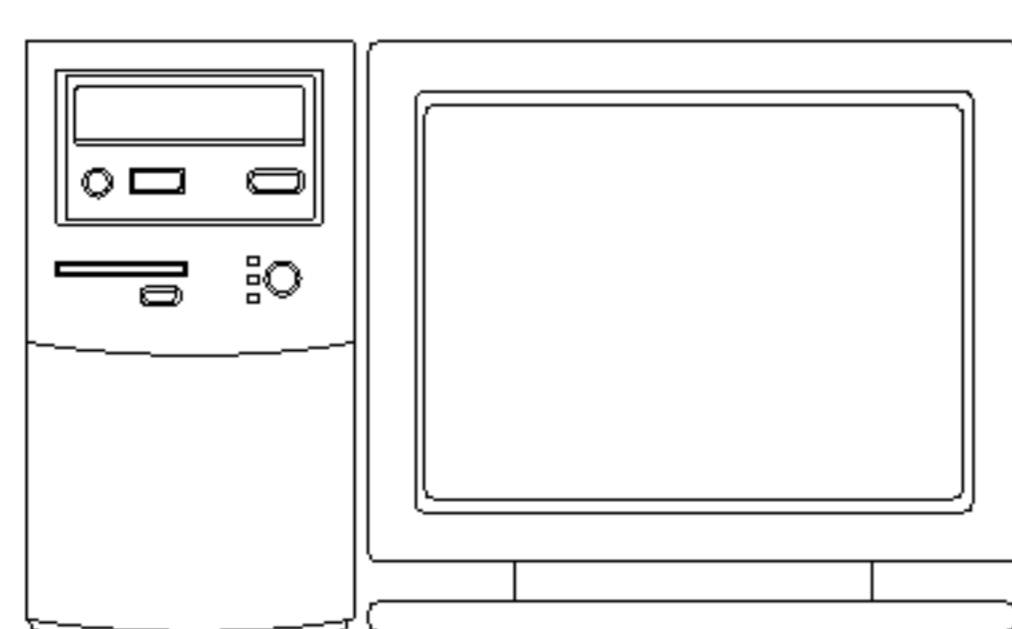
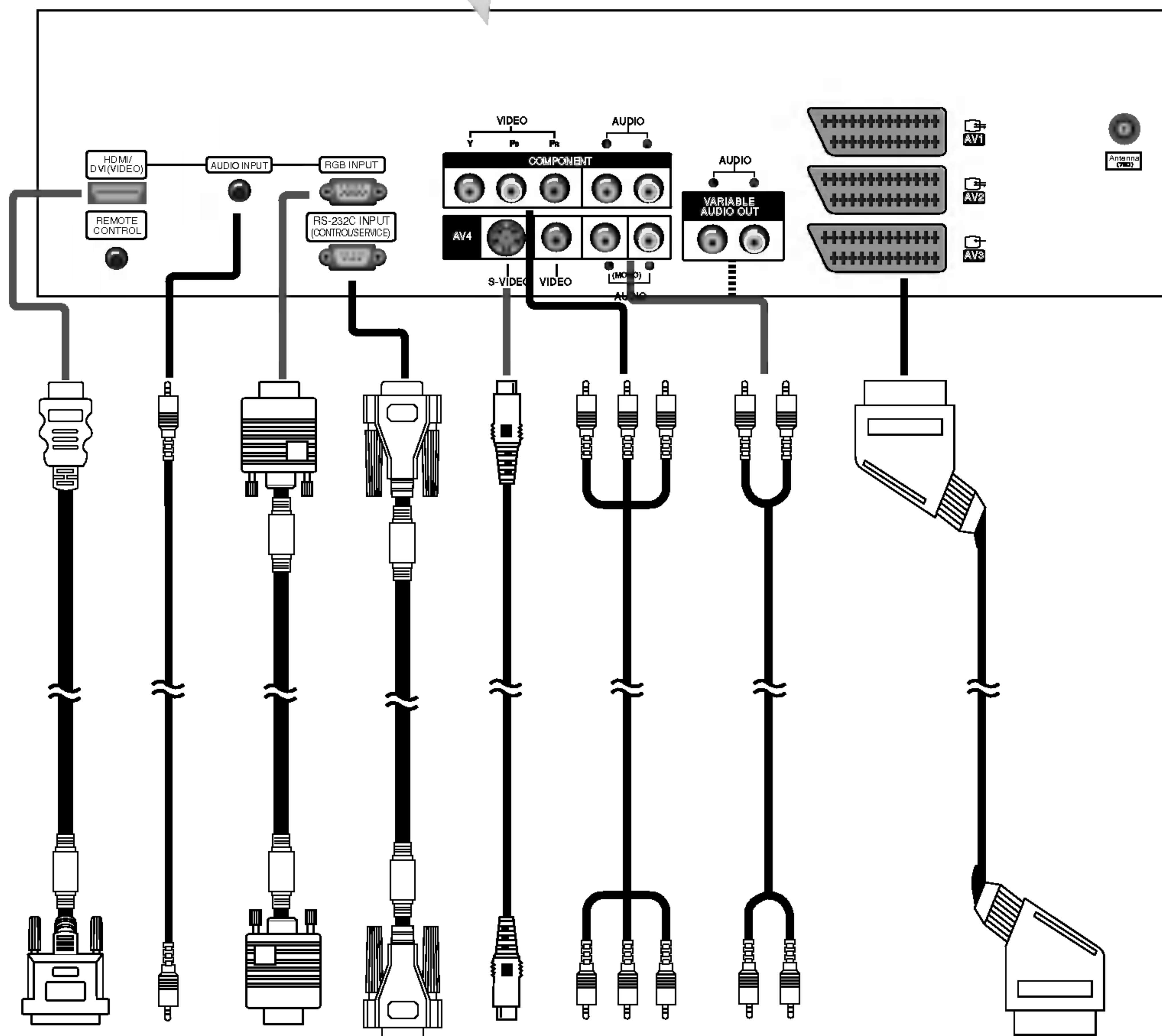
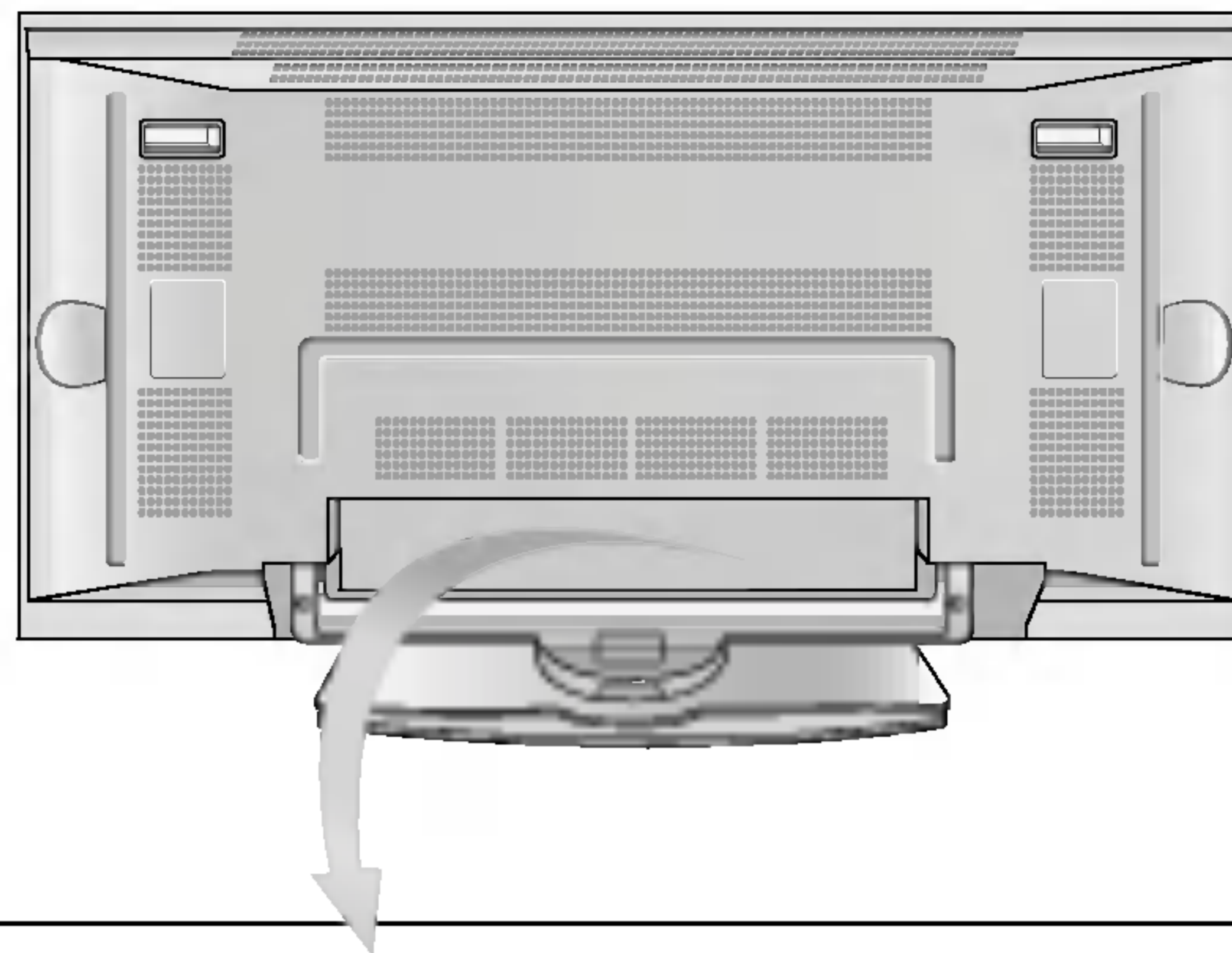

Connection to PC



Connection to AV equipment

Displayable Monitor Specification

RGB / HDMI mode

42PX4R / 42PX5R Series

Resolution	Horizontal Frequency(KHz)	Vertical Frequency(Hz)
640x350	31.468	70.09
	37.861	85.08
720x400	31.469	70.08
	37.927	85.03
640x480	31.469	59.94
	35.000	66.66
	37.861	72.80
	37.500	75.00
848x480	43.269	85.00
	31.500	60.00
	37.799	70.00
852x480	39.375	75.00
	31.500	60.00
800x600	37.799	70.00
	39.375	75.00
	35.156	56.25
832x624	37.879	60.31
	48.077	72.18
	46.875	75.00
	53.674	85.06
1024x768	49.725	74.55
	48.363	60.00
	56.476	70.06
	60.023	75.02
1360x768	68.677	85.00
	47.700	60.00
1366x768	59.625	75.02
	47.700	60.00
1152x864	59.625	75.02
	54.348	60.05
	63.995	70.01
1152x870	67.500	75.00
	68.681	75.06
1280x768	47.693	60.00
	60.091	75.00
1280x960	60.023	60.02
1280x1024	63.981	60.02

50PX4R / 50PX5R Series

Resolution	Horizontal Frequency(KHz)	Vertical Frequency(Hz)
640x350	31.468	70.09
	37.861	85.08
720x400	31.469	70.08
	37.927	85.03
640x480	31.469	59.94
	35.000	66.66
	37.861	72.80
	37.500	75.00
848x480	43.269	85.00
	31.500	60.00
	37.799	70.00
852x480	39.375	75.00
	31.500	60.00
800x600	37.799	70.00
	39.375	75.00
	35.156	56.25
832x624	37.879	60.31
	48.077	72.18
	46.875	75.00
	53.674	85.06
1024x768	49.725	74.55
	48.363	60.00
	56.476	70.06
	60.023	75.02
1360x768	68.677	85.00
	47.700	60.00
1366x768	59.625	75.02
	47.700	60.00
1152x864	59.625	75.02
	54.348	60.05
	63.995	70.01
1152x870	67.500	75.00
	68.681	75.06
1280x768	47.693	60.00
	60.091	75.00
1280x960	60.023	60.02
1280x1024	63.981	60.02



- HDMI™, the HDMI logo and High-Definition Multimedia Interface are trademarks or registered trademarks of HDMI Licensing.
- This set can receive the High-Definition Multimedia Interface (HDMI) or Input of Digital Visual Interface(DVI).
- This set supports HDCP (High-bandwidth Digital Contents Protection) Protocol for the set (480p, 720p, 1080i) modes.
- When you connect to HDMI/DVI Source devices (DVD Player, STB or PC) that support AUTO HDMI/DVI Plug & Play, this sets the HDMI/DVI source devices automatically. After reading HDMI/DVI source devices, using Display Data Channel (DDC) Protocol, Extended Display Identification Data (EDID) stored in the set is used. If HDMI/DVI Source devices do not support AUTO HDMI/DVI, the resolution is set manually.
- When Source Devices have DVI Output Connector, you must connect audio with separated cable. (Refer to <How to connect>)

How to connect

1. When Source Devices (DVD Player or Set Top Box) support HDMI.
 - If Source Devices have HDMI Output Connector, Source Devices connect to the set with HDMI Cable .(not supplied with the product).
 - If Source Devices support Auto HDMI, automatically, Source Devices divert output resolution in 1280 x 720p. But if not, refer to the reference Manual of Source Devices and select resolution manually.
 - To get the best picture quality, adjust the DVD Player or Set Top Box output resolution to 1280 x 720p.
 - Because HDMI sends Digital Video and Audio with one cable, there is no need for a special Audio Cable when using a HDMI Cable.
2. When Source Devices (DVD Player or Set Top Box) supports DVI.
 - If Source Devices have DVI Output Connector, Source Devices connect to the set with HDMI to DVI Cable (not supplied with the product).
 - If Source Devices support Auto DVI, automatically, Source Devices divert output resolution in : 1280 x 720p. But if not, refer to the reference Manual of Source Devices and select resolution manually.
 - To get the best picture quality, adjust the DVD Player or Set Top Box output resolution to 1280 x 720p.
 - In this case, use another cable for audio. When Source Devices have Analog Audio Output Connector, RGB/DVI Audio Input of the set connect to Audio Cable (not supplied with the product). And then you can listen to normal Audio.
3. When PC supports DVI.
 - If PC have DVI Output Connector, Source Devices connect to the set with HDMI to DVI Cable (not supplied with the product).
 - To get the best picture quality, adjust the PC graphics card to 1024 x 768, 60Hz.
 - Use the the set's HDMI/DVI (VIDEO) for video connections, depending on your PC connector.
 - If the graphics card on the PC does not output analog RGB and DVI simultaneously, connect only one of either RGB Input or HDMI/DVI Input to display the PC on the set.
 - If he graphics card on the PC does output analog RGB and DVI simultaneously, the set to either RGB Input or HDMI/DVI Input; (the other mode is set to Plug and Play automatically by the set.)
 - Then, make the corresponding audio connections. If using a sound card, adjust the PC sound as required.

- In this case, use another cable for audio. When PC (or sound card of PC) have Analog Audio Output Connector, RGB/DVI Audio Input of the set connect to Analog Audio Cable (not supplied with the product). And then you can listen to normal Audio.

Reference

Cable sample (not supplied with the product)

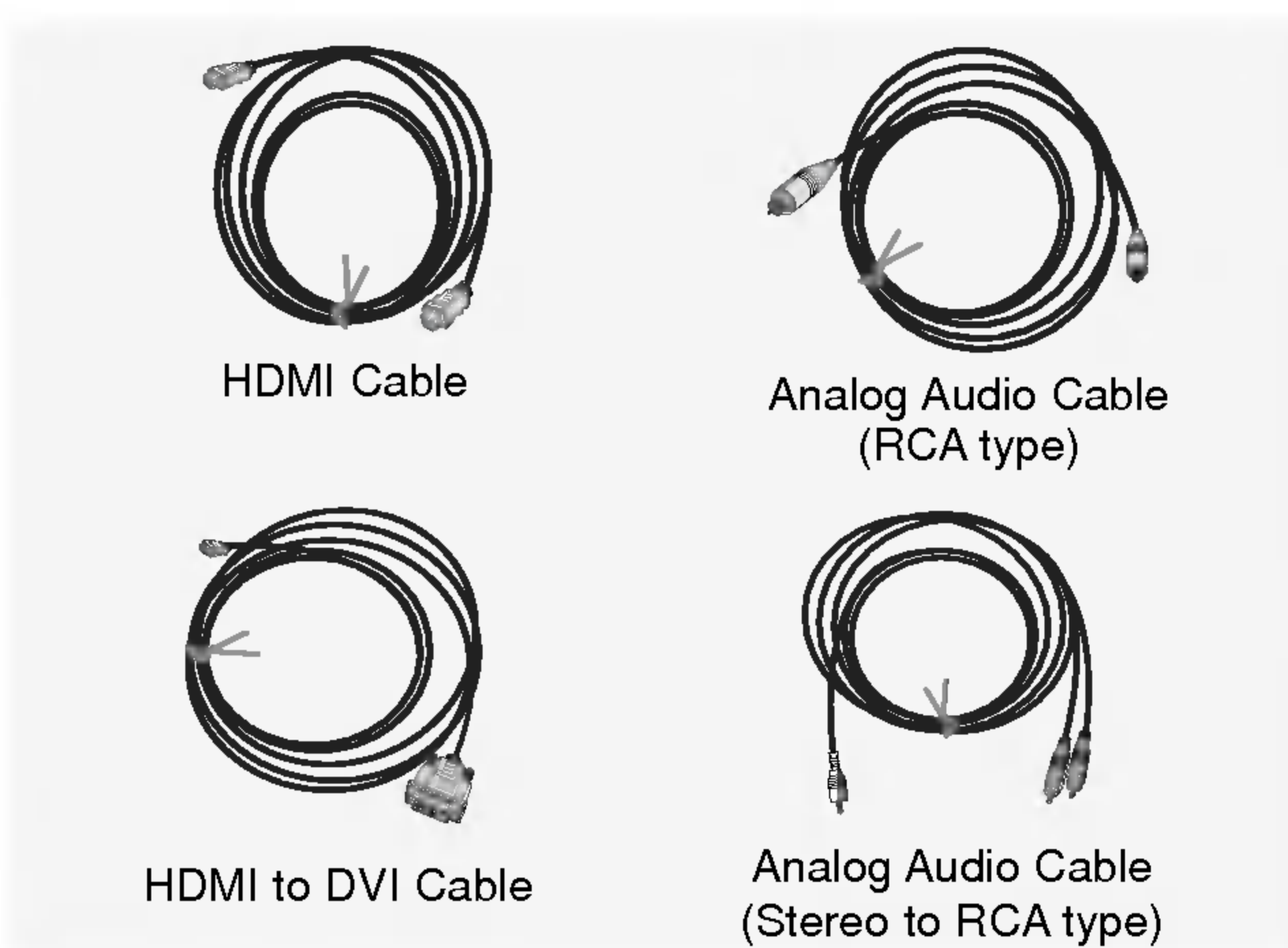

How to use

1. Connect the HDMI/DVI Source Devices(DVD Player or Set Top Box or PC) and the set.
2. Turn on the display by pressing the POWER button on the set and HDMI/DVI Source Devices remote control.
3. Select HDMI/DVI Input source in Main Input option of PIP/DW menu.
4. Check the image on your set. There may be noise associated with the resolution, vertical pattern, contrast or brightness in HDMI/DVI Source Devices. If noise is present, change the HDMI/DVI Source Devices to another resolution, change the refresh rate or adjust the brightness and contrast on the menu until the picture is clear. If the refresh rate of the PC graphics card can not changed, change the PC graphics card or consult the manufacturer of the PC graphics card.

Notes:

- Depending on the graphics card, DOS mode may not work if you use a HDMI to DVI Cable.
- Avoid keeping a fixed image on the set screen for a long period of time. The fixed image may become permanently imprinted on the screen. Use the Orbiter screen saver when possible.
- When Source Devices are connected with HDMI/DVI Input, output PC Resolution(VGA, SVGA, XGA), Position and Size may not fit to Screen. As shown on page 29, press the **MENU** button to adjust the screen Position of the set and contact an PC graphics card service centre.
- When Source Devices connected HDMI/DVI Input output the set Resolution(480p, 720p, 1080i), the set Display fit EIA/CEA-861-B Specification to Screen. If not, refer to the Manual of HDMI/DVI Source Devices or contact your service centre.
- In case HDMI/DVI Source Devices Cable is not connected or poor cable connection, "No Signal" OSD display will appear. And in case of Video Resolution not being supported by the set output in HDMI/DVI Source Devices, "No Signal" OSD display will appear. Refer to the Manual of HDMI/DVI Source Devices or contact your service centre.

Accessories



Owner's Manual



Remote Control handset



2-Eye Bolts

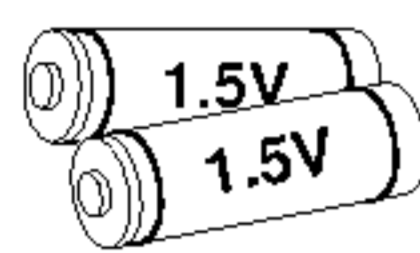

Alkaline batteries

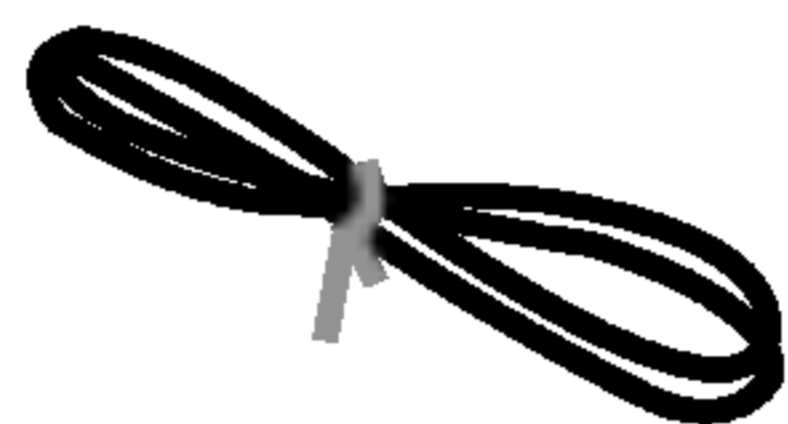

Power Cord



2-Wall brackets

Joining the set assembly to the wall to prevent the set tumbling

- Secure the set assembly by joining it to a wall by using the Eye Bolts/Wall brackets.

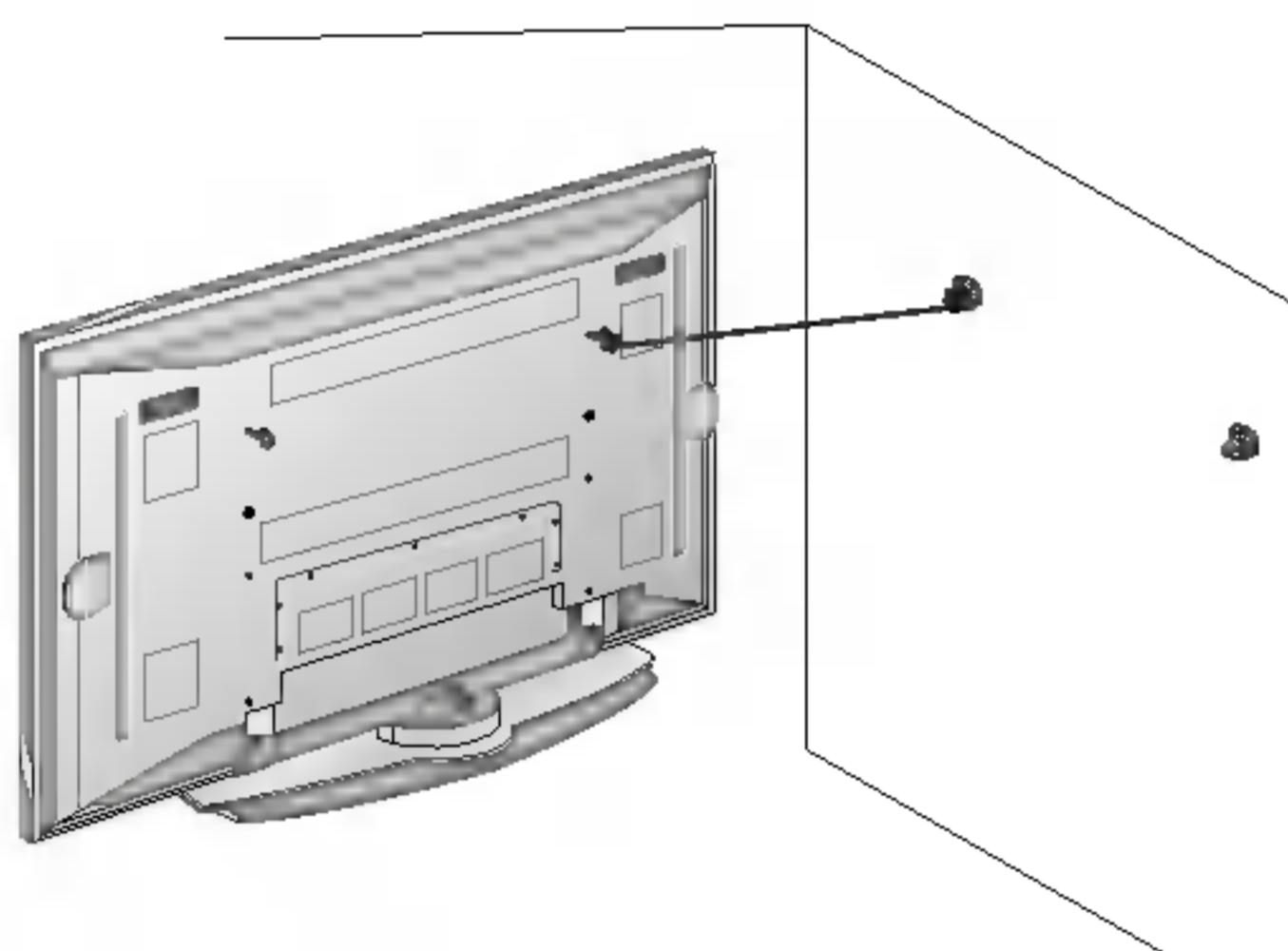

- If the set is to be mounted on a desk top, insert the 2 Eye-Bolts and tighten them securely in the upper holes as shown. Install the wall brackets on the wall with 2 bolts*, (not supplied with the product), as shown. Match the height of the Eye-Bolts and the wall brackets. Check to be sure the Eye-Bolts and the brackets are tightened securely.

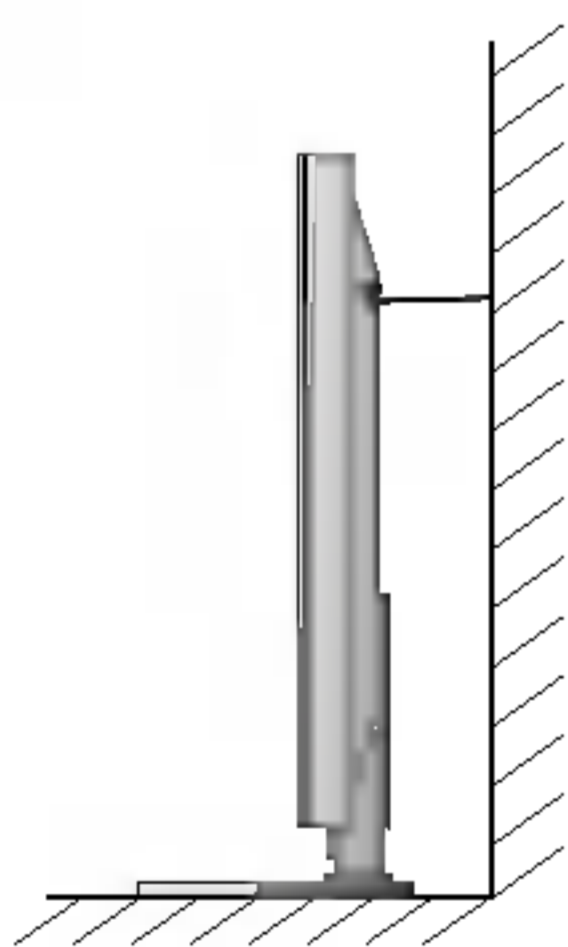

- Secure the set assembly to the wall with strong strings or wound wire cables, (not supplied with the product), as shown.

Optional Extras

- Optional extras can be changed or modified for quality improvement. Without any notification, new optional extras can be added.
- Contract your dealer for the purchasing of these items.

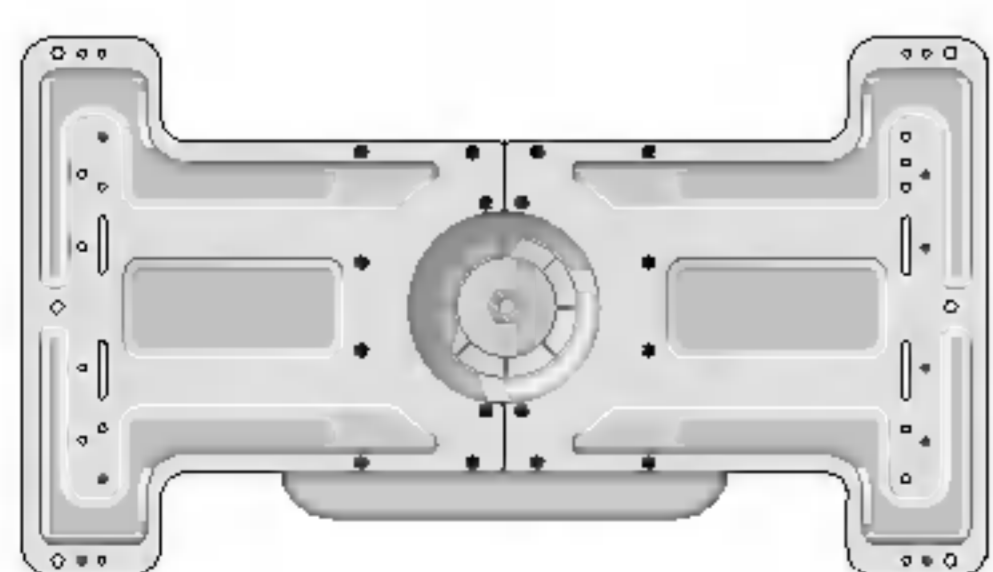

Tilt wall mounting bracket

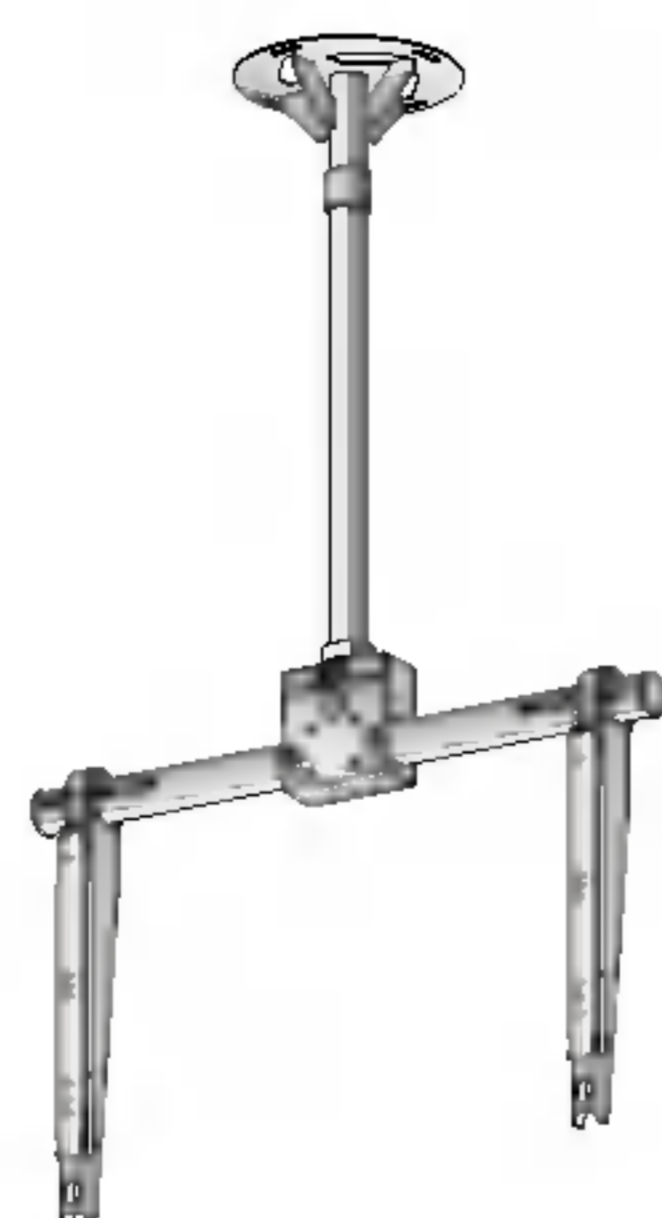

Ceiling mounting bracket

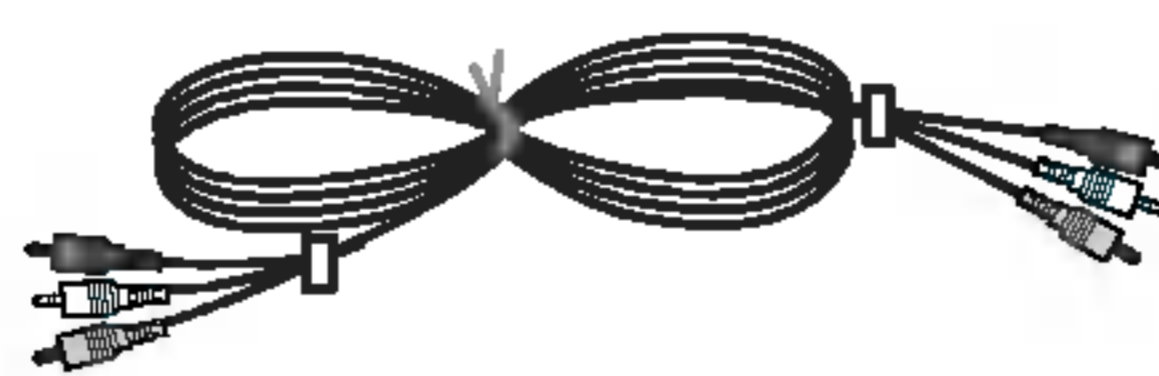

Video cables

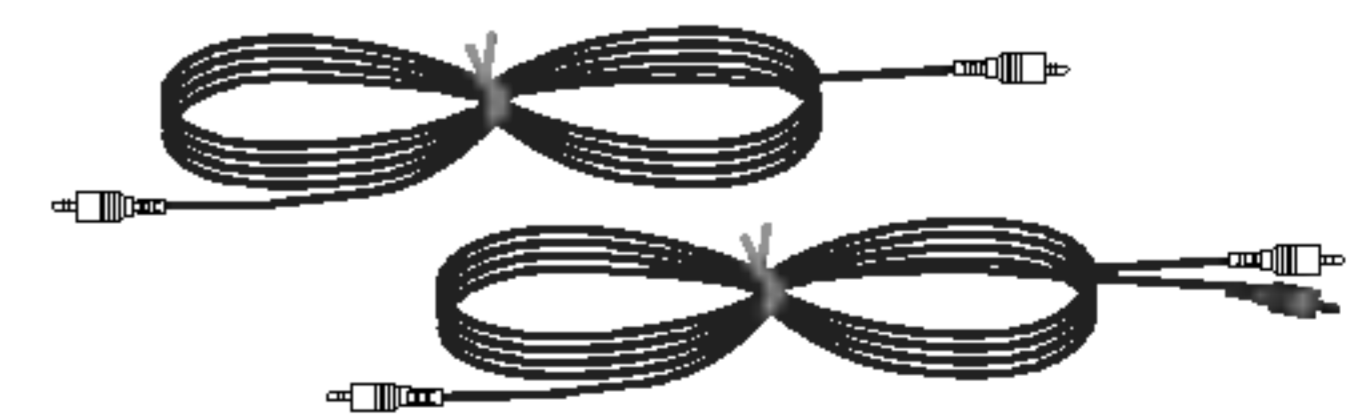

Audio cables

Installation Options

- The set can be installed in different ways such as on a wall, or on a desktop etc.
- Install this set only in a location where adequate ventilation is available.

Wall Mount: Horizontal Installation



- The set can be installed on a wall as shown above. (For further information, refer to the optional 'Wall Mounting Bracket Installation and Setup Guide'.)

Desktop Pedestal Installation



- The set can be mounted on a desk as shown above.

To Mount on a Wall

Wall mount minimum allowable clearances for adequate ventilation.

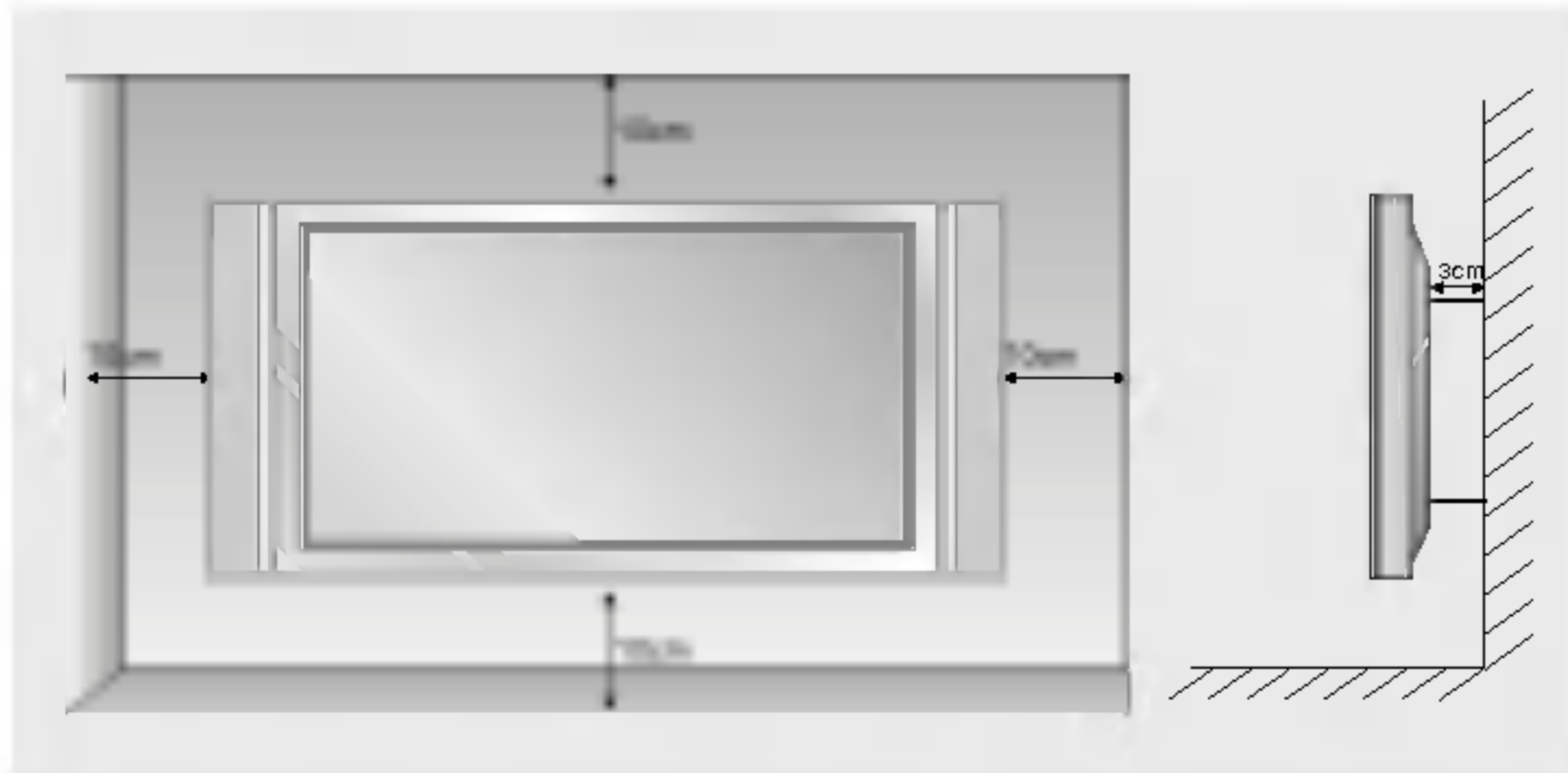

To Install on a Desktop

Pedestal mount minimum allowable clearances for adequate ventilation.

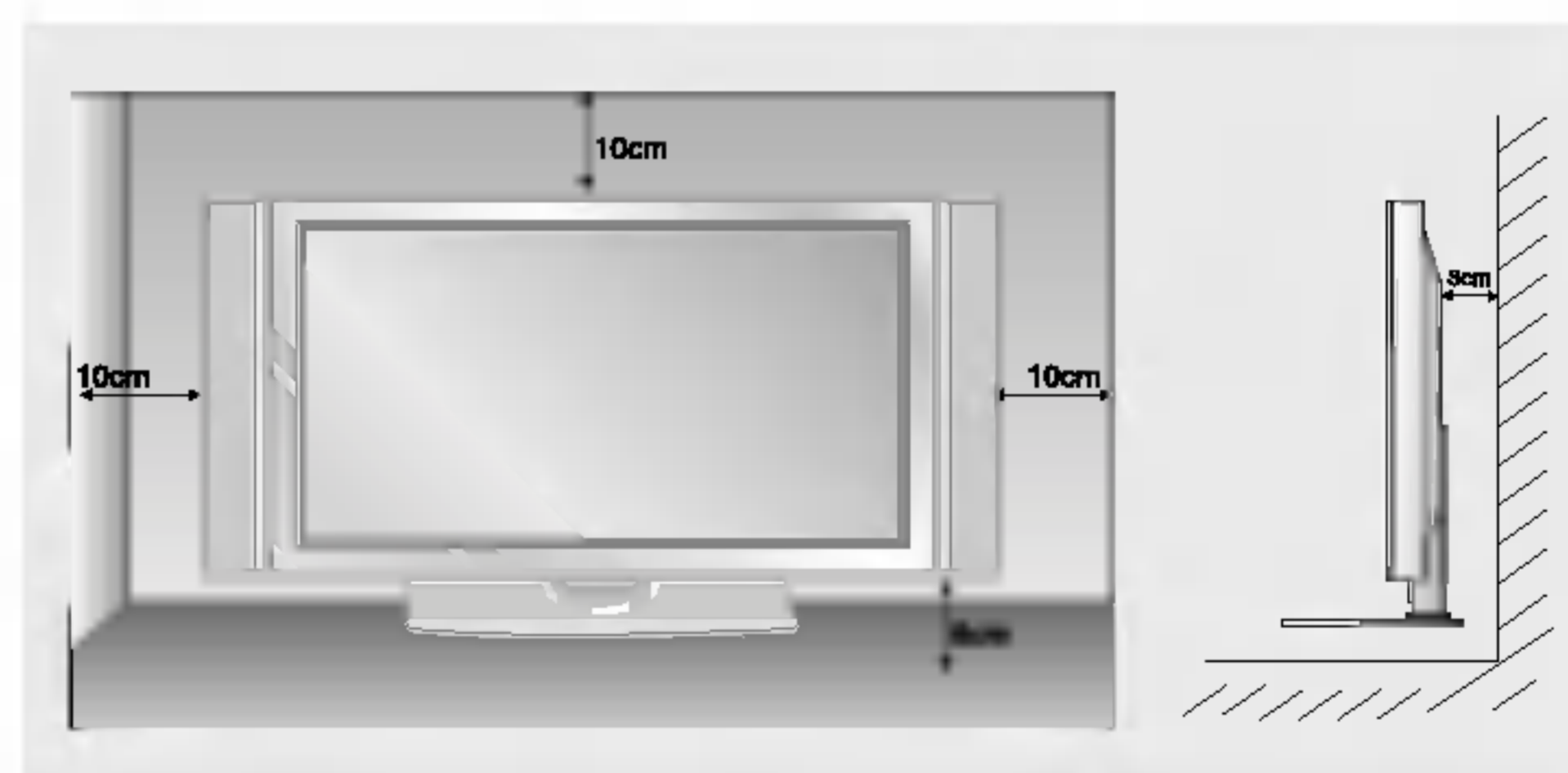

Swivel function (option)

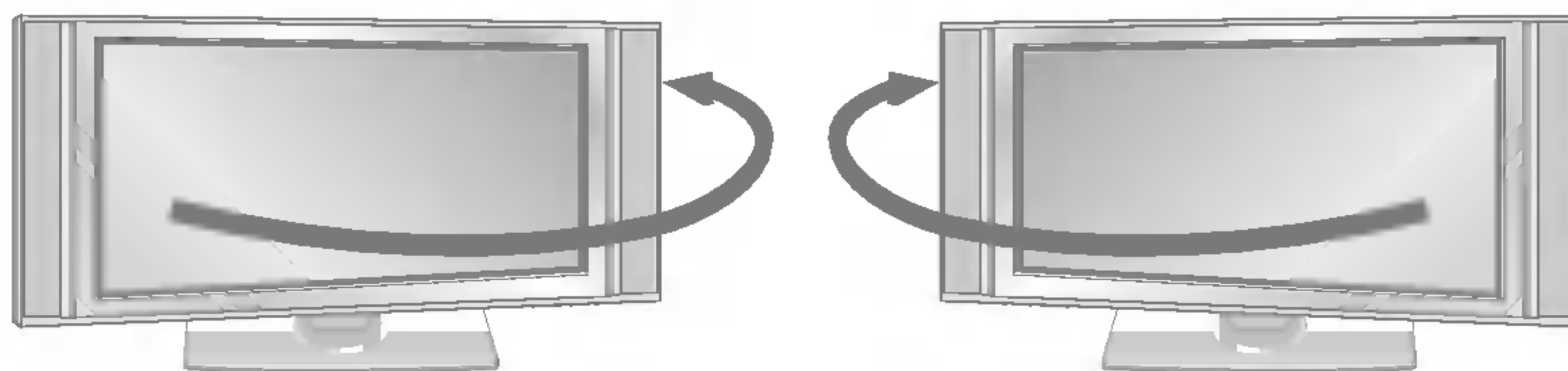

- After installing the set, you can adjust the set manually to the left or right direction by 20 degrees to suit your viewing position.

Note : Before adjusting the angle, you must loosen (to the left) the shaft bolt on the middle of stand's back. And when the stand is level with set, you must close (to the right) the shaft bolt to set the hole.

Turning on the Set

- When using the remote control, aim it at its sensor on the set.

Turning on the set just after installation

1. Connect power cord correctly, the set is switched to standby mode.
2. Press the \odot / I, **INPUT** or **PR ▲ / ▼** button on the set or press the **POWER**, **INPUT**, **MULTIMEDIA**, **PR ▲ / ▼** or **NUMBER** buttons on the remote control and then the set will switch on.

Turning on the set (power cord is still connected)

If the set was turned off with the remote control power button and the \odot / I button on the set

- Press the \odot / I, **INPUT** or **PR ▲ / ▼** button on the set or press the **POWER**, **INPUT**, **MULTIMEDIA**, **PR ▲ / ▼** or **NUMBER** button on the remote control to turn the set on.

On-Screen Menu Language Selection (option)

- The menus can be shown on the screen in the selected language. First select your language.
 1. Press the **MENU** button and then use **▲ / ▼** button to select the **SPECIAL** menu.
 2. Press the **▶** button and then use **▲ / ▼** button to select **Language**.
 3. Press the **▶** button and then use **▲ / ▼** button to select your desired language.
From this point on, the on-screen menus will be shown in the language of your choice.
 4. Press the **EXIT** button to return to normal TV viewing.

On screen menus

- The dialogue between you and your set takes place on screen with an operator menu. The buttons required for the operating steps are also displayed.

Menu selection

1. Press the **MENU** button and then **▲ / ▼** button to display each menu.
2. Press the **▶** button and then the **◀ / ▶** button to select a menu item.
3. Repeatedly press the **MENU** button to return to normal TV viewing.



STATION menu

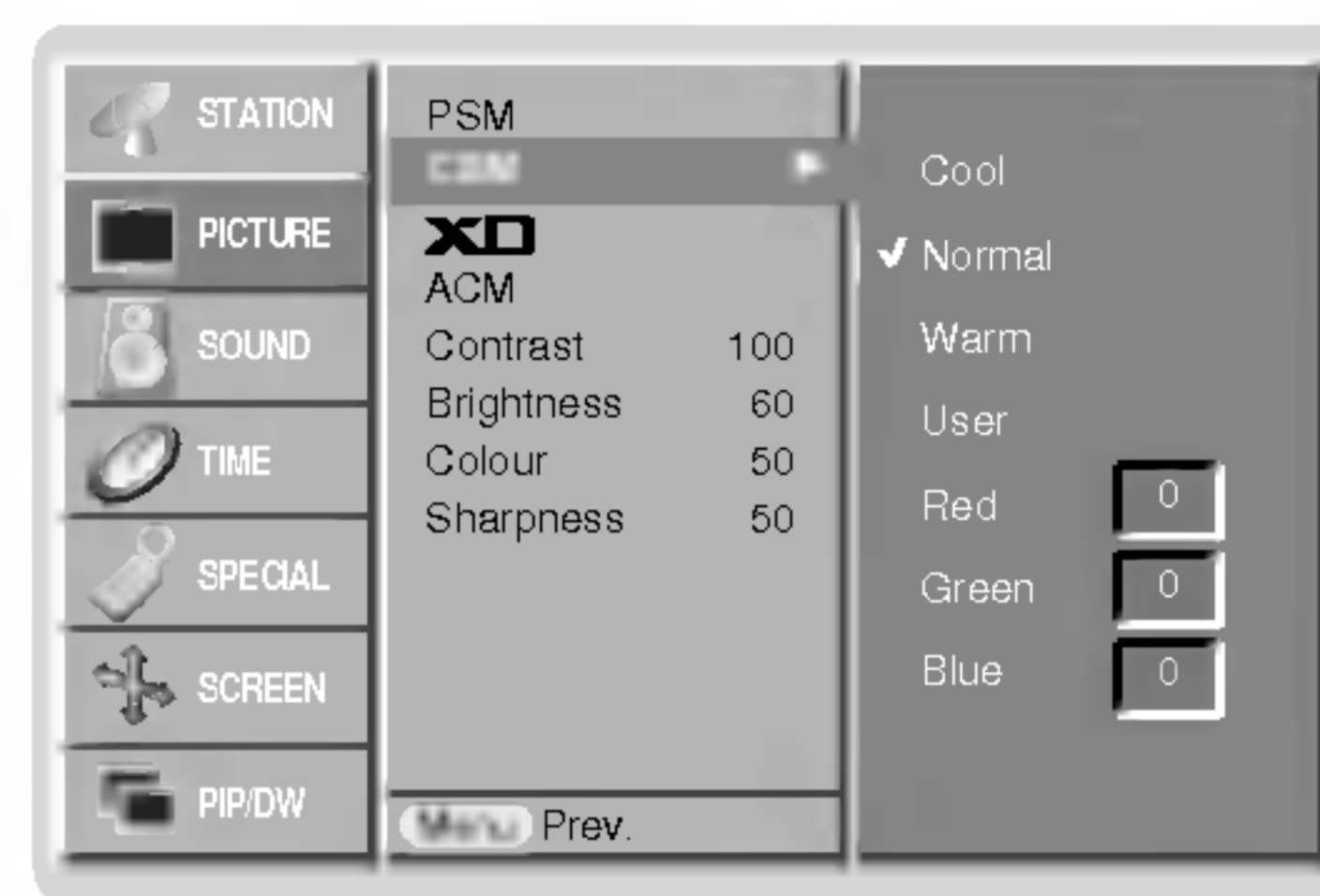

PICTURE menu

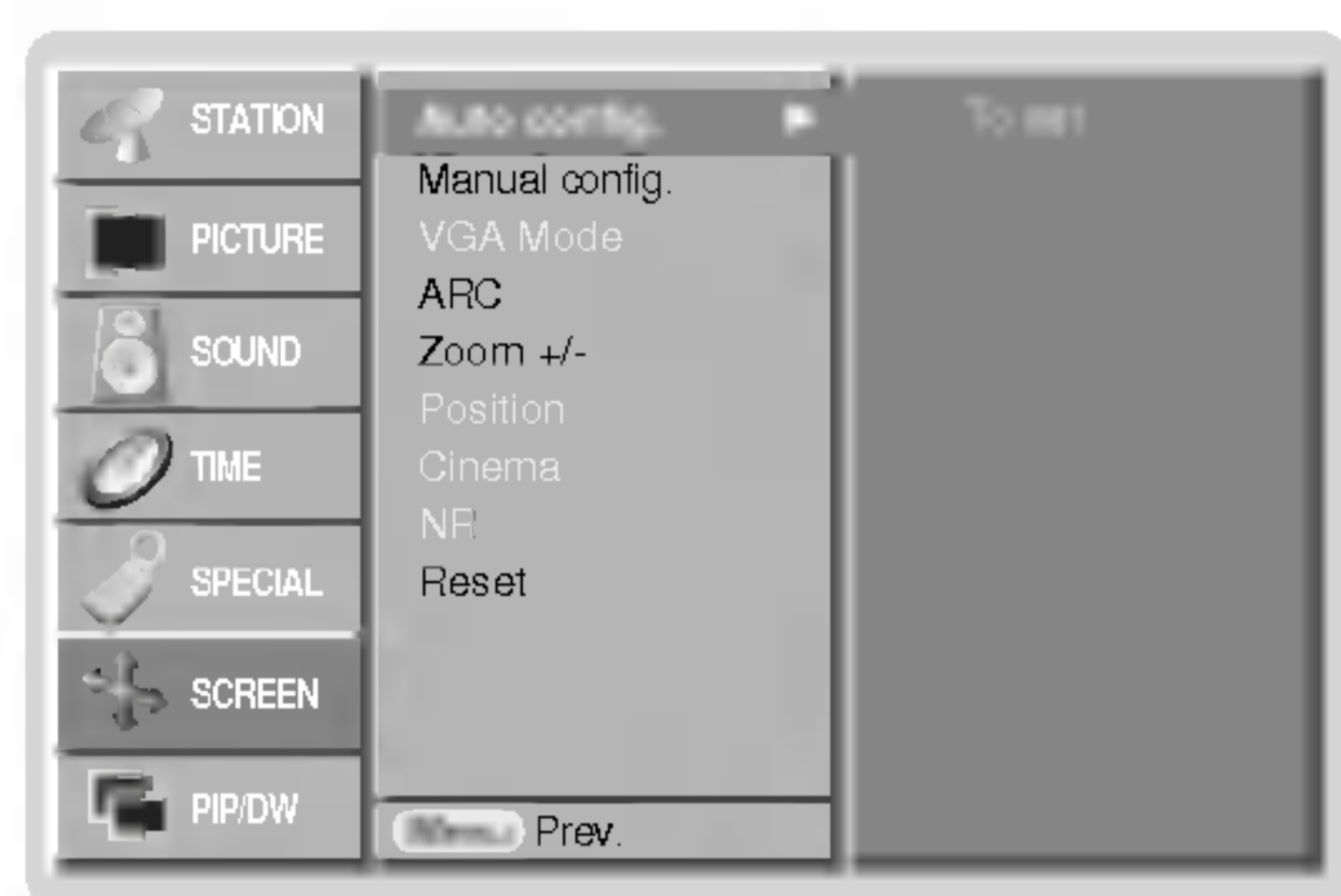

SCREEN menu

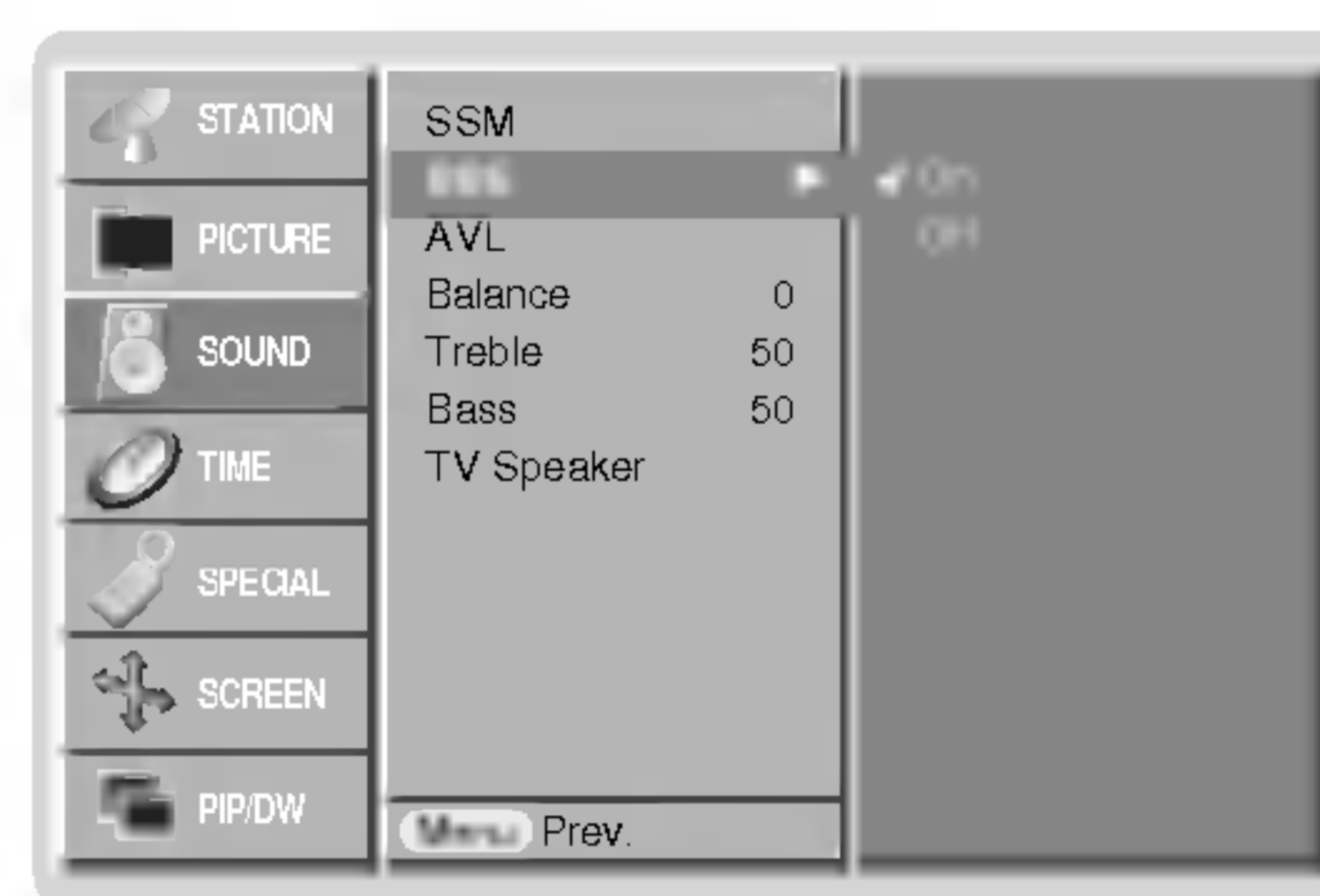

SOUND menu

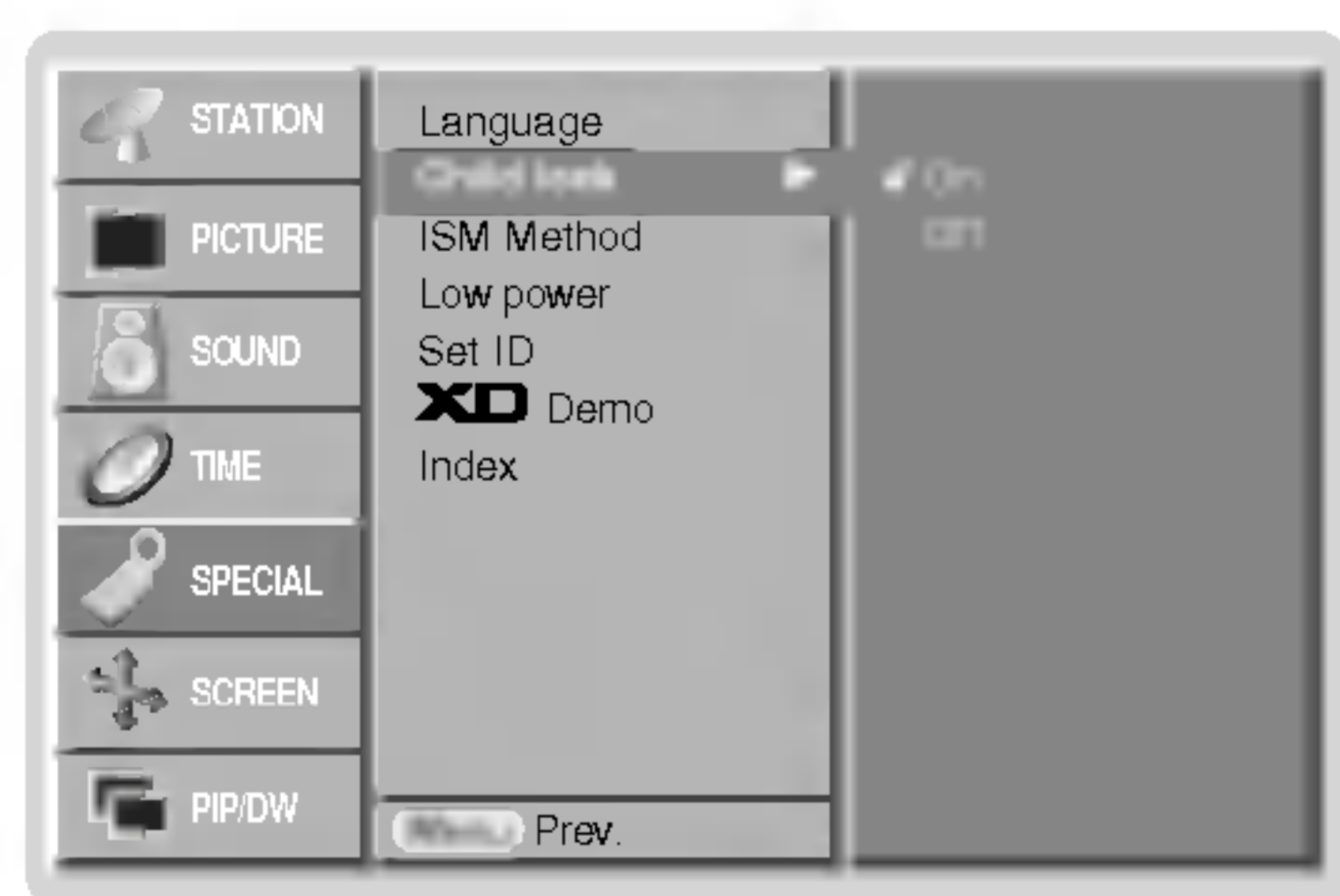

SPECIAL menu



TIME menu

Channel Menu Options

Auto Programme Tuning

- All stations that can be received are stored by this method. It is recommended that you use auto programme during installation of this set.

1. Press the **MENU** button and then use **▲ / ▼** button to select the STATION menu.

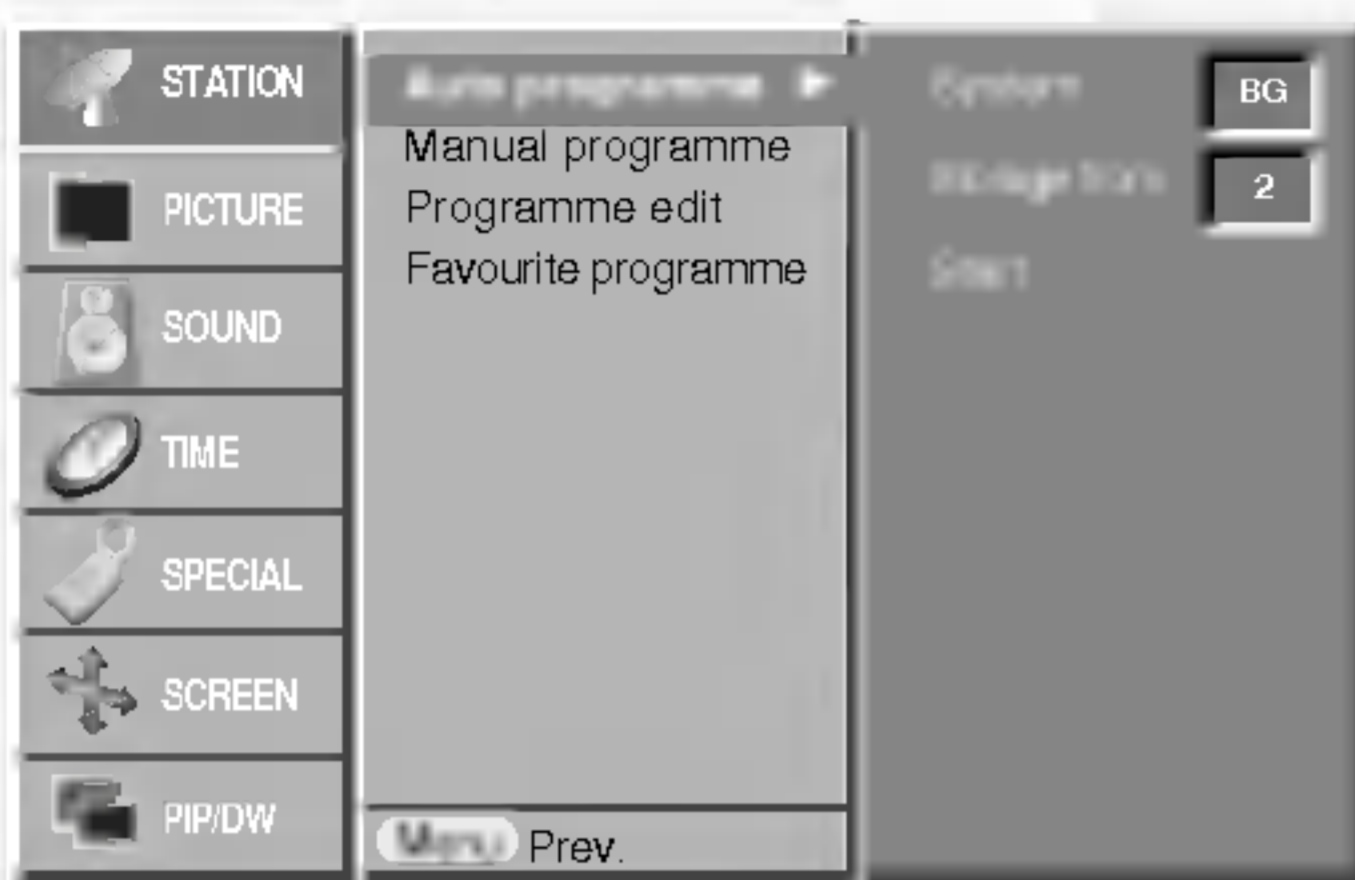

2. Press the **▶** button and then **▲ / ▼** button to select **Auto programme**.
3. Press the **▶** button to select **System**. Select a TV system with the **◀ / ▶** button;
 - L** : SECAM L/L' (option)
 - BG** : PAL B/G, SECAM B/G (Europe / East Europe / Asia / New Zealand / M.East / Africa /Australia)
 - I** : PAL I/II (U.K. / Ireland / Hong Kong / South Africa)
 - DK** : PAL D/K, SECAM D/K (East Europe / China / Africa / CIS)
 - M** : (USA / Korea / Philippines) (option)
4. Press the **▼** button to select **Storage from**. Select the beginning programme number with the **◀ / ▶** button or NUMBER buttons on the **Storage from** menu.
5. Press the **▼** button to select **Start**.
6. Press the **▶** button to begin auto programming. All receivable stations are stored.

Note :

a. In some models, the station name is stored for stations which broadcast VPS (Video Programme Service), PDC (Programme Delivery Control) or TELETEXT data. If no station name can be assigned to a station, the channel number is assigned and stored as **C** (V/UHF 01-69) or **S** (Cable 01-47), followed by a number.

b. In Australia, if no station name can be assigned to a station, the channel number is assigned and stored as ----- followed by a number see 'Assigning a station name' section to assign the station name.

To stop auto programming, press the **MENU** button.

When auto programming is completed, the **Programme edit** menu appears on the screen. See the 'Programme edit' section to edit the stored programme.

Manual Programme Tuning

- Manual programme lets you manually tune and arrange the stations in whatever order you desire. Also you can assign a station name with five characters to each programme number.

1. Press the **MENU** button and then use **▲ / ▼** button to select the STATION menu.
2. Press the **▶** button and then **▲ / ▼** button to select **Manual programme**.

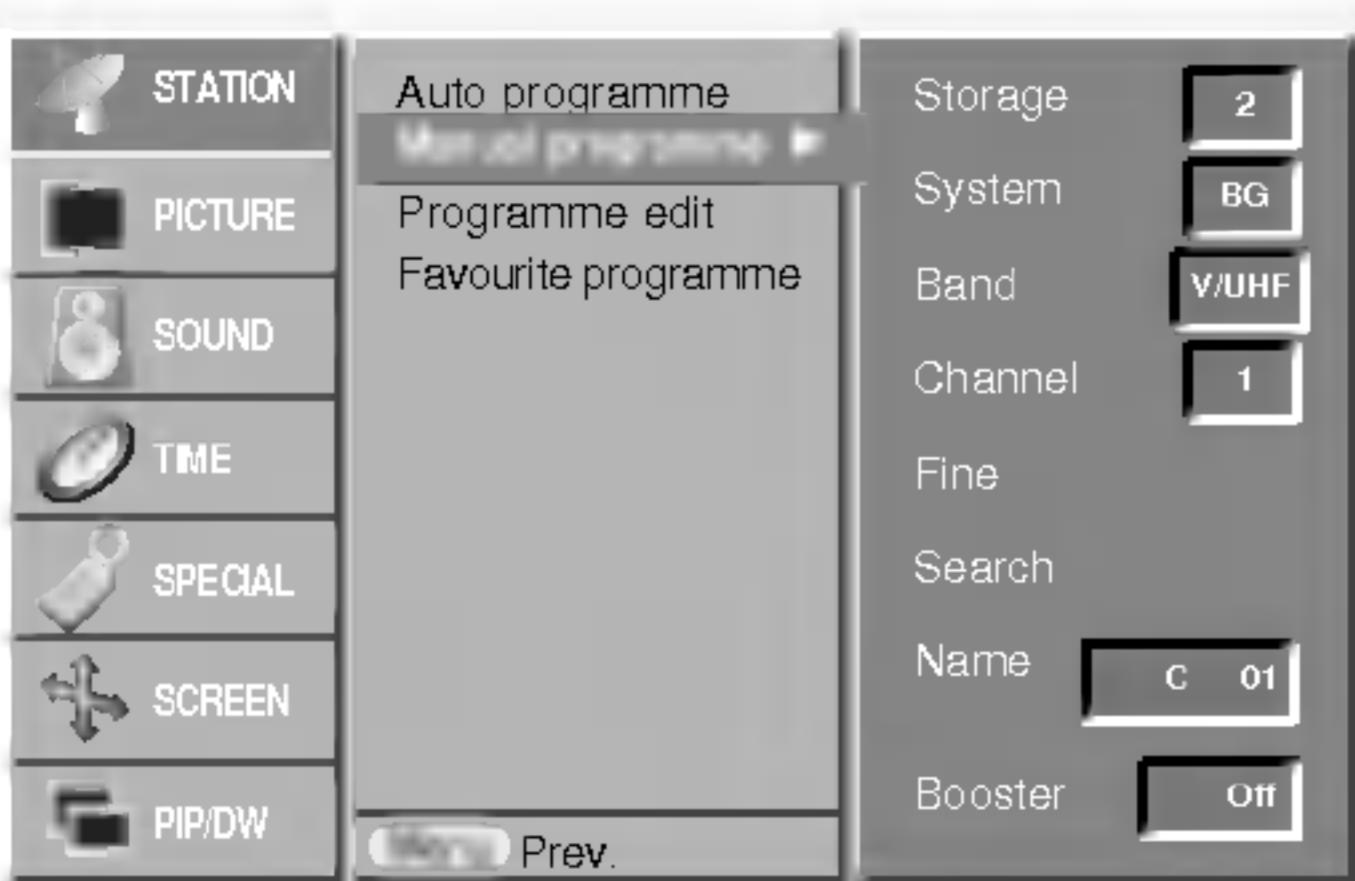

3. Press the **▶** button to select **Storage**. Select the desired programme number with the **◀ / ▶** button or NUMBER buttons on the **Storage** menu.
4. Press the **▼** button to select **System**. Select a TV system with the **◀ / ▶** button;
 - L** : SECAM L/L' (option)
 - BG** : PAL B/G, SECAM B/G (Europe / East Europe / Asia / New Zealand / M.East / Africa /Australia)
 - I** : PAL I/II (U.K. / Ireland / Hong Kong / South Africa)
 - DK** : PAL D/K, SECAM D/K (East Europe / China / Africa / CIS)
 - M** : (USA / Korea / Philippines) (option)
5. Press the **▼** button to select **Band**. Press the **◀ / ▶** button to select **V/UHF** or **Cable** as required.
6. Press the **▼** button to select **Channel**. You can select the desired channel number with the **◀ / ▶** button or NUMBER buttons. If possible, select the channel number directly with the number buttons.
7. Press the **▼** button to select **Search**. Press the **◀ / ▶** button to commence searching. If a station is found the search will stop.
8. Press the **OK** button to store it.
9. To store another station, repeat steps 3 to 8.

Fine Tuning

- Normally fine tuning is only necessary if reception is poor.

1. Repeat the 'Manual programme tuning' steps 1 to 2.
2. Press the **▶** button and then **▲ / ▼** button to select **Fine**.
3. Press the **◀ / ▶** button to fine tune for the best picture and sound.

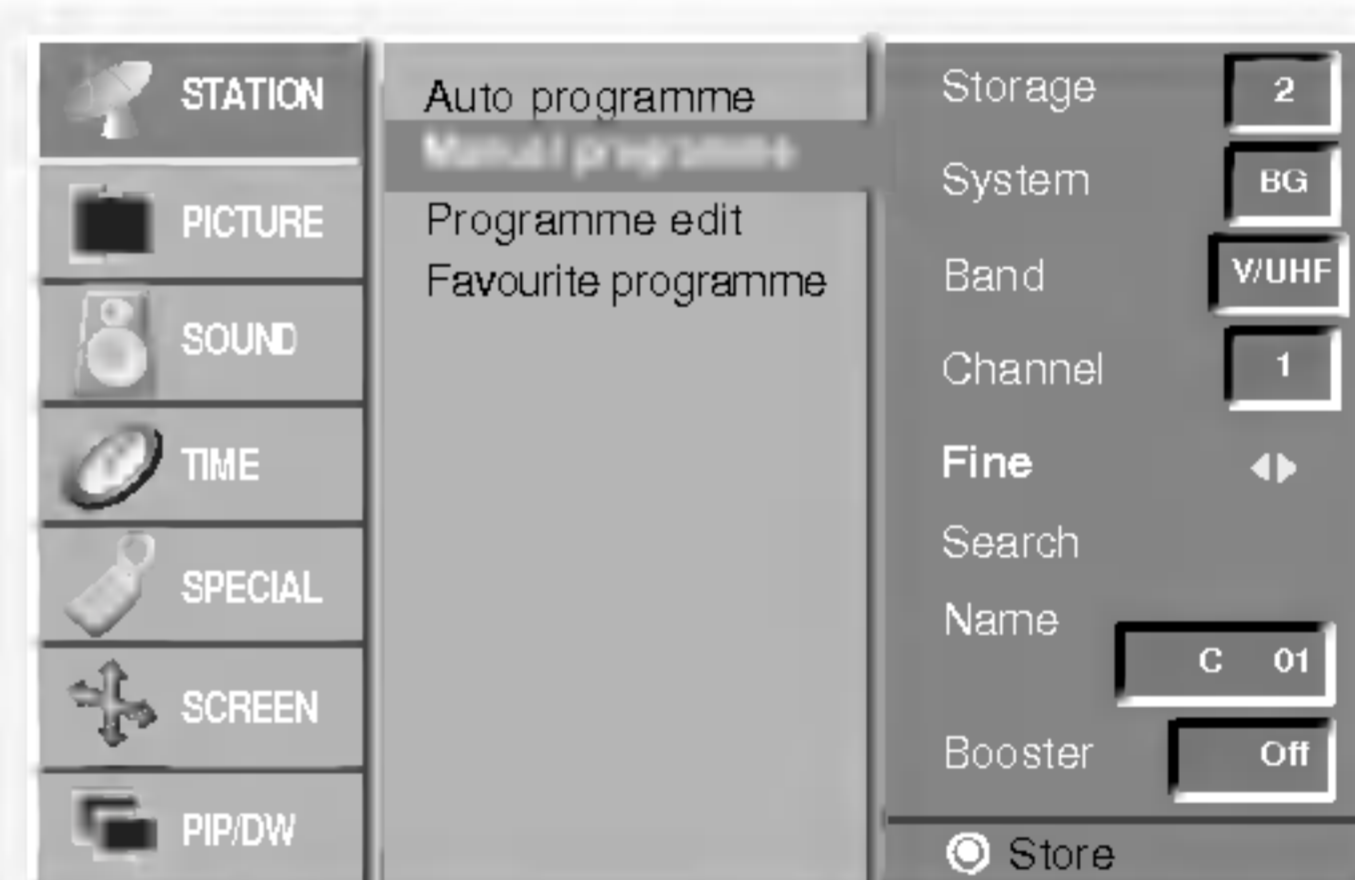

4. Press the **OK** button. The finely tuned programme will be indicated by yellow number during programme selection.
5. Press the **EXIT** button to return to normal TV viewing.

Channel Menu Options

Assigning a Station Name

1. Repeat the 'Manual programme tuning' steps 1 to 2.
2. Press the ► button and then ▲ / ▼ button to select **Name**.
3. Press the ► button to display the **Name** menu.

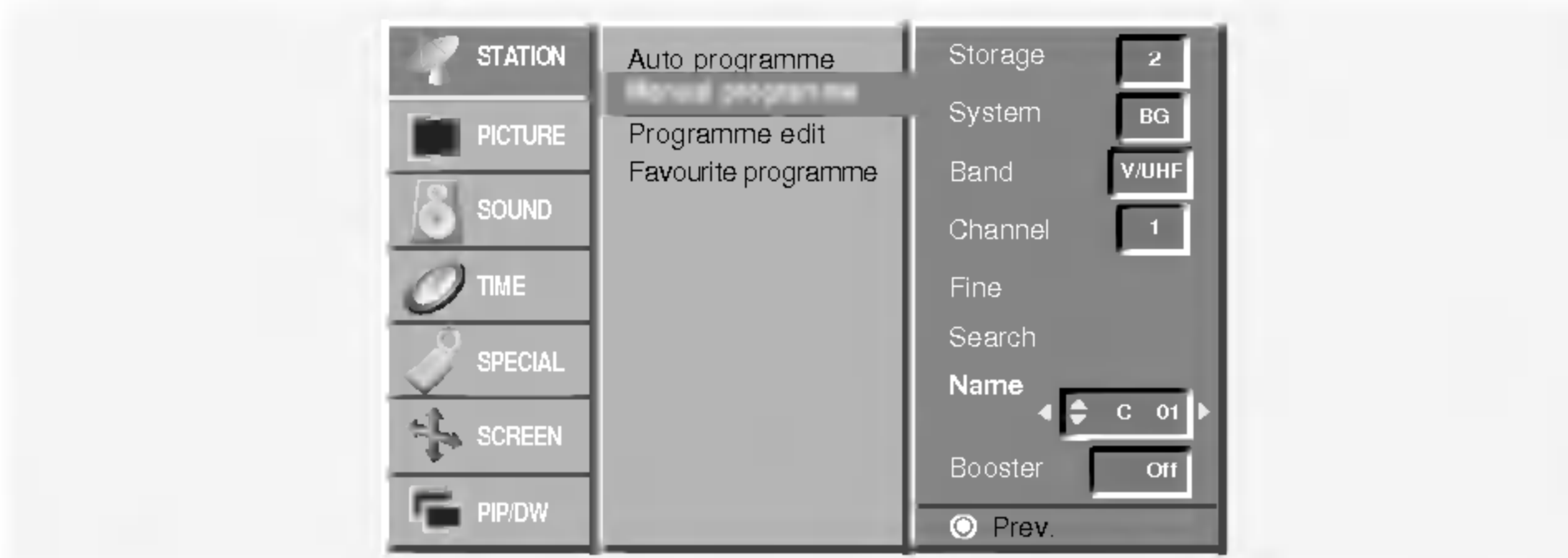

4. Press the ▲ button. You can use a blank, +, -, the alphabet **A** to **Z** and the numeric **0** to **9**.
With the ▼ button you can select in the opposite direction.
5. Select the next position by pressing the ► button and then take your choice of the second character, and so on.
6. Press the **OK** button in twice.
7. Press the **EXIT** button to return to normal TV viewing.

Booster (option)

In some models, **Booster** is an optional function. Only a set with **Booster** can perform this function.
If the reception is poor at the fringe area of TV signal, select **Booster** to **On**.

1. Repeat the 'Manual programme tuning' steps 1 to 2.
2. Press the ► button and then ▲ / ▼ button to select **Booster**.
3. Press the ◀ / ▶ button to select **On** or **Off**.
4. Press the **OK** button.
5. Press the **EXIT** button to return to normal TV viewing.

Programme Edit

- This function enables you to delete or skip the stored programmes. Also you can move some stations to other programme numbers or copy a blank station data into the selected programme number.

1. Press the **MENU** button and then use ▲ / ▼ button to select the **STATION** menu.

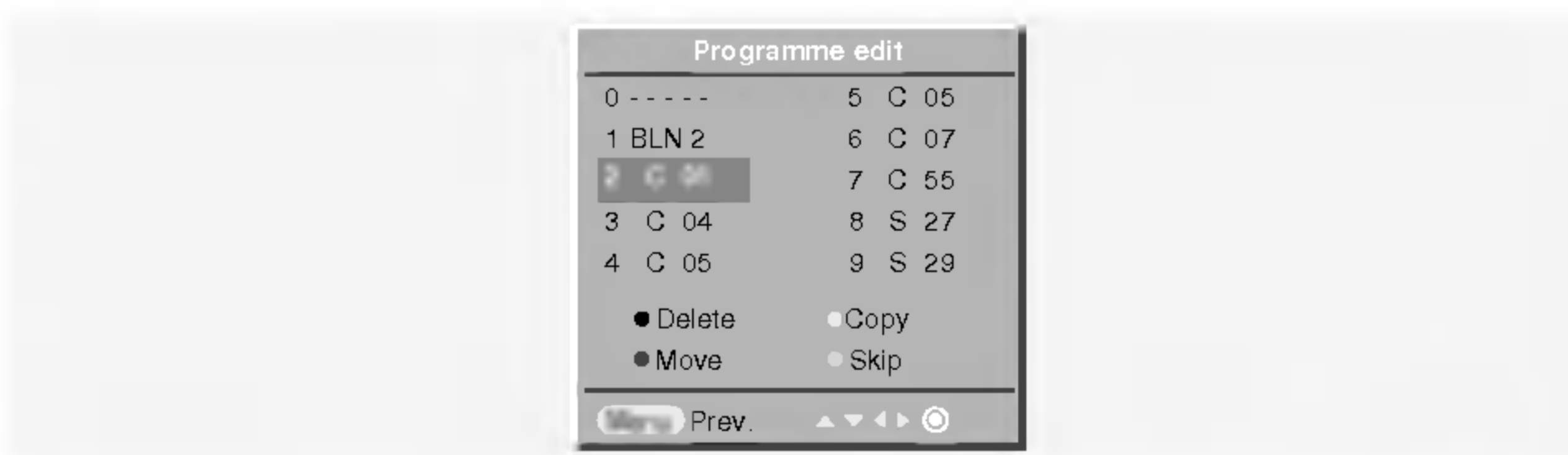

2. Press the ► button and then ▲ / ▼ button to select **Programme edit**.
3. Press the ► button to display the **Programme edit** menu.

Deleting a programme

1. Select a programme to be deleted with the ▲ / ▼ or ◀ / ▶ button.
2. Press the **RED** button twice.
The selected programme is deleted, all the following programmes are shifted up one position.

Copying a programme

1. Select a programme to be copied with the ▲ / ▼ or ◀ / ▶ button.
2. Press the **GREEN** button.
All the following programmes are shifted down one position.

Moving a programme

1. Select a programme to be moved with the ▲ / ▼ or ◀ / ▶ button.
2. Press the **YELLOW** button.
3. Move the programme to the desired programme number with the ▲ / ▼ or ◀ / ▶ button.
4. Press the **YELLOW** button again to release this function.

Skipping a programme number

1. Select a programme number to be skipped with the ▲ / ▼ or ◀ / ▶ button.
2. Press the **BLUE** button. The skipped programme turns to blue.
3. Press the **BLUE** button again to release the skipped programme.

When a programme number is skipped it means that you will be unable to select it using the **PR** ▲ / ▼ button during normal TV viewing. If you want to select the skipped programme, directly enter the programme number with the **NUMBER** buttons or select it in the programme edit or table menu.

Favourite Programme

- This function lets you select your favourite programmes directly.

1. Press the **MENU** button and then use ▲ / ▼ button to select the **STATION** menu.
2. Press the ► button and then ▲ / ▼ button to select **Favourite programme**.
3. Press the ► button to display the **Favourite programme** menu.
4. Press the ▲ / ▼ button to select -- -----.
5. Select a desired programme with the ◀ / ▶ button or **NUMBER** buttons. Any number under 10 is entered with a numeric '0' (or '00') in front of it, i.e. '05' (or '005') for 5.
6. To store another programme, repeat steps 4 to 5.
You can store up to 8 programmes.
7. Press the **OK** button.
8. Press the **EXIT** button to return to normal TV viewing.

Repeatedly press the **FAV** button to select stored favourite programmes.

Calling up the Programme Table

- You can check the programmes stored in the memory by displaying the programme table.

Displaying programme table

Press the **LIST** button to display the Programme table menu.
The programme table appears on the screen.

- You may find some blue highlighted programmes shown. They have been set up in the programme edit mode.
- Some programmes with the channel number shown in the programme table indicate there is no station name assigned.

Selecting a programme in the programme table

Select a programme with the ▲ / ▼ or ◀ / ▶ button.
Then press the **OK** button.

The Plasma Display switches to the chosen programme number.

Paging through a programme table

There are 10 programme table pages in which contain 100 programmes.

Pressing the ▲ / ▼ or ◀ / ▶ button repeatedly turns the pages.

Press the **LIST** button to return to normal TV viewing.

Picture Menu Options

PSM (Picture Status Memory)

- This function adjusts the set to the best picture appearance.
- When adjusting picture options (contrast, brightness, colour, sharpness and tint (NTSC input only)) manually, PSM is automatically changed to **User**.

1. Press the **PSM** button
- Each press of the **PSM** button changes the screen display as shown below.

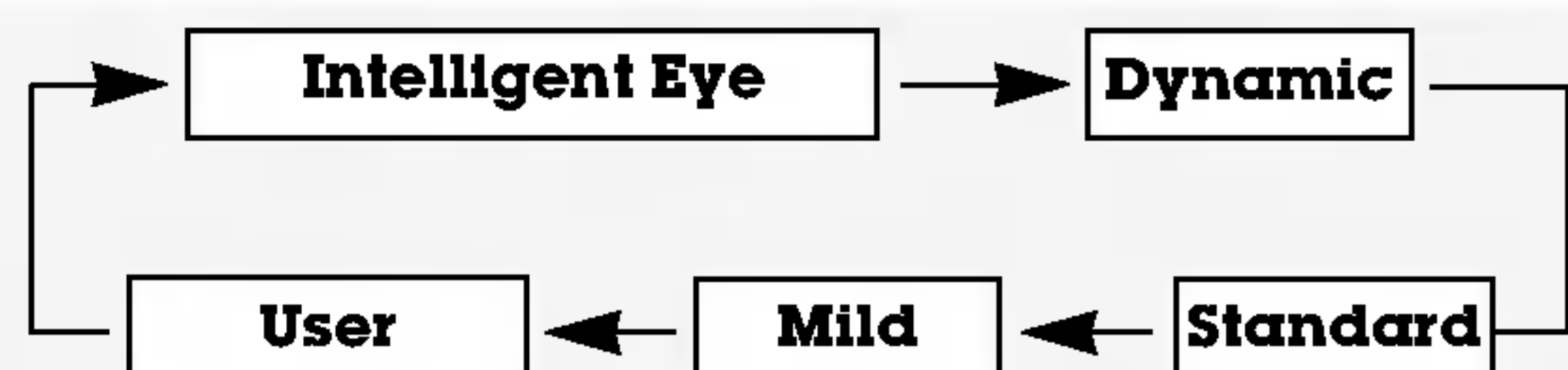

- You can also select **Intelligent Eye**, **Dynamic**, **Standard**, **Mild** or **User** in the PICTURE menu.
- Picture options **Intelligent Eye**, **Dynamic**, **Standard** and **Mild** are preset and programmed for good picture quality at the factory and cannot be changed.
- When the Intelligent eye function is on, the most suitable picture is automatically adjusted according to the surrounding conditions.

CSM (Colour Status Memory)

- To initialize values (reset to default settings), select the **Normal** option.



Manual Colour Temperature Control

- You can adjust red, green, or blue to any colour temperature you prefer.

XD

- You can enjoy the vivid and hi-definition picture with LG's Excellent Digital Reality processor technology.
- This function is not available for use in RGB[PC], HDMI[PC] mode.
- When selecting picture options (**Intelligent Eye**, **Dynamic**, **Standard** and **Mild**) in PICTURE menu, **XD** is automatically changed to **On**.

sRGB

- When the set is connected to external equipment with the sRGB function, the colour difference is adjusted the equal image of each other.
- This function works in the following mode : RGB[PC], HDMI[PC].

ACM (Active Colour Management)

- Adjust the **ACM** to select the desired skin colour option.
- This function works in the following mode: TV, AV1, AV2, S-Video2, AV3, AV4, AV5 or COMPONENT, RGB[DTV], HDMI[DTV].
- It's not available to use this function in **XD Off** mode.

Manual Picture Control

- You can adjust picture contrast, brightness, colour, sharpness and tint (NTSC input only) to the levels you prefer.
- It's not available to use colour, sharpness function in RGB[PC], HDMI[PC] mode.
- In the broadcasting system PAL/SECAM, the picture item Tint doesn't work.

Sound Menu Options

SSM (Sound Status Memory)

- This function lets you enjoy the best sound without any special adjustment because the set automatically selects the appropriate sound option based on the program content.
- When adjusting sound options (treble and bass) manually, SSM is automatically changed to **User**.

1. Press the **SSM** button.
2. Press the **SSM** button to select your desired sound.



- **SRS** is a trademark of SRS Labs, Inc.
- TruSurround XT technology is incorporated under license from SRS Labs, Inc.

BBE

- BBE High Definition Sound restores clarity and presence for better speech intelligibility and musical realism.

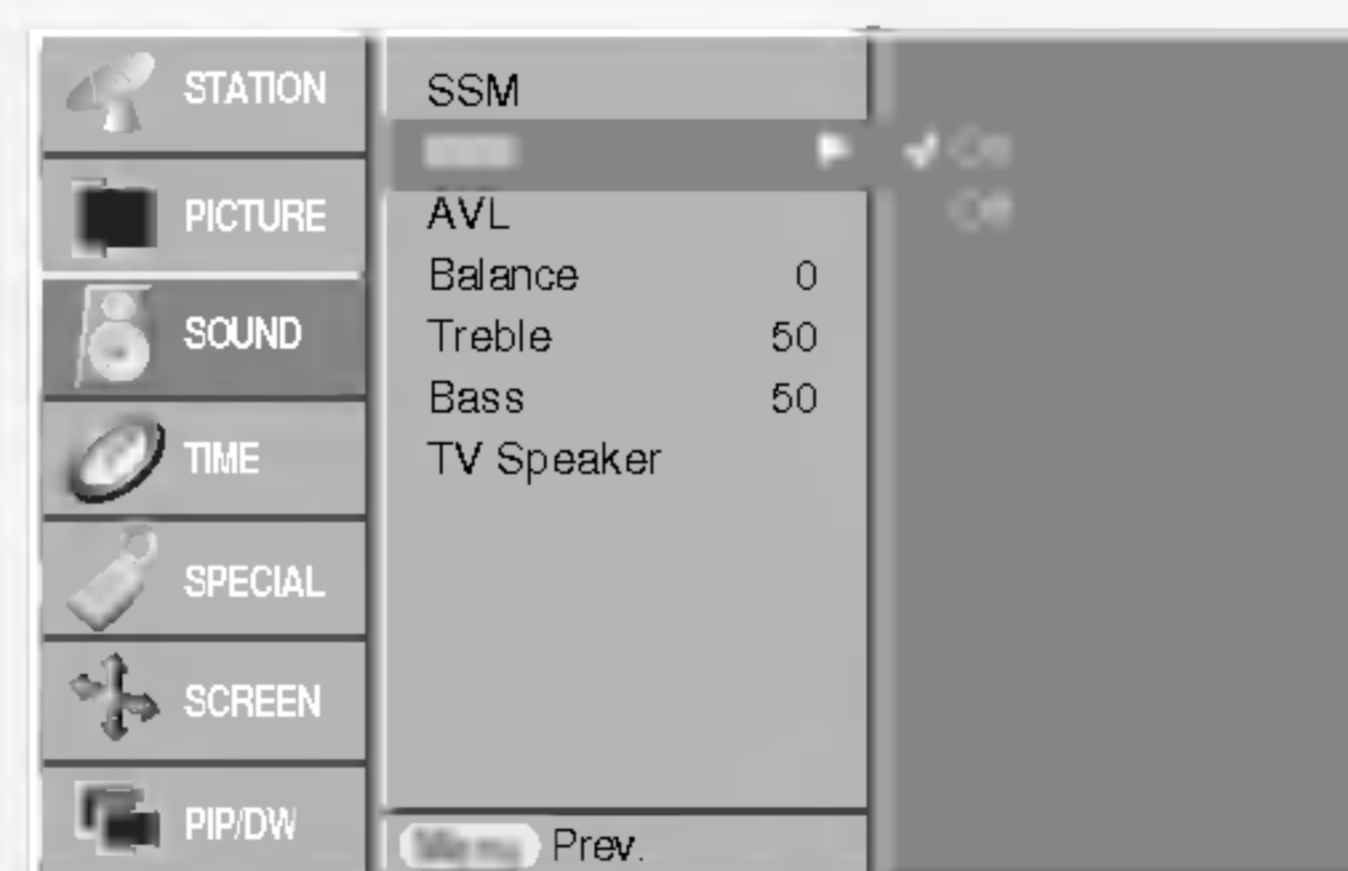

BBE. Manufactured under license from BBE Sound, Inc.

AVL (Auto Volume Leveler)

- This feature maintains an equal volume level; even if you change channels.

Adjusting Sound Control

Note : Treble, Bass or BBE aren't suitable for use with **SRS TSXT**.

Sound Menu Options

TV Speaker

- You can adjust the internal speaker status.
- In COMPONENT RGB[PC] and HDMI[PC] mode, TV speaker and/or variable audio can be outputted even though there is no video signal.
- If you want to use your external hi-fi stereo system, turn off the internal speakers of the set.

Stereo / Dual Reception

- When a programme is selected, the sound information for the station appears after the programme number and station name disappear.

On Screen Display

Press the I/II button to received broadcast state.

Broadcast	On screen Display
Mono	MONO
Stereo	STEREO
Dual	DUAL I

Mono Sound Selection

In stereo reception if the stereo signal is weak, you can switch to mono by pressing the I/II button twice. In mono reception the depth of sound is improved. To switch back to stereo, press the I/II button twice again.

Language Selection for Dual Language Broadcast

If a programme received in two languages (dual language), you can switch to **DUAL I**, **DUAL II** or **DUAL I + II** by pressing the I/II button repeatedly.

- **DUAL I** sends the primary broadcast language to the loudspeakers.
- **DUAL II** sends the secondary broadcast language to the loudspeakers.

- **DUAL I + II** sends a separate language to each loudspeaker.

NICAM Reception (option)

- If your Plasma Display is equipped with the PDP Tuner for NICAM reception, the high quality NICAM (Near Instantaneous Companding Audio Multiplex) digital sound can be received.

Sound output can be selected according to the type of received broadcast as follows by pressing the I/II button repeatedly.

- When NICAM mono is received, you can select **NICAM MONO** or FM MONO.
- When NICAM stereo is received, you can select **NICAM STEREO** or FM MONO. If the stereo signal is weak, switch to FM mono.
- When NICAM dual is received, you can select **NICAM DUAL I**, **NICAM DUAL II**, **NICAM DUAL I + II**, or **MONO**. When FM mono is selected the display **MONO** appears on the screen.

Sound output selection

In AV, Component, RGB or HDMI mode, you can select output sound for the left and right loudspeakers.

Repeatedly press the I/II button to select the sound output.

- **L+R** : Audio signal from audio L input is sent to left loud-speaker and audio signal from audio R input is sent to right loud-speaker.
- **L+L** : Audio signal from audio L input is sent to left and right loud-speakers.
- **R+R** : Audio signal from audio R input is sent to left and right loud-speakers.

Time Menu Options

Setting the Clock

- If current time setting is erased by a power failure or the set is unplugged, reset the clock.

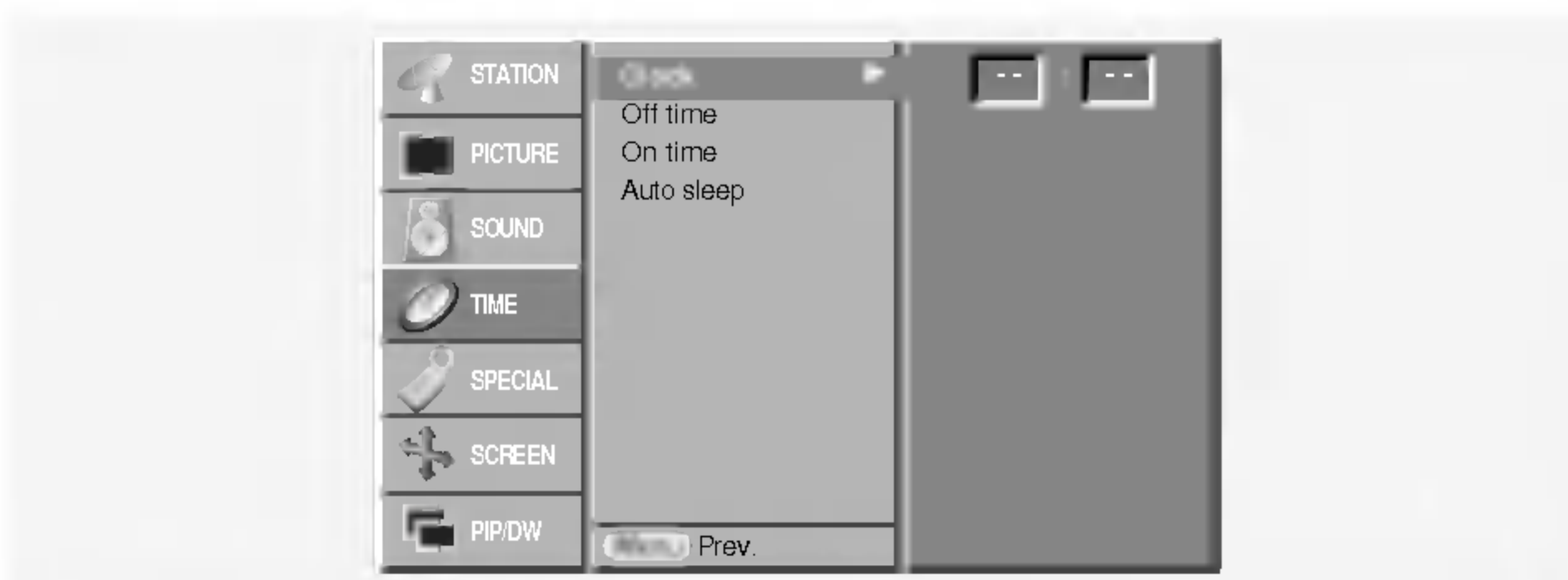

Setting the On/Off Timer

- Timer function operates only if current time has been already set.
- Off Timer function overrides on Timer function if they are set to the same time.
- The set must be in standby mode for the On Timer to work.
- Two hours after the set is switched on by the on time function it will automatically switch back to standby mode unless a button has been pressed.

Auto Sleep

- If there is no input signal, the monitor turn off automatically after 10 minutes.

Sleep Timer

- Sleep timer turns the set off at the preset time.
 - Press the **SLEEP** button to select the number of minutes. The display **Min** will appear on the screen, followed by **10, 20, 30, 60, 90, 120, 180** and **240** minutes. The timer begins to count down from the number of minutes selected.
- To check the remaining sleep time, press the **SLEEP** button once.
 - To cancel the sleep time, repeatedly press the **SLEEP** button until the display **Min** appears.
 - If you turn the set off after setting the sleep timer, the setting will be erased.

Special Menu Options

Child Lock

- The set can be set up so that it can only be used with the remote control.
- This set is programmed to remember which option it was last set to even if you turn the set off.
- In **Child lock 'On'**, if the set is turned off, press the **INPUT**, **PR ▲ / ▼** button on the set or **POWER**, **INPUT**, **MULTIMEDIA**, **PR ▲ / ▼** or **NUMBER** buttons on the remote control.
- With the **Child lock On**, the display '  **Child lock on**' appears on the screen if any button on the front panel is pressed while viewing the set.

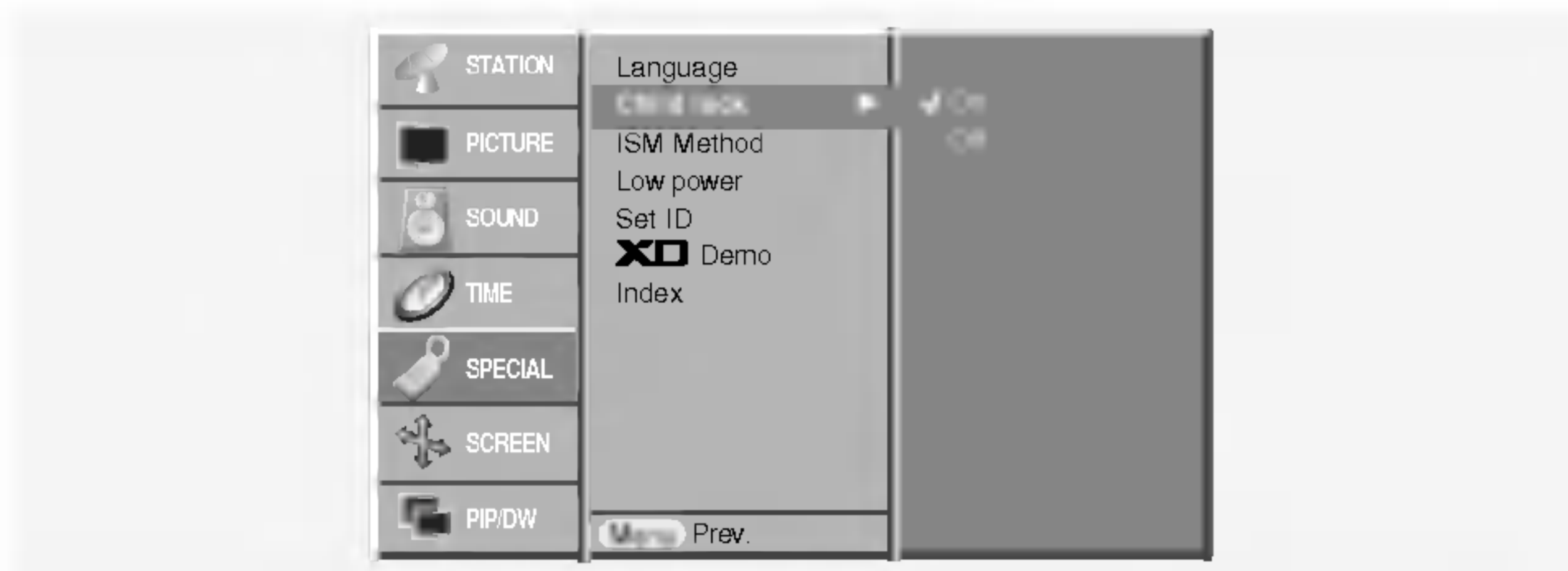

ISM (Image Sticking Minimization) Method

- A frozen or still picture from a PC/video game displayed on the screen for prolonged periods will result in a ghost image remaining even when you change the image. Avoid allowing a fixed image to remain on the set's screen for a long period of time.

• White Wash :

White Wash removes permanent images from the screen.

Note: An excessive permanent image may be impossible to clear entirely with White Wash.

• Orbiter :

Orbiter may help prevent ghost images. However, it is best not to allow any fixed image to remain on the screen. To avoid a permanent image on the screen, the screen will move every 2 minutes.

• Inversion :

This is the function to invert the panel colour of the screen.

The panel colour is automatically inverted every 30 minutes.

Low Power

- This is the function to reduce the power consumption of the set.

XD Demo

- Use it to see the difference between XD demo on and XD Demo off.
- It's not available to use this function in RGB[PC], HDMI[PC] mode.

Index

- You can switch FONT DISPLAY on or off.

Screen Menu Options

Auto Configure

- Automatically adjusts picture position and minimizes image shaking.
- This function works in the following mode : RGB[PC].
 - When **Auto config.** has finished, **OK** will be shown on screen.
 - If the position of the image is still not correct, try Auto adjustment again.
- If picture needs to be adjusted more after Auto adjustment in RGB (PC), you can adjust the **Manual Config.**
- Although the image is still not correct, your set is functioning properly but needs further adjustment.
- The **Auto config.** functions don't need to be run for HDMI mode.

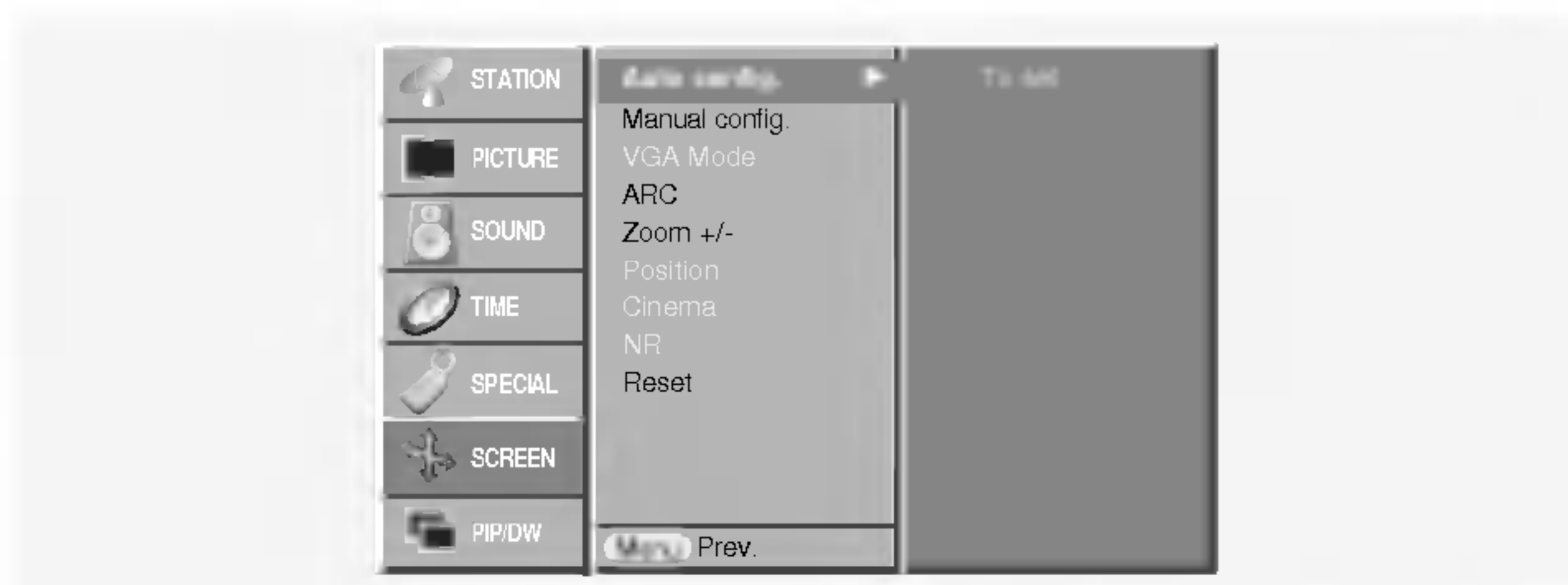

Manual Configure

- If the picture isn't clear after auto adjustment and especially if characters are still trembling, adjust the picture phase manually.
- To correct the screen size, adjust **Clock**.
- This function works in the following mode : RGB[PC], RGB[DTV], COMPONENT (480p/576p/720p/1080i), HDMI (480p/576p/720p/1080i).
- It's not available to use Phase, Clock function in RGB[DTV], COMPONENT (480p/576p/720p/1080i), HDMI (480p/576p/720p/1080i) mode.

Selecting Wide VGA/XGA mode

- To see a normal picture, match the resolution of RGB mode and selection of VGA/XGA mode.
- In some models, it's not available to selection of XGA mode.
- This function works in the following mode : RGB[PC].

Screen Menu Options

Setting the Picture Format

- You can watch the screen in various picture formats; **Spectacle**, **Full** (option), **Original**, **4:3**, **16:9** (Wide), **14:9** and **Zoom**.

- **Spectacle**

When your TV receives the wide screen signal, when selected it will adjust the picture horizontally, in non-linear proportion, to fill the entire screen.

- **Full** (option)

When your TV receives the wide screen signal, when selected it will adjust the picture horizontally or vertically, in a linear proportion, to fill the entire screen fully.

- **Original**

When your TV receives the wide screen signal, it will be automatically changed to the picture format to be sent.

- **4:3**

Following selection will lead you to view a picture with an original 4:3 aspect ratio, with gray bars appearing at both the left and right sides.

- **16:9** (Wide)

Following selection will lead you to adjust the picture horizontally, in a linear proportion, to fill the entire screen (useful for viewing 4:3 formatted DVDs).

- **14:9**

You can enjoy the picture format of 14:9 or general TV programme through the 14:9 mode. The screen 14:9 is viewed just like that the screen 4:3 is magnified to the left / right.

- **Zoom**

Following selection will lead you to view the picture without any alternation, while filling the entire screen. However, the top and bottom portions of the picture will be cropped.

- You can only select **4:3** and **16:9** (Wide) in RGB[PC], HDMI[PC] mode only.
- You can only select **4:3**, **16:9** (Wide) and **Zoom** in RGB[DTV], HDMI[DTV], Component [DTV] mode only.

- You can only select **Spectacle**, **Full** (Option), **4:3**, **16:9** (Wide), **14:9** and **Zoom** in Component [480i/576i] mode only.
- There might be uncomfortable in full mode. Then change into other mode.

Picture Size Zoom

- When enlarging or reducing the picture, the screen may be display an unnatural looking picture.

Screen Position

- This function is available after adjusting Zoom +/-.

Cinema

- When you watch the movie, this function adjusts the set to the best picture appearance.
- This function works in the following mode:
TV, AV1, AV2, S-Video2, AV3, AV4, AV5 or COMPONENT (480i/576i).

NR (Noise Reduction)

- You can select **3D NR** or **MPEG NR** to reduce the picture noise which may appear on the screen during watching the TV.
- This function is not available for use in RGB[PC], HDMI[PC] mode.
- 3D NR is not available for use in RGB, HDMI, Component[DTV] mode.

Initializing (Reset to original factory settings)

This function operates in current mode.

To initialize the adjusted value

- You can initialize Phase, Clock, H-Position, V-Position, Position, Zoom +/-, PIP size, PIP position, PIP Transparency and sub picture size of twin picture.

Teletext (option)

- Teletext (or TOP text) is an optional function, therefore only the set with the teletext system can receive the teletext broadcast.
- Teletext is a free service broadcast by most TV stations which gives up-to-the-minute information on news, weather, television programmes, share prices and many other topics.
- The teletext decoder of this set can support the SIMPLE, TOP and FASTEXT systems. SIMPLE (standard teletext) consists of a number of pages which are selected by directly entering the corresponding page number. TOP and FASTEXT are more modern methods allowing quick and easy selection of teletext information.

Teletext Language Selection

1. Press the **MENU** button and then use **▲** / **▼** button to select the SPECIAL menu.
2. Press the **▶** button and then use **▲** / **▼** button to select **Language**.
3. Press the **▶** button and then use **◀** / **▶** button to select **Teletext Language**.
4. Press the **▲** / **▼** button to select the required language.
5. Repeatedly press the **MENU** button to return to normal TV viewing.

Note :

- a. Please select your local teletext language.
- b. If you don't, the teletext may not appear correctly on the screen.

Switch on/off

Press the **TEXT** button to switch to teletext.

- The initial page or last page appears on the screen.
Two page numbers, TV station name, date and time are displayed on the screen
headline. The first page number indicates your selection, while the second shows the current page displayed.

Press the **TEXT** button to switch off teletext.

Teletext (option)

SIMPLE Text (option)

Page selection

1. Enter the desired page number as a three digit number with the NUMBER buttons. If during selection you press a wrong number, you must complete the three digit number and then reenter the correct page number.
2. The **PR ▲ / ▼** button can also be used to select the preceding or following page.

Programming a colour button in LIST mode

If the TV is in SIMPLE text, TOP text or FASTEXT mode, press the  button to switch to LIST mode.

Four teletext page numbers of your choice can be colour coded and easily selected by pressing the corresponding coloured button on the remote control handset.

1. Press a coloured button.
2. Using the NUMBER buttons, select the page you wish to programme.
3. Press the **OK** button. The selected page is stored as the selected page number, blinking once to confirm this. From now on, you can select this page with the same coloured button.
4. The three other coloured buttons are programmed in this way.

TOP Text (option)

The user guide displays four fields-red, green, yellow and blue at the bottom of the screen. The yellow field denotes the next group and the blue field indicates the next block.

Block / group / page selection

1. With the blue button you can progress from block to block.
2. Use the yellow button to proceed to the next group with automatic overflow to the next block.
3. With the green button you can proceed to the next existing page with automatic overflow to the next group. (Alternatively the **PR ▲** button can be used.)
4. The red button permits to return to previous selection. (Alternatively the **PR ▼** button can be used.)

Direct page selection

Corresponding to the SIMPLE text mode, you can select a page by entering it as a three digit number using the NUMBER buttons in TOP mode.

FASTEXT

The teletext pages are colour coded along the bottom of the screen and are selected by pressing the corresponding coloured button.

Page selection

1. Press the  button to select the index page.
2. You can select the pages which are colour coded along the bottom line with the same coloured buttons.
3. Corresponding to the SIMPLE text mode, you can select a page by entering its three digit page number with the NUMBER buttons in FASTEXT mode.
4. The **PR ▲ / ▼** button can also be used to select the preceding or following page.

Special Teletext Functions

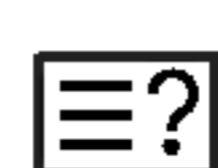

REVEAL

Press this button to display concealed information, such as solutions of riddles or puzzles.

Press this button again to remove the information from the display.



SIZE

Selects double height text.

Press this button to enlarge the top half of the page.

Press this button again to enlarge the bottom half of the page.

Press this button again to return to the normal display.



UPDATE

Displays the TV picture on the screen while waiting for the new teletext page.

Press this button to view the updated teletext page.



HOLD

Stops the automatic page change which will occur if a teletext page consists of 2 or more sub pages. The number of sub pages and the sub page displayed is, usually, shown on the screen below the time. When this button is pressed the stop symbol is displayed at the top left-hand corner of the screen and the automatic page change is inhibited.

To continue press this button again.



MIX

Displays the teletext pages superimposed on the TV picture.

To switch the TV picture off press this button again.



TIME

This button has two functions:

a) When viewing a TV programme, press this button to display the time at the top right hand corner of the screen. Press this button again to remove the display.

b) In teletext mode, press this button to select a sub page number. The sub page number is displayed at the bottom of the screen. To hold or change the sub page, press the RED/ GREEN or **PR ▲ / ▼** buttons. Press this button again to exit this function.

PIP (Picture-in-Picture) Feature

- PIP lets you view 2 different inputs (sources) on your set screen at the same time.
- It's not available to use this function in TELETEXT mode.

Watching PIP

Press the **PIP** button to show the sub picture.

- Each press of **PIP** button changes the screen display as shown below.

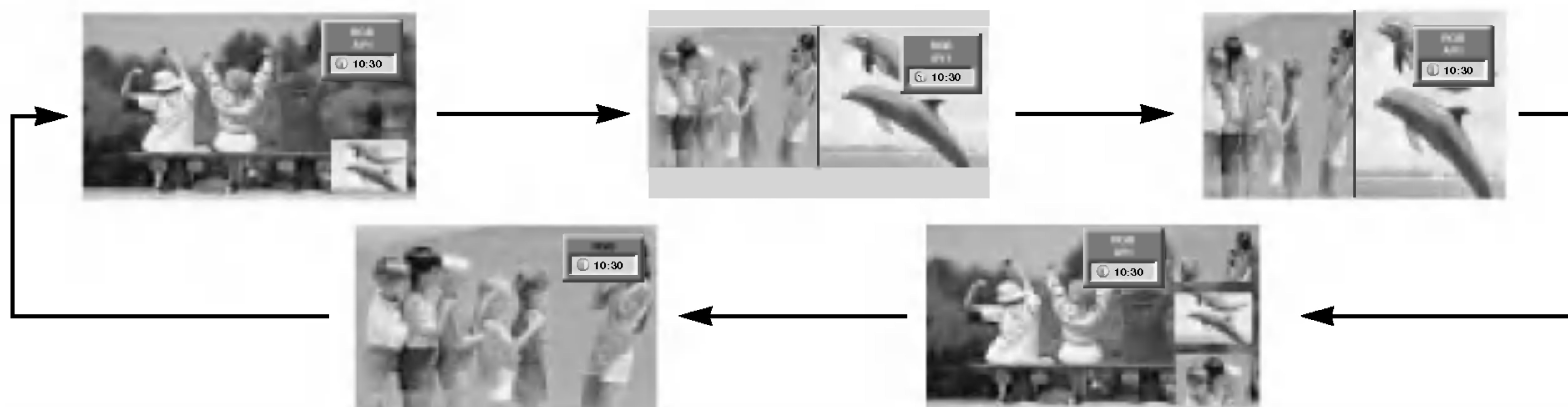

Note :

- When the sub picture size is 1/2 of the main picture, the picture quality may decrease.
- The motion of the sub picture can be unnatural because the set displays full screen by synchronizing the main picture source when the refresh rate between the main picture source and the sub picture source is different in PIP mode.

Programme Selection for Sub Picture

Press the **PIP PR +/-** button to select a programme for the sub picture.

Selecting an Input Signal Source for the PIP

Press the **PIP INPUT** button to select the input source for the sub picture.



In some models, when the sub picture quality get poor for sub picture, select Auto, PAL, SECAM or NTSC in PIP System menu.

POP (Picture-out-of-Picture: Channel Scan)

Use POP to search the programmes of all the memorized channels one-by-one on the 3 PIP screen display, (while the main picture source remains the current channel). The pictures of all the programmed channels are searched with the 3 POP screen.

Adjusting PIP Transparency (PIP mode only)

1. Press the **MENU** button and then **▲ / ▼** button to select the PIP/DW menu.
2. Press the **▶** button and then **▲ / ▼** button to select **PIP Transparency**.
3. Press the **▶** button and then **◀ / ▶** button to adjust PIP transparency.
4. Press the **EXIT** button to return to normal TV viewing.

Moving the PIP (PIP mode only)

Press the **POSITION** button. Repeatedly press the **▲ / ▼** or **◀ / ▶** button until desired position is achieved. The sub picture moves up/down or left/right.



Picture Size

Press the **SIZE** button and then **◀ / ▶** button to adjust the sub picture size.



With **SIZE** button in DW1, DW2 modes, main and sub picture is adjusted simultaneously. With **SIZE** button in PIP mode, sub picture is adjusted.

Adjusting the screen for the PIP

- In TV or AV modes for the main picture and RGB[PC] for the sub picture, you can use Auto config and Manual config to adjust the screen of the sub picture.
- In TV or AV modes for main picture and HDMI[DTV] or Component 480p, 576p, 720p, 1080i for the sub picture, you can use Manual config to adjust the screen of the sub picture.

XSTUDIO

- You can use the JPEG and MP3 file by memorizing to Memory card in **XSTUDIO** mode.

Notes on Memory Card

When removing or handling the memory card, use only your hands. Do not use other devices or the memory card may be damaged.

Memory Card

This is a device equipped to communicate the data between AV external equipment. It's used in a digital camera, camcorder, MP3 player, notebook or PDA.

Precaution for Using the Memory Card

- Please be sure to insert the correct memory card type in the right direction.
(Confirm between the two memory slots before insertion.)
- Don't insert metal substances into the slots of the memory card.
- Do not bend, drop or apply strong shock to memory card.
- After pulling the memory card out from the set, please keep the memory stick in an appropriate case to prevent it from static shock.
- The stored data may be changed or lost as a result of misuse or static electricity.
- Do not turn the power off while the memory card is in operation.
- Don't eject the memory card while in use. Otherwise, it may cause a data loss or card damage.
- Insert only one card into each slot.
- Static electricity and/or electrical noise has the potential to change or erase the stored data. Please take measures to avoid.
- This Company takes no responsibility for problems such as the damage or malfunction that occurs while using the set, inappropriate settings, or any other reasons, except for defects or malfunctions intrinsic to the product.
- Ensure to use a memory card that lists the manufacturers name and serial number.
- The manufacturer will not be responsible for any data damage. Making back up data is strongly recommended.
- Make sure to comply with the following steps when ejecting a memory card.
- Ensure each memory card has complied with standard.

Notes on Memory Card

Available Memory Card

* Check the direction of the Memory card.
(refer to the pictures below)

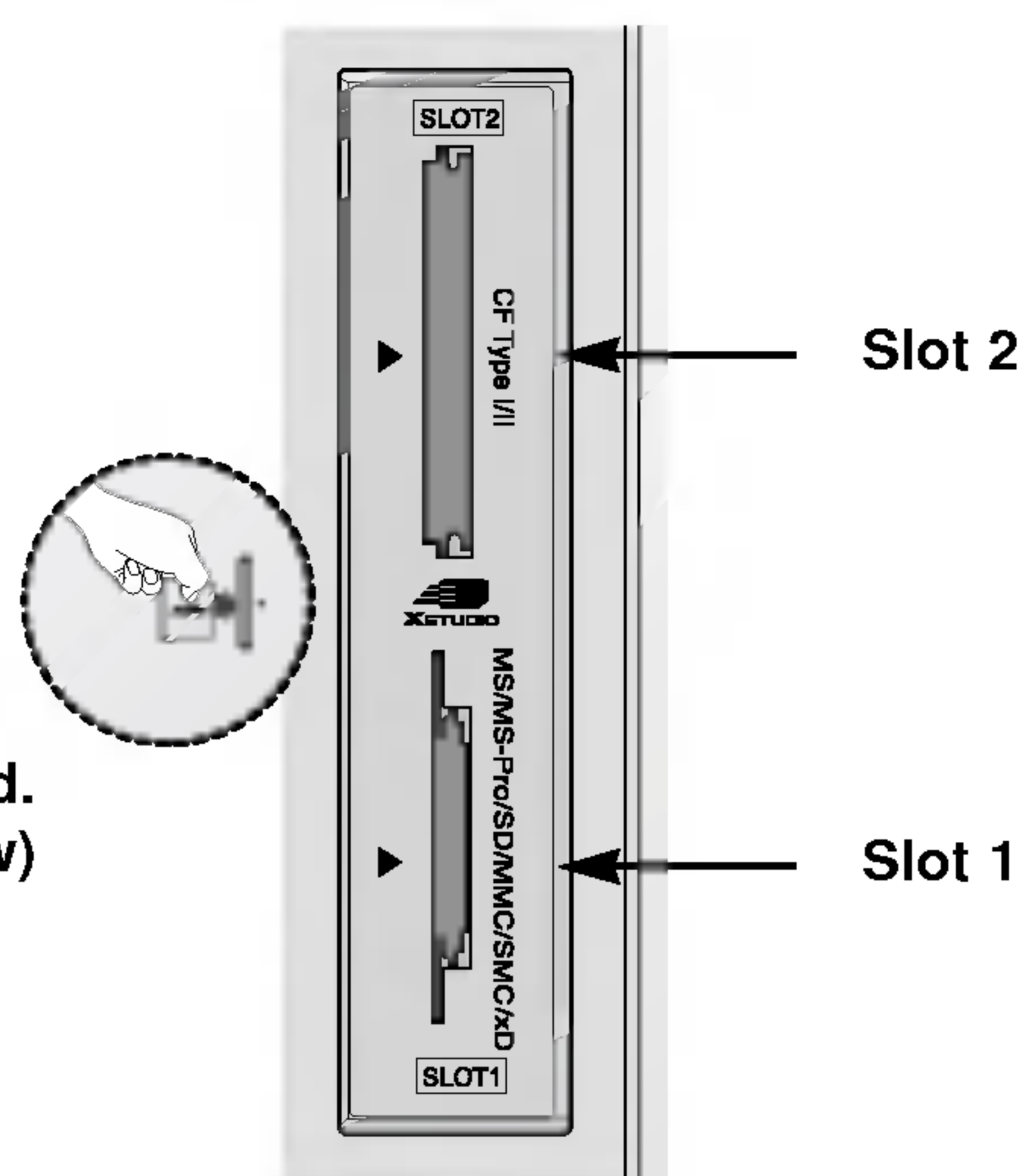

Memory Card type

- Use the specified card based on the slot location.
- 8 types of Memory Card can be used for this set.
- NTFS file system is not supported.

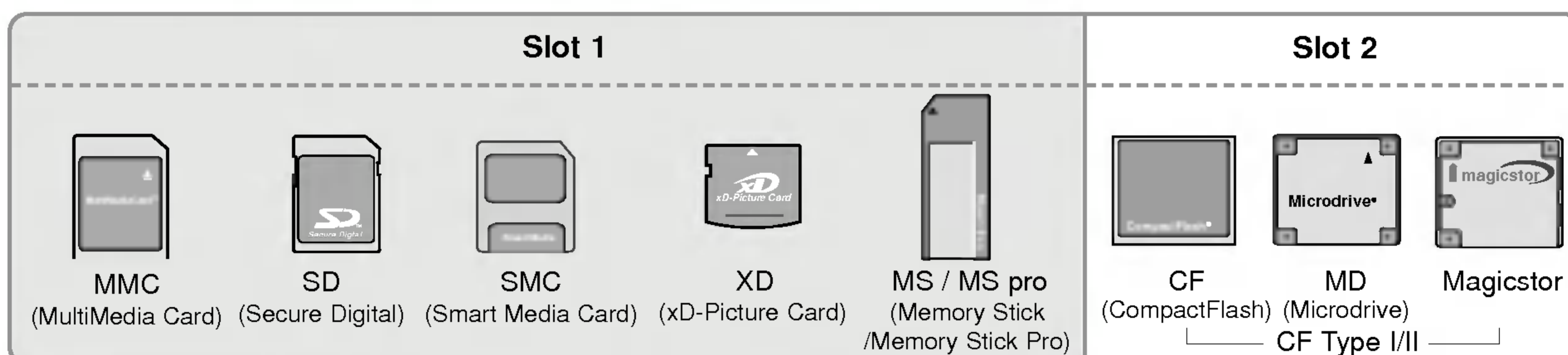





Available file in XSTUDIO mode

A sort of file	Photo Image (JPEG)	Music File (MP3)
Compatibility	*.jpg	*.mp3
Memory card capacity	CF: 2GB Microdrive: 2GB Magicstor: 2.2GB MMC: 256MB SD: 512MB - Some MagicStor Plus cards are not usable. An error may occur if you use a memory card with greater than the specified capacity.	SMC: 128MB XD: 512MB MS: 128MB MS PRO: 1GB
Unsupported or damaged file	Unsupported or damaged JPEG or MP3 files can cause errors. Do not try to change the file extension of unsupported file types to the file extension of supported file types.	

- Playback speed can vary dependent on the card type.
- You can assign 8 characters for the file name of the card. If the file name is longer than 8 characters, it will be truncated at 6 digits and "~1, 2, 3, and 4" will be appended to the 7-8th position.



The JPEG Decoding/The Image Preview Supplied Spec

	Compression Method		Colour format		
	Baseline	Progressive	4:4:4 11:11:11 (Y, Cb, Cr)	4:2:2 21:11:11 (Y, Cb, Cr) 12:11:11 (Y, Cb, Cr)	4:2:0 22:11:11 (Y, Cb, Cr)
JPEG Decoding Support	○	X	X	○	○
Image Display	Image	invalid format	invalid format	Image	Image
Preview Image Display	Display  when there is no thumbnail.			Display  when there is no thumbnail.	Display  when there is no thumbnail.

- If an error occurs when decoding the JPEG, "**Corrupted file**" is displayed on screen.

How to insert and eject the card

◆ Inserting a Card

1. Insert the card into the Slot 1 and/or Slot 2 with the hand softly and slowly.
2. Press the  button to enter the **XSTUDIO** mode.
Press the  button again to exit the **XSTUDIO** mode.

◆ Ejecting a card

1. Press the **M/C EJECT** button on the remote control.
2. Press **▲ / ▼** button to Select the **Memory 1 Eject** or **Memory 2 Eject** based on the inserted card location.
If selecting **Cancel**, OSD will disappear.
3. Carefully remove the card.

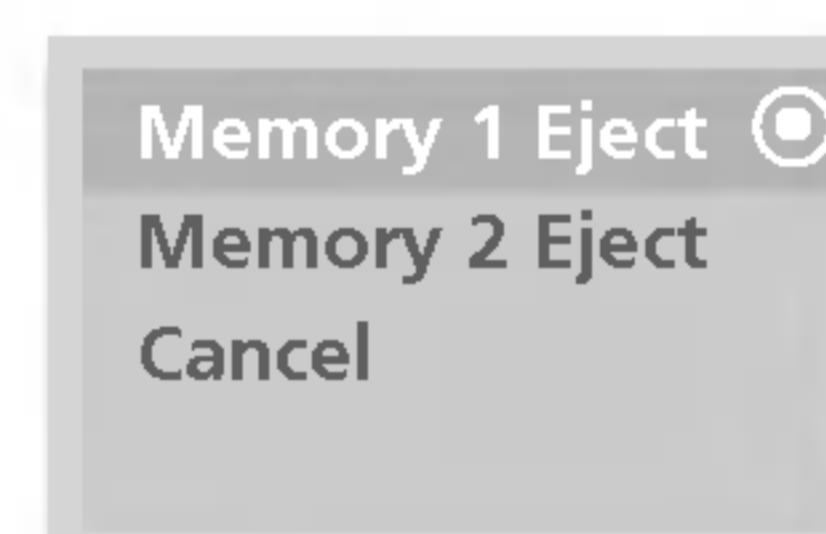

Notes:

- Screen saver will appear if you do not remove the card with the hand after operating the eject function.
- When entering the photo or music media at first, the **M/C EJECT** button will not work.
It's possible to use the **M/C EJECT** button while using the photo or music media.



Caution: Press the **M/C EJECT** button on remote control before removing the memory card. Failure to do so may damage the card.

* In this manual, the OSD (On Screen Display) may be different from your set's because it is just an example to help you with the set operation.

Select the Photo or Music Media

- When you plug a memory card or press the  button, the below screens will be displayed.



1. Press **▲ / ▼ / ◀ / ▶** button to select photo or music for slot1/2.
2. Press the **OK** button to enter the photo or music media.
3. Press the  button to exit the **XSTUDIO** mode.

Notes:

- The OSD of the ejected card slot is inactivate when ejecting the card.
- If there is any error in a memory card, it's impossible to enter **XSTUDIO** mode.

JPEG File Viewing Options

- When you select **Photo** in entry menu, you will now see a screen filled with thumbnail photo media.

* In this manual, the OSD (On Screen Display) may be different from your set's because it is just an example to help you with the set operation.

Screen Components

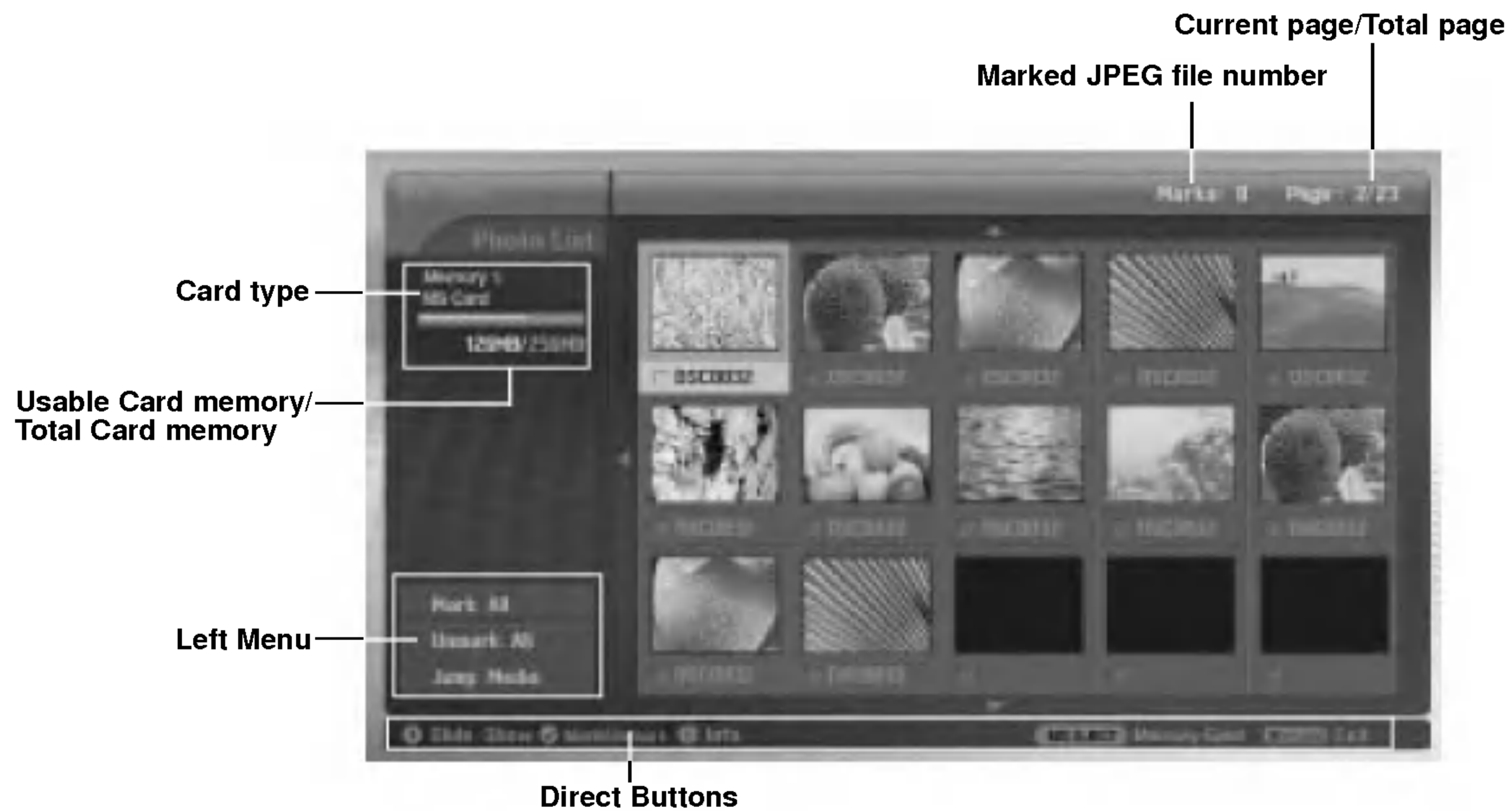

Photo Selection and PopUp menu

- Select your desired image file.



1. Insert the memory card to Slot 1 and/or Slot 2 on the set side panel.
2. Press the **Source** button.
3. Use **▲ / ▼ / ◀ / ▶** button to select photo media for slot1 or slot 2.
4. Press the **OK** button to enter the photo media.
Note: It's possible to display 15 JPEG files per page.
5. Press the **▲ / ▼ / ◀ / ▶** button to select JPEG file and then press the **OK** button.
6. Press the **▲ / ▼** button to select **View** and then press the **OK** button. The selected image will display over the entire screen.

Mark/Unmark for JPEG file

- You can mark/unmark the file to view the desired file or use slide show for desired file conveniently.
- The selected file displays orange in colour.

When pressing the **OK** button after marking a file, the marked file displays green in colour.



◆ Mark/Unmark for all files

1. In photo media, repeatedly press ◀ button to enter the menu on the left.
2. Press the ▲ / ▼ button to select **Mark All** or **Unmark All**.
 - If you select **Mark All**, every file is selected.
 - If you select **Unmark All**, the selection for every file is released.
3. Press the **OK** button and then ▶ button to return to the photo list.

◆ Mark/Unmark for some file

Press the **MARK** button repeatedly to mark or unmark some JPEG file.

Jump Media

- Use this function to jump to other media during using photo media.

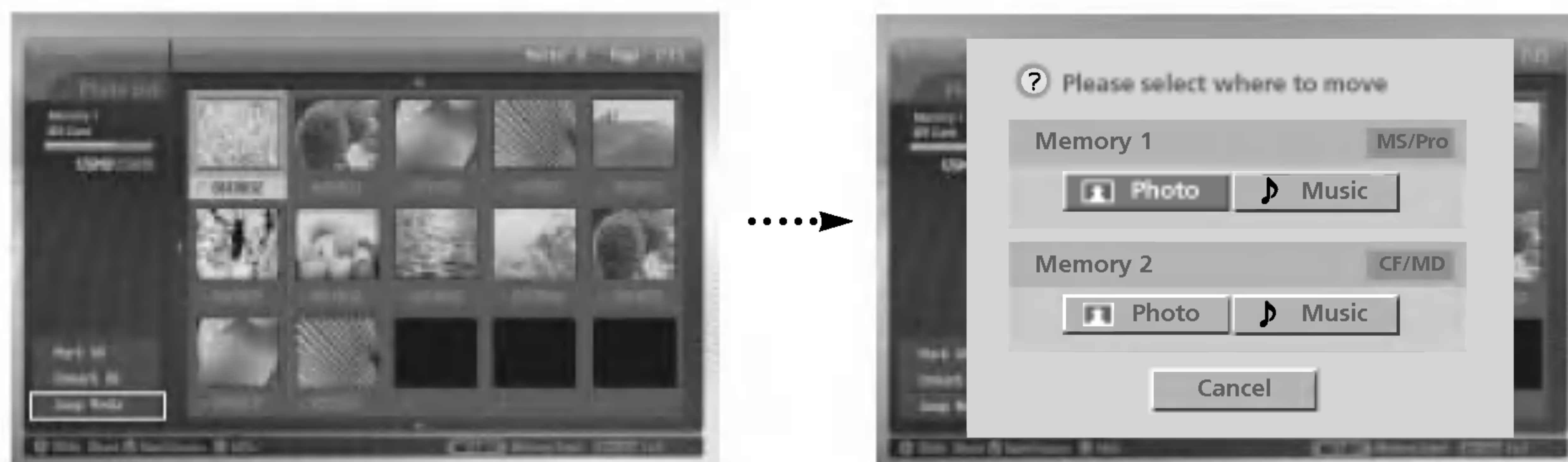

1. In photo media, press ◀ button repeatedly to enter the left menu.
2. Press the ▲ / ▼ button to select **Jump media** and then press the **OK** button.
3. Press the ▲ / ▼ / ◀ / ▶ button to select desired media and then press the **OK** button. The screen displays each media list.

JPEG File Viewing Options

The Image Adjustment

- You can display the selected image on the entire screen and do the various adjustments for the JPEG file.



1. Press the ▲ / ▼ / ◀ / ▶ button to select JPEG file and then press the **OK** button.
2. Press the ▲ / ▼ button to select **View** and then press the **OK** button. The selected image will display on entire screen.
3. Adjust the JPEG file.

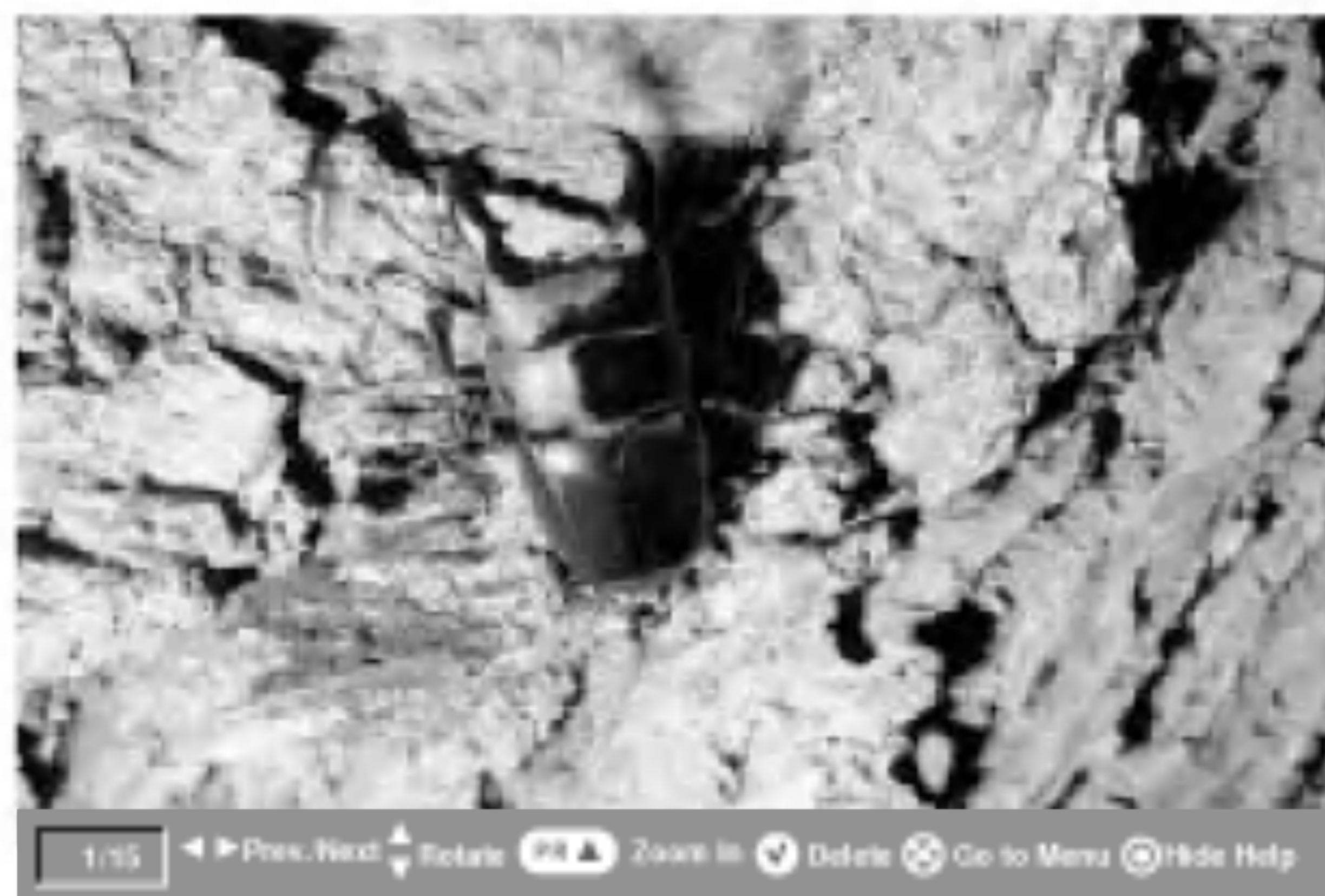
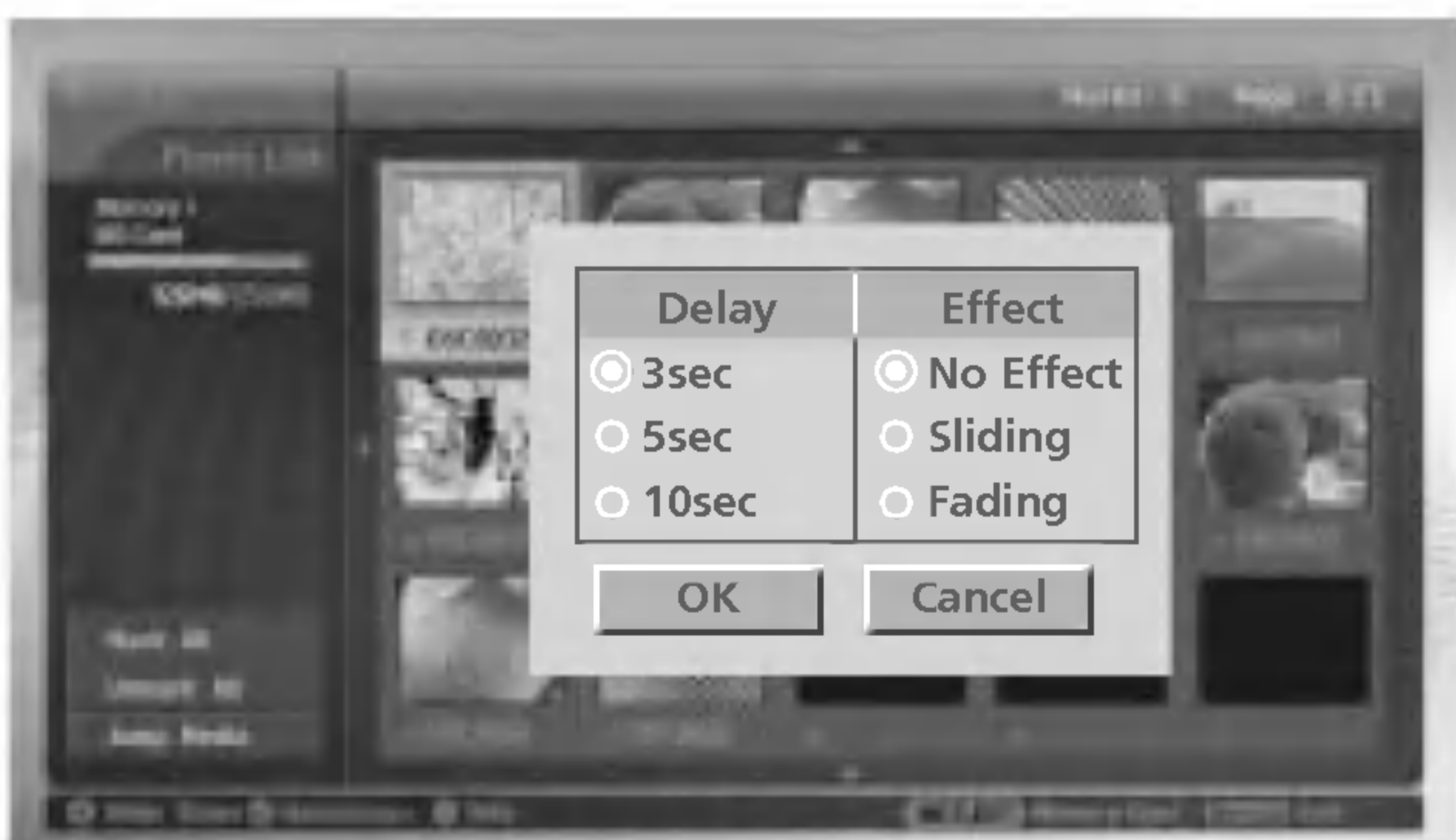

Image selection	<ul style="list-style-type: none"> • Press the ▶ button to select next image. • Press the ◀ button to select previous image. • If you mark a file, you can see only the marked image.
Image Rotation	<ul style="list-style-type: none"> • Press the ▲ / ▼ button to rotate the image. • ▲: Rotate clockwise • ▼: Rotate counterclockwise • The enlarged image cannot be rotated.
Image Zoom In/Out	<ul style="list-style-type: none"> • Press the PR ▲ / ▼ button to enlarge or reduce the image 2 or 4 times. • Press the ▲ / ▼ / ◀ / ▶ button to move the enlarged image.
Image Deletion	<ul style="list-style-type: none"> • Press the MARK button to delete the current image.
Go to the Menu	<ul style="list-style-type: none"> • Press the EXIT button to return to the photo list.
Shown/Hidden the menu	<ul style="list-style-type: none"> • Each press of the OK button, the menu will toggle hidden or shown. • The OSD menu will automatically disappear after a while.

Slide Show



1. Press the ▲ / ▼ / ◀ / ▶ button to select JPEG file and then press the **OK** button.
2. Press the ▲ / ▼ button to select **Slide Show** or **Show Marked** and then press the **OK** button. (If you mark the file with using **MARK** button, **Show Marked** is displayed on screen.)



3. You can choose the slide show delayed time and effect. Press the ▲ / ▼ / ◀ / ▶ button to choose the slide show delayed time and effect.
4. Press the ▲ / ▼ / ◀ / ▶ button to select **OK**. Slide show start.

Notes:

- You can also operate the **Slide Show** or **Show Marked** with  button directly as shown.
- If you mark a file, Slide Show will show only the marked image.



Next / previous Image Selection	<ul style="list-style-type: none"> • Press the ▶ button to select next image. • Press the ◀ button to select previous image.
Image Pause	<ul style="list-style-type: none"> • Press the button to pause the current image. • Press the  button to restart the slide show. • By pressing ◀ / ▶ button, you can also select the next or previous image while pausing the image.
Go to the menu	<ul style="list-style-type: none"> • Press the EXIT button to return to the photo list.
Shown/Hidden the menu	<ul style="list-style-type: none"> • Each press of the OK button, the menu is toggle hidden or shown. • The OSD menu will automatically disappear after a while.

JPEG File Viewing Options

JPEG file Deletion and Cancel

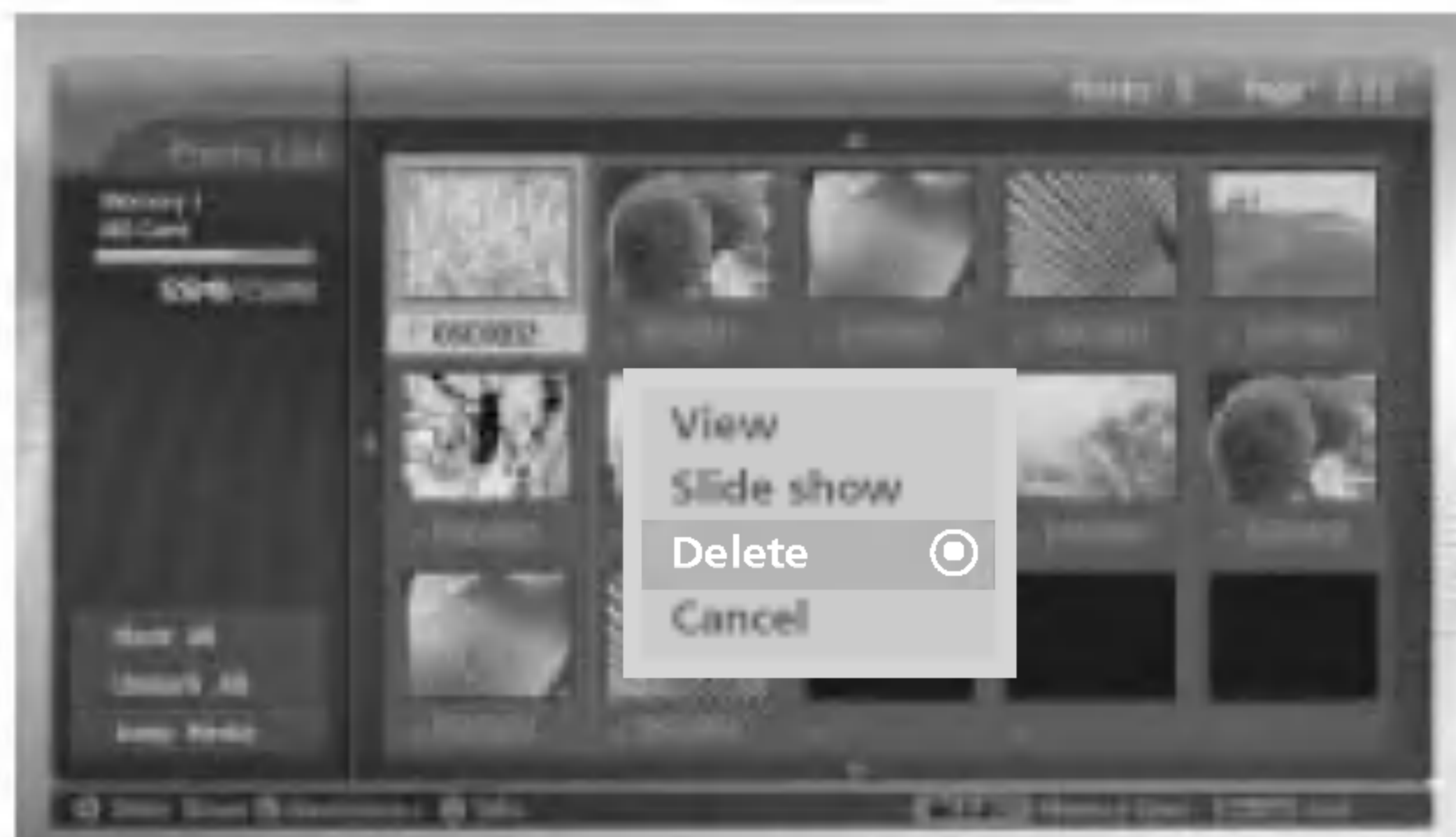

1. Use the ▲ / ▼ / ◀ / ▶ button to select JPEG file and then press the **OK** button.
2. To delete the file, press the ▲ / ▼ button to select **Delete** and then press the **OK** button. When “Do you want to delete the file?” message is displayed, select **YES (YES or NO)** with ◀ / ▶ button. The file is deleted, all the following files are shifted up one position.



* If you select **Delete** after marking some files, all of the marked files are deleted. But in case MS,SMC,SD memory card is set to write protect, “ Protection Mode. Please push the **OK** button.” message is displayed. When you select the **OK**, the screen will return to the photo list.(Release the write protection to delete a JPEG file.)

3. To return to the photo list, press the ▲ / ▼ button to select **Cancel** and then press the **OK** button.

File Information

- Use it to check information for selected JPEG file.

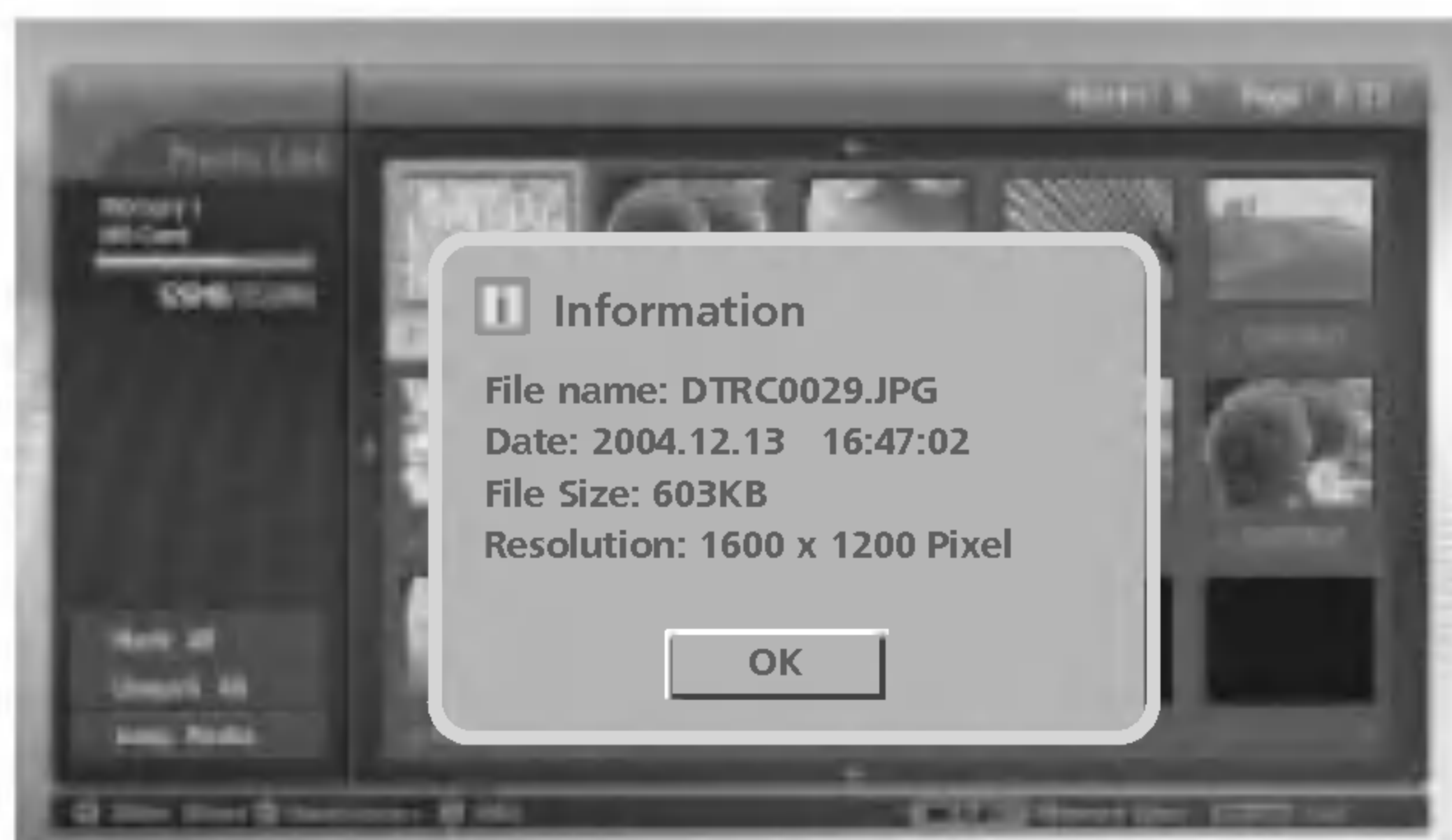

1. In photo media, select your desired JPEG file.
2. Press the **INFO** button. The file information for selected JPEG file is displayed. If JPEG file has no information, you can't check it.
3. Press the **OK**, **EXIT** or **INFO** button to return to the photo list.

Screen Saver

- While displaying the photo list, if a button is not pressed within approx. 30 seconds, the screen saver is activated.



* The '**Screen Saver**'? Screen saver is to prevent screen pixel burning caused by long time still picture.



- Press the ▲ / ▼ / ◀ / ▶, **EXIT**, ▶(play), II, ■, ◀◀, ▶▶, **INFO**, **PR** ▲ / ▼, **MARK** buttons to release the screen saver.

MP3 File Playing Operation

- Purchased MP3/music files may contain copyright restrictions. Playback of these files may not be supported by this model.

Screen Components

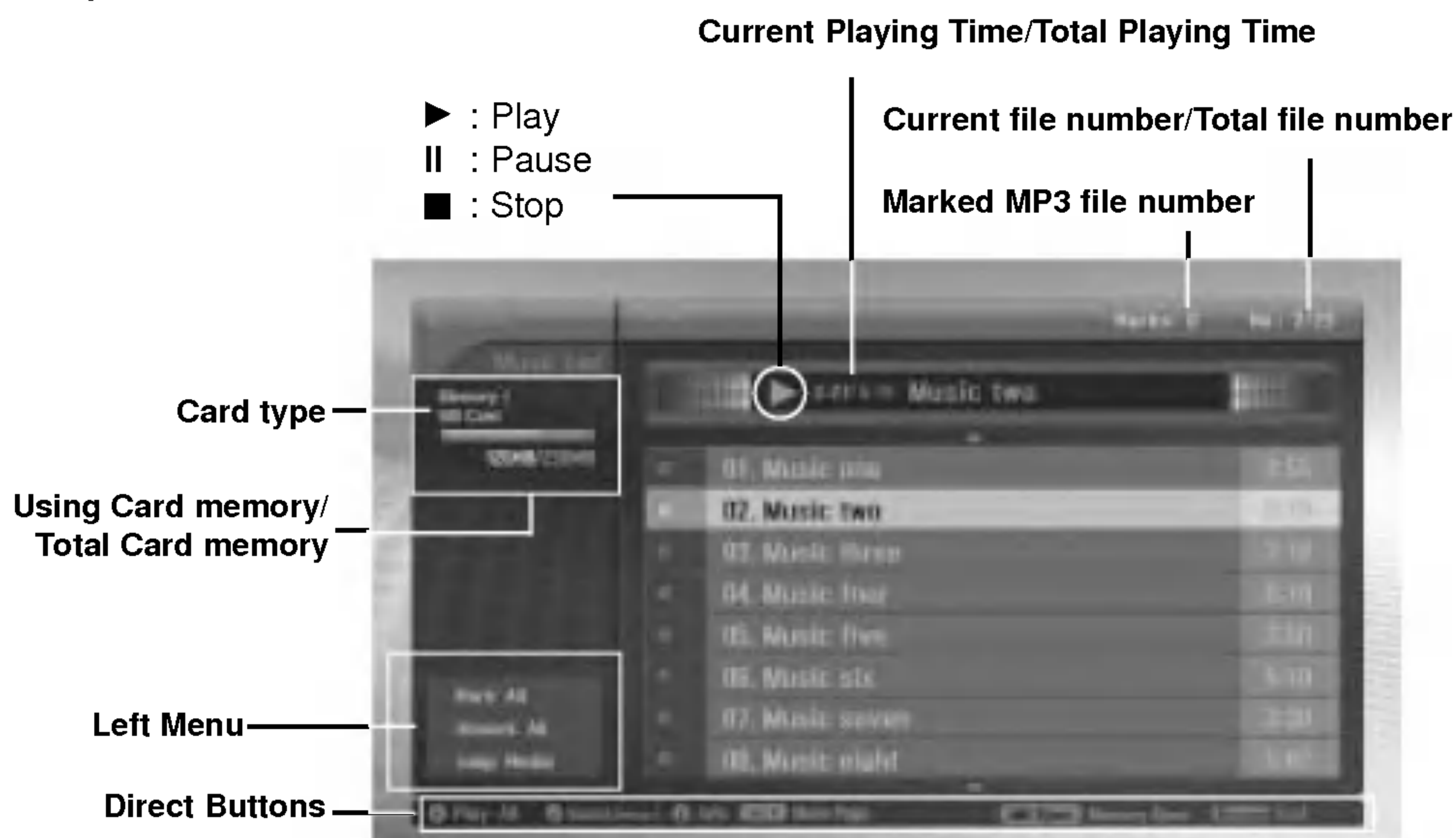

MP3 File Selection and Playback

- MP3 file Selection and deletion function don't work while playing music.
- If pressing any button except , , button on the remote control while playing music, the music playing is stopped.
- Moves from the current 8 files list to the next files list with **PR** / button.

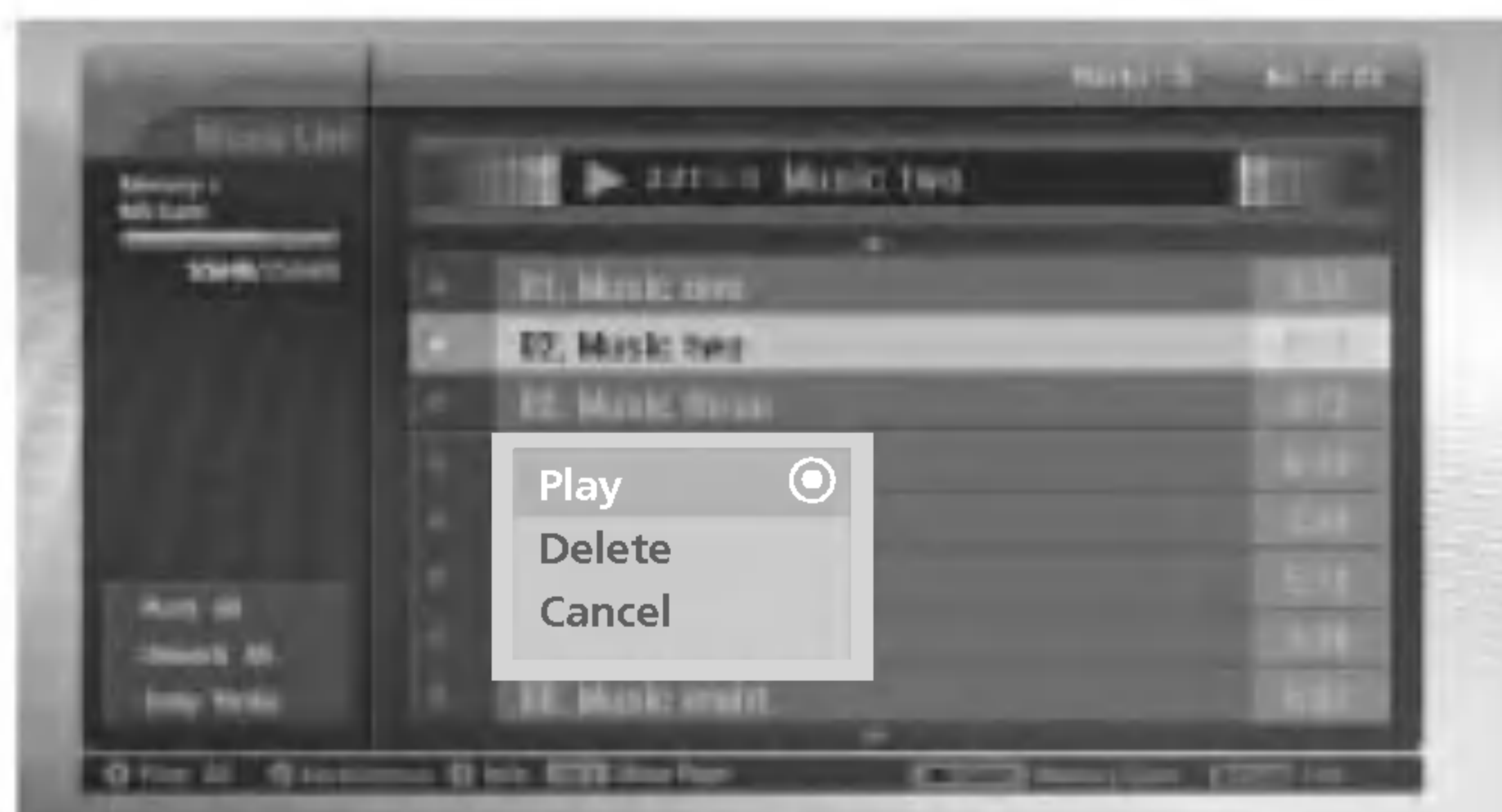

1. Insert the memory card into Slot 1 and/or Slot 2 on the set side panel.
2. Press the button.
3. Use / / / button to select music media for slot1 or slot 2.
4. Press the **OK** button to enter the music media.
Note: It's possible to display 8 MP3 files per page.
5. Press the / button to select desired MP3 file and then press the **OK** button.
6. Press the / button to select **Play** or **Play Marked** and then press the **OK** button.(If you mark the file with using **MARK** button, **Play Marked** is displayed on screen.)

Notes:

- You can also play the music with button directly.
- The current playing MP3 file displays in front of the title.
- While playing music, press the button to select the next music directly.
- If you press the button while playing music, the MP3 will replay from beginning.
(If you press the button within 1~2 seconds after playing the music, the MP3 plays the previous music.)

MP3 File Playing Operation

* In this manual, the OSD (On Screen Display) may be different from your set's because it is just an example to help you with the set operation.

Stop/Pause Playback

◆ Stop Playback

To stop playback, press the **■** button on the remote control.

To stop playback, press the **OK**, **PR** (**▲** / **▼**) button on the set.

Notes:

- If you replay the MP3 file after stopping, the highlighted MP3 file on menu will play.
- On stopping, **VOL** (**◀** / **▶**) and **PR** (**▲** / **▼**) buttons on the TV are used to navigate.

◆ Pause Playback

1. Press the **II** button to pause playback.
2. Press the **II** or **▶** button to starts from the point of your paused part.

Mark/Unmark for MP3 file

- You can mark/unmark the file to play the desired file only.
- The menu on the left can be used when playback is stoped.



◆ Mark/Unmark for all files

1. In music media, press the **◀** button.
2. Press the **▲** / **▼** button to select **Mark All** or **Unmark All**.
 - If you select **Mark All**, every file is selected.
 - If you select **Unmark All**, the selection for every file is released.
3. Press the **OK** button and then **▶** button to return to the music list.

◆ Mark/Unmark for some file

Press the **MARK** button repeatedly to mark or unmark some MP3 file.

Jump Media

- Use this function to jump to other media during using music media.

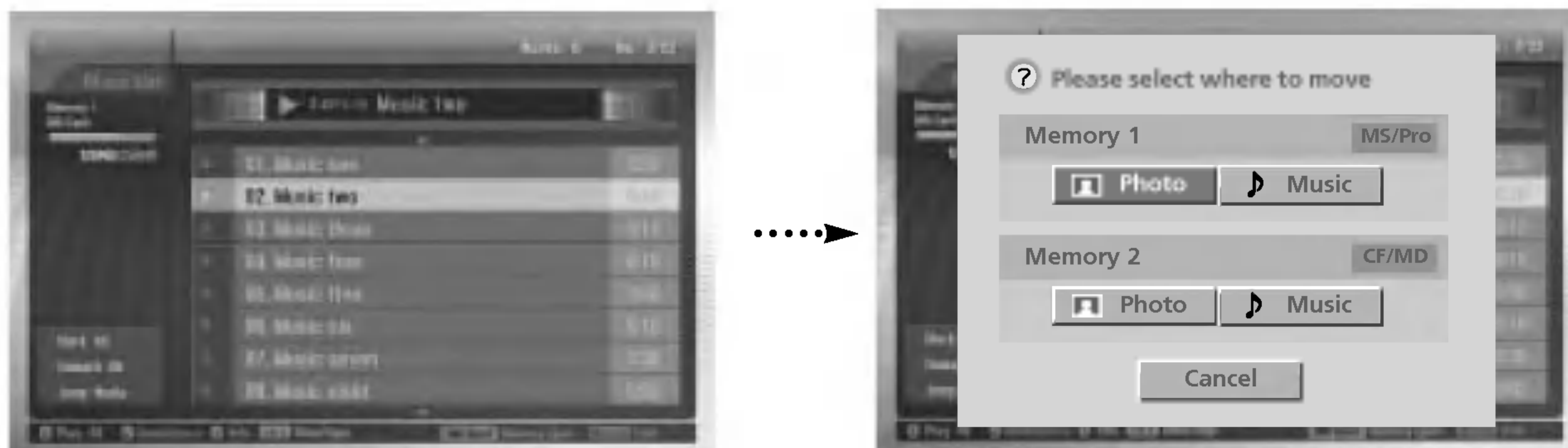

1. In music media, press the ◀ button.
2. Press the ▲ / ▼ button to select **Jump media** and then press the **OK** button.
3. Press the ▲ / ▼ / ◀ / ▶ button to select desired media and then press the **OK** button. The screen displays each media list.

Screen Saver

- If you don't press any button for about 30 seconds, the screen saver is activated.

◆ During playing the MP3

* The 'Screen Saver'?
Screen saver is to prevent screen pixel burning caused by long time still picture.

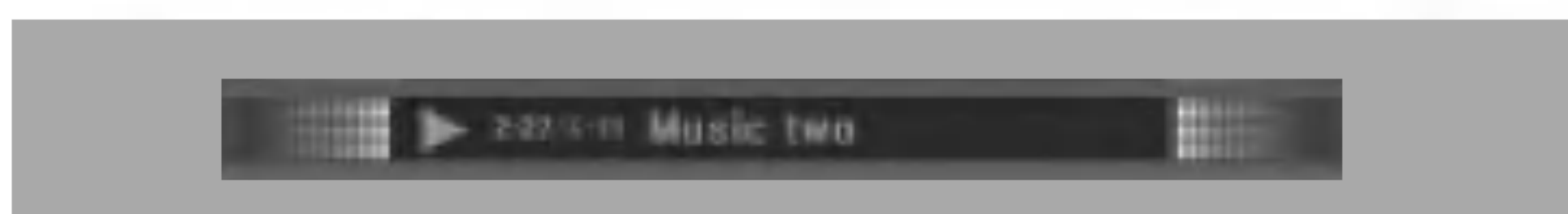

- Press the ◀, ⏮, ⏭ buttons. The screen saver is released but the MP3 playback is restarted.
- ◀, ⏮ : Return to a initial portion of the MP3 playback.
- ⏭ : Playback the next MP3.
- If you press any other button, the screen saver is released and the MP3 playback is stopped.

◆ During stopping the MP3



- Press the ▲ / ▼ / ◀ / ▶, EXIT, ▶(play), II, ■, ⏮, ⏭, INFO, PR ▲ / ▼, MARK buttons to release the screen saver.

MP3 File Playing Operation

MP3 file deletion and Cancel

- It's impossible to delete the music during playback.

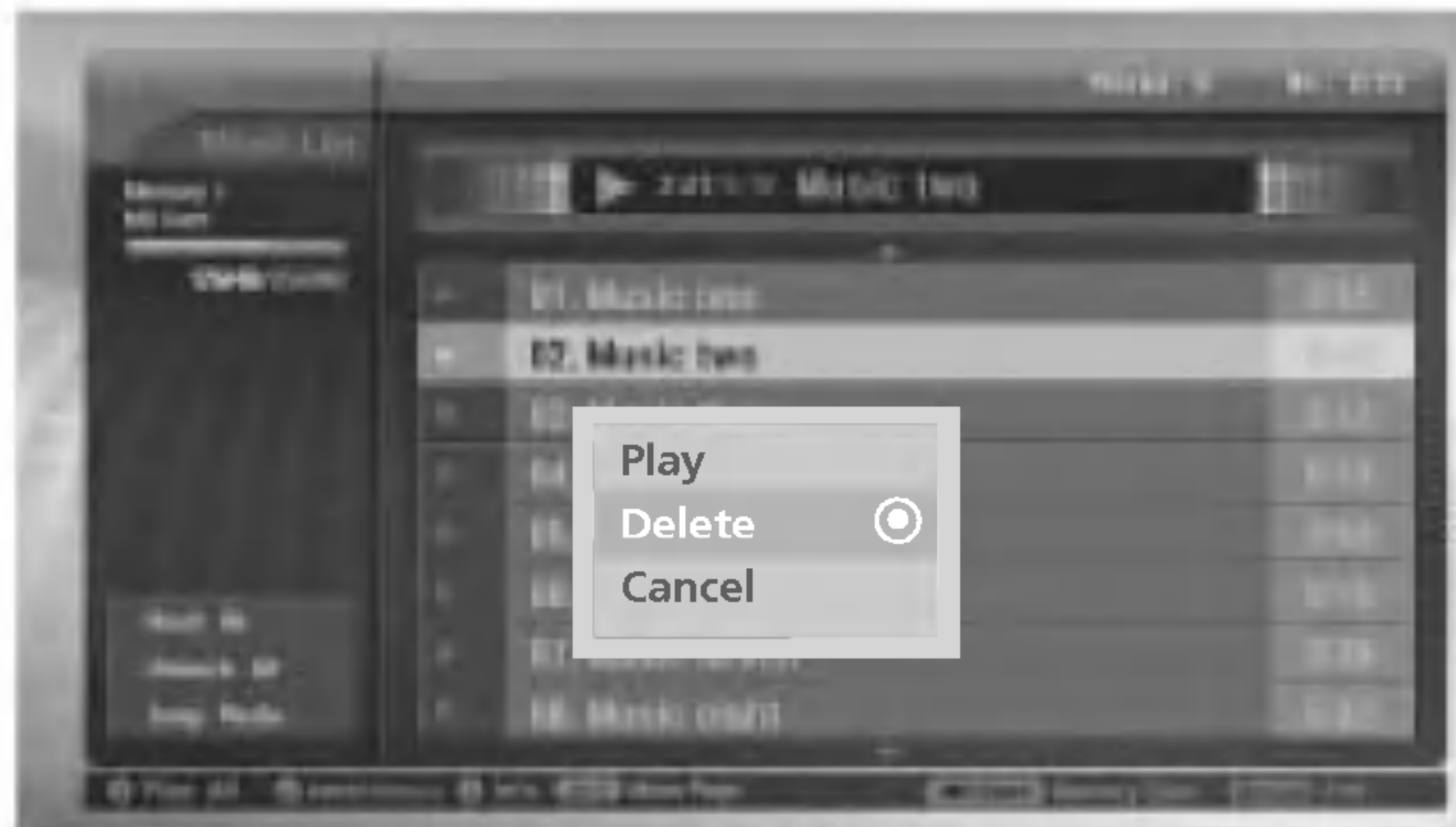

1. Use the ▲ / ▼ button to select MP3 file and then press the **OK** button.
2. To delete the file, press the ▲ / ▼ button to select **Delete** and then press the **OK** button. When "Do you want to delete the file?" message is displayed, select **YES (YES or NO)** with ◀ / ▶ button. The file is deleted, all the following files are shifted up one position.



* If you select **Delete** after marking some files, all of the marked files are deleted. But in case MS,SMC,SD memory card setted the write protection, " Protection Mode. Please push the **OK** button." message is displayed. When you select the **OK**, the screen is returned to the photo list.(Release the write protection to delete a MP3 file.)

3. To return to the music list, press the ▲ / ▼ button to select **Cancel** and then press the **OK** button.

File Information

- Use it to check information for selected MP3 file.

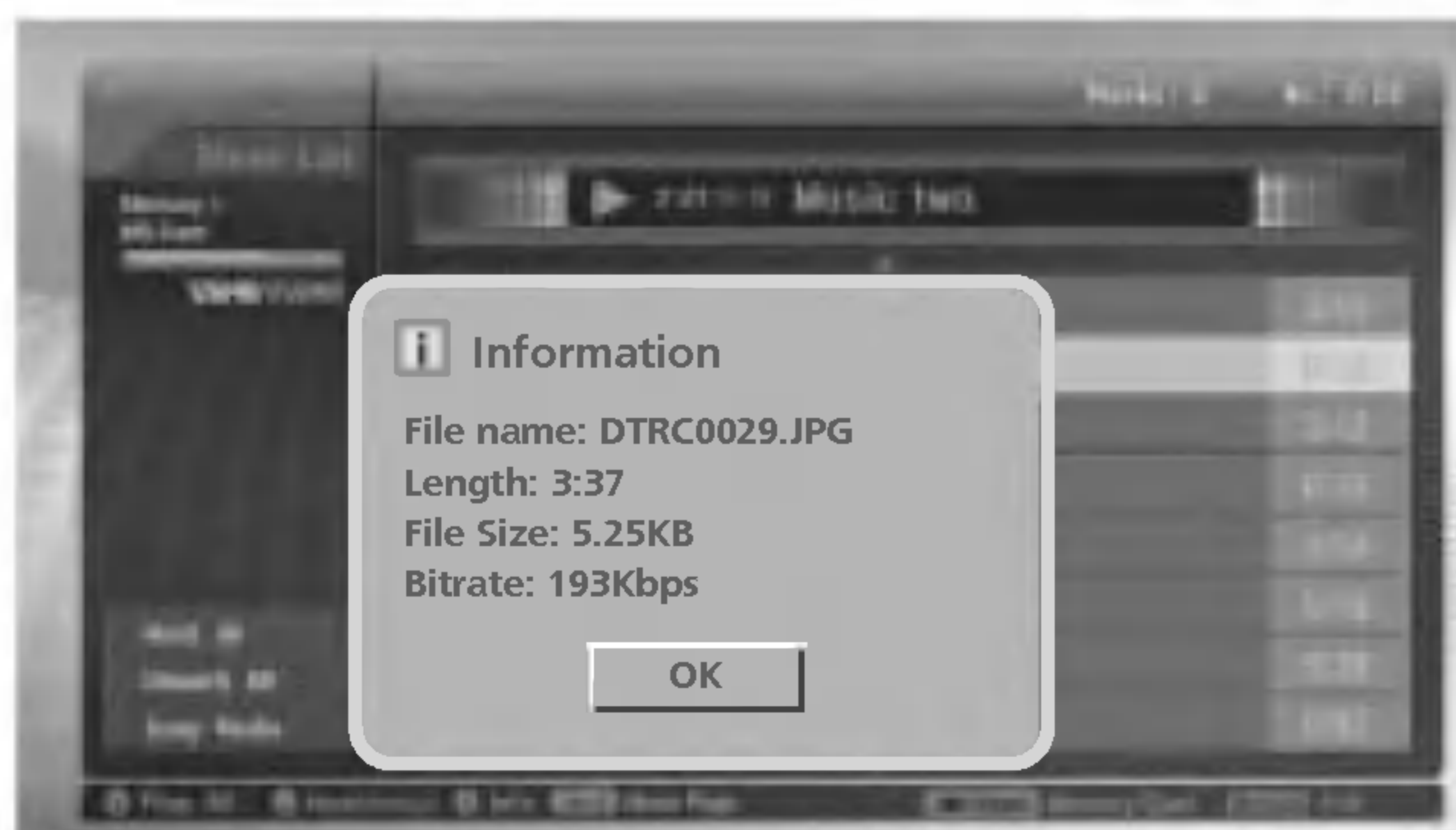

1. In music media, select your desired MP3 file.
2. Press the **INFO** button. The file information for selected MP3 file is displayed. If MP3 file has no information, you can't check it.
3. Press the **OK**, **EXIT** or **INFO** button to return the previous menu.

Programming the Remote

- ▶ The remote is a multi-brand or a universal remote. It can be programmed to operate most remote-controllable devices of other manufacturers.
Note that the remote may not control all models of other brands.

Programming a code into a remote mode

1. To find out whether your remote can operate the device without programming, turn on the device such as a VCR and press the corresponding mode button on the remote.
After that, press the **POWER** button. If the device is turned off then it responds properly and the remote need not to be programmed. If not, the remote should be programmed to operate the device. The programming procedures are explained below.
2. Press the **MENU** and **MUTE** button continuously at the same time for 2 seconds, the current selected device button will be illuminated.
If you don't press any button for 20 seconds, the light on the mode button will be turned off. In that case, you have to repeat from step 2.
3. Enter code numbers using the number button on the remote by referring the code table on the following pages. When pressing the button, the light blinks at a time. If the device turned off, the programming is successful.
4. Press the **MENU** button to store the code. After blinking twice, this code is stored.
5. Test the remote functions to see if the device responds properly. If not, repeat from step 2.

Programming Codes

VCRs

Brand	Codes	Brand	Codes	Brand	Codes	Brand	Codes
AIWA	034	KENWOOD	014 034 039 043	PORTLAND	108	TATUNG	039 043
AKAI	016 043 046 124		047 048	PULSAR	072	TEAC	034 039 043
	125 146	LG (GOLDSTAR)	001 012 013 020	QUARTZ	011 014	TECHNICS	031 033 070
AMPRO	072		101 106 114 123	QUASAR	033 066 075 145	TEKNIKA	019 031 033 034
ANAM	031 033 103	LLOYD	034	RCA	013 020 033 034		101
AUDIO DYNAMICS	012 023 039 043	LXI	003 009 013 014		040 041 062 063	THOMAS	034
BROKSONIC	035 037 129		017 034 101 106		107 109 140 144	TMK	006
CANON	028 031 033	MAGIN	040		145 147	TOSHIBA	008 013 042 047
CAPEHART	108	MAGNAVOX	031 033 034 041	REALISTIC	003 008 010 014		059 082 112 131
CRAIG	003 040 135		067 068		031 033 034 040	TOTEVISION	040 101
CURTIS MATHES	031 033 041	MARANTZ	012 031 033 067		053 054 101	UNITECH	040
DAEWOO	005 007 010 064		069	RICO	058	VECTOR RESEARCH	012
	065 108 110 111	MARTA	101	RUNCO	148	VICTOR	048
	112 116 117 119	MATSUI	027 030	SALORA	014	VIDEO CONCEPTS	012 034 046
DAYTRON	108	MEI	031 033	SAMSUNG	032 040 102 104	VIDEOSONIC	040
DBX	012 023 039 043	MEMOREX	003 010 014 031		105 107 109 112	WARDS	003 013 017 024
DYNATECH	034 053		033 034 053 072		113 115 120 122		031 033 034 040
ELECTROHOME	059		101 102 134 139		125		053 054 131
EMERSON	006 017 025 027	MGA	045 046 059	SANSUI	022 043 048 135	YAMAHA	012 034 039 043
	029 031 034 035	MINOLTA	013 020	SANYO	003 007 010 014	ZENITH	034 048 056
	036 037 046 101	MITSUBISHI	013 020 045 046		102 134		058 072 080 101
	129 131 138 153		049 051 059 061	SCOTT	017 037 112 129		
FISHER	003 008 009 010		151		131		
FUNAI	034	MTC	034 040	SEARS	003 008 009 010		
GE	031 033 063 072	MULTITECH	024 034		013 014 017 020		
	107 109 144 147	NEC	012 023 039 043		031 042 073 081		
GO VIDEO	132 136		048		101		
HARMAN KARDON	012 045	NORDMENDE	043	SHARP	031 054 149		
HITACHI	004 018 026 034	OPTONICA	053 054	SHINTOM	024		
	043 063 137 150	PANASONIC	066 070 074 083	SONY	003 009 031 052		
INSTANTREPLAY	031 033		133 140 145		056 057 058 076		
JCL	031 033	PENTAX	013 020 031 033		077 078 149		
JCPENNY	012 013 015 033		063	SOUNDESIGN	034		
	040 066 101	PHILCO	031 034 067	STS	013		
JENSEN	043	PHILIPS	031 033 034 054	SYLVANIA	031 033 034 059		
JVC	012 031 033 043		067 071 101		067		
	048 050 055 060	PILOT	101	SYMPHONIC	034		
	130 150 152	PIONEER	013 021 048	TANDY	010 034		

CATV

Brand	Codes	Brand	Codes	Brand	Codes	Brand	Codes
ABC	003 004 039 042	GOLDEN CHANNEL	030	PIONEER	065 085 090	SPRUCER	047 078
	046 052 053	HAMLIN	049 050 055		034 051 052 063	STARCOM	002 004 008 009
AJIN	112	HITACHI	052 055		076	STARGATE	008 030
ANTRONIK	014	HOSPITALITY	070 077	POST NEWS WEEK	016	TADIRAN	030
ARCHER	005 007 014 024	JERROLD	002 003 004 008	PRUCER	059	TAEKWANG	110
CABLE STAR	026		009 010 052 069	PTS	011 048 071 072	TAIHAN	105
CENTURION	092		074		073 074	TANDY	017
CENTURY	007	LG (GOLDSTAR)	001 106 101 005	PULSAR	100	TEXSCAN	029
CITIZEN	007	M-NET	037	RCA	047	TOCOM	039 040 056
COLOUR VOICE	065 090	MACOM	033	REGAL	049 050	TOSHIBA	100
COMBANO	080 081	MAGNAVOX	010 012 064 079	REGENCY	057	UNIKA	007 014 024
COMTRONICS	019 030	MEMOREX	100	REMBRANT	025	UNITED CABLE	004 053
DIAMOND	023	MOVIE TIME	028 032	SAMSUNG	102 107 030 068	UNIVERSAL	005 007 014 024
EAGLE	020 030 040	NSC	015 028 038 071	SCIENTIFIC ATLANTA	003 011 041 042		026 027 032 035
EASTERN	057 062 066		073		043 045 046	VIEWSTAR	012 015 018 086
ELECTRICORD	032	OAK	016 031 037 053	SHERITECH	022		087 088 089
GE	072	PANASONIC	044 047	SIGNAL	030	ZENITH	100 114 060 093
GEMINI	008 022 025 054	PARAGON	100	SIGNATURE	052		
GI	052 074	PHILIPS	006 012 013 020	SL MARX	030		

HDSTB

Brand	Codes	Brand	Codes	Brand	Codes	Brand	Codes
ALPHASTAR DSR	123		133 134	PACE SKY SATELLITE	143		088 090 107 130
AMPLICA	050	GENERAL INSTRUMENT	003 004 016 029	PANASONIC	060 142		137
BIRDVIEW	051 126 129		031 059 101	PANSAT	121	TOSHIBA	002 127
CHANNEL MASTER	013 014 015 018	HITACHI	139 140	PERSONAL CABLE	117	UNIDEN	016 025 042 043
	036 055	HOUSTON TRACKER	033 037 039 051	PHILIPS	071		044 045 048 049
CHAPARRAL	008 009 012 077		057 104	PICO	105		078 079 080 086
CITOH	054	HUGHES	068	PRESIDENT	019 102		101 135 136
CURTIS MATHES	050 145	JANIEL	060 147	PRIMESTAR	030 110 111	VIEWSTAR	115
DRAKE	005 006 007 010	JERROLD	061	PROSAT	072	WINEGARD	128 146
	011 052 112 116	KATHREIN	108	RCA	066 106	ZENITH	081 082 083 084
	141	LEGEND	057	REALISTIC	043 074		091 120
DX ANTENNA	024 046 056 076	LG	001	SAMSUNG	123		
ECHOSTAR	038 040 057 058	LUTRON	132	SATELLITE SERVICE CO	028 035 047 057		
	093 094 095 096	LUXOR	062 144		085		
	097 098 099 100	MACOM	010 059 063 064	SCIENTIFIC ATLANTA	032 138		
	122		065	SONY	103		
ELECTRO HOME	089	MEMOREX	057	STARCAST	041		
EUROPLUS	114	NEXTWAVE	028 124 125	SUPER GUIDE	020 124 125		
FUJITSU	017 021 022 027	NORSAT	069 070	TEECOM	023 026 075 087		

Audio

Brand	Codes	Brand	Codes	Brand	Codes	Brand	Codes
AIWA	014 028 070 096	JVC	004 013 141	PHILIPS	026 112 143		147 218
	125 129 139 229	KEC	185 186 187	PIONEER	039 042 043 063	TOSHIBA	137
	230	KENWOOD	038 050 067 089		065 091 093 094	THE	061
AKAI	163		170 171 197 206		115 123 127 250	VICTOR	088 131
ANAM	003 014 017 023		215 222	QUASAR	113	WARDS	089
	059 106 189 216	KOHEL	030	RCA	080	YAMAHA	054 055 066 092
	217 235 236	NAD	045 046	RCX	092		199
BURMECTER	252	LOTTE	014 016 036 098	REALISTIC	103 106		
CARVER	086		100 172 173 174	SAMSUNG	124 145 146 182		
CLARION	199		175 176 177 178		193 194 195 203		
DAEWOO	027 053 060 084		179 180 181 183		204 244 245 246		
	102 148 198 221		201 202 208 213	SANSUI	011 135 138 144		
DENON	015 075 130 143		214 219 223 232	SANYO	019 083 234		
FANTASIA	071		238 240	SCOTT	106 186		
FINEARTS	022	LXI	103	SHARP	031 032 051 052		
FISHER	089 099	MAGNAVOX	111		072 082 117 119		
LG(GOLDSTAR)	001 021 024 029	MARANTZ	002 018 020 025		156 184 199 200		
	087 107 108 110		034 041 081 090		206 209		
	190 191 192 210	MCINTOSH	049	SHERWOOD	005 006 158		
	211 212 239	MCS	104	SONY	044 045 109 114		
HAITAI	034 035 188 222	MEMOREX	107		118 126 248 249		
HARMAN/KARDON	068	NAD	046	TAEKWANG	012 020 073 074		
INKEL	037 058 062 069	ONKYO	013 040 041 047		076 077 105 161		
	078 079 095 121		048 056 057 132		162 163 164 165		
	122 149 150 151		133 140		166 167 168 169		
	152 153 154 155	OPTIMUS	158		205 231 233 242		
	157 158 159 160	PANASONIC	007 033 064 113	TEAC	010 085 106 136		
	189 207 222 224		142 220 241 251		185 187 237		
	225 226 227 243	PENNEY	104	TECHNICS	101 113 128 134		
	247						

DVD

Brand	Codes	Brand	Codes	Brand	Codes	Brand	Codes
APEX DIGITAL	022	MAGNAVOX	013	PHILIPS	013	SONY	007
DENON	020 014	MARANTZ	024	PIONEER	004 026	THOMPSON	005 006
GE	005 006	MITSUBISHI	002	PROCEED	021	TOSHIBA	019 008
HARMAN KARDON	027	NAD	023	PROSCAN	005 006	YAMAHA	009 018
JVC	012	ONKYO	008 017	RCA	005 006	ZENITH	010 016 025
LG	001 010 016 025	PANASONIC	003 009	SAMSUNG	011 015		

Troubleshooting Checklist

No picture & No sound	<ul style="list-style-type: none">• Check whether the set is turned on.• Power cord inserted into wall outlet?• Plug another product's power cord into the wall outlet where the set's power cord was plugged in.
Picture OK & No sound	<ul style="list-style-type: none">• Press the VOLUME (▲) button.• Sound muted? Press MUTE button.• Check whether the TV speaker is "on" in the SOUND menu.
The remote control doesn't work	<ul style="list-style-type: none">• Check to see if there is any object between the set and the remote control causing obstruction.• Check to see if the batteries are installed with the correct polarities. (Refer to p.5)• Check if the remote control handset is set up to correct mode.• Install new batteries. (Refer to p.5)
Picture appears slowly, after switching on	<ul style="list-style-type: none">• This is normal as the image is muted during the startup process of the set. Please contact your service centre, if the picture has not appeared after five minutes.
No or Poor colour or Poor picture	<ul style="list-style-type: none">• Select Colour in the PICTURE menu and press the ► button. (Refer to p.17)• Keep a certain distance between the set and the VCR.• Activate any function to restore the brightness of the picture. (If still picture is on the screen for more than 5 minutes, the screen gets dark.)
Horizontal/vertical bars or picture shaking	<ul style="list-style-type: none">• Check for local interference such as an electrical appliance or power tool.
No output from one of the speakers	<ul style="list-style-type: none">• Adjust Balance in the SOUND menu. (Refer to p.17)
Unusual sound from inside the set	<ul style="list-style-type: none">• A change in ambient humidity or temperature may result in an unusual noise at the time of switching off or on of the set and does not indicate a fault with the set.

Product Specifications

MODEL	42PX4R / 42PX4RH 42PX4R-ZB / 42PX4RH-ZB	50PX4R / 50PX4RH 50PX4R-ZB / 50PX4RH-ZB
Width (inches / mm)	49.3 / 1252	57.6 / 1461
Height (inches / mm)	27.78 / 705.5	32.9 / 835
Depth (inches / mm)	11.29 / 286.7	13.1 / 331.3
Weight (pounds / kg)	70.06 / 31.78	121.7 / 55.2
Power requirement	AC100-240V, 50/60Hz	AC100-240V, 50/60Hz
Operating Temperature Range	32 ~ 104 °F (0 ~ 40 °C)	32 ~ 104 °F (0 ~ 40 °C)
Operating Humidity Range	Less than 80%	Less than 80%

MODEL	42PX5R / 42PX5RH 42PX5R-ZB / 42PX5RH-ZB	50PX5R / 50PX5RH 50PX5R-ZB / 50PX5RH-ZB
Width (inches / mm)	49.3 / 1252	57.6 / 1461
Height (inches / mm)	27.8 / 705.5	32.9 / 835
Depth (inches / mm)	10.7 / 270.7	13.1 / 331.3
Weight (pounds / kg)	91.3 / 41.4	120.6 / 54.7
Power requirement	AC100-240V, 50/60Hz	AC100-240V, 50/60Hz
Operating Temperature Range	32 ~ 104 °F (0 ~ 40 °C)	32 ~ 104 °F (0 ~ 40 °C)
Operating Humidity Range	Less than 80%	Less than 80%

- The specifications shown above may be changed without notice for quality improvement.

