



PLASMA TV OWNER'S MANUAL

Please read this manual carefully before operating your set.
Retain it for future reference.
Record model number and serial number of the set.
See the label attached on the back cover and quote this information to your dealer when you require service.

Model number :
Serial number :

Safety Instructions

WARNING

Do not place the set in direct sunlight or near heat sources such as heat registers, stove and so on.

- This may cause a fire.

Do not use the set in damp place such as a bathroom or any place where it is likely to get wet.

- This may cause a fire or could give an electric shock.

Bend antenna cable between inside and outside building to prevent rain from flowing in.

- This may cause water damaged inside the set and could give an electric shock.

Earth wire should be connected.

- If the earth wire is not connected, there is possible a danger of electric shock caused by the current leakage.
- If grounding methods are not possible, a separate circuit breaker should be employed and installed by a qualified electrician.

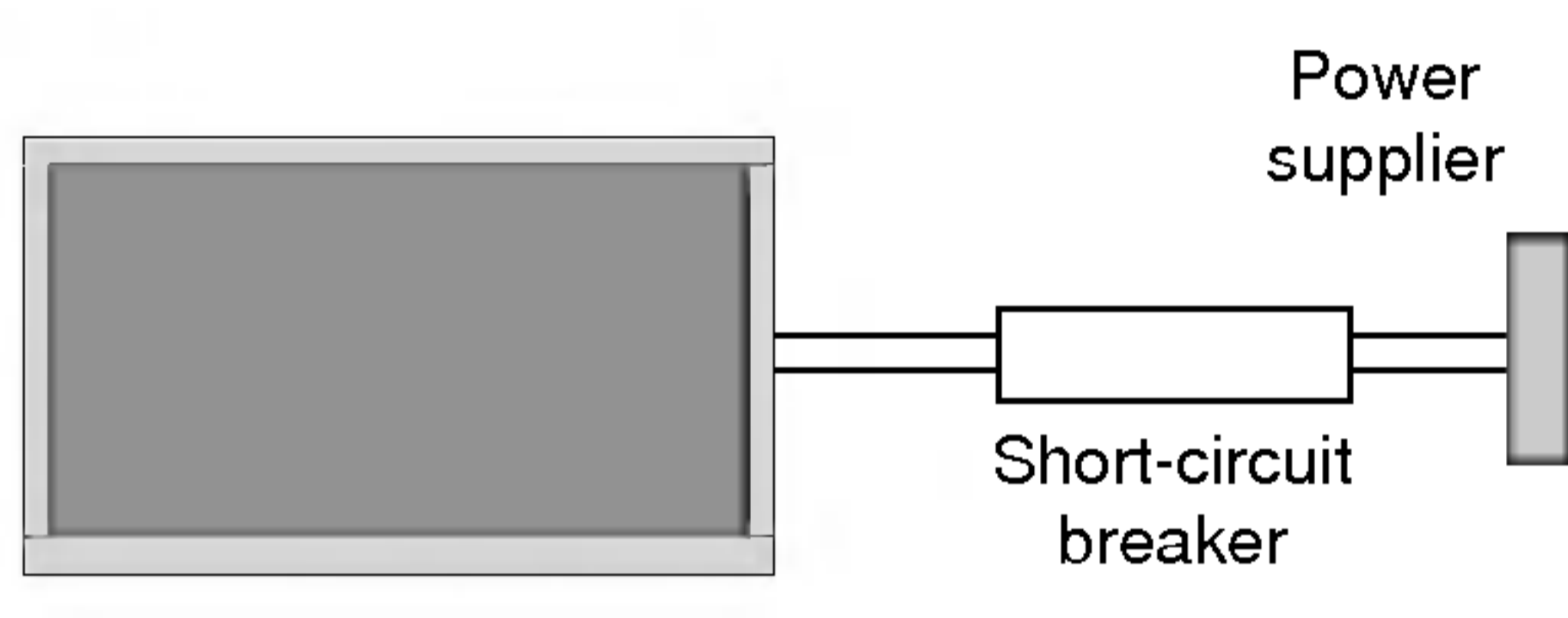

- Do not connect ground to telephone wires, lightning rods or gas pipe.

Apparatus shall not be exposed to dripping or splashing and no objects filled with liquids, such as vases, shall be placed on the apparatus.

WARNING in U.K. only

- * This set is supplied with a BS 1363 approved 13 amp mains plug, fused at 13 amp. When replacing the fuse always use a 13 amp BS 1362, BSI or ASTA approved type. Never use this plug with the fuse cover omitted. To obtain a replacement fuse cover contact your dealer or "LG Electronics U.K. Ltd." If the type of plug supplied is not suitable for the mains sockets in your home, then the plug should be removed and a suitable type fitted. A mains plug removed from the mains lead of this set must be destroyed. A mains plug with bared wires is hazardous if inserted in a mains socket. Do not connect either wire to the earth pin, marked with the letter E or with the earth symbol \equiv or coloured green or green and yellow. If any other plug is fitted, use a 13 amp fuse, either in the plug, or at the distribution board. The wires in this mains lead are coloured in accordance with the following codes: **BLUE: NEUTRAL, BROWN: LIVE** As the colours of the wires in the mains lead of this set may not correspond with the coloured marking identifying the terminals in your plug, proceed as follows: The wire which is coloured blue must be connected to the terminal which is marked with the letter N or coloured black. The wire which is coloured brown must be connected to the terminal which is marked with the letter L or coloured red.

Do not insert any object into the exhaust vent.

- This may cause a fire or could give an electric shock.

Do not place heavy objects on the set.

- This may cause serious injury to a child or adult.

Do not use water while cleaning the set.

- This may cause damaged the set or could give an electric shock.

In case of smoke or strange smell from the set, switch it off ,unplug it from the wall outlet and contact your dealer or service center.

- This may cause a fire or could give an electric shock.

Do not attempt to service the set yourself. Contact your dealer or service center.

- This may cause damaged the set or could give an electric shock.

During storm activity, unplug the set from the wall outlet and don't touch an antenna cable.

- This may cause damaged the set or could give an electric shock.

DISCONNECTING DEVICE FROM MAINS

- Mains plug is the disconnecting device. The plug must remain readily operable.

WARNING

TO REDUCE THE RISK OF FIRE AND ELECTRIC SHOCK, DO NOT EXPOSE THIS PRODUCT TO RAIN OR MOISTURE.

* Safety instructions have two kinds of information, and each meaning of it is as below.

⚠ WARNING The violation of this instruction may cause serious injuries and even death.

⚠ NOTES The violation of this instruction may cause light injuries or damage of the product.

⚠ Take care of danger that may happen under specific condition.

⚠ NOTES

Never touch the power plug with a wet hand.

- This may cause an electric shock.

Disconnect from the mains and remove all connections before moving.

Do not place the set in a built-in installation such as a bookcase or rack.

- Ventilation required.

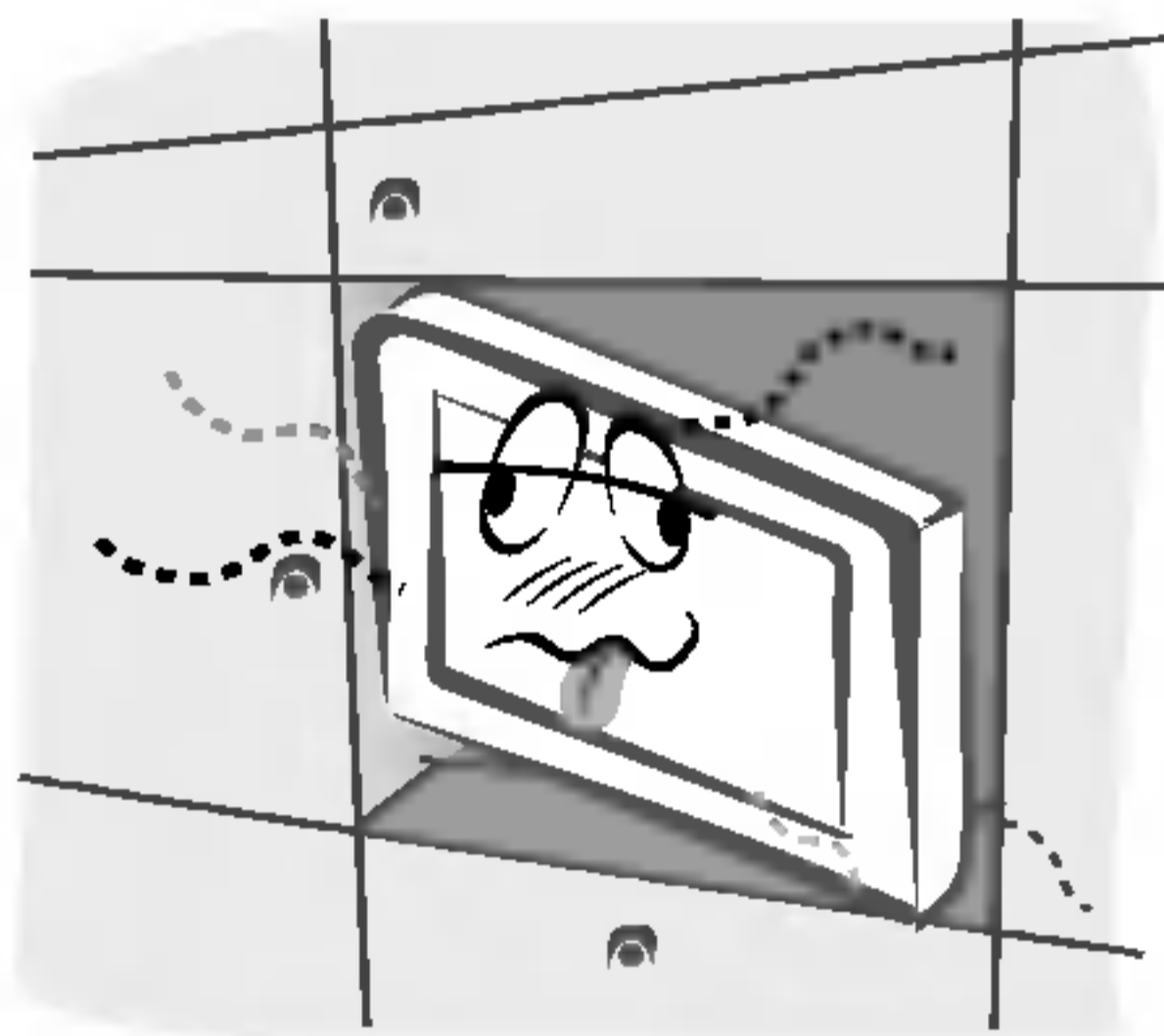

When installing the set on a table, be careful not to place the edge of its stand on the end of the table.

- This may cause the set to fall, causing serious injury to a child or adult, and serious damage to the set.

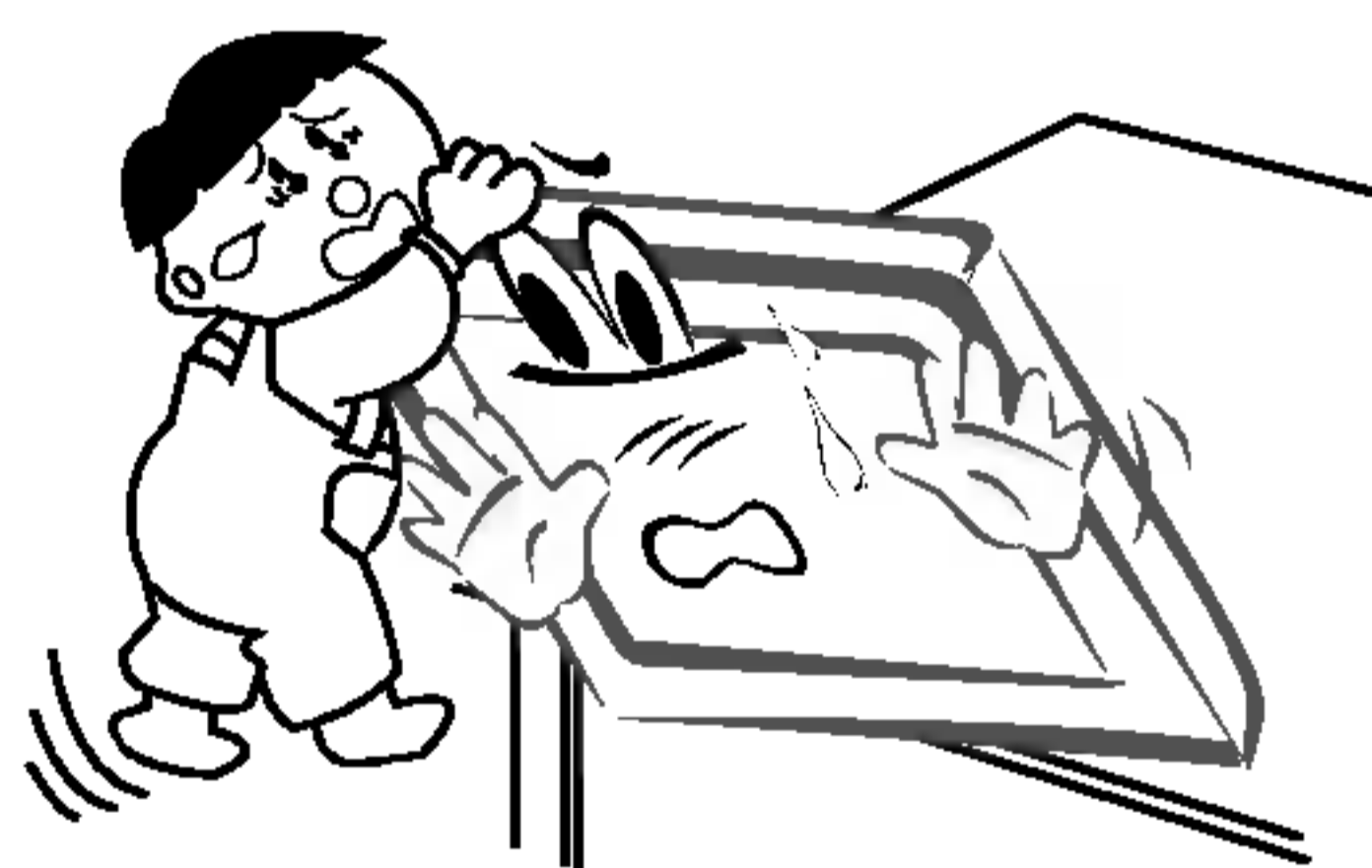

Do not place an outside antenna in the vicinity of overhead power lines or other electric light or power circuits.

- This may cause an electric shock.

There should be enough distance between an outside antenna and power lines to keep the former from touching the latter even when the antenna falls.

- This may cause an electric shock.

Do not pull the plug not the cord when disconnecting.

- This may cause a fire.

Ensure the power cord doesn't trail across any hot objects like a heater.

- This may cause a fire or an electric shock.

Do not plug in unit if power cord or plug is damaged or the connecting part of the power outlet is loose.

- This may cause a fire or an electric shock.

Dispose of used batteries carefully to prevent a child from eating them.

- In case of a child eating them, contact doctor immediately.

When moving the set assembled with speakers do not carry holding the speakers.

- This may cause the set to fall, causing serious injury to a child or adult, and serious damage to the Monitor.

Unplug this product from the wall outlet before cleaning. Do not use liquid cleaners or aerosol cleaners.

- This may cause damage the set or could give an electric shock.

Contact the service center once a year to clean the internal part of the set.

- Accumulated dust can cause mechanical failure.

The distance between eyes and the screen should be approx. 5 ~ 7 times the diagonal length of the screen away.

- If not, eyes will strain.

Unplug the set from the wall outlet when it is left unattended and unused for long periods of time or occurred a state of emergency.

- Accumulated dust may cause a fire or an electric shock from deterioration through electric leakage.

Contents

Safety Warnings		Time Menu Options	
Safety Instructions	2~3	Setting the Clock	19
Introduction		Setting the On/Off Timer	19
Remote Control Key Functions	5~6	Auto Sleep	19
Location and Function of Controls	7~8	Sleep Timer	19
Installation		Special Menu Options	
External Equipment Viewing Setups	9	Child Lock	20
Displayable Monitor Specification	10	ISM (Image Sticking Minimization) Method	20
HDMI	11	Low Power	20
Accessories	12	XD Demo	20
Installation Options	13	Screen Menu Options	
Operation		Auto Configure	20
Turning on the Set	14	Manual Configure	20
On-Screen Menu Language Selection (option)	14	Selecting Wide VGA/XGA mode	20
On screen menus	15	Setting Picture Format	21
Channel Menu Options		Picture Size Zoom	21
Auto Programme Tuning	16	Screen Position	21
Manual Programme Tuning	16	Cinema	21
Fine Tuning	16	NR (Noise Reduction)	21
Assigning a Station Name	17	Initializing (Reset to original factory value)	21
Booster (option)	17	Teletext (option)	
Programme Edit	17	Teletext Language Selection	21
Favourite Programme	17	Switch on/off	21
Calling up the Programme Table	17	SIMPLE Text (option)	22
Picture Menu Options		TOP Text (option)	22
PSM (Picture Status Memory)	18	FASTEXT	22
CSM (Colour Status Memory)	18	Special Teletext Functions	22
Manual Colour Temperature Control	18	PIP (Picture-in-Picture) Feature	
XD	18	Watching PIP	23
sRGB	18	Programme Selection for Sub Picture	23
ACM (Active Colour Management)	18	Selecting an Input Signal Source for the PIP	23
Manual Picture Control	18	Moving the PIP (PIP mode only)	23
Sound Menu Options		POP (Picture-out-of-Picture: Channel Scan)	23
SSM (Sound Status Memory)	18	Picture Size	23
BBE	18	Adjusting the screen for the PIP	23
AVL (Auto Volume Leveler)	18	Adjusting PIP Transparency (PIP mode only)	23
Adjusting Sound Control	18	Miscellaneous	
TV speaker	19	Programming the Remote (option)	24
Stereo/Dual Reception	19	Programming Codes (option)	25~26
NICAM Reception (option)	19	Troubleshooting Checklist	27
		Product Specifications	28

After reading this manual, keep it in a place where the user can refer to easily.

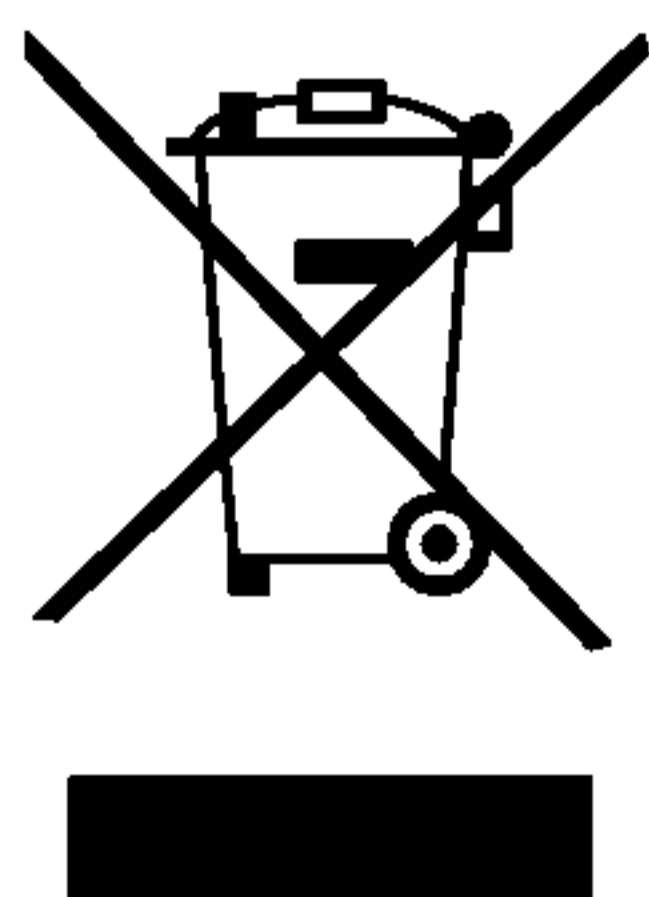

Disposal of your old appliance

1. When this crossed-out wheeled bin symbol is attached to a product it means the product is covered by the European Directive 2002/96/EC.
2. All electrical and electronic products should be disposed of separately from the municipal waste stream via designated collection facilities appointed by the government or the local authorities.
3. The correct disposal of your old appliance will help prevent potential negative consequences for the environment and human health.
4. For more detailed information about disposal of your old appliance, please contact your city office, waste disposal service or the shop where you purchased the product.

Remote Control Key Functions

- When using the remote control aim it at the remote control sensor of the set.
- There's maybe a defect in consecutive operation of remote control in specified brightness according to this set feature.

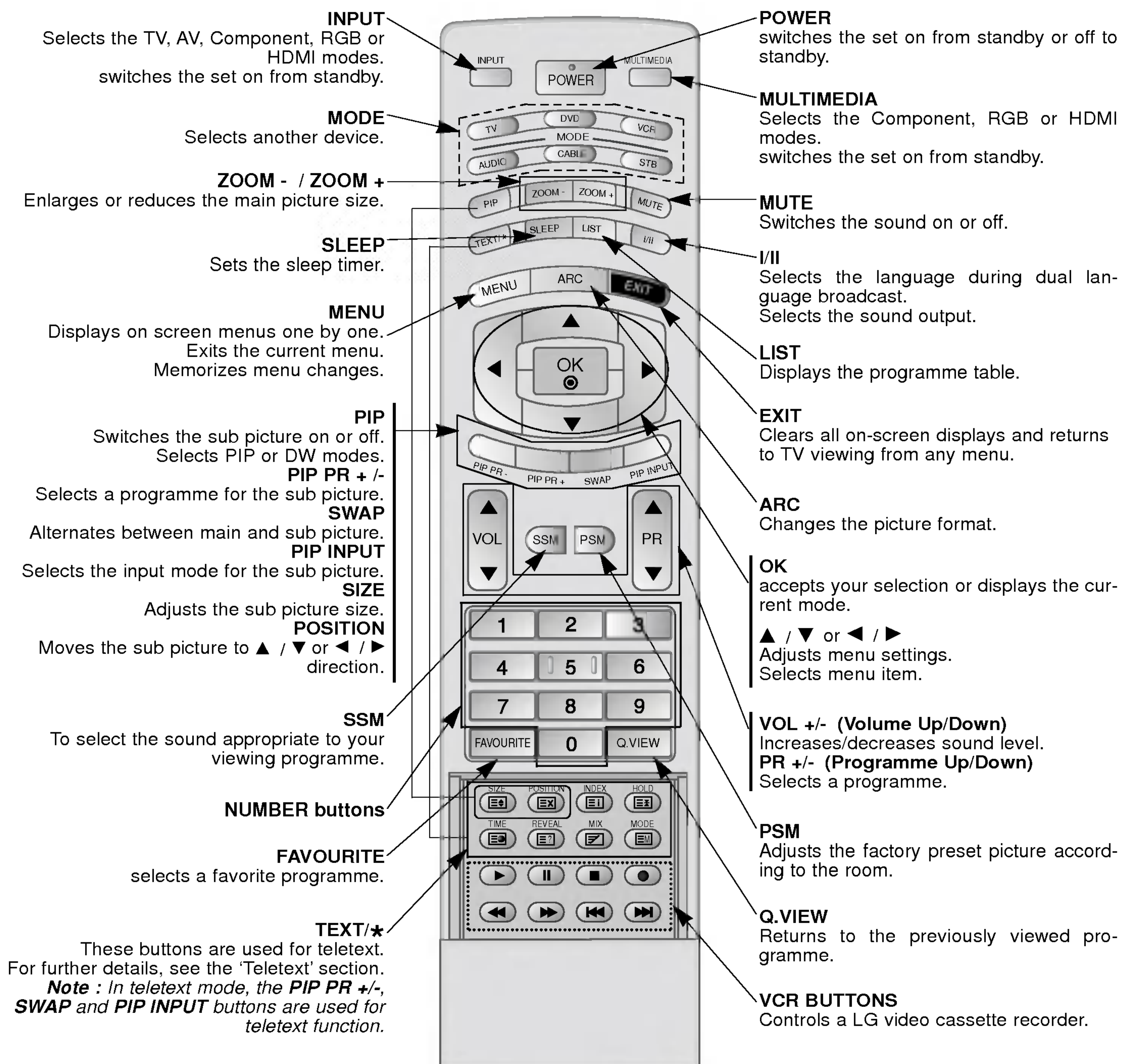

Installing Batteries

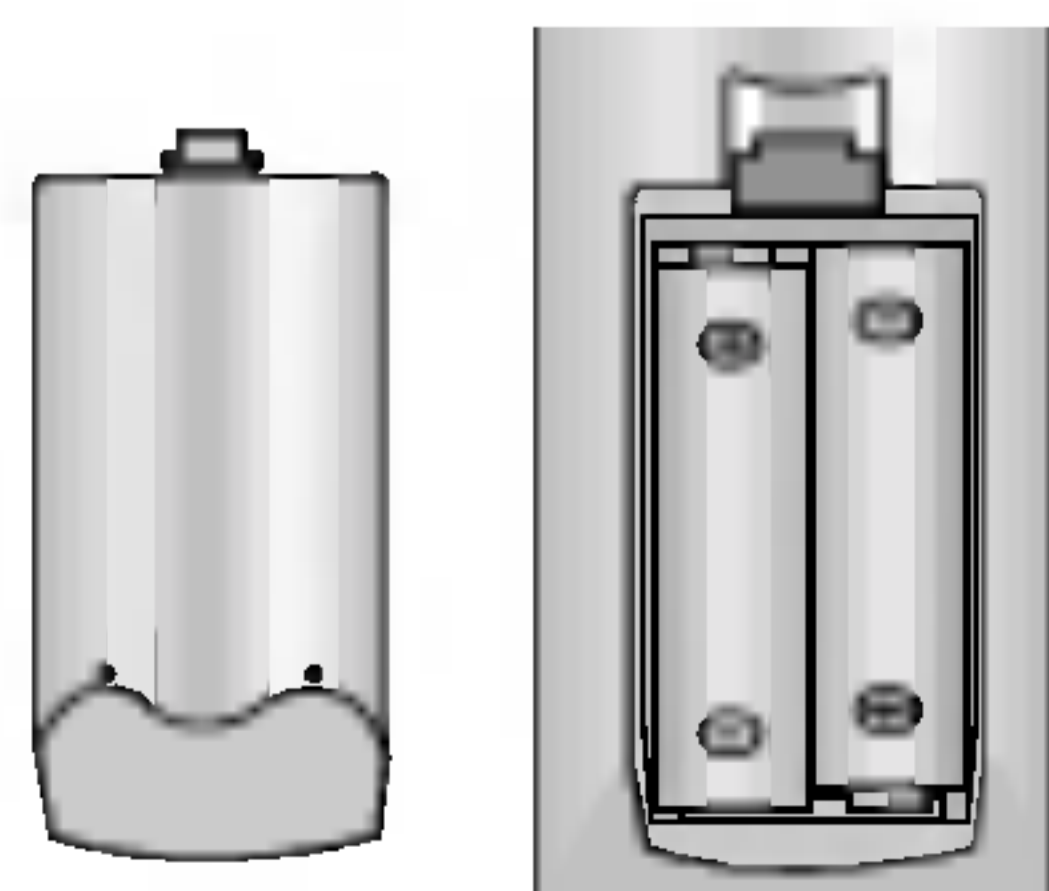

- Open the battery compartment cover on the back side and insert the batteries with correct polarity.
- Install two 1.5V alkaline batteries of AA type. Don't mix used batteries with new batteries.

Remote Control Key Functions

- When using the remote control aim it at the remote control sensor of the set.
- There's maybe a defect in consecutive operation of remote control in specified brightness according to this set feature.

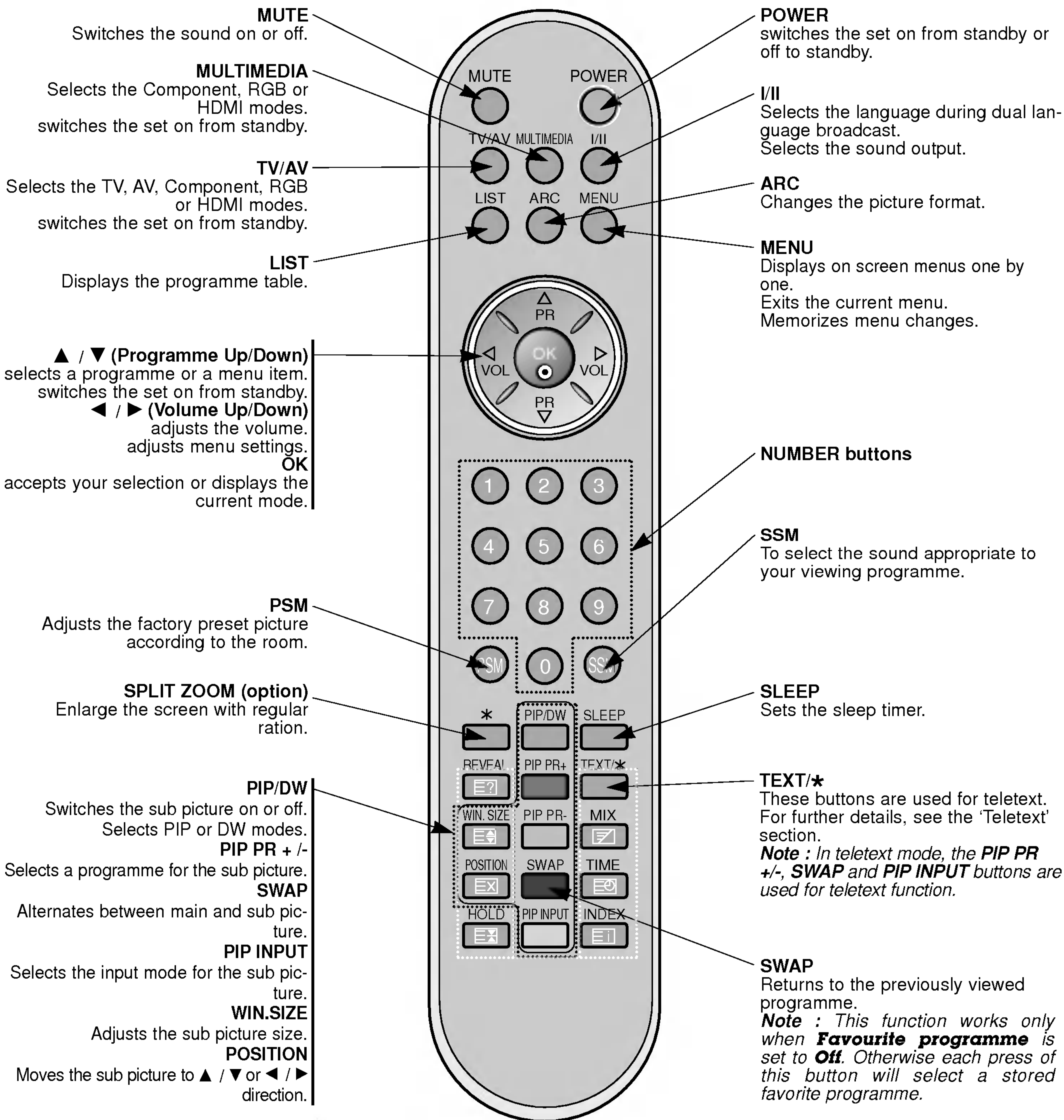

Installing Batteries

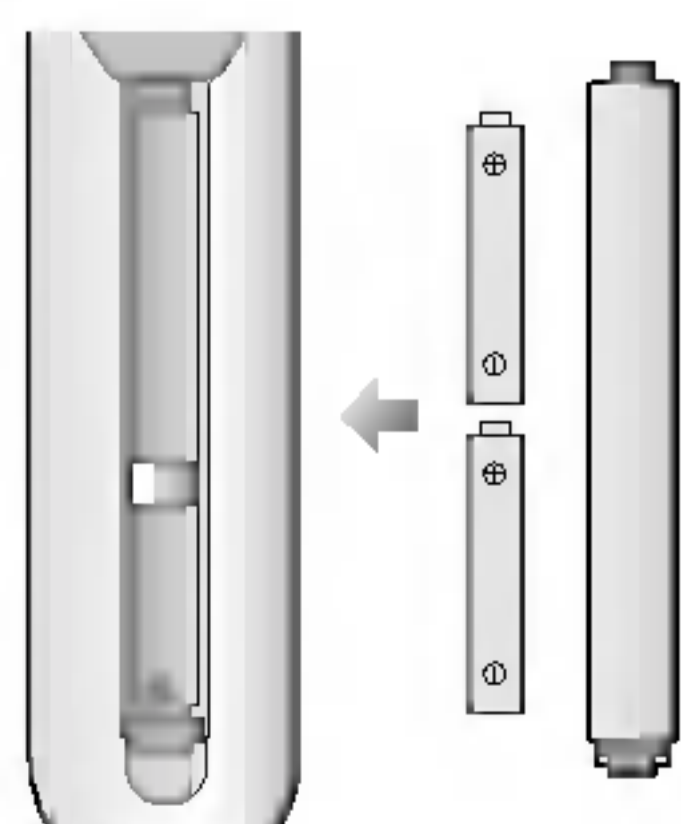

- Open the battery compartment cover on the back side and insert the batteries with correct polarity.
- Install two 1.5V alkaline batteries of AAA type. Don't mix used batteries with new batteries.

Location and Function of Controls

<Front Panel Controls>

42PX4R series

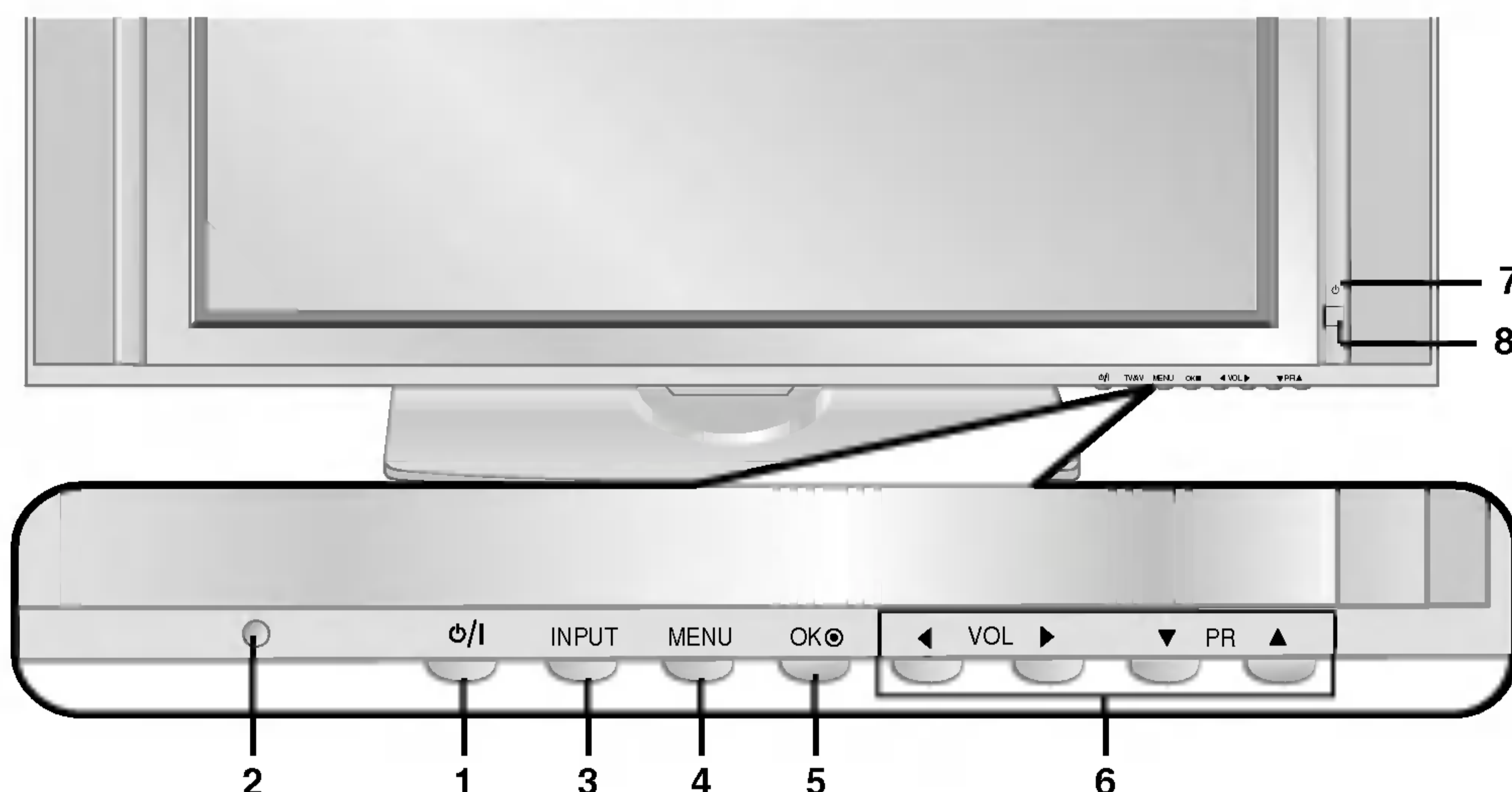

42PX3RV series

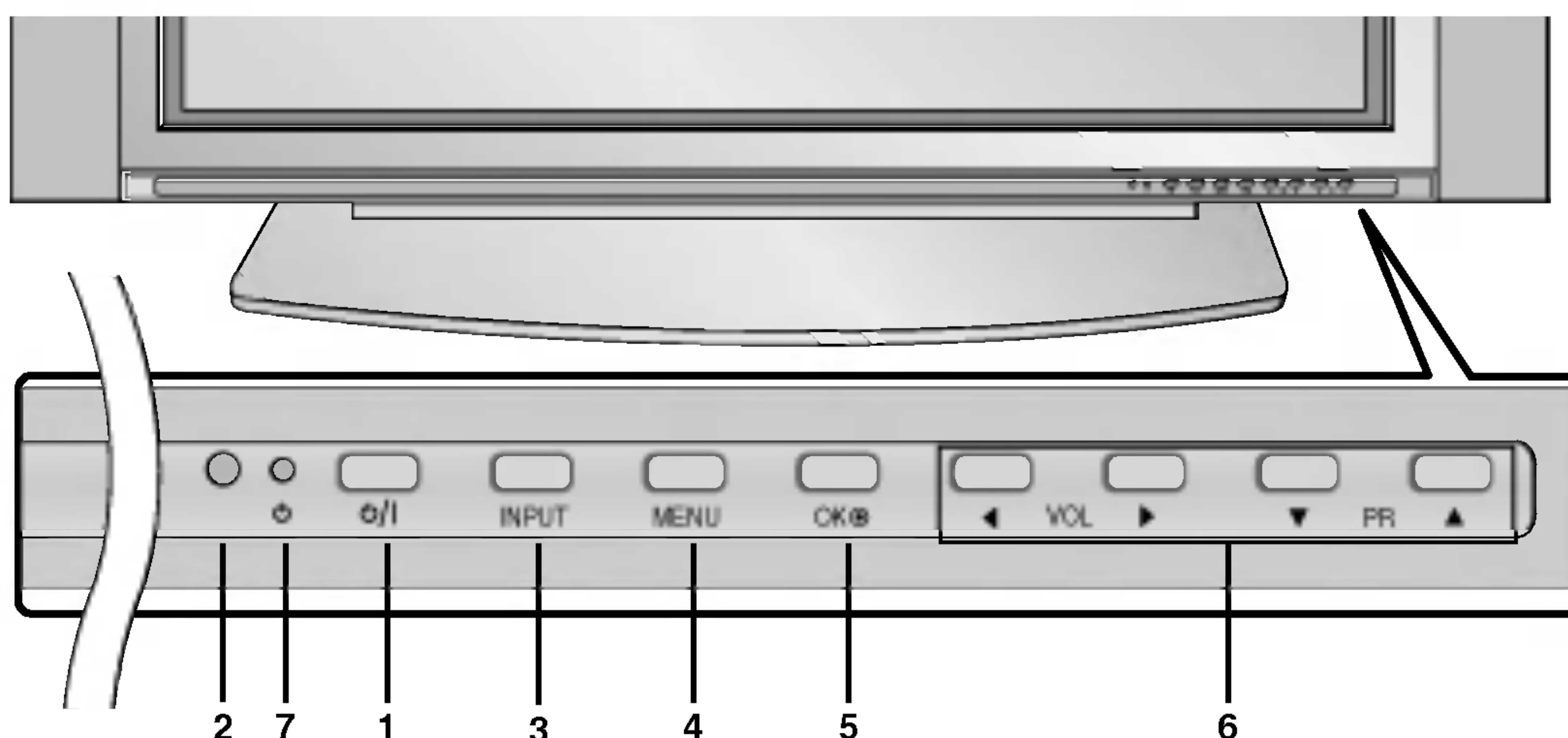

1. Power Button

Switches the set on from standby or off to standby.

2. Remote Control Sensor

3. INPUT or TV/AV Button

Selects the TV, AV, Component, RGB or HDMI modes.
Switches the set on from standby.

4. MENU

Displays on screen menus one by one.
Exits the current menu.
Memorizes menu changes.

5. OK

Accepts your selection or displays the current mode.

6. ▲ / ▼ (Programme Up/Down)

Selects a programme or a menu item.
Switches the set on from standby.

◀ / ▶ (Volume Up/Down)

Adjusts the volume.
Adjusts menu settings.

7. Power Indicator

Illuminates red in standby mode, Illuminates green when the set is turned on

8. Intelligent Eye (option)

Adjusts picture according to the surrounding conditions.

- Shown is a simplified representation of the set.
- What is shown here may be somewhat different from your set.
- This manual explains the features available on the 42PX4R series.

<Back Panel>

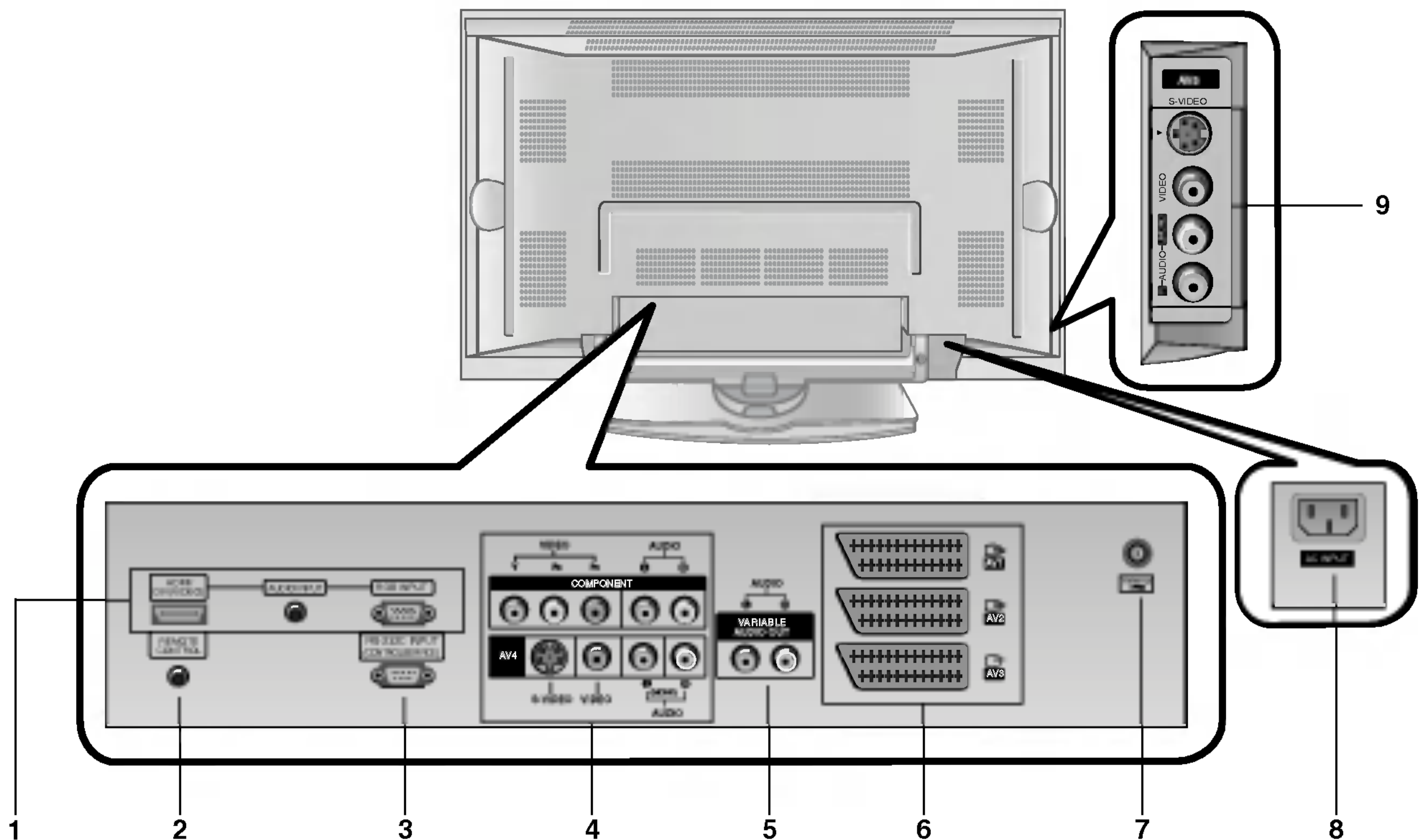

1. HDMI(DVI VIDEO) / AUDIO INPUT / RGB INPUT

Connect the monitor output socket of the PERSONAL COMPUTER, DVD or STB to this socket.

Note: If you want to use RGB/DVI audio, we strongly recommend that you use the cable that has a core, or the EMI Filter core along with separate cable.

2. REMOTE CONTROL

3. RS-232C INPUT(CONTROL/SERVICE) PORT

Connect to the RS-232C port on a PC.

4. COMPONENT INPUT

Connect DVD video outputs to Y, P_B, P_R of COMPONENT INPUT and audio outputs to Audio sockets of AUDIO INPUT.

AUDIO/VIDEO IN SOCKETS (AV4)

Connect the audio/video out sockets of external equipment to these sockets.

S-VIDEO/AUDIO IN SOCKETS

Connect the S-VIDEO out socket of an VCR to the S-VIDEO socket.

Connect the audio out sockets of the VCR to the audio sockets as in **AV4**.

5. VARIABLE AUDIO OUTPUT

6. EURO SCART SOCKET

Connect the euro scart socket of the VCR to these sockets.

Note:

a. If you want to use the EURO scart cable, you have to use the signal shielded Euro scart cable.

b. If the S-VIDEO(Y/C) signal is received through the Euro scart socket 2 (AV 2), you must change to the S-Video 2 (Y/C) mode.

7. ANTENNA INPUT

8. POWER CORD SOCKET

This Monitor operates on AC power. The voltage is indicated on the Specifications page. Never attempt to operate the set on DC power.

**9. AUDIO/VIDEO INPUT (AV5)
S-VIDEO/AUDIO IN SOCKETS**

External Equipment Viewing Setups

<Back Panel>

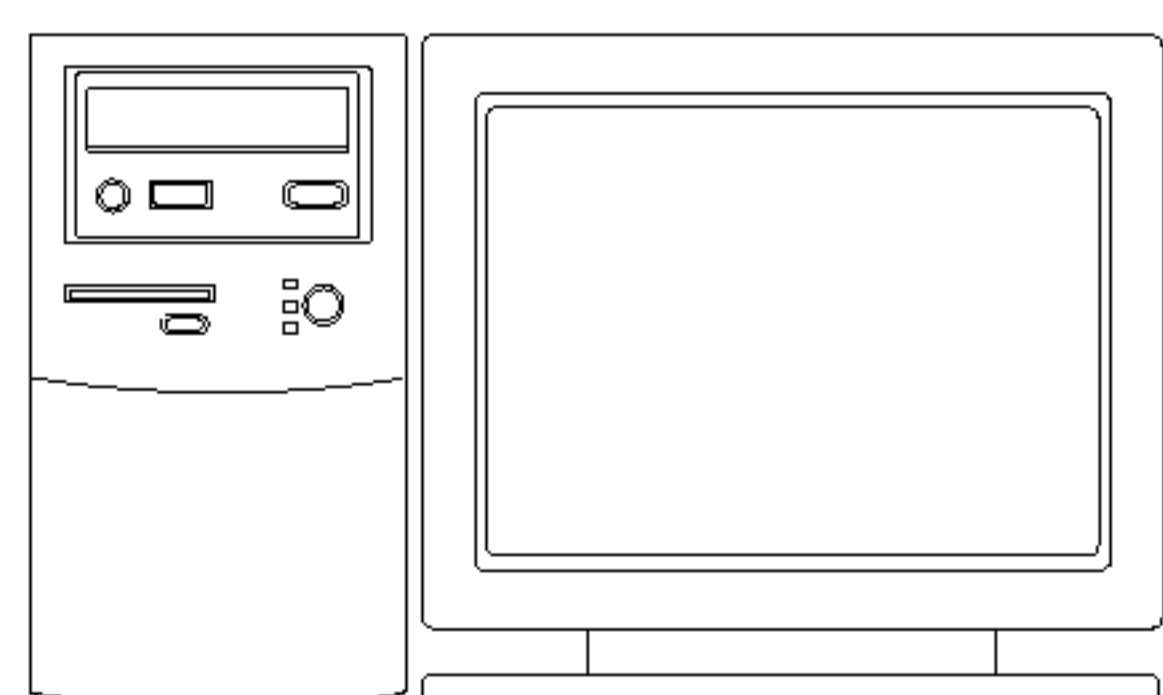
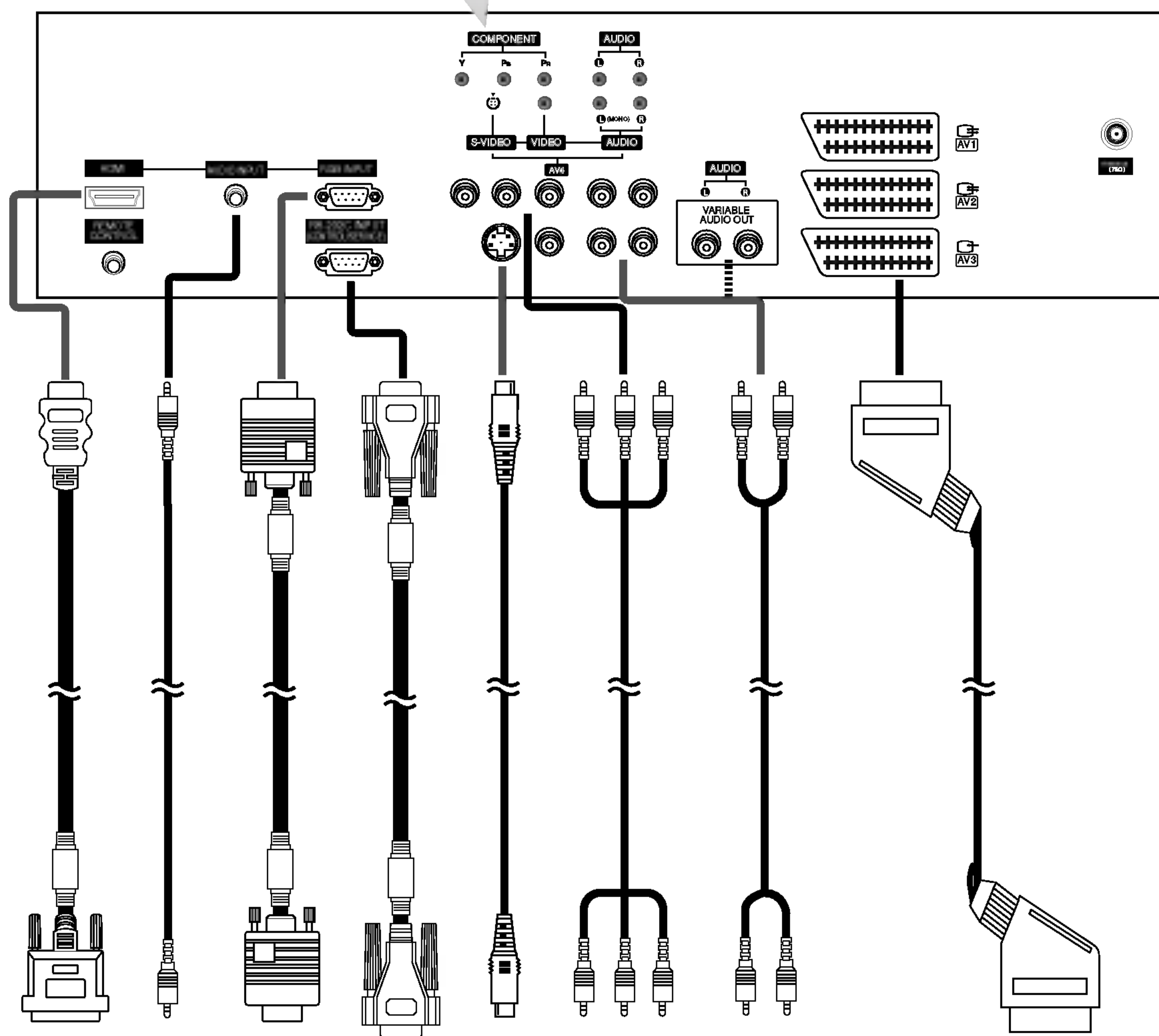
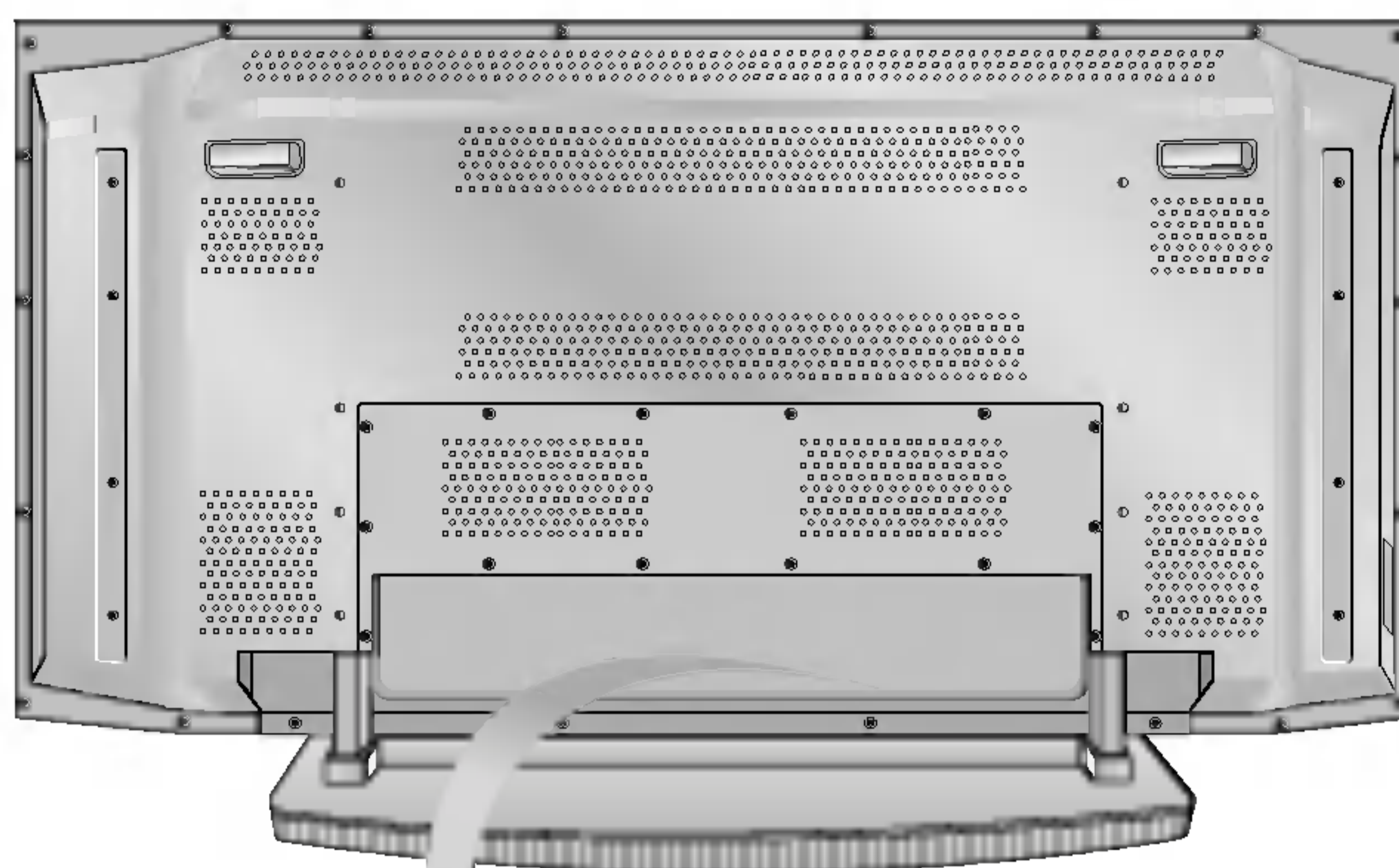

Connection to PC



Connection to AV equipment

Displayable Monitor Specification

RGB / HDMI mode

Resolution	Horizontal Frequency(KHz)	Vertical Frequency(Hz)
640x350	31.468	70.09
	37.861	85.08
720x400	31.469	70.08
	37.927	85.03
640x480	31.469	59.94
	35.000	66.66
	37.861	72.80
	37.500	75.00
	43.269	85.00
848x480	31.500	60.00
	37.799	70.00
	39.375	75.00
852x480	31.500	60.00
	37.799	70.00
	39.375	75.00
800x600	35.156	56.25
	37.879	60.31
	48.077	72.18
	46.875	75.00
	53.674	85.06
832x624	49.725	74.55
1024x768	48.363	60.00
	56.476	70.06
	60.023	75.02
	68.677	85.00
1152x864	54.348	60.05
	63.995	70.01
	67.500	75.00
1152x870	68.681	75.06
1280x960	60.023	60.02
1280x1024	63.981	60.02

42PX3RV series
42PX4RV series

• **Component/HDMI Input signal**

Mode	Terminal	Component	RGB (DTV)	HDMI (DTV)
480i		o	x	x
576i		o	x	x
480p		o	o	o
576p		o	o	o
720p		o	o	o
1080i		o	o	o

RGB / HDMI mode

Resolution	Horizontal Frequency(KHz)	Vertical Frequency(Hz)
640x350	31.468	70.09
	37.861	85.08
720x400	31.469	70.08
	37.927	85.03
640x480	31.469	59.94
	35.000	66.66
	37.861	72.80
	37.500	75.00
	43.269	85.00
848x480	31.500	60.00
	37.799	70.00
	39.375	75.00
852x480	31.500	60.00
	37.799	70.00
	39.375	75.00
800x600	35.156	56.25 (RGB)
	37.879	60.31
	48.077	72.18
	46.875	75.00
	53.674	85.06
832x624	49.725	74.55
1024x768	48.363	60.00
	56.476	70.06
	60.023	75.02
	68.677	85.00
1360x768	47.700	60.00
	59.625	75.02
	68.500	85.00
1366x768	47.700	60.00
	59.625	75.02
	69.500	85.00
1152x864	54.348	60.05
	63.995	70.01
	67.500	75.00
1152x870	68.681	75.06
	77.487	85.00
	1280x768	47.693
60.091		75.00
68.504		85.00
1280x960	60.023	60.02
1280x1024	63.981	60.02

42PX4R series



- HDMI™, the HDMI logo and High-Definition Multimedia Interface are trademarks or registered trademarks of HDMI Licensing.
- This set can receive the High-Definition Multimedia Interface (HDMI) or Input of Digital Visual Interface(DVI).
- This set supports HDCP (High-bandwidth Digital Contents Protection) Protocol for the set (480p, 720p, 1080i) modes.
- When you connect to HDMI/DVI Source devices (DVD Player, STB or PC) that support AUTO HDMI/DVI Plug & Play, this sets the HDMI/DVI source devices automatically. (640 x 480p) (or 42PX4R series : 1280 x 720p).
After reading HDMI/DVI source devices, using Display Data Channel (DDC) Protocol, Extended Display Identification Data (EDID) stored in the set is used.
If HDMI/DVI Source devices do not support AUTO HDMI/DVI, the resolution is set manually.
- To get the best picture quality, adjust the DVD Player or Set Top Box output resolution to (640 x 480p) (or 42PX4R series : 1280 x 720p).
- To get the best picture quality, adjust the PC graphics card to (640 x 480) (or 42PX4R series : 1024 x 768), 60Hz.
- When Source Devices have DVI Output Connector, you must connect audio with separated cable.(Refer to <How to connect>)

How to connect

1. When Source Devices (DVD Player or Set Top Box) support HDMI.
 - If Source Devices have HDMI Output Connector, Source Devices connect to the set with HDMI Cable .(not supplied with the product).
 - If Source Devices support Auto HDMI, automatically, Source Devices divert output resolution in (640 x 480p) (or 42PX4R series : 1280 x 720p). But if not, resolution divert Manually Setting for reference Manual of Source Devices.
 - To get the best picture quality, adjust the DVD Player or Set Top Box output resolution to (640 x 480p) (or 42PX4R series : 1280 x 720p).
 - Because HDMI sends Digital Video and Audio with one cable, there is no need for Audio Cable when using HDMI Cable.
2. When Source Devices (DVD Player or Set Top Box) supports DVI.
 - If Source Devices have DVI Output Connector, Source Devices connect to the set with HDMI to DVI Cable (not supplied with the product).
 - If Source Devices support Auto DVI, automatically, Source Devices divert output resolution in (640 x 480p) (or 42PX4R series : 1280 x 720p). But if not, resolution divert Manually Setting for reference Manual of Source Devices.
 - To get the best picture quality, adjust the DVD Player or Set Top Box output resolution to (640 x 480p) (or 42PX4R series : 1280 x 720p).
 - In this case, Audio use other cable. When Source Devices have Analog Audio Output Connector, RGB/DVI Audio Input of the set connect to Audio Cable (not supplied with the product). And then you can listen to normal Audio.
3. When PC supports DVI.
 - If PC has a DVI Output Connector, Source Devices connect to the set with HDMI to DVI Cable (not supplied with the product).
 - To get the best picture quality, adjust the PC graphics card to (640 x 480) (or 42PX4R series : 1024 x 768), 60Hz.
 - Use the the set's HDMI/DVI (VIDEO) for video connections, depending on your PC connector.
 - If the graphics card on the PC does not output analog RGB and DVI simultaneously, connect only one of either RGB Input or HDMI/DVI Input to display the PC on the set.
 - If the graphics card on the PC does output analog RGB and DVI simultaneously, the set to either RGB Input or HDMI/DVI Input;

- (the other mode is set to Plug and Play automatically by the set.)
- Then, make the corresponding audio connections. If using a sound card, adjust the PC sound as required.
 - In this case, Audio use other cable. When PC (or sound card of PC) have Analog Audio Output Connector, RGB/DVI Audio Input of the set connect to Analog Audio Cable (not supplied with the product). And then you can listen to normal Audio.

Reference

Cable sample (not supplied with the product)

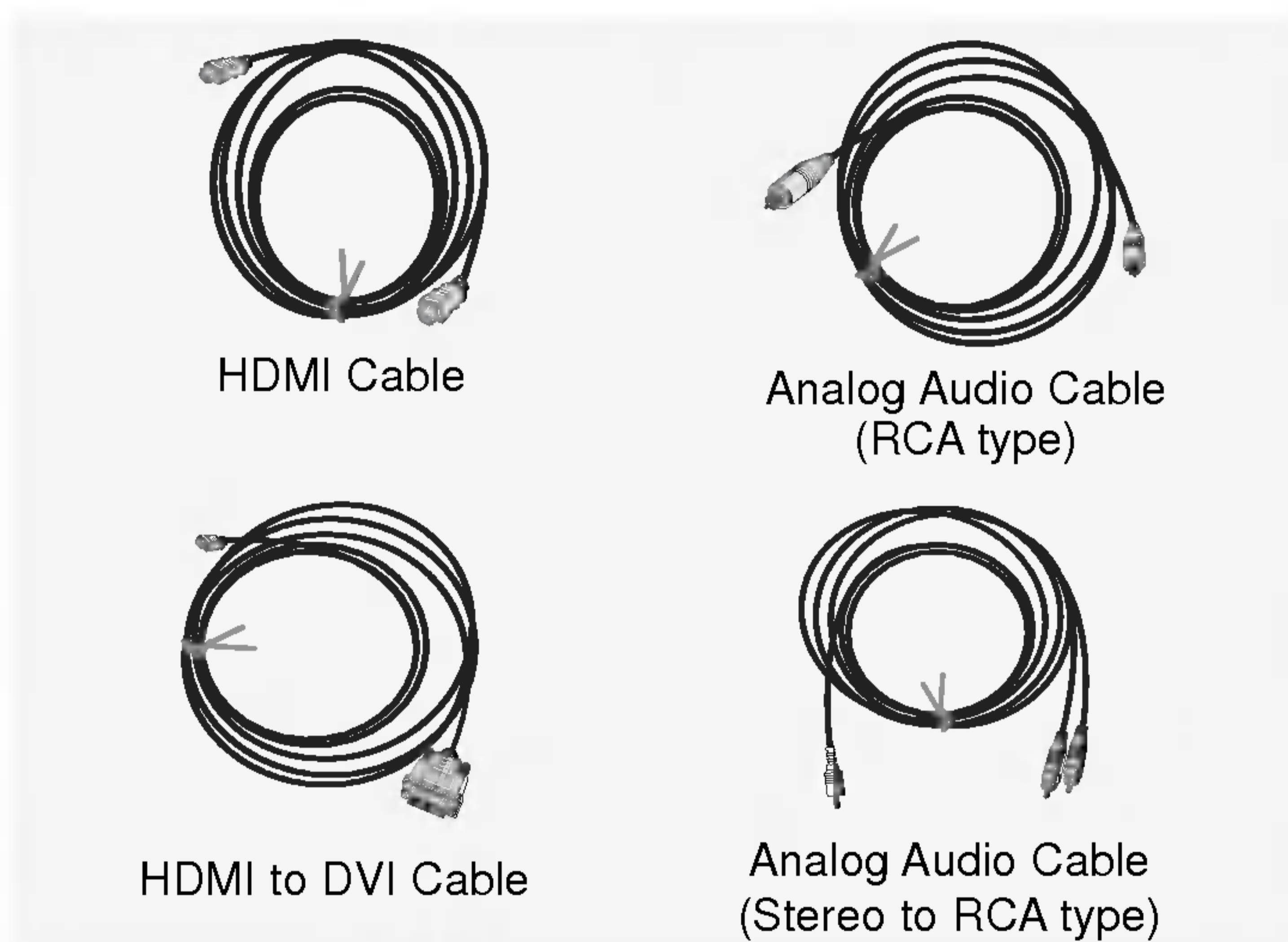

How to use

1. Connect the HDMI/DVI Source Devices(DVD Player or Set Top Box or PC) and the set.
2. Turn on the display by pressing the POWER button on the set and HDMI/DVI Source Devices remote control.
3. Select HDMI/DVI Input source in Main Input option of PIP/DW menu.
4. Check the image on your set. There may be noise associated with the resolution, vertical pattern, contrast or brightness in HDMI/DVI Source Devices. If noise is present, change the HDMI/DVI Source Devices to another resolution, change the refresh rate or adjust the brightness and contrast on the menu until the picture is clear. If the refresh rate of the PC graphics card can not changed, change the PC graphics card or consult the manufacturer of the PC graphics card.

Notes:

- Depending on the graphics card, DOS mode may not work if you use a HDMI to DVI Cable.
- Avoid keeping a fixed image on the set screen for a long period of time. The fixed image may become permanently imprinted on the screen. Use the Orbiter screen saver when possible.
- When Source Devices connected HDMI/DVI Input, output PC Resolution(VGA, SVGA, XGA), Position, Size may not fit to Screen. As shown the lower picture, press the **MENU** button to adjust the screen Position of the set and contact an PC graphics card service center.
- When Source Devices connected HDMI/DVI Input output the set Resolution(480p, 720p, 1080i), the set Display fit EIA/CEA-861-B Specification to Screen. If not, refer to the Manual of HDMI/DVI Source Devices or contact your service center.
- In case of HDMI/DVI Source Devices are not connected, Cable or poor cable connection, "No Signal" OSD display in HDMI/DVI Input. And In case of Video Resolution not supported when output is HDMI/DVI Source Devices, "No Signal" OSD display. Refer to the Manual of HDMI/DVI Source Devices or contact your service center.

Accessories

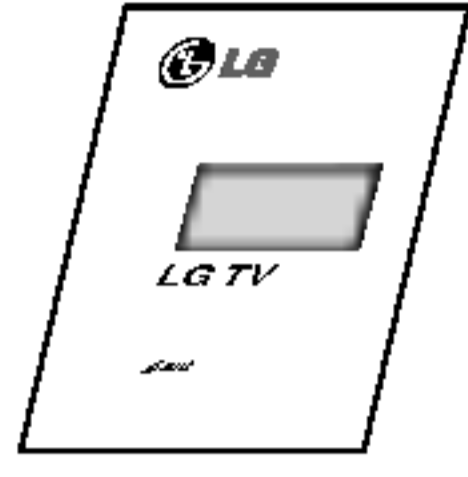

Owner's Manual



or



Remote Control handset



2-Eye Bolts

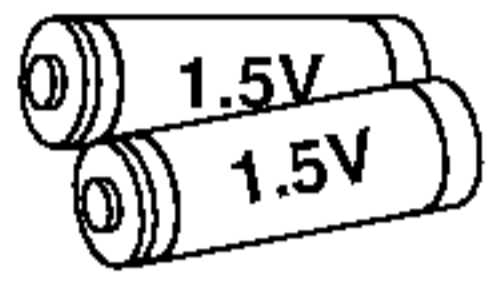

Alkaline batteries

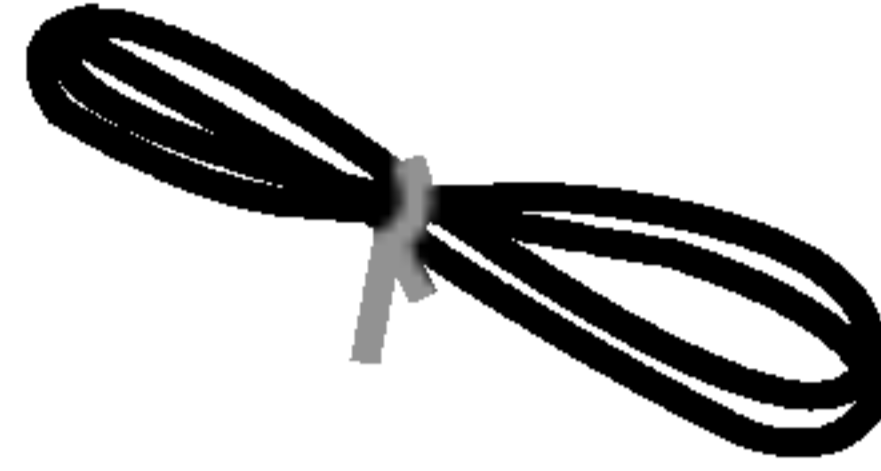

Power Cord



2-Wall brackets

Fixing the set assembly to the wall to protect the set tumbling

- Secure the set assembly by fixing it to a wall by using the Eye Bolts/Wall brackets.

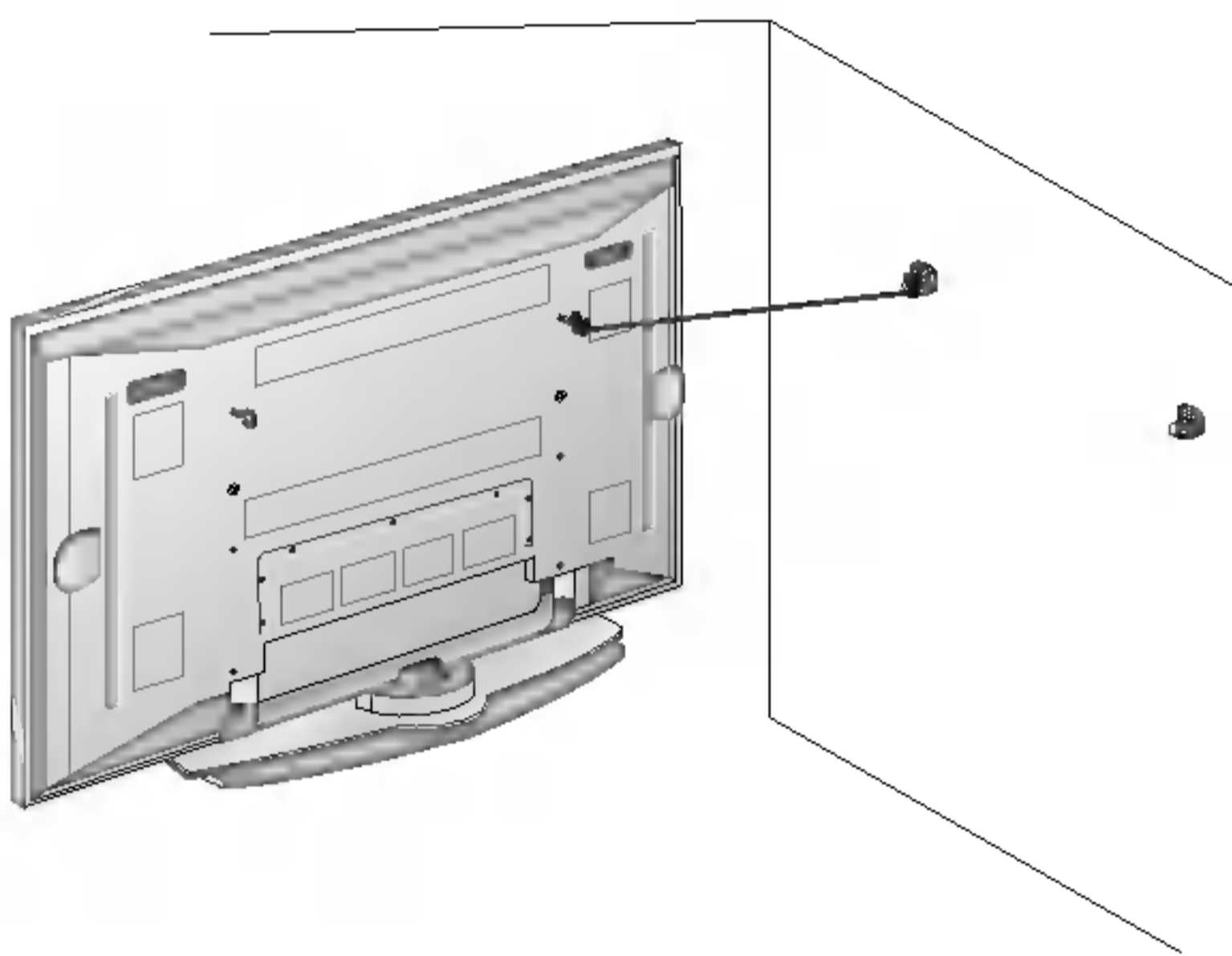

- If the set is mounted on a desk top, insert the 2 Eye-Bolts and tighten them securely in the upper holes as shown. Insert the 2 Eye Bolts and tighten securely, in the holes on the bracket. Install the wall brackets on the wall with 2 bolts, (not supplied with the product), as shown. Match the height of the Eye Bolts and the wall brackets. Check to be sure the brackets are tightened securely.

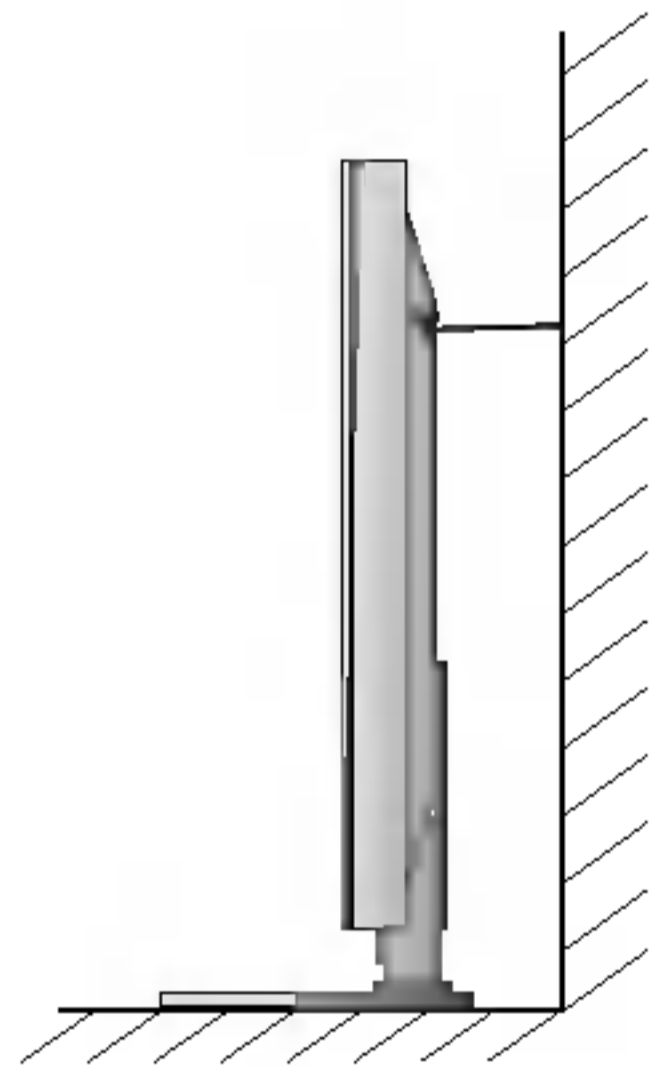

- Secure the set assembly to the wall with strong strings or wound wire cables, (not supplied with the product), as shown.

Optional Extras

- Optional extras can be changed or modified for quality improvement. Without any notification new optional extras can be added.
- Contract your dealer for buying these items.

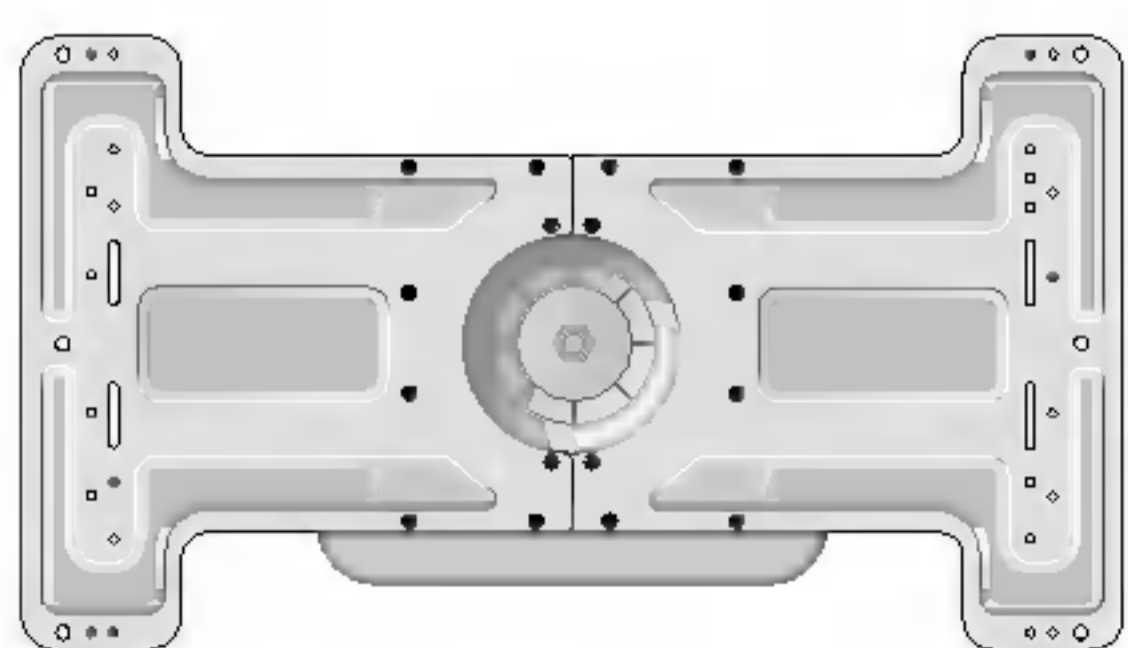

Tilt wall mounting bracket



Ceiling mounting bracket

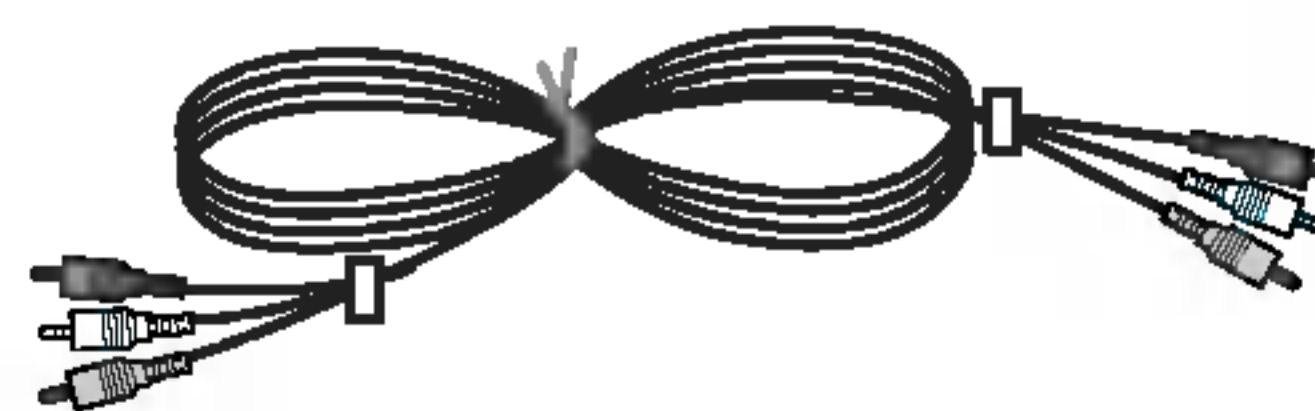

Video cables

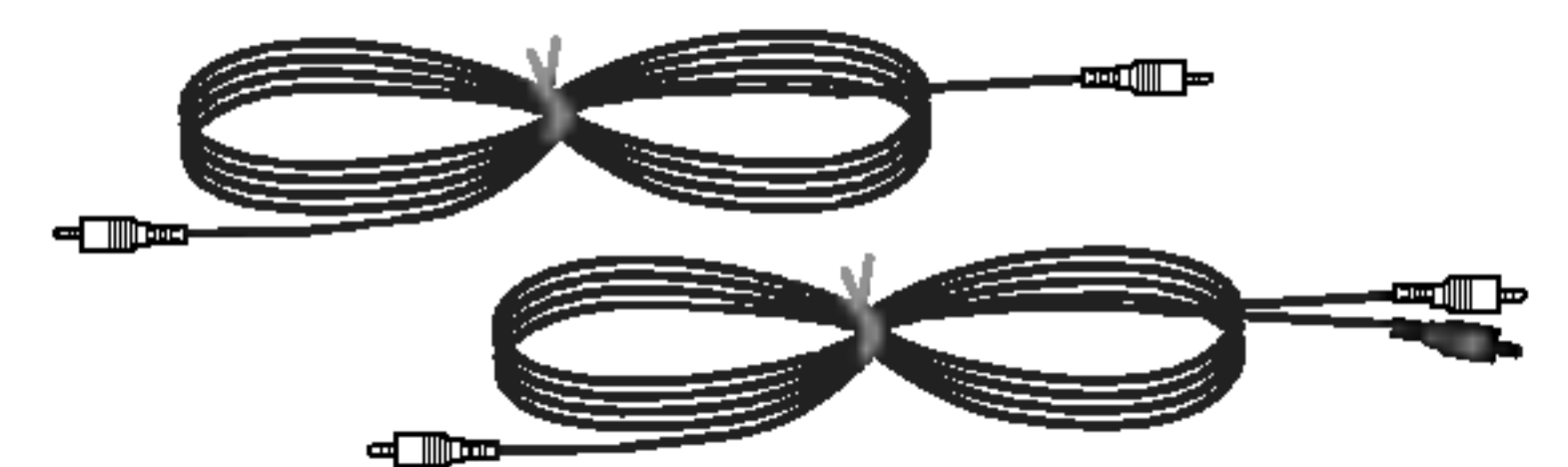

Audio cables

Installation Options

- The set can be installed in different ways such as on a wall, or on a desktop etc.
- Install this set only in a location where adequate ventilation is available.

Wall Mount: Horizontal Installation

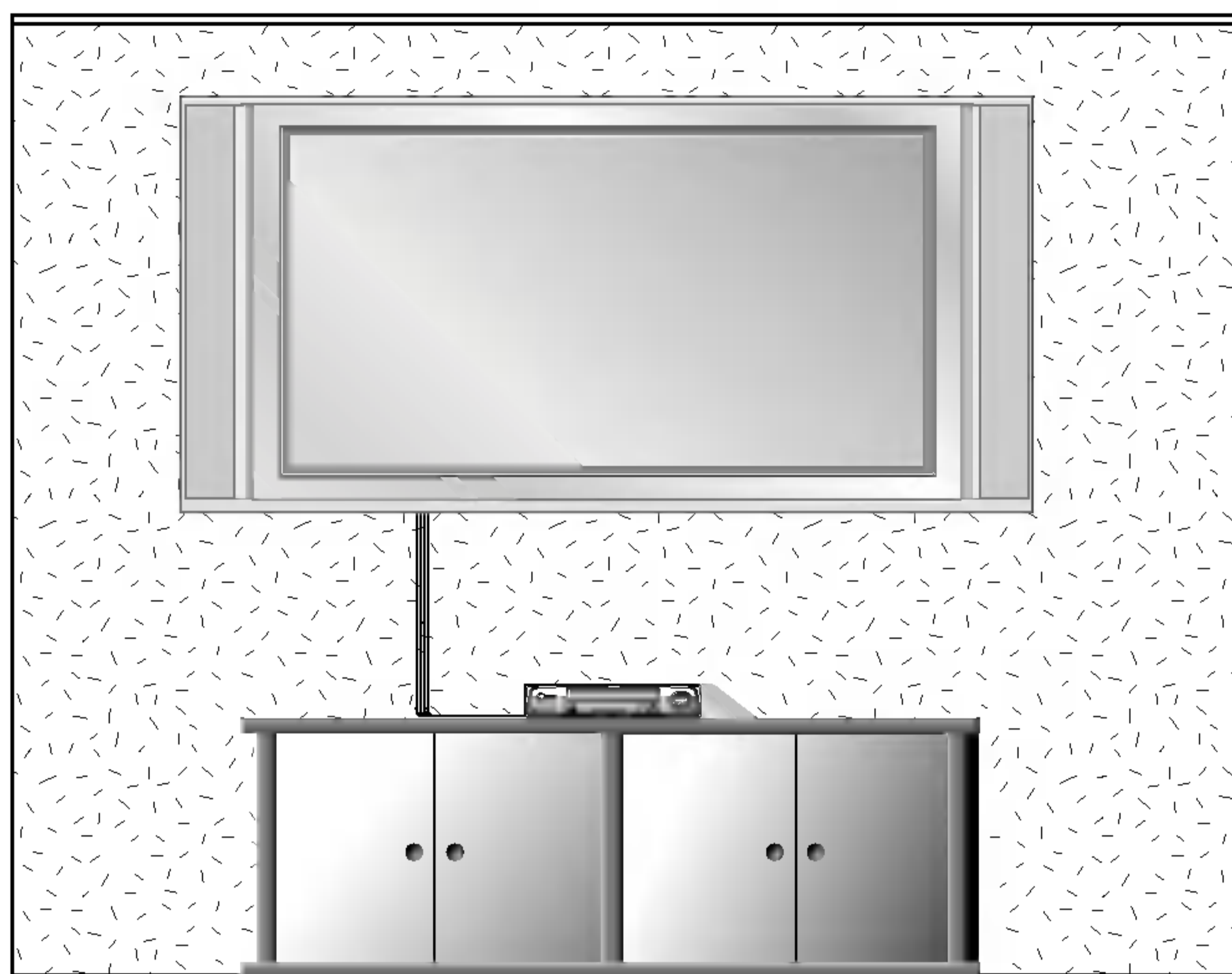

- The set can be installed on a wall as shown above. (For further information, refer to the optional 'Wall Mounting Bracket Installation and Setup Guide'.)

To Mount on a Wall

Wall mount minimum allowable clearances for adequate ventilation.

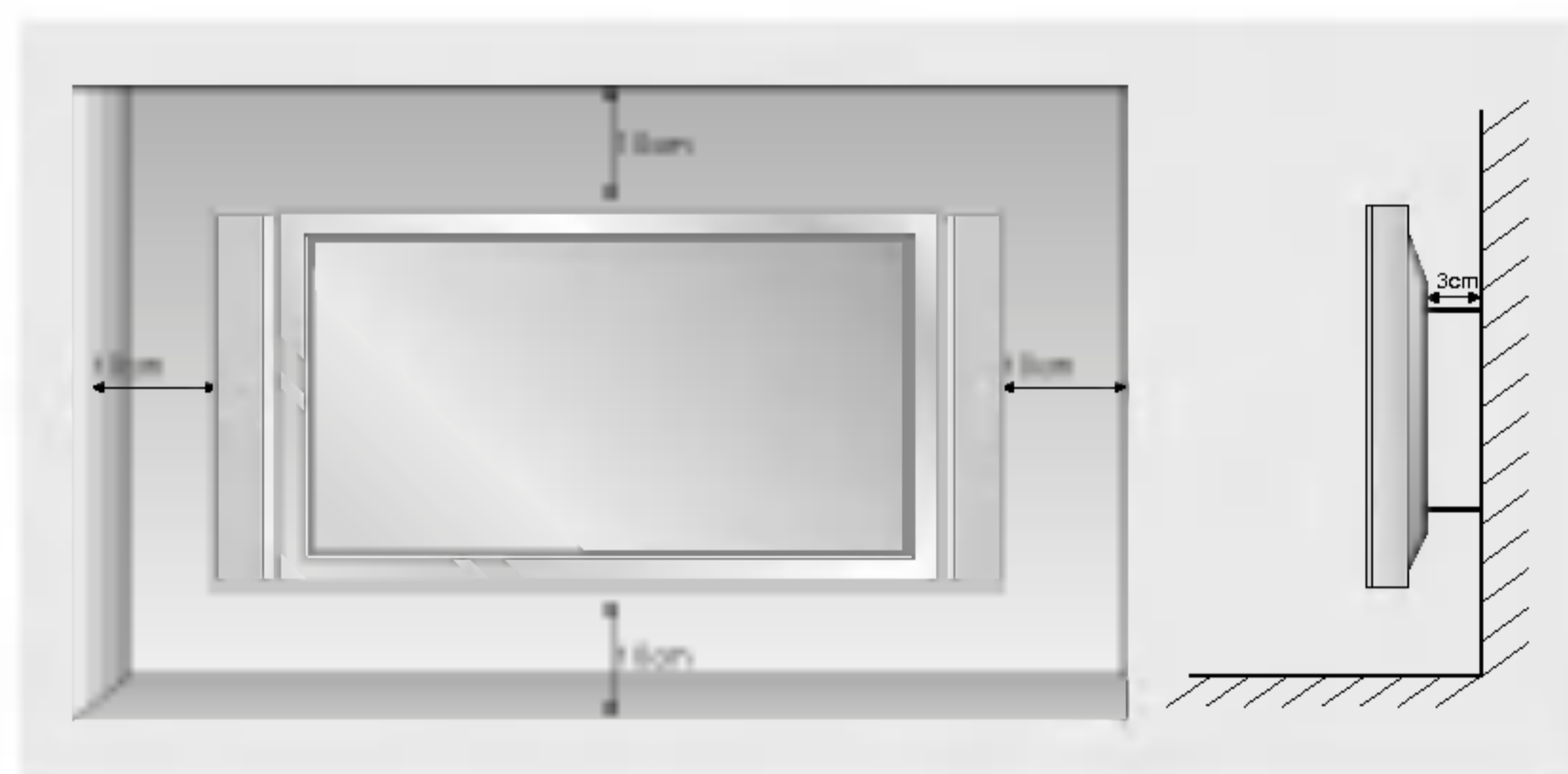

Desktop Pedestal Installation



- The set can be mounted on a desk as shown above.

To Install on a Desktop

Pedestal mount minimum allowable clearances for adequate ventilation.

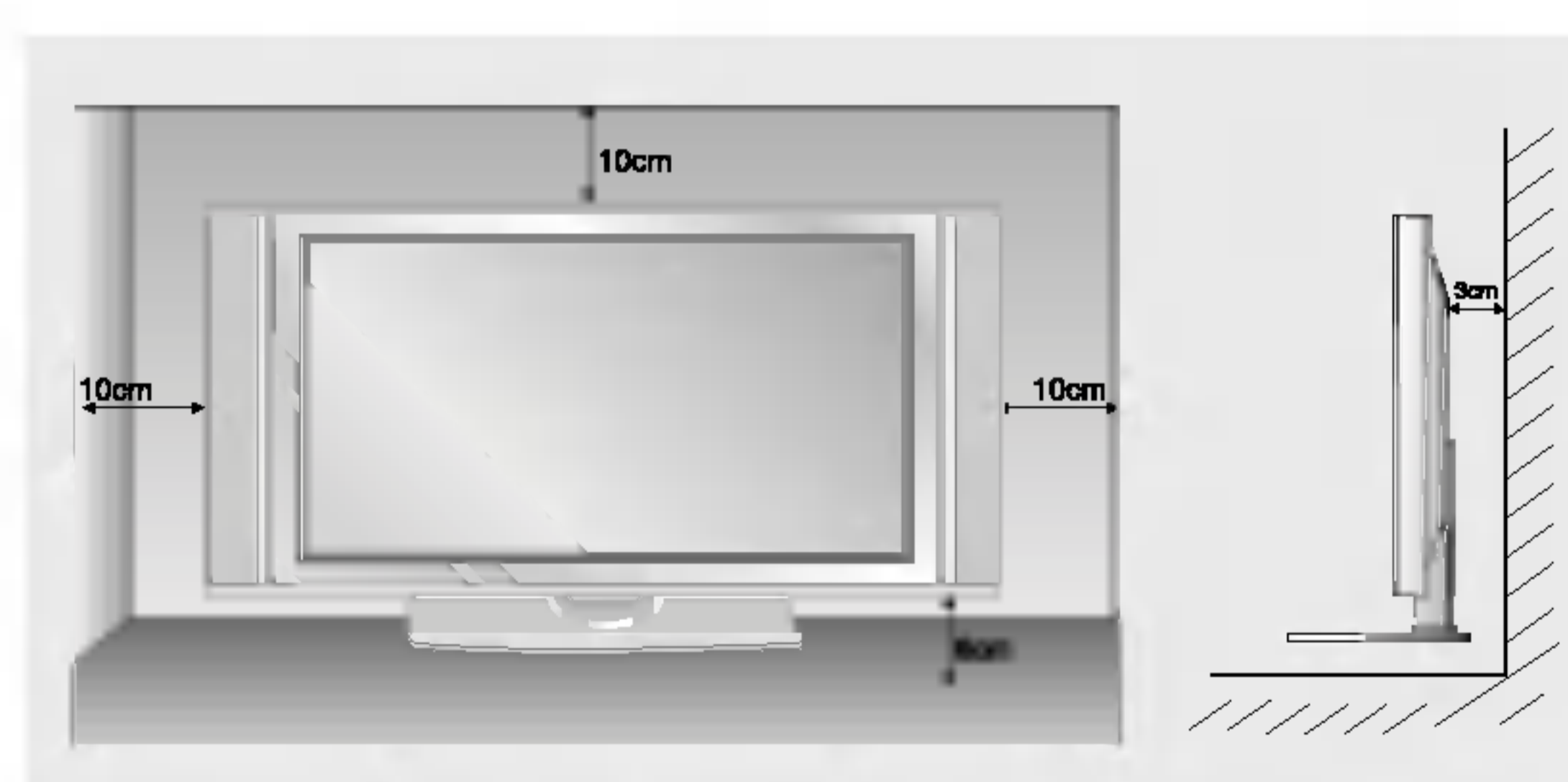

Swivel function (option)

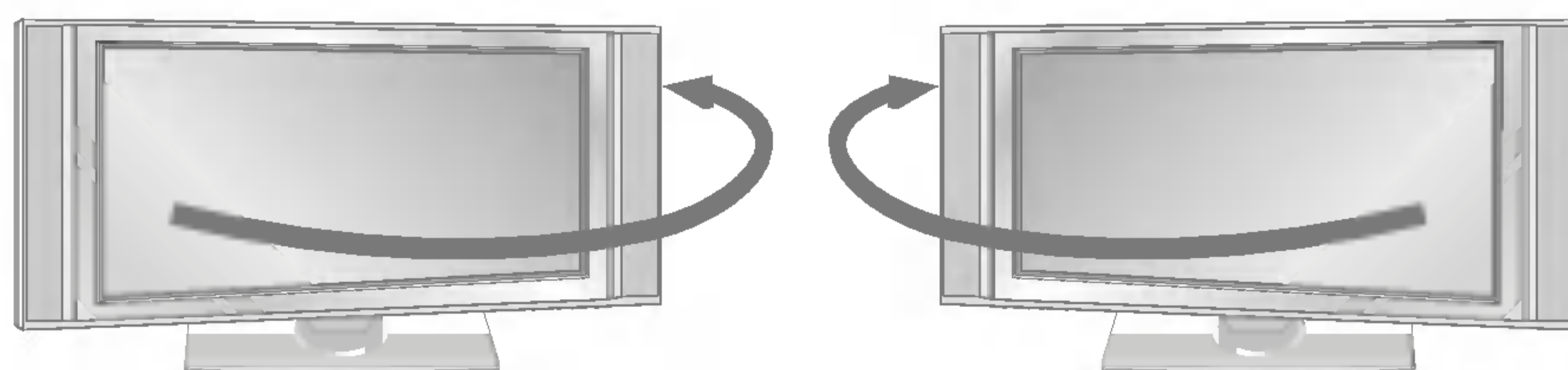

- After installing the set, you can adjust the the set manually to the left or right direction by 20 degrees to suit your viewing position.

Note : Before adjusting the angle, you must loosen (to the left) the shaft bolt on the middle of stand's back. And when stand be level with set, you must close (to the right) the shaft bolt to set the hole.

Turning on the Set

- When using the remote control, aim it at its sensor on the set.

Turning on the set just after installation

1. Connect power cord correctly, the set is switched to standby mode.
2. Press the \odot / I, **INPUT** or **TV/AV** or **PR ▲** / ▼ button on the set or press the **POWER**, **INPUT** or **TV/AV**, **MULTIMEDIA**, **PR ▲** / ▼ or **NUMBER** buttons on the remote control and then the set will switch on.

Turning on the set (power cord is still connected)

If the set was turned off with the remote control power button and the \odot / I button on the set

- Press the \odot / I, **INPUT** or **TV/AV** or **PR ▲** / ▼ button on the set or press the **POWER**, **INPUT** or **TV/AV**, **MULTIMEDIA**, **PR ▲** / ▼ or **NUMBER** button on the remote control to turn the set on.

On-Screen Menu Language Selection (option)

- The menus can be shown on the screen in the selected language. First select your language.
 1. Press the **MENU** button and then use **▲** / ▼ button to select the **SPECIAL** menu.
 2. Press the **▶** button and then use **▲** / ▼ button to select **Language**.
 3. Press the **▶** button and then use **▲** / ▼ button to select your desired language.
From this point on, the on-screen menus will be shown in the language of your choice.
 4. Repeatedly press the **MENU** button to return to normal TV viewing.

On screen menus

- The dialogue between you and your set takes place on screen with an operator menu. The buttons required for the operating steps are also displayed.

Menu selection

1. Press the **MENU** button and then **▲ / ▼** button to display each menu.
2. Press the **▶** button and then the **◀ / ▶** button to select a menu item.
3. Repeatedly press the **MENU** button to return to normal TV viewing.



STATION menu

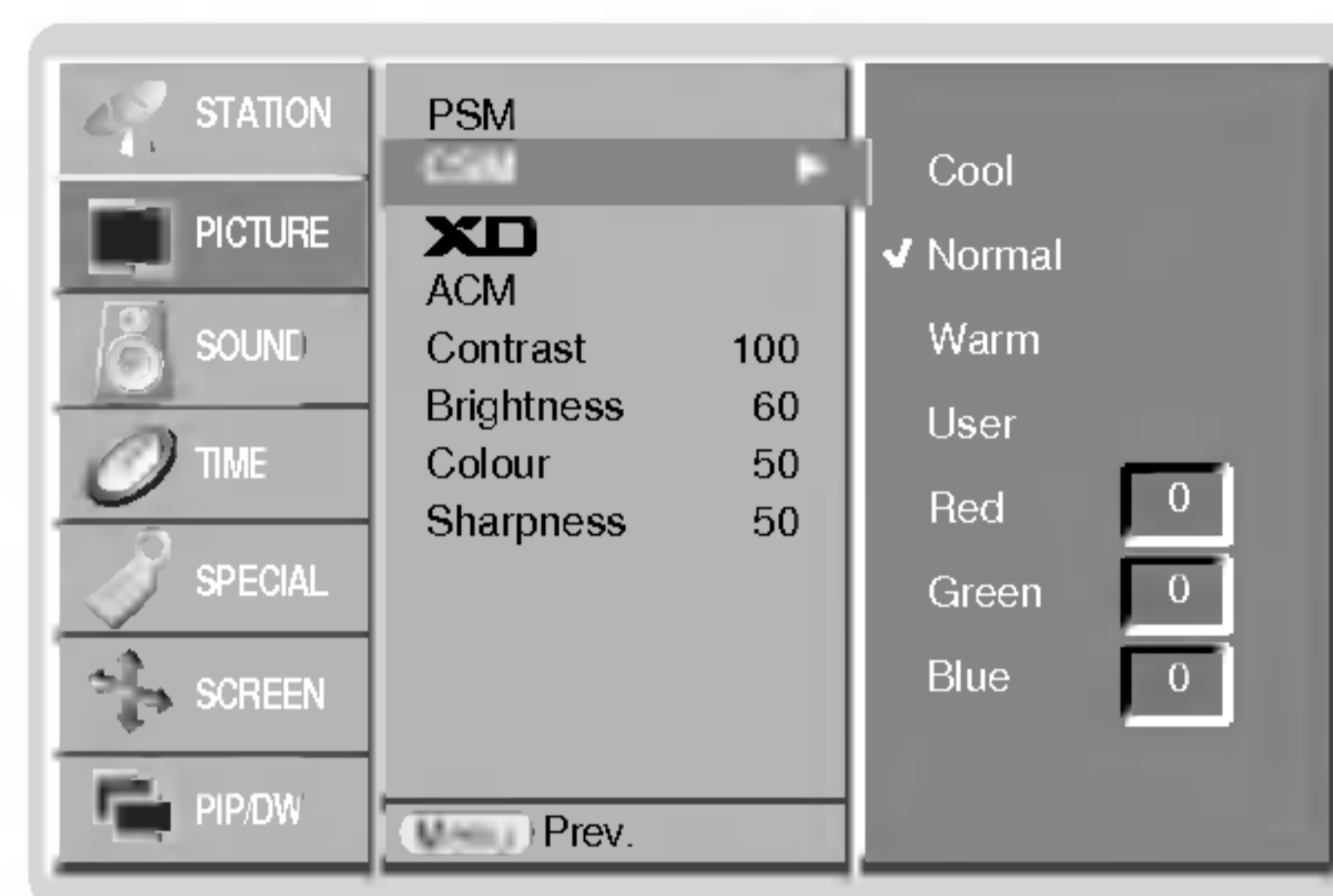

PICTURE menu



SCREEN menu

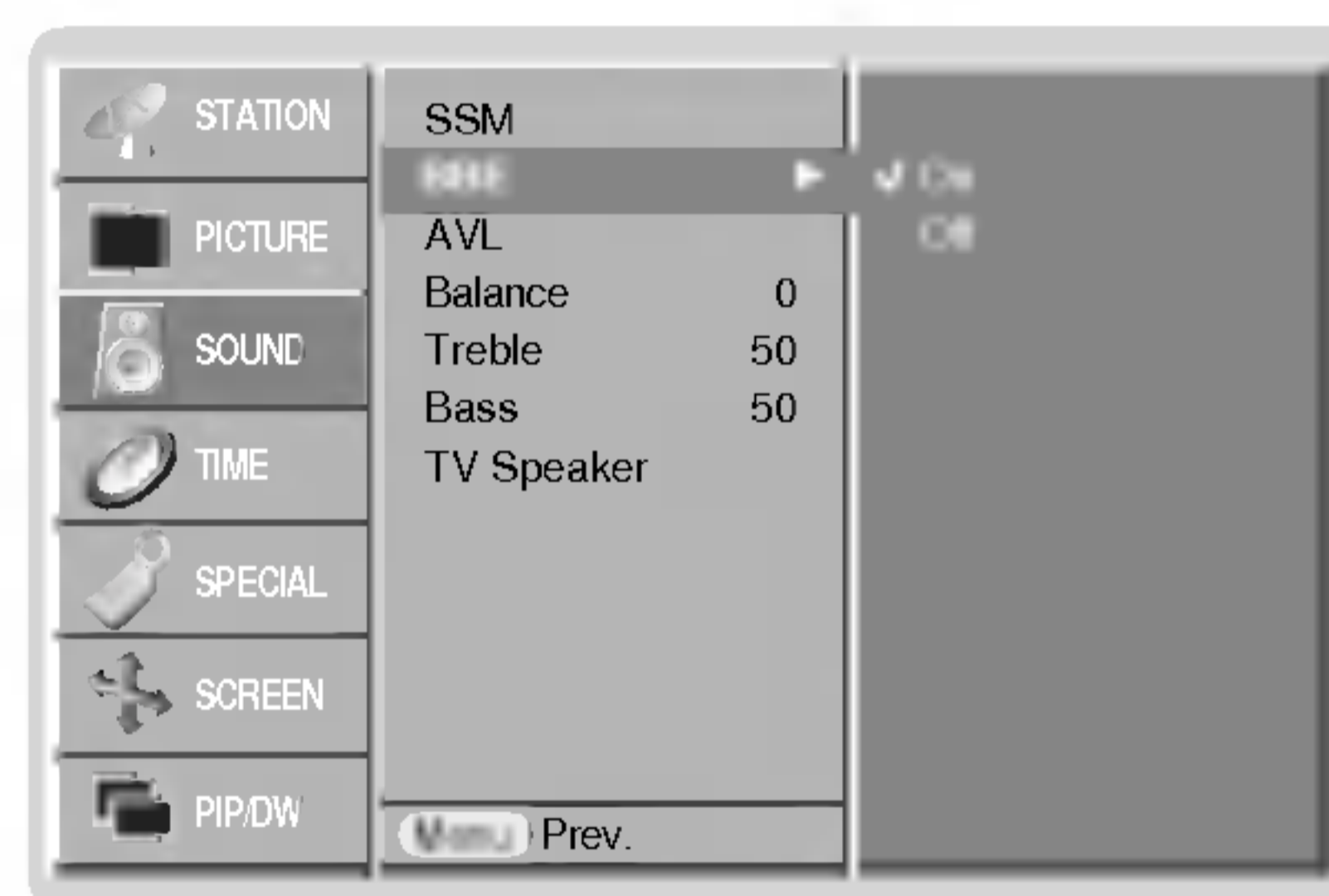

SOUND menu

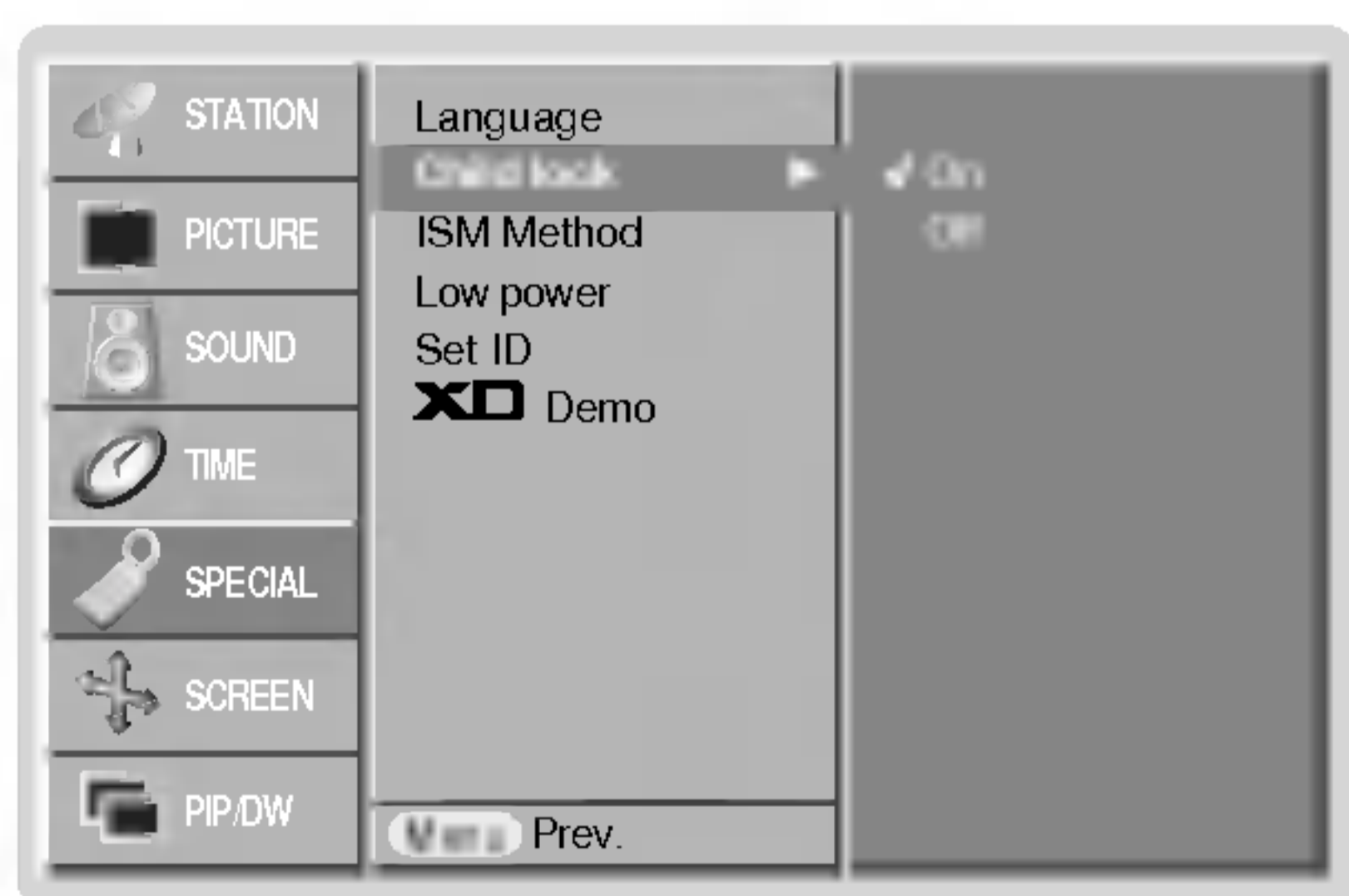

SPECIAL menu



TIME menu

Channel Menu Options

Auto Programme Tuning

- All stations that can be received are stored by this method. It is recommended that you use auto programme during installation of this set.

1. Press the **MENU** button and then use **▲ / ▼** button to select the STATION menu.

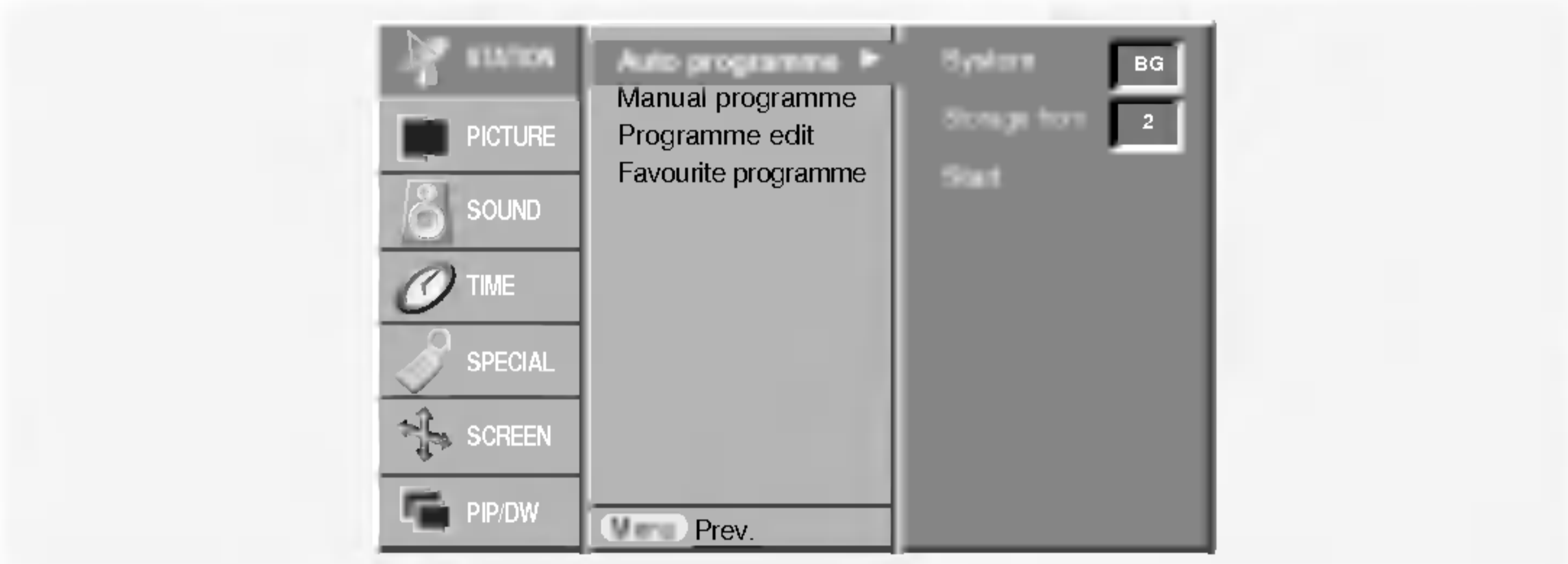

2. Press the **▶** button and then **▲ / ▼** button to select **Auto programme**.
3. Press the **▶** button to select **System**. Select a TV system with the **◀ / ▶** button;
 - L** : SECAM L/L' (option)
 - BG** : PAL B/G, SECAM B/G (Europe / East Europe / Asia / New Zealand / M.East / Africa / Australia)
 - I** : PAL I/II (U.K. / Ireland / Hong Kong / South Africa)
 - DK** : PAL D/K, SECAM D/K (East Europe / China / Africa / CIS)
 - M** : (USA / Korea / Philippines) (option)
4. Press the **▼** button to select **Storage from**. Select the beginning programme number with the **◀ / ▶** button or NUMBER buttons on the **Storage from** menu.
5. Press the **▼** button to select **Start**.
6. Press the **▶** button to begin auto programming. All receivable stations are stored.

Note : In some models, the station name is stored for stations which broadcast VPS (Video Programme Service), PDC (Programme Delivery Control) or TELETEXT data. If no station name can be assigned to a station, the channel number is assigned and stored as **C** (V/UHF 01-69) or **S** (Cable 01-47), followed by a number.

To stop auto programming, press the **MENU** button.

When auto programming is completed, the **Programme edit** menu appears on the screen. See the 'Programme edit' section to edit the stored programme.

Manual Programme Tuning

- Manual programme lets you manually tune and arrange the stations in whatever order you desire. Also you can assign a station name with five characters to each programme number.

1. Press the **MENU** button and then use **▲ / ▼** button to select the STATION menu.
2. Press the **▶** button and then **▲ / ▼** button to select **Manual programme**.

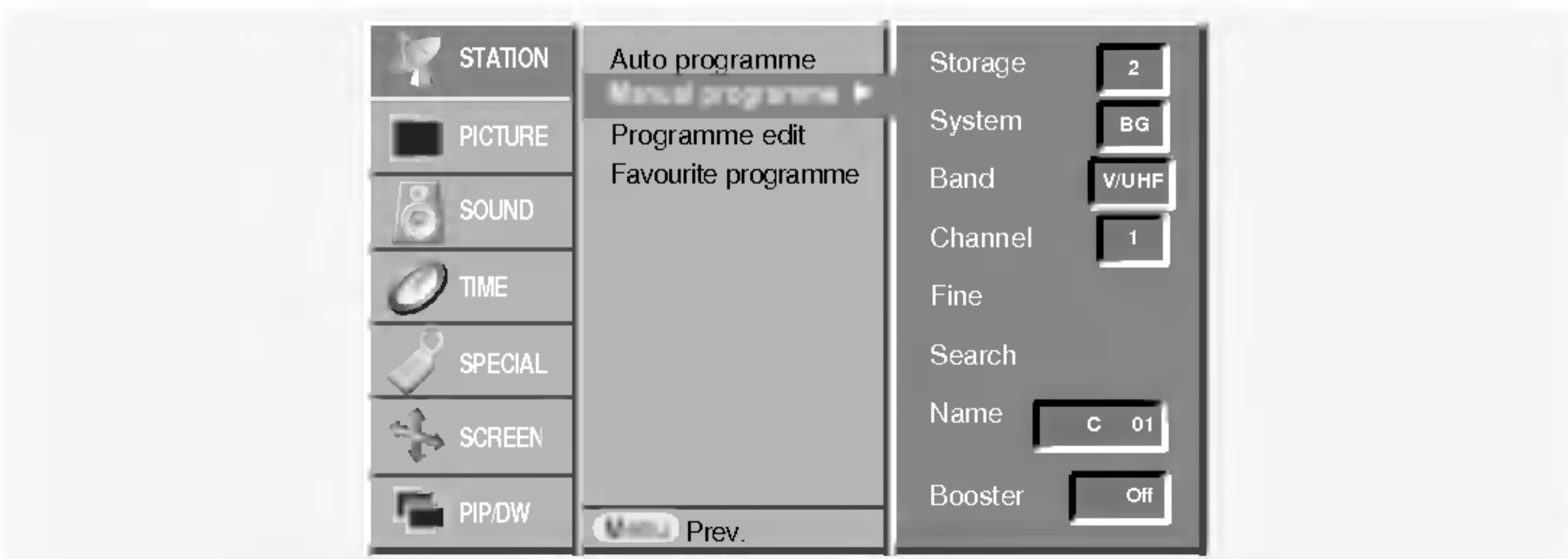

3. Press the **▶** button to select **Storage**. Select the desired programme number with the **◀ / ▶** button or NUMBER buttons on the **Storage** menu.
4. Press the **▼** button to select **System**. Select a TV system with the **◀ / ▶** button;
 - L** : SECAM L/L' (option)
 - BG** : PAL B/G, SECAM B/G (Europe / East Europe / Asia / New Zealand / M.East / Africa / Australia)
 - I** : PAL I/II (U.K. / Ireland / Hong Kong / South Africa)
 - DK** : PAL D/K, SECAM D/K (East Europe / China / Africa / CIS)
 - M** : (USA / Korea / Philippines) (option)
5. Press the **▼** button to select **Band**. Press the **◀ / ▶** button to select **V/UHF** or **Cable** as required.
6. Press the **▼** button to select **Channel**. You can select the desired channel number with the **◀ / ▶** button or NUMBER buttons. If possible, select the channel number directly with the number buttons.
7. Press the **▼** button to select **Search**. Press the **◀ / ▶** button to commence searching. If a station is found the search will stop.
8. Press the **OK** button to store it.
9. To store another station, repeat steps 3 to 8.

Fine Tuning

- Normally fine tuning is only necessary if reception is poor.

1. Repeat the 'Manual programme tuning' steps 1 to 2.
2. Press the **▶** button and then **▲ / ▼** button to select **Fine**.
3. Press the **◀ / ▶** button to fine tune for the best picture and sound.

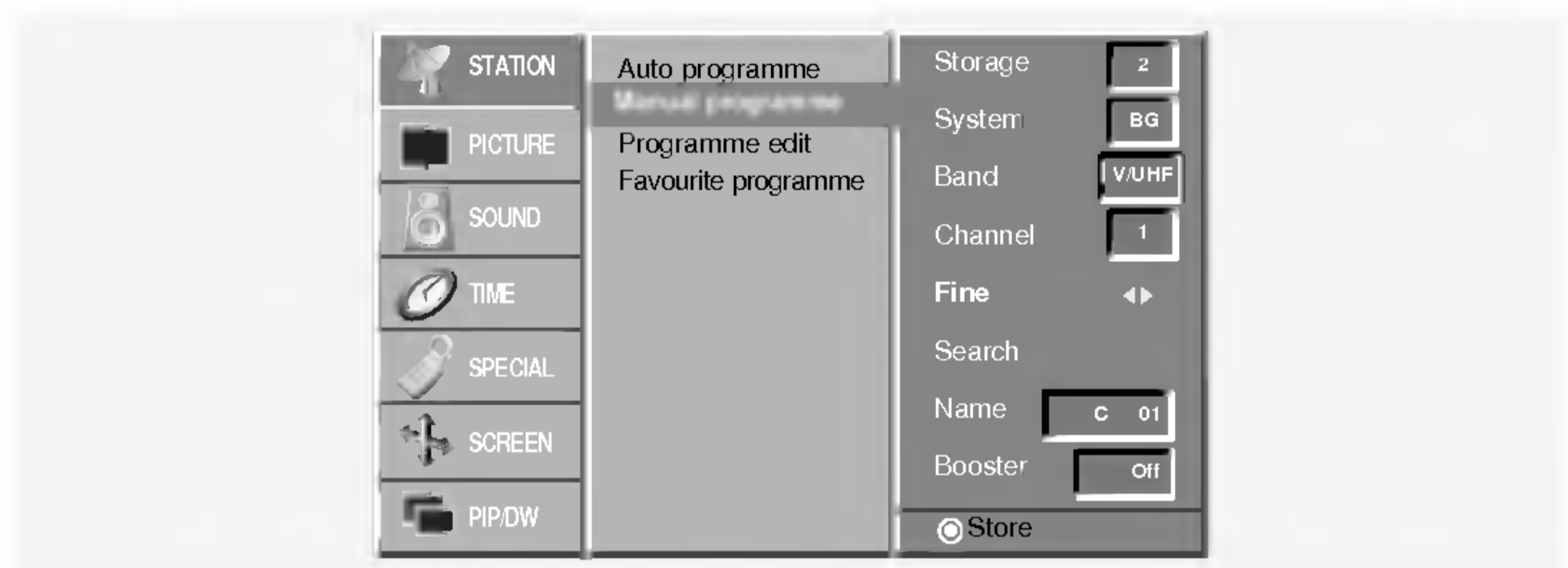

4. Press the **OK** button. The finely tuned programme will be indicated by a yellow number during programme selection.
5. Repeatedly press the **MENU** button to return to normal TV viewing.

Channel Menu Options

Assigning a Station Name

1. Repeat the 'Manual programme tuning' steps 1 to 2.
2. Press the ► button and then ▲ / ▼ button to select **Name**.
3. Press the ► button to display the **Name** menu.

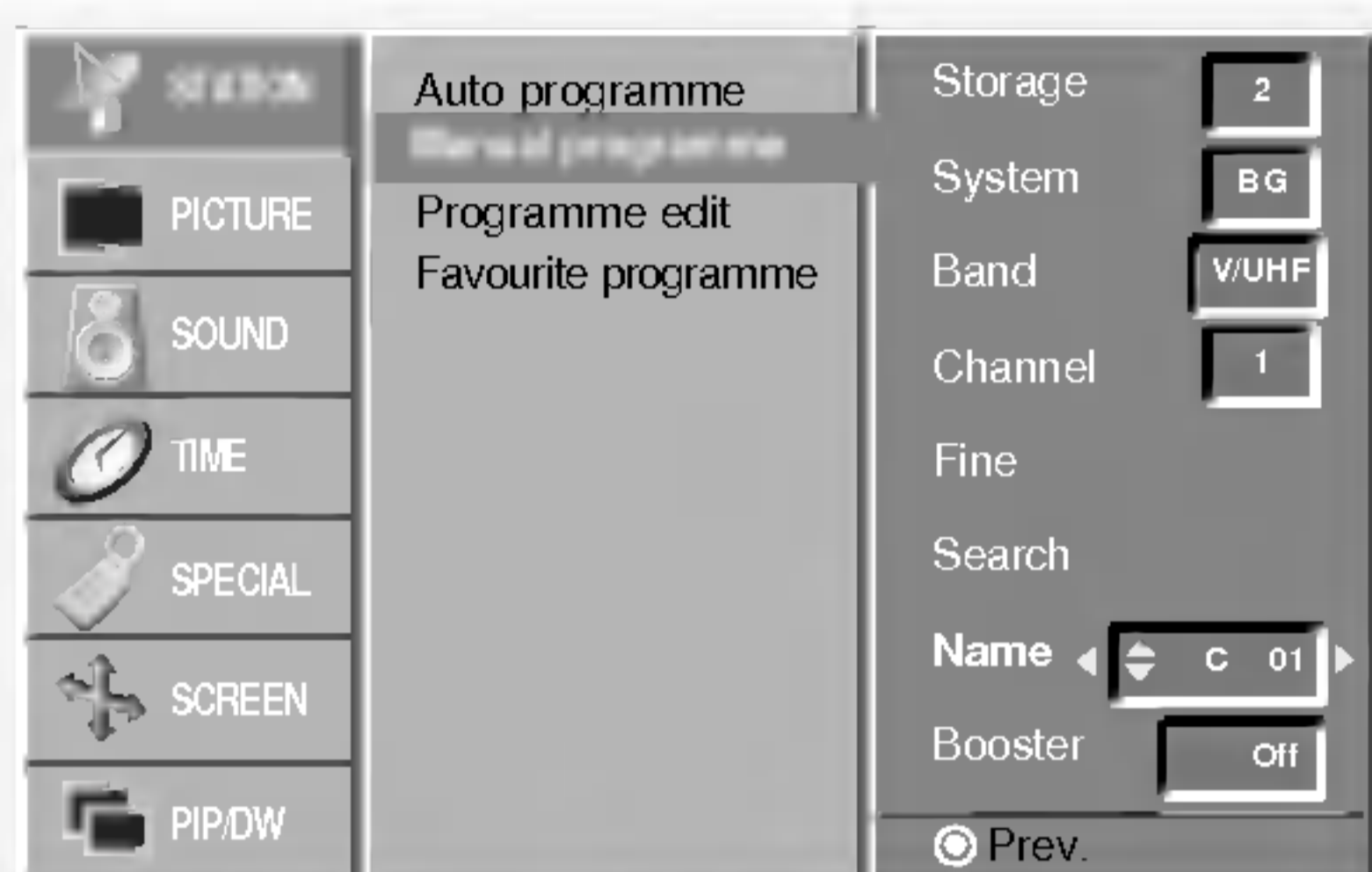

4. Press the ▲ button. You can use a blank, +, -, the alphabet **A** to **Z** and the numeric **0** to **9**.
With the ▼ button you can select in the opposite direction.
5. Select the next position by pressing the ► button and then make your choice of the second character, and so on.
6. Press the **OK** button in twice.
7. Repeatedly press the **MENU** button to return to normal TV viewing.

Booster (option)

In some models, **Booster** is an optional function. Only a set with **Booster** can perform this function.

If the reception is poor at the fringe area of TV signal, select **Booster** to **On**.

1. Repeat the 'Manual programme tuning' steps 1 to 2.
2. Press the ► button and then ▲ / ▼ button to select **Booster**.
3. Press the ◀ / ▶ button to select **On** or **Off**.
4. Press the **OK** button.
5. Repeatedly press the **MENU** button to return to normal TV viewing.

Programme Edit

- This function enables you to delete or skip the stored programmes. Also you can move some stations to other programme numbers or copy a blank station data into the selected programme number.

1. Press the **MENU** button and then use ▲ / ▼ button to select the **STATION** menu.
2. Press the ► button and then ▲ / ▼ button to select **Programme edit**.
3. Press the ► button to display the **Programme edit** menu.

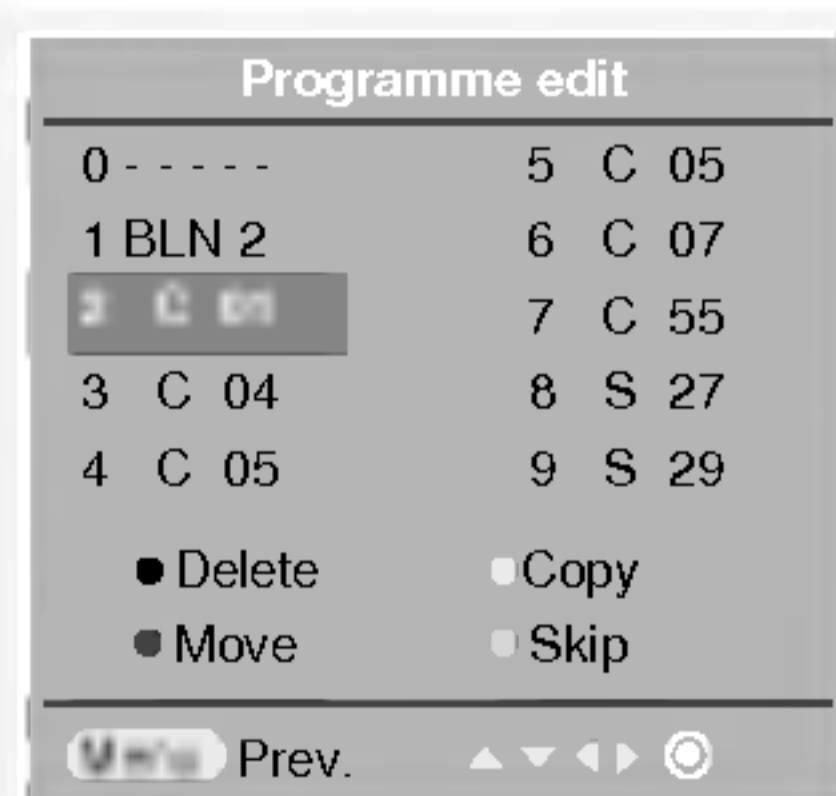

Deleting a programme

1. Select a programme to be deleted with the ▲ / ▼ or ◀ / ▶ button.
2. Press the **RED** button twice.
The selected programme is deleted, all the following programmes are shifted up one position.

Copying a programme

1. Select a programme to be copied with the ▲ / ▼ or ◀ / ▶ button.
2. Press the **GREEN** button.
All the following programmes are shifted down one position.

Moving a programme

1. Select a programme to be moved with the ▲ / ▼ or ◀ / ▶ button.
2. Press the **YELLOW** button.
3. Move the programme to the desired programme number with the ▲ / ▼ or ◀ / ▶ button.
4. Press the **YELLOW** button again to release this function.

Skipping a programme number

1. Select a programme number to be skipped with the ▲ / ▼ or ◀ / ▶ button.
2. Press the **BLUE** button. The skipped programme turns to blue.
3. Press the **BLUE** button again to release the skipped programme.
When a programme number is skipped it means that you will be unable to select it using the **PR** ▲ / ▼ button during normal TV viewing. If you want to select the skipped programme, directly enter the programme number with the **NUMBER** buttons or select it in the programme edit or table menu.

Favourite Programme

- This function lets you select your favourite programmes directly.

1. Press the **MENU** button and then use ▲ / ▼ button to select the **STATION** menu.
2. Press the ► button and then ▲ / ▼ button to select **Favourite programme**. (or, press the ► button and then ▲ / ▼ button to select **On**.)
3. Press the ► button to display the **Favourite programme** menu.
4. Press the ▲ / ▼ button to select -- -----.
5. Select a desired programme with the ◀ / ▶ button or **NUMBER** buttons. Any number under 10 is entered with a numeric '0' (or '00') in front of it, i.e. '05' (or '005') for 5.
6. To store another programme, repeat steps 4 to 5.
You can store up to 8 programmes.
7. Press the **OK** button.
8. Repeatedly press the **MENU** button to return to normal TV viewing.

Repeatedly press the **SWAP** or **FAVOURITE** button to select stored favorite programmes.

Calling up the Programme Table

- You can check the programmes stored in the memory by displaying the programme table.

Displaying programme table

Press the **LIST** button to display the Programme table menu. The programme table appears on the screen.

- You may find some blue highlighted programmes shown. They have been set up in the programme edit mode.
- Some programmes with the channel number shown in the programme table indicate there is no station name assigned.

Selecting a programme in the programme table

Select a programme with the ▲ / ▼ or ◀ / ▶ button. Then press the **OK** button.

The Plasma Display switches to the chosen programme number.

Paging through a programme table

There are 10 programme table pages in which contain 100 programmes.

Pressing the ▲ / ▼ or ◀ / ▶ button repeatedly turns the pages.

Press the **LIST** button to return to normal TV viewing.

Picture Menu Options

PSM (Picture Status Memory)

- This function adjusts the set to the best picture appearance.
- When adjusting picture options (contrast, brightness, colour, sharpness and tint (NTSC AV only)) manually, PSM is automatically changed to **User**.

1. Press the **PSM** button.
- Each press of the **PSM** button changes the screen display as shown below.

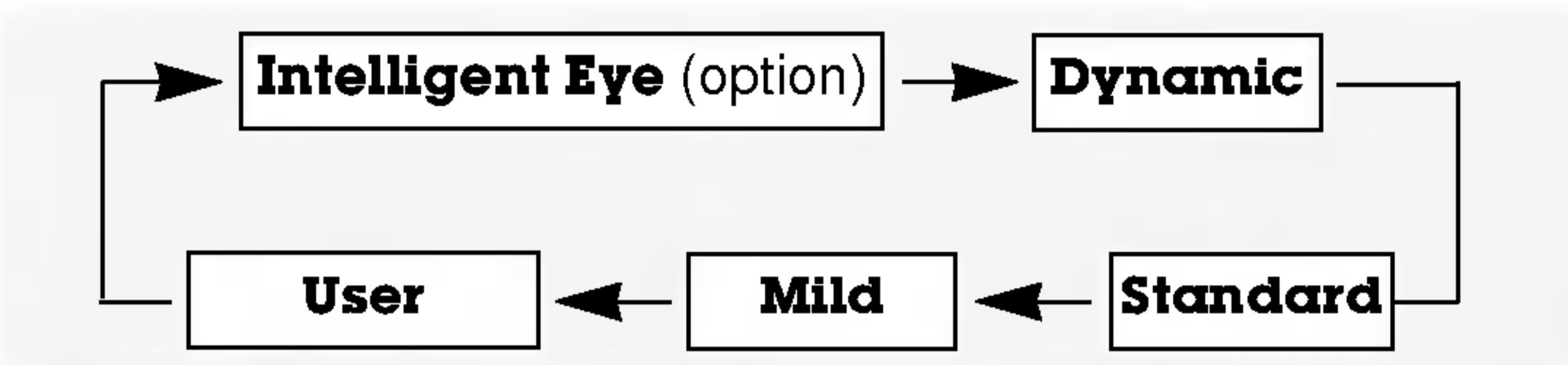

- You can also select **Intelligent Eye** (option), **Dynamic**, **Standard**, **Mild** or **User** in the PICTURE menu.
- Picture options **Intelligent Eye** (option), **Dynamic**, **Standard** and **Mild** are preset and programmed for good picture quality at the factory and cannot be changed.
- When the eye function is on, the most suitable picture is automatically adjusted according to the surrounding conditions. (option)

CSM (Colour Status Memory)

- To initialize values (reset to default settings), select the **Normal** option.



Manual Colour Temperature Control

- You can adjust red, green, or blue to any colour temperature you prefer.

XD

- You can enjoy the vivid and hi-definition picture with LG's Excellent Digital Reality processor technology.
- It's not available to use this function in RGB[PC], HDMI[PC] mode.
- When selecting picture options (**Intelligent Eye** (option), **Dynamic**, **Standard** and **Mild**) in PICTURE menu, **XD** is automatically changed to **On**.

sRGB

- When the set was connected to external equipment with sRGB function, It's adjusted a colour difference to display the equal image each other.
- This function works in the following mode:RGB[PC], HDMI[PC].

ACM (Active Colour Management)

- Adjust the **ACM** to select the desired skin colour option.
- This function works in the following mode: TV, AV1, AV2, S-Video2, AV3, AV4, AV5 or COMPONENT, RGB[DTV], HDMI[DTV].
- It's not available to use this function in **XD Off** mode.

Manual Picture Control

- You can adjust picture contrast, brightness, colour, sharpness and tint (NTSC AV only) to the levels you prefer.
- It's not available to use colour, sharpness function in RGB[PC], HDMI[PC] mode.
- In the broadcasting system PAL/SECAM, the picture item Tint doesn't work.

Sound Menu Options

SSM (Sound Status Memory)

- This function lets you enjoy the best sound without any special adjustment because the set automatically selects the appropriate sound option based on the program content.
- When adjusting sound options (treble and bass) manually, SSM is automatically changed to **User**.

1. Press the **SSM** button.
2. Press the **SSM** button to select your desired sound.

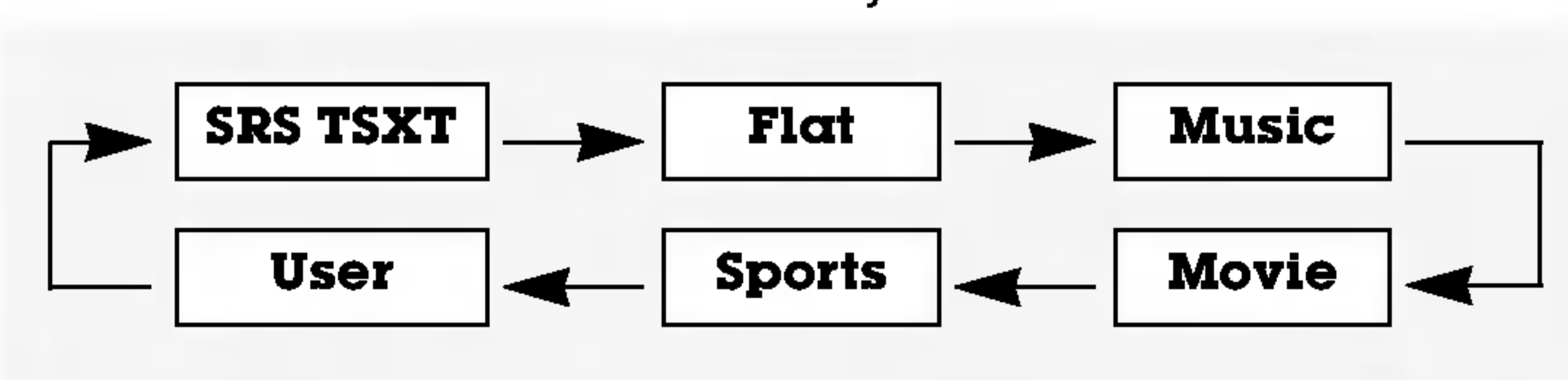

- **SRS** is a trademark of SRS Labs, Inc.
- TruSurround XT technology is incorporated under license from SRS Labs, Inc.

BBE

- BBE High Definition Sound restores clarity and presence for better speech intelligibility and musical realism.

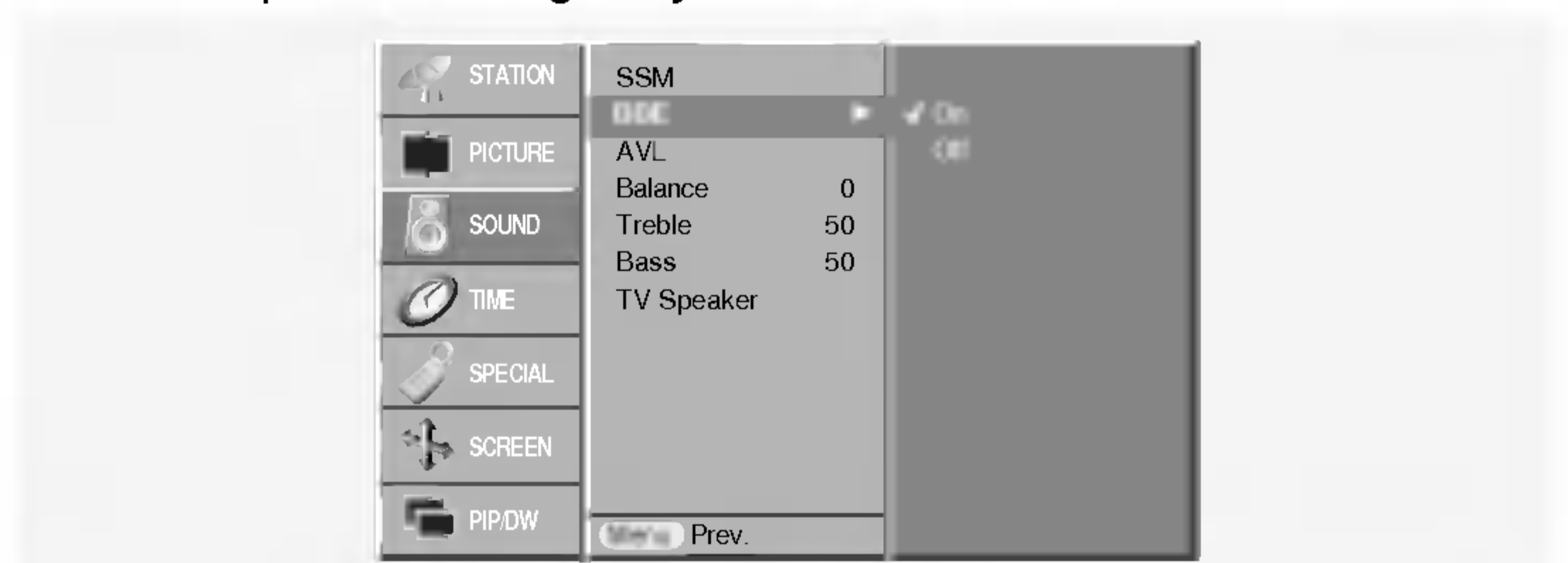

BBE. Manufactured under license from BBE Sound, Inc.

AVL (Auto Volume Leveler)

- This feature maintains an equal volume level; even if you change channels.

Adjusting Sound Control

Note : Treble, Bass or BBE aren't suitable to use **SRS TSXT**.

Sound Menu Options

TV Speaker

- You can adjust internal speaker status.
- In COMPONENT, RGB[PC] and HDMI[PC] mode, TV speaker/variable audio can be output even though there is no video signal.
- If you want to use your external hi-fi stereo system, turn off the internal speakers of the set.

Stereo / Dual Reception

- When a programme is selected, the sound information for the station appears after the programme number and station name disappear.

On Screen Display

Press the I/II button to received broadcast state.

Broadcast	On screen Display
Mono	MONO
Stereo	STEREO
Dual	DUAL I

Mono Sound Selection

In stereo reception if the stereo signal is weak, you can switch to mono by pressing the I/II button twice. In mono reception the depth of sound is improved. To switch back to stereo, press the I/II button twice again.

Language Selection for Dual Language Broadcast

If a programme received in two languages (dual language), you can switch to **DUAL I**, **DUAL II** or **DUAL I + II** by pressing the I/II button repeatedly.

- **DUAL I** sends the primary broadcast language to the loudspeakers.
- **DUAL II** sends the secondary broadcast language to the loudspeakers.

- **DUAL I + II** sends a separate language to each loudspeaker.

NICAM Reception (option)

- If your Plasma Display is equipped with the PDP Tuner for NICAM reception, the high quality NICAM (Near Instantaneous Companding Audio Multiplex) digital sound can be received.

Sound output can be selected according to the type of received broadcast as follows by pressing the I/II button repeatedly.

- When NICAM mono is received, you can select **NICAM MONO** or FM MONO.
- When NICAM stereo is received, you can select **NICAM STEREO** or FM MONO. If the stereo signal is weak, switch to FM mono.
- When NICAM dual is received, you can select **NICAM DUAL I**, **NICAM DUAL II**, **NICAM DUAL I + II**, or **MONO**. When FM mono is selected the display **MONO** appears on the screen.

Sound output selection

In AV, Component, RGB or HDMI mode, you can select output sound for the left and right loudspeakers.

Repeatedly press the I/II button to select the sound output.

- **L+R** : Audio signal from audio L input is sent to left loudspeaker and audio signal from audio R input is sent to right loudspeaker.
- **L+L** : Audio signal from audio L input is sent to left and right loudspeakers.
- **R+R** : Audio signal from audio R input is sent to left and right loudspeakers.

Time Menu Options

Setting the Clock

- If current time setting is erased by a power failure or the set is unplugged, reset the clock.

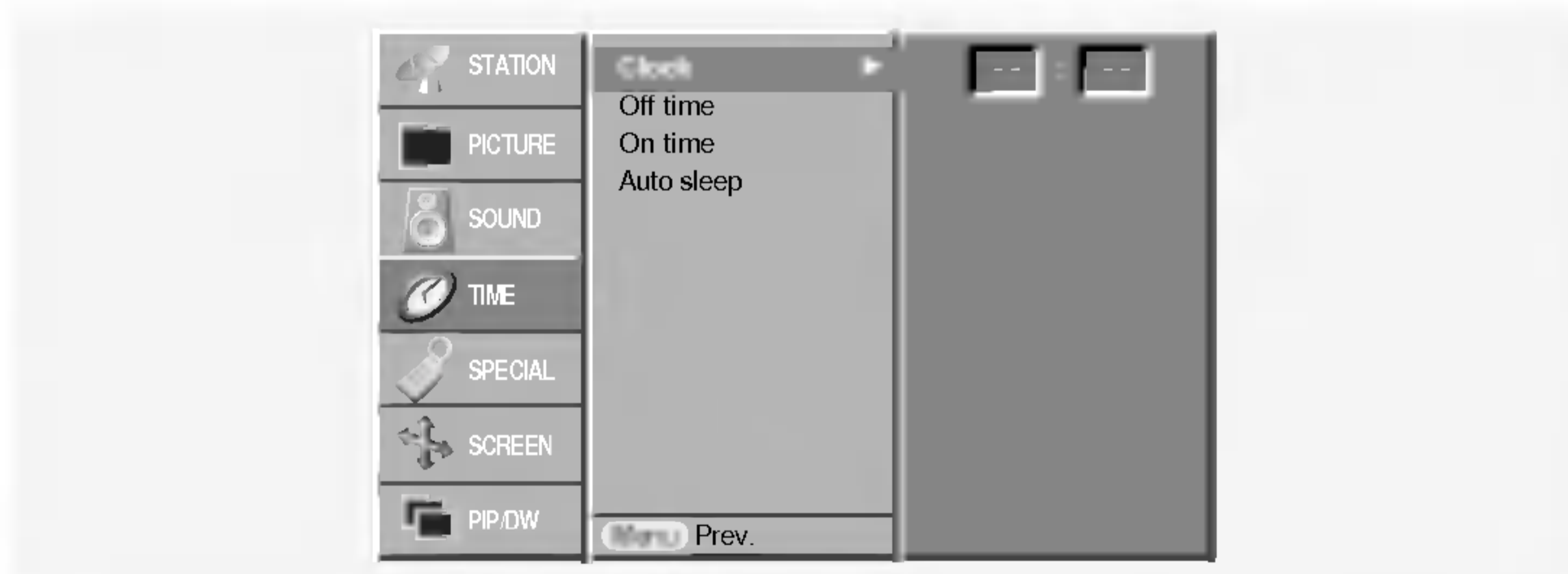

Setting the On/Off Timer

- Timer function operates only if current time has been already set.
- Off Timer function overrides on Timer function if they are set to the same time.
- The set must be in standby mode for the On Timer to work.
- Two hours after the set is switched on by the on time function it will automatically switch back to standby mode unless a button has been pressed.

Auto Sleep

- If there is no input signal, the monitor turn off automatically after 10 minutes.

Sleep Timer

- Sleep timer turns the set off at the preset time.
- Press the **SLEEP** button to select the number of minutes. The display --- **Min** will appear on the screen, followed by **10, 20, 30, 60, 90, 120, 180** and **240** minutes. The timer begins to count down from the number of minutes selected.
 - To check the remaining sleep time, press the **SLEEP** button once.
 - To cancel the sleep time, repeatedly press the **SLEEP** button until the display --- **Min** appears.
 - If you turn the set off after setting the sleep timer, the setting will be erased.

Special Menu Options

Child Lock

- The set can be set up so that it can only be used with the remote control.
- This set programmed to remember which option it was last set to even if you turn the set off.
- In **Child lock 'On'**, if the set is turned off, press the **INPUT** or **TV/AV, PR ▲ / ▼** button on the set or **POWER, INPUT** or **TV/AV, MULTIMEDIA, PR ▲ / ▼** or **NUMBER** buttons on the remote control.
- With the **Child lock On**, the display '  **Child lock on**' appears on the screen if any button on the front panel is pressed while viewing the set.

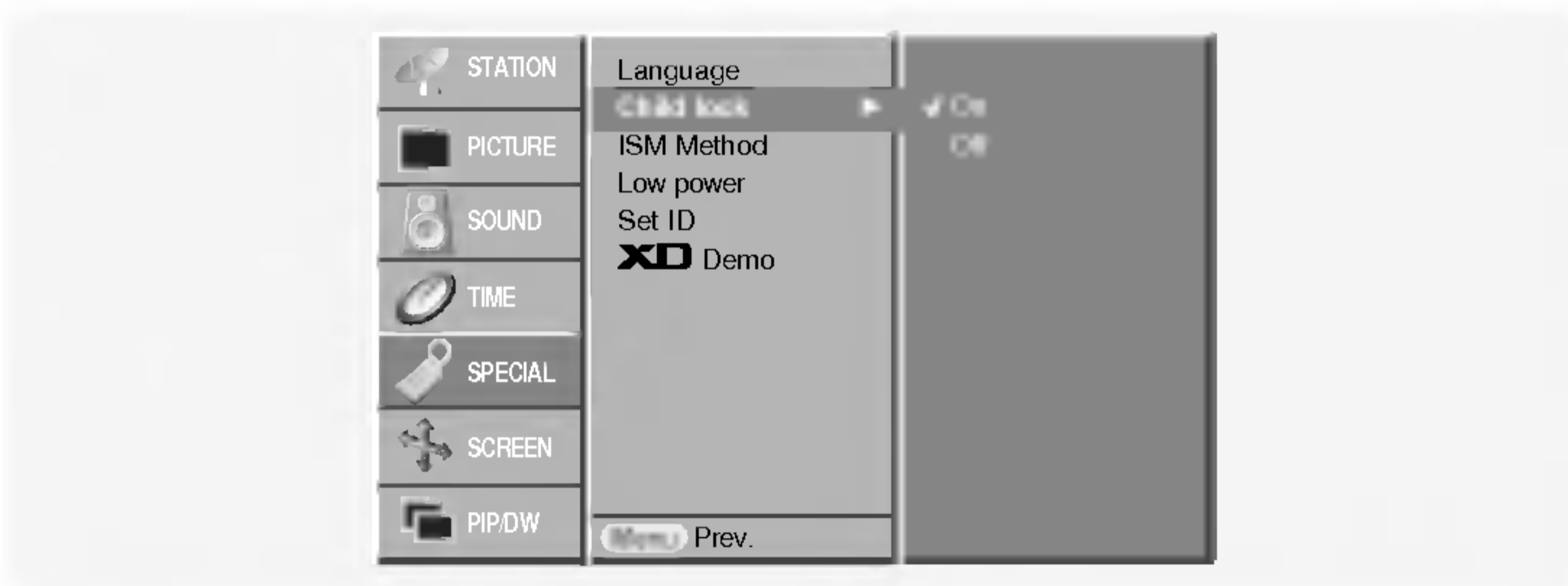

ISM (Image Sticking Minimization) Method

- Frozen still picture from a PC/video game displayed on the screen for prolonged periods will result in an ghost image remaining even when you change the image. Avoid allowing a fixed image to remain on the set's screen for a long period of time.

Screen Menu Options

Auto Configure

- Automatically adjusts picture position and minimizes image shaking.
- This function works in the following mode : RGB[PC].
 - When **Auto config.** has finished, **Ok** will be shown on screen.
 - If the position of the image is still not correct, try Auto adjustment again.
- If picture needs to be adjusted more after Auto adjustment in RGB (PC), you can adjust the **Manual Config.**
- Although the image is still not correct, your set is functioning properly but needs further adjustment.
- The **Auto config.** functions don't need to be run for HDMI mode.



• White Wash :

White Wash removes permanent images from the screen.
Note: An excessive permanent image may be impossible to clear entirely with White Wash.

• Orbiter :

Orbiter may help prevent ghost images. However, it is best not to allow any fixed image to remain on the screen. To avoid a permanent image on the screen, the screen will move every 2 minutes.

• Inversion :

This is the function to invert the panel colour of the screen. The panel colour is automatically inverted every 30 minutes.

Low Power

- This is the function to reduce the power consumption of the set.

XD Demo

- Use it to see the difference between XD demo on and XD Demo off.
- It's not available to use this function in RGB[PC], HDMI[PC] mode.

Manual Configure

- If the picture isn't clear after auto adjustment and especially that characters are still trembling, adjust the picture phase manually.
- To correct the screen size, adjust **Clock**.
- This function works in the following mode : RGB[PC], RGB[DTV], COMPONENT (480p/576p/720p/1080i), HDMI (480p/576p/720p/1080i).
- It's not available to use Phase, Clock function in RGB[DTV], COMPONENT (480p/576p/720p/1080i), HDMI (480p/576p/720p/1080i) mode.

Selecting Wide VGA/XGA mode

- To see a normal picture, match the resolution of RGB mode and selection of VGA/XGA mode.
- In some models, it's not available to selection of XGA mode.
- This function works in the following mode : RGB[PC].

Screen Menu Options

Setting Picture Format

- You can watch the screen in various picture formats; **Spectacle**, **Full** (option), **Original**, **4:3**, **16:9** (Wide), **14:9** and **Zoom**.

- **Spectacle**

When your TV receives the wide screen signal, following selection will lead you to adjust the picture horizontally, in non-linear proportion, to fill the entire screen.

- **Full** (option)

When your TV receives the wide screen signal, following selection will lead you to adjust the picture horizontally or vertically, in a linear proportion, to fill the entire screen fully.

- **Original**

When your TV receives the wide screen signal, it will be automatically changed to the picture format to be sent.

- **4:3**

Following selection will lead you to view a picture with an original 4:3 aspect ratio, with gray bars appearing at both the left and right sides.

- **16:9** (Wide)

Following selection will lead you to adjust the picture horizontally, in a linear proportion, to fill the entire screen (useful for viewing 4:3 formatted DVDs).

- **14:9**

You can enjoy the picture format of 14:9 or general TV programme through the 14:9 mode. The screen 14:9 is viewed just like that the screen 4:3 is magnified to the left / right.

- **Zoom**

Following selection will lead you to view the picture without any alternation, while filling the entire screen. However, the top and bottom portions of the picture will be cropped.

- You can only select **4:3** and **16:9** (Wide) in RGB[PC], HDMI[PC] mode only.

- You can only select **4:3**, **16:9** (Wide) and **Zoom** in RGB[DTV], HDMI[DTV], Component [DTV] mode only.
- You can only select **Spectacle**, **Full** (option), **4:3**, **16:9** (Wide), **14:9** and **Zoom** in Component [480i/576i] mode only.
- There might be uncomfortable in full mode. Then change into other mode.

Picture Size Zoom

- When enlarging or reducing the picture, the screen may be display unnatural picture.

Screen Position

- You are available to this function after adjusting Zoom In/Out.

Cinema

- When you watch the movie, this function adjusts the set to the best picture appearance.
- This function works in the following mode: TV, AV1, AV2, S-Video2, AV3, AV4, AV5 or COMPONENT 480i/576i.

NR (Noise Reduction)

- You can select **3D NR** or **MPEG NR** to reduce the picture noise which may appear on the screen during watching the TV.
- This function is not available for use in RGB[PC], HDMI[PC] mode.
- 3D NR is not available for use in RGB, HDMI, Component[DTV] mode.

Initializing (Reset to original factory value)

This function operates in current mode.

To initialize the adjusted value.

- You can initialize Phase, Clock, H-Position, V-Position, Position, Zoom +/-, PIP size, PIP position, PIP Transparency and sub picture size of twin picture.

Teletext (option)

- Teletext (or TOP text) is an optional function, therefore only the set with the teletext system can receive the teletext broadcast.
- Teletext is a free service broadcast by most TV stations which gives up-to-the-minute information on news, weather, television programmes, share prices and many other topics.
- The teletext decoder of this set can support the SIMPLE, TOP and FASTEXT systems. SIMPLE (standard teletext) consists of a number of pages which are selected by directly entering the corresponding page number. TOP and FASTEXT are more modern methods allowing quick and easy selection of teletext information.

Teletext Language Selection

1. Press the **MENU** button and then use **▲** / **▼** button to select the **SPECIAL** menu.
2. Press the **▶** button and then use **▲** / **▼** button to select **Language**.
3. Press the **▶** button and then use **◀** / **▶** button to select **Teletext Language**.
4. Press the **▲** / **▼** button to select the required language.

5. Repeatedly press the **MENU** button to return to normal TV viewing.

Note :

- a. Please select your local teletext language.
- b. If you don't, the teletext may not appear correctly on the screen.

Switch on/off

Press the **TEXT/★** button to switch to teletext.

- The initial page or last page appears on the screen. Two page numbers, TV station name, date and time are displayed on the screen headline. The first page number indicates your selection, while the second shows the current page displayed.

Press the **TEXT/★** button to switch off teletext.

Teletext (option)

SIMPLE Text (option)

Page selection

1. Enter the desired page number as a three digit number with the NUMBER buttons. If during selection you press a wrong number, you must complete the three digit number and then reenter the correct page number.
2. The **PR ▲ / ▼** button can also be used to select the preceding or following page.

Programming a colour button in LIST mode (option)

If the TV is in SIMPLE text, TOP text or FASTEXT mode, press the  button to switch to LIST mode.

Four teletext page numbers of your choice can be colour coded and easily selected by pressing the corresponding coloured button on the remote control handset.

1. Press a coloured button.
2. Using the NUMBER buttons, select the page you wish to programme.
3. Press the **OK** button. The selected page is stored as the selected page number, blinking once to confirm this. From now on, you can select this page with the same coloured button.
4. The three other coloured buttons are programmed in this way.

TOP Text (option)

The user guide displays four fields-red, green, yellow and blue at the bottom of the screen. The yellow field denotes the next group and the blue field indicates the next block.

Block / group / page selection

1. With the blue button you can progress from block to block.
2. Use the yellow button to proceed to the next group with automatic overflow to the next block.
3. With the green button you can proceed to the next existing page with automatic overflow to the next group. (Alternatively the **PR ▲** button can be used.)
4. The red button permits to return to previous selection. (Alternatively the **PR ▼** button can be used.)

Direct page selection

Corresponding to the SIMPLE text mode, you can select a page by entering it as a three digit number using the NUMBER buttons in TOP mode.

FASTEXT

The teletext pages are colour coded along the bottom of the screen and are selected by pressing the corresponding coloured button.

Page selection

1. Press the  button to select the index page.
2. You can select the pages which are colour coded along the bottom line with the same coloured buttons.
3. Corresponding to the SIMPLE text mode, you can select a page by entering its three digit page number with the NUMBER buttons in FASTEXT mode.
4. The **PR ▲ / ▼** button can also be used to select the preceding or following page.

Special Teletext Functions

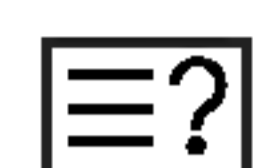

REVEAL

Press this button to display concealed information, such as solutions of riddles or puzzles.

Press this button again to remove the information from the display.



SIZE

Selects double height text.

Press this button to enlarge the top half of the page.

Press this button again to enlarge the bottom half of the page.

Press this button again to return to the normal display.



UPDATE

Displays the TV picture on the screen while waiting for the new teletext page.

Press this button to view the updated teletext page.



HOLD

Stops the automatic page change which will occur if a teletext page consists of 2 or more sub pages. The number of sub pages and the sub page displayed is, usually, shown on the screen below the time. When this button is pressed the stop symbol is displayed at the top left-hand corner of the screen and the automatic page change is inhibited.

To continue press this button again.



MIX

Displays the teletext pages superimposed on the TV picture.

To switch the TV picture off press this button again.



TIME

This button has two functions:

a) When viewing a TV programme, press this button to display the time at the top right hand corner of the screen. Press this button again to remove the display.

b) In teletext mode, press this button to select a sub page number. The sub page number is displayed at the bottom of the screen. To hold or change the sub page, press the RED/ GREEN or **PR ▲ / ▼** buttons. Press this button again to exit this function.

PIP (Picture-in-Picture) Feature

- PIP lets you view 2 different inputs (sources) on your set screen at the same time.
- It's not available to use this function in TELETEXT mode.

Watching PIP

Press the **PIP** or **PIP/DW** button to show the sub picture.

- Each press of **PIP** or **PIP/DW** button changes the screen display as shown below.

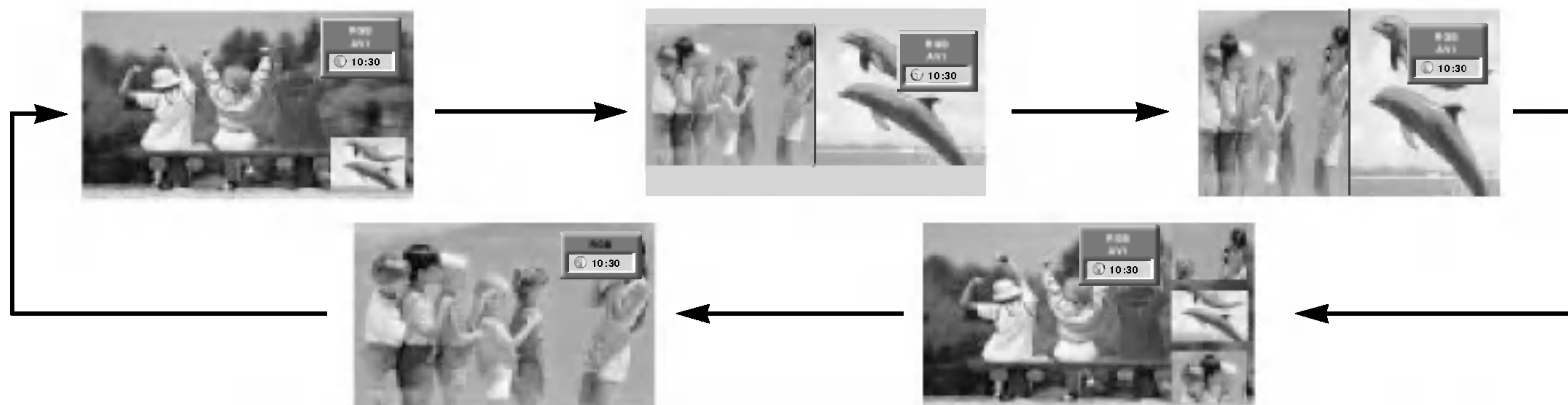

Note :

- When the sub picture size is 1/2 of the main picture, the picture quality might get poor.
- The motion of the sub picture can be unnatural because the set displays full screen by synchronizing the main picture source when the refresh rate between the main picture source and the sub picture source is different in PIP mode.

Programme Selection for Sub Picture

Press the **PIP PR +/-** button to select a programme for the sub picture.

Selecting an Input Signal Source for the PIP

Press the **PIP INPUT** button to select the input source for the sub picture.

In some models, when the sub picture quality get poor for sub picture, select Auto, PAL, SECAM or NTSC in PIP System menu.



Moving the PIP (PIP mode only)

Press the **POSITION** button.

Repeatedly press the **▲ / ▼** or **◀ / ▶** button until desired position is achieved. The sub picture moves up/down or left/right.



Picture Size

Press the **SIZE** or **WIN.SIZE** button and then **◀ / ▶** button to adjust the sub picture size.

With **SIZE** or **WIN.SIZE** button in DW1, DW2 modes, main and sub picture is adjusted simultaneously. With **SIZE** or **WIN.SIZE** button in PIP mode, sub picture is adjusted.



POP (Picture-out-of-Picture: Channel Scan)

Use POP to search the programmes of all the memorized channels one-by-one on the 3 PIP screen display, (while the main picture source remains the current channel). The pictures of all the programmed channels are searched with the 3 POP screen.

Adjusting PIP Transparency (PIP mode only)

1. Press the **MENU** button and then **▲ / ▼** button to select the PIP/DW menu.
2. Press the **▶** button and then **▲ / ▼** button to select **PIP Transparency**.
3. Press the **▶** button and then **◀ / ▶** button to adjust PIP transparency.
4. Repeatedly press the **MENU** button to return to normal TV viewing.

Adjusting the screen for the PIP

- In TV or AV modes for the main picture and RGB[PC] for the sub picture, you can use Auto config and Manual config to adjust the screen of the sub picture.
- In TV or AV modes for main picture and HDMI[DTV] or Component 480p, 576p, 720p, 1080i for the sub picture, you can use Manual config to adjust the screen of the sub picture.

Programming the Remote (option)

- ▶ The remote is a multi-brand or a universal remote. It can be programmed to operate most remote-controllable devices of other manufacturers.
Note that the remote may not control all models of other brands.

Programming a code into a remote mode

1. To find out whether your remote can operate the device without programming, turn on the device such as a VCR and press the corresponding mode button on the remote.
After that, press the **POWER** button. If the device is turned off then it responds properly and the remote need not to be programmed. If not, the remote should be programmed to operate the device. The programming procedures are explained below.
2. Press the **MENU** and **MUTE** button continuously at the same time for 2 seconds, the current selected device button will be illuminated.
If you don't press any button for 20 seconds, the light on the mode button will be turned off. In that case, you have to repeat from step 2.
3. Enter code numbers using the number button on the remote by referring the code table on the following pages. When pressing the button, the light blinks at a time. If the device turned off, the programming is successful.
4. Press the **MENU** button to store the code. After blinking twice, this code is stored.
5. Test the remote functions to see if the device responds properly. If not, repeat from step 2.

Programming Codes (option)

VCRs

Brand	Codes	Brand	Codes	Brand	Codes	Brand	Codes
AIWA	034	KENWOOD	014 034 039 043	PORTLAND	108	TATUNG	039 043
AKAI	016 043 046 124 125 146	LG (GOLDSTAR)	047 048 001 012 013 020 101 106 114 123	PULSAR	072	TEAC	034 039 043
AMPRO	072	LLOYD	034	QUARTZ	011 014	TECHNICS	031 033 070
ANAM	031 033 103	LXI	003 009 013 014 017 034 101 106	QUASAR	033 066 075 145	TEKNIKA	019 031 033 034 101
AUDIO DYNAMICS	012 023 039 043	MAGIN	040	RCA	013 020 033 034 040 041 062 063 107 109 140 144 145 147	THOMAS	034
BROKSONIC	035 037 129	MAGNAVOX	031 033 034 041 067 068	REALISTIC	003 008 010 014 031 033 034 040 053 054 101	TMK	006
CANON	028 031 033	MARANTZ	012 031 033 067 069	RICO	058	TOSHIBA	008 013 042 047 059 082 112 131
CAPEHART	108	MARTA	101	RUNCO	148	TOTEVISION	040 101
CRAIG	003 040 135	MATSUI	027 030	SALORA	014	UNITECH	040
CURTIS MATHES	031 033 041	MEI	031 033	SAMSUNG	032 040 102 104 105 107 109 112 113 115 120 122 125	VECTOR RESEARCH	012
DAEWOO	005 007 010 064 065 108 110 111 112 116 117 119	MEMOREX	003 010 014 031 033 034 053 072 101 102 134 139	SANSUI	022 043 048 135	VICTOR	048
DAYTRON	108	MGA	045 046 059	SANYO	003 007 010 014 102 134	VIDEO CONCEPTS	012 034 046
DBX	012 023 039 043	MINOLTA	013 020	SCOTT	017 037 112 129 131	VIDEOSONIC	040
DYNATECH	034 053	MITSUBISHI	013 020 045 046 049 051 059 061 151	SEARS	003 008 009 010 013 014 017 020 031 042 073 081 101	WARDS	003 013 017 024 031 033 034 040 053 054 131
ELECTROHOME	059	MTC	034 040	SHARP	031 054 149	YAMAHA	012 034 039 043
EMERSON	006 017 025 027 029 031 034 035 036 037 046 101 129 131 138 153	MULTITECH	024 034	SHINTOM	024	ZENITH	034 048 056 058 072 080 101
FISHER	003 008 009 010	NEC	012 023 039 043 048	SONY	003 009 031 052 056 057 058 076 077 078 149		
FUNAI	034	NORDMENDE	043	SOUNDESIGN	034		
GE	031 033 063 072 107 109 144 147	OPTONICA	053 054	STS	013		
GO VIDEO	132 136	PANASONIC	066 070 074 083 133 140 145	SYLVANIA	031 033 034 059 067		
HARMAN KARDON	012 045	PENTAX	013 020 031 033 063				
HITACHI	004 018 026 034 043 063 137 150	PHILCO	031 034 067				
INSTANTREPLAY	031 033	PHILIPS	031 033 034 054 067 071 101				
JCL	031 033	PILOT	101				
JCPENNY	012 013 015 033 040 066 101	PIONEER	013 021 048				
JENSEN	043						
JVC	012 031 033 043 048 050 055 060 130 150 152						

CATV

Brand	Codes	Brand	Codes	Brand	Codes	Brand	Codes
ABC	003 004 039 042 046 052 053	GOLDEN CHANNEL	030	PIONEER	065 085 090 034 051 052 063 076	SPRUCER	047 078
AJIN	112	HAMLIN	049 050 055	POST NEWS WEEK	016	STARCOM	002 004 008 009
ANTRONIK	014	HITACHI	052 055	PRUCER	059	STARGATE	008 030
ARCHER	005 007 014 024	HOSPITALITY	070 077	PTS	011 048 071 072 073 074	TADIRAN	030
CABLE STAR	026	JERROLD	002 003 004 008 009 010 052 069 074	PULSAR	100	TAEKWANG	110
CENTURION	092	LG (GOLDSTAR)	001 106 101 005	RCA	047	TAIHAN	105
CENTURY	007	M-NET	037	REGAL	049 050	TANDY	017
CITIZEN	007	MACOM	033	REGENCY	057	TEXSCAN	029
COLOUR VOICE	065 090	MAGNAVOX	010 012 064 079	REMBRANT	025	TOCOM	039 040 056
COMBANO	080 081	MEMOREX	100	SAMSUNG	102 107 030 068	TOSHIBA	100
COMTRONICS	019 030	MOVIE TIME	028 032	SCIENTIFIC ATLANTA	003 011 041 042 043 045 046	UNIKA	007 014 024
DIAMOND	023	NSC	015 028 038 071 073	SHERITECH	022	UNITED CABLE	004 053
EAGLE	020 030 040	OAK	016 031 037 053	SIGNAL	030	UNIVERSAL	005 007 014 024 026 027 032 035
EASTERN	057 062 066	PANASONIC	044 047	SIGNATURE	052	VIEWSTAR	012 015 018 086 087 088 089
ELECTRICORD	032	PARAGON	100	SL MARX	030	ZENITH	100 114 060 093
GE	072	PHILIPS	006 012 013 020				
GEMINI	008 022 025 054						
GI	052 074						

Programming Codes (option)

HDSTB

Brand	Codes	Brand	Codes	Brand	Codes	Brand	Codes
ALPHASTAR DSR	123		133 134	PACE SKY SATELLITE	143		088 090 107 130
AMPLICA	050	GENERAL INSTRUMENT	003 004 016 029	PANASONIC	060 142		137
BIRDVIEW	051 126 129		031 059 101	PANSAT	121	TOSHIBA	002 127
CHANNEL MASTER	013 014 015 018	HITACHI	139 140	PERSONAL CABLE	117	UNIDEN	016 025 042 043
	036 055	HOUSTON TRACKER	033 037 039 051	PHILIPS	071		044 045 048 049
CHAPARRAL	008 009 012 077		057 104	PICO	105		078 079 080 086
CITOH	054	HUGHES	068	PRESIDENT	019 102		101 135 136
CURTIS MATHES	050 145	JANIEL	060 147	PRIMESTAR	030 110 111	VIEWSTAR	115
DRAKE	005 006 007 010	JERROLD	061	PROSAT	072	WINEGARD	128 146
	011 052 112 116	KATHREIN	108	RCA	066 106	ZENITH	081 082 083 084
	141	LEGEND	057	REALISTIC	043 074		091 120
DX ANTENNA	024 046 056 076	LG	001	SAMSUNG	123		
ECHOSTAR	038 040 057 058	LUTRON	132	SATELLITE SERVICE CO	028 035 047 057		
	093 094 095 096	LUXOR	062 144		085		
	097 098 099 100	MACOM	010 059 063 064	SCIENTIFIC ATLANTA	032 138		
	122		065	SONY	103		
ELECTRO HOME	089	MEMOREX	057	STARCAST	041		
EUROPLUS	114	NEXTWAVE	028 124 125	SUPER GUIDE	020 124 125		
FUJITSU	017 021 022 027	NORSAT	069 070	TEECOM	023 026 075 087		

Audio

Brand	Codes	Brand	Codes	Brand	Codes	Brand	Codes
AIWA	014 028 070 096	JVC	004 013 141	PHILIPS	026 112 143		147 218
	125 129 139 229	KEC	185 186 187	PIONEER	039 042 043 063	TOSHIBA	137
	230	KENWOOD	038 050 067 089		065 091 093 094	THE	061
AKAI	163		170 171 197 206	QUASAR	113	VICTOR	088 131
ANAM	003 014 017 023		215 222	RCA	080	WARDS	089
	059 106 189 216	KOHEL	030	RCX	092	YAMAHA	054 055 066 092
	217 235 236	NAD	045 046	REALISTIC	103 106		199
BURMECTER	252	LOTTE	014 016 036 098	SAMSUNG	124 145 146 182		
CARVER	086		100 172 173 174		193 194 195 203		
CLARION	199		175 176 177 178	SANSUI	011 135 138 144		
DAEWOO	027 053 060 084		179 180 181 183	SANYO	019 083 234		
	102 148 198 221		201 202 208 213	SCOTT	106 186		
DENON	015 075 130 143		214 219 223 232	SHARP	031 032 051 052		
FANTASIA	071		238 240		072 082 117 119		
FINEARTS	022	LXI	103		156 184 199 200		
FISHER	089 099	MAGNAVOX	111		206 209		
LG(GOLDSTAR)	001 021 024 029	MARANTZ	002 018 020 025	SHERWOOD	005 006 158		
	087 107 108 110		034 041 081 090	SONY	044 045 109 114		
	190 191 192 210		097 112		118 126 248 249		
	211 212 239	MCINTOSH	049	TAEKWANG	012 020 073 074		
HAITAI	034 035 188 222	MCS	104		076 077 105 161		
HARMAN/KARDON	068	MEMOREX	107		162 163 164 165		
INKEL	037 058 062 069	NAD	046		166 167 168 169		
	078 079 095 121	ONKYO	013 040 041 047		205 231 233 242		
	122 149 150 151		048 056 057 132	TEAC	010 085 106 136		
	152 153 154 155		133 140		185 187 237		
	157 158 159 160	OPTIMUS	158	TECHNICS	101 113 128 134		
	189 207 222 224	PANASONIC	007 033 064 113				
	225 226 227 243		142 220 241 251				
	247	PENNEY	104				

DVD

Brand	Codes	Brand	Codes	Brand	Codes	Brand	Codes
APEX DIGITAL	022	MAGNAVOX	013	PHILIPS	013	SONY	007
DENON	020 014	MARANTZ	024	PIONEER	004 026	THOMPSON	005 006
GE	005 006	MITSUBISHI	002	PROCEED	021	TOSHIBA	019 008
HARMAN KARDON	027	NAD	023	PROSCAN	005 006	YAMAHA	009 018
JVC	012	ONKYO	008 017	RCA	005 006	ZENITH	010 016 025
LG	001 010 016 025	PANASONIC	003 009	SAMSUNG	011 015		

Notes

Notes

Troubleshooting Checklist

No picture & No sound

- Check whether the set is turned on.
- Power cord inserted into wall outlet?
- Plug another product's power cord into the wall outlet where the set's power cord was plugged in.

Picture OK & No sound

- Press the **VOLUME** (▶) button.
- Sound muted? Press **MUTE** button.
- Check whether the TV speaker is "on" in the SOUND menu.

The remote control doesn't work

- Check to see if there is any object between the set and the remote control causing obstruction.
- Check to see if the batteries are installed with the correct polarities. (Refer to p.5~6)
- Check if the remote control handset is set up to correct mode.
- Install new batteries. (Refer to p.5~6)

Picture appears slowly, after switching on

- This is normal as the image is muted during the startup process of the set. Please contact your service centre, if the picture has not appeared after five minutes.

No or Poor colour or Poor picture

- Select **Colour** in the PICTURE menu and press the **VOLUME** (▶) button. (Refer to p.18)
- Keep a certain distance between the set and the VCR.
- Activate any function to restore the brightness of the picture. (If still picture is on the screen for more than 5 minutes, the screen gets dark.)

Horizontal/vertical bars or picture shaking

- Check for local interference such as an electrical appliance or power tool.

No output from one of the speakers

- Adjust **Balance** in the SOUND menu. (Refer to p.18)

Unusual sound from inside the set

- A change in ambient humidity or temperature may result in an unusual noise at the time of switching off or on of the set and does not indicate a fault with the set.

Product Specifications

MODEL	42PX4R 42PX4R-ZA	42PX4RV 42PX4RV-ZA	42PX4RVA 42PX4RVA-ZA
Width (inches / mm)	49.3 / 1252	49.3 / 1252	49.3 / 1252
Height (inches / mm)	27.78 / 705.5	27.78 / 705.5	27.8 / 706.5
Depth (inches / mm)	11.29 / 286.7	11.29 / 286.7	10.7 / 270.7
Weight (pounds / kg)	84.9 / 38.5	70.06 / 31.78	76.72 / 34.8
Power requirement		AC100-240V, 50/60Hz	
Operating Temperature Range		32 ~ 104°F (0 ~ 40°C)	
Operating Humidity Range		Less than 80%	

MODEL	42PX3RV 42PX3RV-ZA	42PX3RVB 42PX3RVB-ZA	42PX3RVC 42PX3RVC-ZA
Width (inches / mm)		47.64 / 1210	
Height (inches / mm)		27.60 / 701	
Depth (inches / mm)		11.61 / 295	
Weight (pounds / kg)		66.14 / 30	
Power requirement		AC100-240V, 50/60Hz	
Operating Temperature Range		32 ~ 104°F (0 ~ 40°C)	
Operating Humidity Range		Less than 80%	

- The specifications shown above may be changed without notice for quality improvement.