



**MICROWAVE OVEN
HASZNÁLATI UTASÍTÁS
МИКРОВОЉНОВА ФУРНА
MIKROVALNA PEĆNICA
MNKROTALASNA PEĆNICA SA ROŠTILJEM**

**OWNER'S MANUAL
TÍPUSÚ GRILLEZŐ MIKROHULLÁMÚ SÜTŐHÖZ
РЪКОВОДСТВО НА ПОТРЕБИТЕЛЯ
PRIRUČNIK ZA VLASNIKA
PRIRUČNIK ZA UPOTREBU**

MB-4384B

P/No: 3828W5A4245

GB**OWNER'S MANUAL**

PLEASE READ THIS OWNER'S MANUAL THOROUGHLY BEFORE OPERATING.

4~36

HU**TÍPUSÚ GRILLEZŐ MIKROHULLÁMÚ SŰTŐHÖZ**

37~70

BG**РЪКОВОДСТВО НА ПОТРЕБИТЕЛЯ**

Моля, прочетете внимателно това ръководство преди работа

71~106

CR**PRIRUČNIK ZA VLASNIKA**

MOLIMO VAS DA PRIJE KORIŠTENJA U CIJELOSTI PROČITATE OVAJ PRIRUČNIK

107~139

SE**PRIRUČNIK ZA UPOTREBU**

MOLIMO VAS DA PAŽLJIVO PROČITATE OVO UPUTSTVO PRE UPOTREBE.

140~173

Precautions

Precautions to avoid possible exposure to excessive microwave energy.

GB

You cannot operate your oven with the door open due to the safety interlocks built into the door mechanism. These safety interlocks automatically switch off any cooking activity when the door is opened; which in the case of a microwave oven could result in harmful exposure to microwave energy.

It is important not to tamper with the safety interlocks.

Do not place any object between the oven front face and the door or allow food or cleaner residue to accumulate on sealing surfaces.

Do not operate your oven if it is damaged. It is particularly important that the oven door closes properly and that there is no damage to the: (1) door(bent), (2) hinges and latches (broken or loosened), (3) door seals and sealing surfaces.

Your oven should not be adjusted or repaired by anyone except qualified service personnel.

Warning

Please ensure cooking times are correctly set as over cooking may result in the FOOD catching fire and subsequent damage to your oven.

When heating liquids, e.g. soups, sauces and beverages in your microwave oven, delayed eruptive boiling can occur without evidence of bubbling. This could result in a sudden boil over of the hot liquid. To prevent this possibility the following steps should be taken:

- 1 Avoid using straight sided containers with narrow necks.
- 2 Do not overheat.
- 3 Stir the liquid before placing the container in the oven and again halfway through the heating time.
- 4 After heating, allow to stand in the oven for a short time, stir or shake them(especially the contents of feeding bottles and baby food jars) again carefully and check the temperature of them before consumption to avoid burns (especially, contents of feeding bottles and baby food jars).
Be careful when handling the container.

Warning

Always allow food to stand after being cooked by microwaves and check the temperature of them before consumption. Especially contents of feeding bottles and baby food jars.

How the Microwave Oven Works

Microwaves are a form of energy similar to radio and television waves and ordinary daylight. Normally, microwaves spread outwards as they travel through the atmosphere and disappear without effect. Microwave ovens, however, have a magnetron which is designed to make use of the energy in microwaves. Electricity, supplied to the magnetron tube, is used to create microwave energy.

These microwaves enter the cooking area through openings inside the oven. A turntable or tray is located at the bottom of the oven. Microwaves cannot pass through metal walls of the oven, but they can penetrate such materials as glass, porcelain and paper, the materials out of which microwave-safe cooking dishes are constructed.

Microwaves do not heat cookware, though cooking vessels will eventually get hot from the heat generated by the food.

A very safe appliance

Your microwave oven is one of the safest of all home appliances. When the door is opened, the oven automatically stops producing microwaves. Microwave energy is converted completely to heat when it enters food, leaving no “left over” energy to harm you when you eat your food.

Precautions	4
Contents	5
Unpacking & Installing	6 ~ 7
Setting the Clock	8
Child Clock	9
Micro Power Cooking	10
Micro Power Level	11
Quick Start	12
Grill Cooking	13
Combination Cooking	14
Auto Cook	15 ~ 17
Auto Defrost	18 ~ 19
Quick Defrost	20 ~ 21
Auto Roast	22 ~ 24
Special Cook	25 ~ 27
Heating or Reheating Guide	28
Fresh Vegetable Guide	29
Grill Cooking Guide	30
Important safety instructions	31
Microwave - safe Utensils	32
Food characteristics & Microwave cooking	33 ~ 34
Questions & Answers	35
Plug Wiring Information/Technical Specifications	36

Unpacking & Installing

By following the basic steps on these two pages you will be able to quickly check that your oven is operating correctly. Please pay particular attention to the guidance on where to install your oven. When unpacking your oven make sure you remove all accessories and packing. Check to make sure that your oven has not been damaged during delivery.

GB

- 1** Unpack your oven and place it on a flat level surface.

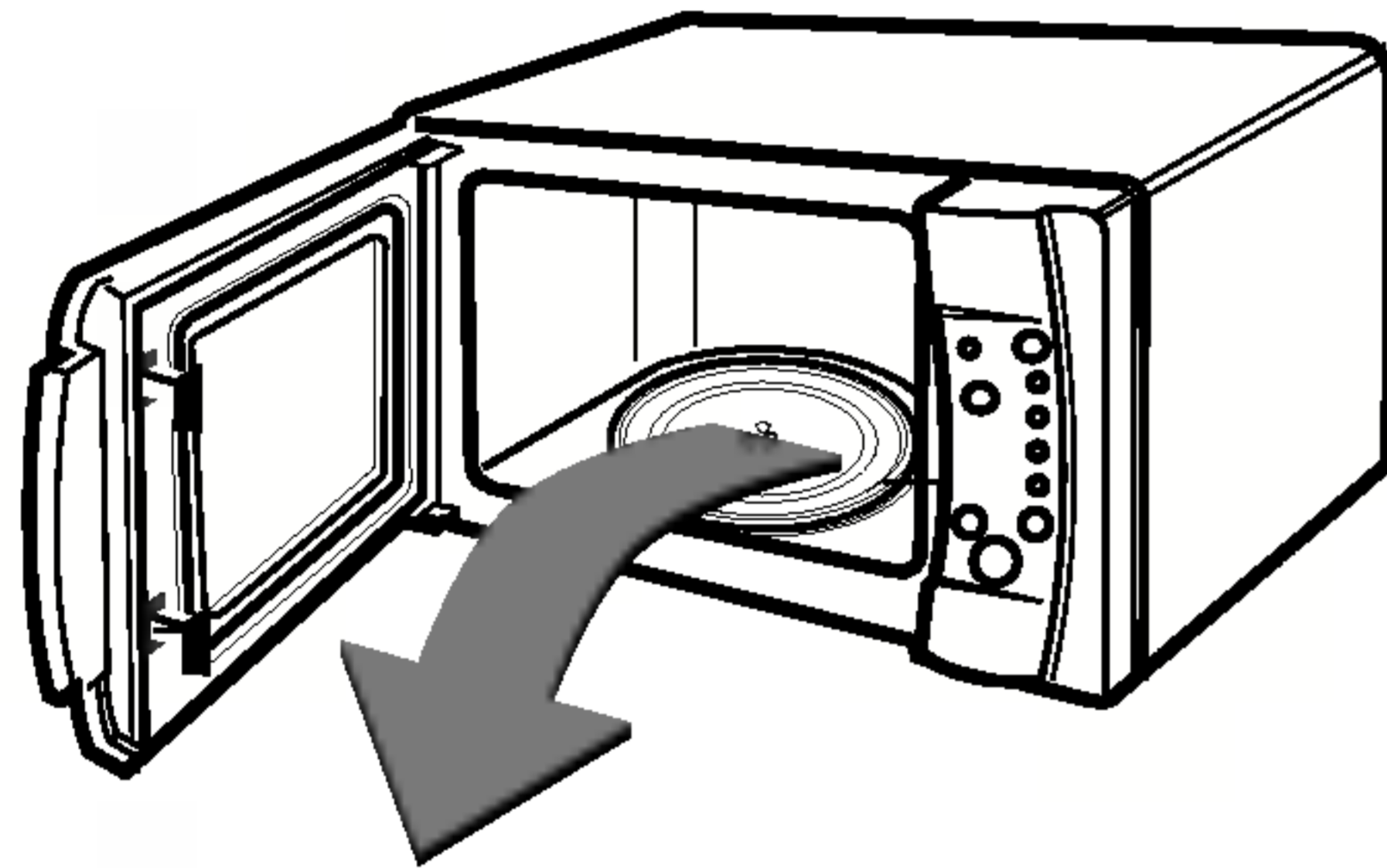

GLASS TRAY

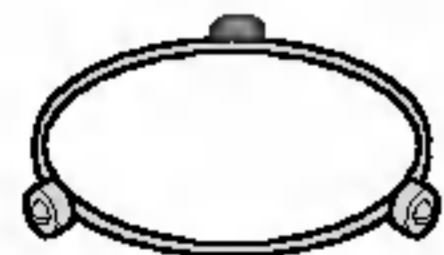
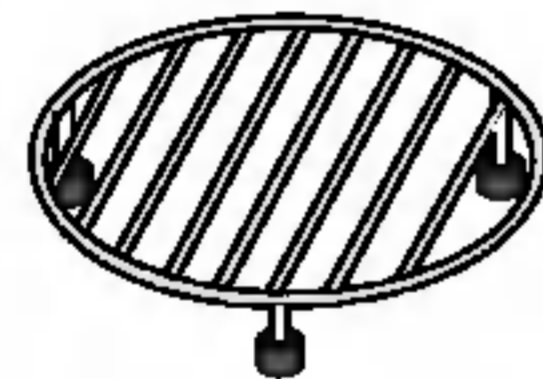

ROTATING RING

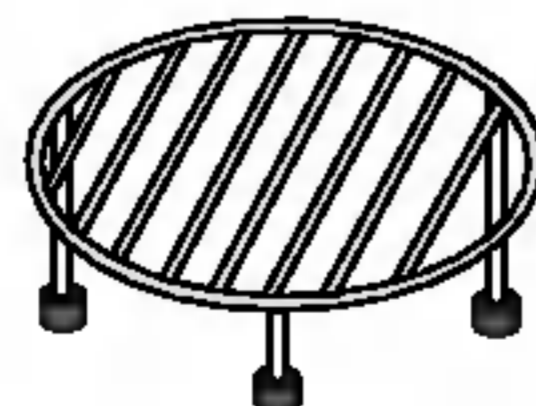

GRILL RACK

- 2** Place the oven in the level location of your choice with more than 85cm height but make sure there is at least 30cm of space on the top and 10cm at the rear for proper ventilation. The front of the oven should be at least 8cm from the edge of the surface to prevent tipping. An exhaust outlet is located on top or side of the oven. Blocking the outlet can damage the oven.

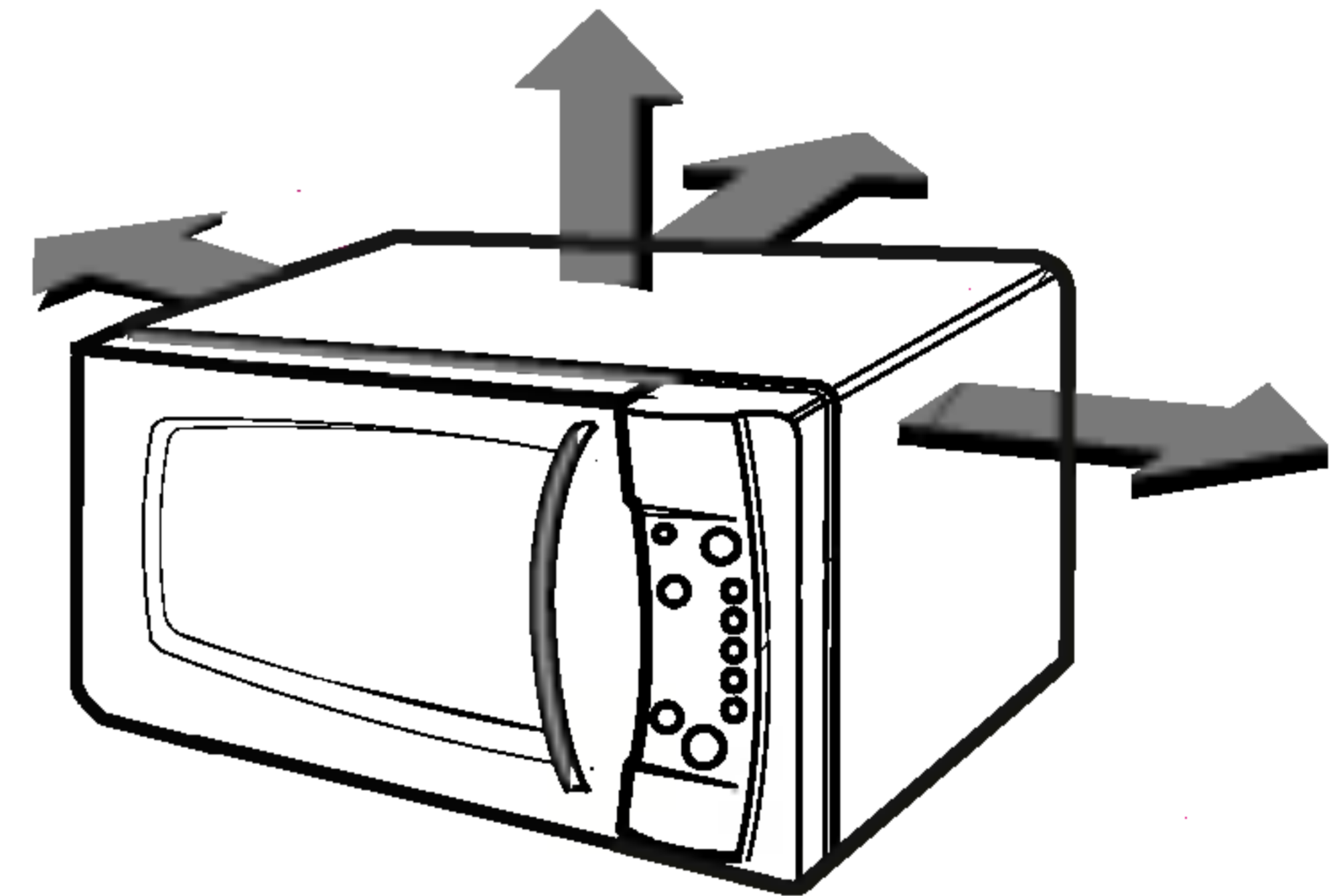

THIS OVEN SHOULD NOT BE USED FOR COMMERCIAL CATERING PURPOSES

3 Plug your oven into a standard household socket. Make sure your oven is the only appliance connected to the socket. **If your oven does not operate properly, unplug it from the electrical socket and then plug it back in.**

4 Open your oven door by pulling the **DOOR HANDLE**. Place the **ROLLER REST** inside the oven and place the **GLASS TRAY** on top.

GB

5 Fill a **microwave safe container** with 300 ml (1/2 pint) of water. Place on the **GLASS TRAY** and close the oven door. If you have any doubts about what type of container to use please refer to page 32.

6 Press the **START** button once to set 30 seconds of cooking time.

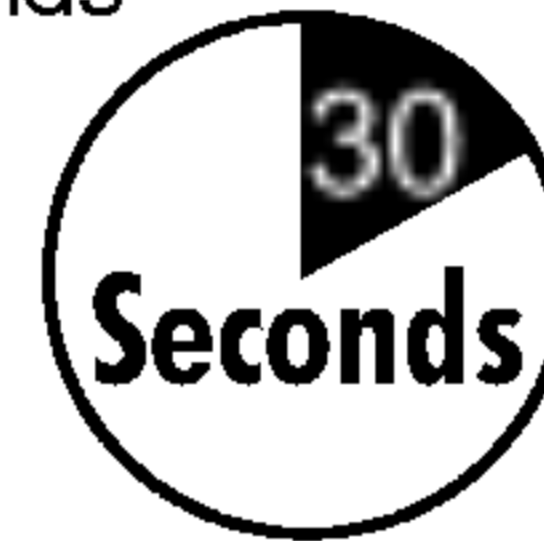

7 The **DISPLAY** will count down from 30 seconds. When it reaches 0, BEEP sounds. Open the oven door and test the temperature of the water. If your oven is operating the water should be warm. **Be careful when removing the container it may be hot.**

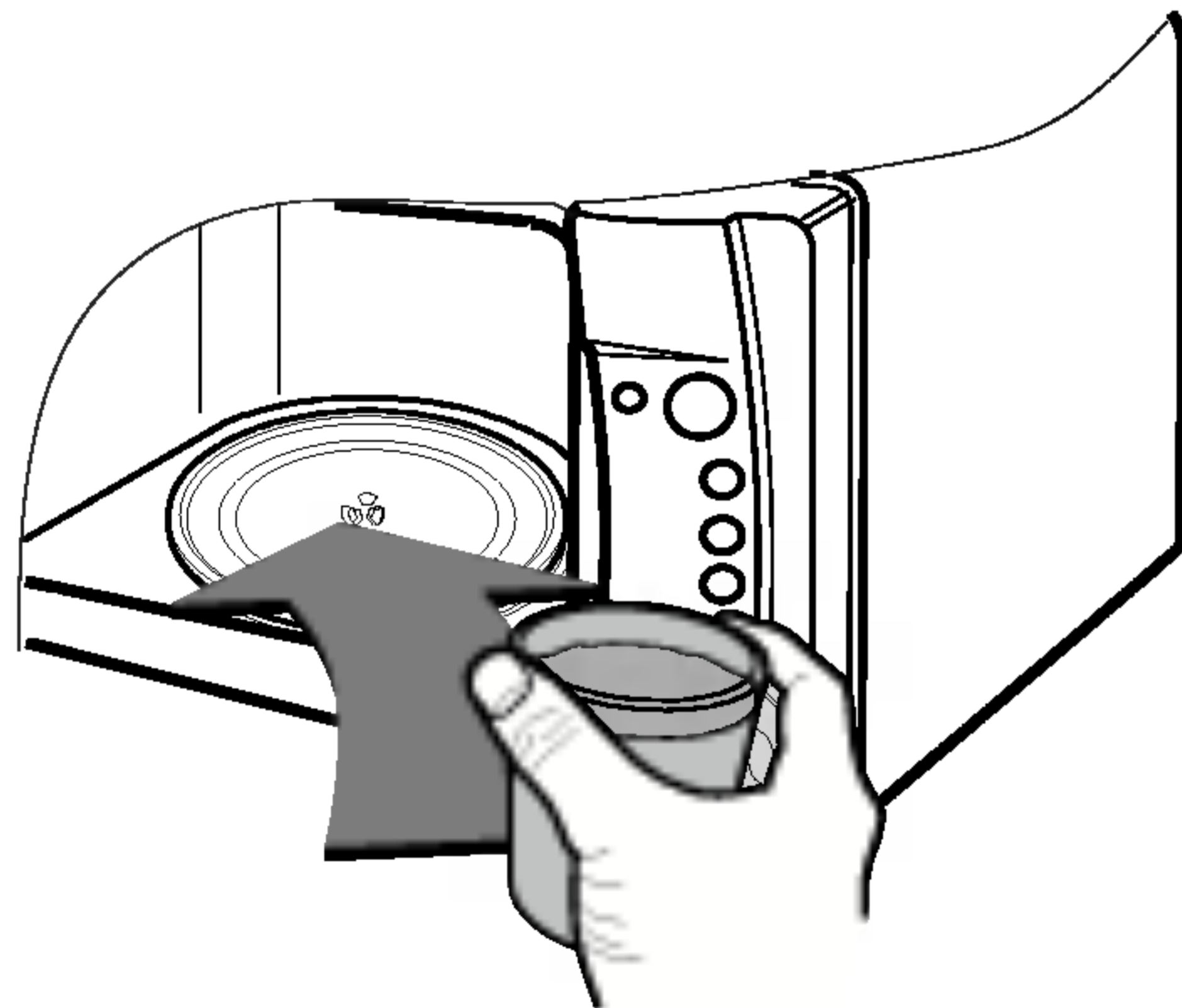

YOUR OVEN IS NOW INSTALLED

Setting the Clock

You can set either 12 hour clock or 24 hour clock.
In the following example I will show you how to set the time for 14:35 when using the 24 clock.
Make sure that you have removed all packaging from your oven.

GB



When your oven is plugged in for the first time or when power resumes after a power cut, a '0' will be shown in the display; you will have to reset the clock.

If the clock (or display) shows any strange looking symbols, unplug your oven from the electrical socket and plug it back in and reset the clock.

Make sure that you have correctly installed your oven as described earlier in this book.

Press **STOP/CLEAR**.

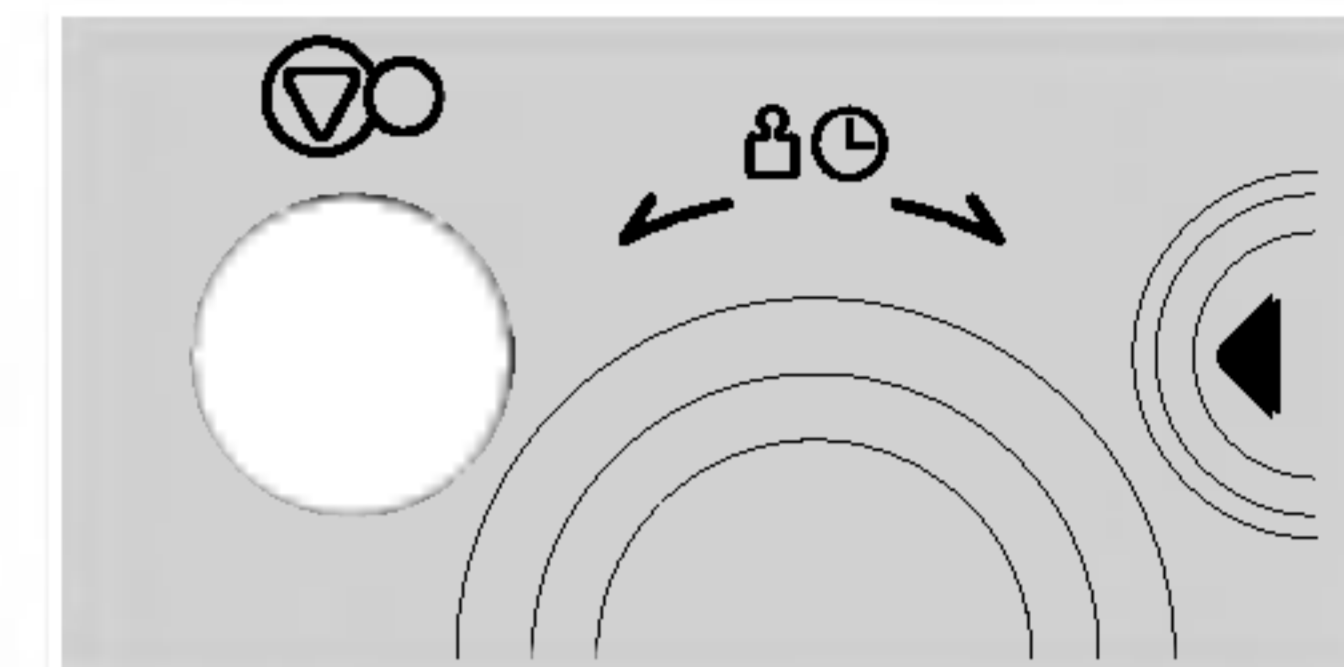

Press **CLOCK** once.

(If you want to use different option, Press **CLOCK** once more.
If you want to change different option after setting clock, you have to unplug and plug it back in.)

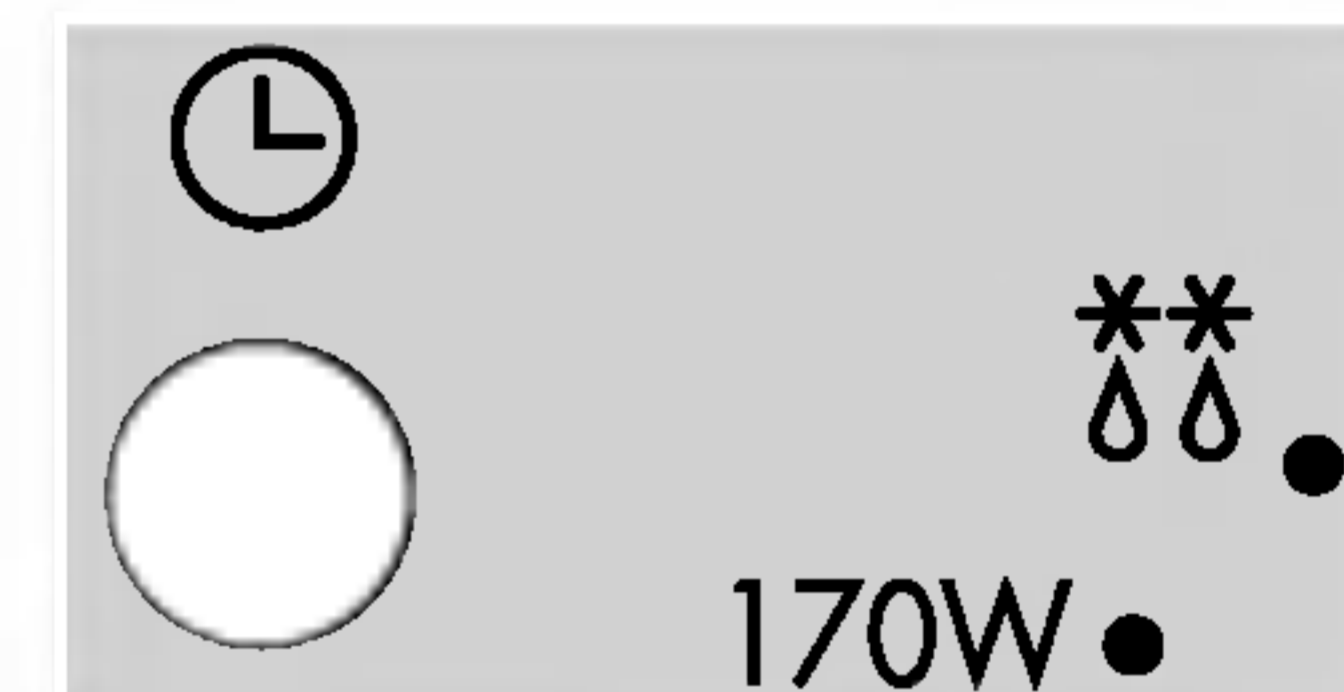

Turn **DIAL** until display shows "14:00".

Press **START** for hour confirmation.

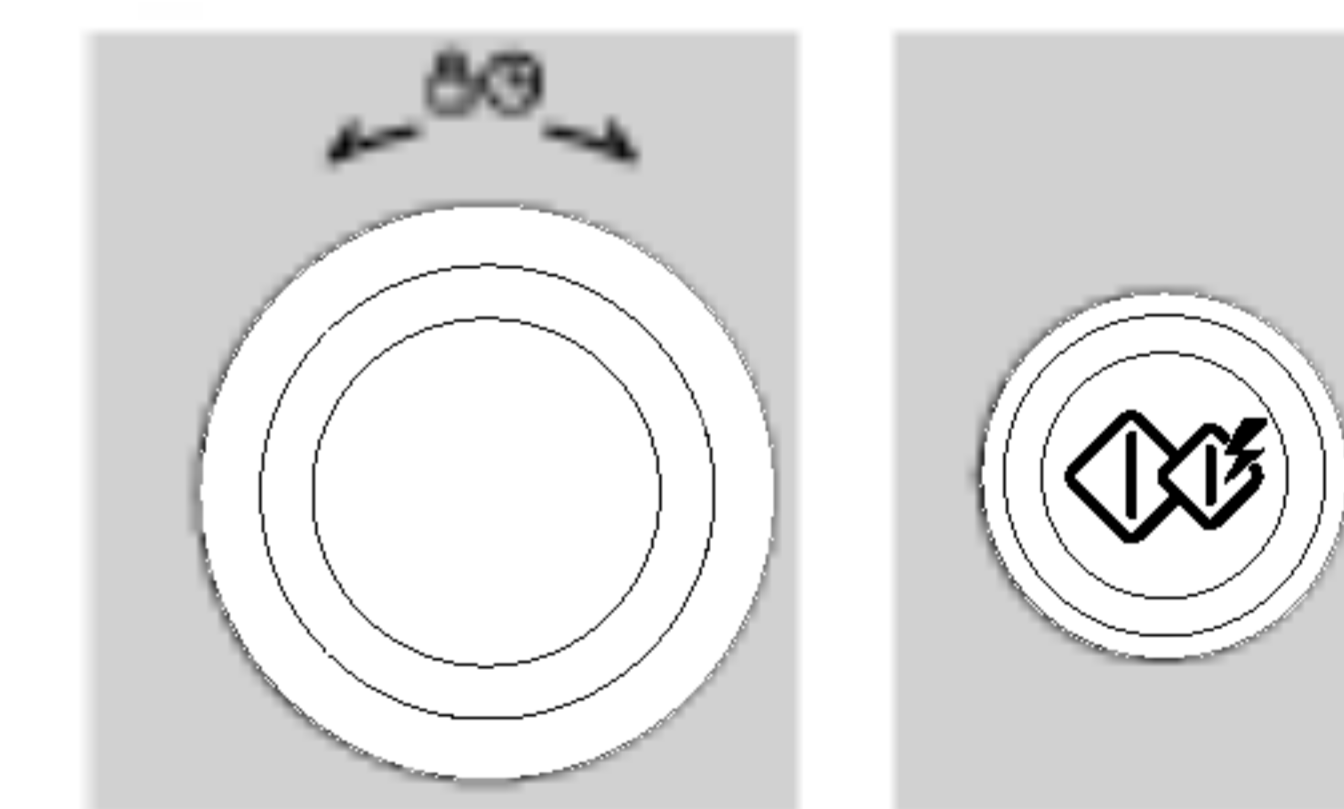

Turn **DIAL** until display shows "14:35".

Press **START**.

The clock starts counting.

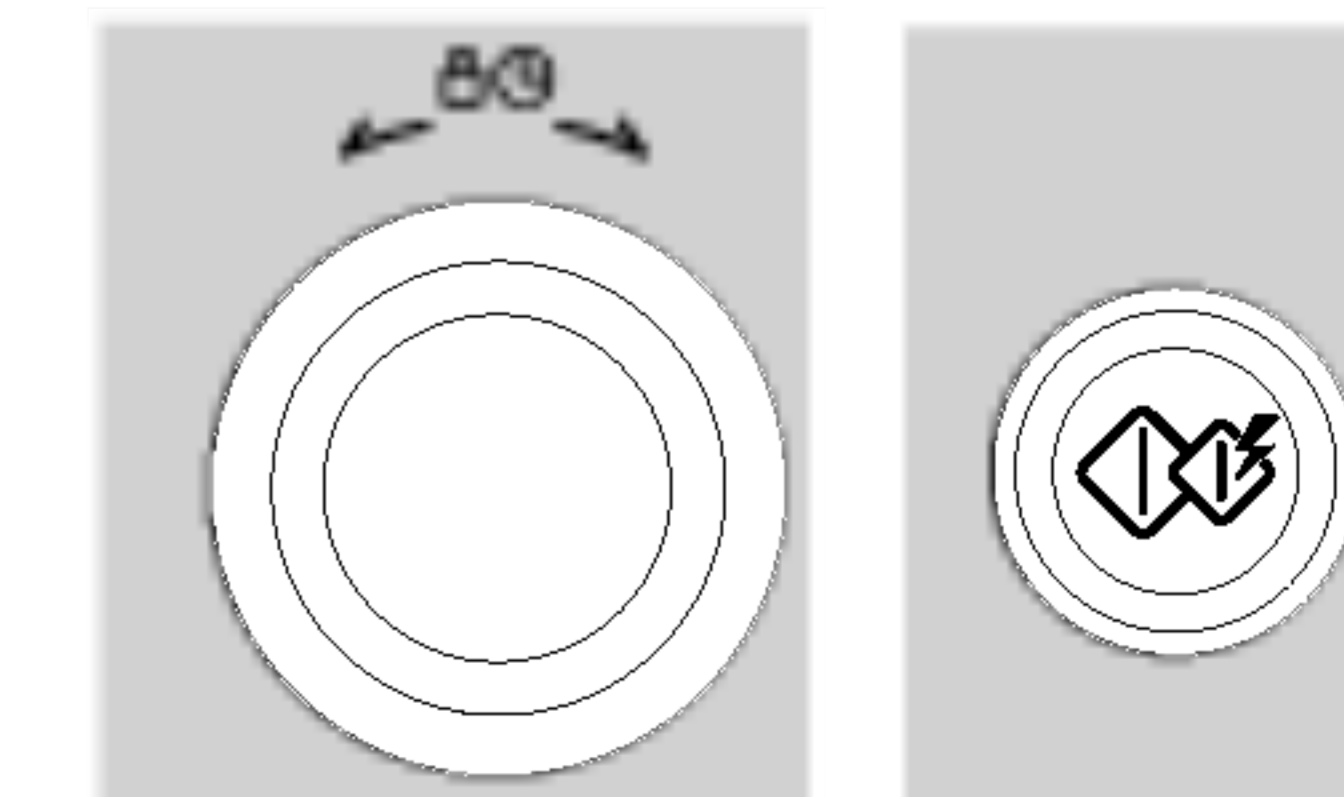

Child Lock



Your oven has a safety feature that prevents accidental running of the oven. Once the child lock is set, you will be unable to use any functions and no cooking can take place. However your child can still open the oven door.

Press **STOP/ CLEAR**

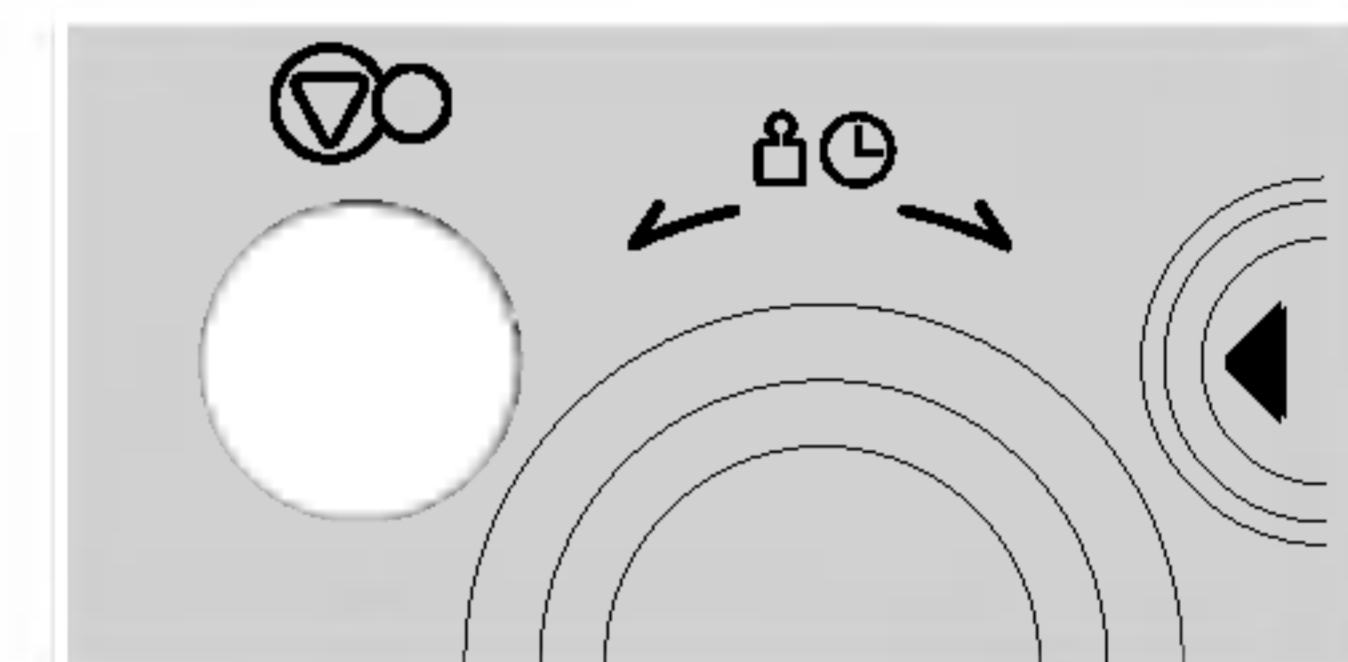

GB

Press and hold **STOP/ CLEAR** until “L” appears on the display and BEEP sounds.
The **CHILD LOCK** is now set.

The time will disappear on the display if you have set the clock.

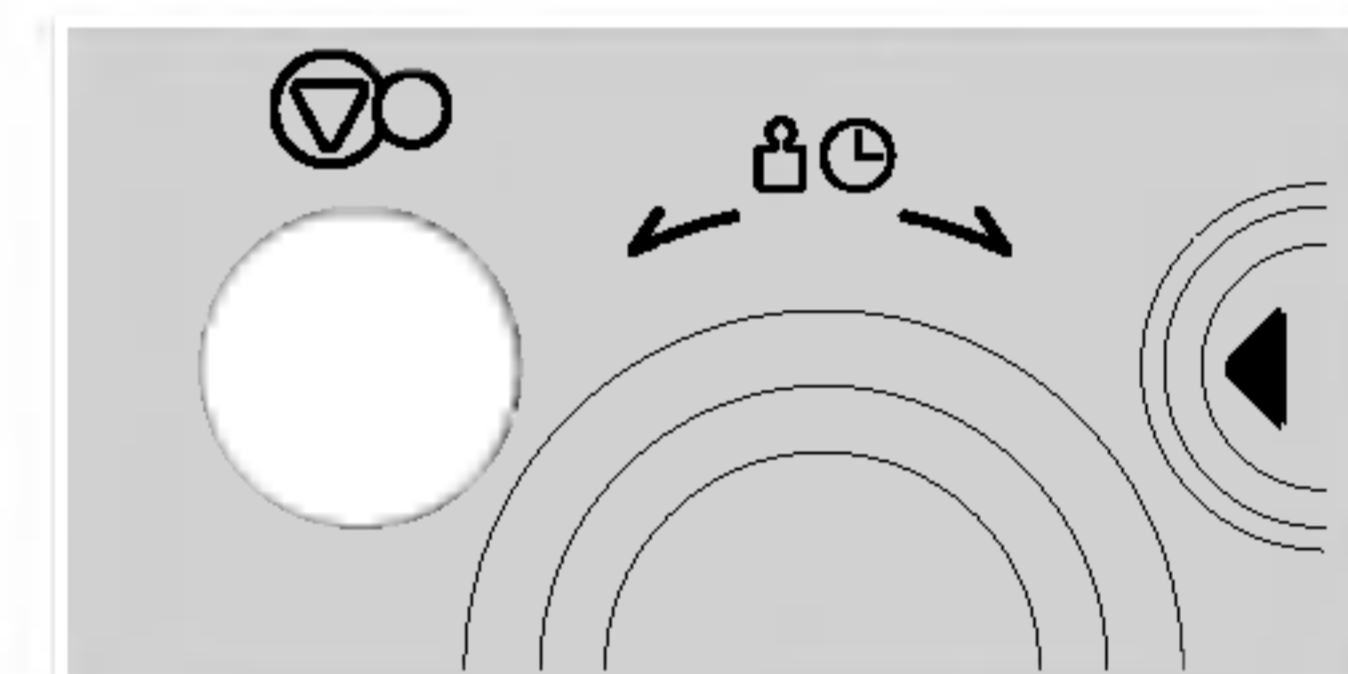

“L” remains on the display to let you know that **CHILD LOCK** is set.



To cancel **CHILD LOCK** press and hold **STOP/ CLEAR** until “L” disappears.
You will hear BEEP when it's released.

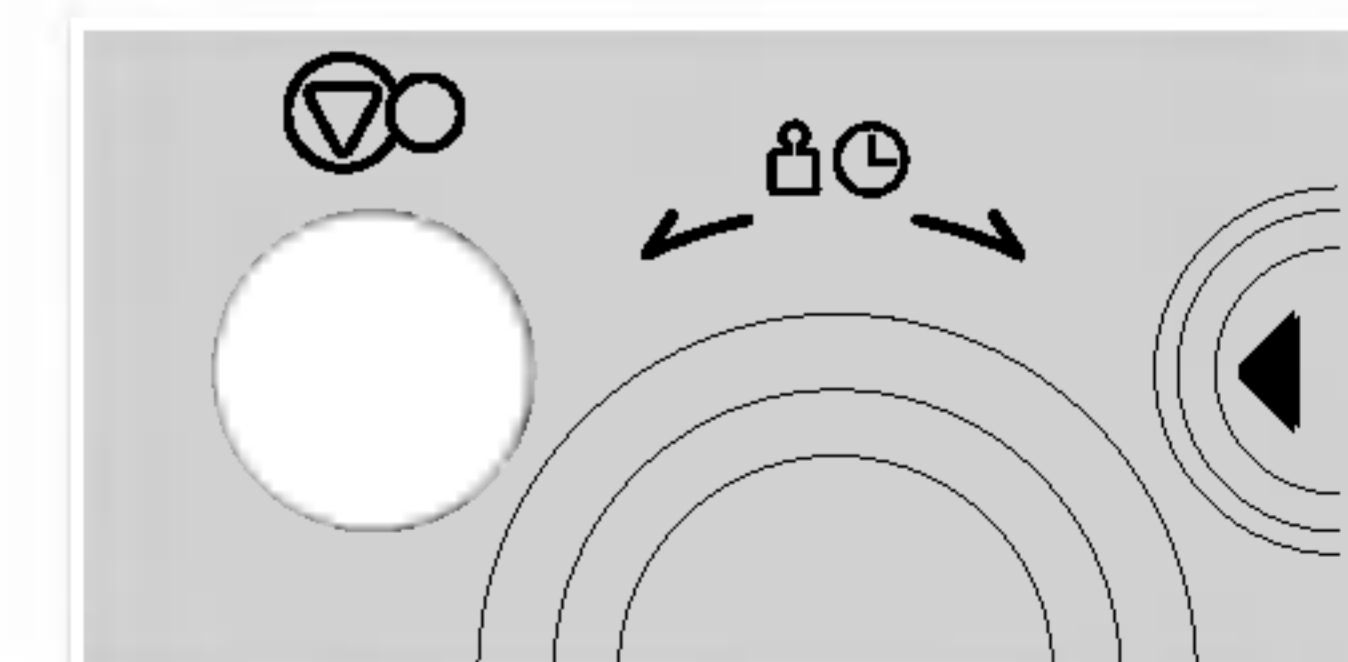
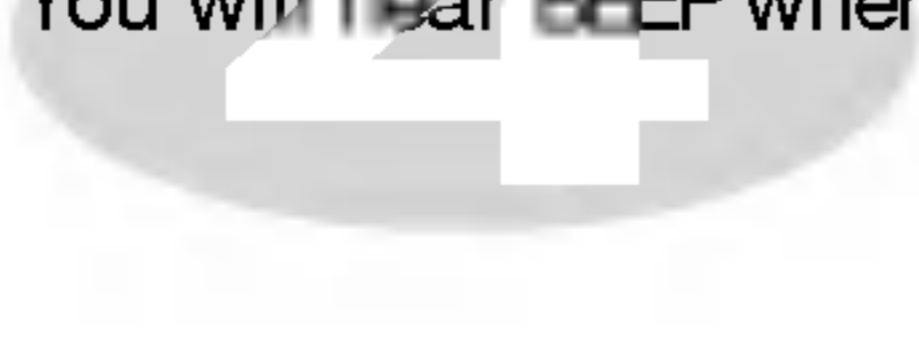

Micro Power Cooking

In the following example I will show you how to cook some food on 80% power for 5 minutes and 30 seconds.

GB



Your oven has five microwave Power settings.

POWER	%	Power Output
HIGH MAX	100%	850W
MEDIUM HIGH	80%	680W
MEDIUM	60%	510W
DEFROST MEDIUM LOW	40%	340W
LOW	20%	170W

Make sure that you have correctly installed your oven as described earlier in this book.

Press **STOP/CLEAR**.

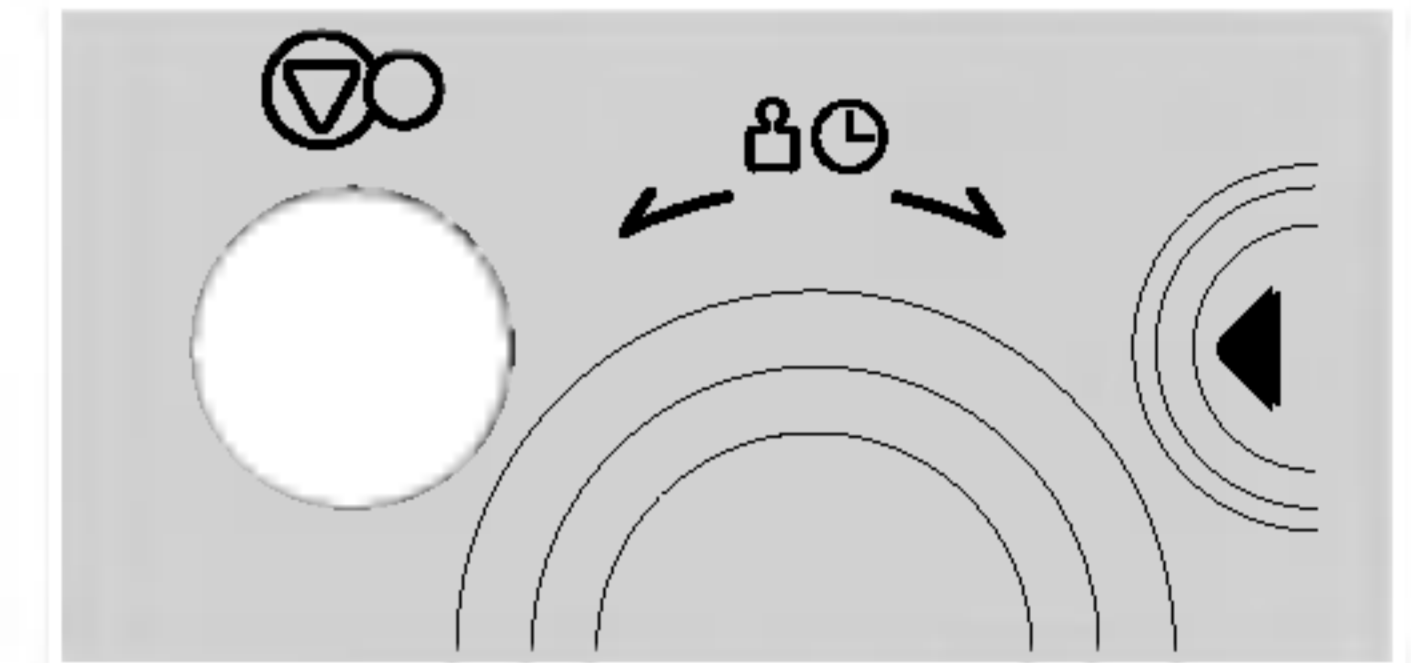

Turn **KNOB** to select the 80%.

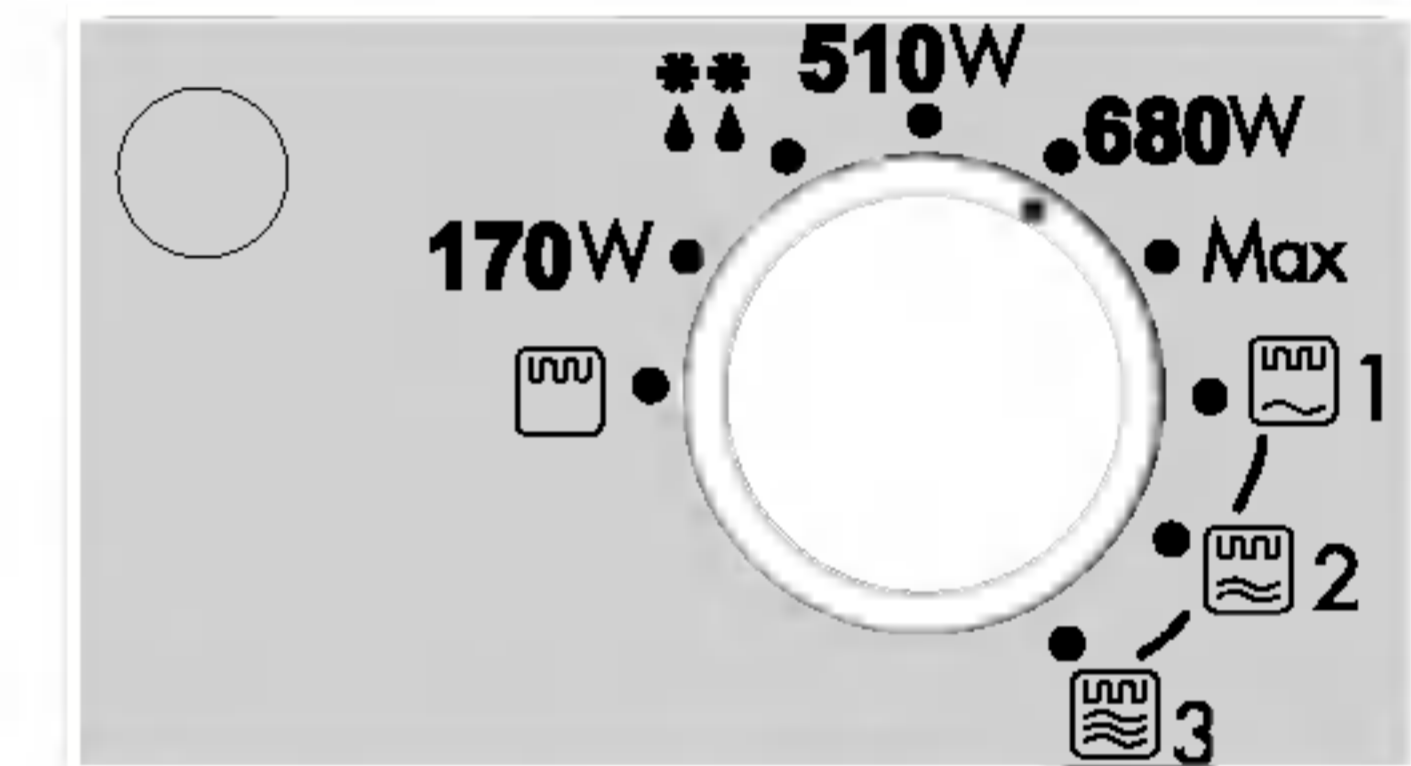

Turn **DIAL** until display shows "5:30".

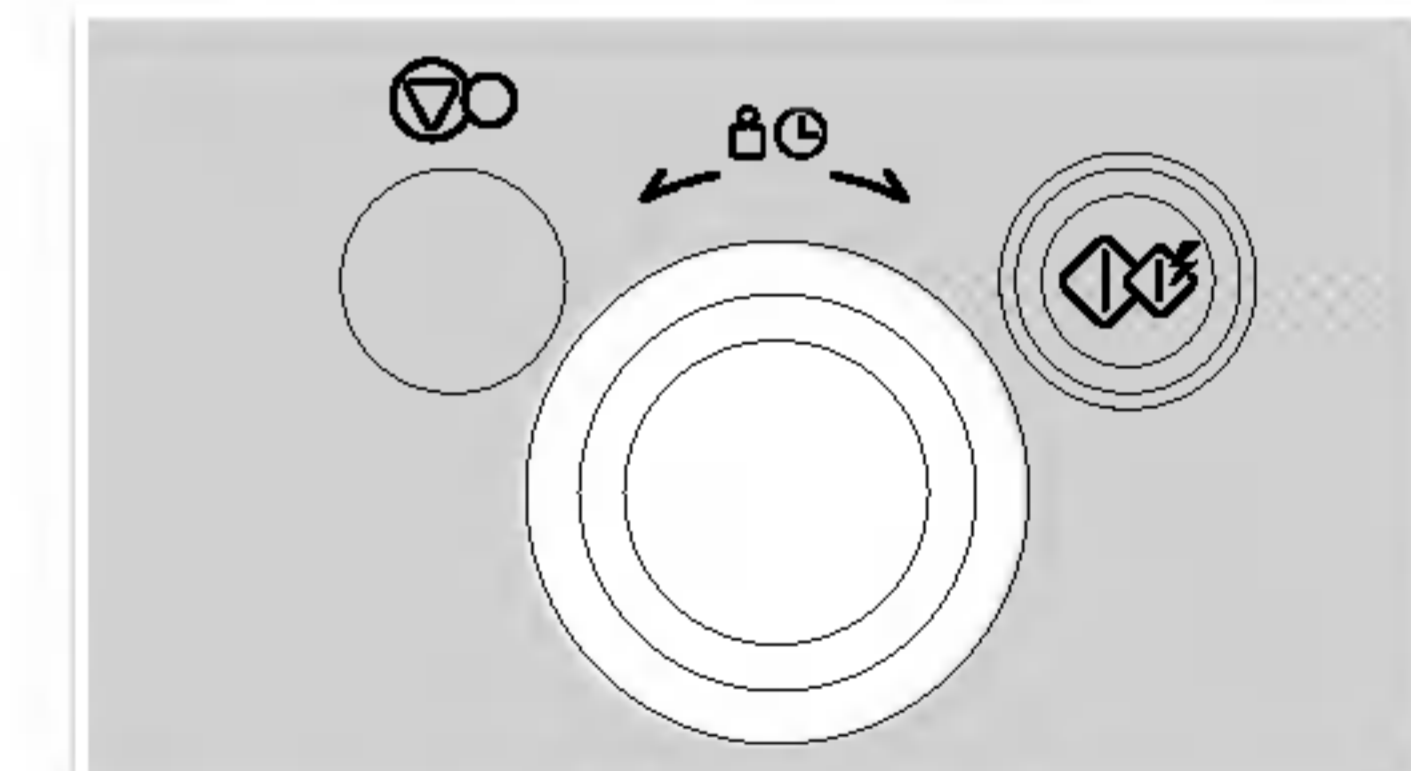

Press **START**.

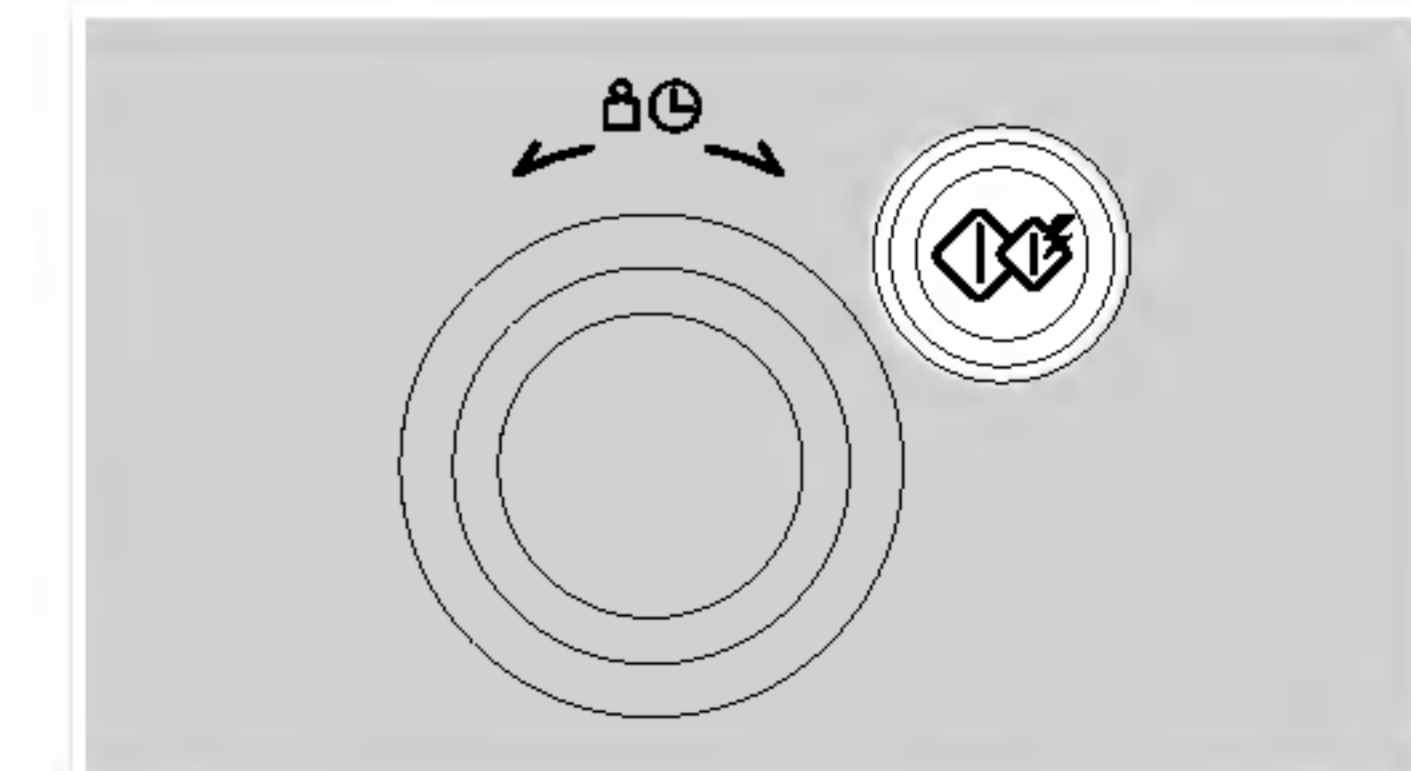

Micro Power Level

Your microwave oven is equipped with 5 power levels to give you maximum flexibility and control over cooking. The table below shows the examples of food and their recommended cooking power levels for use with this microwave oven.

POWER LEVEL	USE	POWER LEVEL (%)	POWER OUTPUT
HIGH	<ul style="list-style-type: none"> * Boil Water * Brown minced beef * Cook poultry pieces, fish, vegetables * Cook tender cuts of meat 	100%	850W
MEDIUM HIGH	<ul style="list-style-type: none"> * All reheating * Roast meat and poultry * Cook mushrooms and shellfish * Cook foods containing cheese and eggs 	80%	680W
MEDIUM	<ul style="list-style-type: none"> * Bake cakes and scones * Prepare eggs * Cook custard * Prepare rice, soup 	60%	510W
DEFROST/ MEDIUM LOW	<ul style="list-style-type: none"> * All thawing * Melt butter and chocolate * Cook less tender cuts of meat 	40%	340W
LOW	<ul style="list-style-type: none"> * Soften butter & cheese * Soften ice cream * Raise yeast dough 	20%	170W



GB

Quick Start

In the following example I will show you how to set 2 minutes of cooking on high power.

GB



The **QUICK START** feature allows you to set 30 seconds intervals of HIGH power cooking with a touch of the **START** button.

Press **STOP CLEAR**.

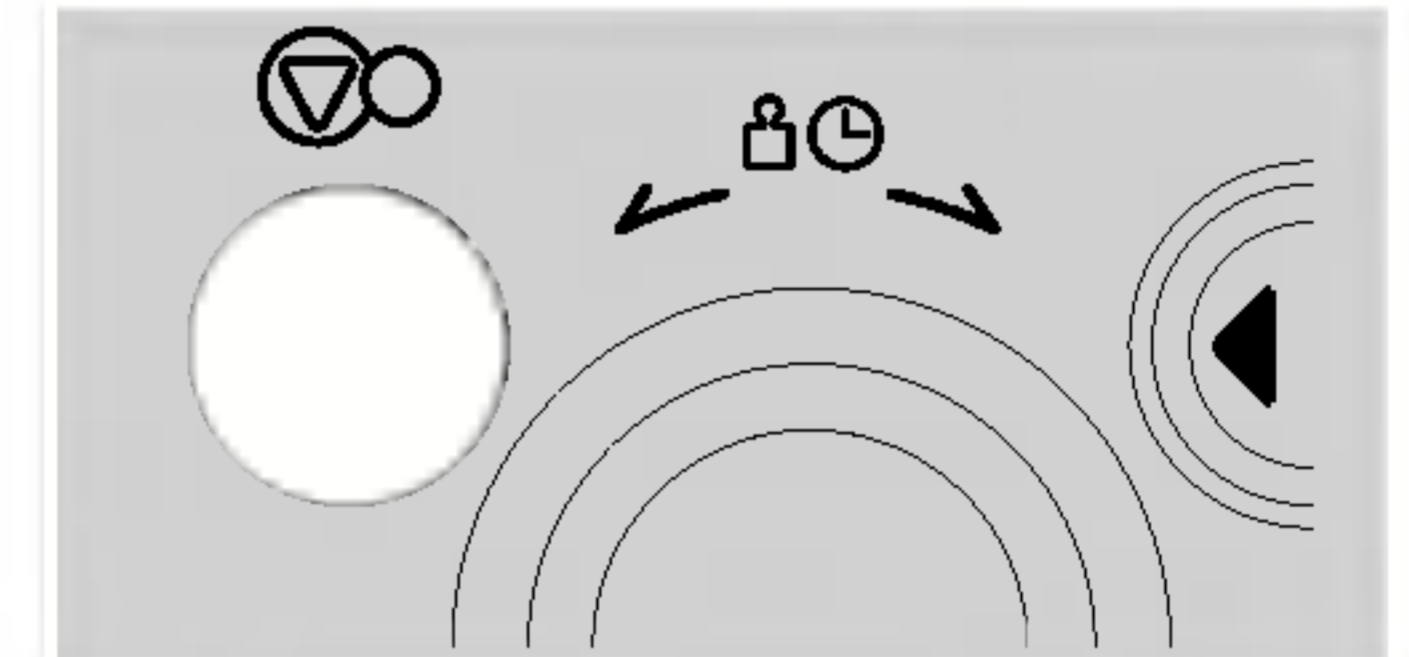

Press **START** four times to select 2 minutes on HIGH power.
Your oven will start before you have finished the fourth press.

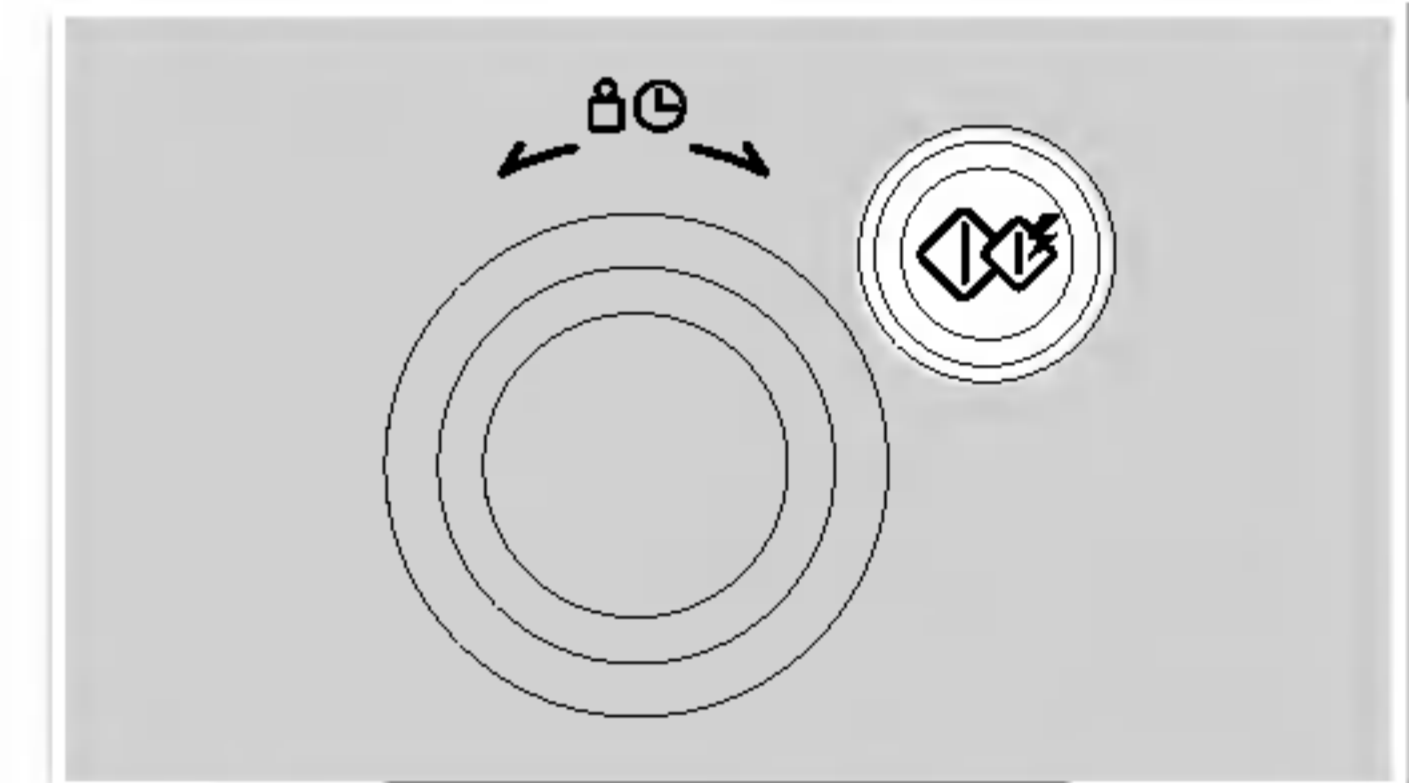
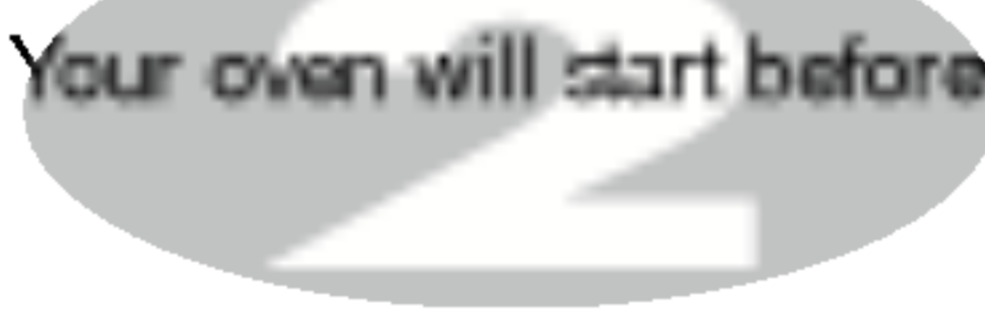

During **QUICK START** cooking, you can extend the cooking time by repeatedly pressing the **START** button.



Grill Cooking

In the following example I will show you how to use the grill to cook some food for 12 minutes and 30 seconds.



This feature will allow you to brown and crisp food quickly.

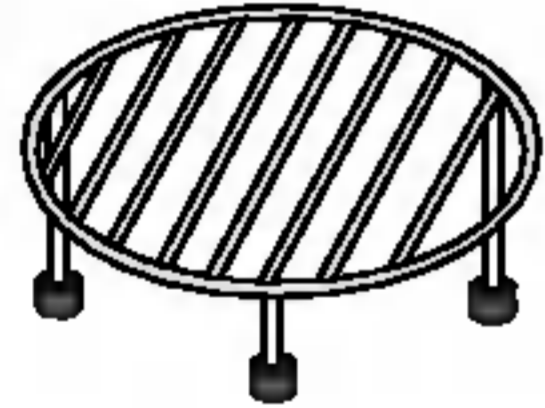
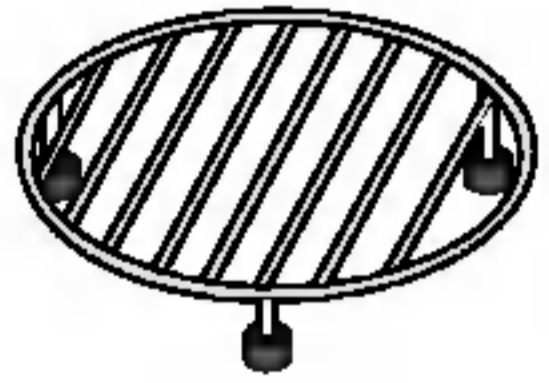

Press **STOP/CLEAR**

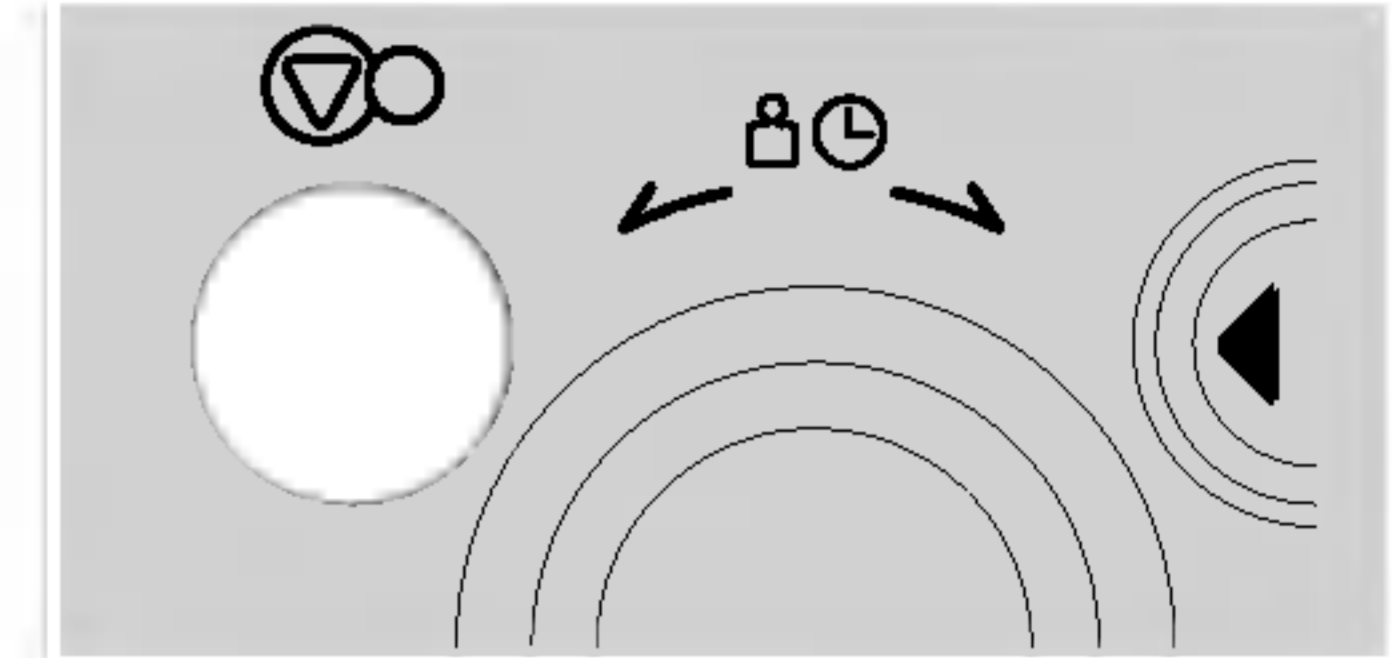

GB

Turn **KNOB** to select the grill mode.

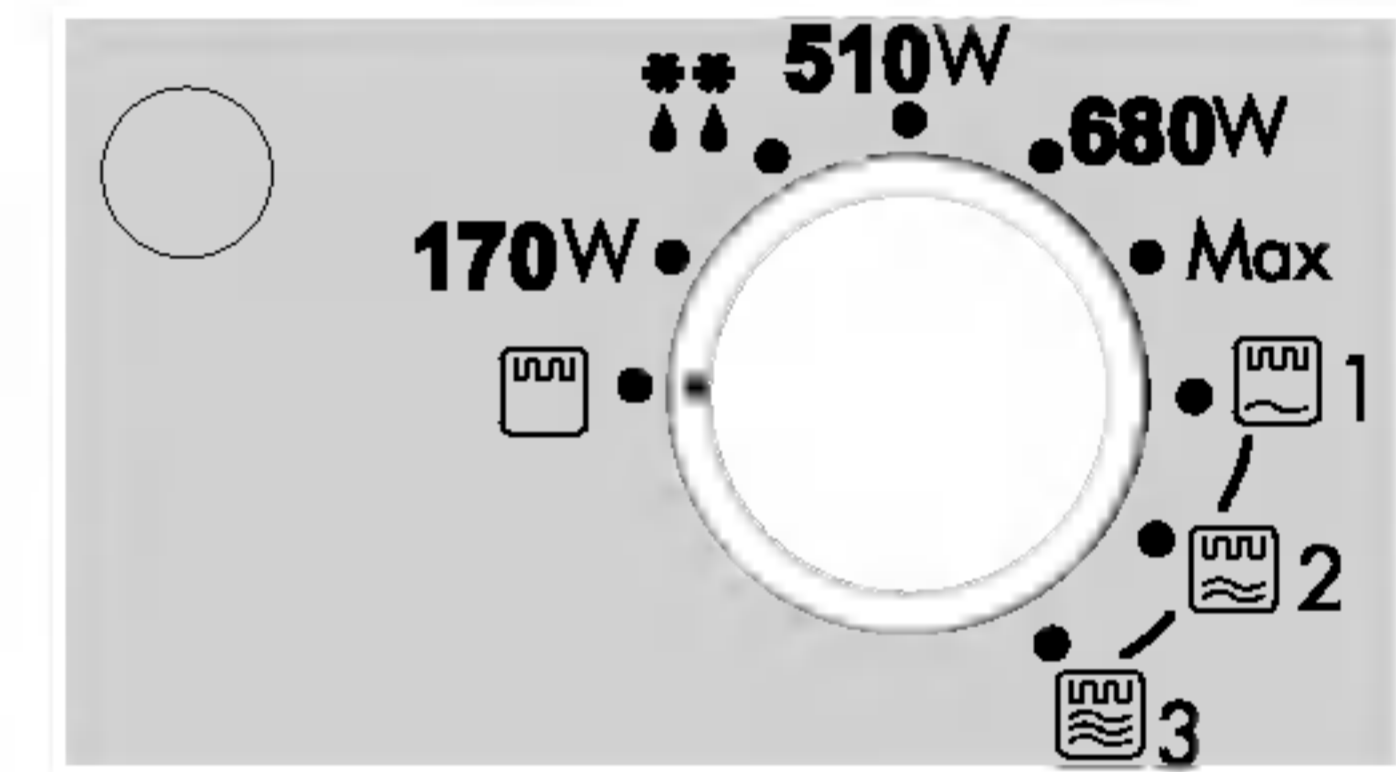

Turn **DIAL** until display shows "12:30".

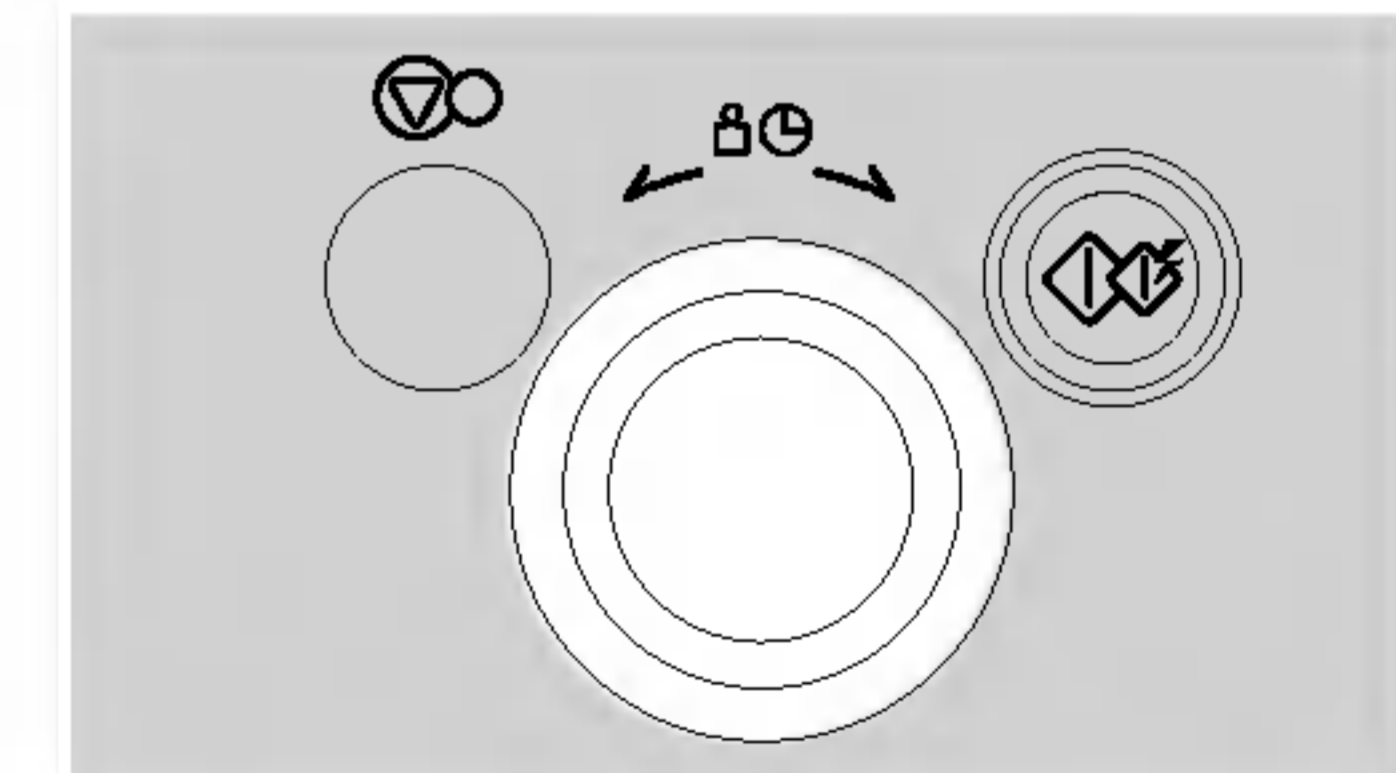

Press **START**.

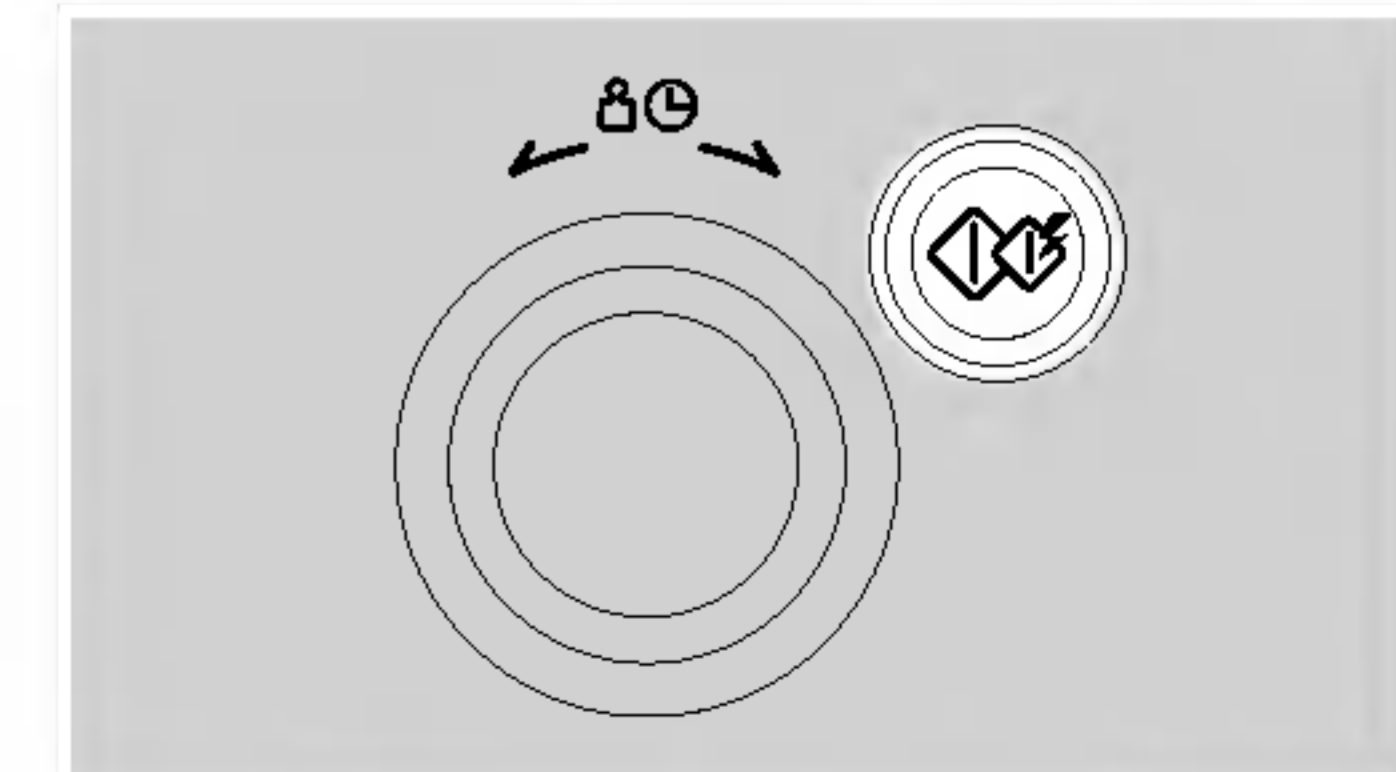

Combination Cooking

In the following example I will show you how to programme your oven with combi mode Co-3 for a cooking time of 25 minutes.

GB



Your oven has a combination cooking feature which allows you to cook food with **heater** and **microwave** at the same time or alternately. This generally means it takes less time to cook your food.

The **sheath heater** grills the surface of the food while **microwave** heats inside. Moreover, preheating your oven is not necessary.

Press **STOP/CLEAR**.

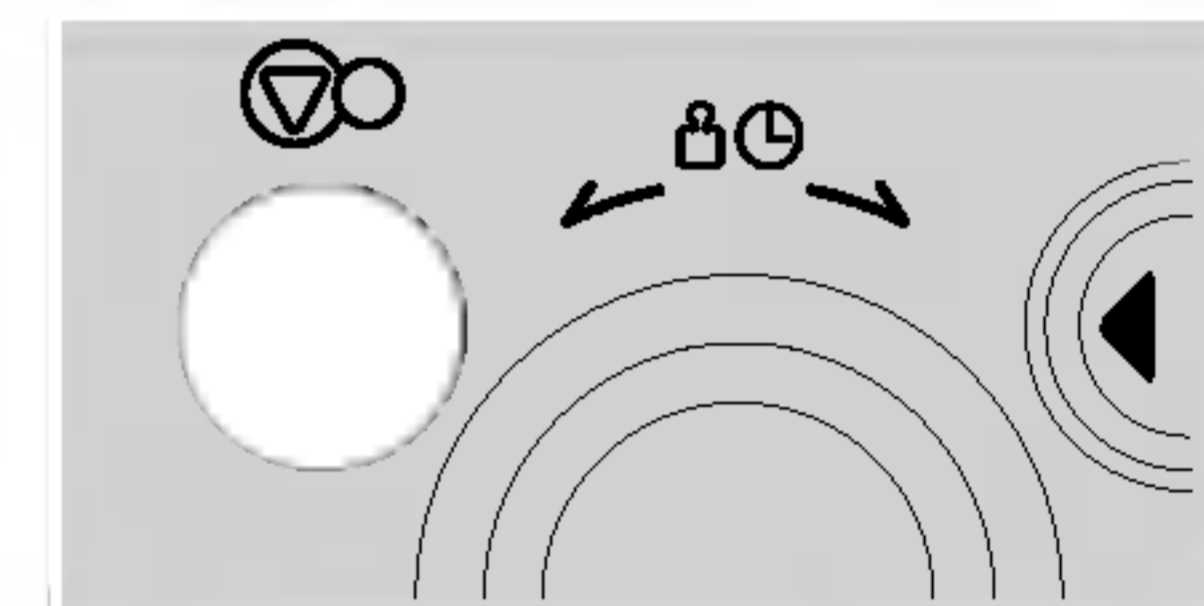

Turn **KNOB** to select the Combi-3 mode.

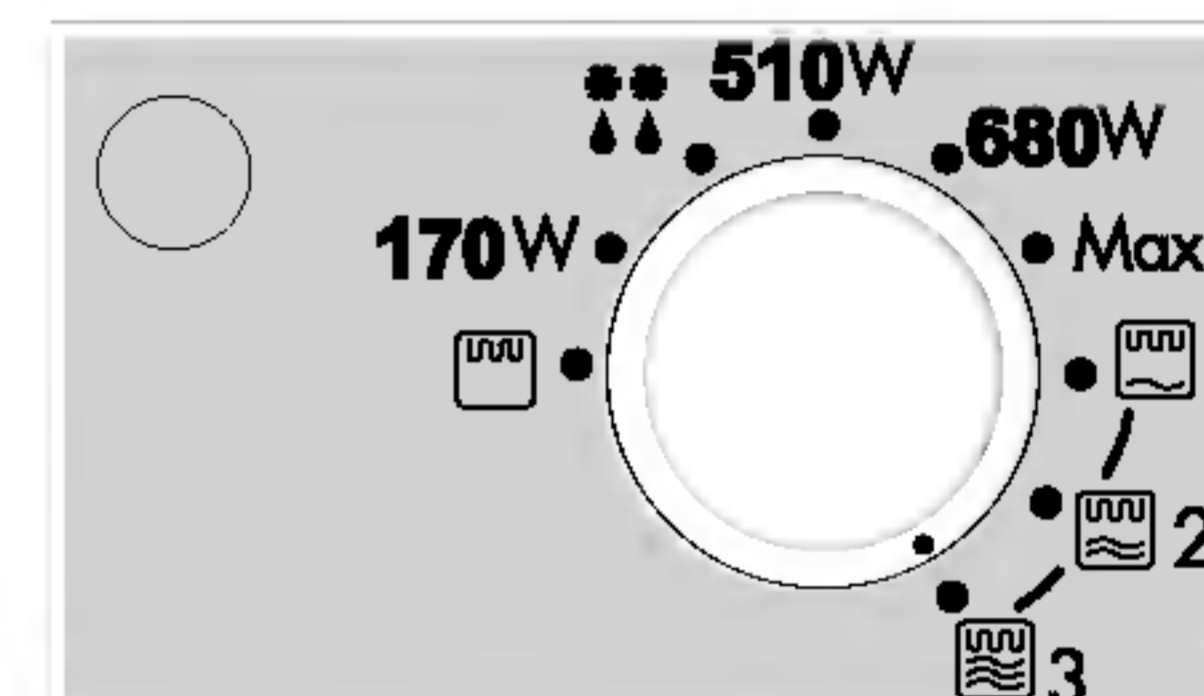

Turn **DIAL** until display shows "25:00".

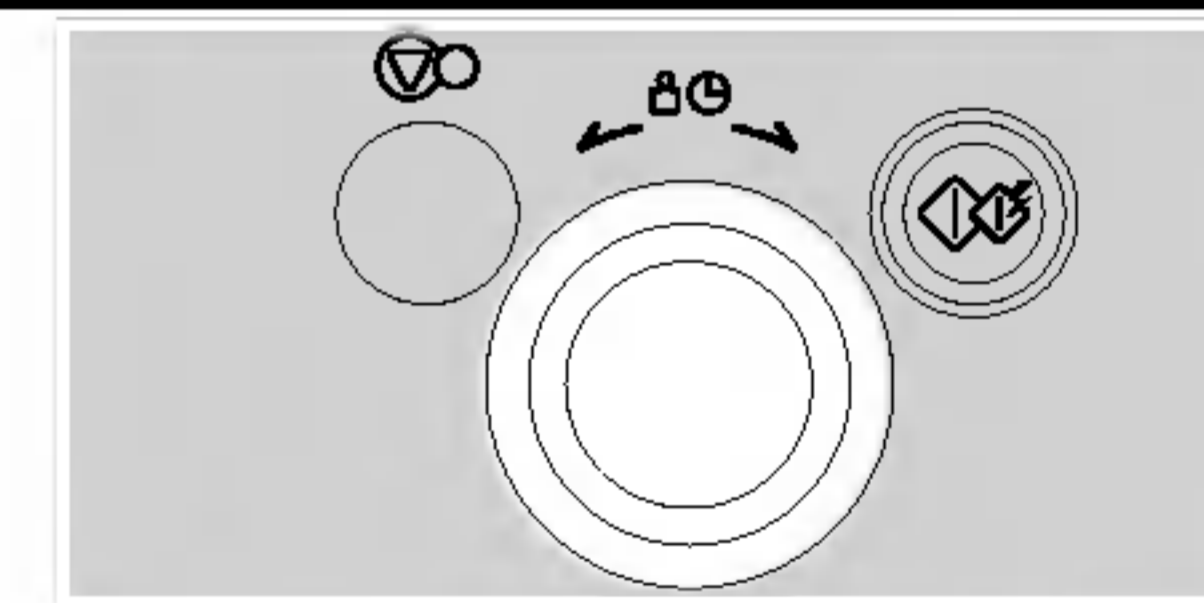

Press **START**.



Be careful when removing your food because the container will be hot!

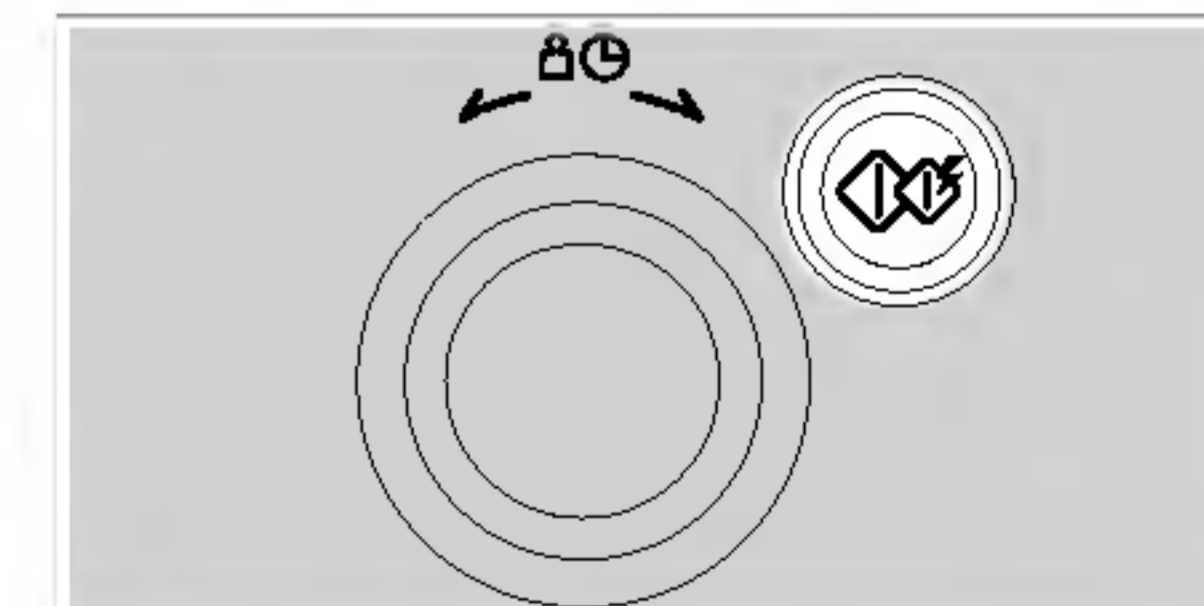

Combination Cooking Mode

CATEGORY	MICRO POWER (%)	HEATER POWER (%)
Co-1	20	80
Co-2	40	60
Co-3	60	40

Auto Cook

In the following example I will show you how to cook 0.6kg of fresh vegetable.



AUTO COOK allows you to cook most of your favorite food easily by selecting the food type and entering the weight of the food.

Category	Press AUTO COOK
Jacket potato	1 time
Fresh vegetable	2 times
Frozen vegetable	3 times
Rice	4 times
Popcorn	5 times
Chilled pizza	6 times
Sauce	7 times
Curry, reheat	8 times

Press **STOP CLEAR**.

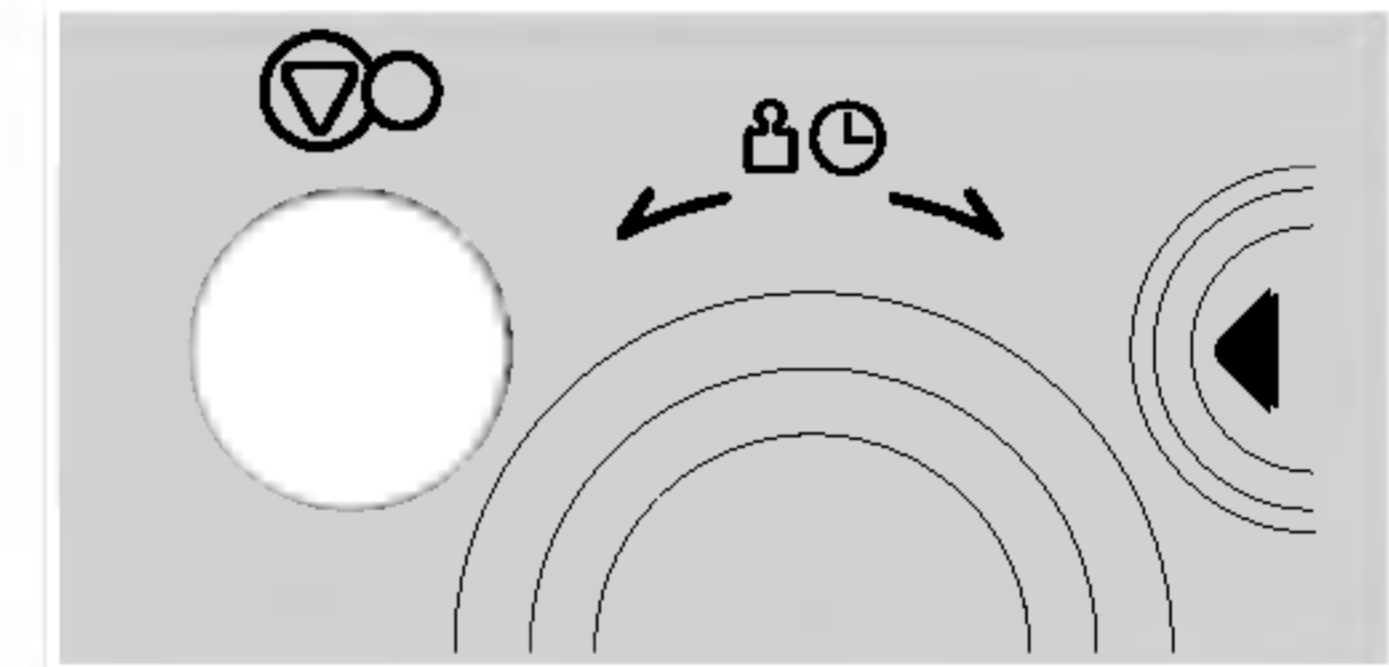

GB

Press **AUTO COOK** twice to select Fresh vegetable.

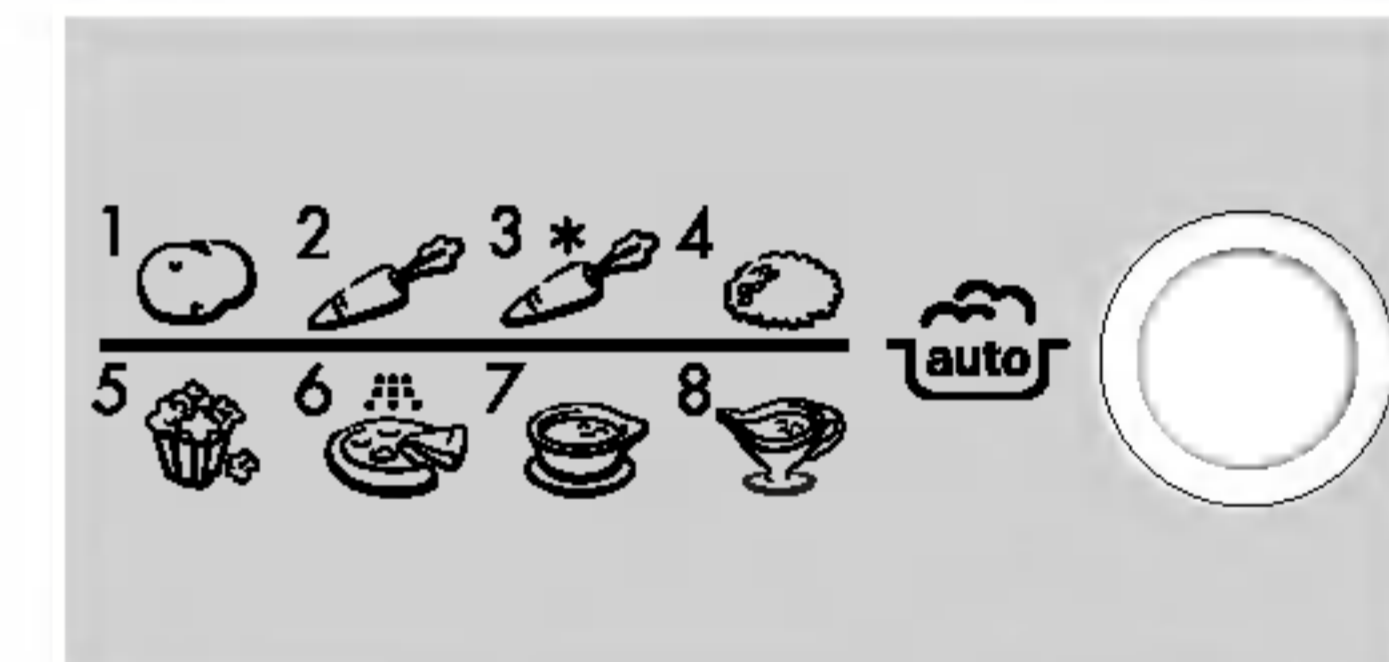

Turn **DIAL** until display shows "0.6".



Press **START**.

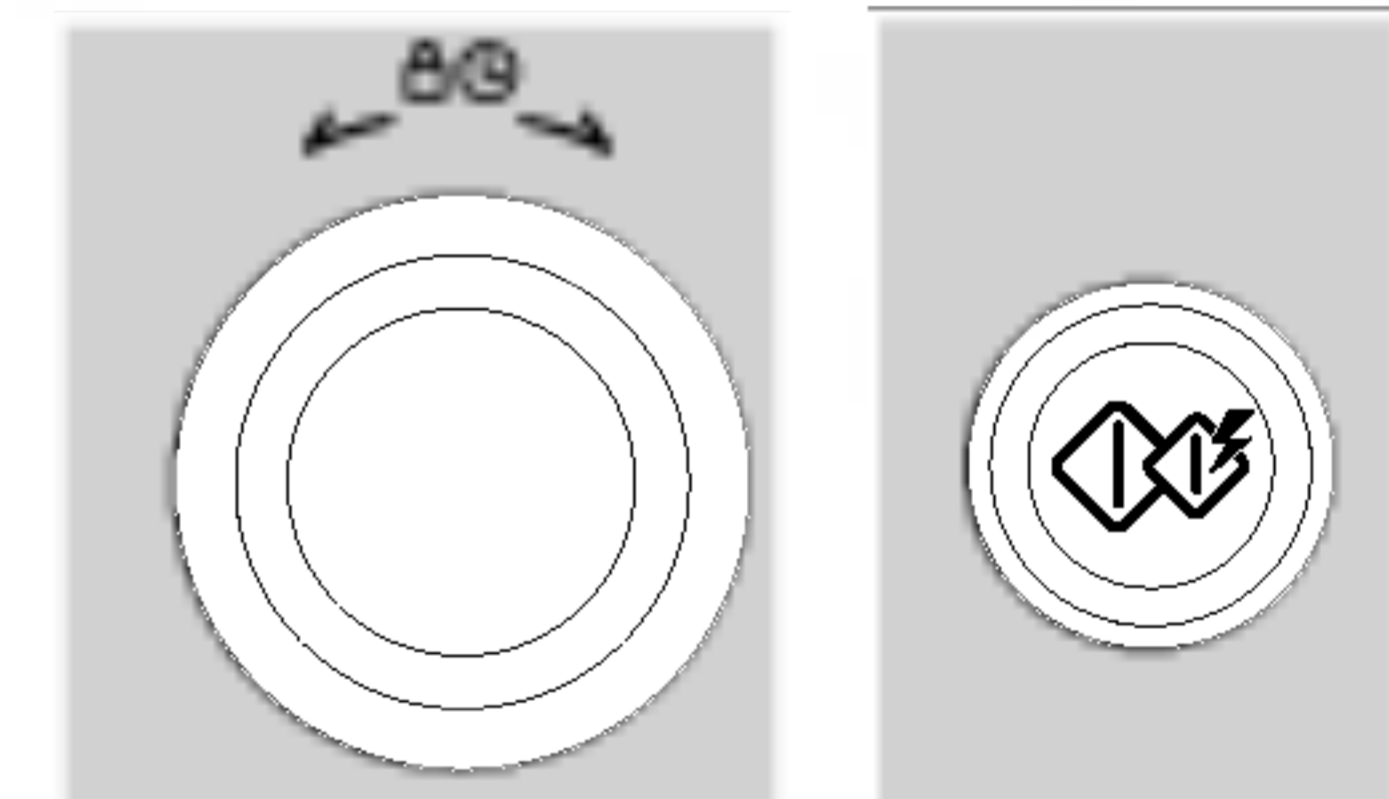

GB

FOOD CATEGORY	FOOD TEMP.	UTENSILS	WEIGHT LIMIT	INSTRUCTIONS										
1. Jacket potato	Room	On Glass tray	0.1 kg ~ 1.0 kg	Choose medium sized potatoes 170-200g . Wash and dry potatoes. Pierce the potatoes several times with fork. Place the potatoes on the glass try. Adjust weight and press start. After cooking, remove the potatoes from the oven. Let stand covered with foil for 5 minutes.										
2. Fresh vegetable	Room	Microwave-safe bowl	0.2 kg ~ 0.8 kg	Place vegetables in a microwave-safe bowl. Add water. Cover with wrap. After cooking, stir and allow to stand for 2 minutes. Add amount of water according to the quantity. ** 0.2kg - 0.4kg : 2 Tablespoon ** 0.5kg - 0.8kg : 4 Tablespoon										
3. Frozen vegetable	Frozen	Microwave-safe bowl	0.2 kg ~ 0.8 kg	Place vegetables in a microwave-safe bowl. Add water. Cover with wrap. After cooking, stir and allow to stand for 2 minutes. Add amount of water according to the quantity. ** 0.2kg - 0.4kg : 2 Tablespoon ** 0.5kg - 0.8kg : 4 Tablespoon										
4. Rice	Room	Microwave-safe bowl	0.1 kg ~ 0.3 kg	Wash rice. Darin water. Plase rice & boiling water in a deep and large bowl. <table border="1" data-bbox="1685 1402 2706 1558"> <tr> <td>Weight</td> <td>100g</td> <td>200g</td> <td>300g</td> <td>Cover</td> </tr> <tr> <td>Boiling water</td> <td>200ml</td> <td>400ml</td> <td>600ml</td> <td>Yes/Vent corner</td> </tr> </table> ** Rice -- After cooking, stand covered for 5 minutes or until water is absorbed.	Weight	100g	200g	300g	Cover	Boiling water	200ml	400ml	600ml	Yes/Vent corner
Weight	100g	200g	300g	Cover										
Boiling water	200ml	400ml	600ml	Yes/Vent corner										

FOOD CATEGORY	FOOD TEMP.	UTENSILS	WEIGHT LIMIT	INSTRUCTIONS
5. Popcom	Room	Bag on the glass tray	100g	Use popcorn product for microwave oven . Remove plastic overwrap. Place unfolded bag on the glass tray. (Follow the package directions) After popping, remove bag from the oven. CAUTION: Product is HOT! Open bag carefully by pulling diagonally on corners
6. Chilled pizza	Refrigerated	Microwave-safe bowl	0.1 kg ~ 0.4 kg	This function is for reheating leftover chilled pizza. Place chilled pizza on the flat dish. After heating, stand for 1-2 minutes
7. Sauce	Room	Microwave-safe bowl	0.2kg ~ 0.6 kg	Pour the sauce into a microwave-safe bowl. Cover with lid or plastic wrap. After heating, stir. Stand for 2 minutes with cover And then stir again.
8. Curry, reheat	Room	Microwave-safe dish	0.2 kg ~ 0.8 kg	Pour curry into the microwave-safe dish. cover. Place dish on the glass tray. After reheating, stir and then stand for 1-2 minutes cover.

Auto Defrost

The temperature and density of food varies, I would recommend that the food is checked before cooking commences. Pay particular attention to large joints of meat and chicken, some foods should not be completely thawed before cooking. The BREAD programme is suitable for defrosting small items such as rolls or a small loaf. These will require a standing time to allow the centre to thaw. In the following example I will show you how to defrost 1.4 Kg of frozen poultry.

GB



Your oven has four microwave defrost settings:- **MEAT**, **POULTRY**, **FISH** and **BREAD**; each defrost category has different power settings. Repeated presses of the **AUTO DEFROST** button will select a different setting.

Category	Press DEFROST	
MEAT	1	time
POULTRY	2	times
FISH	3	times
BREAD	4	times

Press **STOP CLEAR**

Weight the food that you are about to defrost. Be certain to remove any metallic ties or wraps; then place the food in your oven and close the oven door.

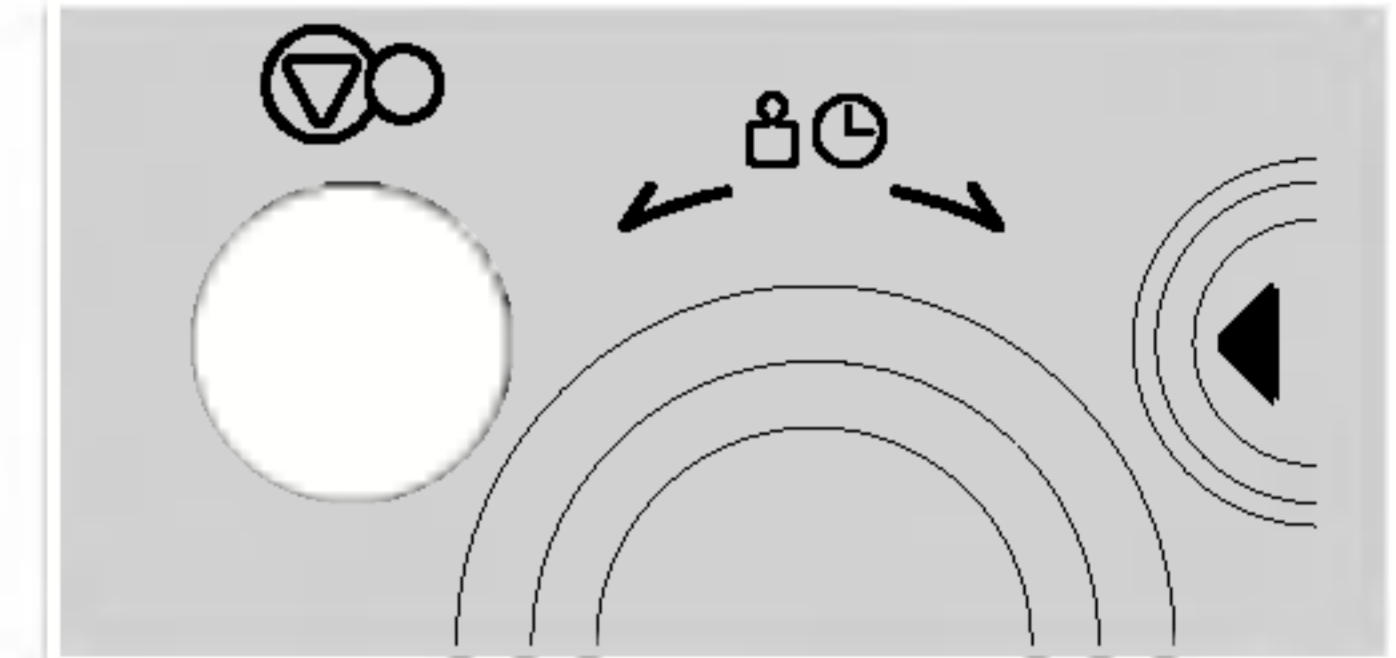

Press **AUTO DEFROST** twice to select the **POULTRY** defrosting programme.

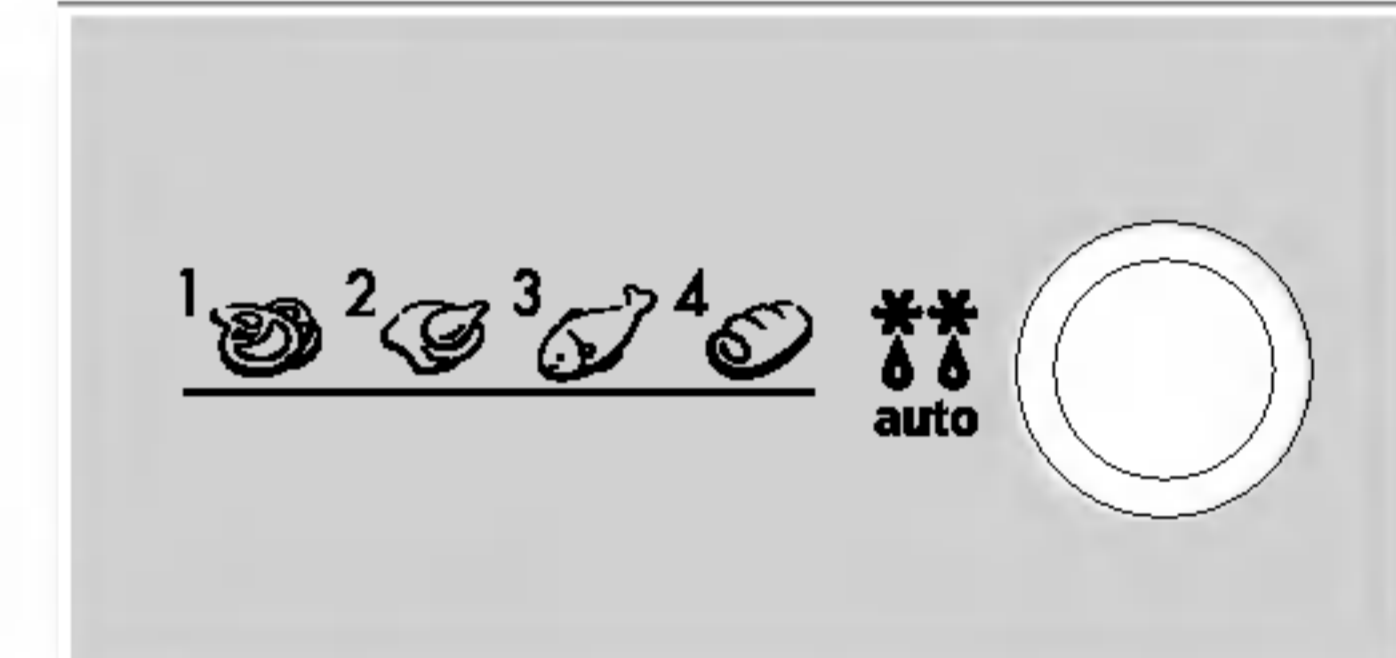

Enter the weight of the frozen food that you are about to defrost.

Turn **DIAL** until display shows "1.4".

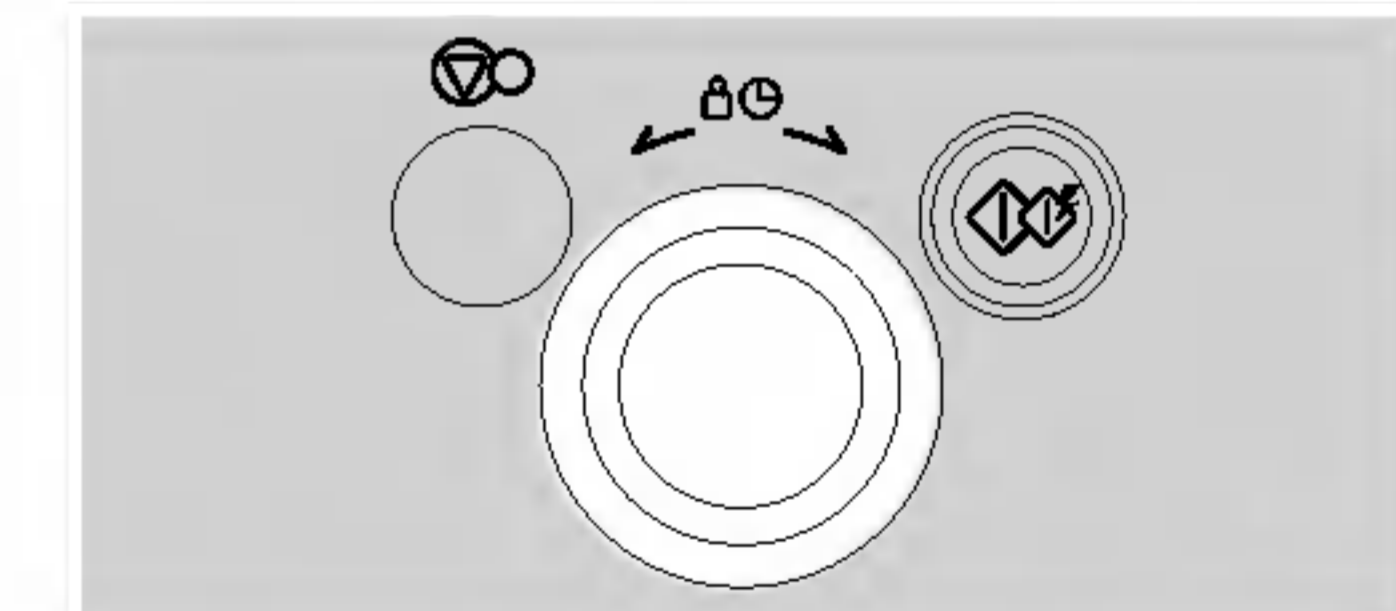

Press **START**

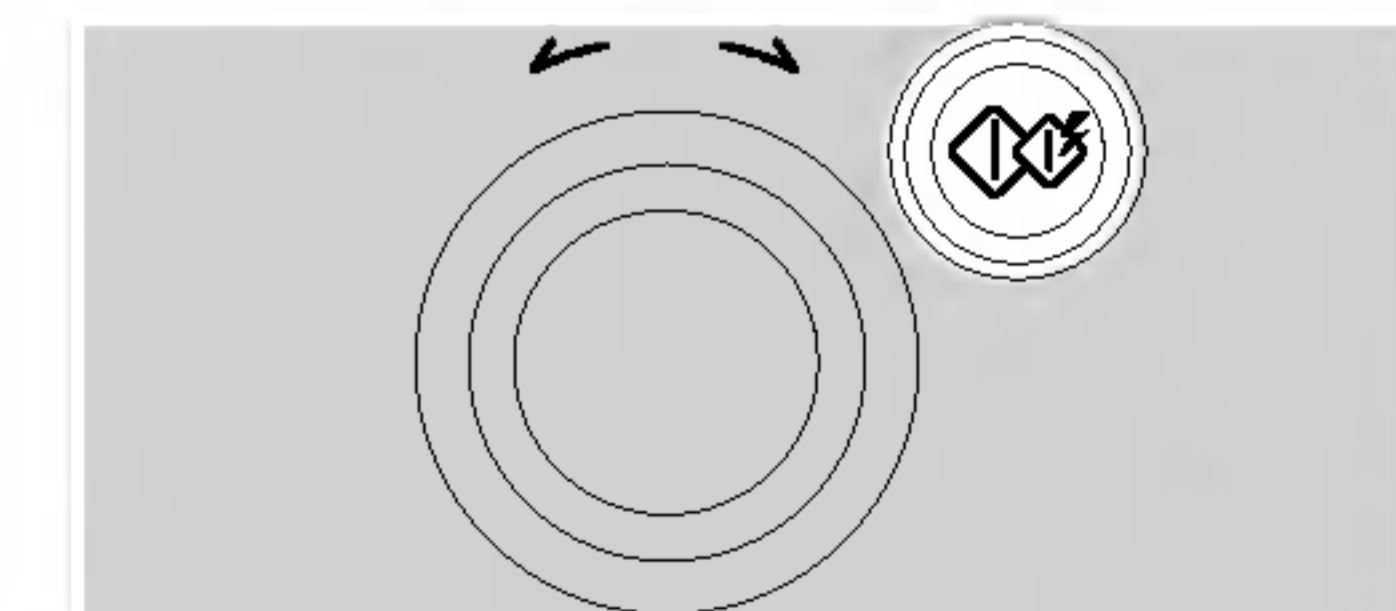

During defrosting your oven will "BEEP", at which point open the oven door, turn food over and separate to ensure even thawing. Remove any portions that have thawed or shield them to help slow down thawing. After checking close the oven door and press **START** to resume defrosting.

Your oven will not stop defrosting (even when the beep sounded) unless the door is opened.

AUTO WEIGHT DEFROST GUIDE

- * Food to be defrosted should be in a suitable microwave proof container and place uncovered on the glass turntable.
 - * If necessary, shield small areas of meat or poultry with flat pieces of aluminum foil. This will prevent thin areas becoming warm during defrosting. Ensure the foil does not touch the oven walls.
 - * Separate items like minced meat, chops, sausages and bacon as soon as possible.
- When BEEP, at this point remove the food from the microwave oven, turn the food over and return to the microwave oven. Press start to continue. At the end of the program, remove the food from the microwave oven, cover with foil and allow to stand until completely thawed.
- To thaw completely, for example joints of meat and whole chickens should STAND for a minimum of 1 hour before cooking.

GB

Category	Weight Limit	Utensil	Food
Meat Poultry Fish	0.1 ~ 4.0 kg	Microwave ware (Flat plate)	Meat Minced beef, Fillet steak, Cubes for stew, Sirloin steak, Pot roast, Rump roast, Beef burger Pork chops, Lamb chops, Rolled roast, Sausage, Cutlets(.2cm) Turn food over at beep. After defrosting, let stand for 5-15 minutes. Poultry Whole chicken, Legs, Breasts, Turkey breasts(under 2.0kg) Turn food over at beep. After defrosting, let stand for 20-30 minutes. Fish Fillets, Steaks, Whole fish, Sea foods Turn food over at beep. After defrosting, let stand for 10-20 minutes.
Bread	0.1 ~ 0.5 kg	Paper towel or flat plate	Sliced bread, Buns, Baguette, etc. Separate slices and place between paper towel or flat plate. Turn food over at beep. After defrosting, let stand for 1-2 minutes.

Quick Defrost

Use this function to thaw only 0.5kg of Minced meat very quickly.

This will require a standing time to allow the center to thaw. In the following example will show you how to defrost 0.5kg of frozen minced meat.

GB



Your oven has a microwave quick defrost setting (MEAT).

Press **STOP CLEAR**.

Weight the food that you are about to defrost. Be certain to remove any metallic ties or wraps; then place the food in your oven and close the oven door.

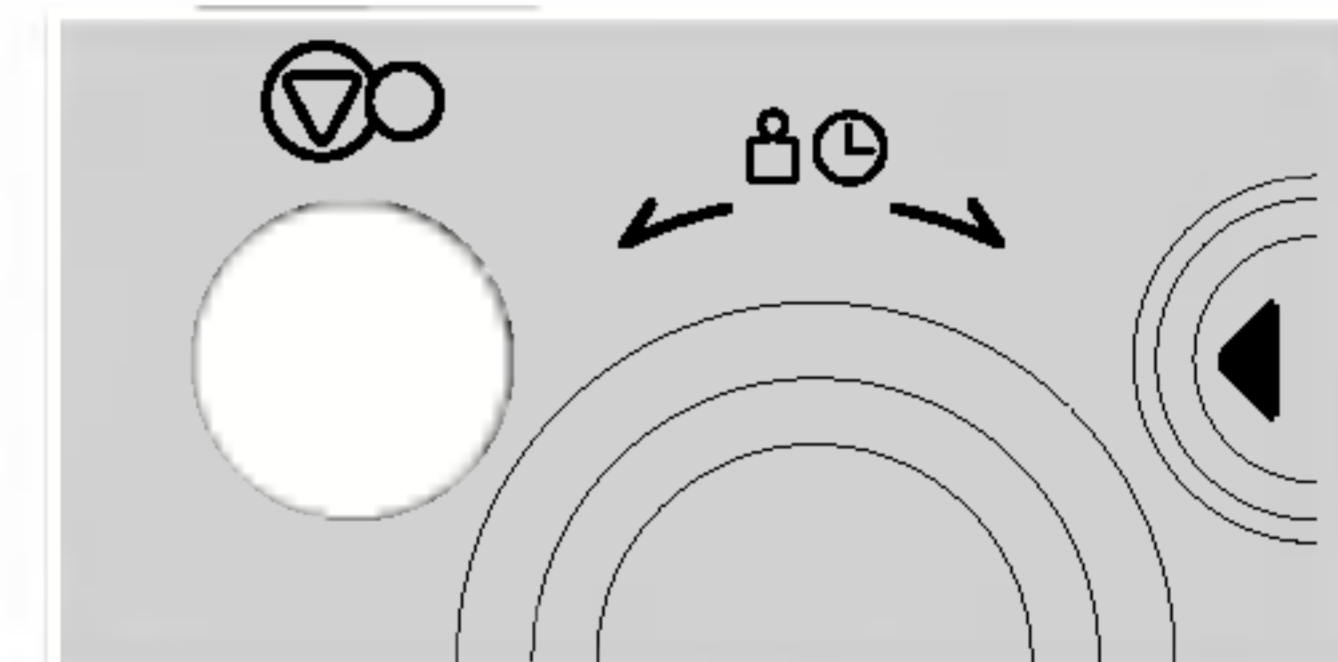

Press **QUICK DEFROST**.

The oven will start automatically.

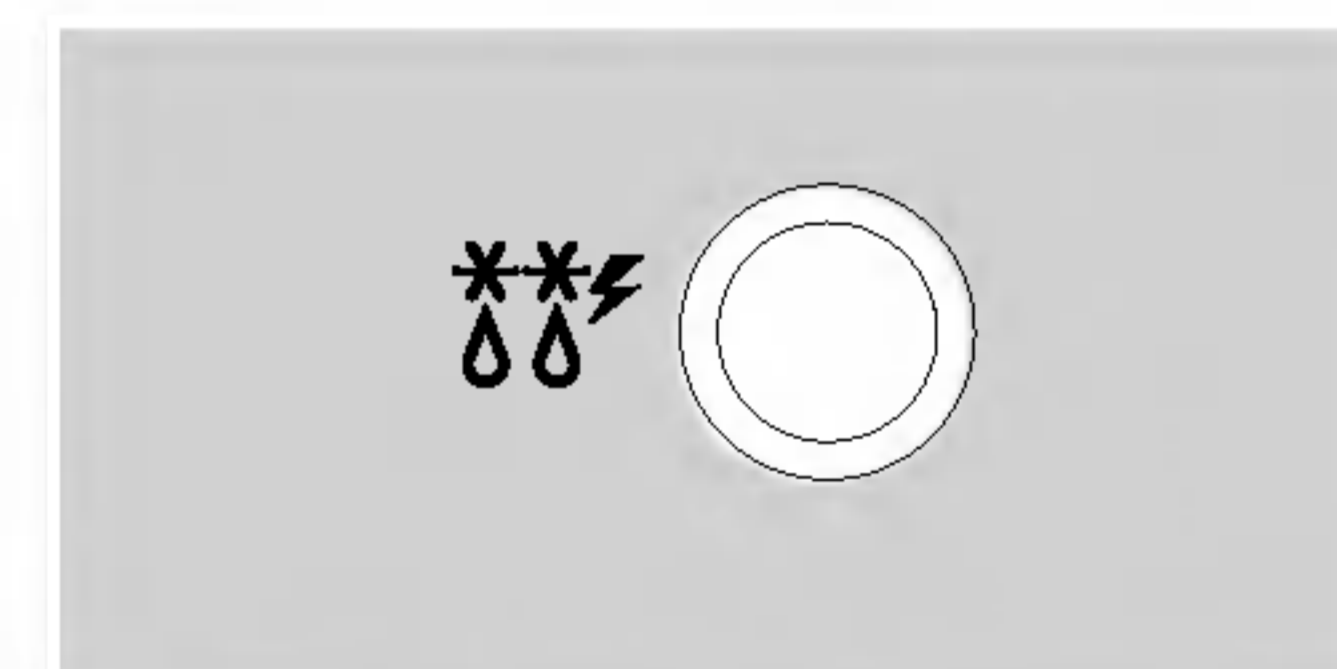

During defrosting your oven will "BEEP", at which point open the oven door, turn food over and separate to ensure even thawing. Remove any portions that have thawed or shield them to help slow down thawing. After checking close the oven door and press **START** to resume defrosting.

Your oven will not stop defrosting (even when the beep sounded) unless the door is opened.

AUTO WEIGHT DEFROST GUIDE

Use this function to defrost quickly for minced meat.

Remove the meat completely from it's wrapping. Place the mince onto a microwave-safe plate. When BEEP, at this point remove the mince from the microwave oven, turn the mince over and return to the microwave oven . Press start to continue. At the end of the program remove the mince from the microwave oven , cover with foil and allow to stand 5-15 minutes or until completely thawed.

GB

CATEGORY	WEIGHT	UTENSIL	INSTRUCTIONS
Minced meat	0.5kg	Microwave ware (Flat plate)	Minced meat Turn food over at beep After defrosting, let stand for 5-15 minutes

Auto Roast

In the following example I will show you how to cook 0.6kg of Roast Pork.

GB



AUTO Roast allows you to cook most of your favorite food easily by selecting the food type and entering the weight of the food.

Category	Press AUTO ROAST
Gratin	1 time
Lasagna	2 times
Grilled shrimps	3 times
Roast beef	4 times
Roast pork	5 times
Chicken pieces	6 times

Press **STOP CLEAR**.

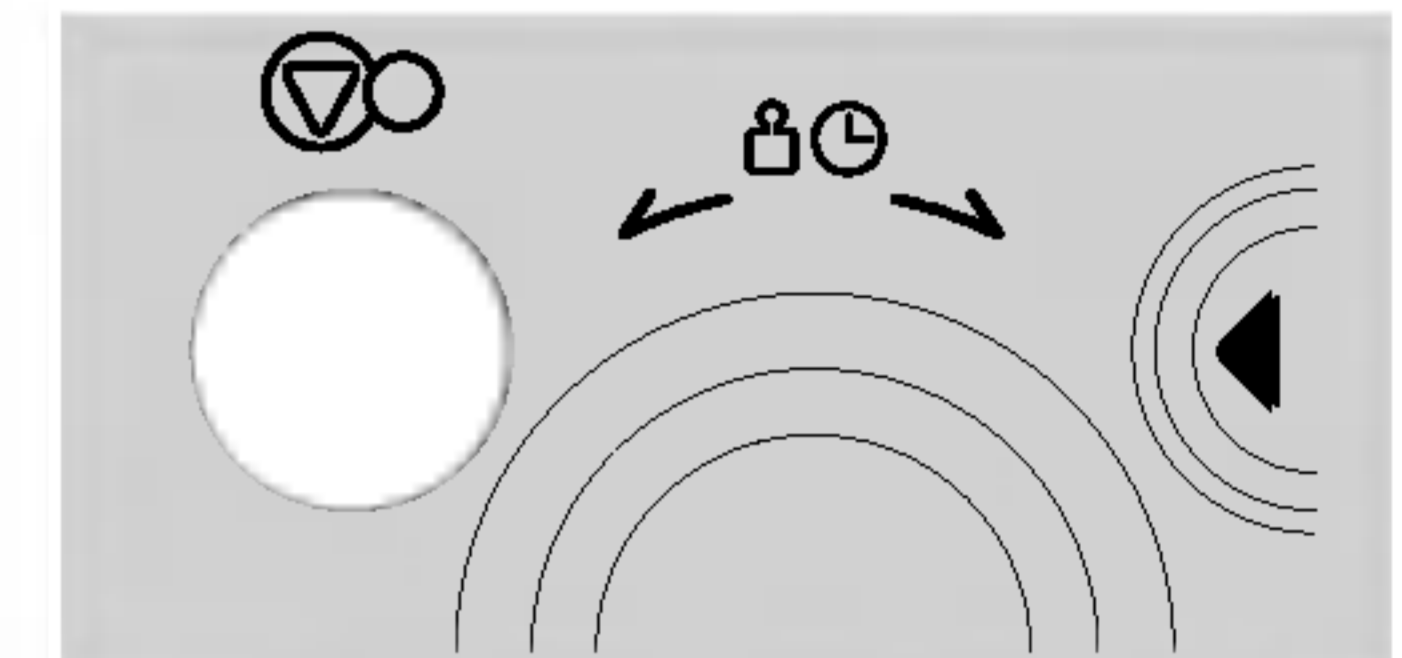

Press **AUTO ROAST** fifth to select Roast Pork.



"Ar-5" appears on the display.

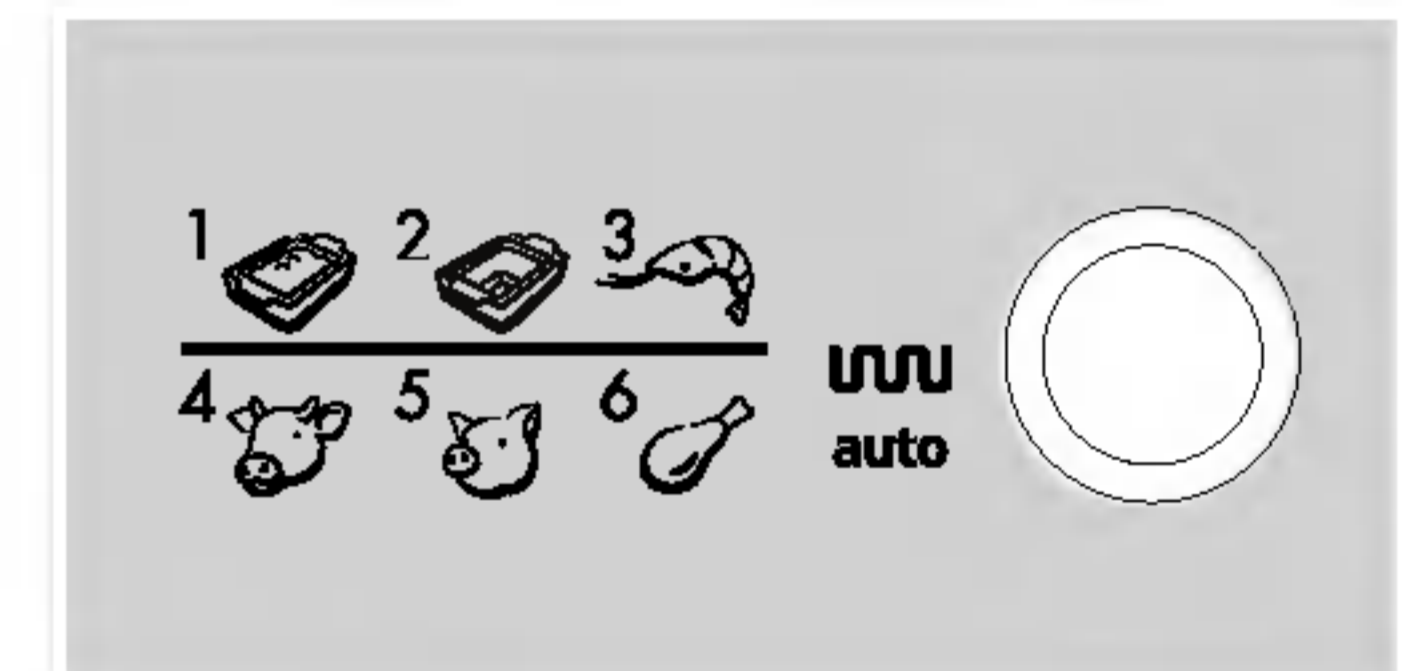

Turn **DIAL** until display shows "0.6".

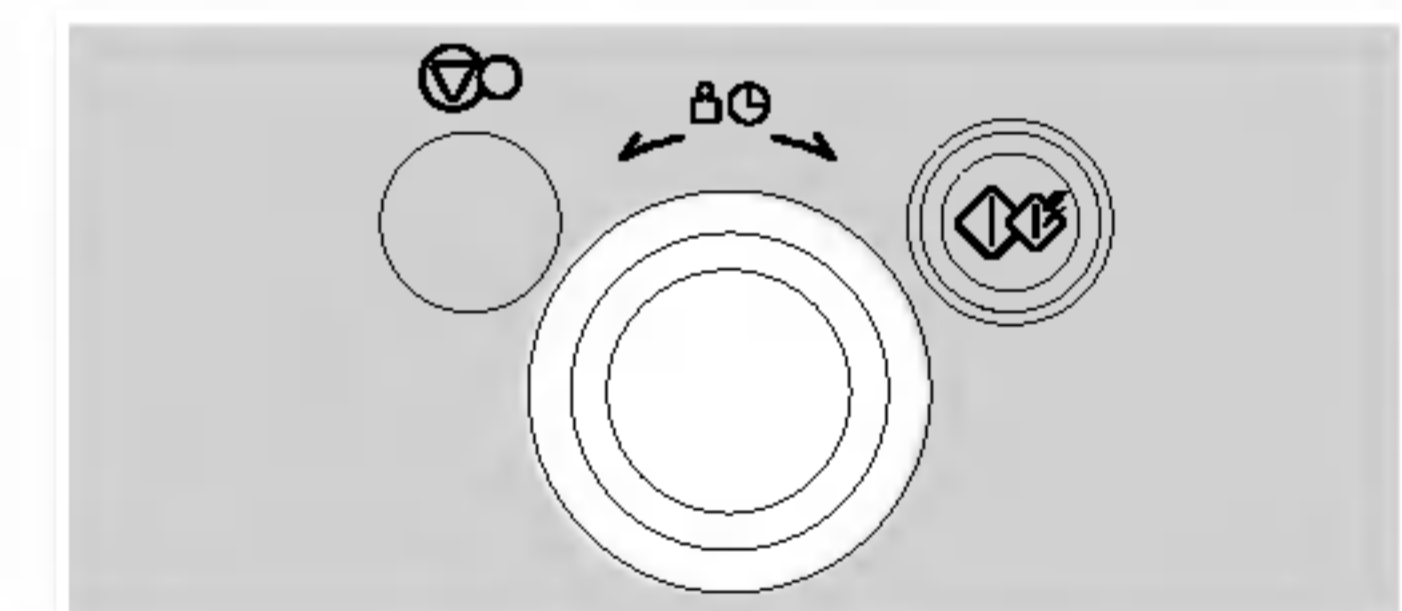

Press **START**.

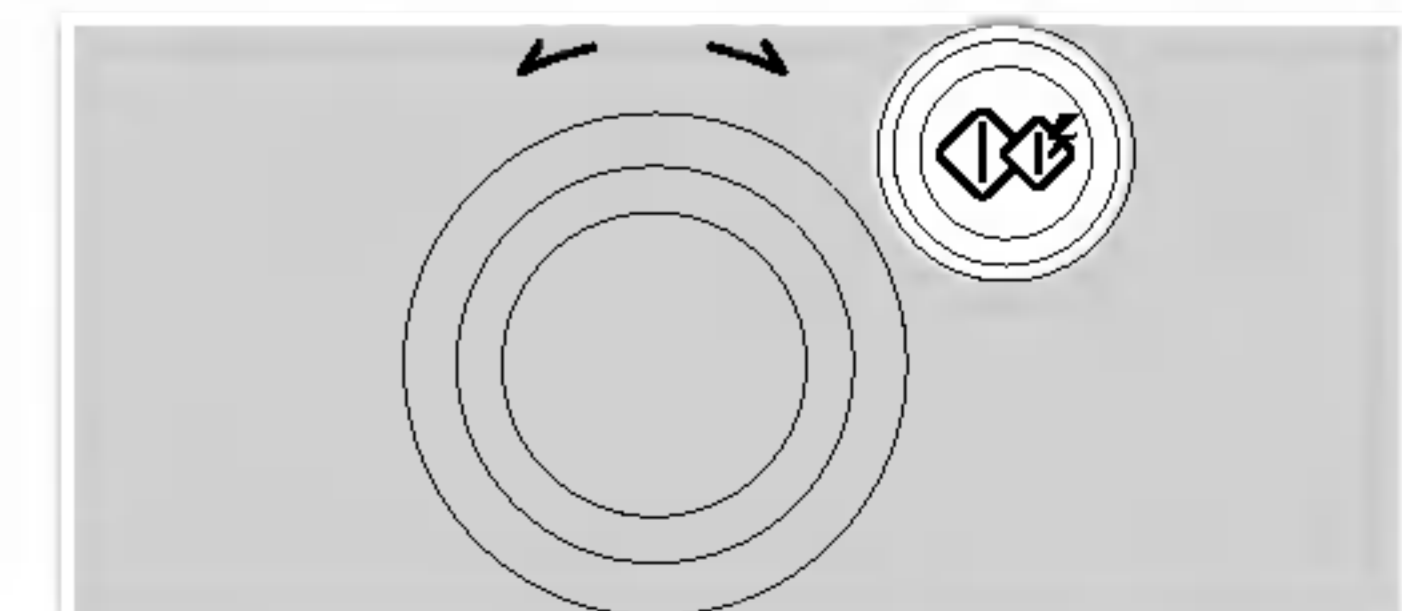

CATEGORY	WEIGHT LIMIT	UTENSIL	FOOD TEMP.	INSTRUCTIONS
1. Gratin	0.5 kg ~ 1.2 kg	Low tray	Room	<p>Use this key to cook home made Gratins. Place food on the low rack. After cooking, remove from oven and stand 1-2 minutes.</p> <p>* Potato Gratin *</p> <p>Ingredients</p> <p>400g potatoes 100g onions(cut into thin slices) 2/3 tablespoon butter 3 slices of bacon 350g white sauce 80g shredded mozzarella cheese Salt, black pepper</p> <p>(White Sauce)</p> <p>3 tablespoon butter, 5 bablespoon flour, 2.5 cups of milk Place butter in a large bowl. Microwave at HIGH until butter melt. Add flour and mincrowave for 2 minutes at HIGH. Add milk, salt and black pepper. Microwave at HIGH for 15 minutes. (During cooking, stir several times.)</p> <p>Method</p> <ol style="list-style-type: none"> 1. Bake potatoes with Jacket Patato Function, And then peel and slice into small size. Add salt, pepper. 2. Combine onionsand butter in a bowl. Microwave at HIGH for 2 minutes. 3. Place one third of the white sauce in gratin dish. Add potatoes, onions and bacon. Cover with the rest of the white sauce. 4. Sprinkle with cheese. Place on low rack on the glass tray. After cooking, stand for 2-3 minutes.

CATEGORY	WEIGHT LIMIT	UTENSIL	FOOD TEMP.	INSTRUCTIONS
2. Lasagne	0.3 kg ~ 0.6kg	Low rack	Refrigerated	REMOVE CARTON & PROTECTIVE FILM ON DINNER. Place on the low rack. After cooking, remove from the oven and let stand for 1-2 minutes
3. Grilled shrimps	0.1 kg ~ 0.6kg	High rack	Refrigerated	Clean and dry. Place on the high rack. The oven will beep, turn food over and press start to continue. After cooking, remove from the oven. And serve.
4. Roast beef	0.5 kg ~ 1.5 kg	Low rack	Refrigerated	Brush the beef with melted margarine or butter. Place on the low rack on the metal tray, The oven will beep, turn food over and press start to continue. After cooking, stand covered with foil for 10 minutes before serving.
5. Roast pork	0.5 kg ~ 1.5 kg	Low rack	Refrigerated	Brush the beef with melted margarine or butter. Place on the low rack on the metal tray, The oven will beep, turn food over and press start to continue. After cooking, stand covered with foil for 10 minutes before serving.
6. Chicken pieces	0.2 kg ~ 0.8 kg	High rack	Refrigerated	Wash and dry skin. Brush the chicken legs with melted margarine or butter. Place on the high rack on the metal tray. The oven will beep, turn food over and press start to continue. After cooking, stand covered with foil for 2-5 minutes .

Special Cook

In the following example I will show you how to cook of special food



Special COOK allows you to cook most of your favorite food easily by selecting the food type and selecting the weight of the food.

Category	Press AUTO COOK
Oatmeal	1 time
Pasta	2 times
Baked beans	3 times
Hotdogs	4 times
Stew	5 times
Scrambled eggs	6 times
grill fish	7 times
sausage	8 times

Press **STOP/CLEAR**.

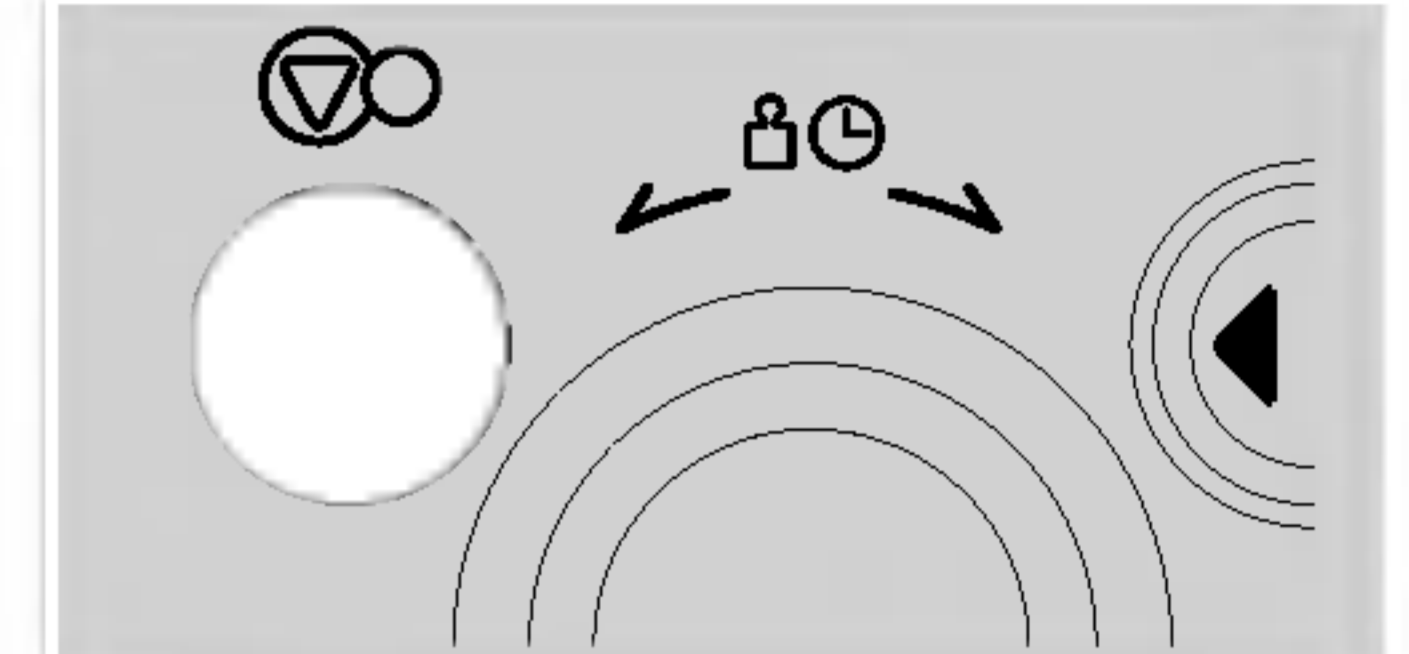

GB

Press **Special Cook** of time to select food type

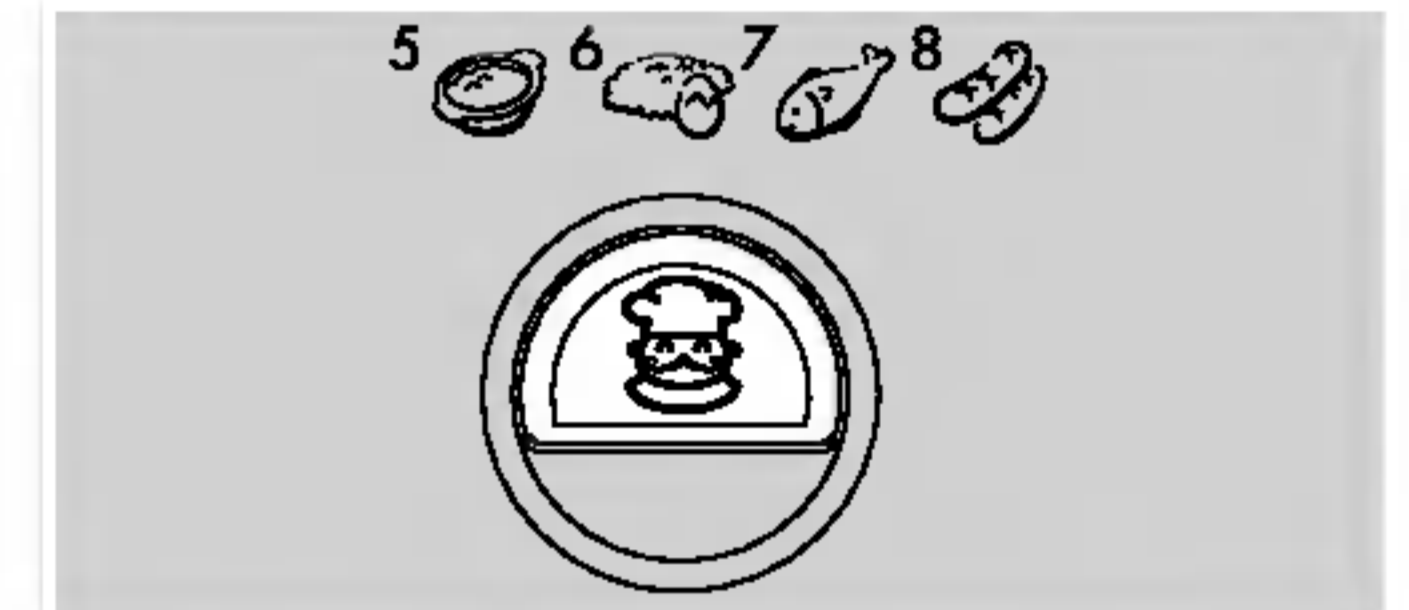

Turn **DIAL** select weight of food

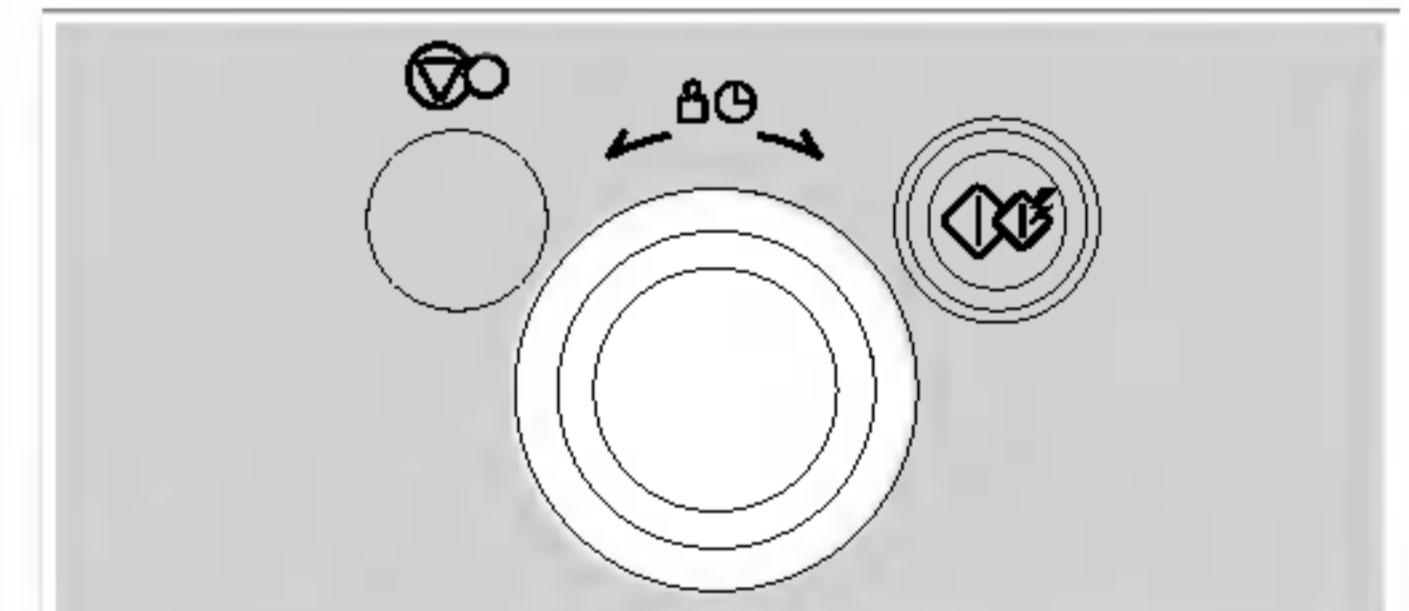

Press **START**.

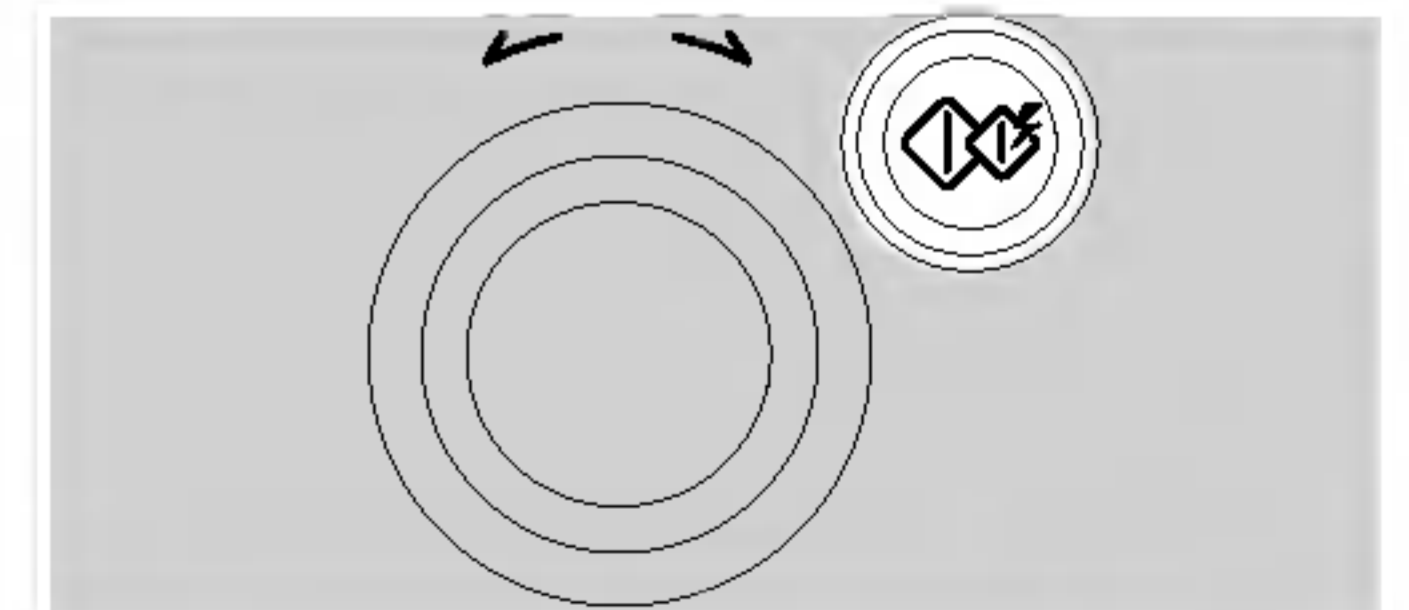

FOOD CATEGORY	FOOD TEMP.	UTENSILS	WEIGHT LIMIT	INSTRUCTIONS															
1. Oatmeal	Room	Microwave-safe bowl	1-4 serves	<p>Choose medium sized potatoes 170-200g . Wash and dry potatoes. Pierce the potatoes several times with fork. Place the potatoes on the glass try. Adjust weight and press start. After cooking,</p> <table border="1" data-bbox="1676 388 2783 751"> <thead> <tr> <th></th> <th>1 serve</th> <th>2 serves</th> <th>3 serves</th> <th>4 serves</th> </tr> </thead> <tbody> <tr> <td>Oats 1 package Approx. 40g</td> <td>1/3 cup (1 package)</td> <td>2/3 cups (2 packages)</td> <td>1 cup (3 packages)</td> <td>1 1/3 cups (4 packages)</td> </tr> <tr> <td>Cold Milk</td> <td>3/4 cup (180 ml)</td> <td>1 1/2 cups (360 ml)</td> <td>2 1/4 cups (540 ml)</td> <td>3 cups (720 ml)</td> </tr> </tbody> </table>		1 serve	2 serves	3 serves	4 serves	Oats 1 package Approx. 40g	1/3 cup (1 package)	2/3 cups (2 packages)	1 cup (3 packages)	1 1/3 cups (4 packages)	Cold Milk	3/4 cup (180 ml)	1 1/2 cups (360 ml)	2 1/4 cups (540 ml)	3 cups (720 ml)
	1 serve	2 serves	3 serves	4 serves															
Oats 1 package Approx. 40g	1/3 cup (1 package)	2/3 cups (2 packages)	1 cup (3 packages)	1 1/3 cups (4 packages)															
Cold Milk	3/4 cup (180 ml)	1 1/2 cups (360 ml)	2 1/4 cups (540 ml)	3 cups (720 ml)															
2. Pasta	Room	Microwave-safe bowl	0.1 kg ~ 0.3 kg	<p>Place pasta and boiling water with 1/4 to 1 teaspoon salt in a deep and large bowl.</p> <table border="1" data-bbox="1724 1003 2703 1165"> <thead> <tr> <th>Weight</th> <th>100g</th> <th>200g</th> <th>300g</th> <th>Cover</th> </tr> </thead> <tbody> <tr> <td>Boiling water</td> <td>400ml</td> <td>700ml</td> <td>1000ml</td> <td>No</td> </tr> </tbody> </table> <p>Cook uncovered. The oven will beep, stir the pasta well and press start to continue. After cooking, stir and stand for 1 minute if required. Rinse pasta with cold water.</p>	Weight	100g	200g	300g	Cover	Boiling water	400ml	700ml	1000ml	No					
Weight	100g	200g	300g	Cover															
Boiling water	400ml	700ml	1000ml	No															
3. Baked beans	Room	Microwave-safe dish	0.2 kg ~ 0.8kg	<p>Pour beans into the microwave-safe dish. Cover. Place dish on the glass tray. After reheating, stir and then stand for 1-2 minutes with cover.</p>															

FOOD CATEGORY	FOOD TEMP.	UTENSILS	WEIGHT LIMIT	INSTRUCTIONS
4. Hotdogs	Room	Microwave-safe bowl	0.2 kg ~ 0.6 kg	Place contents of can including brine in a microwave-safe bowl. Heat uncovered. After heating, stir well. Drain and serve.
5. Stew	Room	Microwave-safe bowl	0.2 kg ~ 0.6 kg	Place stew in microwave-safe bowl. Cover with wrap loosely. After heating, stir well and stand for 2 minutes
6. Scrambled eggs	Refrigerated	Microwave-safe bowl	1-4 eggs	Place desired number of eggs and milk into a large bowl. Whisk slightly. Cover with wrap. After cooking, remove from the oven. Stir well and stand for 1-2 minutes with cover until firm. Add amount of milk according to the quantity. ** 1 egg : 1 Tablespoon of milk ** 2 eggs : 2 Tablespoons of milk ** 3 eggs : 3 Tablespoons of milk ** 4 eggs : 4 Tablespoons of milk
7. grill fish	Refrigerated	High rack	0.2 kg ~ 0.6 kg	Clean and dry, place on the high rack. the oven will beep, turn food over and press start to continue. after cooking, remove from the oven .and serve.
8. sausage	Refrigerated	High rack	0.1 kg ~ 0.5 kg	remove package, place on the high rack. the oven will beep, turn food over and press start to continue. after cooking, remove from the oven .and serve.

GB

Heating or Reheating Guide

To heat or reheat successfully in the microwave, it is important to follow several guidelines. Measure the amount of food in order to determine the time needed to reheat. Arrange the food in a circular pattern for best results. Room temperature food will heat faster than refrigerated food. Canned foods should be taken out of the can and placed in a microwavable container. The food will be heated more evenly if covered with a microwavable lid or vented plastic wrap. Remove cover carefully to prevent steam burns. Use the following chart as a guide for reheating cooked food.

GB

Item	Cook time (at HIGH)	Special Instructions
Sliced meat 3 slices (0.5cm thick)	1~2 minutes	Place sliced meat on microwavable plate. Cover with plastic wrap and vent. Note: Gravy or sauce helps to keep meat juicy.
Chicken pieces 1 breast 1 leg and thigh	2~3 minutes 3~3 1/2 minutes	Place chicken pieces on microwavable plate. Cover with plastic wrap and vent.
Fish fillet (170-230g)	1~2 minutes	Place fish on microwavable plate. Cover with plastic wrap and vent.
Lasagne 1 serving(300g)	4~6 minutes	Place lasagne on microwavable plate. Cover with plastic wrap and vent.
Casserole 1 cup 4 cups	1 1/2~3 minutes 4 1/2~7 minutes	COOK covered in microwavable casserole dish. Stir once halfway through cooking.
Casserole cream or cheese 1 cup 4 cups	1~2 1/2 minutes 3 1/2~6 minutes	COOK covered in microwavable casserole dish. Stir once halfway through cooking.
Sloppy Joe or Barbecued beef 1 sandwich (1/2 cup meat filling) without bun	1~2 1/2 minutes	Reheat filling and bun separately. COOK covered in microwavable casserole dish. Stir once. Heat bun as directed in chart below.

Item	Cook time (at HIGH)	Special Instructions
Mashed potatoes 1 cup 4 cups	2 1/2~3 1/2 minutes 6~9 minutes	COOK covered in microwavable casserole dish. Stir once halfway through cooking.
Baked beans 1 cup	1 1/2~3 minutes	COOK covered in microwavable casserole dish. Stir once halfway through cooking.
Ravioli or pasta in sauce 1 cup 4 cups	2 1/2~4 minutes 7 1/2~11 minutes	COOK covered in microwavable casserole dish. Stir once halfway through cooking.
Rice 1 cup 4 cups	1~1 1/2 minutes 3 1/2~5 minutes	COOK covered in microwavable casserole dish. Stir once halfway through cooking.
Sandwich roll or bun 1 roll	15~30 seconds	Wrap in paper towel and place on glass tray.
Vegetables 1 cup 4 cups	1 1/2~2 1/2 minutes 3 1/2~5 1/2 minutes	COOK covered in microwavable casserole dish. Stir once halfway through cooking.
Soup 1 serving (8 oz.)	1 1/2~2 minutes	COOK covered in microwavable casserole dish. Stir once halfway through cooking.

Fresh Vegetable Guide

GB

Vegetable	Amount	Cook time (at HIGH)	Instructions	Standing Time
Artichokes (230g each)	2 medium 4 medium	4½ ~ 7 10 ~ 12	Trim. Add 2 tsp water and 2 tsp juice. Cover.	2~3 minutes
Asparagus, Fresh, Spears	450g	2½ ~ 6	Add 1 cup water. Cover.	2~3 minutes
Green Beans	450g	7 ~ 11	Add ½ cup water in 1.5 litre casserole dish. Stir halfway through cooking.	2~3 minutes
Beets, Fresh	450g	11 ~ 16	Add ½ cup water in 1.5 litre covered casserole dish. Rearrange halfway through cooking.	2~3 minutes
Broccoli, Fresh, Spears	450g	5 ~ 8	Place broccoli in baking dish. Add ½ cup water.	2~3 minutes
Cabbage, Fresh, Chopped	450g	5½~7½	Add ½ cup water in 1.5 litre covered casserole dish. Stir halfway through cooking.	2~3 minutes
Carrots, Fresh, Sliced	200g	2 ~ 3	Add ¼ cup water in 1.5 litre covered casserole dish. Stir halfway through cooking.	2~3 minutes
Cauliflower, Fresh, Whole	450g	5 ~ 7	Trim. Add ¼ cup water in 1.5 litre covered casserole dish. Stir halfway through cooking.	2~3 minutes
Fresh, Flowerettes Celery, Fresh, Sliced	2 cups 4 cups	11 ~ 16	Slice. Add ½ cup water in 1.5 litre covered casserole dish. Stir halfway through cooking.	2~3 minutes

Vegetable	Amount	Cook time (at HIGH)	Instructions	Standing Time
Corn, Fresh	2 ears	4 ~ 8	Husk. Add 2 tbsp water in 1.5 litre baking dish. Cover.	2~3 minutes
Mushrooms, Fresh, Sliced	230g	1½ ~ 2½	Place mushrooms in 1.5 litre covered casserole dish. Stir halfway through cooking.	2~3 minutes
Parsnips, Fresh, Sliced	450g	4 ~ 7	Add ½ cup water in 1.5 litre covered casserole dish. Stir halfway through cooking.	2~3 minutes
Peas, Green, Fresh	4 cups	6 ~ 9	Add ½ cup water in 1.5 litre covered casserole dish. Stir halfway through cooking.	2~3 minutes
Sweet Potatoes Whole Baking (170~230g each)	2 medium 4 medium	4 ~ 9 6~ 12	Pierce potatoes several times with fork. Place on 2 paper towels. Turn over halfway through cooking.	2~3 minutes
White potatoes, Whole Baking (170~230g each)	2 potatoes 4 potatoes	5½ ~ 7½ 9½ ~ 14	Pierce potatoes several times with fork. Place on 2 paper towels. Turn over halfway through cooking.	2~3 minutes
Spinach, Fresh, Leaf	450g	4½ ~ 7½	Add ½ cup water in 2 litre covered casserole dish.	2~3 minutes
Courgette, Fresh, Sliced	450g	4½ ~ 7½	Add ½ cup water in 1.5 litre covered casserole dish. Stir halfway through cooking.	2~3 minutes
Courgette, Fresh, Whole	450g	6 ~ 9	Pierce. Place on 2 paper towels. Turn courgette over and rearrange halfway through cooking.	2~3 minutes

Grill Cooking Guide

Directions for grilling meat on grill

- Trim excess fat from meat. Cut fat, making sure you do not cut into the lean. (This will stop the fat curling.)
- Arrange on the rack. Brush with melted butter or oil.
- Halfway through, turn the meat over.

<i>Item</i>	<i>Weight</i>	<i>Approx. cooking time (in minutes)</i>	<i>Hints</i>
Lamb chops (2.5cm (1") thick)	230g x 2	25-32	Baste with oil or melted butter. Thin items should be placed on the grill rack. Thick items can be placed on to a drip tray. Turn food over after half the cooking time. Turn frequently.
Sausages (2.5cm (1") thick)	230g	13-16	
Fish fillets 1 cm (1/2") thick 1.5cm (1/2") thick	230g 230g	17-21 20-24	Brush with melted butter and turn over halfway through cooking.

Directions for grilling fish and seafood

Place fish and seafood on the rack. Whole fish should be scored diagonally on both sides before grilling. Brush fish and seafood with melted butter, margarine or oil before and during cooking. This helps stop the fish drying out. Grill for times recommended in the chart. Whole fish and fish steaks should be carefully turned over halfway through grilling time. If desired thick fillets can also be turned halfway.

<i>Item</i>	<i>Weight</i>	<i>Approx. cooking time (in minutes)</i>	<i>Hints</i>
Fish steaks 2.5 cm (1") thick	230g	24-28	Brush with melted butter and turn over halfway through cooking.
Whole fish	225-350g each 450g	16-20 24-28	Allow extra time for thick and oily fish.
Scallops Prawns uncooked	450g 450g	16-20 16-20	Baste well during cooking.

WARNING

Please ensure cooking times are correctly set as over cooking may result in FIRE and subsequent DAMAGE to the OVEN.

Important safety instructions

Read carefully and keep for future reference

- 1 Do not attempt to tamper with, or make any adjustments or repairs to the door, control panel, safety interlock switches or any other part of the oven. It is hazardous for anyone to carry out any service or repair operation which involves the removal of any cover which gives protection against exposure to microwave energy. Repairs should only be undertaken by a qualified service technician.
- 2 Do not operate the oven when empty. It is best to leave a glass of water in the oven when not in use. The water will safely absorb all microwave energy, if the oven is accidentally started.
- 3 Do not dry clothes in the microwave oven, which may become carbonized or burned if heated too long.
- 4 Do not cook food wrapped in paper towels, unless your cook book contains instructions, for the food you are cooking.
- 5 Do not use newspaper in place of paper towels for cooking.
- 6 Do not use wooden containers. They may heat-up and char. Do not use ceramic containers which have metallic (e.g. gold or silver) inlays. Always remove metal twist ties. Metal objects in the oven may arc, which can cause serious damage.
- 7 Do not operate the oven with a kitchen towel, a napkin or any other obstruction between the door and the front edges of the oven, which may cause microwave energy leakage.
- 8 Do not use recycled paper products since they may contain impurities which may cause sparks and/ or fires when used in cooking.
- 9 Do not rinse the turntable by placing it in water just after cooking. This may cause breakage or damage.
- 10 Small amounts of food require shorter cooking or heating time. If normal times are allowed they may overheat and burn.
- 11 Be certain to place the oven so the front of the door is 8 cm or more behind the edge of the surface on which it is placed, to avoid accidental tipping of the appliance.
- 12 Before cooking, pierce the skin of potatoes, apples or any such fruit or vegetable.
- 13 Do not cook eggs in their shell. Pressure will build up inside the egg which will burst.
- 14 Do not attempt deep fat frying in your oven.
- 15 Remove the plastic wrapping from food before cooking or defrosting. Note though that in some cases food should be covered with plastic film, for heating or cooking.
- 16 If the oven door or door seals are damaged, the oven must not be operated until it has been repaired by a qualified service technician.
- 17 If smoke is observed, switch off or disconnect the oven from the power supply and keep the oven door closed in order to stifle any flames.
- 18 When food is heated or cooked in disposable containers of plastic, paper or other combustible materials, check the oven frequently due to the possibility of ignition.
- 19 Only allow children to use the oven without supervision when adequate instructions have been given so that the child is able to use the oven in a safe way and understands the hazards of improper use.
- 20 Liquids or other foods must not be heated in sealed containers since they are liable to explode.

GB

Microwave-safe

Utensils

Never use metal or metal trimmed utensils in your microwave oven

Microwaves cannot penetrate metal. They will bounce off any metal object in the oven and cause arcing, an alarming phenomenon that resembles lightning.

Most heat resistant non metallic cooking utensils are safe for use in your microwave oven. However, some may contain materials that render them unsuitable as microwave cookware. If you have any doubts about a particular utensil, there's a simple way to find out if it can be used in your microwave oven.

Place the utensil in question next to a glass bowl filled with water in the microwave oven. Microwave at power HIGH for 1 minute. If the water heats up but the utensil remains cool to the touch, the utensil is microwave-safe. However, if the water does not change temperature but the utensil becomes warm, microwaves are being absorbed by the utensil and it is not safe for use in the microwave oven. You probably have many items on hand in your kitchen right now that can be used as cooking equipment in your microwave oven. Just read through the following checklist.

Dinner plates

Many kinds of dinner-ware are microwave-safe. If in doubt consult the manufacturer's literature or perform the microwave test.

Glassware

Glassware that is heat-resistant is microwave-safe. This would include all brands of oven tempered glass cookware. However, do not use delicate glassware, such as tumblers or wine glasses, as these might shatter as the food warms.

Plastic storage containers

These can be used to hold foods that are to be quickly reheated. However, they should not be used to hold foods that will need considerable time in the oven as hot foods will eventually warp or melt plastic containers.

Paper

Paper plates and containers are convenient and safe to use in your microwave oven, provided that the cooking time is short and foods to be cooked are low in fat and moisture. Paper towels are also very useful for wrapping foods and for lining baking trays in which greasy foods such as bacon are cooked. In general, avoid coloured paper products as the colour may run. Some recycled paper products may contain impurities which could cause arcing or fires when used in the microwave oven.

Plastic cooking bags

Provided they are made specially for cooking, cooking bags are microwave safe. However, be sure to make a slit in the bag so that steam can escape. Never use ordinary plastic bags for cooking in your microwave oven, as they will melt and rupture.

Plastic microwave cookware

A variety of shapes and sizes of microwave cookware are available. For the most part, you can probably use items you already have on hand rather than investing in new kitchen equipment.

Pottery, stoneware and ceramic

Containers made of these materials are usually fine for use in your microwave oven, but they should be tested to be sure.

CAUTION

Some items with high lead or iron content are not suitable for cooking utensils.

Utensils should be checked to ensure that they are suitable for use in microwave ovens.

Food characteristics & Microwave cooking

Keeping an eye on things

The recipes in the book have been formulated with great care, but your success in preparing them depends on how much attention you pay to the food as it cooks. Always watch your food while it cooks. Your microwave oven is equipped with a light that turns on automatically when the oven is in operation so that you can see inside and check the progress of your food. Directions given in recipes to elevate, stir, and the like should be thought of as the minimum steps recommended. If the food seems to be cooking unevenly, simply make the necessary adjustments you think appropriate to correct the problem.

Factors affecting microwave cooking times

Many factors affect cooking times. The temperature of ingredients used in a recipe makes a big difference in cooking times. For example, a cake made with ice-cold butter, milk, and eggs will take considerably longer to bake than one made with ingredients that are at room temperature. All of the recipes in this book give a range of cooking times. In general, you will find that the food remains under-cooked at the lower end of the time range, and you may sometimes want to cook your food beyond the maximum time given, according to personal preference. The governing philosophy of this book is that it is best for a recipe to be conservative in giving cooking times. While overcooked food is ruined for good. Some of the recipes, particularly those for bread, cake, and custards, recommend that food be removed from the oven when they are slightly undercooked. This is not a mistake. When allowed to stand, usually covered, these foods will continue to cook outside of the oven as the heat trapped within the outer portions of the food gradually travels inward. If the food is left in the oven until it is cooked all the way through, the outer portions will become overcooked or even burnt. You will become increasingly skilful in estimating both cooking and standing times for various foods.

Density of food

Light, porous food such as cakes and breads cook more quickly than heavy, dense foods such as roasts and casseroles. You must take care when microwaving porous food that the outer edges do not become dry and brittle.

Height of food

The upper portion of tall food, particularly roasts, will cook more quickly than the lower portion. Therefore, it is wise to turn tall food during cooking, sometimes several times.

Moisture content of food

Since the heat generated from microwaves tends to evaporate moisture, relatively dry food such as roasts and some vegetables should either be sprinkled with water prior to cooking or covered to retain moisture.

Bone and fat content of food

Bones conduct heat and fat cooks more quickly than meat. Care must be taken when cooking bony or fatty cuts of meat that they do not cook unevenly and do not become overcooked.

Quantity of food

The number of microwaves in your oven remains constant regardless of how much food is being cooked. Therefore, the more food you place in the oven, the longer the cooking time. Remember to decrease cooking times by at least one third when halving a recipe.

Shape of food

Microwaves penetrate only about 2 cm into food, the interior portion of thick foods are cooked as the heat generated on the outside travels inward. Only the outer edge of food is cooked by microwave energy; the rest is cooked by conduction. The worst possible shape for a food that is to be microwaved is a thick square. The corners will burn long before the centre is even warm. Round thin foods and ring shaped foods cook successfully in the microwave.

Covering

A cover traps heat and steam which causes food to cook more quickly. Use a lid or microwave cling film with a corner folded back to prevent splitting.

Browning

Meats and poultry that are cooked fifteen minutes or longer will brown lightly in their own fat. Foods that are cooked for a shorter period of time may be brushed with a browning sauce such as worcestershire sauce, soy sauce or barbecue sauce to achieve an appetizing colour. Since relatively small amounts of browning sauces are added to food the original flavour of the recipe is not altered.

Covering with greaseproof paper

Greaseproofing effectively prevents spattering and helps food retain some heat. But because it makes a looser cover than a lid or clingfilm, it allows the food to dry out slightly.

Arranging and spacing

Individual foods such as baked potatoes, small cakes and hors d'oeuvres will heat more evenly if placed in the oven an equal distance apart, preferably in a circular pattern. Never stack foods on top of one another.

Food characteristics & Microwave cooking

Stirring

Stirring is one of the most important of all microwaving techniques. In conventional cooking, food is stirred for the purpose of blending. Microwaved food, however, is stirred in order to spread and redistribute heat. Always stir from the outside towards the centre as the outside of the food heats first.

Turning over

Large, tall foods such as roasts and whole chickens should be turned so that the top and bottom will cook evenly. It is also a good idea to turn cut up chicken and chops.

Placing thicker portions facing outwards

Since microwaves are attracted to the outside portion of food, it makes sense to place thicker portions of meat, poultry and fish to the outer edge of the baking dish. This way, thicker portions will receive the most microwave energy and the food will cook evenly.

Shielding

Strips of aluminium foil (which block microwaves) can be placed over the corners or edges of square and rectangular foods to prevent those portions from overcooking. Never use too much foil and make sure the foil is secured to the dish or it may cause 'arcing' in the oven.

Elevating

Thick or dense foods can be elevated so that microwaves can be absorbed by the underside and centre of the foods.

Piercing

Foods enclosed in a shell, skin or membrane are likely to burst in the oven unless they are pierced prior to cooking. Such foods include yolks and whites of eggs, clams and oysters and whole vegetables and fruits.

Testing if cooked

Food cooks so quickly in a microwave oven, it is necessary to test it frequently. Some foods are left in the microwave until completely cooked, but most foods, including meats and poultry, are removed from the oven while still slightly undercooked and allowed to finish cooking during standing time. The internal temperature of foods will rise between 5°F (3°C) and 15°F (8°C) during standing time.

Standing time

Foods are often allowed to stand for 3 to 10 minutes after being removed from the microwave oven. Usually the foods are covered during standing time to retain heat unless they are supposed to be dry in texture (some cakes and biscuits, for example). Standing allows foods to finish cooking and also helps flavour blend and develop.

To Clean Your Oven

1 Keep the inside of the oven clean

Food spatters or spilled liquids stick to oven walls and between seal and door surface. It is best to wipe up spillovers with a damp cloth right away. Crumbs and spillovers will absorb microwave energy and lengthen cooking times. Use a damp cloth to wipe out crumbs that fall between the door and the frame. It is important to keep this area clean to assure a tight seal. Remove greasy spatters with a soapy cloth then rinse and dry. Do not use harsh detergent or abrasive cleaners. The glass tray can be washed by hand or in the dishwasher.

2 Keep the outside of the oven clean

Clean the outside of your oven with soap and water then with clean water and dry with a soft cloth or paper towel. To prevent damage to the operating parts inside the oven, the water should not be allowed to seep into the ventilation openings. To clean control panel, open the door to prevent oven from accidentally starting, and wipe a damp cloth followed immediately by a dry cloth. Press STOP/CLEAR after cleaning.

3 If steam accumulates inside or around the outside of the oven door, wipe the panels with a soft cloth. This may occur when the microwave oven is operated under high humidity conditions and in no way indicates a malfunction of the unit.

4 The door and door seals should be kept clean. Use only warm, soapy water, rinse then dry thoroughly.

DO NOT USE ABRASIVE MATERIALS, SUCH AS CLEANING POWDERS OR STEEL AND PLASTIC PADS.

Metal parts will be easier to maintain if wiped frequently with a damp cloth.

Questions & Answers

GB

Q What's wrong when the oven light will not glow?

A There may be several reasons why the oven light will not glow.
Light bulb has blown
Door is not closed

Q Does microwave energy pass through the viewing screen in the door?

A No. The holes, or ports, are made to allow light to pass; they do not let microwave energy through.

Q Why does the beep tone sound when a pad on the Control Panel is touched?

A The beep tone sounds to assure that the setting is being properly entered.

Q Will the microwave oven be damaged if it operates empty?

A Yes Never run it empty or without the glass tray.

Q Why do eggs sometimes pop?

A When baking, frying, or poaching eggs, the yolk may pop due to steam build up inside the yolk membrane. To prevent this, simply pierce the yolk before cooking. Never microwave eggs in the shell.

Q Why is standing time recommended after microwave cooking is over?

A After microwave cooking is finished, food keeps on cooking during standing time. This standing time finishes cooking evenly throughout the food. The amount of standing time depends on the density of the food.

Q Is it possible to pop corn in a microwave oven?

A Yes, if using one of the two methods described below

- 1 Popcorn-popping utensils designed specifically for microwave cooking.
- 2 Prepackaged commercial microwave popcorn that contains specific times and power outputs needed for an acceptable final product.

FOLLOW EXACT DIRECTIONS GIVEN BY EACH MANUFACTURER FOR THEIR POPCORN PRODUCT. DO NOT LEAVE THE OVEN UNATTENDED WHILE THE CORN IS BEING POPPED. IF CORN FAILS TO POP AFTER THE SUGGESTED TIMES, DISCONTINUE COOKING. OVERCOOKING COULD RESULT IN THE CORN CATCHING FIRE.

CAUTION

NEVER USE A BROWN PAPER BAG FOR POPPING CORN. NEVER ATTEMPT TO POP LEFTOVER KERNELS.

Q Why doesn't my oven always cook as fast as the cooking guide says?

A Check your cooking guide again to make sure you've followed directions correctly, and to see what might cause variations in cooking time. Cooking guide times and heat settings are suggestions, chosen to help prevent overcooking, the most common problem in getting used to a microwave oven. Variations in the size, shape, weight and dimensions of the food require longer cooking time. Use your own judgement along with the cooking guide suggestions to test food condition, just as you would do with a conventional cooker.

Plug wiring information/ Technical Specifications

GB

Warning

This appliance must be earthed

The wires in this mains lead are colored in accordance with the following codes

BLUE ~ Neutral

BROWN ~ Live

GREEN & YELLOW ~ Earth

As the colours of the wires in the mains lead of this appliance may not correspond with the coloured markings identifying the terminals in your plug proceed as follows:

The wire which is colored BLUE must be connected to the terminal which is marked with the letter N or Colored BLACK.

The wire which is colored BROWN must be connected to the terminal which is marked with the letter L or colored RED.

The wire which is colored GREEN & YELLOW or GREEN must be connected to the terminal which is marked with the letter E or .

If the supply cord is damaged, it must be replaced by the manufacturer or its service agent or a similarly qualified person in order to avoid a hazard;

Technical Specification

	MB-4384B
Power Input	230 V AC /50Hz
Output	850 W (IEC60705 rating standard)
Microwave Frequency	2,450 MHz
Outside Dimension	507 mm(W) X 283mm(H) X 43.5mm(D)
Power Consumption	1,250 Watts
Microwave	
Grill	1,000 Watts
Combination	2,200 Watts

<English>

Disposal of your old appliance

1. When this crossed-out wheeled bin symbol is attached to a product it means the product is covered by the European Directive 2002/96/EC.
2. All electrical and electronic products should be disposed of separately from the municipal waste stream via designated collection facilities appointed by the government or the local authorities.
3. The correct disposal of your old appliance will help prevent potential negative consequences for the environment and human health.
4. For more detailed information about disposal of your old appliance, please contact your city office, waste disposal service or the shop where you purchased the product.

<Hungarian>

Régi eszközök ártalmatlanítása

1. A termékhez csatolt áthúzott, kerek szeméttároló jel jelöli, hogy a termék a 2002/96/EC EU-direktíva hatálya alá esik.
2. Minden elektromos és elektronikai terméket a lakossági hulladéktól elkülönítve kell begyűjteni, a kormány vagy az önkormányzatok által kijelölt begyűjtő eszközök használatával.
3. Régi eszközeinek megfelelő ártalmatlanítása segíthet megelőzni az esetleges egészségre vagy környezetre ártalmas hatásokat.
4. Ha több információra van szüksége régi eszközeinek ártalmatlanításával kapcsolatban, tanulmányozza a vonatkozó környezetvédelmi szabályokat, vagy lépjen kapcsolatba az üzlettel, ahol a terméket vásárolta.

<Bulgaria>

Изхвърляне на вашия стар уред

1. Когато този символ на задраскана кофа за боклук е поставен върху дадено изделие, това означава, че изделието попада под разпоредбите на Европейска директива 2002/96/ЕО.
2. Всички електрически и електронни изделия трябва да се изхвърлят отделно от битовите отпадъци, в определени за целта съоръжения, посочени от държавните или местните органи.
3. Правилното изхвърляне на вашия уред ще помогне за предотвратяване на възможни негативни последици за околната среда и човешкото здраве.
4. За по-подробна информация за изхвърлянето на вашия стар уред се обърнете към вашата община, службите за събиране на отпадъци или магазина, откъдето сте купили своя уред.

<Croatia>

Uklanjanje starog aparata

1. Ako se na proizvodu nalazi simbol prekrizene kante za smeće, to znači da je proizvod pokriven europskom direktivom 2002/96/EC.
2. Električni i elektronski proizvodi ne smiju se odlagati zajedno s komunalnim otpadom, već u posebna odlagališta koja je odredila vlada ili lokalne vlasti.
3. Pravilno odlaganje starog proizvoda sprečıt će potencijalne negativne posljedice po okoliš i zdravlje ljudi.
4. Podrobnije informacije o odlaganju starog proizvoda potražite u gradskom uredu, službi za odlaganje otpada ili u trgovini u kojoj ste kupili proizvod.

<Serbian>

Uklanjanje starih aparata

1. Ako se na proizvodu nalazi simbol prekrizene kante za smeće, to znači da je proizvod u skladu sa evropskom smernicom 2002/96/EC.
2. Električni i elektronski proizvodi ne smeju se odlagati zajedno s komunalnim otpadom, već na posebna mesta koja je odredila vlada ili lokalne vlasti.
3. Ispravno odlaganje starog aparata sprečiće potencijalne negativne posledice za okolinu i zdravlje ljudi.
4. Detaljnije informacije o odlaganju starog aparata potražite u gradskom uredu, komunalnoj službi ili u prodavnici u kojoj ste kupili proizvod.

