



CAR CD/MP3/WMA Receiver

OWNER'S MANUAL

MODEL : LAC-M1600R/M3600R

Please read this instruction booklet carefully and completely before connecting, operating or adjusting this product.

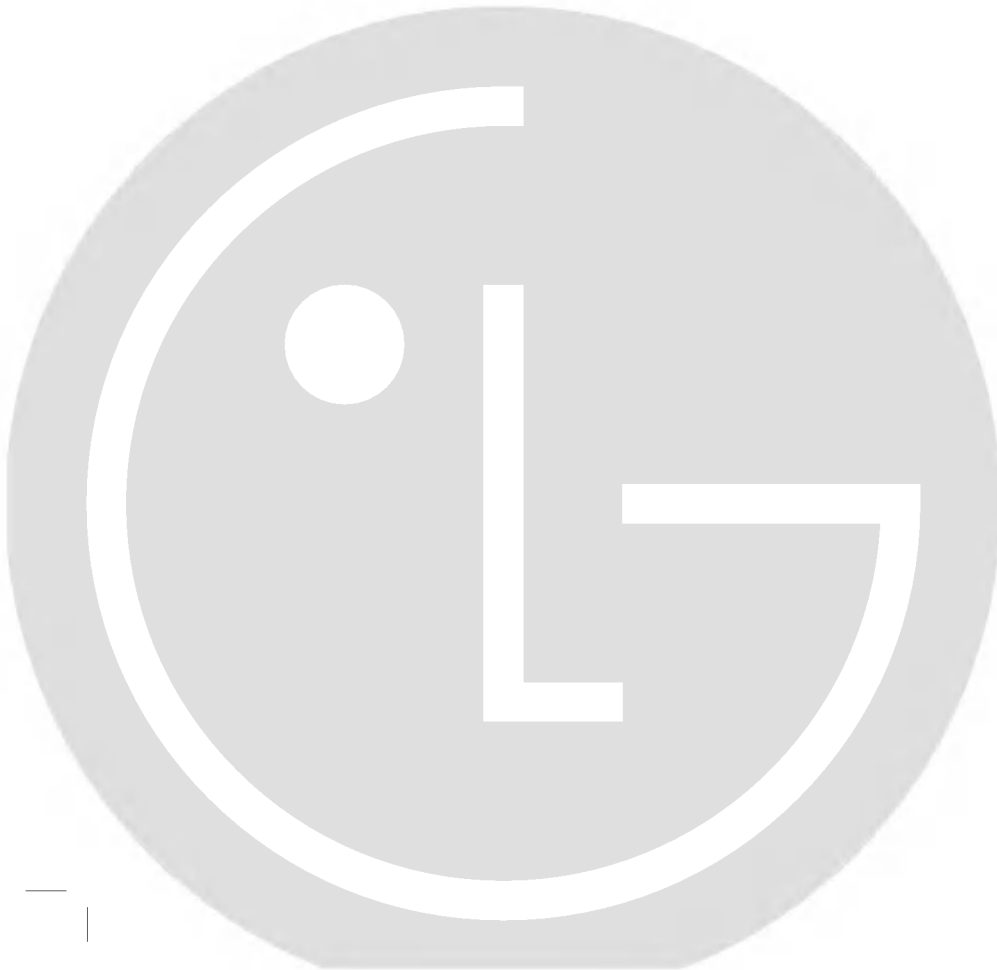

Safety note



The lightning flash with arrowhead symbol, within an equilateral triangle is intended to alert the user about the presence of uninsulated dangerous voltage within the product's enclosure that may be of sufficient magnitude to constitute a risk of electric shock to persons.



The exclamation point within an equilateral triangle is intended to alert the user to the presence of important operating and maintenance (servicing) instructions in the literature accompanying the appliance.



Always operate the vehicle in a safe manner. Do not become distracted by the vehicle while driving, and always be fully aware of all driving condition. Do not change settings, or any functions. Pull over in a safe and legal manner before attempting such operations.



Do not use for many hours at extremely low or high temperature. (-10~60°C)



To reduce the risk of electric shock, do not remove the cover or back of this product. There are no user-serviceable parts inside. Refer servicing to qualified service personnel.



To reduce the risk of fire or electric shock, do not expose this product to dripping or splashing water, rain, or moisture.



Due to high temperature outside of the unit, please use the unit only installed in a car.

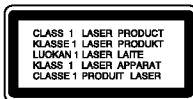

CAUTION : VISIBLE AND INVISIBLE LASER RADIATION WHEN OPEN AND INTERLOCKS DEFEATED.

CAUTION : This product uses a Laser System.

To ensure proper use of this product, please read this owner's manual carefully and retain it for future reference. Should the unit require maintenance, contact an authorized service center.

Performing controls, adjustments, or carrying out procedures other than those specified herein may result in hazardous radiation exposure.

To prevent direct exposure to laser beam, do not try to open the enclosure.

Visible laser radiation when open. DO NOT STARE INTO BEAM.

Safety note / Table of contents



- A defective or soiled disc inserted into unit can cause sound to drop out during playback.
- Handle the disc by holding its inner and outer edges.
- Do not touch the surface of the unlabeled side of the disc.



Do not stick paper or tape etc. on the surface.



Do not expose the disc to direct sunlight or excessive heat.



This unit cannot be operated by 8cm disc (using 12cm disc only).

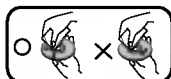

- Clean the disc before playback. Wipe the disc from the center outward with a cleaning cloth.
- Never use solvents such as benzine or alcohol to clean the disc.

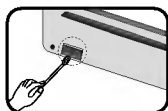

Periodically wipe the contacts on the back of the front panel with a cotton swab moistened with alcohol.

Safety note	2-3
Table of contents	3
Before use	4
Front panel	5-6
Remote control	7
Installation	8
Connection diagram	9
Connection	10
Basic operation	11-12
Radio operation	13
RDS operation	14-15
CD/MP3/WMA operation	16-17
Troubleshooting	18
Specifications	19

Before use

Detachable front panel

The front panel of this unit can be detached to prevent theft.

- 1 Press the  (RELEASE) to open the front panel.
- 2 Hold the right part the front panel.
- 3 Pull the front panel.
- 4 Place the front panel in the supplied protective case.

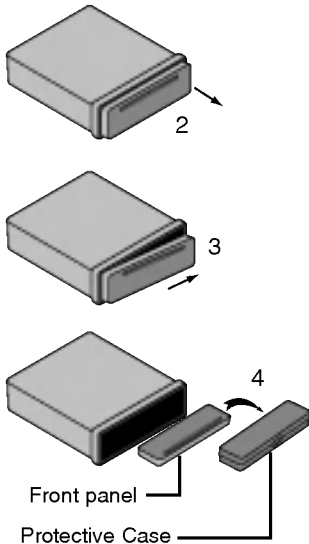

Attachable front panel

The front panel of this unit can be detached to prevent theft.

- 1 Align the left side of the panel with stopper.
- 2 push the right side of panel into the unit until clicks.

Notes

- When detaching or attaching the front panel, do not press the display or control buttons.
- The control buttons may not work properly if the front panel is not attached properly. If this occurs, gently press the front panel.
- Do not leave the front panel in any area exposed to high temperatures or direct sunlight.
- Do not drop the front panel or otherwise subject it to strong impact.
- Do not allow such volatile agents as benzine, thinner, or insecticides to come into contact with the surface of the front panel.
- Do not try to disassemble the front panel.

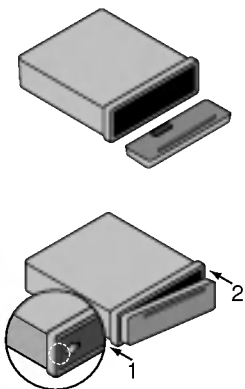

Front Panel

LAC-M1600R

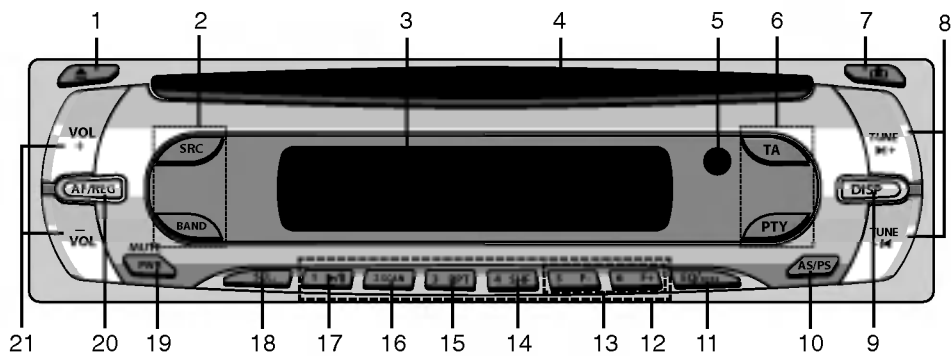

- | | |
|-----------------------------|---|
| 1 EJECT ▲ | 12 PRESET STATION [1-6] |
| 2 • SOURCE [SRC] | 13 • MP3 TRACK +10/-10 MP3 WMA |
| • [BAND] | • FOLDER UP/DOWN [F+/F-] MP3 WMA |
| 3 DISPLAY WINDOW | 14 SHUFFLE [SHF] |
| 4 DISC SLOT | 15 REPEAT [RPT] |
| 5 REMOTE SENSOR | 16 INTRO SCAN [SCAN] |
| 6 • PROGRAM TYPE [PTY] | 17 PLAY/PAUSE ►/II |
| • TRAFFIC ANNOUNCEMENT [TA] | 18 SELECT [SEL] |
| 7 RELEASE 🏠 | 19 POWER [PWR / MUTE] |
| 8 • CD SKIP/SEARCH ◀▶ | 20 • ALTERNATIVE FREQUENCIES [AF] |
| • SEEK / TUNE +/- | • REGIONAL [REG] |
| 9 DISPLAY [DISP] | 21 • VOLUME [VOL+/-] |
| 10 • AUTO STORE [AS] | • CONTROL UP/DOWN |
| • PRESET SCAN [PS] | |
| 11 EQUALIZER/XDSS [EQ/XDSS] | |





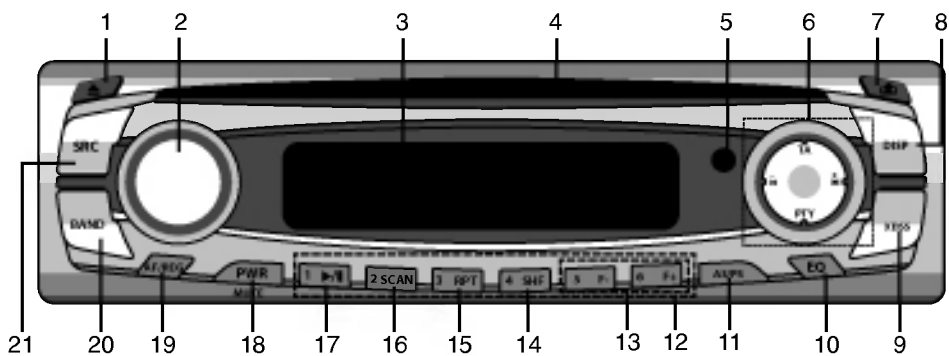











Front Panel

LAC-M3600R



- | | | | |
|----|-----------------------------|----|---|
| 1 | EJECT ▲ | 11 | • AUTO STORE [AS] |
| 2 | • VOLUME [VOL/SEL] | | • PRESET SCAN [PS] |
| | • CONTROL UP/DOWN | 12 | PRESET STATION [1-6] |
| | • SELECT | 13 | • MP3 TRACK +10/-10 MP3 WMA |
| 3 | DISPLAY WINDOW | | • FOLDER UP/DOWN [F+/F-] MP3 WMA |
| 4 | DISC SLOT | 14 | SHUFFLE [SHF] |
| 5 | REMOTE SENSOR | 15 | REPEAT [RPT] |
| 6 | • PROGRAM TYPE [PTY] | 16 | INTRO SCAN [SCAN] |
| | • TRAFFIC ANNOUNCEMENT [TA] | 17 | PLAY/PAUSE ▶/II |
| | • CD SKIP/SEARCH I◀▶I | 18 | POWER [PWR / MUTE] |
| | • SEEK / TUNE +/- | 19 | • ALTERNATIVE FREQUENCIES [AF] |
| 7 | RELEASE 🏠 | | • REGIONAL [REG] |
| 8 | DISPLAY [DISP] | 20 | [BAND] |
| 9 | [XDSS] | 21 | SOURCE [SRC] |
| 10 | EQUALIZER [EQ] | | |

Remote control

- 1 POWER [PWR] / MUTE 
- 2 SELECTION [SEL]
- 3 SOURCE [SRC]
- 4 PLAY / PAUSE 
- 5 INTRO SCAN [SCAN]
- 6 SHUFFLE [SHF]
- 7 • MP3 TRACK +10 
• FOLDER UP [F+] 
- 8 • CD SKIP / SEARCH  
• SEEK / TUNE  
- 9 [BAND]
- 10 VOLUME UP  / DOWN 
- 11 NUMBER [#]
- 12 REPEAT [RPT]
- 13 NUMBER [0 -9]
- 14 • CD SKIP / SEARCH  
• SEEK / TUNE  
- 15 DISPLAY [DISP.]
- 16 • MP3 TRACK -10 
• FOLDER DOWN [F-] 

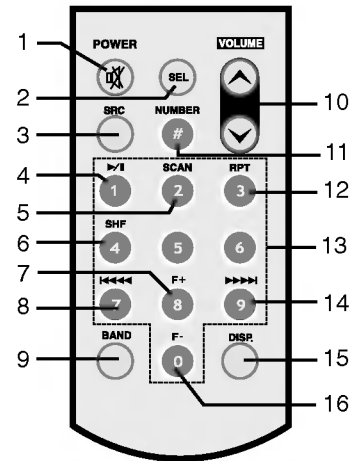

Battery installation

- 1 Remove the battery holder with a pencil or ball point pen.
- 2 Install the battery on the battery holder.
- 3 Install the battery holder back into its original position.

Notes

- Use only one CR2025 (3V) lithium battery.
- Remove the battery if the remote control is not used for a long period of time.
- Do not leave the product in a hot or humid place.
- Do not handle the battery with metallic tools.
- Do not store the battery with metallic materials.
- In the event of battery leakage, wipe the remote control completely clean and install a new battery.

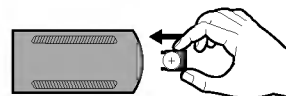
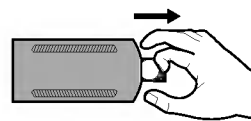
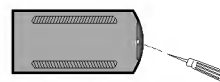

Installation

Basic Installation

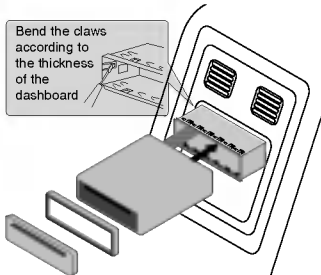

Front panel

Before installing, make sure that the ignition-switch is set to OFF and remove the terminal of the car battery to avoid short-circuiting.

- 1 Remove the existing receiver unit.
- 2 Make the necessary connections.
- 3 Install the installation sleeve.
- 4 Install the unit into the installation sleeve.

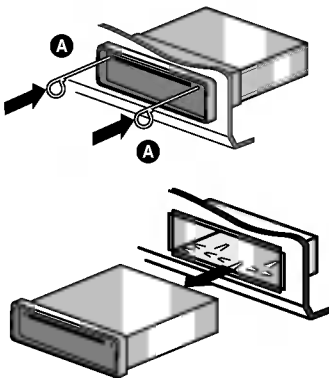

Removing the existing receiver unit.

If there is already an installation sleeve for the receiver unit in the dashboard, it must be removed.

- 1 Remove the rear support from the unit.
- 2 Remove the front panel and trim ring from the unit.
- 3 Insert the lever **A** into the hole on one side of the unit. Perform the same operation on the other side and pull the unit out from the mounting sleeve.

ISO-DIN Installation

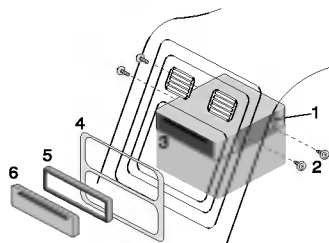

Front panel

- 1 Slide the unit into the ISO-DIN frame.
- 2 Install screws removed from the old unit.
- 3 Slide the unit and frame into dash opening.
- 4 Install the dash panel or adapter plate.
- 5 Install the trim ring to unit.
- 6 Install the faceplate by fitting right edge into position then pushing left edge closed.

Connection diagram

Before connecting, make sure that the ignition switch is set to OFF, and remove the battery \ominus terminal to avoid short circuits.

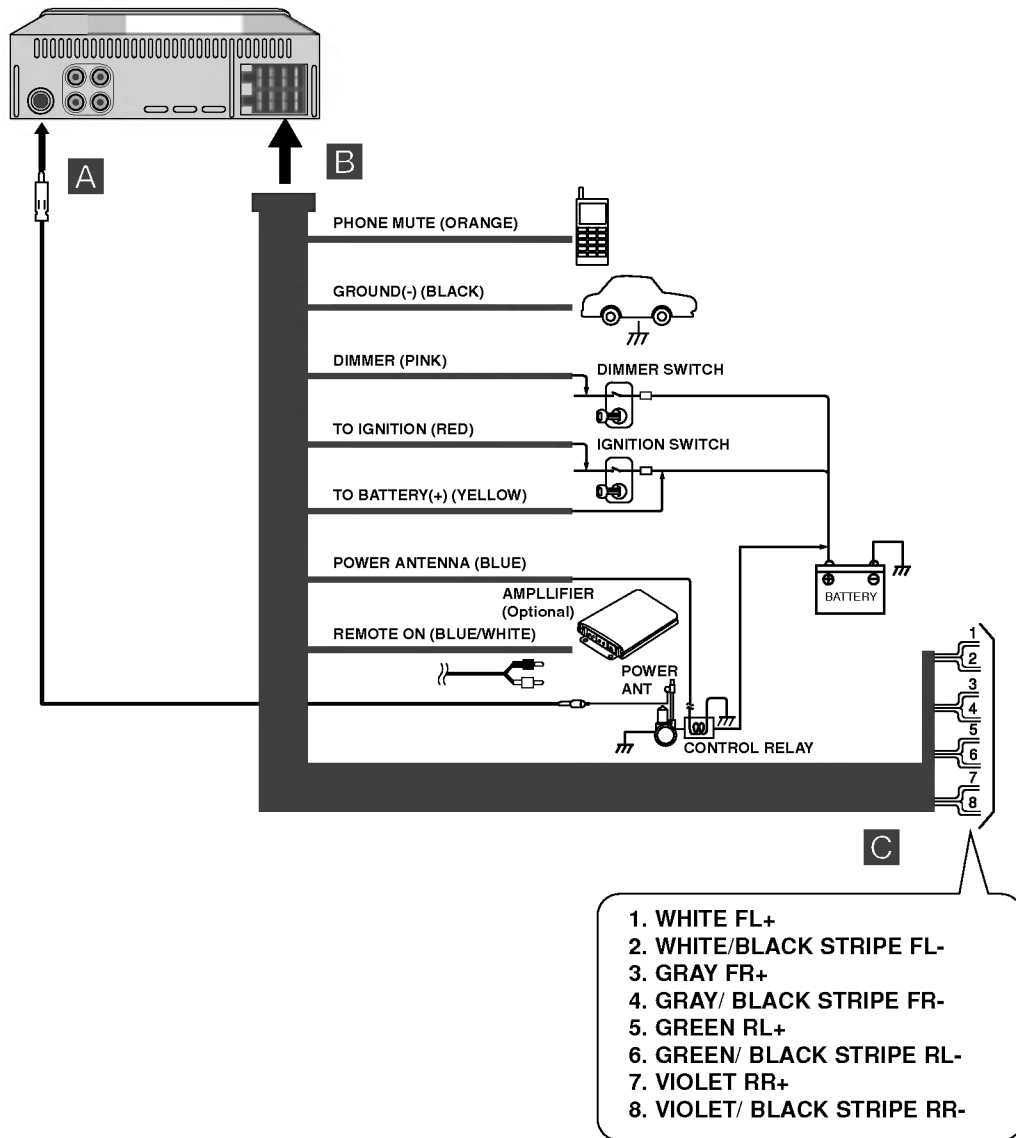

Connection

C Speaker Connections

A From antenna

B To the wiring of the vehicle colors of leads.

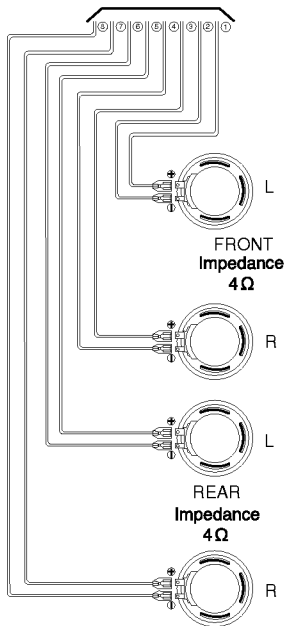

- **BLACK** : This lead is for the ground connection.
- **ORANGE** : This lead is for the phone line connection.
- **PINK** : This lead is for the dimmer line connection.
- **RED** : This lead is for connection to the power supply terminal when the ignition switch is set to ACC.
- **YELLOW** : This lead is for connection to the battery (back-up) terminal from which power is always supplied.
- **BLUE** : This lead is for the power antenna connection.
- **BLUE/WHITE** : This lead is for the remote amplifier on connection.

Connecting to Auxiliary Equipment (Optional)

Connect the **AUDIO OUTPUT** connector of this unit to the **AUDIO INPUT** connector of the Auxiliary Equipment.

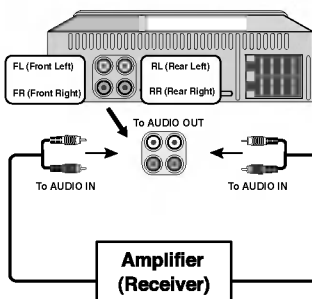

Basic operation

Turning the unit on

Press **PWR/MUTE** (**POWER/MUTE**  on the remote control) or any other button.

Note

When you insert the CD in the CD slot, the unit turns on.

Turning the unit off

Press **PWR/MUTE** (**POWER/MUTE**  on the remote control) for more than 1.2 seconds.

Selecting a source

Press **SRC** repeatedly to select a source.

The indicator lights up in the following order. Tuner → CD → Tuner...

Adjusting the volume

Press the **VOL+/-** (Press the **VOLUME ▲ ▼** on the remote control) to adjust sound level. : **LAC-M1600R**

Rotate the **VOL/SEL.** : **LAC-M3600R**



Note

When you turn the unit off, the current volume level is automatically memorized. Whenever you turn the unit back on, it will operate at the memorized volume level.

Checking the clock

You can see the clock pressing **DISP** (**DISP.** on the remote control).

Mute

- 1 Press **PWR/MUTE** (**POWER/MUTE**  on the remote control) to cut the sound.
- 2 To cancel it, press **PWR/MUTE** (**POWER/MUTE**  on the remote control) again.

XDSS (Extreme Dynamic Sound System)

Press and hold the **EQ/XDSS** to reinforce treble, bass and surround effect. : **LAC-M1600R**

Press the **XDSS.** : **LAC-M3600R**

XDSS off (No display) → XDSS

Basic operation

Using the EQ (Equalizer)

The equalizer lets you adjust the equalization to match the acoustic characteristics of the car's interior design.

Press **EQ/XDSS** repeatedly. : **LAC-M1600R**

The indicator lights up in the following order.

Pop → Classic → Rock → User1 → User2 → EQ off (No display)

Press **EQ** repeatedly. : **LAC-M3600R**

Pop → Classic → Rock → Jazz → Vocal → Salsa → Samba → User1 → User2 → EQ off (No display)

- Pop : Optimized for R&B, Soul and Country music.
- Classic : Optimized for orchestral music.
- Rock : Optimized for Hard Rock and Heavy Metal music.
- Jazz : Sweet sound with soft feeling.
- Vocal : Powerful realism with strong sound quality.
- Salsa : Reproduces salsa music acoustics.
- Samba : Reproduces samba music acoustics.
- User1 : Use the menu to set the sound level you want.
- User2 : Use the menu to set the sound level you want.

Using the User1/User2 (Sound level)

- 1 Press the **SEL** repeatedly to select the mode you want to adjust from volume, bass, middle, treble, balance and fader. : **LAC-M1600R**

Press and hold the **VOL/SEL** and then repeatedly. : **LAC-M3600R**

The indicator lights up in the following order.

VOL → BAS → MID → TRB → BAL → FAD

- 2 Press the **VOL+/-** (Press **VOLUME ▲ ▼** on the remote control) to adjust the sound quality. : **LAC-M1600R**

Rotate the **VOL/SEL**. : **LAC-M3600R**

	Turn right	Turn left
<i>VOL</i>	Increase the volume level.	Decrease the volume level.
<i>BAS</i>	Increase the bass level.	Decrease the bass level.
<i>MID</i>	Increase the middle level.	Decrease the middle level.
<i>TRB</i>	Increase the treble level.	Decrease the treble level.
<i>BAL</i>	Decrease the level of the left speaker(s).	Decrease the level of the right speaker(s).
<i>FAD</i>	Decrease the level of the front speaker(s).	Decrease the level of the rear speaker(s).

Note

The unit can adjust the bass, middle and treble in the **User1**, **User2**, **EQ OFF** or **XDSS OFF**.

Radio operation

Listening to radio stations

- 1 Press the **SRC** to select the radio.
- 2 Press the **BAND** repeatedly to select a band.
The indicator lights up in the following order. FM1 → FM2 → FM3 → MW(AM)
- 3 **Seek tuning** : Press **I◀/▶I** (**I◀◀ ◀◀/▶▶ ▶▶I** on the remote control).
The tuner will scan the frequencies until a broadcast with strong enough reception is found.
Manual tuning : Press the **I◀/▶I** (Press the **I◀◀ ◀◀/▶▶ ▶▶I** on the remote control for more than 2 seconds and then repeatedly.) repeatedly.
The frequencies move up or down step by step.

Note

When the selected frequency is being broadcast in stereo, the “((S))” indicator will light.

Auto search memory

This function lets you automatically store the 6 strongest broadcast frequencies.

- 1 Press the **SRC** to select the tuner.
- 2 Press and hold the **AS/PS** for more than 1 second.
Scanning starts from the currently displayed frequency to higher frequencies and stops when 6 stations have been preset or the receivable frequencies have been scanned once.

Storing and recalling broadcast frequencies

You can easily store up to 6 broadcast frequencies for later recall at the touch of a button.

- 1 Select the desired frequency.
- 2 Press one of the **preset station 1 ~ 6** for more than 1 second.
The number you have pressed will flash in the preset number indicator and then remain lit. The selected radio station frequency has been stored in memory.
- 3 Repeat steps 1 and 2 to preset other stations.
The next time, you press the same **preset station 1 ~ 6** the radio station frequency is recalled from the memory.

Note

- As F1, F2, F3 have the same frequency range, up to 18 stations can be preset for FM.
- When a station is preset on the preset station button on which another station of the same band has already been preset, the previously preset station is automatically erased.

To scan the preset stations

Press the **AS/PS** on the front panel. To stop the scanning, press the **AS/PS**.

To tune in the preset stations

Press **BAND** to select the desired band and press the desired number (1-6).

The number of the **preset station 1 ~ 6** is displayed and the preset station is received.

RDS operation

RDS Display options

In normal RDS operation the display will indicate the station name. Pressing the **DISP** enables you to cycle through the various data types in the following sequence:

(CT → FREQUENCY → PTY → RT → PS)

- **CT** (Time controlled by the channel)
- **PTY** (Program type recognition)
- **RT** (Radio text recognition)
- **PS** (Program Service name)
- **PI** (Program Identification)
- **AF** (Alternative Frequencies for the actual program)
- **TP** (Traffic Program Identification)
- **TA** (Traffic Announcement Identification)

RDS AF/REG function

To switch on or off the AF function (Alternative Frequencies), shortly press the **AF/REG**. To switch on or off the REG function (Regional Network Tracking), long press the **AF/REG** more than 2 seconds).

PROGRAM TYPE function

To select a certain program type out of the reception band, the following procedure can be used.

- 1 Press the **BAND** to select FM mode.
- 2 After, press the **PTY** repeatedly for selecting each mode.
music group → speech group → search off
- 3 Short press one of the **preset station 1 ~ 6**.
Each time this button is pressed, the display mode changes as follows.

No	Music group	No	Speech group
1.	Pop M, Rock M	1.	News, Affairs, Info
2.	Easy M, Light M.	2.	Sport, Educate, Drama
3.	Classics, Other M	3.	Culture, Science, Varied
4.	Jazz, Country	4.	Weather, Finance, Children
5.	Nation M, Oldies	5.	Social, Religion, Phone In
6.	Folk M	6.	Travel, Leisure, Document

Note

RDS is only available for FM reception.

RDS operation

RDS mode adjustment

- 1 Press the **SEL** for more than 2 seconds activate the select mode. : **LAC-M1600R**
Press the **VOL/SEL** for more than 2 seconds. : **LAC-M3600R**
- 2 After, press the **SEL** repeatedly to select each mode. : **LAC-M1600R**
After, press the **VOL/SEL** repeatedly. : **LAC-M3600R**
- 3 Press the **VOL+/-** (Press **VOLUME ▲ ▼** on the remote control) to select the indicator.
: **LAC-M1600R**
Rotate the **VOL/SEL**. : **LAC-M3600R**

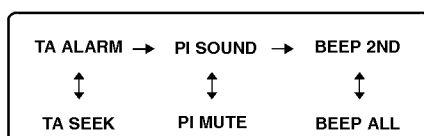

TA ALARM mode

When a newly tuned station has no TP information for 5 seconds, a double beep sound is output.

TA SEEK mode

When the newly tuned station does not receive TP information for 5 seconds, the receiver returns to the next station which has the same PI as the last station, but has the TP information.

PI SOUND mode

If the sound of a station with different PI is heard intermittently, the receiver mutes the sound after 1 second.

PI MUTE mode

If the situation described above is repeated, the receiver instantly mutes the sound.

BEEP 2ND mode

The beep is only generated when a key is long pressed. (1 sec)

BEEP ALL mode

The beep is generated when any key is pressed.

CD/MP3/WMA operation

Playing an Audio CD and MP3/WMA Disc

The unit can play MP3/WMA formatted recordings on CD-ROM, CD-R or CD-RW discs. Before playing MP3/WMA recordings, read the notes on MP3/WMA Recordings on page 19.

- To directly play a file, press the **NUMBER (#)** on remote control and then press the track number with **0-9** number.

Pause **CD** **MP3** **WMA**

- 1 Press the **▶/||** during playback.
- 2 To return to playback, press the **▶/||** again.

Moving to another track **CD** **MP3** **WMA**

- Press the **I◀/▶I** (**I◀◀ ◀◀/▶▶ ▶▶I** on the remote control) briefly during playback to go to the next track or to return to the beginning of the current track.
- Press the **I◀** (**I◀◀ ◀◀** on the remote control) twice briefly to step back to the previous track.

(If playing times is less then 3 seconds, there is no operation.)

Search **CD**

Press and hold the **I◀/▶I** (**I◀◀ ◀◀/▶▶ ▶▶I** on remote control) for about 1 second during playback and then release at the point you want.

Intro scan **CD** **MP3** **WMA**

- 1 Press the **SCAN**.
The **■ SCAN** appears in the display window. **MP3** **WMA**
(The first 10 seconds of each files in the current selected folder on the disc are played.)
The **SCAN** appears in the display window. **CD**
(The first 10 seconds of each files on the disc are played.)
Press and hold **SCAN** for about 2 seconds during playback.
The **SCAN** appears in the display window. **MP3** **WMA**
(The first 10 seconds of each files on the disc are played.)
- 2 Press the **SCAN** again.
The **SCAN** or **■ SCAN** disappears in the display window.
(The intro scan is cancelled.)

Repeat **CD** **MP3** **WMA**

- 1 Press the **RPT** during playback.
The **1 RPT** appears in the display window. **CD** **MP3** **WMA**
(The current selected music on the disc is played repeatedly.)
Press and hold **RPT** for about 2 seconds during playback.
The **■ RPT** appears in the display window. **MP3** **WMA**
(The current selected folder on the disc is played repeatedly.)
- 2 Press the **RPT** again.
The **1 RPT** or **■ RPT** disappears in the display window. (The repeat mode is cancelled.)

CD/MP3/WMA operation

Random **CD** **MP3** **WMA**

- 1 Press the **SHF** during playback.

The **SHF** appears in the display window. **MP3** **WMA**
(The current selected folder on the disc is played randomly.)

The **SHF** appears in the display window. **CD**
(All of the music on the disc is played randomly.)

Press and hold **SHF** for about 2 seconds during playback.

The **SHF** appears in the display window. **MP3** **WMA**
(All of the music on the disc is played randomly.)

- 2 Press the **SHF** again.

The **SHF** or **SHF** disappears in the display window. (The random playback is cancelled.)

Note

During random playback, if you press the **◀** (**◀◀** **◀◀** on remote control), you won't go back to the previous track.

CD TEXT / ID3 TAG **CD** **MP3** **WMA**

Some discs have certain information encoded on the disc during manufacture.

These discs may contain such information as title, artist's name and album name and are called CD TEXT discs.

When playing a disc containing information, you can see the information (Folder name, File name, ID3 TAG, Title, Artist or Album) in the display window. If there is no information, "NO TEXT" will be shown in the display window.

Press the **DISP** repeatedly during MP3/WMA file playback.

MP3/WMA TRACK -10/+10 **MP3** **WMA** (If there is no folder or one folder.)

During playback, press the **F-** to go back to the previous 10 track, and press the **F+** to go forward to the next 10 track.

MP3/WMA FOLDER UP/DOWN **MP3** **WMA** (If there are more than two folders.)

During playback, press the **F-** to go back to the previous folder, and press the **F+** to go forward to the next folder.

Note

Time display appearing on the display part when playing VBR file may vary and there may be some difference from actual time (both progress time and VBR are displayed at the same time when playing file).

Troubleshooting

Symptom	Cause	Correction
Power doesn't turn on. The unit doesn't operate.	<ul style="list-style-type: none"> Leads and connectors are not properly connected. The fuse is blown. Noise and other factors are causing the built-in microprocessor to operate incorrectly. 	<ul style="list-style-type: none"> Confirm once more that all connections are correct. Rectify the problem that caused the fuse to blow, and then replace it. Be very sure to install the correct fuse with the same rate. Turn the unit off and then on.
Playback is not possible.	<ul style="list-style-type: none"> The disc is dirty. The loaded disc is of a type this unit cannot play. 	<ul style="list-style-type: none"> Clean disc. Check what type the disc.
No sound is heard. The volume level will not rise.	<ul style="list-style-type: none"> Cables are not connected correctly. 	<ul style="list-style-type: none"> Connect the cables correctly.
There's no sound.	<ul style="list-style-type: none"> The volume level is low. 	<ul style="list-style-type: none"> Adjust the volume.
There's audio skipping.	<ul style="list-style-type: none"> This unit is not firmly secured. 	<ul style="list-style-type: none"> Secure this unit firmly.
The unit does not operate correctly even when the appropriate remote control buttons are pressed.	<ul style="list-style-type: none"> Battery power is low. Some operations are prohibited with certain discs. 	<ul style="list-style-type: none"> Load new battery. Check using another disc.



This product is manufactured to comply with the radio interference requirements of EEC DIRECTIVE 89/336/EEC, 93/68/EEC and 73/23/EEC.

Specifications



MP3/WMA Disc compatibility with this unit is limited as follows:

1. Sampling Frequency / 8 - 48kHz (MP3) 22.05 - 48kHz (WMA)
2. Bit rate / within 8 - 320kbps (include VBR) (MP3) 32 -320kbps (WMA)
3. CD-R/CD-RW physical format should be "ISO 9660"
4. If you record MP3/WMA files using software which cannot create a FILE SYSTEM, for example "Direct-CD" etc., it will not be possible to playback MP3/WMA files. We recommend that you use "Easy-CD Creator" which creates an ISO9660 file system.

Customers should also note that permission is required in order to download MP3/WMA files and music from the Internet.

Our company has no right to grant such permission.

Permission should always be sought from the copyright owner.

GENERAL

Output Power	.50W x 4CH (Max.)
Power Source	.DC 12V
Speaker impedance	.4-8 Ω
Ground System	Negative
Dimensions (W x H x D)	.182 x 51 x 171 mm (Without Front Panel)
Net Weight	.1.35 kg

CD SELECTION

Frequency Response	.20 Hz-20 kHz
S/N Ratio	.80 dB
Distortion	.0.1%
Channel Separation (1kHz)	.70 dB

RADIO SELECTION

FM

Frequency Range	.87.5-107.9 or 87.5-108 MHz
S/N Ratio	.55 dB
Distortion	.0.7%
Usable Sensitivity	.12 dB μ V

AM (MW)

Frequency Range	.520-1720 or 522-1620 kHz
S/N Ratio	.45 dB
Distortion	.1.0%
Usable Sensitivity	.28 dB μ V

Disposal of your old appliance

1. When this crossed-out wheeled bin symbol is attached to a product, it means the product is covered by the European Directive 2002/96/EC.
2. All electrical and electronic products should be disposed of separately from the municipal waste stream via designated collection facilities appointed by the government or the local authorities.
3. The correct disposal of your old appliance will help prevent potential negative consequences for the environment and human health.
4. For more detailed information about disposal of your old appliance, please contact your city office, waste disposal service or the shop where you purchased the product.



3834RR0049P