



LCD TV

OWNER'S MANUAL

MODEL: 32LB1R** | 37LB1R** |
42LB1R** |



Please read **Information Manual** included together before reading this manual and operating your set.

Retain it for future reference.

Record model number and serial number of the set.

See the label attached on the back cover and quote this information to your dealer when you require service.

P/NO : 38289U0023E(0607-REV00)

Printed in Korea

Accessories

Ensure that the following accessories are included with your TV. If any accessory is missing, please contact the dealer from where you purchased the product.

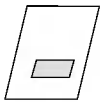

Owner's Manual

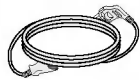

Power Cord

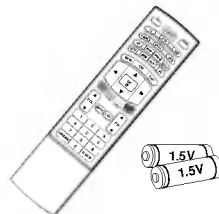

Remote Control / Batteries



Twister Holder



D-SUB cable (PC)



Audio cable (PC)



2-TV Bracket Bolts



2-TV Brackets
2-Wall Bracket



Cable Management



Polishing Cloth
Polish the screen
with the cloth.

Slightly wipe stained spot on the exterior only with the cleansing cloths for the product exterior if there is stain or fingerprint on surface of the exterior.

Do not wipe roughly when removing stain. Please be cautious of that excessive power may cause scratch or discoloration.

Contents

Introduction

- 2 Accessories
- 5 **Controls**
- 5 Swivel stand
- 6 **Connection Options**
- 8 **Remote Control Key Functions**

Installation

- 11 **Basic Connection**
- 13 **External Equipment Connections**
- 13 Antenna Connection
- 13 Headphone Socket
- 14 VCR Setup
- 16 DVD Setup
- 17 External Stereo
- 18 STB (Set-Top Box) Setup
- 19 Cable TV Setup
- 20 External AV Source Setup
- 21 PC Setup
- 22 Supported display resolution
- 22 Power Cord Connection

Operation

- 23 Turning On/Off the TV
- 23 Volume Adjustment
- 23 Programme selection
- 23 On screen language selection
- 24 How to adjust the OSD screen
- 25 Auto programme tuning
- 26 Manual programme tuning
- 27 Fine tuning
- 28 Assigning a station name
- 29 Programme edit
- 30 Favourite programme
- 30 Calling the programme table
- 31 PSM (Picture Status Memory)
- 31 CSM (Colour Status Memory)
- 32 **xD** Function
- 32 ACM (Active Colour Management)
- 33 sRGB
- 33 Manual Picture Adjustment
- 34 SSM (Sound Status Memory)
- 34 BBE
- 35 AVL (Auto Volume leveler)
- 35 Manual Sound Adjustment
- 36 TV Speaker
- 37 I/II
- 38 Clock Setup
- 38 On/Off Time
- 39 Auto Sleep
- 39 Sleep Timer

Operation	Special Menu	40	Child Lock	
		40	XD Demo	
		41	Lightening Index	
			
	Screen Menu		42	Auto Configure
			42	Manual Configure
			43	XGA Mode
			43	Picture Size Zoom
			44	Picture format (ARC)
			45	Screen Position
			45	Cinema
			46	NR (Noise Reduction)
		46	Reset to original factory value (Initializing)	
			
PIP (Picture-In-Picture) / DW (Double Window) Menu		47	Main Picture Input	
		47	Watching DW/PIP	
		48	PIP Input	
		49	Win. Size/Position	
	50	PIP Transparency		
.....				
Teletext		52	Switch on/off	
		52	SIMPLE text	
		52	TOP text	
		53	FASTEXT	
		53	Special teletext functions	
.....				
Reference		54	Troubleshooting Checklist	
		55	Product Specifications	
		56	Programming the Remote control	
		57	Programming Codes	
		59	IR codes	
	61	External Control Device Setup ; RS-232C		

Introduction

Controls

- This is a simplified representation of front panel.
- Here shown may be somewhat different from your TV.

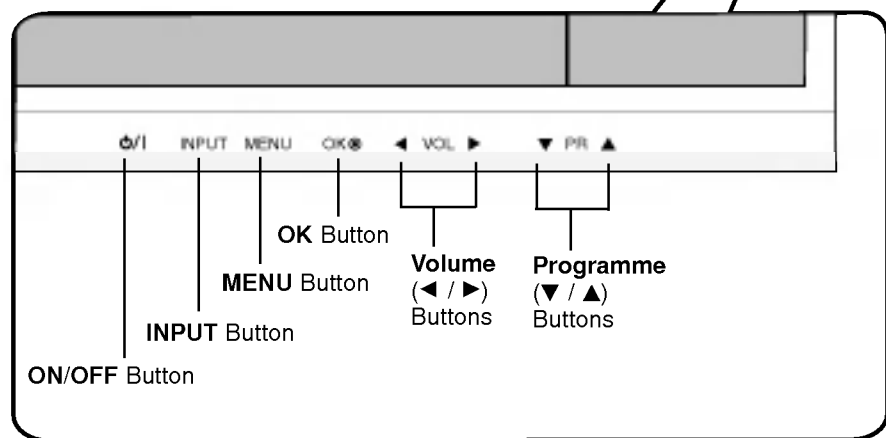
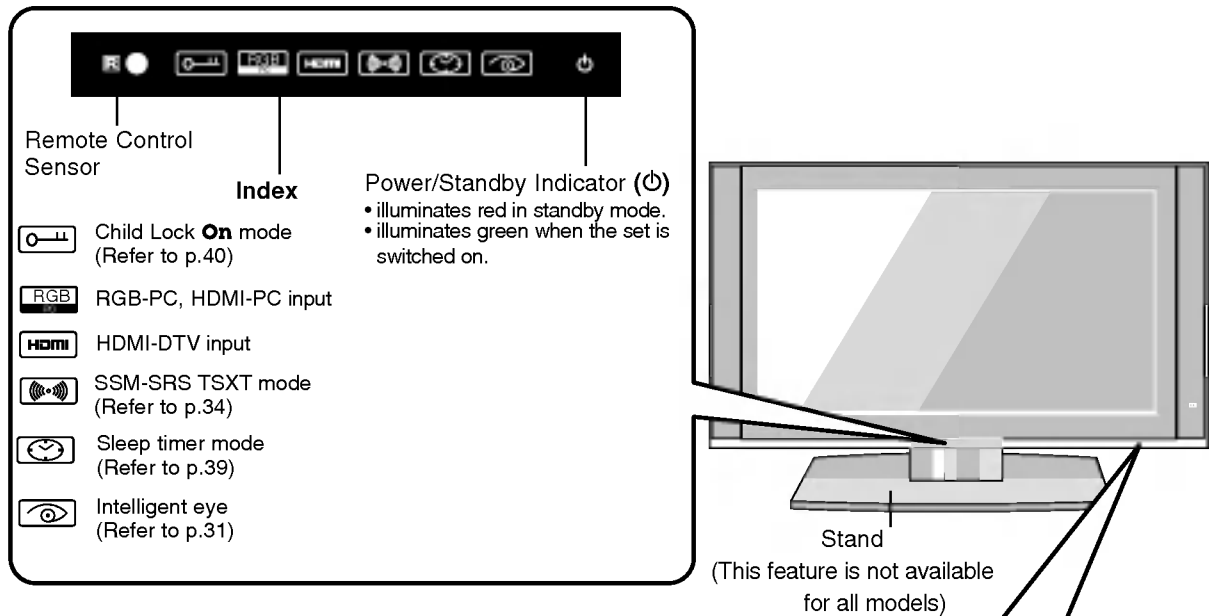

Swivel Stand

- This feature is not available for all models.

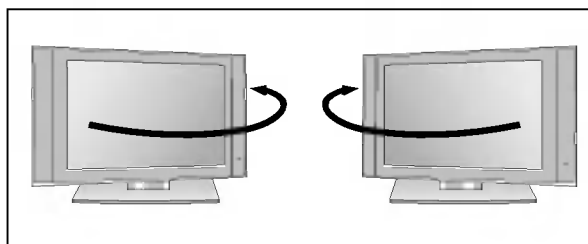

- The TV can be conveniently swiveled on its stand 30° to the left or right to provide the optimum viewing angle.

Introduction

Connection Options (Model: 32LB1R**/37LB1R**)

- Here shown may be somewhat different from your TV.

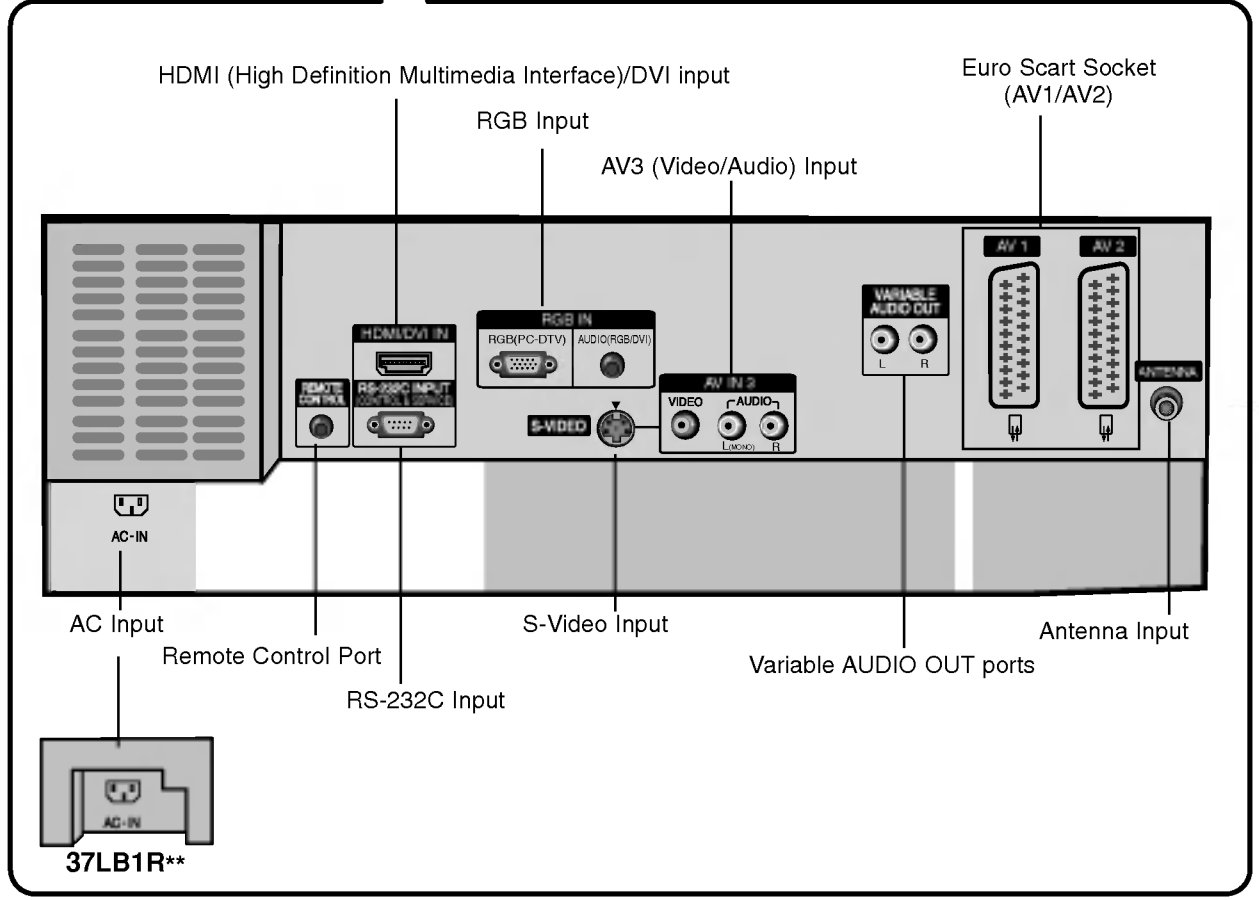
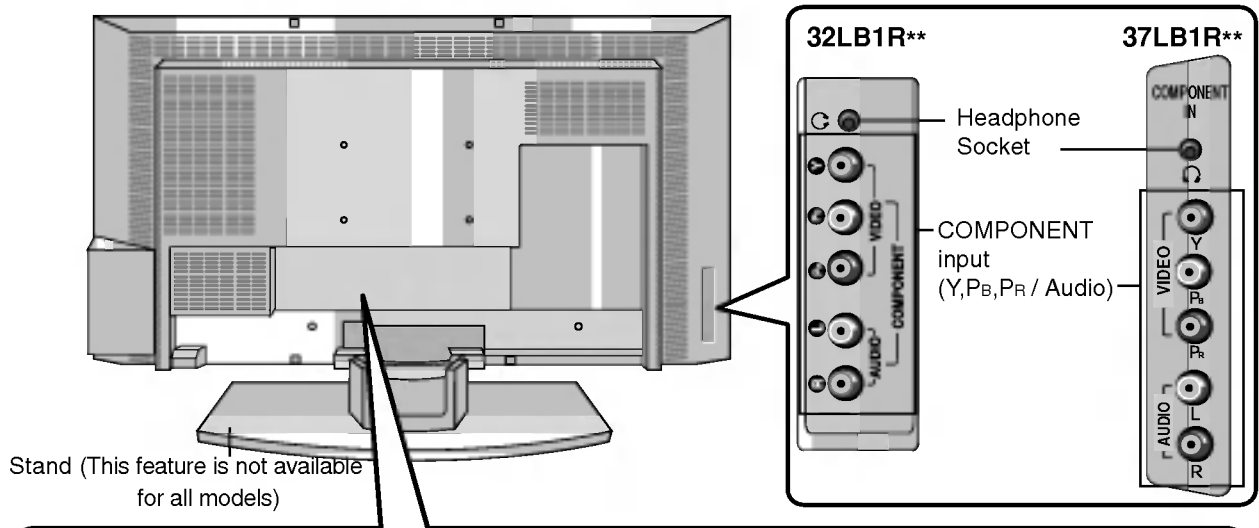

Connection Options (Model: 42LB1R**)

- Here shown may be somewhat different from your TV.

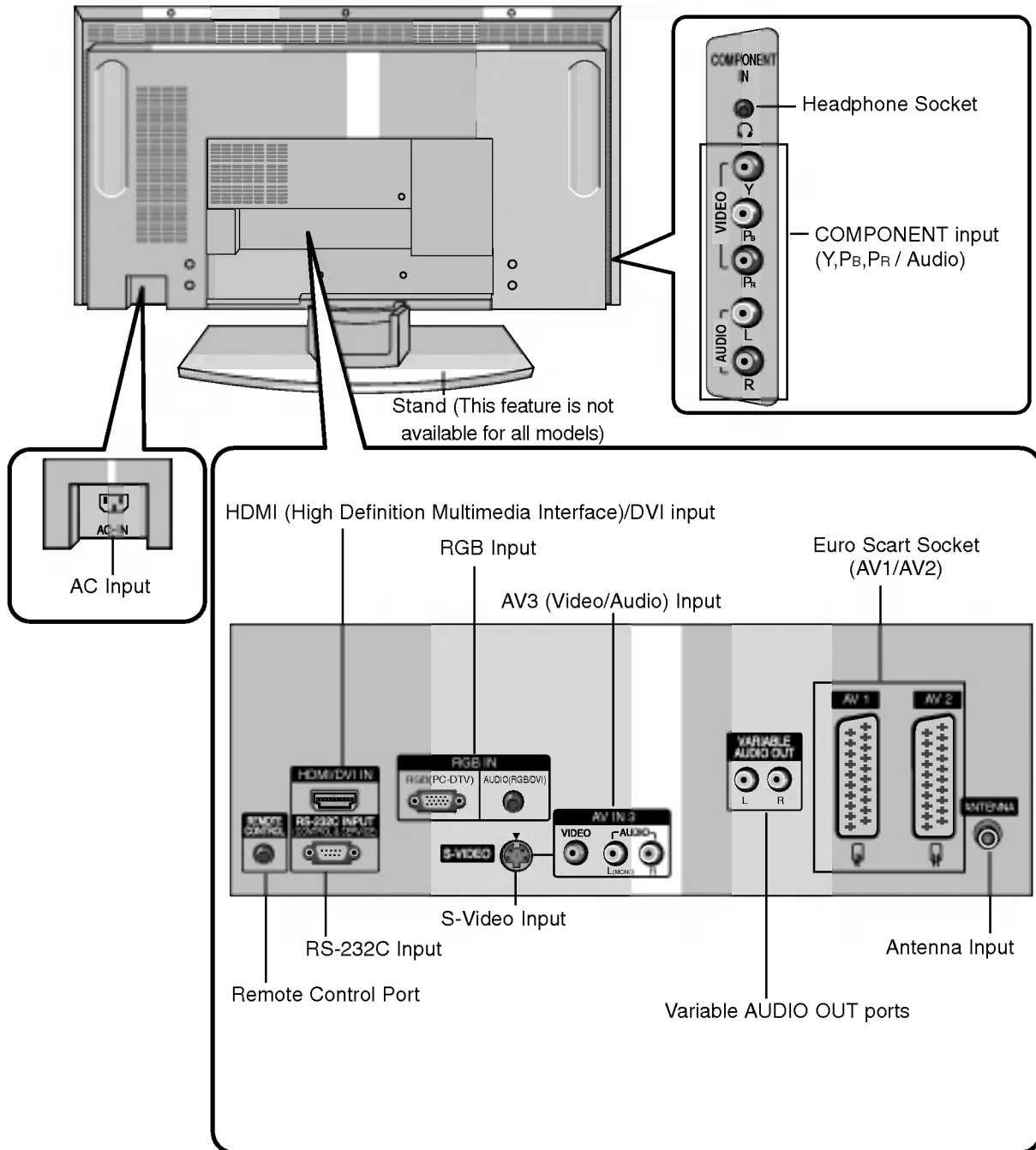

Introduction

Remote Control Key Functions

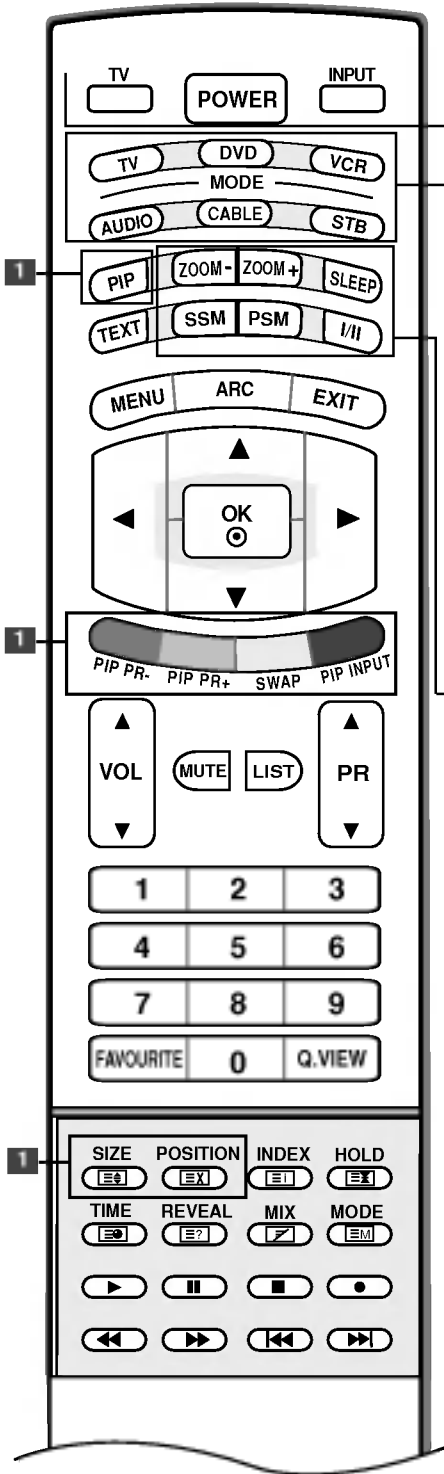

TV
Returns to TV viewing from any mode.

POWER
switches the set on from standby or off to standby.

INPUT

Input
TV
AV1
AV2
AV3
S-Video
Component
RGB PC
HDMI PC

If you press the button once, the input source OSD will appear on screen as shown. Press the ▲ / ▼ button and then **OK** button to select the desired input source (**TV, AV1, AV2, AV3, S-Video, Component, RGB PC/RGB DTV, or HDMI PC/HDMI DTV**).

MODE
Selects the remote operating modes. :TV, DVD, VCR, AUDIO, CABLE or STB

1 PIP BUTTONS

PIP (Refer to p.48)
Switches the sub picture PIP, DW, POP or off mode.

PIP PR - / + (Refer to p.51)
Selects a programme for the sub picture.

SWAP (Refer to p.51)
Alternates between main and sub picture.

PIP INPUT (Refer to p.48)
Selects the input mode for the sub picture.

SIZE (Refer to p.49)
Adjusts the sub picture size.

POSITION (Refer to p.49)
Moves the sub picture to ▲ / ▼ or ◀ / ▶ direction.

***COLOURED BUTTONS** : These buttons are used for teletext (only **TELETEXT** models) or **Programme edit**.

ZOOM - / ZOOM +
Enlarges or reduces the main picture size.

SLEEP
Sets the sleep timer. (Refer to p.39)

SSM (Sound Status Memory)
Recalls your preferred sound setting. (Refer to p.34)

PSM (Picture Status Memory)
Recalls your preferred picture setting. (Refer to p.31)

I/II
• Selects the sound output.

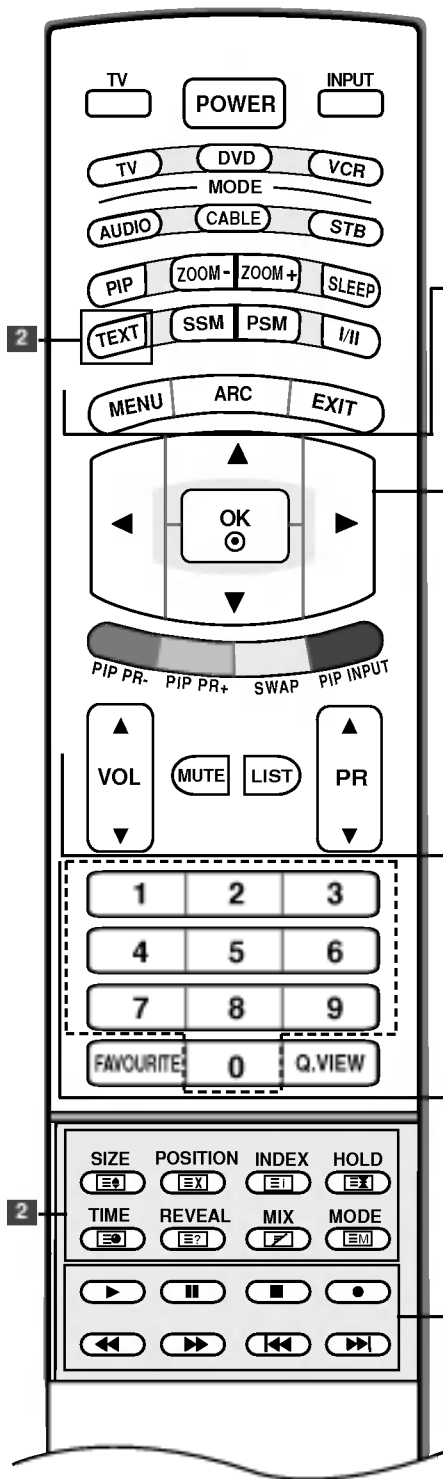

2 TELETEXT BUTTONS

These buttons are used for teletext.
For further details, see the 'Teletext' section (Refer to p.52).

MENU
Selects a menu.

ARC
Selects your desired picture format (Refer to p.44).

EXIT
Clears all on-screen displays and returns to TV viewing from any menu.

▲ / ▼ / ◀ / ▶ (up / down / left / right)
Selects or adjusts an item in the menu.

OK
Accepts your selection or displays the current mode.

VOL (Volume) ▲ / ▼
Adjusts the volume.

MUTE
Switches the sound on or off.

LIST
Displays the programme table (Refer to p.30).

PR (Programme) ▲ / ▼
Selects a programme.

0-9 number buttons
• Selects a programme.
• Selects numbered items in a menu.

FAVOURITE
Displays the selected favourite programme (Refer to p.30).

Q.VIEW
Returns to the previously viewed programme.

VCR/DVD Control buttons
Controls a LG video cassette recorder or DVD.

Introduction

Remote Control Key Functions

Installing Batteries

- 1** Open the battery compartment cover on the back side.

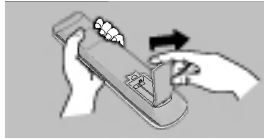

- 2** Insert two 1.5V AA size batteries in correct polarity (+ with +, - with -). Don't mix old or used batteries with new ones.

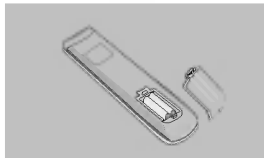

- 3** Close the cover.

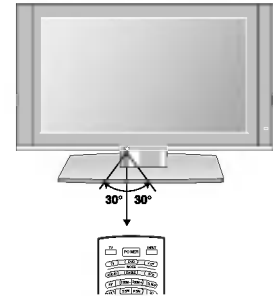
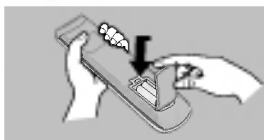

* Use a remote control 7 meter distance and 30 degree (left/right) within the receiving unit scope.

* Dispose of used batteries in the recycle bin to prevent environment.

Wall Mount: Horizontal installation

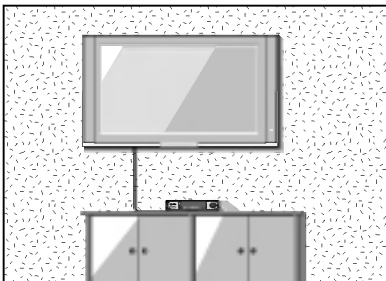

For proper ventilation, allow a clearance of 4" on each side and from the wall. Detailed installation instructions are available from your dealer, see the optional Tilt Wall Mounting Bracket Installation and Setup Guide.

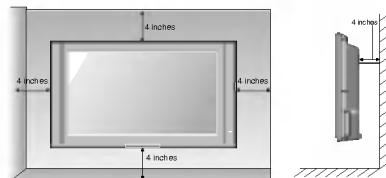

Desktop Pedestal Installation

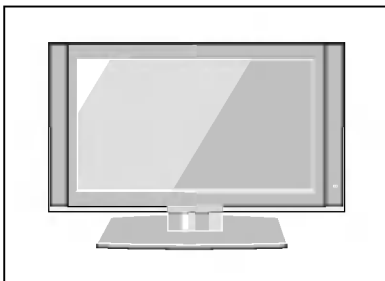

For proper ventilation, allow a clearance of 4" on each side and from the wall.

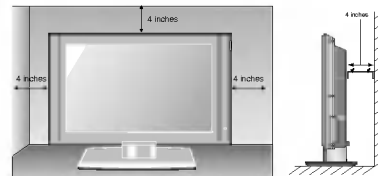

Installation

Basic Connection

- 1** Connect the cables as necessary. After connecting the cables neatly, arrange the cables to the Cable Holder.

To connect an additional equipment, see the **External equipment Connections** section.



37 inch

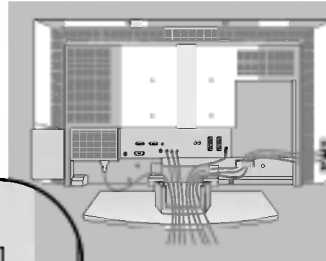

32/37 inch

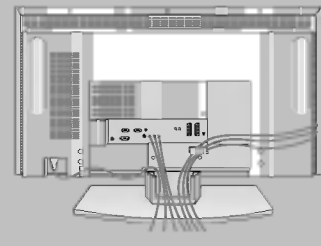

42 inch

- 2** Install the **CABLE MANAGEMENT** as shown.

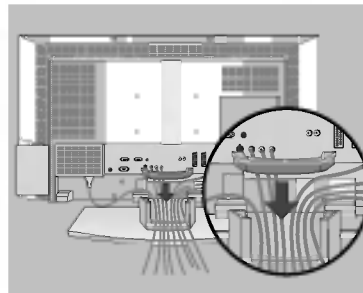

32/37 inch

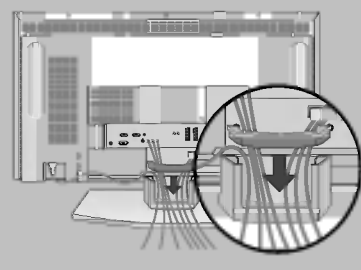

42 inch

- 3** Bundle the cables using the supplied twister holder.

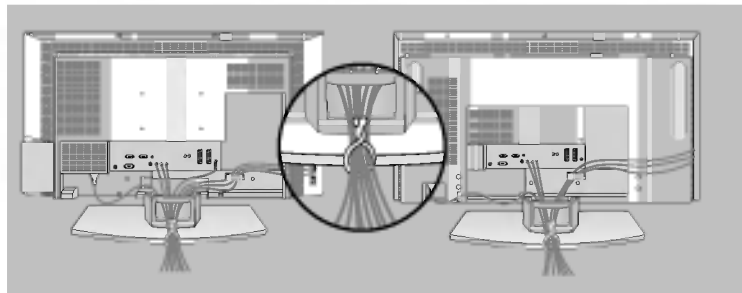

32/37 inch

42 inch

How to remove the CABLE MANAGEMENT

Hold the **CABLE MANAGEMENT** with both hands and pull it backward.



Do not hold the **CABLE MANAGEMENT** when moving the product.
- If the product is dropped, you may be injured or the product may be broken.

Installation

How to join the product assembly to the wall to protect the set tumbling

- Set it up close to the wall so the product doesn't fall over when it is pushed backwards.
- The instructions shown below is a safer way to set up the product, which is to fix it on the wall so the product doesn't fall over when it is pulled in the forward direction. It will prevent the product from falling forward and hurting people. It will also prevent the product from damage caused by fall. Please make sure that children don't climb on or hang from the product.

32/37 inch

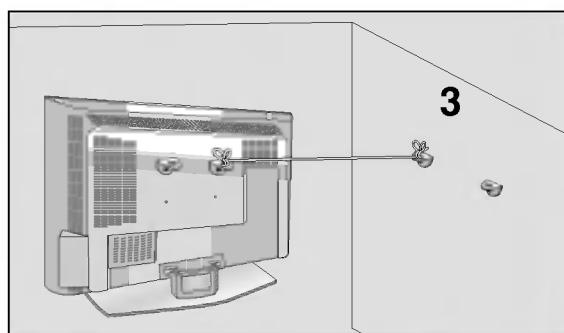
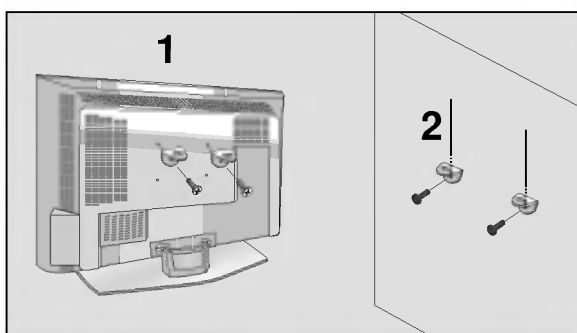

42 inch

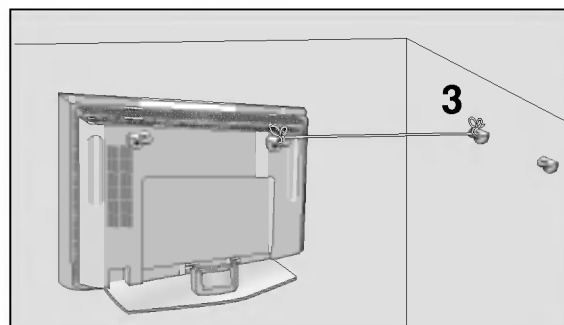
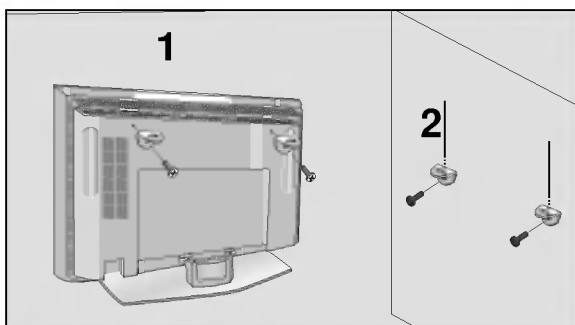

- 1** Use the bracket and the bolt to fix the product to the wall as shown in the picture.
- 2** Secure the bracket with the bolt (not provided as parts of the product, must purchase separately) on the wall.
- 3** Use a sturdy rope (not provided as parts of the product, must purchase separately) to tie the product. It is safer to tie the rope so it becomes horizontal between the wall and the product.

Notes

- When moving the product to another place undo the ropes first.
- Use a product holder or a cabinet that is big and strong enough for the size and weight of the product.
- To use the product safely make sure that the height of the bracket that is mounted on the wall is same as that of the product.

External Equipment Connections

To prevent the equipment damage, never plug in any power cords until you have finished connecting all equipment.

Antenna Connection

- For optimum picture quality, adjust antenna direction.
- An antenna cable and converter are not supplied.

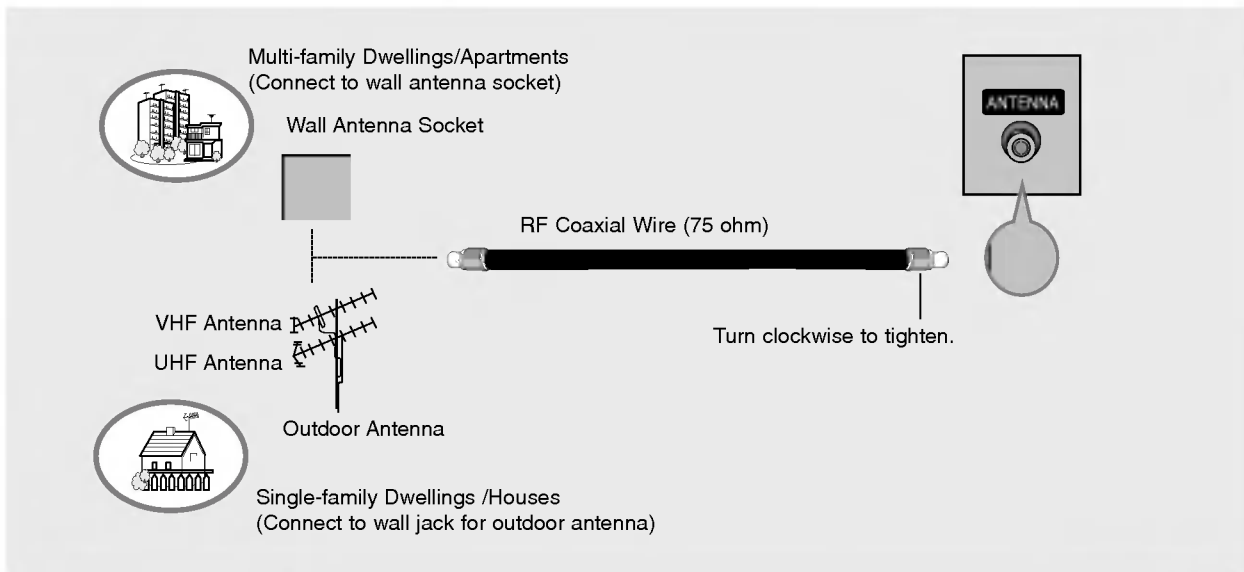

- In poor signal areas, to get better picture quality, install a signal amplifier to the antenna as shown to the right.
- If signal needs to be split for two TVs, use an antenna signal splitter for connection.



Headphone Socket

- You can listen to the sound through the headphone.

32 inch

37/42 inch

- 1 Plug the headphone into the headphone socket.
- 2 To adjust the headphone volume, press the **VOL** ▲ / ▼ button. If you press the **MUTE** button, the sound from the headphone is switched off.

• While you are listening to sound through a headphone, TV speakers will not be heard.

Installation Instruction

External Equipment Connections

VCR Setup

- To avoid picture noise (interference), leave an adequate distance between the VCR and TV.
- Typically a frozen still picture from a VCR. If the 4:3 picture format is used; the fixed images on the sides of the screen may remain visible on the screen.

When connecting with an antenna cable

- 1 Connect the **ANT OUT** socket of the VCR to the **Antenna** socket on the set.
- 2 Connect the antenna cable to the **ANT IN** socket of the VCR.
- 3 Press the **PLAY** button on the VCR and match the appropriate programme between the TV and VCR for viewing.

When connecting with a Scart cable

- 1 Connect the scart socket of the VCR to the **AV1** scart socket on the set. Please use shielded scart cable.
- 2 Insert a video tape into the VCR and press **PLAY** on the VCR. (Refer to the VCR owner's manual.)
- 3 Select **AV1** input source with using the **INPUT** button on the remote control.
 - If connected to **AV2** scart socket, select **AV2** input source.

- If your VCR outputs an AV switching signal via the **AV1** or **AV2** scart sockets, the set will switch to **AV1** input source automatically. But if you want to keep on watching TV mode, press the PR ▲ / ▼ or number buttons.
- You can also record programmes received by the TV on video tape.
- The signal type RGB (the signals red, green and blue) can only be selected for the **AV1** scart socket and the **AV1** input source can be received. These signals are transmitted, for example, by a pay TV decoder, game machine or photo CD unit, etc and that digital signal can be recorded via **AV1** scart socket.
- If the **AV1**, **AV2** scart sockets have been connected to the VCRs simultaneously, only the **AV2** input source can be received.

When connecting with a RCA cable

TV Back panel

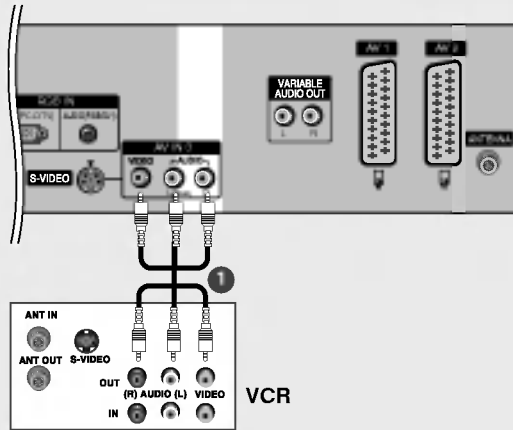

- 1 Connect the **AUDIO/VIDEO** jacks between TV and VCR. Match the jack colours (Video = yellow, Audio Left = white, and Audio Right = red)
- 2 Insert a video tape into the VCR and press **PLAY** on the VCR. (Refer to the VCR owner's manual.)
- 3 Select **AV3** input source with using the **INPUT** button on the remote control.



- If you have a mono VCR, connect the audio cable from the VCR to the **AUDIO L/MONO** jack of the set.

When connecting with an S-Video cable

TV Back panel

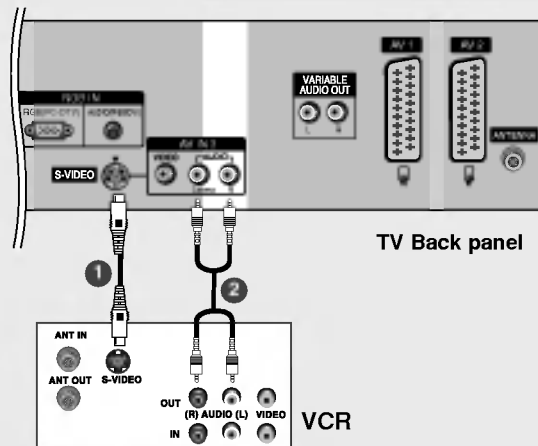

- 1 Connect the **S-VIDEO** output of the VCR to the **S-VIDEO** input on the set. The picture quality is improved; compared to connecting a regular VCR to the Video input.
- 2 Connect the **AUDIO** jacks between TV and VCR.
- 3 Insert a video tape into the VCR and press **PLAY** on the VCR. (Refer to the VCR owner's manual.)
- 4 Select **S-Video** input source with using the **INPUT** button on the remote control.

Installation

External Equipment Connections

DVD Setup

When connecting with a component cable

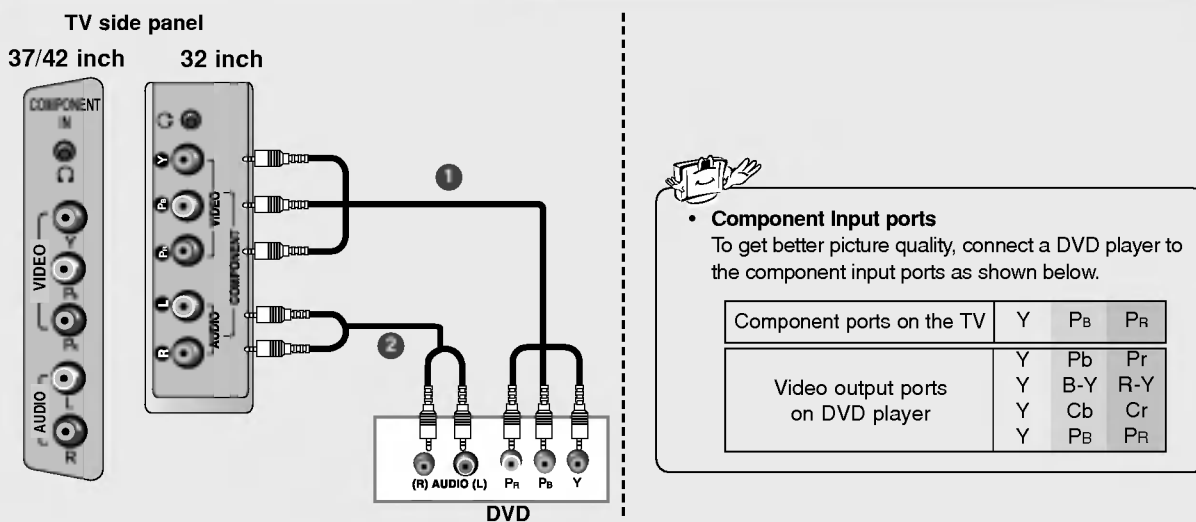

- 1 Connect the video outputs (Y, Pb, Pr) of the DVD player to the **COMPONENT VIDEO (Y, Pb, Pr)** jacks on the set.
- 2 Connect the audio outputs of the DVD player to the **COMPONENT AUDIO** jacks on the set.
- 3 Turn on the DVD player, insert a DVD.
- 4 Select **Component** input source with using the **INPUT** button on the remote control.
- 5 Refer to the DVD player's manual for operating instructions.

When connecting with a Euro scart cable

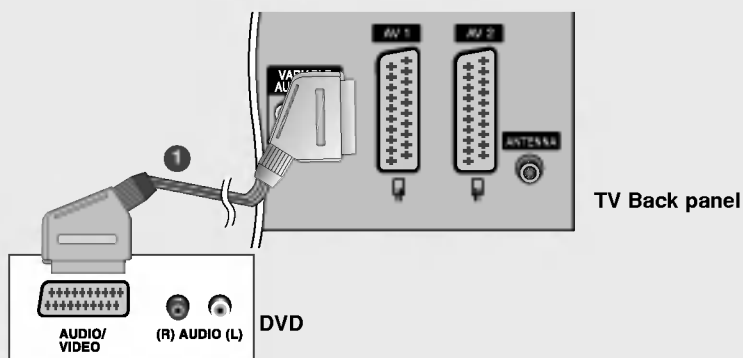

- 1 Connect the Euro scart socket of the DVD player to the **AV1** Euro scart socket on the set. Please use shielded scart cable.
- 2 Turn on the DVD player, insert a DVD.
- 3 Select **AV1** input source with using the **INPUT** button on the remote control.
- If connected to **AV2** Euro scart socket, select **AV2** input source.

When connecting with a HDMI cable

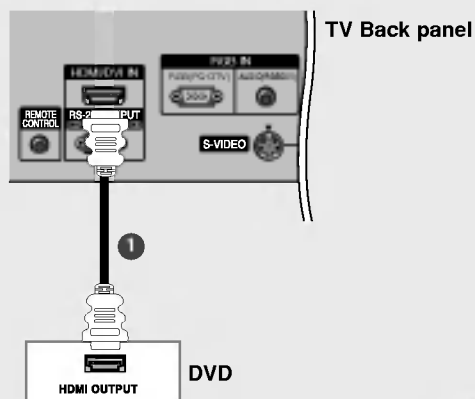

- 1 Connect the HDMI output of the DVD player to the **HDMI/DVI IN** jack on the set.
- 2 Select **HDMI DTV** input source with using the **INPUT** button on the remote control.
- 3 Refer to the DVD player's manual for operating instructions.



- TV can receive the video and audio signal simultaneously with using a HDMI cable.

External Stereo

- Use to connected either an external amplifier, or add a sub-woofer to your surround sound system.

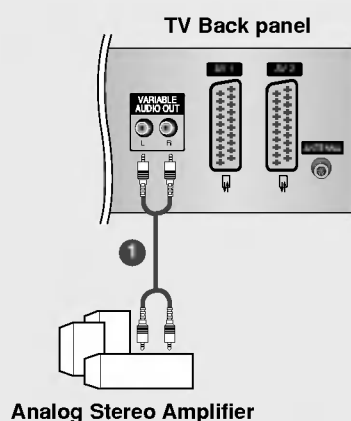

- 1 Connect the input jack of the stereo's amplifier to the **VARIABLE AUDIO OUT** jacks on the set.
- 2 Set up your speakers through your analog stereo amplifier, according to the instructions provided with the amplifier.
 - When connecting with external audio equipments, such as amplifiers or speakers, please turn the TV speakers off. (Refer to p.36)

Installation

External Equipment Connections

STB (Set-Top Box) Setup

When connecting with a component cable

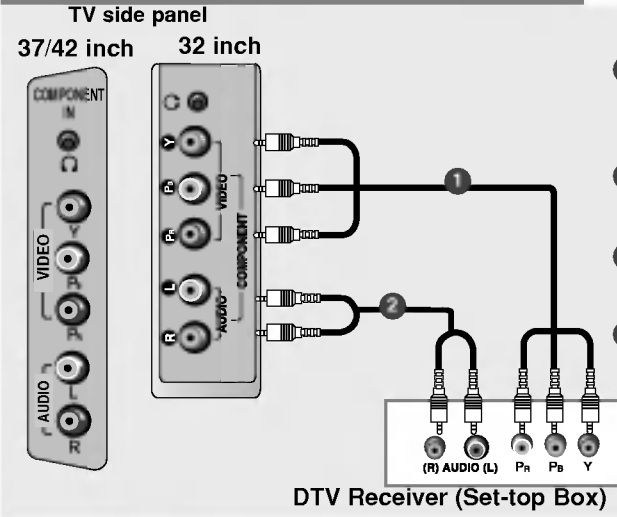

- 1 Connect the video outputs (Y, PB, PR) of the digital set-top box to the **COMPONENT VIDEO (Y, PB, PR)** jacks on the set.
- 2 Connect the audio outputs of the digital set-top box to the **COMPONENT AUDIO** jacks on the set.
- 3 Turn on the digital set-top box. (Refer to the owner's manual for the digital set-top box.)
- 4 Select **Component** input source with using the **INPUT** button on the remote control.

When connecting with a HDMI cable

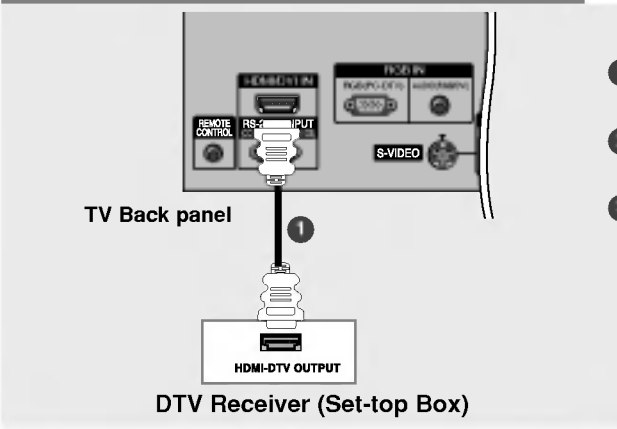

- 1 Connect the HDMI output of the digital set-top box to the **HDMI/DVI IN** jack on the set.
- 2 Turn on the digital set-top box. (Refer to the owner's manual for the digital set-top box.)
- 3 Select **HDMI DTV** input source with using the **INPUT** button on the remote control.

 • TV can receive the video and audio signal simultaneously with using a HDMI cable.

When connecting with a D-sub cable

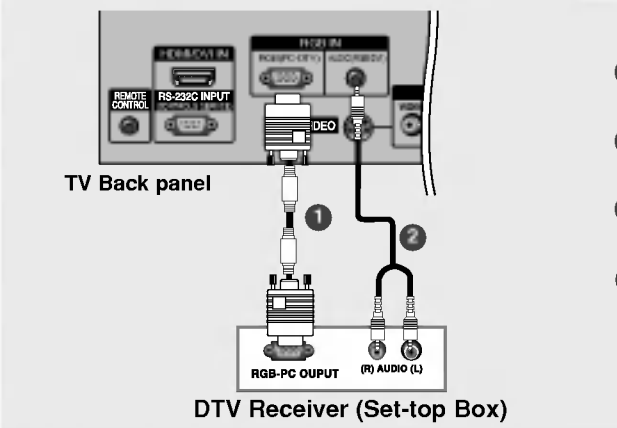

- 1 Connect the RGB output of the digital set-top box to the **RGB (PC-DTV)** jack on the set.
- 2 Connect the audio outputs of the set-top box to the **AUDIO (RGB/DVI)** jack on the set.
- 3 Turn on the digital set-top box. (Refer to the owner's manual for the digital set-top box.)
- 4 Select **RGB DTV** input source with using the **INPUT** button on the remote control.

When connecting with a HDMI to DVI cable

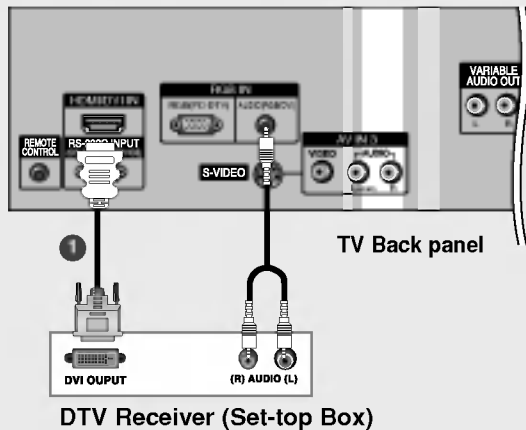

- 1 Connect the DVI output of the digital set-top box to the **HDMI/DVI IN** jack on the set.
- 2 Connect the audio outputs of the set-top box to the **AUDIO (RGB/DVI)** jack on the set.
- 3 Turn on the digital set-top box. (Refer to the owner's manual for the digital set-top box.)
- 4 Select **HDMI DTV** input source with using the **INPUT** button on the remote control.



• If the STB has a DVI output and no HDMI output, a separated audio connection is necessary.

Cable TV Setup

- After subscribing to a local cable TV service and installing a converter, you can watch cable TV programmes.
- For further cable TV information, contact a local cable service provider.

When connecting with a RCA cable

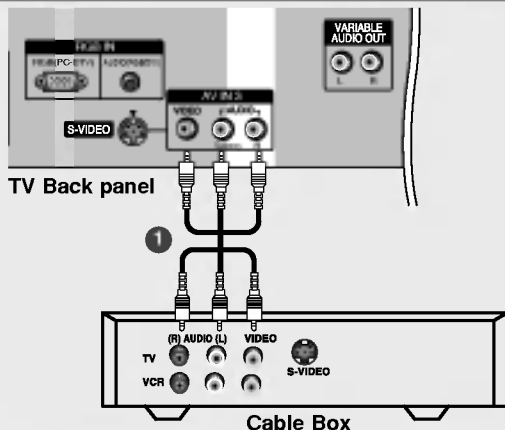

- 1 Connect the **AUDIO/VIDEO** jacks between TV and Cable Box. Match the jack colours (Video = yellow, Audio Left = white, and Audio Right = red)
- 2 Select **AV3** input source with using the **INPUT** button on the remote control.
- 3 Select programmes with the cable box remote control.

When connecting with an S-Video cable

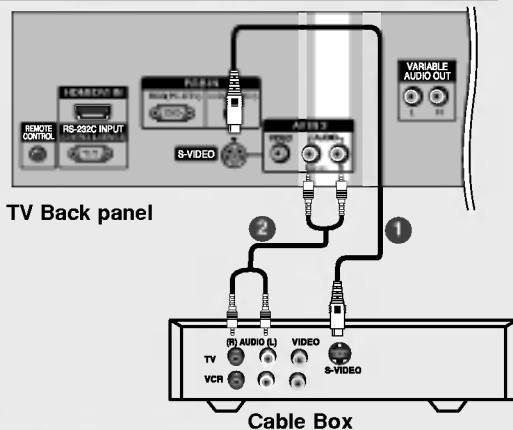

- 1 Connect the **S-VIDEO** output of the Cable Box to the **S-VIDEO** input on the set. The picture quality is improved.
- 2 Connect the **AUDIO** jacks between TV and Cable Box.
- 3 Select **S-Video** input source with using the **INPUT** button on the remote control.
- 4 Select programmes with the cable box remote control.

Installation

External Equipment Connections

External AV Source Setup

When connecting with a RCA cable

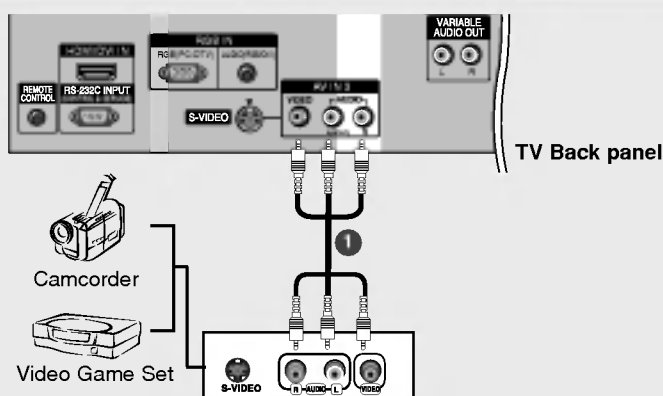

- 1 Connect the **AUDIO/VIDEO** jacks between TV and external equipment. Match the jack colours (Video = yellow, Audio Left = white, and Audio Right = red).
- 2 Select **AV3** input source with using the **INPUT** button on the remote control.
- 3 Operate the corresponding external equipment. Refer to external equipment operating guide.

When connecting with an S-Video cable

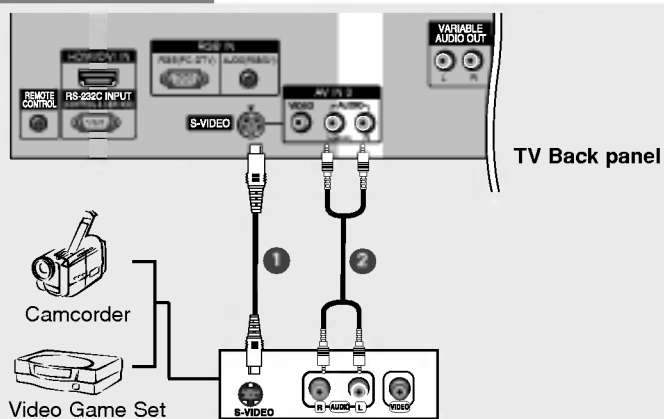

- 1 Connect the **S-VIDEO** output of the external equipment to the **S-VIDEO** input on the set. The picture quality is improved.
- 2 Connect the **AUDIO** jacks between TV and external equipment.
- 3 Select **S-Video** input source with using the **INPUT** button on the remote control.
- 4 Operate the corresponding external equipment. Refer to external equipment operating guide.

PC Setup

When connecting with a D-sub cable

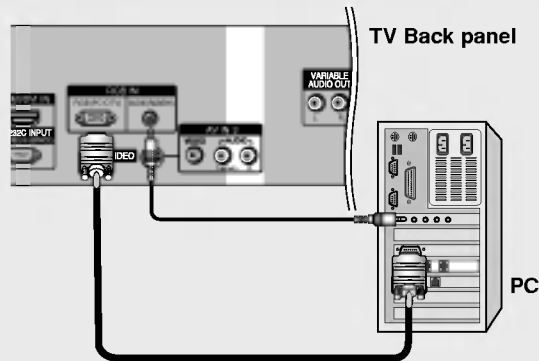

- 1 Connect the RGB output of the PC to the **RGB (PC-DTV)** jack on the set.
- 2 Connect the PC audio output to the **AUDIO (RGB/DVI)** jack on the set.
- 3 Turn on the PC and the set.
- 4 Select **RGB PC** input source with using the **INPUT** button on the remote control.

When connecting with a HDMI to DVI cable

TV Back panel

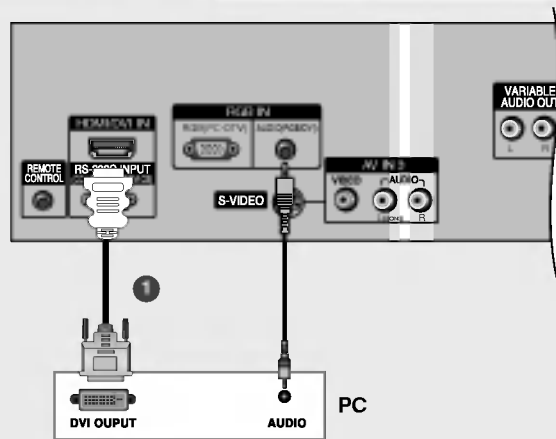

- 1 Connect the DVI output of the PC to the **HDMI/DVI IN** jack on the set.
- 2 Connect the PC audio output to the **AUDIO (RGB/DVI)** jack on the set.
- 3 Turn on the PC and the set.
- 4 Select **HDMI PC** input source with using the **INPUT** button on the remote control.



- If the PC has a DVI output and no HDMI output, a separated audio connection is necessary.

Installation

External Equipment Connections

Supported display resolution

■ PC (Monitor Display Specifications)

Resolution	Horizontal Frequency(kHz)	Vertical Frequency(Hz)
720 x 400	31.468	70
640 x 480	31.469 37.500	60 75
800 x 600	37.879 46.875	60 75
832 x 624	49.725	75
1024 x 768 (XGA)	48.363 56.470 60.123	60 70 75
1280 x 768 (WXGA)	47.776	60
1360 x 768 (WXGA)	47.720	60
1366 x 768 (WXGA)	47.720	60

Note

- For optimum picture quality, use standard WXGA 1360x768 computer output at a 60Hz refresh rate. Using other formats (VGA, SVGA, etc.) or refresh rates may result in reduced picture quality. (To change the computer video output format, please refer to the operating manual for the computer you are using).
- If the message **No signal** or any picture distortions appears on the screen, adjust the PC output to a format listed in the **Monitor Display Specification** table.
- The synchronization input form for Horizontal and Vertical frequencies is separate.

DPM (Display Power Management) mode

If the PC goes to power saving mode, the monitor automatically switches to DPM mode.
If you don't use the PC cable provided, DPM mode may not work.
- DPM mode is not available in HDMI PC mode.

■ DTV

Mode	Terminal	Component	RGB (DTV)	HDMI (DTV)
480i		o	x	x
576i		o	x	x
480p		o	o	o
576p		o	o	o
720p		o	o	o
1080i		o	o	o

Power Cord Connection

- Connect the power cord correctly as shown.

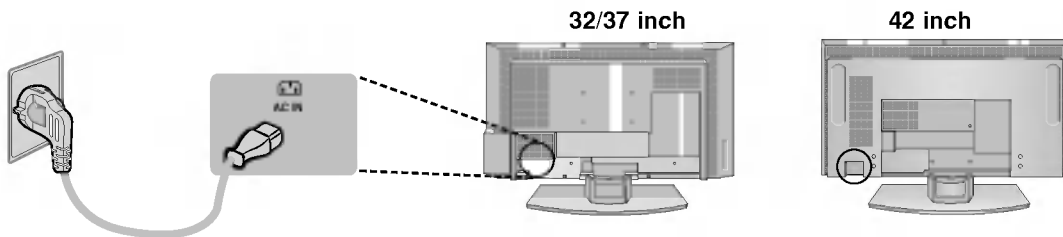

Operation

Basic Operation

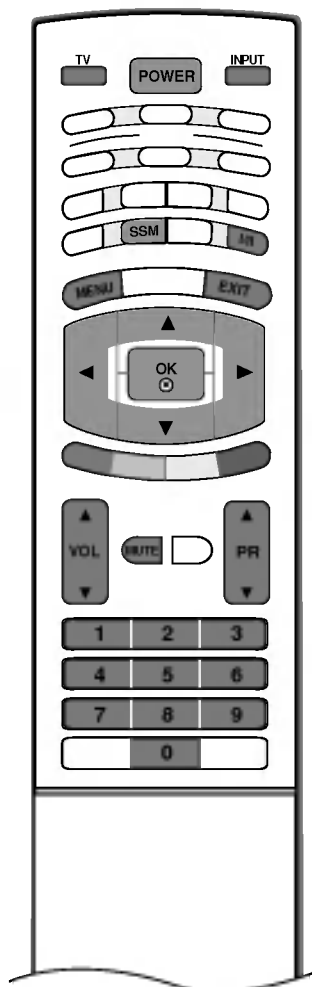

Turning On/Off the TV

- 1 First, make all equipment connections. Connect the AC power cord into the TV, then plug the power cord into a wall outlet. Press the **POWER** button located on the TV to turn on the TV. The power indicator will light.
 - In the standby mode, press the **POWER**, **PR** ▲ / ▼, **TV**, **INPUT** or number buttons on the remote control to turn on the TV.
- 2 If you want to turn the TV off, press the **POWER** button located on the remote control. If you intend to be away on vacation, disconnect the plug from the wall outlet.

Volume Adjustment

- 1 Press the **VOL** ▲ / ▼ button to adjust the volume.
- 2 If you want to switch the sound off, press the **MUTE** button. You can cancel this function by pressing the **MUTE**, **VOL** ▲ / ▼, **I/II** or **SSM** button.

Programme selection

- 1 Press the **PR** ▲ / ▼ or **NUMBER** buttons to select a programme number.

On screen language selection

- 1 Press the **MENU** button and then ▲ / ▼ button to select the **Special** menu.
- 2 Press the ► button and then ▲ / ▼ button to select **Language**.
- 3 Press the ► button and then ▲ / ▼ button to select your desired language. All the on screen displays will appear in the selected language.
- 4 Press the **OK** button.
- 5 Press the **EXIT** button to return to TV viewing.

Operation

Basic Operation

How to adjust the OSD screen

- 1 Press the **MENU** button and then **▲ / ▼** button to display each menu.
- 2 Press the **▶** button and then **▲ / ▼** button to select a menu item.
- 3 Change the setting of an item in the sub or pull-down menu with **◀ / ▶** button.
You can move to the higher level menu by pressing the **OK** or **MENU** button.

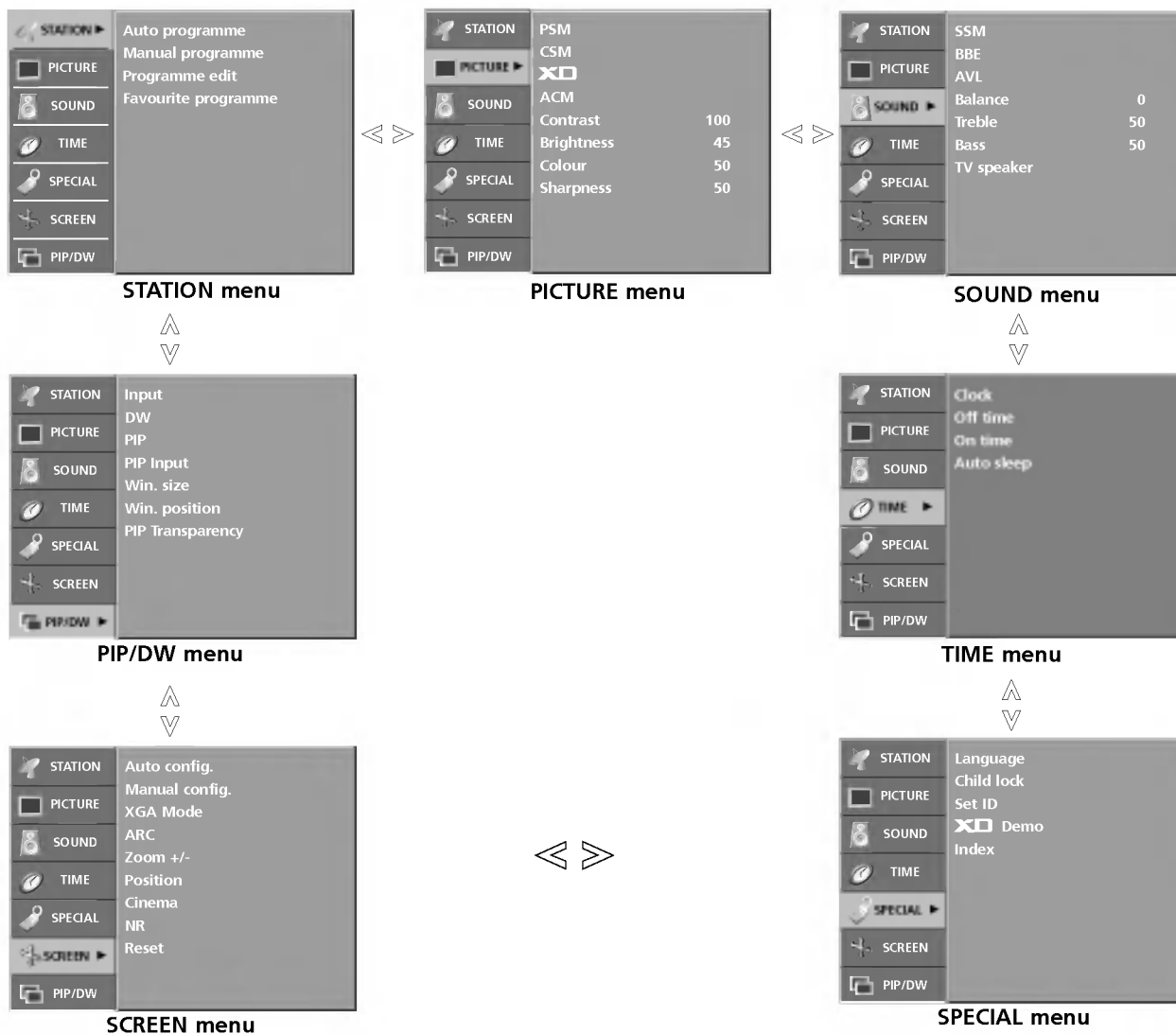

Note

- The OSD (On Screen Display) function enables you to adjust the screen status conveniently since it provides graphical presentation.
- In this manual, the OSD (On Screen Display) may be different from your TV's because it is just example to help the TV operation.
- In the teletext mode, menus are not displayed



Setting up TV stations

Up to 100 TV stations can be stored by programme numbers (0 to 99). Once you have preset the stations, you will be able to use the ▲ / ▼ or NUMBER buttons to scan the stations you have programmed. Stations can be tuned using automatic or manual modes.

Auto programme tuning



- All stations that can be received are stored by this method. It is recommended that you use auto programme during installation of this set.

- 1 Press the **MENU** button and then ▲ / ▼ button to select the **STATION** menu.
- 2 Press the ► button and then ▲ / ▼ button to select **Auto programme**.
- 3 Press the ► button and then ▲ / ▼ button to select **System**.
- 4 Press the ◀ / ▶ button to select a TV system menu;
BG : PAL B/G, SECAM B/G (Europe/East Europe)
I : PAL I/II (U.K./Ireland)
DK : PAL D/K, SECAM D/K (East Europe)
L : SECAM L/L' (France)
- 5 Press the ▲ / ▼ button to select **Storage from**.
- 6 Press the ◀ / ▶ button or NUMBER buttons to select the beginning programme number. If you use NUMBER buttons, any number under 10 is entered with a numeric '0' in front of it, i.e. '05' for 5.
- 7 Press the ▲ / ▼ button to select **Start**.
- 8 Press the ► button to begin auto programming.
All receivable stations are stored. The station name is stored for stations which broadcast VPS (Video Programme Service), PDC (Programme Delivery Control) or TELETEXT data. If no station name can be assigned to a station, the channel number is assigned and stored as **C** (V/UHF 01-69) or **S** (Cable 01-47), followed by a number.

To stop auto programming, press the **MENU** button.
When auto programming is completed, the **Programme edit** menu appears on the screen. See the **Programme edit** section to edit the stored programme.

- 9 Press the **EXIT** button to return to normal TV viewing.



Setting up TV stations

Manual programme tuning

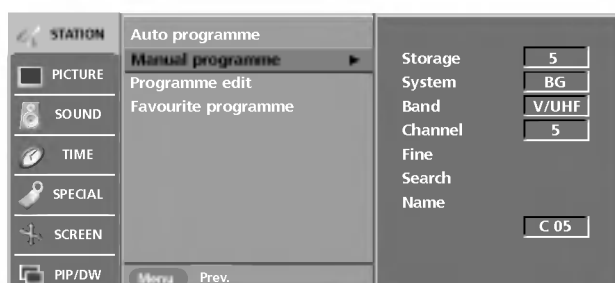

- *Manual programme lets you manually tune and arrange the stations in whatever order you desire.*

- 1 Press the **MENU** button and then **▲ / ▼** button to select the **STATION** menu.
- 2 Press the **▶** button and then **▲ / ▼** button to select **Manual programme**.
- 3 Press the **▶** button and then **▲ / ▼** button to select **Storage**.
- 4 Press the **◀ / ▶** button or NUMBER buttons to select the desired programme number (0 to 99). If you use NUMBER buttons, any number under 10 is entered with a numeric '0' in front of it, i.e. '05' for 5.
- 5 Press the **▲ / ▼** button to select **System**.
- 6 Press the **◀ / ▶** button to select a TV system menu;
BG : PAL B/G, SECAM B/G (Europe/East Europe)
I : PAL I/II (U.K./Ireland)
DK : PAL D/K, SECAM D/K (East Europe)
L : SECAM L/L' (France)
- 7 Press the **▲ / ▼** button to select **Band**.
- 8 Press the **◀ / ▶** button to select **V/UHF** or **Cable**.
- 9 Press the **▲ / ▼** button to select **Channel**.
- 10 You can select the desired programme number with the **◀ / ▶** button or number buttons. If possible, select the programme number directly with the number buttons. Any number under 10 is entered with a numeric '0' in front of it, i.e. '05' for 5.
- 11 Press the **▲ / ▼** button to select **Search**.
- 12 Press the **◀ / ▶** button to commence searching. If a station is found the search will stop.
- 13 Press the **OK** button to store it.
- 14 To store another station, repeat steps 3 to 13.
- 15 Press the **EXIT** button to return to normal TV viewing.

Fine tuning

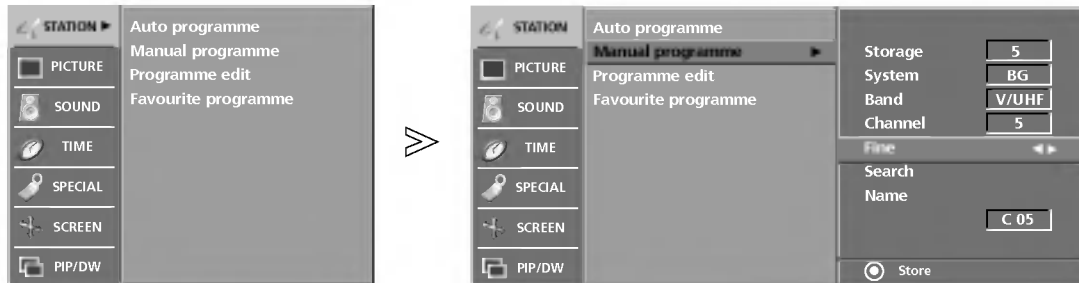

- Normally fine tuning is only necessary if reception is poor.

- 1 Press the **MENU** button and then **▲ / ▼** button to select the **STATION** menu.
- 2 Press the **▶** button and then **▲ / ▼** button to select **Manual programme**.
- 3 Press the **▶** button and then **▲ / ▼** button to select **Fine**.
- 4 Press the **◀ / ▶** button to to fine tune for the best picture and sound.
- 5 Press the **OK** button to store it.
- 6 Press the **EXIT** button to return to normal TV viewing.



Setting up TV stations

Assigning a station name



- You can assign a station name with five characters to each programme number.

- 1 Press the **MENU** button and then **▲ / ▼** button to select the **STATION** menu.
- 2 Press the **▶** button and then **▲ / ▼** button to select **Manual programme**.
- 3 Press the **▶** button and then **▲ / ▼** button to select **Name**.
- 4 Press the **▶** button and then **▲ / ▼** button. You can use a blank, **+**, **-**, the number **0** to **9** and the alphabet **A** to **Z**.
- 5 Press the **◀ / ▶** button to select the position and make your choice of the second character, and so on.
- 6 Press the **OK** button to store it.
- 7 Press the **EXIT** button to return to normal TV viewing.

Programme edit

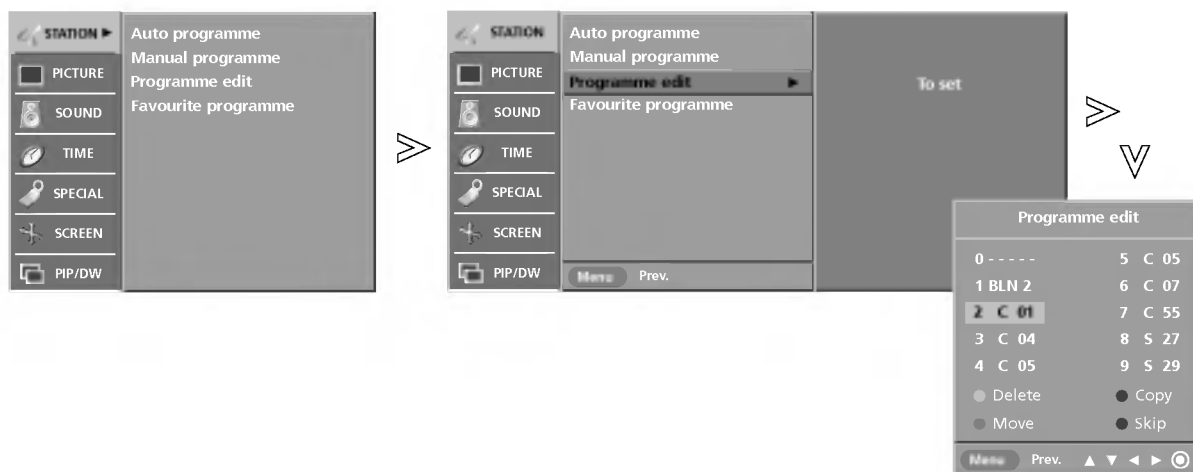

- This function enables you to delete or skip the stored programmes. Also you can move some stations to other programme numbers or copy a blank station data into the selected programme number.

- 1 Press the **MENU** button and then **▲ / ▼** button to select the **STATION** menu.
- 2 Press the **▶** button and then **▲ / ▼** button to select **Programme edit**.
- 3 Press the **▶** button to display the **Programme edit** menu.

■ Deleting a programme

1. Select a programme to be deleted with the **▲ / ▼ / ◀ / ▶** button.
2. Press the **RED** button twice.
The selected programme is deleted, all the following programmes are shifted up one position.

■ Copying a programme

1. Select a programme to be copied with the **▲ / ▼ / ◀ / ▶** button.
2. Press the **GREEN** button.
All the following programmes are shifted down one position.

■ Moving a programme

1. Select a programme to be moved with the **▲ / ▼ / ◀ / ▶** button.
2. Press the **YELLOW** button.
3. Move the programme to the desired programme number with the **▲ / ▼ / ◀ / ▶** button.
4. Press the **YELLOW** button again to release this function.

■ Skipping a programme number

1. Select a programme number to be skipped with the **▲ / ▼ / ◀ / ▶** button.
2. Press the **BLUE** button. The skipped programme turns to blue.
3. Press the **BLUE** button again to release the skipped programme.
When a programme number is skipped it means that you will be unable to select it using the **▲ / ▼** button during normal TV viewing. If you want to select the skipped programme, directly enter the programme number with the **NUMBER** buttons or select it in the programme edit or table menu.

- 4 Press the **EXIT** button to return to normal TV viewing.

Setting up TV stations

Favourite programme

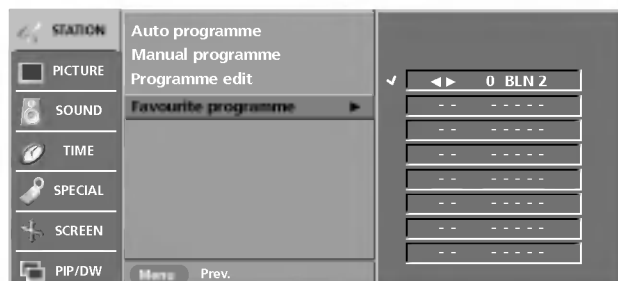
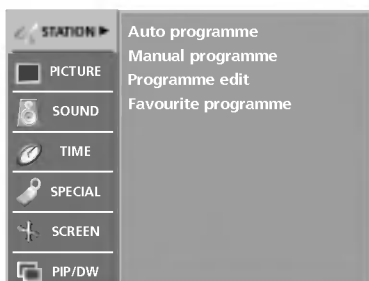

- This function lets you select your favourite programmes directly.
- Repeatedly press the **FAVOURITE** button to select stored favourite programmes.

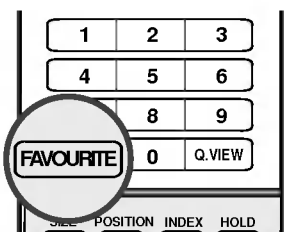

- 1 Press the **MENU** button and then $\blacktriangle / \blacktriangledown$ button to select the **STATION** menu.
- 2 Press the \blacktriangleright button and then $\blacktriangle / \blacktriangledown$ button to select **Favourite programme**.
- 3 Press the \blacktriangleright button.
- 4 Press the $\blacktriangle / \blacktriangledown$ button to select -- ----.
- 5 Select a desired programme with the $\blacktriangleleft / \blacktriangleright$ button or NUMBER buttons. Any number under 10 is entered with a numeric '0' in front of it, i.e. '05' for 5.
- 6 To store another programme, repeat steps 4 to 5. You can store up to 8 programmes.
- 7 Press the **EXIT** button to return to normal TV viewing.

Calling the programme table

- You can check the programmes stored in the memory by displaying the programme table.

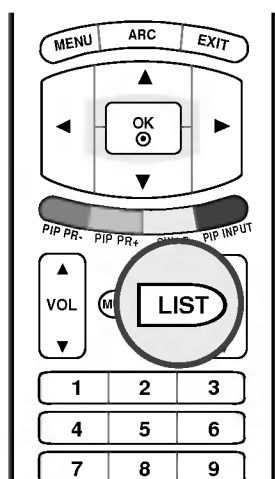

■ Displaying programme table

Press the **LIST** button to display the **Programme table** menu. The programme table appears on the screen. One programme table contains ten programmes as below.

0	----	5	C 05
1	BLN 2	6	C 07
2	C 01	7	C 55
3	C 04	8	S 27
4	C 05	9	S 29



Note

- You may find some blue programmes. They have been set up to be skipped by auto programming or in the programme edit mode.
- Some programmes with the channel number shown in the programme table indicate there is no station name assigned.

■ Selecting a programme in the programme table

Select a programme with the $\blacktriangle / \blacktriangledown / \blacktriangleleft / \blacktriangleright$ button. Then press the **OK** button. The set switches to the chosen programme number.

■ Paging through a programme table

There are 10 programme table pages in which contain 100 programmes. Pressing the $\blacktriangle / \blacktriangledown / \blacktriangleleft / \blacktriangleright$ button repeatedly turns the pages.

Press the **EXIT** button to return to normal TV viewing.

Picture adjustment

PSM (Picture Status Memory)

- This function adjusts the set for the best picture appearance.
- When adjusting **Contrast**, **Brightness**, **Colour**, **Sharpness**, and **Tint** (NTSC only) manually, PSM automatically changes to **User**.
- **Dynamic**, **Standard**, and **Mild** are programmed for optimum picture reproduction at the factory and cannot be changed.
- When the Intelligent eye function is on, picture is automatically adjusted to most suitable according to the surrounding conditions.
- You can also use the **PICTURE** menu to adjust **PSM**.

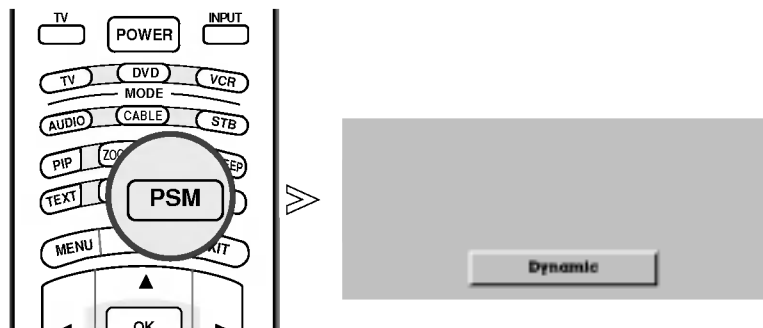

- 1 Press the **PSM** button repeatedly to select the picture appearance setup option as shown below: **Intelligent Eye**, **Dynamic**, **Standard**, **Mild**, or **User**.

CSM (Colour Status Memory)

STATION	PSM	
PICTURE	CSM	
	XD	
SOUND	ACM	
	Contrast	100
TIME	Brightness	45
	Colour	50
SPECIAL	Sharpness	50
SCREEN		
PIP/DW		



STATION	PSM		
PICTURE	CSM		Cool
	XD		✓ Normal
SOUND	ACM		Warm
	Contrast	100	User
TIME	Brightness	45	Red
	Colour	50	Green
SPECIAL	Sharpness	50	Blue
SCREEN			
PIP/DW	Menu	Prev.	

- For initialize values (reset to default settings), select the **Normal** option.
- When adjusting colour temperature options (**Red**, **Green**, or **Blue**) manually, **CSM** automatically changes to **User**.

- 1 Press the **MENU** button and then **▲ / ▼** button to select the **PICTURE** menu.
- 2 Press the **▶** button and then **▲ / ▼** button to select **CSM**.
- 3 Press the **▶** button and then **▲ / ▼** button to select **Cool**, **Normal**, **Warm**, or **User**.
 - **Cool** : To see less intense colors with more blue.
 - **Normal** : To initialize values (reset to default settings).
 - **Warm** : To enhance hotter colors such as red.
 - **User** : To adjust red, green, blue to any colour temperature you prefer.
 1. Press the **▲ / ▼** button to select **User**.
 2. Press the **▶** button and then **▲ / ▼** button to select **Red**, **Green**, or **Blue**.
 3. Press the **◀ / ▶** button to make appropriate adjustments.
- 4 Press the **EXIT** button to return to normal TV viewing.

Picture adjustment

XD Function

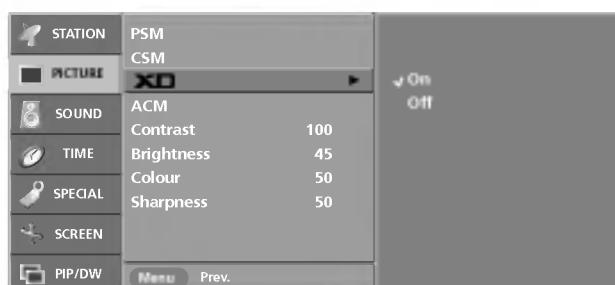

- **XD** is LG's unique picture improving technology to display a real HD source through an advanced digital signal processing algorithm.
- When selecting **PSM** options (**Dynamic**, **Standard**, or **Mild**), **XD** is automatically change to **On**. If **XD** setting is **Off**, **PSM** is automatically change to **User** and **ACM** function is not available.
- **XD** function is not available in RGB PC/HDMI PC mode.

- 1 Press the **MENU** button and then ▲ / ▼ button to select the **PICTURE** menu.
- 2 Press the ▶ button and then ▲ / ▼ button to select **XD**.
- 3 Press the ▶ button and then ▲ / ▼ button to select **On** or **Off**.
- 4 Press the **EXIT** button to return to normal TV viewing.

ACM (Active Colour Management)

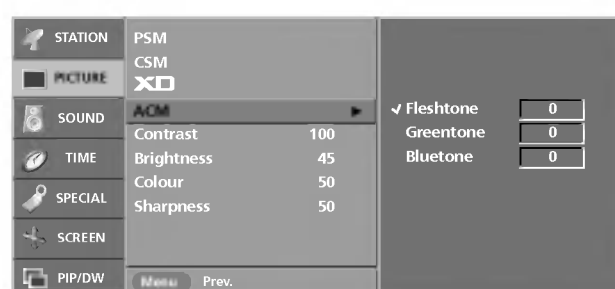

- Adjust the **ACM** to select the desired skin colour option.
- **ACM** function is available in all modes except RGB PC/HDMI PC mode.

- 1 Press the **MENU** button and then ▲ / ▼ button to select the **PICTURE** menu.
- 2 Press the ▶ button and then ▲ / ▼ button to select **ACM**.
- 3 Press the ▶ button and then ▲ / ▼ button to select **Fleshtone**, **Greentone**, or **Bluetone**.
- 4 Press the ◀ / ▶ button to make appropriate adjustments.
- 5 Press the **EXIT** button to return to normal TV viewing.

sRGB

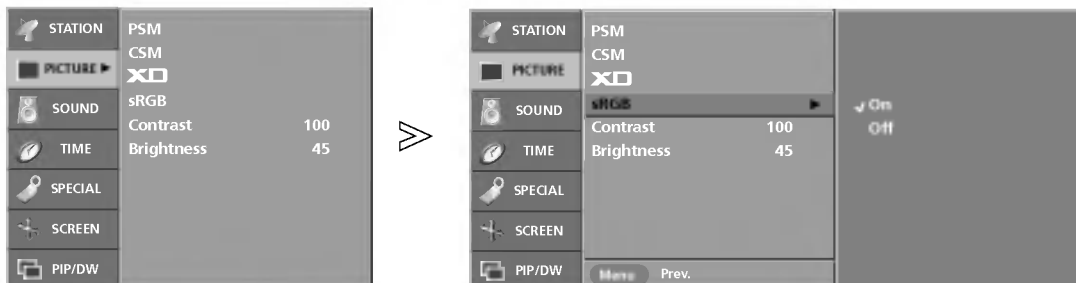

- When the set was connected to external equipment with sRGB function, it's adjusted a colour difference to display the equal image each other.

- **sRGB** function is available in RGB PC/HDMI PC mode.

- 1 Press the **MENU** button and then **▲ / ▼** button to select the **PICTURE** menu.
- 2 Press the **▶** button and then **▲ / ▼** button to select **sRGB**.
- 3 Press the **▶** button and then **▲ / ▼** button to select **On** or **Off**.
- 4 Press the **EXIT** button to return to normal TV viewing.

Manual Picture Adjustment

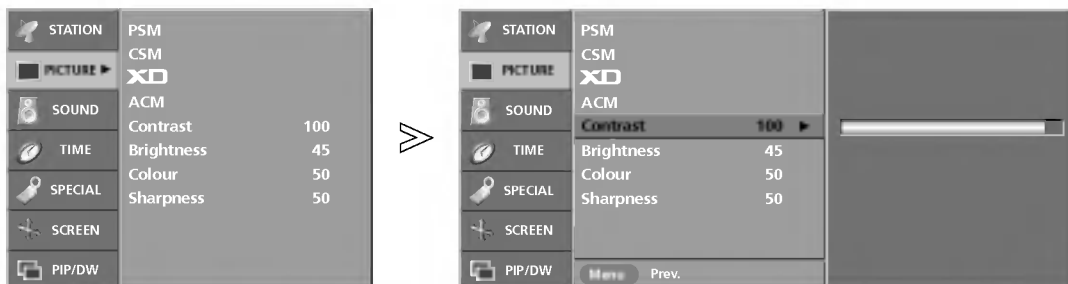

- You can adjust picture **Contrast, Brightness, Colour, Sharpness and Tint** (NTSC only) to the levels you prefer.

- 1 Press the **MENU** button and then **▲ / ▼** button to select the **PICTURE** menu.
- 2 Press the **▶** button and then **▲ / ▼** button to select the desired picture option (**Contrast, Brightness, Colour, or Sharpness**).
- 3 Press the **◀ / ▶** button to make appropriate adjustments.
- 4 Press the **EXIT** button to return to normal TV viewing.



Note

- Only **Contrast** and **Brightness** are displayed in PC mode.

Sound adjustment

SSM (Sound Status Memory)

- **SSM** lets you enjoy the best sound without any special adjustment because the TV sets the appropriate sound options based on the program content.
- When adjusting sound equalizer manually, **SSM** automatically switches **User**.
- **SRS TSXT, Flat, Music, Movie, and Sports** are preset for good sound quality at the factory and are not adjustable.
- If **SRS TSXT** is selected, **BBE, Treble, and Bass** functions are not available.
- You can also use the **SOUND** menu to adjust **SSM**.

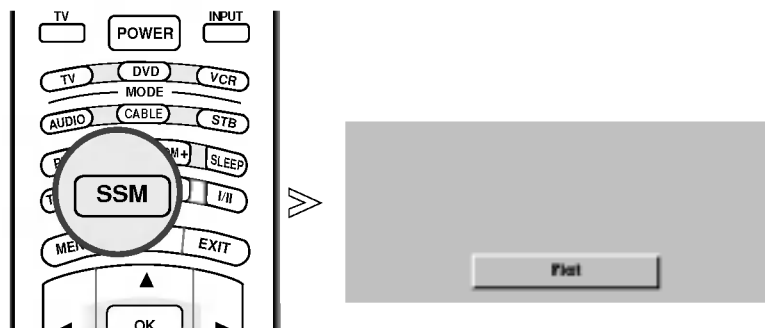

- 1 Press the **SSM** button repeatedly to select the picture appearance setup option as shown below: **SRS TSXT, Flat, Music, Movie, Sports, or User**.

- TruSurround XT technology is incorporated under license from SRS Labs, Inc.
- **SRS** is a trademark of SRS Labs, Inc.

BBE

STATION	SSM	
PICTURE	BBE	
SOUND ▶	Balance	0
	Treble	50
	Bass	50
TIME	TV speaker	
SPECIAL		
SCREEN		
PIP/DW		



STATION	SSM	
PICTURE	BBE ▶	On/Off
SOUND	Balance	0
	Treble	50
	Bass	50
TIME	TV speaker	
SPECIAL		
SCREEN		
PIP/DW	Menu Prev.	

- **BBE High Definition Sound** restores clarity and presence for better speech intelligibility and musical realism.

- 1 Press the **MENU** button and then **▲ / ▼** button to select the **SOUND** menu.
- 2 Press the **▶** button and then **▲ / ▼** button to select **BBE**.
- 3 Press the **▶** button and then **▲ / ▼** button to select **On** or **Off**.
- 4 Press the **EXIT** button to return to normal TV viewing.

- **BBE** is manufactured under license from BBE Sound, Inc.

AVL (Auto Volume leveler)

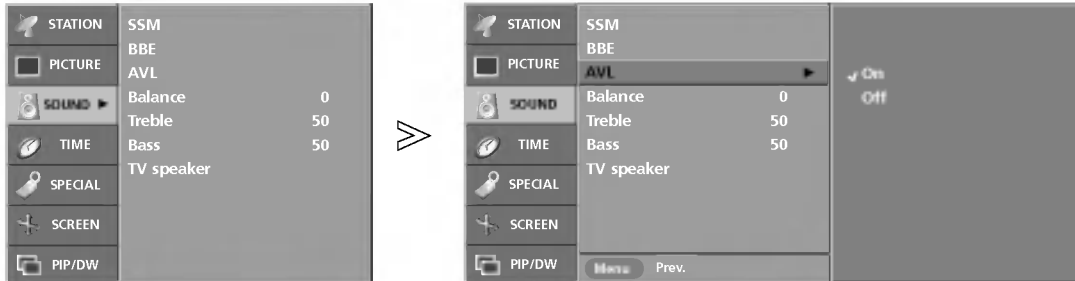

- **AVL** automatically keeps on an equal volume level even if you change programmes.

- 1 Press the **MENU** button and then **▲ / ▼** button to select the **SOUND** menu.
- 2 Press the **▶** button and then **▲ / ▼** button to select **AVL**.
- 3 Press the **▶** button and then **▲ / ▼** button to select **On** or **Off**.
- 4 Press the **EXIT** button to return to normal TV viewing.

Manual Sound Adjustment

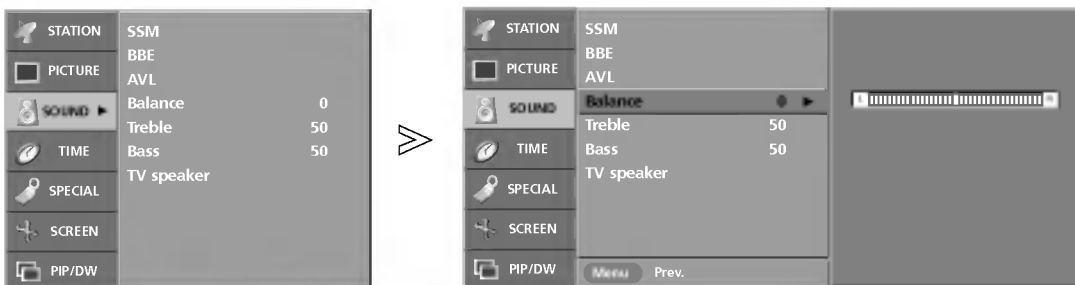

- Adjust the sound to suit your taste and room situations.

- 1 Press the **MENU** button and then **▲ / ▼** button to select the **SOUND** menu.
- 2 Press the **▶** button and then **▲ / ▼** button to select the desired sound option (**Balance, Treble, or Bass**).
- 3 Press the **▶** button and then **◀ / ▶** button to make desired adjustment.
- 4 Press the **EXIT** button to return to normal TV viewing.



Sound adjustment

TV Speaker

STATION	SSM
PICTURE	BBE AVL
SOUND ▶	Balance 0 Treble 50
TIME	Bass 50 TV speaker
SPECIAL	
SCREEN	
PIP/DW	



STATION	SSM	
PICTURE	BBE AVL	
SOUND	Balance 0 Treble 50	
TIME	Bass 50	
SPECIAL	TV Speaker ▶	✓ On Off
SCREEN		
PIP/DW	Menu Prev.	

- You can adjust internal speaker status.

- If you want to use your external hi-fi stereo system, turn off the internal speakers of the set.

- 1 Press the **MENU** button and then ▲ / ▼ button to select the **SOUND** menu.
- 2 Press the ▶ button and then ▲ / ▼ button to select **TV Speaker**.
- 3 Press the ▶ button and then ▲ / ▼ button to select **On** or **Off**.
- 4 Press the **EXIT** button to return to normal TV viewing.

I/II

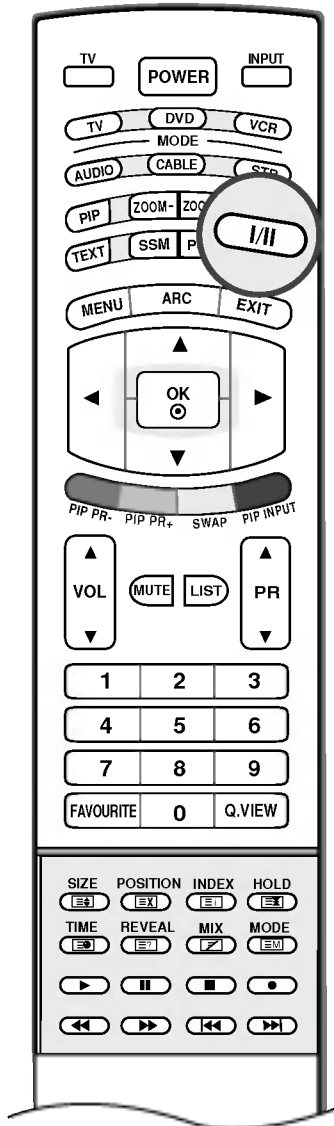

■ Stereo/Dual reception

When a programme is selected, the sound information for the station appears after the programme number and station name disappear.

Broadcast	On Screen Display
Mono	MONO
Stereo	STEREO
Dual	DUAL I

• Mono sound selection

In stereo reception if the stereo signal is weak, you can switch to mono by pressing the I/II button twice. In mono reception the depth of sound is improved. To switch back to stereo, press the I/II button twice again.

• Language selection for dual language broadcast

If a programme is received in two languages (dual language), you can switch to **DUAL I**, **DUAL II** or **DUAL I+II** by pressing the I/II button repeatedly. **DUAL I** sends the primary broadcast language to the loudspeakers. **DUAL II** sends the secondary broadcast language to the loud-speakers. **DUAL I+II** sends a separate language to each loudspeaker.

■ NICAM reception (This feature is not available in all countries.)

If your set is equipped with the receiver for NICAM reception, the high quality NICAM (Near Instantaneous Companding Audio Multiplex) digital sound can be received.

Sound output can be selected according to the type of received broadcast as follows by pressing the I/II button repeatedly.

1. When **NICAM mono** is received, you can select **NICAM MONO** or **FM MONO**.
2. When **NICAM stereo** is received, you can select **NICAM STEREO** or **FM MONO**. If the stereo signal is weak, switch to **FM mono**.
3. When **NICAM dual** is received, you can select **NICAM DUAL I**, **NICAM DUAL II** or **NICAM DUAL I+II** or **MONO**. When **FM mono** is selected the display **MONO** appears on the screen.

■ Sound output selection

In **AV1**, **AV2**, **AV3**, **S-Video**, **Component**, **RGB PC/RGB DTV**, or **HDMI PC/ HDMI DTV** mode, you can select output sound for the left and right loudspeakers. Repeatedly press the I/II button to select the sound output.

L+R : Audio signal from audio L input is sent to left loud-speaker and audio signal from audio R input is sent to right loud-speaker.

L+L : Audio signal from audio L input is sent to left and right loudspeakers.

R+R : Audio signal from audio R input is sent to left and right loudspeakers.

Time Menu

Clock Setup

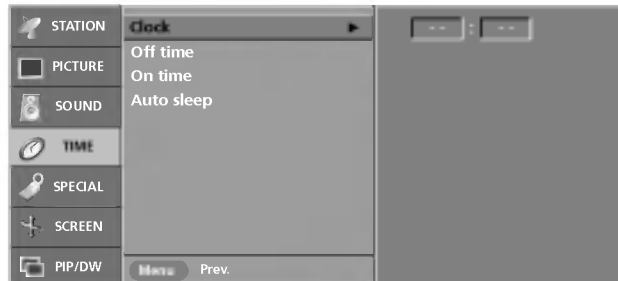
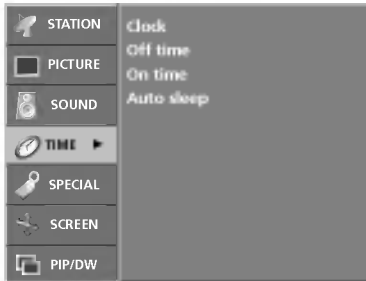

- You must set the time correctly before using on/off time function.

- If current time setting is erased by a power failure or the set is unplugged, reset the clock.

- 1 Press the **MENU** button and then **▲ / ▼** button to select the **TIME** menu.
- 2 Press the **▶** button and then **▲ / ▼** button to select **Clock**.
- 3 Press the **▶** button and then **▲ / ▼** button to set the hour.
- 4 Press the **▶** button and then **▲ / ▼** button to set the minutes.
- 5 Press the **EXIT** button to return to normal TV viewing.

On/Off time

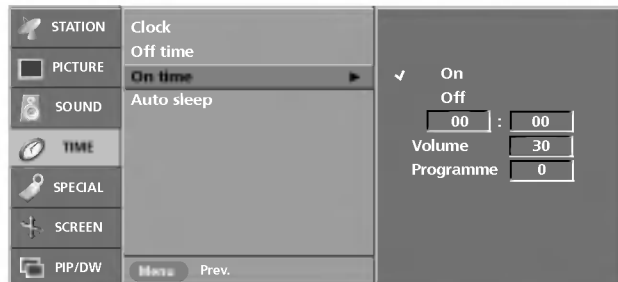
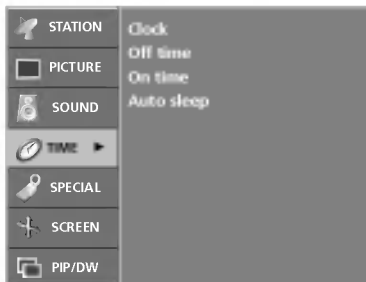

- The off time automatically switches the set to standby at the preset time.

- 1 Press the **MENU** button and then **▲ / ▼** button to select the **TIME** menu.
- 2 Press the **▶** button and then **▲ / ▼** button to select **Off time** or **On time**.
- 3 Press the **▶** button and then **▲ / ▼** button to select **On**.
 - To cancel **On/Off time** function, press the **▲ / ▼** button to select **Off**.
- 4 Press the **▶** button and then **▲ / ▼** button to set the hour.
- 5 Press the **▶** button and then **▲ / ▼** button to set the minutes.
- 6 **Only On time function**; Press the **▶** button and then **▲ / ▼** button to adjust volume level and programme number.
- 7 Press the **EXIT** button to return to normal TV viewing.



Note

- a. In the event of power interruption (disconnection or power failure), the clock must be reset.
- b. Two hours after the set is switched on by the on time function it will automatically switch back to standby mode unless a button has been pressed.
- c. Once the **On** or **Off Time** is set, these functions operate daily at the preset time.
- d. **Off Time** function overrides **On Time** function if they are set to the same time.
- e. The set must be in standby mode for the **On Time** to work.

Auto Sleep

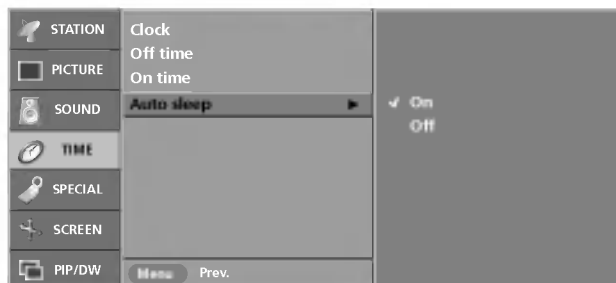
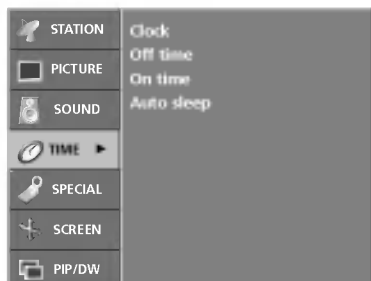

- If set to on and there is no input signal, the TV turns off automatically after 10 minutes.

- 1 Press the **MENU** button and then **▲ / ▼** button to select the **TIME** menu.
- 2 Press the **▶** button and then **▲ / ▼** button to select **Auto sleep**.
- 3 Press the **▶** button and then **▲ / ▼** button to select **On** or **Off**.
- 4 Press the **EXIT** button to return to normal TV viewing.

Sleep Timer

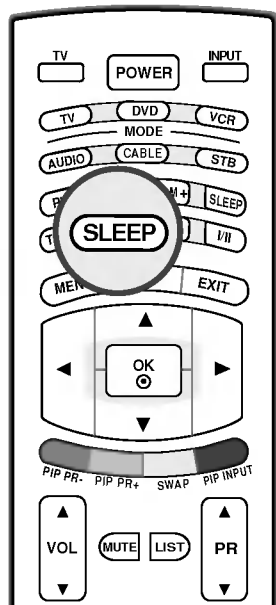

- 1 Press the **SLEEP** button repeatedly to select the number of minutes. First the ' --- ' option appears on the screen, followed by the following sleep timer options: 10, 20, 30, 60, 90, 120, 180, and 240 minutes.
- 2 The timer begins to count down from the number of minutes selected.
- 3 To view the remaining sleep time, press the **SLEEP** button once.
- 4 To cancel the sleep time, repeatedly press the **SLEEP** button until the display ' --- ' appears.



Note

- a. To view the remaining sleep time, press the **SLEEP** button once.
- b. When you switch the set off, the set releases the preset sleep time.

Special Menu

Child Lock

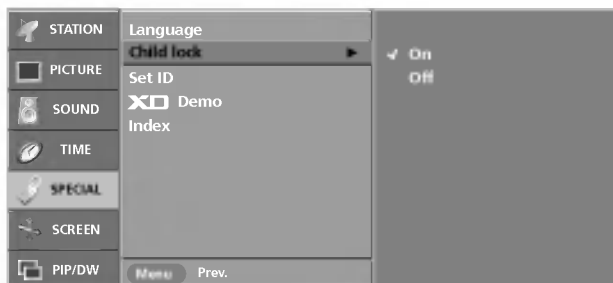

- The TV can be set so that the remote control handset is needed to control it. This feature can be used to prevent unauthorized viewing.

- 1 Press the **MENU** button and then **▲ / ▼** button to select the **SPECIAL** menu.
- 2 Press the **▶** button and then **▲ / ▼** button to select **Child lock**.
- 3 Press the **▶** button and then **▲ / ▼** button to select **On** or **Off**.
- 4 Press the **EXIT** button to return to normal TV viewing.



Note

- a. This set programmed to remember which option it was last set to even if you turn the set off.
- b. In **Child lock 'On'**, if the set is turned off, press the **POWER, INPUT, PR ▲ / ▼** button on the set or **POWER, TV, INPUT, PR ▲ / ▼** or **NUMBER** buttons on the remote control.
- c. With the **Child lock On**, the display **'Child lock on'** appears on the screen if any button on the front panel is pressed while viewing the set.

XD Demo



- Use it to see the difference between XD demo on and XD Demo off.

- **XD Demo** function is not available in RGB PC/HDMI PC mode.

- 1 Press the **MENU** button and then **▲ / ▼** button to select the **SPECIAL** menu.
- 2 Press the **▶** button and then **▲ / ▼** button to select **XD Demo**.
- 3 Press the **▶** button to start **XD Demo**.
- 4 To stop **XD Demo**, press the **EXIT** button.

Lightening Index

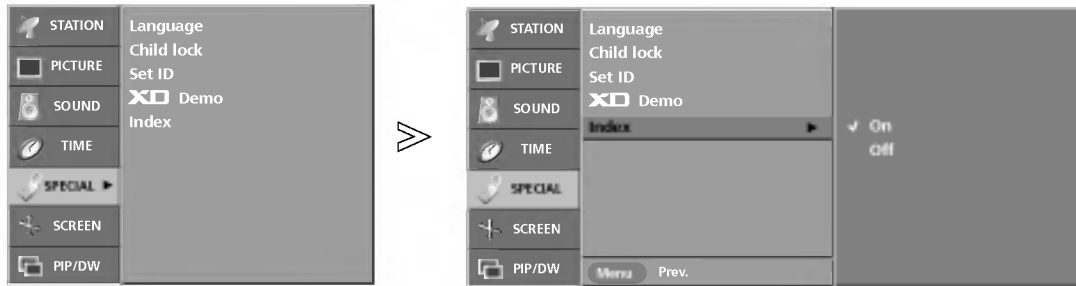

- If you select on, Index logo of TV front panel turns the lamp on.

- 1 Press the **MENU** button and then **▲ / ▼** button to select the **SPECIAL** menu.
- 2 Press the **▶** button and then **▲ / ▼** button to select **Index**.
- 3 Press the **▶** button and then **▲ / ▼** button to select **On** or **Off**.
- 4 Press the **EXIT** button to return to normal TV viewing.

Screen Menu

Auto Configure

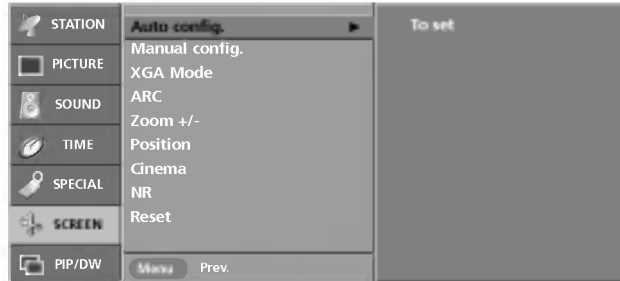

- **Auto config.** function is available in RGB PC mode only.
- Automatically adjusts picture position and minimizes image shaking.
- After adjustment, if the image is still not correct, your TV is functioning properly but needs further adjustment.
- Automatically adjusts the screen position, clock, and phase. (The displayed image will disappear for a few seconds while Auto-configuration is in progress.)

- 1 Press the **MENU** button and then use **▲ / ▼** button to select the **SCREEN** menu.
- 2 Press the **▶** button and then use **▲ / ▼** button to select **Auto config.**.
- 3 Press the **▶** button to start **Auto configure**.
 - If the position of the image is still not correct, try Auto adjustment again.

Manual Configure

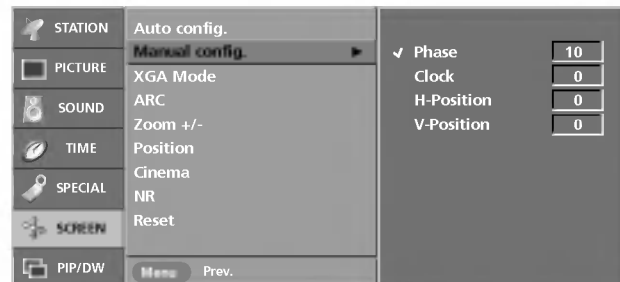

- **Manual config.** function is available in RGB PC or Component (480p, 576p, 720p, 1080i) mode.
- If the picture isn't clear after auto adjustment and especially that characters are still trembling, adjust the picture phase manually.
- To correct the screen size, adjust **Clock**.
- In **Component [480i, 576i] mode, H-position/V-Position function is not available.**

- 1 Press the **MENU** button and then use **▲ / ▼** button to select the **SCREEN** menu.
- 2 Press the **▶** button and then use **▲ / ▼** button to select **Manual config.**.
- 3 Press the **▶** button and then use **▲ / ▼** button to select **Phase, Clock, H-Position, or V-Position**.
 - **Phase** : This function allows you to remove any horizontal noise and clear or sharpen the image of characters.
 - **Clock** : This function is to minimize any vertical bars or stripes visible on the screen background. And the horizontal screen size will also change.
 - **H-Position / V-Position** : This function is to adjust picture to left/right and up/down as you prefer.
- 4 Press the **◀ / ▶** button to make appropriate adjustments.
- 5 Press the **EXIT** button to return to normal TV viewing.

XGA Mode

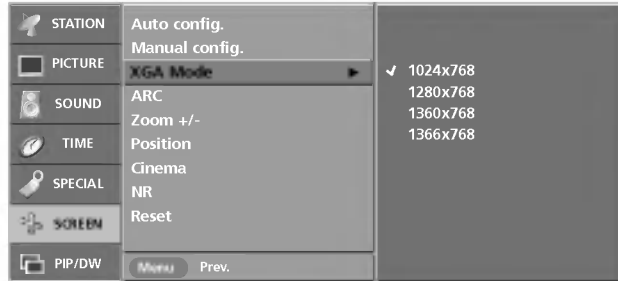

- **XGA Mode** function is available in RGB PC mode and XGA/WXGA mode (60Hz) only.
- For more improved or better picture quality, select the same mode corresponding to computer resolution.

- 1 Press the **MENU** button and then use ▲ / ▼ button to select the **SCREEN** menu.
- 2 Press the ► button and then use ▲ / ▼ button to select **XGA Mode**.
- 3 Press the ► button and then use ▲ / ▼ button to select desired mode. From this point on, the adjustment starts.

Picture Size Zoom

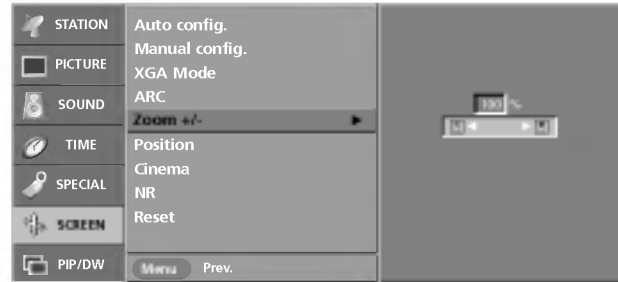

- When enlarging or reducing the picture, the screen may be display unnatural picture.
- You can also enlarge or reduce the picture size with **ZOOM - / ZOOM +** on the remote control and then adjust the main picture position with the ▲ / ▼ / ◀ / ▶ buttons in enlarged picture mode.
- **Zoom +/-** function is not available in RGB PC mode.

- 1 Press the **MENU** button and then use ▲ / ▼ button to select the **SCREEN** menu.
- 2 Press the ► button and then use ▲ / ▼ button to select **Zoom +/-**.
- 3 Press the ► button and then ◀ / ▶ button to enlarge or reduce the picture size.
 - The adjustment range of zoom is 100~300 %.
- 4 Press the **EXIT** button to return to normal TV viewing.

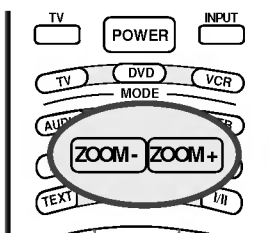

Screen Menu

Picture format (ARC)

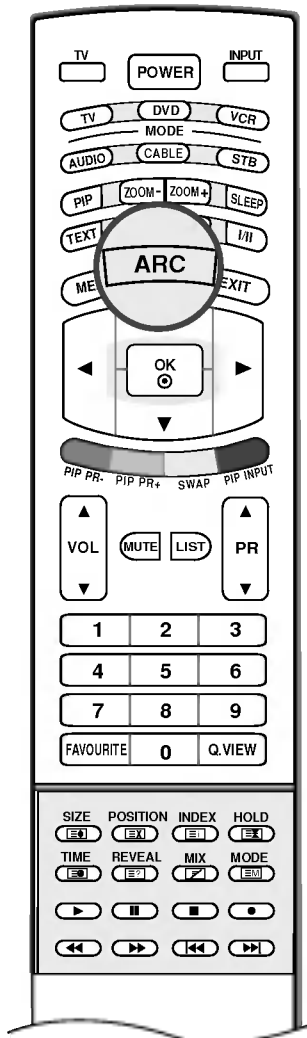

- You can watch TV in various picture formats; **Spectacle, Full, Original, 4:3, 16:9, 14:9, Zoom**. Repeatedly press the **ARC** button to select your desired picture format.
- You can also use the **SCREEN** menu to adjust **ARC**.

Spectacle

When your TV receives the wide screen signal, it will lead you to adjust the picture horizontally, in a nonlinear proportion, to fill the entire screen.

Full

When your TV receives the wide screen signal, it will lead you to adjust the picture horizontally or vertically, in a linear proportion, to fill the entire screen fully.

Original

When your TV receives the wide screen signal, it will be automatically changed to the picture format to be sent.

4:3

This picture format is 4 to 3 of general TV.

16:9

You can enjoy the cinema (the picture format of 16:9) or general TV programme through the 16:9 mode.

The screen 16:9 is viewed just like that but the screen 4:3 is magnified to the left and right so that the screen 16:9 is full.

14:9

You can enjoy the picture format of 14:9 or general TV programme through the 14:9 mode.

The screen 14:9 is viewed just like that the screen 4:3 is magnified to the upper / lower and left / right.

Zoom

You can enjoy the cinema in a vast screen through the Zoom mode.

The screen 4:3 is magnified to the upper / lower and left / right sides so that the screen 16:9 is full. The bottom and top of the picture may be lost.



Note

- In **PC (RGB or HDMI)** mode only **16:9** and **4:3** aspect ratios are available.
- In the **DW (Double Window)** mode, **ARC** function isn't available.
- In **Component** mode only **4:3, 16:9** and **Zoom** aspect ratios are available.
- There might be uncomfortable in full mode. Then change into other mode.

Screen Position

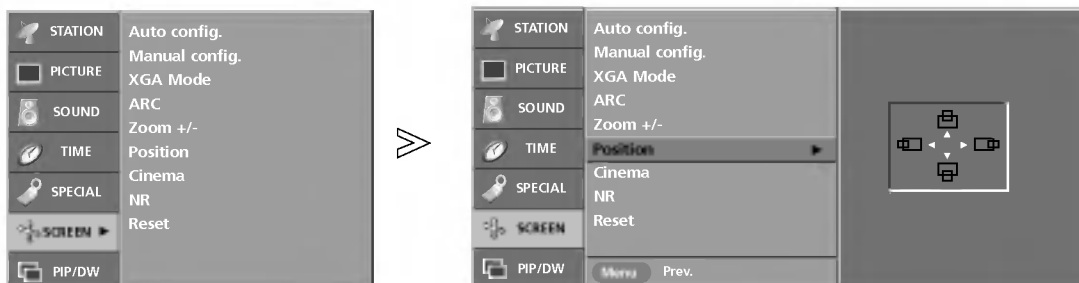

- When screen is enlarged, you can change the position of the picture.
- **Position** function is not available in RGB PC mode.

- 1 Press the **MENU** button and then use ▲ / ▼ button to select the **SCREEN** menu.
- 2 Press the ► button and then use ▲ / ▼ button to select **Position**.
- 3 Press the ► button and then ▲ / ▼ / ◀ / ▶ button to adjust the position.
- 4 Press the **EXIT** button to return to normal TV viewing.

Cinema

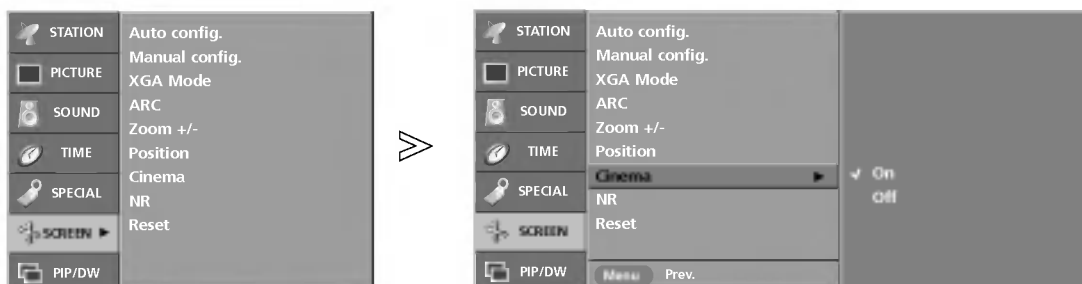

- When you watch the movie, this function adjusts the set to the best picture appearance.
- **Cinema** function is available in **TV, AV, S-Video, or Component (480i, 576i) mode**

- 1 Press the **MENU** button and then use ▲ / ▼ button to select the **SCREEN** menu.
- 2 Press the ► button and then use ▲ / ▼ button to select **Cinema**.
- 3 Press the ► button and then ▲ / ▼ button to select **On** or **Off**.
- 4 Press the **EXIT** button to return to normal TV viewing.

Screen Menu

NR (Noise Reduction)

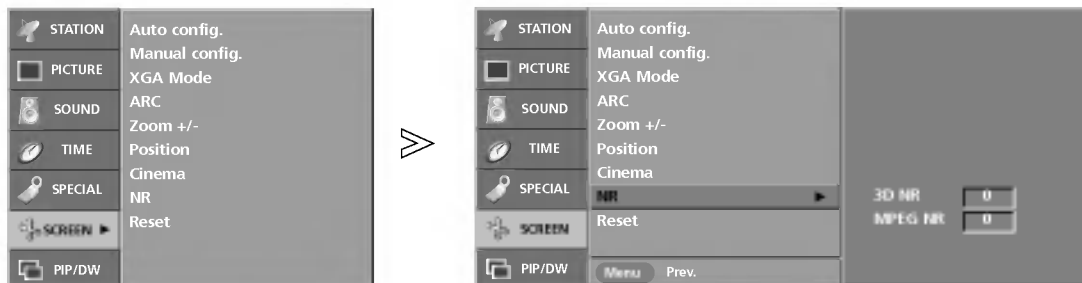

- You can select **3D NR** or **MPEG NR** to reduce the picture noise which may appear on the screen during watching the TV.
- This function is not available for use in **RGB PC**, **HDMI PC** mode.
- **3D NR** is not available for use in **Component**, **RGB DTV**, **HDMI DTV** mode.

- 1 Press the **MENU** button and then use **▲ / ▼** button to select the **SCREEN** menu.
- 2 Press the **▶** button and then use **▲ / ▼** button to select **NR**.
- 3 Press the **▶** button and then use **▲ / ▼** button to select **3D NR** or **MPEG NR**.
- 4 Press the **◀ / ▶** button to make appropriate adjustments.
 - The adjustment range of **3D NR** is 0~2.
 - The adjustment range of **MPEG NR** is 0~15.
- 5 Press the **EXIT** button to return to normal TV viewing.

Reset to original factory value (Initializing)

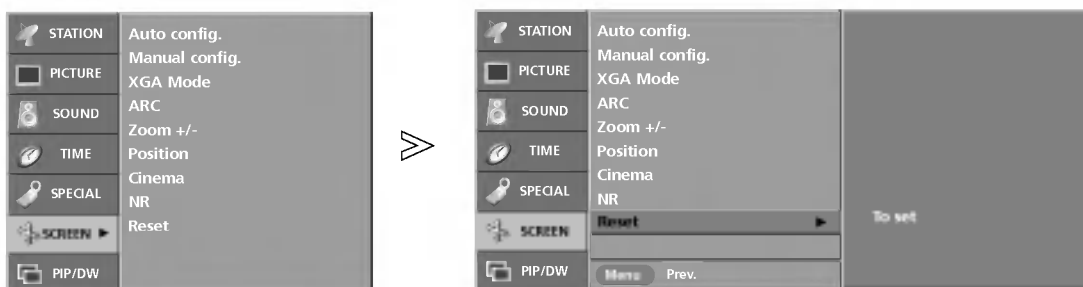

- You can initialize **Zoom +/-**, **Position**, **Manual Config.**, **PIP size**, **PIP position** and **sub picture size for twin picture**.
- This function operates in every mode. To initialize the adjusted value.

- 1 Press the **MENU** button and then use **▲ / ▼** button to select the **SCREEN** menu.
- 2 Press the **▶** button and then use **▲ / ▼** button to select **Reset**.
- 3 Press the **▶** button to start **Reset**.
The display **OK** will appear.

PIP (Picture-In-Picture) / DW (Double Window) Menu

Main Picture Input

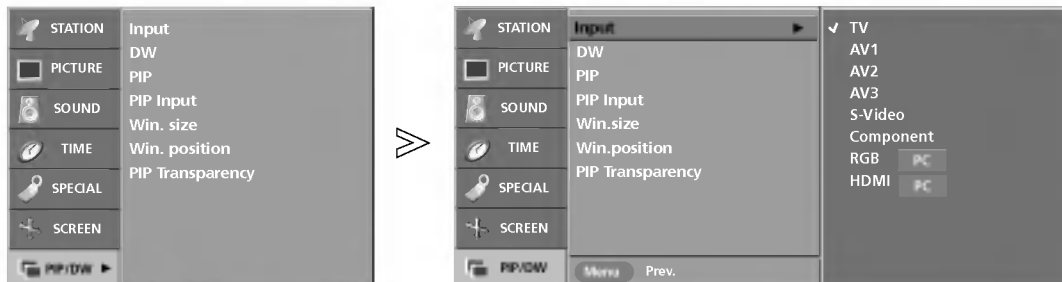

- You can also select the desired input with the **INPUT** button on the remote control.

- 1 Press the **MENU** button and then use **▲ / ▼** button to select the **PIP/DW** menu.
- 2 Press the **▶** button and then use **▲ / ▼** button to select **Input**.
- 3 Press the **▶** button and then **▲ / ▼** button to select **TV, AV1, AV2, AV3, S-Video, Component, RGB PC/RGB DTV, or HDMI PC/HDMI DTV**.
- 4 Press the **EXIT** button to return to normal TV viewing.

Watching DW/PIP

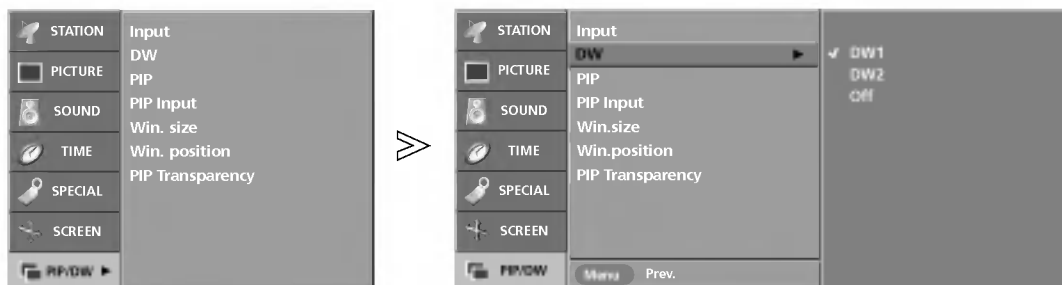

- PIP lets you view 2 different inputs (sources) on your TV screen at the same time. One source will be large, and the other source will show a smaller inset image.

- DW (Double Window) mode splits the screen into 2, allowing 2 picture sources to be shown on the TV screen at the same time. Each source is given half the screen.

- You can also select the **DW/PIP** with the **PIP** button on the remote control.

- 1 Press the **MENU** button and then use **▲ / ▼** button to select the **PIP/DW** menu.
- 2 Press the **▶** button and then use **▲ / ▼** button to select **DW** or **PIP**.
- 3 Press the **▶** button and then **▲ / ▼** button to select the item.
- 4 Press the **EXIT** button to return to normal TV viewing.

PIP (Picture-In-Picture) / DW (Double Window) Menu

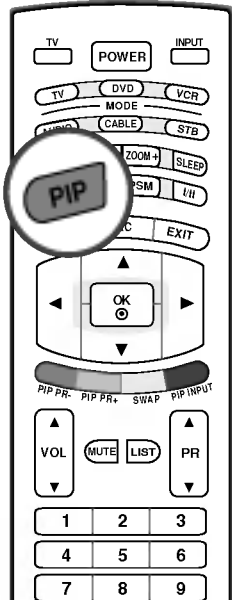

■ Press the **PIP** button to access the sub picture. Each press of PIP changes the PIP options as shown below.
You can hear the main picture sound in PIP mode. Exchange the main and sub picture to hear the sub picture sound.

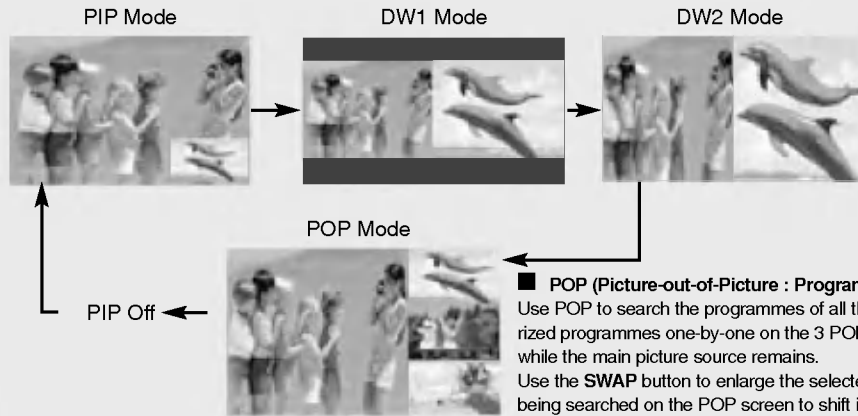

■ **POP (Picture-out-of-Picture : Programme scan)**
Use POP to search the programmes of all the memorized programmes one-by-one on the 3 POP screen, while the main picture source remains.
Use the **SWAP** button to enlarge the selected channel being searched on the POP screen to shift it for viewing on the Main picture.
Note : Run **Auto programme** function before using POP mode.

PIP Input

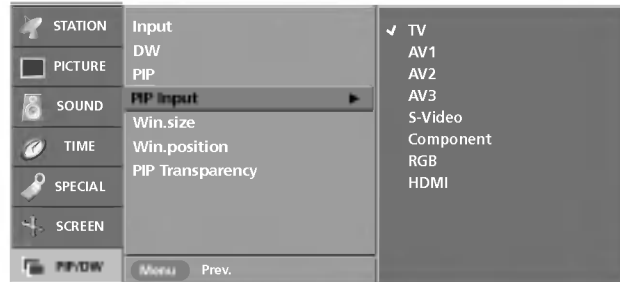
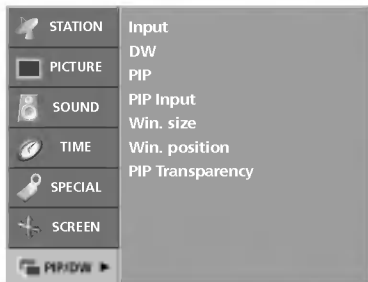

- You can also select the desired input for the sub picture with the **PIP INPUT** button on the remote control.

- 1 Press the **MENU** button and then use **▲ / ▼** button to select the **PIP/DW** menu.
- 2 Press the **▶** button and then use **▲ / ▼** button to select **PIP Input**.
- 3 Press the **▶** button and then **▲ / ▼** button to select **TV, AV1, AV2, AV3, S-Video, Component, RGB, or HDMI**.
- 4 Press the **EXIT** button to return to normal TV viewing.

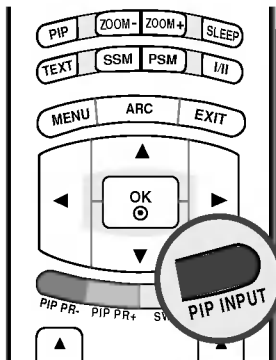

■ Press the **PIP INPUT** button to select the input source for the sub picture.

Main picture	Sub picture	
	PIP/DW	POP
TV	All	TV
AV1	All (Except AV1)	
AV2	All (Except AV2)	
AV3	All (Except AV3)	
S-Video	All (Except S-Video)	
Component	All (Except Component)	
RGB PC / RGB DTV	All (Except RGB, HDMI)	
HDMI PC / HDMI DTV	All (Except RGB, HDMI)	

X : not available

Win. Size/Position

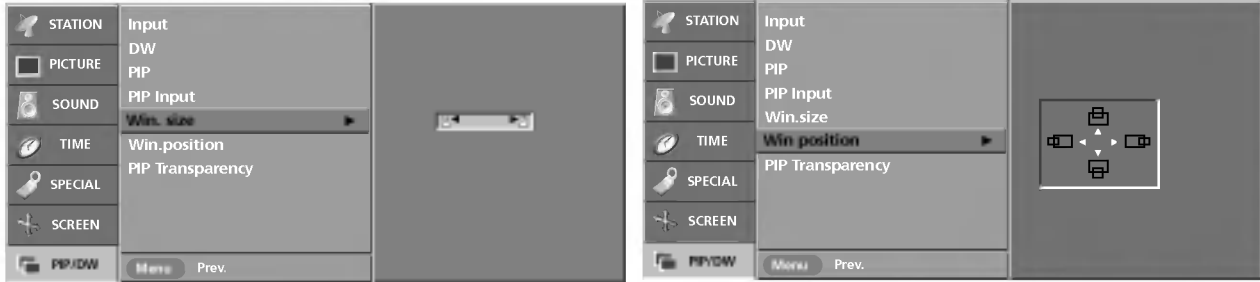

- You can also adjust the **Win. size/Win. position** with the **SIZE/POSITION** button on the remote control.

- 1 Press the **MENU** button and then use **▲ / ▼** button to select the **PIP/DW** menu.
- 2 Press the **▶** button and then use **▲ / ▼** button to select **Win. size** or **Win. position**.
 - **Win. size** : Press the **◀ / ▶** button to adjust the sub picture size.
 - **Win. position** : Press the **▲ / ▼ / ◀ / ▶** button until desired position is achieved.
- 3 Press the **EXIT** button to return to normal TV viewing.

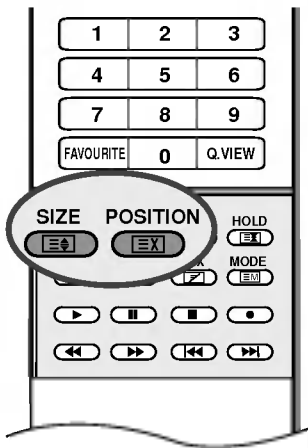

■ Sub Picture Size Adjustment



Press the **SIZE** button and then **◀ / ▶** button to adjust the sub picture size.
Using the **SIZE** button in DW1, DW2 modes, main and sub picture are adjusted simultaneously. Using the **SIZE** button in PIP mode, sub picture is adjusted.

■ Moving the Sub Picture (PIP mode only)



Press the **POSITION** button.
Repeatedly press the **▲ / ▼ / ◀ / ▶** button until desired position is achieved. The sub picture moves up/down or left/right.

PIP (Picture-In-Picture) / DW (Double Window) Menu

PIP Transparency

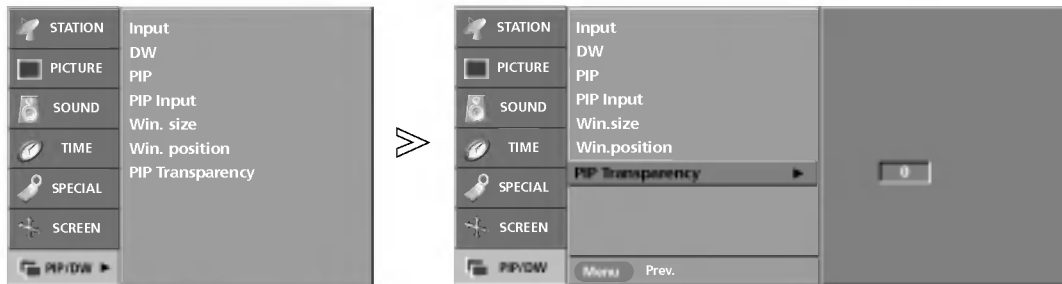

- This function is to make the PIP clear or opaque.

- 1 Press the **MENU** button and then use ▲ / ▼ button to select the **PIP/DW** menu.
- 2 Press the ► button and then use ▲ / ▼ button to select **PIP Transparency**.
- 3 Press the ► button and then use ◀ / ▶ button to make appropriate adjustments.
 - The adjustment range of is 0~10.
- 4 Press the **EXIT** button to return to normal TV viewing.

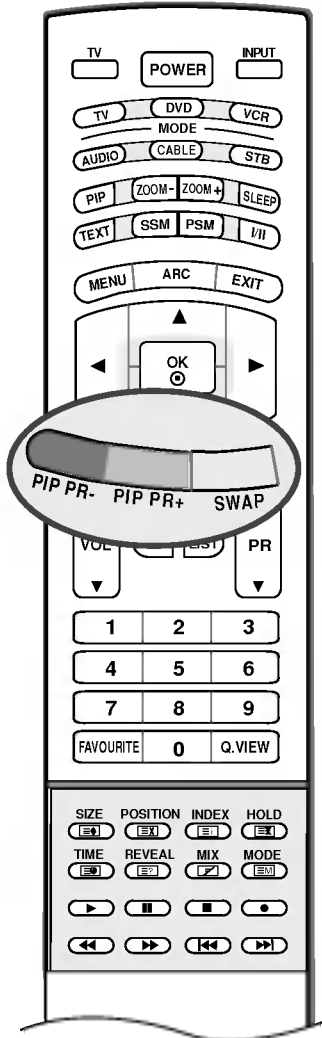

■ Programme Selection for Sub Picture

Press the **PIP PR +/-** button to select a programme for the sub picture.
The selected programme number is displayed just below the programme number of main picture.

■ Swapping between main and sub pictures

Press the **SWAP** button to exchange the main and sub pictures.

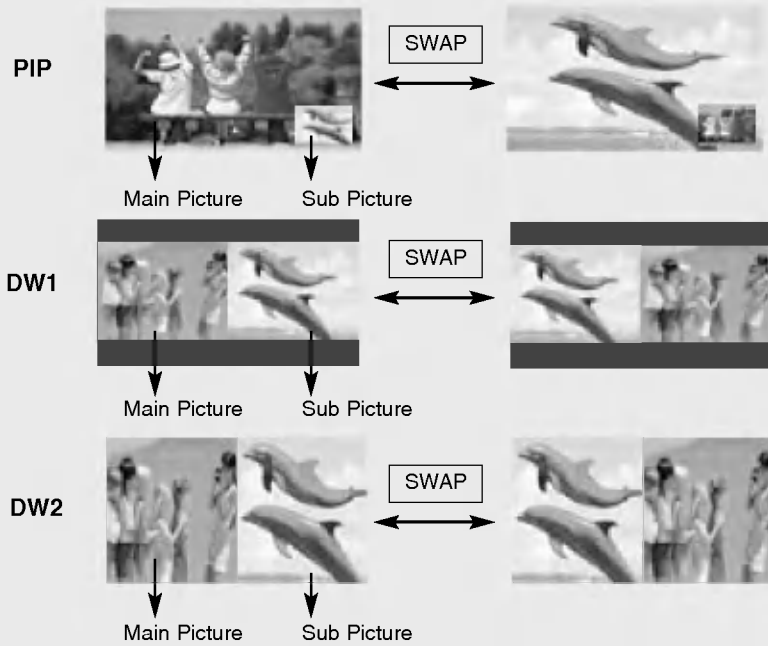

Note

- a. In some case of PIP/DW mode, picture quality can be different between main picture and sub picture. the sub picture may appear poor as compared to main picture.

Teletext

Teletext (or TOP text) is an optional function, therefore only a set with the teletext system can receive the teletext broadcast.

Teletext is a free service broadcast by most TV stations which gives up-to-the-minute information on news, weather, television programmes, share prices and many other topics.

The teletext decoder of this TV can support the SIMPLE, TOP and FASTEXT systems. SIMPLE (standard teletext) consists of a number of pages which are selected by directly entering the corresponding page number. TOP and FASTEXT are more modern methods allowing quick and easy selection of teletext information.

Switch on/off

Press the **TEXT** button to switch to teletext. The initial page or last page appears on the screen.

Two page numbers, TV station name, date and time are displayed on the screen headline. The first page number indicates your selection, while the second shows the current page displayed.

Press the **TEXT** button to switch off teletext. The previous mode reappears.

SIMPLE text

■ Page selection

1. Enter the desired page number as a three digit number with the **NUMBER** buttons. If during selection you press a wrong number, you must complete the three digit number and then reenter the correct page number.
2. The **PR ▲ / ▼** buttons can be used to select the preceding or following page.

■ Programming a colour button in LIST mode

If the TV is in SIMPLE text, TOP text or FASTEXT mode, press the **EM** button to switch to LIST mode.

Four teletext page numbers of your choice can be colour coded and easily selected by pressing the corresponding coloured button on the remote control handset.

1. Press a coloured button.
2. Using the **NUMBER** buttons, select the page you wish to programme.
3. Press the **OK** button. Then the selected page is stored as the selected page number by blinking once. From now on, you can select this page with the same coloured button.
4. The three other coloured buttons are programmed in this way.

TOP text (This feature is not available in all countries)

The user guide displays four fields-red, green, yellow and blue at the bottom of the screen. The yellow field denotes the next group and the blue field indicates the next block.

■ Block / group / page selection

1. With the blue button you can progress from block to block.
2. Use the yellow button to proceed to the next group with automatic overflow to the next block.
3. With the green button you can proceed to the next existing page with automatic overflow to the next group. Alternatively the **PR ▲** button can be used.
4. The red button permits to return to previous selection.
Alternatively the **PR ▼** button can be used.

■ Direct page selection

Corresponding to the SIMPLE teletext mode, you can select a page by entering it as a three digit number using the **NUMBER** buttons in TOP mode.

FASTEXT

The teletext pages are colour coded along the bottom of the screen and are selected by pressing the corresponding coloured button.

■ Page selection

1. Press the  button to select the index page.
2. You can select the pages which are colour coded along the bottom line with the same coloured buttons.
3. Corresponding to the SIMPLE teletext mode, you can select a page by entering its three digit page number with the NUMBER buttons in FASTEXT mode.
4. The PR ▲/▼ buttons can be used to select the preceding or following.

Special teletext functions



REVEAL

Press this button to display concealed information, such as solutions of riddles or puzzles.
Press this button again to remove the information from the display.

SIZE

Selects double height text.
Press this button to enlarge the top half of the page.
Press this button again to enlarge the bottom half of the page.
Press this button again to return to the normal display.

UPDATE

Displays the TV picture on the screen while waiting for the new teletext page. The display  will appear at the top left hand corner of the screen. When the updated page is available then display  will change to the page number.
Press this button to view the updated teletext page.

HOLD

Stops the automatic page change which will occur if a teletext page consists of 2 or more sub pages. The number of sub pages and the sub page displayed is, usually, shown on the screen below the time. When this button is pressed the stop symbol is displayed at the top left-hand corner of the screen and the automatic page change is inhibited.
To continue press this button again.

MIX

Displays the teletext pages superimposed on the TV picture.
To switch the TV picture off press this button again.

TIME

When viewing a TV programme, press this button to display the time at the top right hand corner of the screen. Press this button again to remove the display. In the teletext mode, press this button to select a sub page number. The sub page number is displayed at the bottom of the screen. To hold or change the sub page, press the RED/GREEN, ◀/▶ or NUMBER buttons.
Press again to exit this function.

Reference

Troubleshooting Checklist

The operation does not work normally.	
The remote control doesn't work	<ul style="list-style-type: none"> • Check to see if there is any object between the product and the remote control causing obstruction. • Are batteries installed with correct polarity (+ to +, - to -)? • Correct remote operating mode set: TV, VCR etc.? • Install new batteries.
Power is suddenly turned off	<ul style="list-style-type: none"> • Is the sleep timer set? • Check the power control settings. Power interrupted • No broadcast on station tuned with Auto off activated.

The video function does not work.	
No picture & No sound	<ul style="list-style-type: none"> • Check whether the product is turned on. • Try another channel. The problem may be with the broadcast. • Is the power cord inserted into wall power outlet? • Check your antenna direction and/or location. • Test the wall power outlet, plug another product's power cord into the outlet where the product's power cord was plugged in.
Picture appears slowly after switching on	<ul style="list-style-type: none"> • This is normal, the image is muted during the product startup process. Please contact your service center, if the picture has not appeared after five minutes.
No or poor color or poor picture	<ul style="list-style-type: none"> • Adjust Color in menu option. • Keep a sufficient distance between the product and the VCR. • Try another channel. The problem may be with the broadcast. • Are the video cables installed properly? • Activate any function to restore the brightness of the picture.
Horizontal/vertical bars or picture shaking	<ul style="list-style-type: none"> • Check for local interference such as an electrical appliance or power tool.
Poor reception on some channels	<ul style="list-style-type: none"> • Station or cable product experiencing problems, tune to another station. • Station signal is weak, reorient antenna to receive weaker station. • Check for sources of possible interference.
Lines or streaks in pictures	<ul style="list-style-type: none"> • Check antenna (Change the direction of the antenna).

The audio function does not work.	
Picture OK & No sound	<ul style="list-style-type: none"> • Press the VOL or VOLUME button. • Sound muted? Press MUTE button. • Try another channel. The problem may be with the broadcast. • Are the audio cables installed properly? • Check whether the TV Speaker is On in the SOUND menu.
No output from one of the speakers	<ul style="list-style-type: none"> • Adjust Balance in menu option.
Unusual sound from inside the product	<ul style="list-style-type: none"> • A change in ambient humidity or temperature may result in an unusual noise when the product is turned on or off and does not indicate a fault with the product.

There is a problem in PC mode. (Only PC mode applied)	
The signal is out of range.	<ul style="list-style-type: none"> • Adjust resolution, horizontal frequency, or vertical frequency. • Check it whether the signal cable is connected or loose. • Check the input source.
Vertical bar or stripe on background & Horizontal Noise & Incorrect position	<ul style="list-style-type: none"> • Work the Auto configure or adjust clock, phase, or H/V position.
Screen color is unstable or single color	<ul style="list-style-type: none"> • Check the signal cable. • Reinstall the PC video card.

Product Specifications

Power Requirement/ Power Consumption	32LB1R** : AC 100-240V~ 50/60Hz 1.5A / 145W 37LB1R** : AC 100-240V~ 50/60Hz 2.0A / 180W 42LB1R** : AC 100-240V~ 50/60Hz 2.5A / 240W
Dimensions (Width x Depth x Height)	32LB1R** : 911.4mm x 259.0mm x 596.0mm 35.9inches x 10.2inches x 23.5inches 37LB1R** : 1046.0mm x 296.0mm x 690.0mm 41.2inches x 11.7inches x 27.2inches 42LB1R** : 1175.0mm x 300.0mm x 768.0mm 46.3inches x 11.8inches x 30.2inches
Weight (Net)	32LB1R** : 22.6kg (49.8lbs) 37LB1R** : 31.6kg (69.7lbs) 42LB1R** : 41.4kg (91.3lbs)
Television System Programme Coverage External Antenna Impedance	PAL/SECAM B/G/D/K, PAL I/II, SECAM L/L' VHF: E2 ~ E12, UHF: E21 ~ E69, CATV: S1 ~ S20, HYPER: S21 ~ S47 75 Ω

- The specifications shown above may be changed without prior notice for quality improvement.

Reference

Programming the Remote control

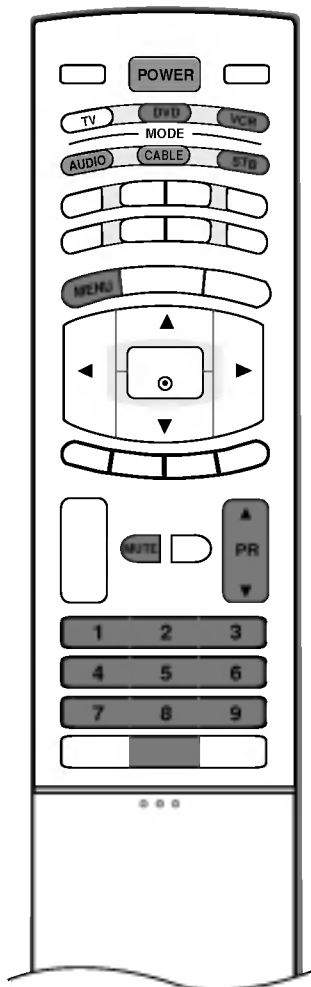

The remote control is a multi-brand or universal remote control. It can be programmed to operate most remote-controllable devices of other manufacturers. Note that the remote control may not control all models of other brands.

Programming a code into a remote mode

1. Test your remote control.
To find out whether your remote control can operate the component without programming, turn on the component such as a VCR and press the corresponding mode button (such as a **DVD** or **VCR**) on the remote control, while pointing at the component. Test the **POWER** and **PR ▲ / ▼** buttons to see if the component responds properly. If not, the remote requires programming to operate the device.
2. Turn on the component to be programmed, then press the corresponding mode button (such as a **DVD** or **VCR**) on the remote control. The remote control button of desired device is lighted.
3. Press the **MENU** and **MUTE** buttons simultaneously, the remote control is ready to be programmed for the code.
4. Enter a code number using the number buttons on the remote control. Programming code numbers for the corresponding component can be found on the following pages. Again, if the code is correct, the device will turn off.
5. Press the **MENU** button to store the code.
6. Test the remote control functions to see if the component responds properly. If not, repeat from step 2.

Programming Codes

■ VCRs

Brand	Codes	Brand	Codes	Brand	Codes	Brand	Codes
AIWA	034	KENWOOD	014 034 039 043	PORTLAND	108	TATUNG	039 043
AKAI	016 043 046 124 125 146	LG (GOLDSTAR)	001 012 013 020 101 106 114 123	PULSAR	072	TEAC	034 039 043
AMPRO	072	LLOYD	034	QUARTZ	011 014	TECHNICS	031 033 070
ANAM	031 033 103	LXI	003 009 013 014	QUASAR	033 066 075 145	TEKNIKA	019 031 033 034
AUDIO DYNAMICS	012 023 039 043	MAGIN	040	RCA	013 020 033 034 040 041 062 063 107 109 140 144 145 147	THOMAS	034
BROKSONIC	035 037 129	MAGNAVOX	031 033 034 041 067 068	REALISTIC	003 008 010 014 031 033 034 040 053 054 101	TMK	006
CANON	028 031 033	MARANTZ	012 031 033 067 069	RICO	058	TOSHIBA	008 013 042 047
CAPEHART	108	MARTA	101	RUNCO	148	TOTEVISION	040 101
CRAIG	003 040 135	MATSUI	027 030	SALORA	014	UNITECH	040
CURTIS MATHES	031 033 041	MEI	031 033	SAMSUNG	032 040 102 104 105 107 109 112 113 115 120 122 125	VECTOR RESEARCH	012
DAEWOO	005 007 010 064 065 108 110 111 112 116 117 119	MEMOREX	003 010 014 031 033 034 053 072 101 102 134 139	SANSUI	022 043 048 135	VICTOR	048
DAYTRON	108	MGA	045 046 059	SANYO	003 007 010 014 102 134	VIDEO CONCEPTS	012 034 046
DBX	012 023 039 043	MINOLTA	013 020	SCOTT	017 037 112 129 131	VIDEOSONIC	040
DYNATECH	034 053	MITSUBISHI	013 020 045 046 049 051 059 061 151	SEARS	003 008 009 010 013 014 017 020 031 042 073 081 101	WARDS	003 013 017 024 031 033 034 040 053 054 131
ELECTROHOME	059	MTC	034 040	SHARP	031 054 149	YAMAHA	012 034 039 043
EMERSON	006 017 025 027 029 031 034 035 036 037 046 101 129 131 138 153	MULTITECH	024 034	SHINTOM	024	ZENITH	034 048 056 058 072 080 101
FISHER	003 008 009 010	NEC	012 023 039 043 048	SONY	003 009 031 052 056 057 058 076 077 078 149		
FUNAI	034	NORDMENDE	043	SOUNDESIGN	034		
GE	031 033 063 072 107 109 144 147	OPTONICA	053 054	STS	013		
GO VIDEO	132 136	PANASONIC	066 070 074 083 133 140 145	SYLVANIA	031 033 034 059 067		
HARMAN KARDON	012 045	PENTAX	013 020 031 033 063		034		
HITACHI	004 018 026 034 043 063 137 150	PHILCO	031 034 067		013		
INSTANTREPLAY	031 033	PHILIPS	031 033 034 054 067 071 101		031 033 034 059 067		
JCL	031 033	PILOT	101		034		
JCPENNY	012 013 015 033 040 066 101	PIONEER	013 021 048		010 034		
JENSEN	043						
JVC	012 031 033 043 048 050 055 060 130 150 152						

■ AUDIO

Brand	Codes	Brand	Codes	Brand	Codes	Brand	Codes
AIWA	014 028 070 096 125 129 139 229 230	INKEL	037 058 062 069 078 079 095 121 122 149 150 151 152 153 154 155 157 158 159 160 189 207 222 224 225 226 227 243 247	MARANTZ	002 018 020 025 034 041 081 090 097 112	SANYO	019 083 234
AKAI	163	KEC	185 186 187	MEMOREX	107	SCOTT	106 186
ANAM	003 014 017 023 059 106 189 216 217 235 236	KENWOOD	038 050 067 089 170 171 197 206 215 222	NAD	046	SHARP	031 032 051 052 072 082 117 119 156 184 199 200 206 209
BURMECTER	252	KOHEL	030	ONKYO	013 040 041 047 048 056 057 132 133 140	SHERWOOD	005 006 158
CARVER	086	NAD	045 046	OPTIMUS	158	SONY	044 045 109 114 118 126 248 249
CLARION	199	LOTTE	014 016 036 098 100 172 173 174 175 176 177 178 179 180 181 183 201 202 208 213 214 219 223 232 238 240	PANASONIC	007 033 064 113 142 220 241 251 104	TAEKWANG	012 020 073 074 076 077 105 161 162 163 164 165 166 167 168 169 205 231 233 242
DAEWOO	027 053 060 084 102 148 198 221			PENNEY	104	TEAC	010 085 106 136 185 187 237
DENON	015 075 130 143			PHILIPS	026 112 143	TECHNICS	101 113 128 134 147 218
FANTASIA	071			PIONEER	039 042 043 063 065 091 093 094 115 123 127 250	TOSHIBA	137
FINEARTS	022			QUASAR	113	THE	061
FISHER	089 099			RCA	080	VICTOR	088 131
LG (GOLDSTAR)	001 021 024 029 087 107 108 110 190 191 192 210 211 212 239			RCX	092	WARDS	089
HAITAI	034 035 188 222			REALISTIC	103 106	YAMAHA	054 055 066 092 199
HARMAN/KARDON	068	LXI	103	SAMSUNG	124 145 146 182 193 194 195 203 204 244 245 246		
JVC	004 013 141	MAGNAVOX	111				
MCS	104	MCINTOSH	049	SANSUI	011 135 138 144		

Reference

Programming Codes

■ DVD

Brand	Codes	Brand	Codes	Brand	Codes	Brand	Codes
APEX DIGITAL	022	MAGNAVOX	013	PHILIPS	013	SONY	007
DENON	020 014	MARANTZ	024	PIONEER	004 026	THOMPSON	005 006
GE	005 006	MITSUBISHI	002	PROCEED	021	TOSHIBA	019 008
HARMAN KARDON	027	NAD	023	PROSCAN	005 006	YAMAHA	009 018
JVC	012	ONKYO	008 017	RCA	005 006	ZENITH	010 016 025
LG (GOLDSTAR)	001 010 016 025	PANASONIC	003 009	SAMSUNG	011 015		

■ CABLE

Brand	Codes	Brand	Codes	Brand	Codes	Brand	Codes
ABC	003 004 039 042	GOLDEN CHANNEL	030	PHILIPS	006 012 013 020	SPRUCER	047 078
	046 052 053	HAMLIN	049 050 055		065 085 090	STARCOM	002 004 008 009
AJIN	112	HITACHI	052 055	PIONEER	034 051 052 063	STARGATE	008 030
ANTRONIK	014	HOSPITALITY	070 077		076	TADIRAN	030
ARCHER	005 007 014 024	JERROLD	002 003 004 008	PRUCER	059	TAEKWANG	110
CABLE STAR	026		009 010 052 069	PTS	011 048 071 072	TAIHAN	105
CENTURION	092		074		073 074	TANDY	017
CENTURY	007	LG (GOLDSTAR)	001 106 101 005	PULSAR	100	TEXSCAN	029
CITIZEN	007	M-NET	037	RCA	047	TOCOM	039 040 056
COLOUR VOICE	065 090	MACOM	033	REGAL	049 050	TOSHIBA	100
COMBANO	080 081	MAGNAVOX	010 012 064 079	REGENCY	057	UNIKA	007 014 024
COMTRONICS	019 030	MEMOREX	100	REMBRANT	025	UNITED CABLE	004 053
DIAMOND	023	MOVIE TIME	028 032	SAMSUNG	102 107 030 068	UNIVERSAL	005 007 014 024
EAGLE	020 030 040	NSC	015 028 038 071	SCIENTIFIC ATLANTA	003 011 041 042		026 027 032 035
EASTERN	057 062 066		073		043 045 046	VIEWSTAR	012 015 018 086
ELECTRICORD	032	OAK	016 031 037 053	SHERITECH	022		087 088 089
GE	072	PANASONIC	044 047	SIGNAL	030	ZENITH	100 114 060 093
GEMINI	008 022 025 054	PARAGON	100	SIGNATURE	052		
GI	052 074	POST NEWS WEEK	016	SL MARX	030		

■ STB

Brand	Codes	Brand	Codes	Brand	Codes	Brand	Codes
ALPHASTAR DSR	123	EUROPLUS	114	MACOM	010 059 063 064	SATELLITE SERVICE CO	028 035 047 057
AMPLICA	050	FUJITSU	017 021 022 027		065		085
BIRDVIEW	051 126 129		133 134	NEXTWAVE	028 124 125	SONY	103
CHANNEL MASTER	013 014 015 018	GENERAL INSTRUMENT	003 004 016 029	NORSAT	069 070	STARCAST	041
	036 055		031 059 101	PAGE SKY SATELLITE	143	SUPER GUIDE	020 124 125
CHAPARRAL	008 009 012 077	HITACHI	139 140	PANASONIC	060 142	TEECOM	023 026 075 087
CITOH	054	HOUSTON TRACKER	033 037 039 051	PANSAT	121		088 090 107 130
CURTIS MATHES	050 145		057 104	PERSONAL CABLE	117		137
DRAKE	005 006 007 010	HUGHES	068	PHILIPS	071	TOSHIBA	002 127
	011 052 112 116	JANIEL	060 147	PICO	105	UNIDEN	016 025 042 043
	141	JERROLD	061	PRESIDENT	019 102		044 045 048 049
DX ANTENNA	024 046 056 076	KATHREIN	108	PRIMESTAR	030 110 111		078 079 080 086
ECHOSTAR	038 040 057 058	LEGEND	057	PROSAT	072		101 135 136
	093 094 095 096	LG (GOLDSTAR)	001	RCA	066 106	VIEWSTAR	115
	097 098 099 100	LUTRON	132	REALISTIC	043 074	WINEGARD	128 146
	122	LUXOR	062 144	SAMSUNG	123	ZENITH	081 082 083 084
ELECTRO HOME	089	MEMOREX	057	SCIENTIFIC ATLANTA	032 138		091 120

IR codes

How to Connect

- ▶ Connect your wired remote control to the Remote Control port on the TV.

Remote Control IR Codes

▶ Output waveform

Single pulse, modulated with 37.917KHz signal at 455KHz

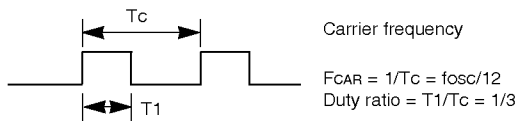

▶ Configuration of frame

- 1st frame

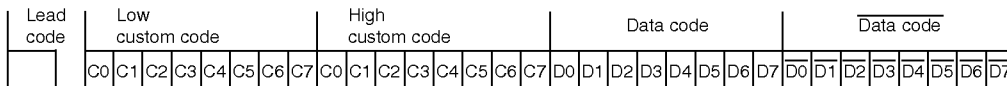

- Repeat frame

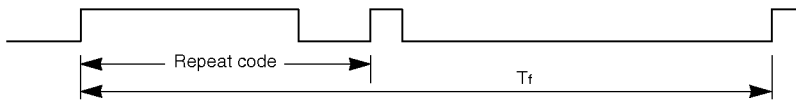

▶ Lead code



▶ Repeat code

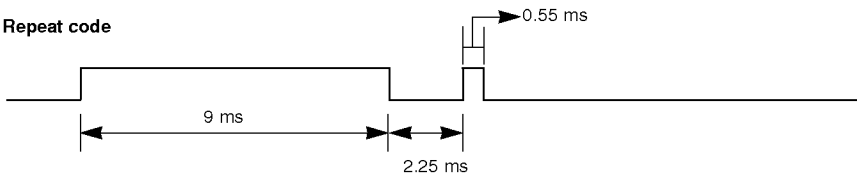

▶ Bit description

- Bit "0"

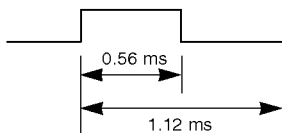

- Bit "1"

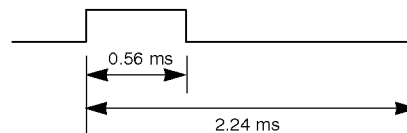

▶ Frame interval : Tf

The waveform is transmitted as long as a key is depressed.

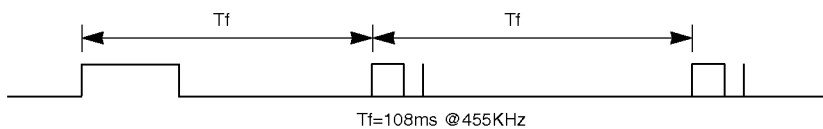

Reference

IR codes

Code (Hexa)	Function	Note
0F	TV	Remote Control Button
08	POWER	Remote Control Button
0B	INPUT	Remote Control Button
C4	POWER ON	Discrete IR Code (Only Power On)
C5	POWER OFF	Discrete IR Code (Only Power OFF)
60	PIP	Remote Control Button
5D	ZOOM-	Remote Control Button
5C	ZOOM+	Remote Control Button
0E	SLEEP	Remote Control Button
20	TEXT	Remote Control Button
52	SSM	Remote Control Button
4D	PSM	Remote Control Button
0A	I/II	Remote Control Button
43	MENU	Remote Control Button
79	ARC	Remote Control Button
5B	EXIT	Remote Control Button
07	◀	Remote Control Button
06	▶	Remote Control Button
40	▲	Remote Control Button
41	▼	Remote Control Button
44	OK	Remote Control Button
72	PIP PR-	Remote Control Button
71	PIP PR+	Remote Control Button
63	SWAP	Remote Control Button
61	PIP INPUT	Remote Control Button
72	RED	Remote Control Button
71	GREEN	Remote Control Button
63	YELLOW	Remote Control Button
61	BLUE	Remote Control Button
02	VOL ▲	Remote Control Button
03	VOL ▼	Remote Control Button
00	PR ▲	Remote Control Button
01	PR ▼	Remote Control Button
09	MUTE	Remote Control Button
53	LIST	Remote Control Button
10~19	Number Key 0~ 9	Remote Control Button
1E	FAVOURITE	Remote Control Button
1A	Q.VIEW	Remote Control Button
64	SIZE	Remote Control Button
62	PIP : POSITION, Teletext : UPDATE	Remote Control Button
70	INDEX	Remote Control Button
65	HOLD	Remote Control Button
26	TIME	Remote Control Button
2A	REVEAL	Remote Control Button
24	MIX	Remote Control Button
22	MODE	Remote Control Button

External Control Device Setup ; RS-232C

- Connect the RS-232C input jack to an external control device (such as a computer or an A/V control system) and control the TV's functions externally.
- Connect the serial port of the control device to the RS-232C jack on the TV back panel.
- RS-232C connection cable is not supplied with the TV.

RS-232C Setup

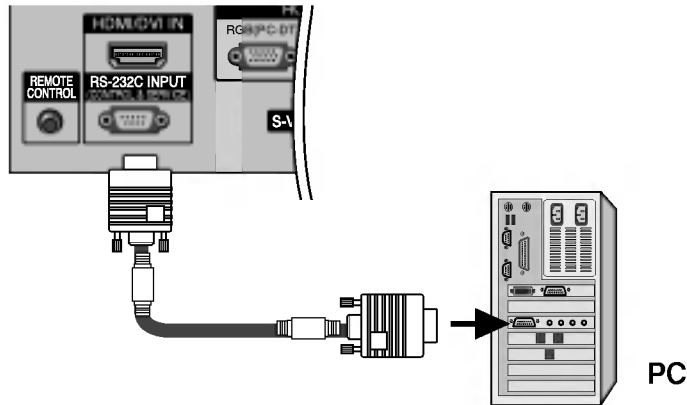

Type of Connector; D-Sub 9-Pin Male

No.	Pin name
1	No connection
2	RXD (Receive data)
3	TXD (Transmit data)
4	DTR (DTE side ready)
5	GND
6	DSR (DCE side ready)
7	RTS (Ready to send)
8	CTS (Clear to send)
9	No Connection

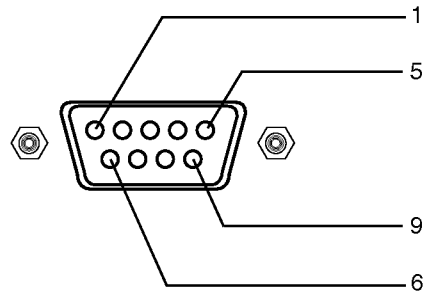

RS-232C Configurations

7-Wire Configurations (Standard RS-232C cable)

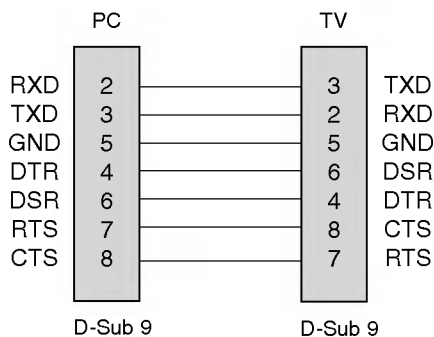

3-Wire Configurations (Not standard)

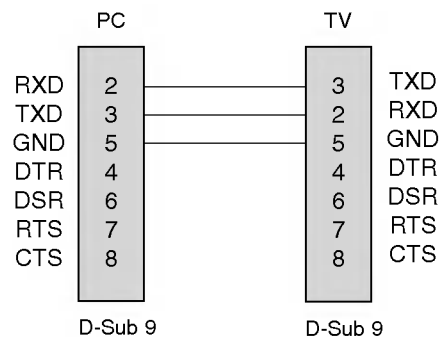

Reference

External Control Device Setup ; RS-232C

Set ID

- Use this function to specify a monitor ID number.
- Refer to 'Real Data Mapping 1'. See page 63.

1. Press the **MENU** button and then use **▲ / ▼** button to select the **Special** menu.
2. Press the **▶** button and then use **▲ / ▼** button to select **Set ID**.
3. Press the **▶** button and then use **◀ / ▶** button to adjust **Set ID** to choose the desired monitor ID number. The adjustment range of **Set ID** is 1 ~ 99.
4. Press the **OK** button to save.

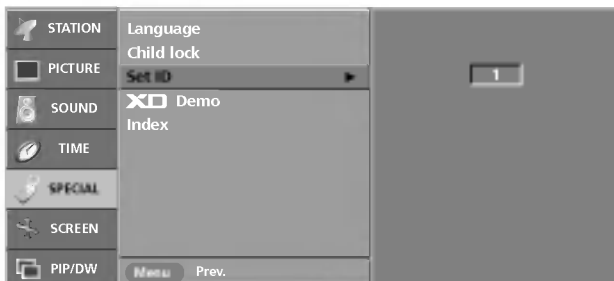

Communication Parameters

- Baud rate : 9600 bps (UART)
- Data length : 8 bits
- Parity : None
- Stop bit : 1 bit
- Communication code : ASCII code
- * Use a crossed (reverse) cable.

Command Reference List

	COMMAND 1	COMMAND 2	DATA (Hexa)
01. Power	k	a	0 ~ 1
02. Input Select (Main Picture)	x	b	*
03. Input Select (Sub Picture)	x	y	*
04. Aspect Ratio	k	c	0 ~ 6
05. Screen Mute	k	d	0 ~ 1
06. Volume Mute	k	e	0 ~ 1
07. Volume Control	k	f	0 ~ 64
08. Contrast	k	g	0 ~ 64
09. Brightness	k	h	0 ~ 64
10. Colour	k	i	0 ~ 64
11. Tint	k	j	0 ~ 64
12. Sharpness	k	k	0 ~ 64
13. OSD Select	k	l	0 ~ 1
14. Key Lock	k	m	0 ~ 1
15. Balance	k	t	0 ~ 64
16. Programme Select (Main TV Input)	m	a	0 ~ 63
17. Programme Select (Sub TV Input)	m	b	0~1
18. Key	m	c	Key Code

* : Refer to '02~03. Input Select' on page 63

Transmission / Receiving Protocol

Transmission

[Command1][Command2][][Set ID][][Data][Cr]

- * [Command 1]: First command. (k, x or m)
- * [Command 2]: Second command.
- * [Set ID]: You can adjust the set ID to choose desired monitor ID number in Special menu. Adjustment range is 1 ~ 99. When selecting Set ID '0', every connected TV set is controlled. Set ID is indicated as decimal (1~99) on menu and as Hexa decimal (0x0~0x63) on transmission/receiving protocol.
- * [DATA]: To transmit command data.
Transmit 'FF' data to read status of command.
- * [Cr]: Carriage Return
ASCII code '0x0D'
- * []: ASCII code 'space (0x20)'

OK Acknowledgement

[Command2][][Set ID][][OK][Data][x]

- * The Monitor transmits ACK (acknowledgement) based on this format when receiving normal data. At this time, if the data is data read mode, it indicates present status data. If the data is data write mode, it returns the data of the PC computer.

Error Acknowledgement

[Command2][][Set ID][][NG][Data][x]

- * The Monitor transmits ACK (acknowledgement) based on this format when receiving abnormal data from non-viable functions or communication errors.
Data 1: Illegal Code
2: not support function

Error messages

1. **Illegal ID** : If Wrong or no ID in the command is written.
2. **B_TokenLength !=2** : If the first argument of the command does not equals to 2.
3. **Error ==TOKEN_ERROR** : If some Special character or Numeric are written to the first argument of the command or wrong Space position is written to the first argument of the command.
4. **Illegal Opcodes** : If the Wrong Alphabet is written to the first argument of the command.
5. **Illegal Params** : If the Wrong parameter is supplied to the end of the command line (means that value of the parameter that is not supported).

01. Power On (Command:a)

- ▶ To control Power On/Off of the TV.

Transmission

[k][a][][Set ID][][Data][Cr]

Data 0 : Power Off 1 : Power On

Acknowledgement

[a][][Set ID][][OK][Data][x]

- ▶ To show Power On/Off.

Transmission

[k][a][][Set ID][][FF][Cr]

Acknowledgement

[a][][Set ID][][OK][Data][x]

Data 0 : Power Off 1 : Power On

02. Input Select (Command:b) (Main Picture Input)

- ▶ To select input source for the TV.
You can also select an input source using the INPUT button on the TV's remote control.

Transmission

[x][b][][Set ID][][Data][Cr]

Data 10 : TV 50 or 60 : RGB PC
20 : AV1 21 : AV2 51 or 61 : RGB DTV
22 : AV3 90 : HDMI PC
30 : S-Video 91 : HDMI DTV
40 : Component

Acknowledgement

[b][][Set ID][][OK][Data][x]

03. Input Select (Command:y) (Sub Picture Input)

[x][y][][Set ID][][Data][Cr]

Data 10 : TV 50 or 60 : RGB
20 : AV1 21 : AV2 90 : HDMI
22 : AV3
30 : S-Video
40 : Component

Acknowledgement

[y][][Set ID][][OK][Data][x]

04. Aspect Ratio (Command:c) (Main picture format)

- ▶ To adjust the screen format.
You can also adjust the screen format using the ARC (Aspect Ratio Control) button on remote control or in the Screen menu.

Transmission

[k][c][][Set ID][][Data][Cr]

Data 0 : Normal screen (4:3) 4 : Spectacle
1 : Wide screen (16:9) 5 : Full
2 : 14:9 6 : Original
3 : Zoom

* In PC mode only 16:9 and 4:3 aspect ratios are available.

Acknowledgement

[c][][Set ID][][OK][Data][x]

05. Screen Mute (Command:d)

- ▶ To select screen mute on/off.

Transmission

[k][d][][Set ID][][Data][Cr]

Data 0 : Screen mute off (Picture on)
1 : Screen mute on (Picture off)

06. Volume Mute (Command:e)

- ▶ To control volume mute on/off.
You can also adjust mute using the MUTE button on remote control.

Transmission

[k][e][][Set ID][][Data][Cr]

Data 0 : Volume mute on (Volume off)
1 : Volume mute off (Volume on)

Acknowledgement

[e][][Set ID][][OK][Data][x]

07. Volume Control (Command:f)

- ▶ To adjust volume.
You can also adjust volume with the volume buttons on remote control.

Transmission

[k][f][][Set ID][][Data][Cr]

Data Min: 0 ~ Max: 64 (transmit by Hexadecimal code)
• Refer to 'Real data mapping 1' as shown below.

Acknowledgement

[f][][Set ID][][OK][Data][x]

08. Contrast (Command:g)

- ▶ To adjust screen contrast.
You can also adjust contrast in the Picture menu.

Transmission

[k][g][][Set ID][][Data][Cr]

Data Min: 0 ~ Max: 64 (transmit by Hexadecimal code)
• Refer to 'Real data mapping 1' as shown below.

Acknowledgement

[g][][Set ID][][OK][Data][x]

* Real data mapping 1

0 : Step 0
⋮
A : Step 10
⋮
F : Step 15
10 : Step 16
⋮
64 : Step 100

* Tint : R50 ~ G50

* Balance : L50 ~ R50

Reference

External Control Device Setup ; RS-232C

09. Brightness (Command:h)

- ▶ To adjust screen brightness.
You can also adjust brightness in the Picture menu.

Transmission

[k][h][][Set ID][][Data][Cr]

Data Min: 0 ~ Max: 64 (transmit by Hexadecimal code)
• Refer to 'Real data mapping 1'. See page 63.

Acknowledgement

[h][][Set ID][][OK][Data][x]

10. Colour (Command:i)

- ▶ To adjust the screen colour.
You can also adjust colour in the Picture menu.

Transmission

[k][i][][Set ID][][Data][Cr]

Data Min: 0 ~ Max: 64 (transmit by Hexadecimal code)
• Refer to 'Real data mapping 1'. See page 63.

Acknowledgement

[i][][Set ID][][OK][Data][x]

11. Tint (Command:j)

- ▶ To adjust the screen tint.(NTSC M input only)
You can also adjust tint in the Picture menu.

Transmission

[k][j][][Set ID][][Data][Cr]

Data Min: 0 ~ Max: 64 (transmit by Hexadecimal code)
• Refer to 'Real data mapping 1'. See page 63.

Acknowledgement

[j][][Set ID][][OK][Data][x]

12. Sharpness (Command:k)

- ▶ To adjust the screen sharpness.
You can also adjust sharpness in the Picture menu.

Transmission

[k][k][][Set ID][][Data][Cr]

Data Min: 0 ~ Max: 64 (transmit by Hexadecimal code)
• Refer to 'Real data mapping 1'. See page 63.

Acknowledgement

[k][][Set ID][][OK][Data][x]

13. OSD Select (Command:l)

- ▶ To select OSD (On Screen Display) mute on/off.

Transmission

[k][l][][Set ID][][Data][Cr]

Data 0: OSD mute on 1: OSD mute off

Acknowledgement

[l][][Set ID][][OK][Data][x]

14. Key Lock (Command:m)

- ▶ To lock the front panel controls on the TV.

Transmission

[k][m][][Set ID][][Data][Cr]

Data 0: Lock off 1: Lock on

Acknowledgement

[m][][Set ID][][OK][Data][x]

- If you're not using the front panel controls on the TV, use this mode. When main power is on/off, remote control lock is released.

15. Balance (Command:t)

- ▶ To adjust balance.

Transmission

[k][t][][Set ID][][Data][Cr]

Data Min: 0 ~ Max: 64 (transmit by Hexadecimal code)

- Refer to 'Real data mapping 1'. See page 61.

Acknowledgement

[t][][Set ID][][OK][Data][x]

16. Programme Select (Command:m a) (Main TV Input)

- ▶ Tune channel to following Physical/major/minor number.

Transmission

[m][a][][Set ID][][Data0][Cr]

Data0: Programme Number
Min : 0 ~ Max : 63(transmit by Hexadecimal code)

Acknowledgement

[a][][Set ID][][OK][Data0][x]

[a][][Set ID][][NG][Data0][x]

17. Programme Select (Command:m b) (Sub TV Input)

- ▶ Tune channel to following Physical/major/minor number.

Transmission

[m][b][][Set ID][][Data 0][Cr]

Data0: Programme Number
Min : 0 ~ Max : 63(transmit by Hexadecimal code)

Acknowledgement

[b][][Set ID][][OK][Data0][x]

[b][][Set ID][][NG][Data0][x]

18. Key (Command:m c)

- ▶ To send IR remote key code.

Transmission

[m][c][][Set ID][][Data][Cr]

Data: Key code (Refer to P.60)

Acknowledgement

[c][][Set ID][][OK][Data][x]