

ENGLISH



In Dash Navi & Infotainment System with Bluetooth

OWNER'S MANUAL

MODEL : LAN-9600R

Please read this instruction booklet carefully and completely before connecting, operating or adjusting this product.



Table of contents

Safety notes 6-9

Basic operation 10-21

Front panel	10
Monitor	11
Accessories	11
Remote control	12
Install the battery of remote control	13
Using the remote control	13
Connecting the system	14-17
Detaching the control panel	18
Attaching the control panel	18
Installing the hide-away unit	18
Basic installation	19
Removing the existing receiver unit	19
ISO-DIN installation	19
Turning the unit on	20
Turning the unit off	20
Opening / Closing the LCD	20
Changing the monitor angle	20
Turning the LCD panel horizontal	20
Inserting a disc	20
Ejecting a disc	21
Adjusting the volume	21
Mute (To drop the volume in a moment)	21
Selecting a source	21
Selecting a EQ (Equalizer)	21

Dual mode operation 22

Using a display connected to REAR OUT	22
Selecting a source	22
Canceling the dual mode	22
About rear camera view	22

Setup operation 23-29

SETUP	23
SCREEN	23-24
SOUND	25-26
DVD	26-27
Defining the parental control	27
Changing the password	28
Changing the area code	28
RDS	29
SOURCE	29

Table of contents

Bluetooth operation 30-37

Using a Bluetooth wireless connection	.30
Starting Bluetooth on your phone	.30
Pairing your unit and Bluetooth phone	.30-32
Headset functionality	.32
SETUP	.33
CONNECT PHONE	.33
INFORMATION (CONNECT PHONE)	.33
BT INFO. (Bluetooth information)	.34
PHONE BOOK	.34-35
INFORMATION (PHONE BOOK)	.36
Making a call	.36
Making a call with speed dial numbers	.36
Answering calls	.37
Making a call from recent calls	.37
Changing between car speaker and Bluetooth phone during a call	.37

Radio (RDS) operation 38-41

Listening to radio stations	.38
AS (Auto search memory)	.38
Storing and recalling stations	.38
RDS display options	.39
AF (Alternative frequency)	.39
TA (Traffic announcement identification)	.40
PTY (Program type recognition)	.40
REGION	.40
R-TEXT (Radio text recognition)	.41

CD/MP3/WMA operation 42-44

Playing an audio CD and MP3/WMA disc	.42
Skip to the next track/file	.42
Skip to the previous track/file	.42
Return to the beginning of the current track/file	.42
Search	.42
Skip to the previous folder/next folder	.42
Locating a folder/file using the list	.43
REPEAT	.43
SHUFFLE	.43
SCAN	.43
INFORMATION	.44

Table of contents

DVD/VCD operation	45-48
Playing a DVD/VCD disc	.45
If menu screen is displayed	.45
Play / Stop / Pause	.46
Skip to the next chapter/track	.46
Skip to the previous chapter/track	.46
Return to the beginning of the current chapter/track	.46
Search	.46
MENU/VCD MENU	.46
SEARCH	.47
AUDIO	.47
SUBTITLE	.47
ANGLE	.47
REPEAT	.48
Using ◊	.48
DivX Operation	49-51
Playing a Divx disc	.49
Play / Stop / Pause	.50
Skip to the next file	.50
Skip to the previous file	.50
Search	.50
Locating a folder/file using the list	.50
REPEAT	.51
AUDIO	.51
SUBTITLE	.51
Photo operation	52
Playing photo files	.52
Picture format	.52
USB operation	53
Playing a USB device	.53
Locating a folder/file using the list	.53
Basic navigation	54-55
What is GPS?	.54
Memory navi mode	.54
Navigation in the memory navi mode	.54
Installing the new map data in the memory	.55
Menu and Map display	56-61
MAP mode	.56-57
Whole route overview	.58
Guide mode	.58
Simulation mode	.59
Scrolling the map display	.59
Marking your first journey	.60-61
Selecting your country	.61

Table of contents

Finding a location with the navigator	62-69
Modifying the destination menu	.62
Memory Points	.62
MODIFY INFORMATION : Editing a location's information	.63
POI (Point of interest) Search	.64-65
Nearest POI (Point of interest)	.66
Address Search	.67
Junction Search : City ➔ Street1 ➔ Street2	.68
Previous Dest. (Previous destination)	.69
Navigation settings	70-80
Registering your home and your favorite location	.70
Modifying the Route Calculation Conditions	.71
Cancel Route	.71
Route Overview	.71
ROUTE OPTIONS	.72
Edit Way Point	.73
Detour	.74
Change Start	.75
Using Traffic Information (RDS-TMC)	.76
TMC Event List	.76
Station Search	.77
Display Icon	.77
TMC Option	.78
Display	.79
Guidance	.79
Volume	.80
Language	.80
System Options	.80
Download	.80
GPS Information	.80
Initialize	.80
Troubleshooting	81-84
Bluetooth phone compatibility list	85
Specifications	86
Support-Hotline	87

● Safety notes



The lightning flash with the arrowhead symbol, within an equilateral triangle is intended to alert the user about the presence of uninsulated dangerous voltage within the product's enclosure that may be of sufficient magnitude to constitute a risk of electric shock.



The exclamation point within an equilateral triangle is intended to alert the user to the presence of important operating and maintenance (servicing) instructions in the literature accompanying the appliance.



Always operate the vehicle in a safe manner. Do not become distracted by the vehicle while driving, and always be fully aware of all driving conditions. Do not change settings, or any functions. Pull over in a safe and legal manner before attempting such operations.

To promote safety, certain functions are disabled unless the handbrake is on.



Do not use for many hours at extremely low or high temperature. (-10~60°C)



To reduce the risk of electric shock, do not remove the cover or back of this product. There are no user-serviceable parts inside. Refer servicing to qualified service personnel.



To reduce the risk of fire or electric shock, do not expose this product to dripping or splashing water, rain, or moisture.



The temperature of unit's outside can be extremely high, please use the unit after proper installation in your vehicle.



While driving, keep the sound volume at a proper level.



Do not drop it and avoid heavy impacts at anytime.

Safety notes

The driver must not watch the monitor while driving. If the driver watches the monitor while driving, it may lead to carelessness and cause an accident.



This unit is for vehicles with a 12-volt battery and negative grounding. Before installing it in a recreational vehicle, lorry or bus, check the battery voltage. To avoid shorts in the electrical system, be sure to disconnect the  battery cable before beginning the installation.



Periodically wipe the contacts on the back of the front panel with a cotton swab moistened with alcohol.

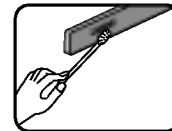

Disposal of your old appliance

1. When this crossed-out wheeled bin symbol is attached to a product, it means the product is covered by the European Directive 2002/96/EC.
2. All electrical and electronic products should be disposed of separately from the municipal waste stream via designated collection facilities appointed by the government or the local authorities.
3. The correct disposal of your old appliance will help prevent potential negative consequences for the environment and human health.
4. For more detailed information about disposal of your old appliance, please contact your city office, waste disposal service or the shop where you purchased the product.



This product has been manufactured to comply with the radio interference requirements of EEC DIRECTIVE 89/336/EEC, 93/68/EEC and 73/23/EEC.



Safety notes

A section whose title has one of the following symbols is applicable only to the disc represented by the symbol.

 DVD	 Video CDs
 Audio CDs	 MP3 files
 WMA files	 DivX files

About the Symbol Display

When you are watching a DVD and attempt to perform an operation, it may not be performed due to the programming on the disc. When this happens, the unit indicates the button  on the screen.

Types of Playable Discs



DVD
(12 cm disc)



Video CD (VCD)
(12 cm disc)



Audio CD
(12 cm disc)

In addition, this unit plays DVD±R, DVD±RW and CD-R or CD-RW containing audio titles, MP3 or WMA.

- Depending on the conditions of the recording equipment or the CD-R/RW (or DVD±R/±RW) disc itself, some CD-R/RW (or DVD±R/±RW) discs cannot be played on the unit.
- Do not attach any seal or label to either side (the labeled side or the recorded side) of a disc.
- Do not use irregularly shaped CDs (e.g., heart-shaped or octagonal). It may result in malfunctions.

Notes on DVDs and Video CDs

Some playback operations of DVDs and Video CDs may be intentionally programmed by software manufacturers. This unit plays DVDs and Video CDs according to disc content designed by the software manufacturer, therefore some playback features may not be available or other functions may be added.

Safety note

- A defective or soiled disc inserted into the unit can cause sound to drop during playback.
- Handle the disc by holding its inner and outer edges.
- Do not touch the surface of the unlabeled side of the disc.
- Do not stick paper or tape etc. on the surface.
- Do not expose the disc to direct sunlight or excessive heat.
- This unit cannot play 8cm disc (use 12cm disc only).
- Clean the disc before playback. Wipe the disc from the center outward with a cleaning cloth.
- Never use solvents such as benzene or alcohol to clean the disc.



Regional code

This unit is designed and manufactured for playback of region "2" encoded DVD software. This unit can only play DVD discs labeled "2" or "ALL".



Notes on Regional Codes

- Most DVD discs have a globe with one or more numbers on it clearly visible on the cover. This number must match your Car DVD Receiver's regional code or the disc cannot play.
- If you try to play a DVD with a different region code from your player, the message "Check regional code" appears on the screen.

CAUTION : VISIBLE AND INVISIBLE LASER RADIATION WHEN OPEN AND INTERLOCKS DEFEATED.

CAUTION : This product uses a Laser System.

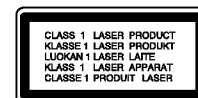

To ensure proper use of this product, please read this owner's manual carefully and retain it for future reference. Should the unit require maintenance, contact an authorized service center. Performing controls, adjustments, or carrying out procedures other than those specified herein may result in hazardous radiation exposure. To prevent direct exposure to laser beam, do not try to open the enclosure. Visible laser radiation when open. **DO NOT STARE INTO BEAM.**

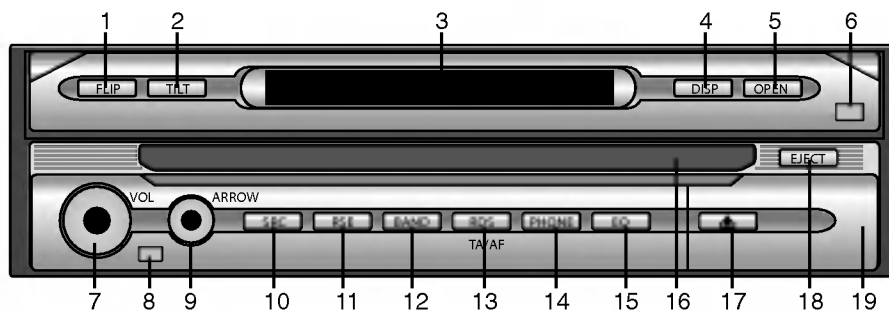

Basic operation

Front panel



1. **FLIP**
Turn the LCD panel horizontal temporarily when the LCD panel is upright.
2. **TILT**
Adjust the monitor angle.
3. **DISPLAY WINDOW**
4. **DISP**
Select a different display.
5. **OPEN/CLOSE**
Open (or Close) the monitor.
6. **DIMMER SENSOR**
7. **VOL. (Volume)**
 - Adjust the volume.
 - Power off (Press a long time)
 - Mute (Press a short time)
8. **REMOTE SENSOR**
9. **ARROW ▲/▼/◀/▶ (up/down/left/right)**
 - Select the folders
 - Select the menus
 - Skip (Push a short time)
 - Seek (Push a short time)
 - Enter
10. **SRC (Source)**
Change the sources.
11. **RSE (Rear service)**
You can playback two different sources as main source and subsidiary source.
12. **BAND**
 - Select the band.
13. **RDS**
 - Select the TA on/off (Press a short time)
 - Select the AF/RE on/off (Press a long time)
14. **PHONE**
Select the phone.
15. **EQ**
Select various equalizer curves.
16. Disc slot
17.  **EJECT**
Eject a disc from the unit,
18.  **Home**
Remove the front panel.
19.  **USB port**
Pull the cover on the front.

Basic operation

Monitor

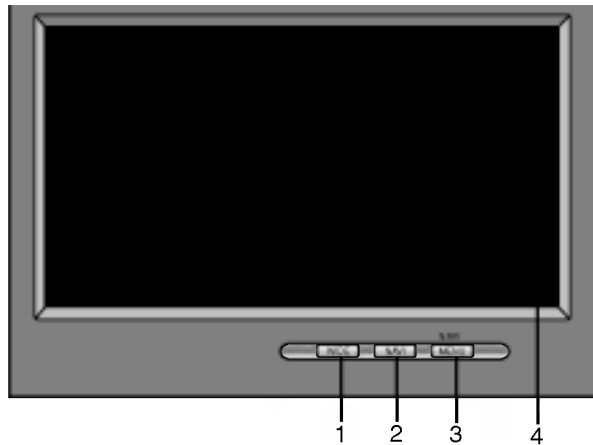

- 1. WIDE**
Change the screen mode.

- 2. NAVI**
Display the navigation map.
- 3. MENU**
Display the navigation menu.
- 4. LCD**



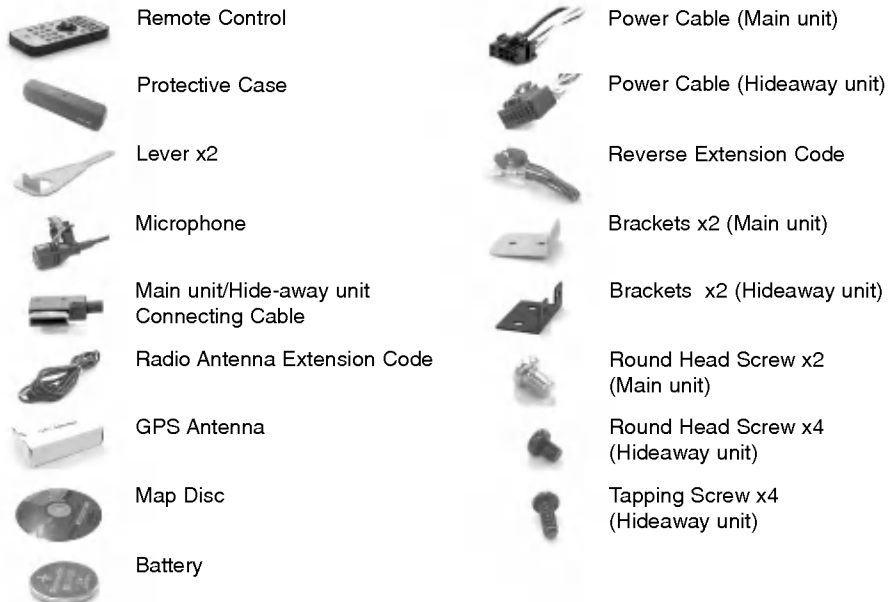



Accessories

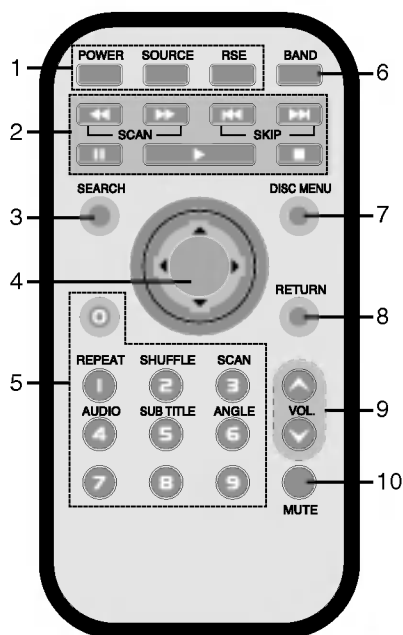

Basic operation

Remote control



1. **POWER**
Switches the unit ON/OFF.
- SOURCE**
Selects a source.
- RSE (Rear service)**
You can play two different sources as main source and secondary source.
2. **SKIP I<</>I**
 - Go to next (previous) chapter, track or file.
 - Return to the beginning of the current chapter, track or file.
- SCAN <</>**
Backward (Forward) search playback.
- STOP ■ PLAY ► PAUSE II**
3. **SEARCH** 
Select chapter or title.
4. **▲/▼/◀/▶** (up/down/left/right)
Select an item in the menu.
- ENTER**
Confirms menu selection.
5. **0-9 number buttons**
 - Selects numbered items in the menu.
 - Selects a stored radio station frequency (1-6).
- REPEAT**
• Repeat chapter, track, title or file.
- SHUFFLE**
• Plays tracks or files in random order. 
- SCAN**
• Plays the first 10 seconds of all track. 
- AUDIO**
• Select audio language. 
- SUBTITLE**
• Select audio subtitle language.  
- ANGLE**
• Select a DVD camera angle if available. 
6. **BAND**
Select FM and MW(AM) bands.
7. **DISC MENU**
Accesses the menu on a DVD disc.
8. **RETURN**
Displays the disc menu with PBC.
9. **VOLUME**
Adjust the volume level.
10. **MUTE**
Mute the volume.

Basic operation

Install the battery of remote control

Pull the tray on the back of battery of remote control outward with a pencil or ball point pen and insert the battery with the plus (+) minus (-) poles pointing in the proper direction.

- 1 Remove the battery holder with a pencil or ball point pen.
- 2 Install the battery on the battery holder.
- 3 Install the battery holder back into its original position.

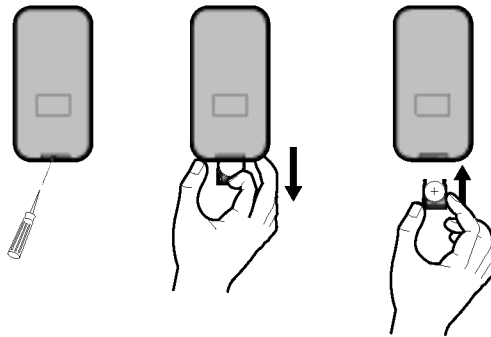

Using the remote control

Point the remote control in the direction of the front panel to operate.

✦ Notes

- Use only one CR2025 (3V) lithium battery.
- Remove the battery if the remote control is not going to be used for a long period of time.
- Do not leave the product in a hot or humid place.
- Do not handle the battery with metallic tools.
- Do not store the battery with metallic materials.
- In the event of battery leakage, wipe the remote control completely clean and install a new battery.

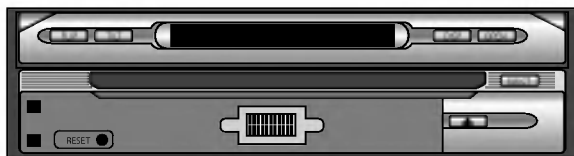

Reset

If the unit fails to operate properly, press the rest button using a ball-pen or a similar too.

Basic operation

Connecting the system

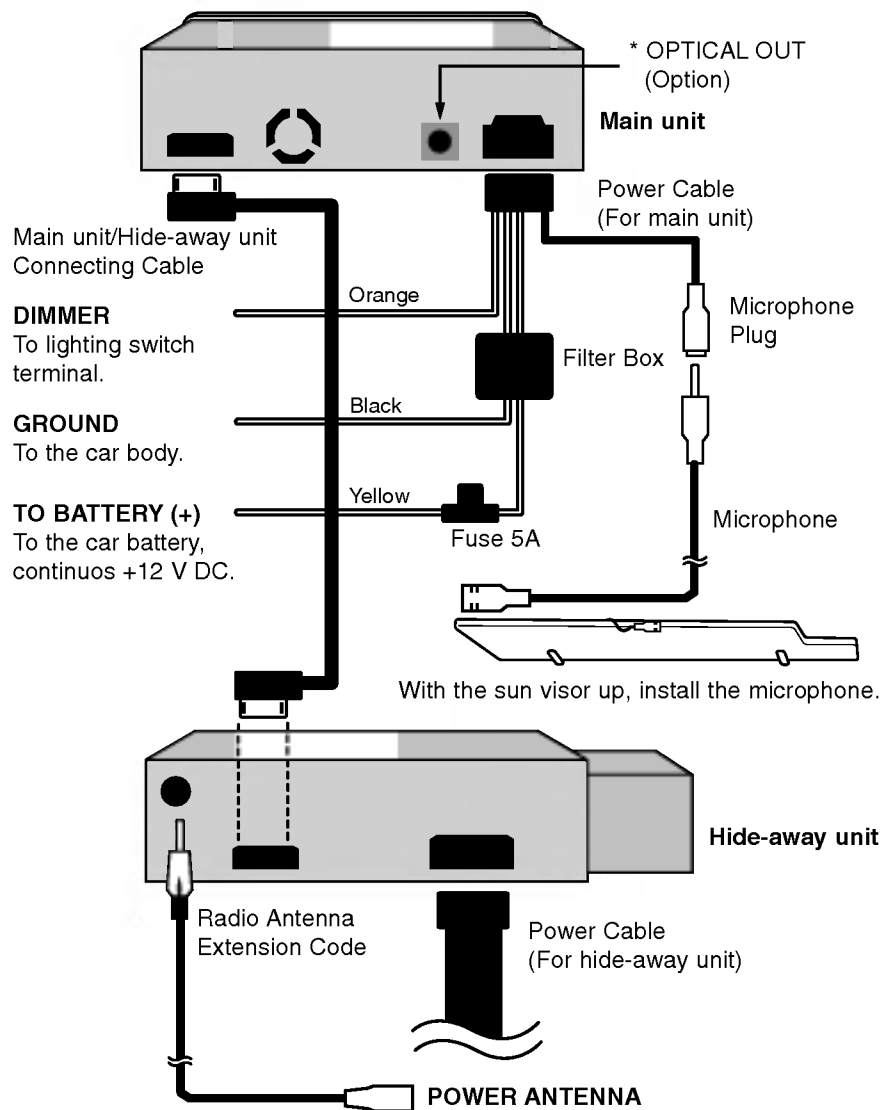

* Connecting to Optical equipment.

Connecting to an amplifier equipped with two channel digital stereo or to an Audio/Video receiver equipped with a multi-channel decoder.

Basic operation

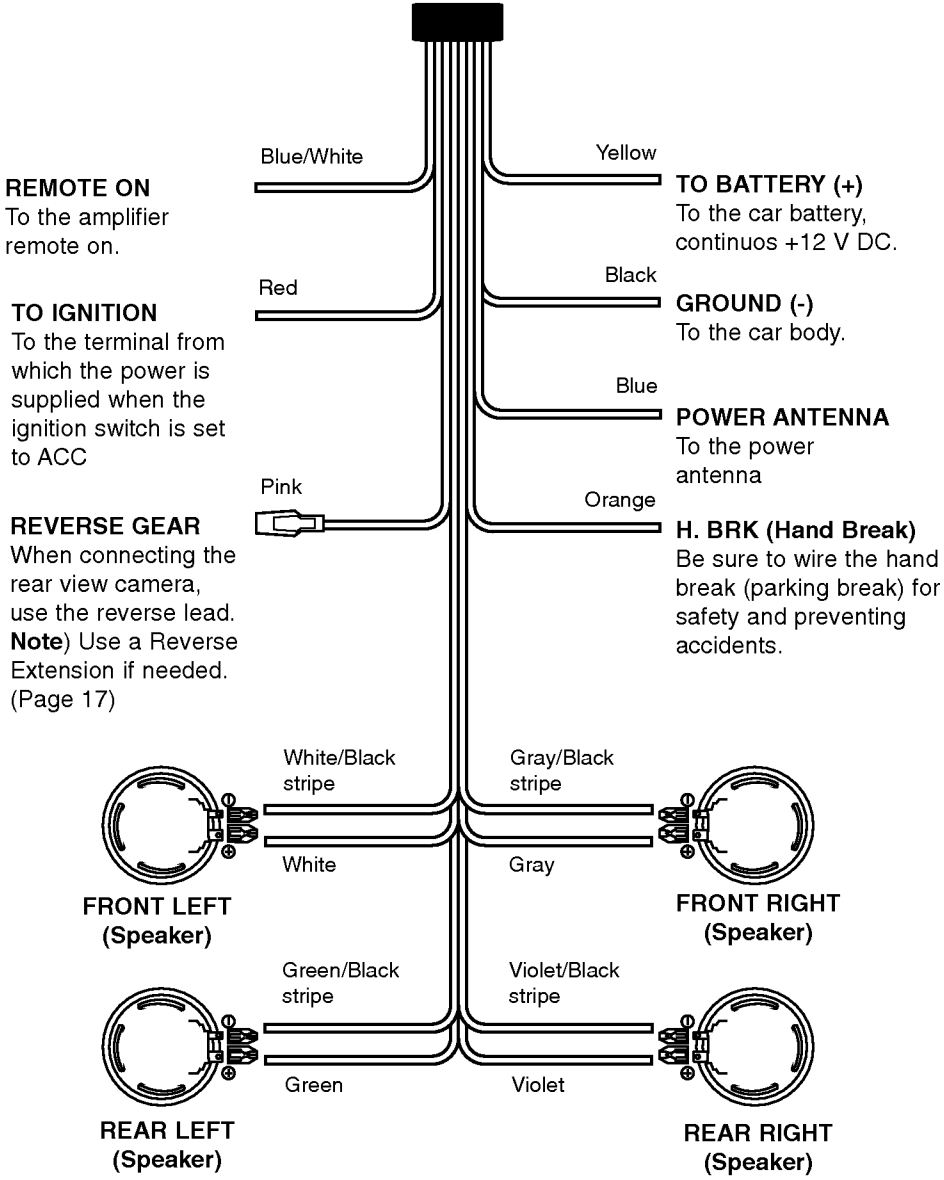

Basic operation

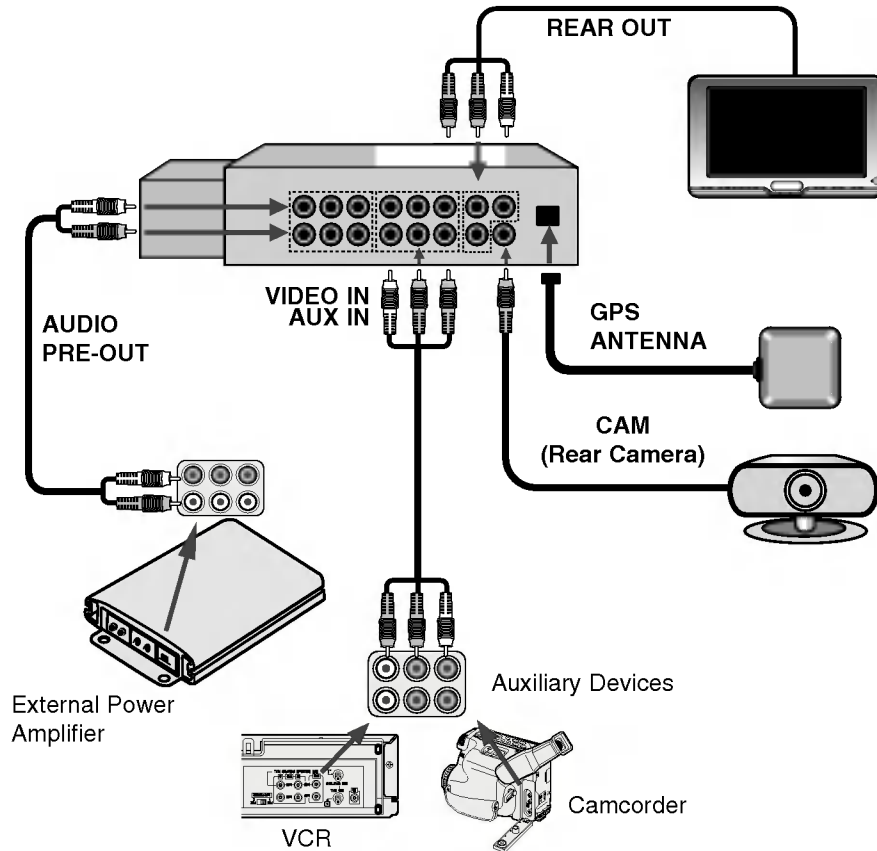

Basic operation

● When installing the antenna inside the vehicle (on the dashboard or shelf)

Affix the metallic sheet on as level a surface as possible where the GPS aerial faces outside the window. Place the GPS aerial on the metallic sheet. (The GPS aerial is fastened with its magnet.)

✦ Note

- Make sure the surface is free of moisture, dust, grime, oil, etc., before affixing the metallic sheet.
- The metallic sheet contains a strong adhesive and may leave a mark on the dashboard if it is removed.
- Some models use a window glass that does not allow signals from GPS satellites to pass through. On such models, install the GPS aerial on the outside of the vehicle.

● When installing the antenna outside of the vehicle (on the body)

Put the GPS aerial in a position as level as possible, such as on the roof or boot lid.

● When routing the lead in from the top of the door

Make a U-shaped loop in the lead on the outside to prevent rainwater from flowing along the lead into the interior of the vehicle.

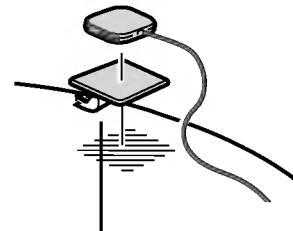

Peel off the protective sheet on the rear.

● Connecting the Reverse Gear

If using an optional rear view camera, the reverse lead must be connected.

1. Clamp the reversing lamp lead.
2. Clamp firmly with needle-nosed pliers.

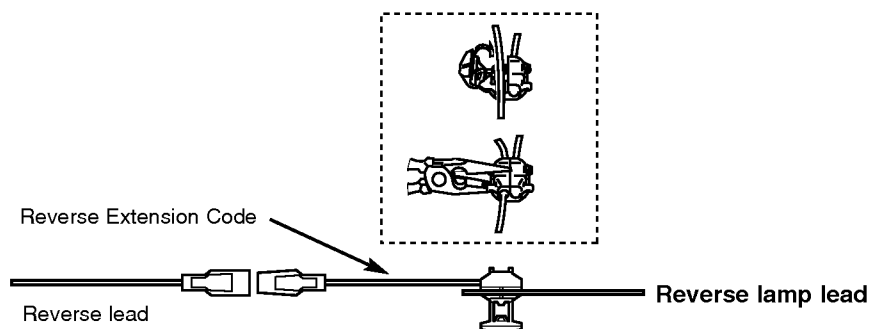

Basic operation

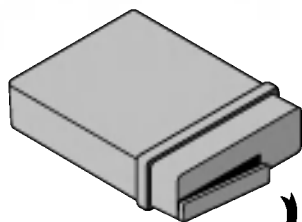

Protective Case

Detaching the control panel

You can detach the control panel when leaving the car. When detaching or attaching the control panel, be careful not to damage the connectors on the back of the control panel and on the panel holder.

1. Press the “▲” button to unlock the control panel.
2. Pull the control panel out of the unit.
3. Put the detached control panel into the provided case.

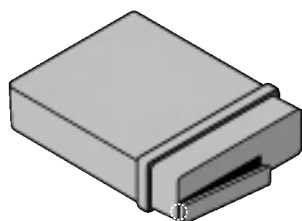

Attaching the control panel

1. Insert the left side of control panel into the groove on the panel holder.
2. Press the right side of control panel to fix it to the panel holder.

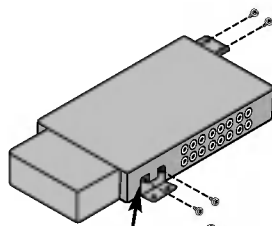

Round Head Screw

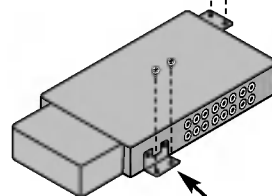

Tapping screws

Installing the hide-away unit (Under the front seat)

Be sure to use the tapping screws of appropriate length so that they will not damage any parts of car.

Basic operation

Basic installation

Before installing, make sure that the ignition-switch is set to OFF and remove the terminal of the car battery to avoid short-circuiting.

1. Remove the existing receiver unit.
2. Make the necessary connections.
3. Install the installation sleeve.
4. Install the unit into the installation sleeve.

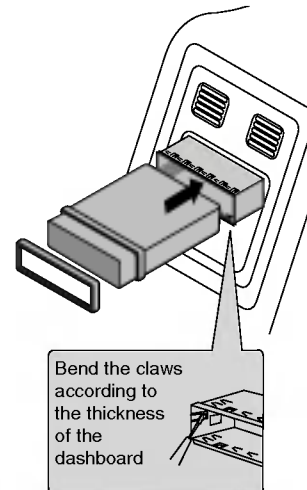

Removing the existing receiver unit.

If there is already an installation sleeve for the receiver unit in the dashboard, it must be removed.

1. Remove the rear support from the unit.
2. Remove the front panel and trim ring from the unit.
3. Insert the lever **A** into the hole on one side of the unit. Perform the same operation on the other side and pull the unit out from the mounting sleeve.

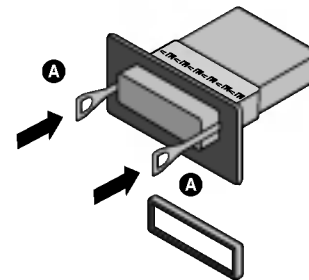

ISO-DIN Installation

1. Slide the unit into the ISO-DIN frame.
2. Install screws removed from the old unit.
3. Slide the unit and frame into the dash opening.
4. Install the dash panel or adapter plate.
5. Install the trim ring to the unit.

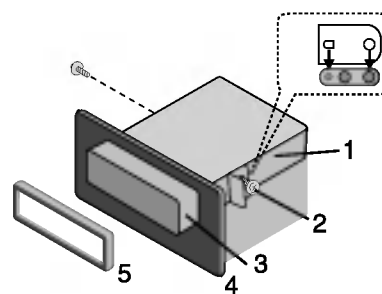

Basic operation



Turning the unit on

Press any buttons. (Except DISP or EJECT buttons)

Turning the unit off

Press and hold the "VOL" button.



Opening / Closing the LCD

Press the "OPEN/CLOSE" button.
The LCD panel will be opened or closed.

Note

The LCD panel will be closed automatically with turning the power off.



Changing the monitor angle

Press the "TILT" button to adjust the LCD panel to an easily viewable angle.
Each time you press the button, the LCD panel changes its angle step by step.

Note

The adjusted LCD panel angle will be memorized and the monitor panel will automatically return to this angle next time the monitor panel is opened.



Turning the LCD panel horizontal

Press the "FLIP" button.
When the LCD panel is upright and hinders the operation of the air conditioner, the position of the panel can be turned horizontal temporarily.
To return to the original position, press the "FLIP" button again.

Note

The LCD panel returns to the original position automatically with beep sounds in 10 seconds after operation.

Inserting a disc

The disc is drawn in and playback starts automatically.

Basic operation

Ejecting a disc

Press the "EJECT" button.
The disc is ejected from the loading slot.

★ Note

If the ejected disc is not removed in approximately 10 seconds, the disc is automatically inserted again into the loading slot.



Adjusting the volume

Rotate the "VOL" knob to adjust the sound level.

★ Note

When you turn the unit off, the current volume level is automatically memorized. Whenever you turn the unit back on, it will operate at the memorized volume level.



Mute (To drop the volume in a moment)

Press the "VOL" knob while listening to any source.
To resume the previous volume level, press the button again.

Selecting a source

Press the "SRC" button repeatedly to select a source.
The mode switches as follows.

FM → CD → VIDEO → AUX

You cannot use a source if it is not ready.



Selecting a EQ (Equalizer)

Press the "EQ" button repeatedly to select an equalizer.
The mode switches as follows.

FLAT → POP → CLASSIC → ROCK → JAZZ → VOCAL
→ SALSA → SAMBA → USER → WOW

- POP : Optimized for R&B, Soul and Country music.
- CLASSIC : Optimized for orchestral music.
- ROCK : Optimized for Hard Rock and Heavy Metal.
- JAZZ : Sweet sound with soft feeling.
- VOCAL : Powerful realism with strong sound quality.
- SALSA : Reproduces salsa music acoustics.
- SAMBA : Reproduces samba music acoustics.
- USER : Use the menu to set the sound level you want.
- WOW : Enjoy the SRS and TruBass simultaneously.

★ Notes

-  is a trademark of the SRS Labs, Inc.
- WOW technology is incorporated under license of the SRS Labs, Inc.



Dual mode operation

Using a display connected to REAR OUT

You can play back two different sources as main source and secondary source.

You can listen to the main source through the speakers, and to the secondary source through the monitor inserted into the cradle or the one connected the REAR OUT jacks.



Selecting a source

Press the "RSE" button repeatedly to select a source. The mode switches as follows.

RSE DVD → RSE USB → RSE VIDEO → RSE AUX

- RSE DVD
You can select the built-in DVD drive.
- RSE USB
You can select the built-in USB.
- RSE VIDEO
You can select the component connected to the VIDEO IN jacks.
- RSE AUX
You can select the component connected to the AUX IN jacks.

Note

You cannot use a source if it is not ready.

Canceling the dual mode

Press and hold the "RSE" button.

RSE OFF appears.

About rear camera view

With an optional rear view camera, you are able to use this product as an aid to keep an eye on trailers or backing into a tight parking spot.

Notes

- When you connect the video camera as a rear view camera to the REAR OUT CAM jack to guide you the car.
- When the vehicle's gearstick is reverse(R), you can see what is behind the vehicle connecting a rear view camera.

Setup operation

SETUP

You customize the various options according to your particular needs.

Touch the "SETUP" button.

The setup screen appears on the screen.



SCREEN

● Language

You can set the display language.

Touch the language button you want.



● Setback

You can move the LCD panel a little forward or backward.

- Yes : Activates the functions.
- No : Cancels the functions.

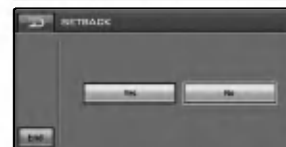

● Adjust Picture

Brightness

You can set the monitor brightness.

Touch the ◀ or ▶ buttons to adjust the settings.

Contrast

You can set the monitor contrast.

Touch the ◀ or ▶ buttons to adjust the settings.



● Adjust Dimmer

Auto Dimmer control

The dimmer adjustments for daytime, evening, and nighttime ambient lights are stored separately.

The brightness of LCD screen adjusts automatically to the optimum level in accordance with the ambient light based on the set values.

- Yes : Activates the functions.
- No : Cancels the functions.



✦ Note

Touch the  button to exit the current screen to previous screen

Setup operation



● Display

Turn by Turn on AV

Set whether to display the guidance information using the arrow on the audio/video operation screen.

- On : Display guidance information using the arrow on the audio operation screen.
- Off : Do not display guidance information using the arrow on the audio operation screen.

Color

You can set the background color of map.

- Day : Always use to day-driving background color.
- Night : Always use night-driving background color.
- Auto : Automatic switch to night-driving background when headlights are switched on.



● BG Animation

You can select one of 5 modes. It displays the change of sound output during play.

Touch the image button you want.

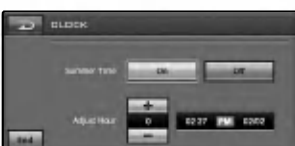

● Clock

You can set the summer time.

Summer time

- On : Activates the functions.
- Off : Cancels the functions.

Adjust Hour

Touch the + or - buttons to adjust the settings (-1~3).



● Rear Camera

- On : The rear view through the rear view camera is automatically displayed on the monitor when the rear gear is applied.
- Off : Cancels the function.

✦ Note

Touch the  button to exit the current screen to previous screen

Setup operation

SOUND

● Balance/Fader

1. Touch the “Left” or “Right” button.
Adjust the balance—speaker output balance between the left and right speakers.
2. Touch the “Front” or “Rear” button.
Adjust fader—speaker output balance between the front and rear speakers.



● Woofer

Output Level

Touch the ◀ or ▶ buttons to select the output level.

Cut-off Frequency

Frequencies 80/120/160 Hz are sent to the subwoofer. The cut-off frequency is chosen according to the Woofer setting so that you can enjoy low frequency effects purely from the subwoofer if it is connected.

Off : Cancels the functions.



● SRS WOW

You can set the various 3D sound effects (1~10).

Touch the ◀ or ▶ buttons to adjust settings.

- SRS : Enjoy SRS and TruBass simultaneously.
- FOCUS : Improve the resolution sound.
- TruBass : Improve the bass sound to make it spectacular.



✦ Notes

- is a trademark of the SRS Labs, Inc.
- WOW technology is incorporated under license of the SRS Labs, Inc.

● User Equalizer

You can adjust the sound modes and store your own adjustments in memory.

Touch the ▲ or ▼ buttons to adjust the level of each frequency band.



● High Pass Filter

Outputs all frequencies higher than selected according to your preference.



Setup operation



- **Rear Speaker**
On : Select this to turn on the rear speaker output.
Off : Cancels the function.



- **Beep**
Beep Pattern
 - Long Key : When long pressed, a beep sound occurs.
 - All : When any button is pressed, a beep sound occurs.**Beep Volume**
Adjust the Beep Volume. (HIGH/MEDIUM/LOW)



DVD



- **DVD Language**
Audio Language
If the disc contains multi-audio languages, you can change to a different audio.

Subtitle Language

If the disc contains multi-subtitle languages, you can change to a different subtitle language.
To erase the subtitle, select the "Off" button.

Menu Language

If the disc contains multi-menu languages, you can change to a different menu language.

Other

If the language you want is not listed in language menu list.
See page 84 to find the language code.



- Confirm the entered code.
- Keypad button.
- Delete the previous character at the cursor position.
- Cancels the functions.

Setup operation

● Aspect Ratio

Select the monitor type of your unit to play a DVD recorded with an aspect ratio of 16:9.

Wide

Select when your screen's aspect ratio is fixed at 16:9 (Wide screen).

Letter Box

Select when your screen's aspect ratio is fixed at 4:3 (Conventional screen). While viewing a wide screen picture, the black bars appear on the top and the bottom of screen.

Panscan

Select when your screen's aspect ratio is fixed at 4:3. While viewing a wide screen picture, the black bars do not appear. The left and right edges of the pictures will not be shown on the screen.



● Lock

You can secure the device against unauthorized use by assigning a password. In addition, you can specify a rating level. If you set a rating level that is lower than the one found on the inserted DVD, it can be played only after entering the password.

If you have already assigned a password, first enter the old password with the number buttons 0-9.

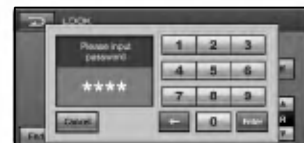

Defining the parental control

Select the desired age-appropriate release 1-8.

To erase the desired age-appropriate release, select the "Off" button.



✦ Notes

- Rating level means that some DVDs are equipped with a code that defines the age-appropriate release.
- If you have not yet assigned a password, the present password is 0000.
- If you forget your password.
Input the 6-digit number "210499" and the password is cleared.

Setup operation



Changing the password

1. Touch the "Password" button.
2. Enter the new password with the number buttons 0-9.
3. Confirm the new password with the number buttons 0-9.
4. Touch the "Enter" button to reset the password to the newly assigned one.

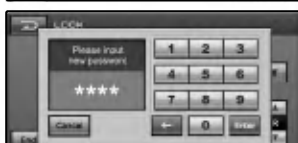

Changing the area code

1. Touch the ▲ or ▼ buttons to select the area code.
See page 84 to find the area code.
2. Touch the "END" button to exit the setup menu.

Notes

- If you have not yet assigned a password, the present password is 0000.
- Do not forget your password. A new password cannot be set without your old password.



DivX Registration

We provide you with the DivX® VOD (Video On Demand) registration code that allows you to rent and purchase videos using the DivX® VOD service.

For more information, visit www.divx.com/vod.

Use the registration code to purchase or rent the videos from the DivX® VOD service at www.divx.com/vod.

Follow the instructions and download the video onto a disc for playback on this unit.

Setup operation

RDS

● TA Mode

TA Seek

When the newly tuned station does not receive TP information for 5 seconds, the receiver returns to the next station which has the same TP information as well as the same PI as the last station.

TA Alarm

When a newly tuned station has no TP information for 5 seconds, a double beep sound is output.

● PI Mode

PI Mute

If the sound of a station with different PI is heard intermittently, the receiver mutes the sound right now.

PI Sound

If the sound of a station with different PI is heard intermittently, the receiver mutes the sound after 1 second.



SOURCE

You can select the source on the screen to make it operate according to your particular needs.

Touch the "SOURCE" button.

The source screen displays on the screen.

You cannot use a source if it is not ready.

- FM/MW : You can select the radio stations.
- DVD / CD : You can select the built-in DVD drive.
- SET UP : You can select the SET UP menu.
- USB : You can select the inserted USB.
- VIDEO IN : You can select the component connected to the VIDEO IN jacks.
- AUX : You can select the component connected to the AUX IN jacks.
- SOURCE OFF : You can see the current time. Touch the "SRC" button in the front panel to return the previous screen.



Bluetooth operation



Using a Bluetooth wireless connection.

Your unit supports Bluetooth wireless connections. You can set up a wireless link with a Bluetooth phone.

Starting Bluetooth on your phone.

Your phone's Bluetooth feature may be set to off by default. To use your car Bluetooth feature, Bluetooth must be turned on in your phone. - Please see page 85 for details.

Notes

- Refer to your phone's user guide.
- Due to the variety of Bluetooth phones and their firmware version, LAN-9600R may respond differently when performing over Bluetooth
- If even a phone as described in this list meets requirements of Bluetooth Hand-free Profile 1.0 and Object Push Profile 1.1, it can operate. However, it is noted that we cannot assure for operation by function.
- As difference in functional operation by model is mainly resulted from feature of a hand-free phone, consult manufacturer of a phone if you have any question.

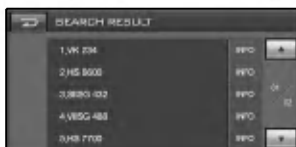
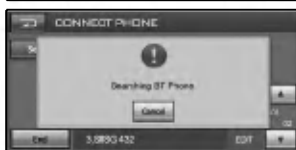
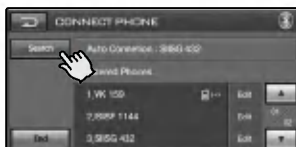

Pairing your unit and Bluetooth phone.

• Connection through the unit

1. Press the PHONE button to select the phone.
2. Touch the  button.
The "SETUP" screen displays on the screen.
3. Touch the "Connect Phone" button.
The "CONNECT PHONE" screen appears on the screen.
4. Touch the "Search" button.
The "Searching" pop-up screen appears on the screen. It will take about 20 seconds, to continue the process. To cancel, touch the "CANCEL" button.
5. Select a Bluetooth phone you desire from the "SEARCH RESULT".

Notes



- During the settings for Bluetooth phone, make sure to select "visible to all devices" from Visibility. Otherwise, it cannot search Bluetooth phones.
- The successfully connected mobile phone will be registered in the "CONNECT PHONE" screen. Once registered, the phone can be connected without searching.

Bluetooth operation

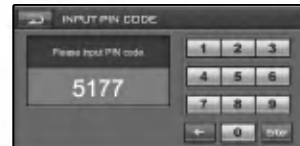
6. In an initial connection, the user will see the "INPUT PIN CODE" screen as shown in the figure.
To successfully connect, make sure to enter the same PIN code for Bluetooth phone and the unit.
7. Touch the number 0~9 buttons, then confirm.
8. Touch the "Enter" button to complete the pairing .
9. If the connection is successful, the Bluetooth phone is registered. The user can confirm it with the  checking mark in the "CONNECT PHONE" screen.



✦ Notes

- When the connection is successful,  icon will be displayed on the upper right side of the "PHONE" screen.
-  icon is displayed with hands-free connection. Refer to "Headset functionality" for headset connections.



- Icon for hands-free connection.

- Icon for headset connection.

● Auto connection

1. Bluetooth phone with a previous record showing that it has successfully connected will automatically start the connection process when starting the car.
2. Auto connection functionality operates if there is a registered Bluetooth phone in the "CONNECT PHONE" screen and the "Auto Connection" is selected on the "INFORMATION" screen.
- Please see page 33 for details.

Bluetooth operation

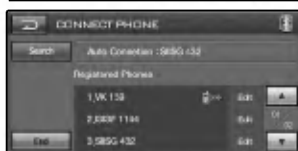

● Connection through a bluetooth phone

Refer to your phone's user guide.

1. Press the PHONE button to select the phone.
2. Touch the  button.
The "SETUP" screen appears on the screen.
3. Touch the "Connect Phone" button.
The "CONNECT PHONE" screen appears on the screen.
The Bluetooth phones can be found (searched) only on the "CONNECT PHONE" screen.
4. Perform "Searching a Bluetooth device" in the Bluetooth phone.
5. Initiate the pairing and connection process on the LAN-9600R searched.
6. In an initial connection, the user will see the "INPUT PIN CODE" screen.

✦ Notes

- To successfully connect, make sure to enter the same PIN code for Bluetooth phone and LAN-9600R.
- The same instructions as "connecting through the unit" apply correspondingly to the following.



Headset functionality

The connection method is the same as "Hands-free connection", but  icon is displayed on the upper right side of the "PHONE" screen right after connected.

- It works the same as the wired headset for mobile phone.
The headset functionality is for telephone conversation. It is not for listening to music.
- Unlike the hands-free functionality, Headset connection will allow only two functions "answering calls" and "making a call from the latest call".
Also the caller's number is not displayed when answering calls.

✦ Notes

- If connecting through LAN-9600R, initiate the hands-free connection first. If your Bluetooth phone does not support the hands-free connection, then initiate the headset connection.
- If connecting through a Bluetooth phone, the hands-free connection or headset connection may not operate depending on the type of the phone.

Bluetooth operation

SETUP

- **Connect Phone**
You can check the connected Bluetooth phone.
- **BT Information. (Bluetooth Information)**
You can check the Bluetooth phone information.



CONNECT PHONE

- **Search**
Enter a part of registration number or letter to search a contacts entry you want.
- Please see page 34 for details (BT Info.).
- **Edit**
You shows the "INFORMATION" screen.
(Pop-up screen displays in the screen.)
- **Info. (Information)**
The "INFORMATION" screen appears on the screen.
- **Delete**
You can delete the selected list.
- **Cancel**
Cancels the functions.





INFORMATION (CONNECT PHONE)

- **Auto Connection**
Bluetooth phone can be automatically connected, if there is a registered Bluetooth phone in the "CONNECT PHONE" screen and the "Auto Connection" is selected on the "INFORMATION" screen.
- **Manual Connection**
Bluetooth phone can be manually connected using the the function, if there is a registered Bluetooth phone in the "CONNECT PHONE" screen and the "Manual Connection" is selected on the "INFORMATION" screen.
In these cases, you would try to connect from the registered list at "CONNECT PHONE".



Notes

- Touch the  button in the current screen to exit previous screen.
- A maximum of 6 Bluetooth phones can be registered at one time.
- Touch the  or  buttons to select the list you want to view.

Bluetooth operation

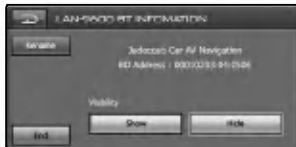

BT Info. (Bluetooth Information)

You can check the Bluetooth phone information.

- **Name**
You can rename the Bluetooth phone name.
- **End**
Exit previous screen.
- **Show/Hide**
You can select whether bluetooth phones are able to search the LAN-9600R or not.



- Enter name is displayed
- Keypad button
- Confirm the entered name
- Changes between number and symbol lists
- Inserts a space at the cursor position
- Delete the previous character at the cursor position
- Erase all entered character

Note

Touch the  button in the current screen to exit previous screen.



PHONE BOOK

You can view all entry's numbers by Phone, Home, Office.



- **Search**
Enter a part of registration number or letter to search a contacts entry you want.
- Please see page 34 for details (BT Info.).
- **Add**
You can copy the phone book entries are supplied on the memory of phone to the unit.
 1. The "waiting..." screen displays on the screen.
 2. When you choose "Telephone No. Item Transmission" in the bluetooth phone, you can search LAN-9600R.
(The bluetooth phone control method may differ according to the manufacturer. Refer to the Owner's manual.)
 3. Press "Sending the phone number" in Bluetooth phone.
 4. The telephone number is transmitted to the LAN-9600R from the Bluetooth phone.

Bluetooth operation

- **Delete All**

You can delete all the list.

- **Edit**

You can display the "INFORMATION" screen.
(Pop-up screen appears on the screen.)

- ✦ **Note**

If the hands-free or headset connection has already been made, disconnect the corresponding connection to add a new contacts entry.



Bluetooth operation

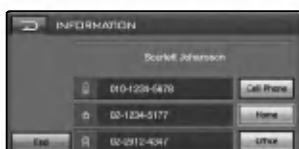

INFORMATION (PHONE BOOK)

You can view all entry's numbers or select which phone number is dialed when you default dial the phone book entries. (If the entry has more than one phone number.) From this screen, you can make a call as displayed here and set up a calling number.

Note

When connecting to a phone, the hands-free connection should be made already.



Making a call

There are different ways to make calls with this unit. To make a call by entering numbers on your number buttons.

1. Enter the phone number you want to call, by touching the number buttons.
2. Touch the "SEND" button to make a call to the entered phone number.
3. When you are finished, touch the "END" button.

Notes

- Touch the "SEND" button for long to make a call from a latest call.
- The user's recent call history applies only to the hands-free connection. (Making a call from a recent call with the headset connection depends on the call history of the Bluetooth phone.)
- The headset connection allows only making a call from a recent call.



Making a call with speed dial numbers

To make a call from a speed dial numbers, press "SEND" for a long after pressing the speed dial number assigned to the Bluetooth phone, or press the last digit of the speed dial number for long.

- When making a call from the speed dial number 10, press 10 and press "SEND" button for long.)
- When making a call from the speed dial number 10, press 1 and press 0 for long.)

Note

Make sure that the speed dial functionality in the Bluetooth phone is enabled before using.

Bluetooth operation

Answering calls

When you receive a call, your phone rings and display an incoming call message.

1. The “CALL FROM” screen appears on the screen.
2. Touch the “Accept” button to answer the call.
If you want to reject a call, touch the “Reject” button.



Notes

- If the Call-ID service is available, the caller's phone number is displayed.
- If the phone number is in the phone book, phone book entry's name is display.
- If the incoming call is from a number stored in your Contacts, the entry's name is displayed. The caller's phone number may also be displayed, if available.
- If “Rejecting” function is unusable, then the phone connected to the device does not support the rejecting calls function.



Making a call from recent calls

Your unit keeps a record of your recently received and dialed calls.

Touch and hold the “SEND” button.



Changing between car speaker and Bluetooth phone during a call ↔

When you turn the car speaker on, your unit displays the  button in the screen. The car speaker remains on until you press the  button.

Note

If you make a mistake while dialing, touch the  button to erase one digit at a time.

Radio (RDS) operation



Listening to the radio stations

1. Press the "SRC" button to select the radio.
2. Press the "BAND" repeatedly to select a band.
The mode switches as follows.
FM1 → FM2 → FM3 → MW
3. **Seek tuning :**
Touch the ◀◀ or ▶▶ buttons.
The tuner will scan the frequencies until a broadcast with strong enough signal is found.

Manual tuning :

Touch the ◀ or ▶ buttons repeatedly until a preset number you want is selected.



AS (Auto search memory)

This function lets you automatically store the 6 strongest broadcast frequencies.

1. Select the band (FM1, FM2, FM3, MW) you want to store a station into.
2. Touch the "AS" button.
Local stations with the strongest signals are searched and stored automatically in the selected radio band.
3. To cancel, touch it again.

Storing and recalling stations.

You can easily store up to 6 preset stations for later recall at the touch of a button.

1. Select the band (FM1, FM2, FM3, MW) you want to store a station into.
2. Touch the ◀◀ or ▶▶ buttons to select the desired frequency.
3. Touch one of the number buttons (1-6).
The preset station information will be displayed.
The selected preset station has been stored in memory.
4. Repeat steps 2 and 3 to preset other stations.
Next time, if you touch the number button (1-6), the station is recalled from the memory.

✦ Notes

- As FM1, FM2, FM3 have the same frequency range, up to 18 stations can be preset for FM.
- When a station is preset on the preset station button number on which another station of the same band has already been preset, the previously preset station is automatically erased.

Radio (RDS) operation

RDS display options

The RDS system is capable of transmitting a wide variety of information in addition to the initial call sign that appears when a station is first tuned. In normal RDS operation the display will indicate the station name, broadcast network or call letters.



- **AF** (Alternative Frequencies for the actual program)
- **TA** (Traffic Announcement Identification)
- **PTY** (Program type recognition)
- **RT** (Radio text recognition)
- **PS** (Program Service name)
- **PI** (Program Identification) : contains additional information for regional program operation
- **TP** (Traffic Program Identification)

AF (Alternative frequency)

When the reception quality drops, the tuner automatically changes to another station in the network, broadcasting a better reception quality, using the PI and AF codes.

This means : wherever you drive, you can continue to listen to the same program without interruptions.

1. Touch the "AF" button.
"AF ON" appears on the screen.
2. To cancel, touch it again.

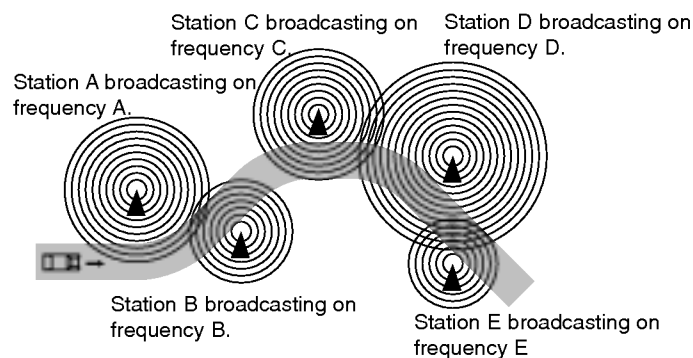

Radio (RDS) operation



TA (Traffic announcement identification)

This is an ON/OFF switching signal that indicates when a traffic announcement is on air.

1. Touch the "TA" button.
The "TA ON" appears on the screen.
2. To cancel, touch it again.

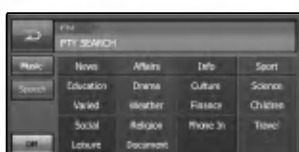

PTY (Program type recognition)

You can select your favorite program type.

1. Touch the "PTY" button.
2. The PTY list displays in the screen.
3. Touch one of your favorite program types.
(Music or Speech)
4. Touch one of your favorite PTY code name.
5. "PTY SEARCH" appears on the screen.
6. To cancel, touch "Off" button.



REGION

1. Touch the "Region" button.
The "ON" appears on the screen.
2. To cancel, touch it again.

ON : Network-Tracking is activated.

The unit switches to another station, within the same network, broadcasting the same program when the receiving signals from the current station become weak.

OFF : Network-Tracking is deactivated.

The unit switches to another station, within the same network when the receiving signals from the current station become weak. (In the mode, the program may differ from the one currently received.)

Notes

- RDS is only available for FM reception.
- In some areas, the PTY search will not work correctly.
- Touch the  button in current screen to exit the previous screen.

Radio (RDS) operation

R-TEXT (Radio text recognition)

The radio station's information is displayed on the screen.

1. Touch the "R-Text" button.
Radio text appears on the screen.
2. To cancel, touch it again.



Note

Some RDS stations may not choose to include some of these additional features. If the data required for the selected mode is not being transmitted, the screen will show a "Radio Text Information" message.

CD/MP3/WMA operation



Playing an audio CD and MP3/WMA disc

The disc is drawn in and play starts automatically.

Notes

- The unit can play MP3/WMA formatted recordings on CD-ROM, CD-R or CD-RW (DVD-ROM, DVD-R, DVD+R, DVD-RW, DVD+RW) discs.
- MP3/WMA Disc compatibility with this unit is limited as follows:
 1. Sampling Frequency / 16 - 48 kHz (MP3) 8 - 44.1 kHz (WMA)
 2. Bit rate / within 8 - 320 kbps (include VBR) (MP3) 5 -160 kbps (WMA)
 3. CD-R/CD-RW physical format should be "ISO 9660"
 4. If you record MP3/WMA files using software which cannot create a FILE SYSTEM, for example "Direct-CD" etc., it will not be possible to playback MP3/WMA files.
We recommend that you use "Easy-CD Creator" which creates an ISO9660 file system.
Customers should also note that permission is required in order to download MP3/WMA files and music from the Internet. Our company has no right to grant such permission. Permission should always be sought from the copyright owner.

Skip to the next track/file

Touch briefly the ►►I button to select the next track.

Skip to the previous track/file

Touch briefly the I◄◄ button within 3 seconds of playing time.

Return to the beginning of the current track/file

Touch briefly the I◄◄ button after 4 seconds of playing time.

Search

Touch and hold the ◄◄ or ►► buttons during playback and then release at the point you want.

Skip to the previous folder/next folder

This functions only for **MP3** **WMA**.

Touch briefly the ◄ or ► buttons to select the previous folder/the next folder.

CD/MP3/WMA operation

Locating a folder/file using the list

You can display the folder list/track list before starting to play.

This is available only for **MP3** **WMA**.

1. Touch the “LIST” button during playback.
2. Touch the folder button you want.
3. Touch the file you want. The file will be played.

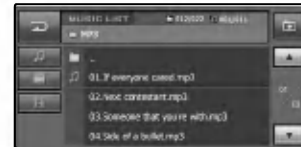

- Touch the button to select upper folder.
- Touch the button in current screen to exit previous screen
- Touch the or buttons to select the list you want to view.
 : Previous/Next page of the list.
- If you want to classify by kind, press the , or buttons.

REPEAT

Touch the “Repeat” button during playback.

The item changes as follow.

OFF → TRACK... **CD**

OFF → ONE → FOLDER... **MP3** **WMA**

- TRACK : Plays repeatedly the current track.
- ONE : Plays repeatedly the current file.
- FOLDER : Plays repeatedly all tracks of the current folder.
- OFF : Cancels repeat play.



SHUFFLE

Touch the “Shuffle” button during playback.

The item changes as follow.

OFF → ON... **CD**

OFF → FOLDER... **MP3** **WMA**

- ON : Plays all files randomly on the disc.
- FOLDER : Plays all files randomly on the current folder.
- OFF : Cancels SHUFFLE play.

SCAN

Touch the “Scan” button during playback.

The item changes as follow.

OFF → ON... **CD**

- ON : Plays the first 10 seconds of all tracks on the disc.
- OFF : Cancels scan play.

CD/MP3/WMA operation



INFORMATION

Touch the “Information” button during playback.

When playing a disc containing information, you can see the CD TEXT/ID3 TAG information.

In a CD TEXT, some information about the disc (disc title, performer and track title) is recorded.

In a ID3 TAG, some information about the file (album title, Performer name, song title, recording year, music genre and a brief comment)is recorded.

This unit can show ID3 TAG (artist name, title name, album name).

DVD/VCD operation

Playing a DVD/VCD disc

The disc is drawn in, and “Disc reading” appears on the display window, and playback starts automatically. If playback does not start, press the ► button.

✦ Notes

- It takes several seconds for the unit to detect a disc type.
- In some cases, the disc menu might appear instead.
- If “⏏” appears on the screen, the disc cannot accept the operation you have tried.
- DVDs may have a region code.
Your unit will not play which discs have a region code different from your unit. The region code for this unit is “2”
- When VCD with PBC is detected, the PBC indicator appears on the screen.



If menu screen is displayed

A menu screen may be displayed first after loading a DVD or Video 2.0 offering a menu.

This is available only for **DVD**.

1. Touch the ◀, ▶, ▲ or ▼ buttons to select the title/chapter you want to view.

- ◀ ▶ : Move a cursor to up or down.
- ▲ ▼ : Move a cursor to left or right.
- ⬆ ⬇ : Move a menu bar to up or down.
- Enter : Enter to sub menu.
- ⏏ : Cancels the functions.

2. Touch the “ENTER” button to start playback.



This is available only for **VCD**.

1. Touch the number 0~9 buttons, then confirm.

- ⬆ ⬇ : Move a menu bar to up or down.
- ⏏ : Return to the previous screen.
- ⏏ : Cancels the functions.
- Enter : Enter to sub menu.

2. Touch the “ENTER” button to start playback.



DVD/VCD operation



Play

Touch the ► button to start playback.

Stop

Touch the ■ button to stop.

Pause

1. Touch the || button during playback.
2. To return to playback, press the ► button.



Skip to the next chapter/track

Touch briefly the ►| button to select the next chapter/track.

Skip to the previous chapter/track

Touch briefly the |◀◀ button within 3 seconds of playing time.

Return to the beginning of the current chapter/track

Touch briefly the |◀◀ button after 4 seconds of playing time.

Search

Touch the ◀◀ or ►► buttons repeatedly to select the required speed (X2, X4, X8, X16, X100).

✦ Notes

- With a VCD, the Search speed changes : (X2, X4, X8, X16)
- To return to the normal speed, press the ► button.

MENU **DVD** / VCD MENU **VCD**

The menu may contain camera angles, spoken language, subtitle options and chapters for the title.





1. Touch the screen during playback.
The setup screen displays on the screen.
2. Touch the "MENU (VCD MENU)" button.
3. Touch the ▲, ▼, ◀ or ► button to select a title you want.
4. Touch the "ENTER" button to start playback.
ENTER : Enter to sub menu / Playback.



DVD/VCD operation

SEARCH

Use the number buttons to select the chapter or title you want to view.

1. Touch the screen during playback.
The setup screen displays on the screen.
2. Touch the "Search" button.
The number screen displays on the screen.
3. Touch the number 0~9 buttons, then confirm.
 -   : Move a cursor to the desired information point. (TITLE/CHAPTER/TIME)
 -  : Delete the inputted number(s).
 -  : Enter to sub menu.
4. Touch the "ENTER" button.



AUDIO

This is available only for .

Touch the "Audio" button during playback.

If the disc contains multi-audio languages, you can change to a different audio language during playback.

SUBTITLE

This is available only for .

Touch the "Subtitle" button during playback.

If the disc contains multi-subtitle languages, you can change to a different subtitle language during playback.

ANGLE

This is available only for .

Touch the "Angle" button during playback.

If the disc contains multi-angle views, you can change to a different camera angle during playback.

DVD/VCD operation



REPEAT

Touch the "REPEAT" button during playback.
The menu item changes as follows.

OFF → CHAPTER → TITLE... **DVD**

OFF → TRACK → ALL... **VCD**

- CHAPTER : Plays repeatedly the current chapter.
- TITLE : Plays repeatedly the current title.
- TRACK : Plays repeatedly the current track.
- ALL : Plays repeatedly all files on the current disc.
- OFF : Cancels repeat play.

Note

If you change the source, turn the power off or eject the disc.
Next time you select the DVD/CD player as the source or turn the power on, disc play back starts from where playback stopped previously.

Using

This is available only for **DVD**.

It is the function to use at the appears requiring menu selection, while playing DVDs.

(The various playing displays are required at the recorded DVD title during playing.)

The menu screen appears on the screen.

Please see page 46 for details.

DivX operation

Playing a DivX disc

The disc is drawn in, and "Disc reading" appears on the display window, and playback starts automatically. If playback does not start, press the ► button.

Notes

DivX disc compatibility with this player is limited as follows:

- Available resolution size of the DivX file is under 720x576 (W x H) pixels.
- The file name of the DivX subtitle has a length of 40 characters.
- If there is impossible code to express in the DivX file, it may be displayed as " _ " mark on the display.
- If the number of the screen frame is over 30 per 1 second, this unit may not operate normally.
- If the video and audio structure of recorded file is not interleaved, either video or audio is output.
- Playable DivX file : .avi, .mpg, .mpeg
- Playable Subtitle format
 - SubRip(*.srt/*.txt)
 - SAMI(*.smi)
 - SubStation Alpha(*.ssa/*.txt)
 - MicroDVD(*.sub/*.txt)
 - SubViewer 1.0(*.sub)
 - SubViewer 2.0(*.sub/*.txt)
 - TMPlayer(*.txt)
- Playable Codec format
"DIVX3.xx", "DIVX4.xx", "DIVX5.xx", "XVID", "MP43", "3IVX".
- Playable Audio format
"Dolby Digital", "PCM", "MP3", "DTS"
 - Sampling frequency: within 8 - 48 kHz (MP3),
 - Bit rate: within 8 - 320kbps (MP3)



DivX operation



Play

Touch the ► button to start playback.

Stop

Touch the ■ button to stop.

Pause

1. Touch the || button during playback.
2. To return to playback, press the ► button.

Skip to the next file

Touch briefly the ►| button to select the next file.

Skip to the previous file

Touch briefly the |◀ button.

Search

Touch the ◀◀ or ▶▶ buttons repeatedly to select the required speed (X2, X4, X8, X16).

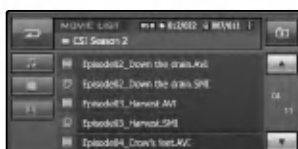

Locating a folder/file using the list

You can display the folder list/file list before starting play.

1. Touch the "LIST" button during playback.
 2. Touch the folder button you want.
 3. Touch the file you want.
The file will be played.
- Touch the [Folder] button to select upper folder.
 - Touch the [Back] button in the current screen to exit previous screen.
 - Touch the [Left] or [Right] buttons to select the list you want to view.
[Left] [Right] : Previous/Next page of the list.
 - When you want to classify the list as kind of file (music file, movie file or photo file), press the desired file button among the [Music], [Movie] or [Photo] buttons.

DivX operation

REPEAT

Touch the “REPEAT” button during playback.
The item changes as follows.

OFF → ONE → FOLDER → ALL...

- ONE : Plays repeatedly the current file.
- FOLDER : Plays repeatedly all files of the current folder.
- ALL : Plays repeatedly all files of the current disc.
- OFF : Cancels repeat play.



AUDIO

Touch the “Audio” button during playback.
If the disc contains multi-audio languages, you can change to a different audio language during playback.

SUBTITLE

Touch the “Subtitle” button during playback.
If the disc contains multi-subtitle languages, you can change to a different subtitle language during playback.

Photo operation

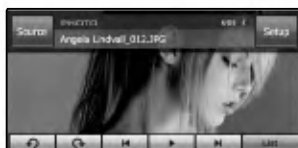

Playing photo files

The Photo viewer lets you view pictures from your device. This application recognizes JPG files.

The previous Image and next Image arrow keys lets you display the previous or next image in the sequence of image files located in the selected folder.







The "Rotate" buttons lets you move the image clockwise (or count clockwise). Each touch rotates the image 90 degrees.

The Slide Show button lets you view all JPG images in the current folder in Slide Show mode. Photo viewer shows all pictures in full-screen mode automatically at a certain rate.

Picture format

The Load Failure warning message is displayed when the image file is too large. The picture format is not supported warning message is displayed when the image file is not saved in JPG format.

JPG : Image file size should use less than 2M pixels as 5120 x 3840 (Baseline) or 2048 x 1536 (Progressive).

- Touch the  button to select the upper folder.
- Touch the  button in the current screen to exit previous screen
- Touch the  or  buttons to select the list you want to view.
  : Previous/Next page of the list.

USB operation

Playing a USB device

Plug the USB device, "USB detected" appears on the display window, and playback starts automatically. If playback does not start, press the ► button.

The way to use the files recorded in a USB memory device is the same as when using a DISC.

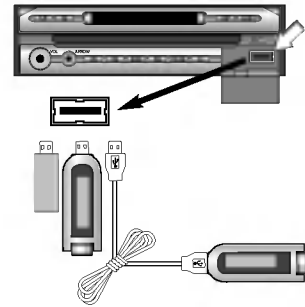









Locating a folder/file using the list

You can display the folder list/track list before starting to play.

1. Touch the "LIST" button during playback.
2. Touch the folder button you want.
3. Touch the file you want.

The file will be played.

- Touch the  button to select upper folder.
- Touch the  button in the current screen to exit previous screen.
- Touch the  or  buttons to select the list you want to view.
  : Previous/Next page of the list.
- When you want to classify the list as kind of file (music file, movie file or photo file), press the desired file button among the ,  or  buttons.

✦ Notes

- Don't remove a MP3 player or memory stick while playing via a USB device.
- Some memory sticks or devices may not be recognized depending on the type of memory.
- Card reader does not support.
- The total number of files and folders on the memory should be less than 999.

Basic navigation

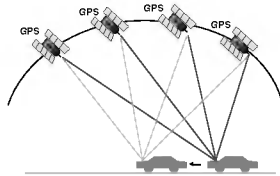

What is GPS?

The Global Positioning System (GPS) is a satellite-based navigation system made up of a network of 24 satellites placed into orbit by the U.S. Department of Defense. GPS was originally intended for military applications, but in the 1980s, the government made the system available for civilian use.

GPS works in any weather conditions, anywhere in the world, 24 hours a day.

There are no subscription fees or setup charges to use GPS.

Memory navi mode

While the map disc is inserted, you can store the data on the map disc into the memory of the navigation unit.

If the map disc is removed from the navigation unit after the data is stored, navigation is performed using the data in the memory (memory navi mode).

In the memory navi mode, you can play a music CD or DVD video on the navigation unit while navigation is taking place. The operation is automatically switched to the memory navi mode when the map disc is removed from the navigation unit.

Navigation in the memory navi mode

During the memory navi mode, navigation is performed only using the data read into the memory.

Therefore, some functions are restricted compared with navigation using the map disc (DVD navi mode).

✦ Notes

- The user may download map data for more than a country in memory. The MAP DISC is used if traveling to a different country than the country saved in the memory. It is therefore recommended to use Map Disc when traveling to other countries after downloading the map for the user to mainly use in the memory.
- It is possible to search paths to other country areas by using a map in memory but path guide is not provided.
- During map disc operation, the speed may be lower depending on the function being used.

Basic navigation

Installing the new map data in the memory

If you want to use these functions, please insert the map disc again. In addition, you may need to insert the map disc and store new data in the memory during navigation operation, such as when the destination is far away.

1. Insert the DVD map disc to the disc loading slot.
2. Touch the "NAVI/MENU" button.
3. Touch the "SETUP" button.
4. Touch the "Download" button.
5. Touch the map you want to download.
6. Touch the "Download" button.
7. Touch the "OK" button
8. The map data from the map disc is download into the memory of the navigation unit.
9. Touch the "OK" button when the installation complete screen is displayed.

Notes

- More than a country can be selected depending on capacity of the map, by country.
- During download, take care not to power off.



Menu and Map display



Map mode

Displays start map

1. Press the "NAVI" button to select the navigation.
2. The map screen displays on the screen.



The current location of your vehicle.

The arrow indicates your heading, and the display moves automatically as you drive.



Scroll location.

The cross hairs indicate a position on the map when you scroll away from your current location.

- Please see page 59 for details. (Scrolling the map display)



Compass indicator. (The red arrow indicates north.)

Each touch changes the map's display direction.

(North up, Heading up or 3D)



North up : The map display always has north at the top of screen.

Heading up : The map display always shows the vehicle's direction as proceeding towards the top of the screen.



3D : The map displays always the basic outline and details of the surrounding roads and general area.



DVD mode



Volume command is impossible.



GPS status indicator

You can check reception signals from the GPS satellite, such as information about your satellite fix, latitude, longitude and speed of your car.

The color of the icons indicates the signal reception status.

The green represents a satellite whose signals are actually being used for positioning.

The red means that signals are being picked up but are not currently in use for positioning.

- Latitude - The angular distance, measured north of south from the equator, of a point on the earth's surface.
- Longitude - The angular distance east or west on the earth's surface, as measured in degrees from the meridian of a particular point to the prime meridian of Greenwich, England.
- Speed - The rate of movement, as expressed by kilometers or miles per hour.







Menu and Map display

A communication system for informing drivers of the latest traffic information using FM multiplex broadcast. Information such as traffic jams or accidents can be checked on the display.

When a route has been calculated, touch to check whether there is any traffic jam or closure information on your route. When no route has been calculated, touch to display the traffic list.

- Please see page 76 for details.

- Area for a RDS-TMC station with good reception. :  Black.
- Area for a RDS-TMC station with poor reception. :  Gray
- Area for a RDS-TMC station with good reception.
(When there is new broadcasting. :  Green/Red)
- Area for a RDS-TMC station with good reception.
(When there is no new broadcasting.  No color)

Map scale indicator.

This map scale is indicated by distance.

You can reduce the menu to a shortcut icon.

You can register the current position receiving a GPS signal or position if you scroll down.

- Please see page 62 for details.

You can search for surrounding facilities (for example, parking lot, hospital, etc) around the current position receiving a GPS signal or position if you scroll down.

- Please see page 66 for details.

Zoom in / Zoom out indicator

The current map scale is indicated by the map scale indicator toward the bottom right of the map. You can easily increase or decrease the map scale (zoom in or zoom out) using the ⊖ and ⊕ buttons on the Navigation commander. Each click steps the scale up or down in the following order:

50 m ↔ 100 m ↔ 200 m ↔ 400 m ↔ 800 m ↔ 1 km ↔
3 km ↔ 5 km ↔ 10 km ↔ 20 km ↔ 50 km ↔ 100 km ↔
200 km ↔ 400 km

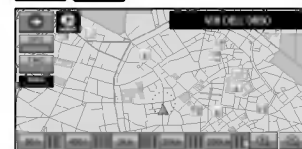
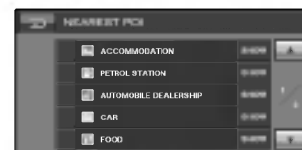
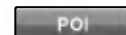
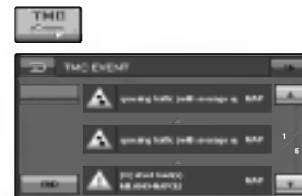

Menu and Map display

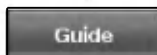

Whole route overview

You can check information about the route between your current location and destination.

Drive in accordance with the screen and voice information. This option also displays on-screen instructions whenever the system is in guide mode. Here, you will learn how to interpret the various information presented to you on the screen, and how to customize the guidance information display.

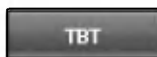

This view indicates the distance to your next turn, and the name of the next street immediately after completing the previous turn.

Voice and visual prompts are displayed at varying intervals to indicate your next turn or change of direction.

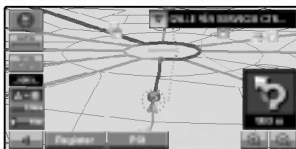

Guide mode

Mode in which guidance is given as you drive to your destination (the system automatically switches to this mode as soon as a route has been set).

The map of your surroundings is shown on the left, and an arrow indicating or illustration the direction of travel is shown on the right.



Note

When no sound guide comes out during path movement, press the NAVI button. A sound guide representing the current position is produced.



Distance to the destination (or distance to way point)
If way points are set, the display changes with each touch.



When two or more way points are set, the distance to the destination and the distance to the next way point are shown.



The remaining travel distance or travel time.



The display changes with each touch.



Direction line

The direction towards the location is indicated with a straight line.

Menu and Map display

Simulation mode

This is a demonstration function for shops. After a route is set, the simulation of the route guidance to a destination is automatically displayed.

▶ : Play || : Pause

-/+ : Check the simulation mode speed at 60 Km, 120 Km, 180 Km and 240 Km.

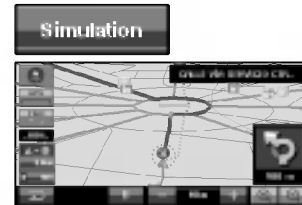

Scrolling the map display

Touching anywhere on the map changes the map to Scroll mode and the map begins scrolling in the direction you touched.

The scrolling stops when you release your finger from the screen. At this time, the scroll cursor appears at the centre of the screen. To stop scrolling, release the finger touch and allow it to return to the center position. Scrolling stops immediately.

✦ Notes

- Pressing the “NAVI” button returns you to the map of your surroundings.
- The closest road to the screen center is highlighted in the Scrolling Screen, and Destination button appears. Pressing this button enables the search path as the destination of a highlighted road.
- If path has been already searched before, pressing the “Destination” button the scroll screen will make a button to add the WayPoint appear, and if pressing “WayPoint” button, the “EDIT WAY POINTS” Screen will appear.

A location you choose as the endpoint of your journey. you can set a destination for easy and quick routing from any current position.

You can select way points (locations you want to visit on the way to your destination) and you can calculate the route the pass through these locations.

Route calculation starts automatically.

Return to the previous map screen.

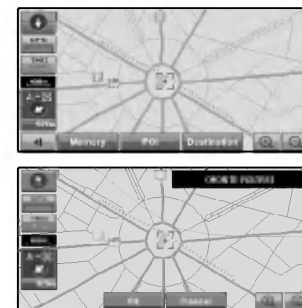

Destination

Way Point

Ok

Cancel

Menu and Map display



Marking your first journey.

It is possible to do a path search and guide using how to set various destination.

Here we explain how to set a destination by using address search.



1. Press the "MENU" button.



2. Touch the "Address Search" button.
The text entry palette appears on the screen.
3. Touch the first letter you need to input the name (City).
If there is only one letter that could possibly follow your entry, that letter will automatically be entered.
4. Touch the "OK" button.
5. Touch the item from the list (CITY LIST).

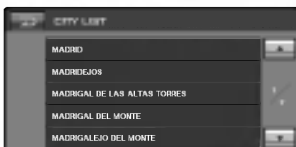

6. Touch the first letter you need to input the name (Street).
7. Touch the "OK" button.



8. Touch the item from the list (STREET LIST).



9. Input the house number and the touch "OK" button.

Menu and Map display

10. The map screen appears on the screen.
11. Touch the "OK" button.
Route calculation starts automatically.







12. The "WHOLE ROUTE OVERVIEW" screen appears on the screen.
13. Touch the "Guide" button.



14. To guide you to your destination.
The navigation will give you spoken instructions and visual instructions on the screen.
- Please see page 67 for details. (Address Search)



Notes

- Touch the  or  buttons to select the list you want to view.
  : Previous/Next page of the list.
- Touch the  button in the current screen to exit the previous screen.

Selecting your country

If the destination is in another country, you should change the country settings.

1. Touch the "Zone" button.
2. Touch the destination country.
3. Touch the "OK" button to confirm your country selection and then return to the previous screen.



Finding a location with the navigator

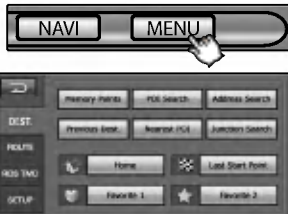

Modifying the destination menu

The DEST. Menu helps to set various destinations for path search and guide. Users can search for destination by using functions such as Address, POI, Nearest POI, Intersection, or previously stored set points such as Memory Points, Previous Dest., as destination.

This menu also provides short-cut menus for set destinations such as Home, Favorite1, Favorite2, Last Start Point that can be done at a time.

Memory Points

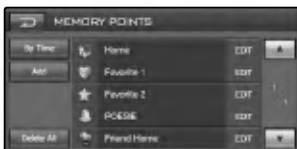

Memory Points

The Memory points can store up to 100 registered locations. These can include home location, favorite places, and destinations you have already registered.

This registered location information can also be modified. Routes to registered locations can be calculated by touching the screen. Registering places you visit frequently saves your time and effort.

By Name

Whenever pressing the button, the name of button is changed to "By Name" or "By Time".

Users may arrange lists by name or time.

Add



You can register a new registration point in the "MEMORY POINTS" list. There are 6 total setting methods for setting destinations.

Delete All

Delete all list.

EDIT

To change the information for the points already registered or to delete it from the list is provided.

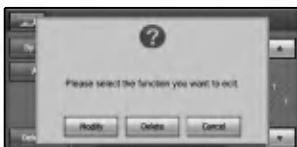

Modify

The MODIFY INFORMATION appears on the screen.
- Please see page 63 for details (MODIFY INFORMATION).

Delete

You can delete items from the list.

Cancel

Return to the previous screen.

Finding a location with the navigator

MODIFY INFORMATION : Editing a location's information

You can select a location from your list of stored "MEMORY POINTS". Also you can save or edit points from this item.

You can change the name.

- Entered name is displayed.
- Keypad button.
- Erase all entered characters.
- Delete the previous character at the cursor position.
- Inserts a space at the cursor position.
- Alternates between Number and Symbol lists.
- Confirm the entered name.

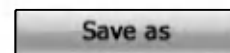
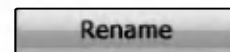

You can register the selected points in "Home" "Favorite 1" "Favorite 2" or Memory Points.
- Please see page 70 for details.

You can see and modify the position of the selected point.

- The map of the selected area and its surroundings appears.
- Touch the screen to change its position, then touch the "Modify" button. The position changes.
 - Touch the "Cancel" button to go to the previous screen.

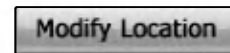

You can select the sound type.
Touch the button you want from the items.
Voice, Bell, Warning, Mute

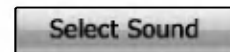

Finding a location with the navigator

POI Search

POI (Point of interest) Search

- Name
- City → Name
- Genre (Category) → Name
- City → Genre (Category) → Name
- Genre (Category) → City → Name

Information about various features (Point of Interest POI), such as petrol stations, amusement parks or restaurants is available. By selecting the category (or entering the POI Name or City), you can search for a POI.

Name

Name :

Touch if you wish to first specify the POI Name.

City

City :

Touch if you wish to first specify the destination city or area.

Genre

Genre :

Touch if you wish to first specify the category.

ESP

Zone (eg. ESP) :

Touch if you wish to first specify the country.

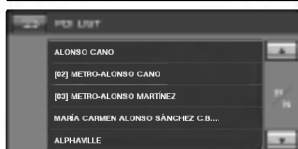

1. Touch the "POI Search" button.
The text entry palette appears on the screen.
2. Touch the "Genre" button.
3. Touch the item from the list (GENRE LIST).
POI's are divided into several categories.
If the category is not sub-divided into more detailed categories, the list will not be displayed.
4. Touch the item from the sub list.
5. Touch the "Name" button.
6. Touch the letter you want to input the name.
If there is only one letter that could possibly follow your entry, that letter will automatically be entered.
7. Touch the "OK" button.
8. Touch the item from the list (POI LIST).
9. The map screen appears on the screen.

Note

If less than five POIs in a subcategory are registered the screen for inputting the POI name is not displayed.

Finding a location with the navigator

10. Touch the "OK" button.
Route calculation starts automatically.
11. The "WHOLE ROUTE OVERVIEW" screen appears on the screen.
- Please see page 58 for details.
(WHOLE ROUTE OVERVIEW)



Notes

- Touch the or buttons to select the list you want to view.
- : Previous/Next page of the list.
- Touch the button in current screen to exit previous screen.

- Enter name is displayed. _____
- Keypad button. _____
- Erase all entered character. _____
- Delete the previous character at the cursor position. _____
- Inserts a space at the cursor position. _____
- Alternates between Number and Symbol lists. _____
- Confirm the entered name. _____



Notes

- If several items with same name are searched, only a name appears on the list as representing all of them. Total item numbers with same results are displayed with the parenthesis [] mark beside the name. Selecting the relevant list, detailed selection items appear again.
- By pressing the "Zone (eg. ESP)" button with the country code displayed, you can change a country to change. However, you can select only the country saved in memory in the Memory mode.
- If you touch "City" without entering the name of city or area, you can check all the cities or areas, which you have searched before.

Finding a location with the navigator

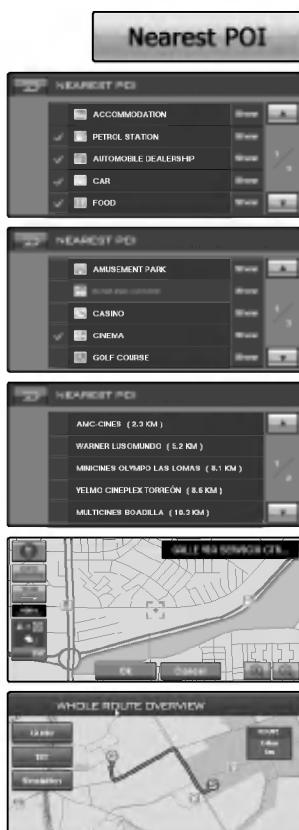

Nearest POI (Point of interest)

The map information on the memory includes the location of many points of interest. These range from railway stations to amusement parks and restaurants. You can use this function to quickly locate and route to any one of these points of interest. For example, look for a particular type of cuisine within a certain distance of your present location and set a route there. Or you can choose a museum from a list and route there.

1. Touch the “Nearest POI” button.
The POI categories appears on the screen.
2. Touch the item from the list (NEAREST POI).
POI's are divided into several categories.
If the category is not sub-divided into more detailed categories, the list will not be displayed.
3. The map screen appears on the screen.
4. Touch the “OK” button.
Route calculation starts automatically.
5. The “WHOLE ROUTE OVERVIEW” screen appears on the screen.
- Please see page 58 for details.
(WHOLE ROUTE OVERVIEW)

✦ Notes

- Touch the or buttons to select the list you want to view.
 : Previous/Next page of the list.
- Touch the button in the current screen to exit the previous screen.
- When some sub-categories are selected, the corresponding category is marked blue. When all the sub-categories within a category are selected, that category is marked yellow.
- Searching range is approximately 10 km square from the current location.

Finding a location with the navigator

Address Search :

- Street
- City → Street

If you know the address of your destination, you can set a route to using it .

Name :





Touch if you wish to first specify the Street Name.

City :

Touch if you wish to first specify the destination city or area.

1. Touch the “Address Search” button.
The text entry palette appears on the screen.
2. Touch the first letter you want to input the name (City).
If there is only one letter that could possibly follow your entry, that letter will automatically be entered.
3. Touch the “OK” button.
4. Touch the item from the list (CITY LIST).
5. Touch the letter you want to input the name (Street).
6. Touch the item from the list (STREET LIST)
7. Input the house number and touch “OK” button.
8. Touch the “OK” button.
9. The map screen appears on the screen.
10. Touch the “OK” button.
Route calculation starts automatically.
11. The “WHOLE ROUTE OVERVIEW” screen appears on the screen.
- Please see page 58 for details.
(WHOLE ROUTE OVERVIEW)

Notes

- Touch the  or  buttons to select the list you want to view.
  : Previous/Next page of the list.
- Touch the  button in the current screen to exit the previous screen.
- If you touch “City” without entering the name of the city or area, you can check the cities or areas, which you have searched before.







Finding a location with a navigator



Junction Search : City → Street1 → Street2

1. Touch the "Junction Search" button.
The text entry palette appears on the screen.
2. Touch the letter you want to input the name (STREET 1).
If there is only one letter that could possibly follow your entry, that letter will automatically be entered.
3. Touch the item from the list (STREET LIST).
4. Touch the letter you want to input the name (STREET 2).
5. Touch the "OK" button.
6. Touch the item from the list (STREET LIST 2).
7. The map screen appears on the screen.
8. Touch the "OK" button.
Route calculation starts automatically.
9. The "WHOLE ROUTE OVERVIEW" screen appears on the screen.
- Please see page 58 for details.
(WHOLE ROUTE OVERVIEW)

Notes

- Unless two streets have an intersection, a pop-up appears.
- Touch the  or  buttons to select the list you want to view.
  : Previous/Next page of the list.
- Touch the  button in the current screen to exit the previous screen.
- If you touch "City" without entering the name of city or area, you can check the cities or areas, which you have searched before.

Finding a location with the navigator

Previous Dest. (Previous destination)

The “Previous Dest” is a convenient list of places that you have routed to in the past. Up to previous destinations are stored in the list, and you can register or delete particular listings at any time. To set a route back to one of these listings, all you have to do is to select it from the list.

1. Touch the “Previous Dest.” button.
The screen displays a list of your previous destinations.
2. Touch a destination from the list.

Whenever pressing the button, the name of button is changed to “By Name” or “By Time”.

Users may arrange lists by name or time order.

Permanently deletes the listing from the list.





Changing information for the points already registered or to delete it from the list.

The MODIFY INFORMATION appears on the screen.
- Please see page 63 for details (MODIFY INFORMATION).

You can delete an item from the list.

Cancels the function.

Notes

- Touch the  or  buttons to select the list you want to view.
  : Previous/Next page in the list.
- Touch the  button in current screen to exit the previous screen.

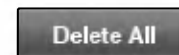
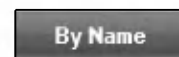

Navigation settings



Registering your home and your favorite location

If your home location is registered, the route home can be calculated by a single touch of the Home button from the menu. Also, you can register two location, such as your workplace, as your favorite location, and the route is calculated in a similar way.

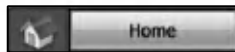

You can register your home location with the system. Doing so will make it very easy to route home from any location.

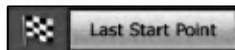

Sets up a starting point after arrival at the destination as a new destination (this menu is used in return travel through a path). This point is automatically registered in the Last Start Point after searching for destination path.

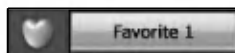

You can select a favorite from your list in the stored memory. A favorite is a destination previously stored for quick and easy retrieval.

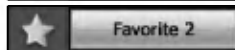

Navigation settings

Modifying the Route Calculation Conditions

You can change the route calculation conditions using the Route menu.



Cancel Route

If you no longer need to travel to your destination or if you want to change your destination.



Route Overview

You can check information about the route between your current location and your destination.
The "WHOLE ROUTE OVERVIEW" screen appears on the screen.



Return to the previous map screen.

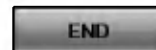

Navigation settings



ROUTE OPTIONS

- **Route Candidates**

This setting controls whether the system should calculate only one route, or three routes.

1 : Only one route judged as being optimum by your navigation is calculated.

3 : Only three route options are calculated.

- **Route Condition**

Fast : Calculate a route with the travel time to your destination as a priority.

Short : Calculate a route with the distance to your destination as a priority.

- **Avoid**

TOLL : This setting controls not-toll roads (including toll areas) that should be taken into account.

MOTORWAY : This setting controls not-motorways that may be included in the road calculation. (A route using motorways may be calculated in some cases, such as when setting your destination far away.)

FERRY : This setting controls not-ferry crossings that should be taken into account.

✦ **Note**

The avoid function is used to search for a path to avoid Tolls, Motorways and Ferry crossings.

However, Toll, Motor and Ferry may be included in some paths where bypass to the destination is severe.

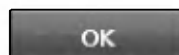

The route from the current position to your destination is recalculated.

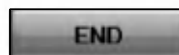

Return to the previous map screen.

Navigation settings

Edit Way Point

You can edit (add, delete) way points (locations you want to visit on the way to your destination) and you can recalculate the route to pass through these locations.

Whenever you set a way point, your point is manually added to the "EDIT WAY POINTS". Switch the display to search for points. When you display the map for a certain point after searching for it, you can touch "ADD" to add that point to the way points. (You can add up to five way points in total.)

You can sort the way point by distance from your current position.

You can sort the way point by original order from your current position.

The route from the current position to your destination is recalculated.

If more than two destinations exist, the ▲ or ▼ buttons allow to change the up and down position of the list when clicking items in the list. You can manually re-arrange list by using this button.

Using it to change information for the points already registered or to delete it from the list.

Note

If a path has been already searched before, pressing the "Destination" button the scroll screen will make a button to add the "EDIT WAY POINTS" screen will appear.

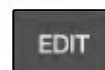
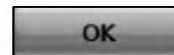
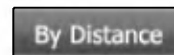

Navigation settings



Detour

As you follow the guidance provided by your Navigation, you may wish to find an alternative route that avoids a certain length of the road ahead. For example, you may hear on the radio that the road ahead is heavily congested. In such a situation, "Detour" may be able to find a route around the congestion by taking a less direct route at upcoming intersections.



1. Touch the distance from the list.
You select the desired distance button, a pop-up asking "Do you want to perform Detour?" appears.
2. Pressing the "OK" button performs Detour.
Route calculation starts automatically.
3. The "ROUTE OVERVIEW" screen appears on the screen.
If searching is completed, the initial path and bypass path appear at the same time. You can select a desired path to be used.

Notes

- Depending on the road layout, the actual length of the calculated detour may differ somewhat from the specified distance. Also, the calculated detour may be longer than the original route.
- Depending on the road layout and road conditions, the Detour function may fail to find an alternative route.
- In some cases, the detour route may overlap the original route for some distance.
- On the map screen during route guidance, try this operation.

Navigation settings

Change Start

Change Start is the function to change the start point site simulating where to drive using the navigation before actually driving.

1. Touch the “Change Start Point” button.
The pop -up screen appears.
2. Touch the “OK” button to where you want to change the start point.
3. The map screen appears on the screen.
4. Touch anywhere on the map.
You can change the direction of the starting point by pressing the arrow button around the map.
5. Touch the “OK” button.

If you want to return to the current start point where it receives the GPS signal.

1. Touch the “Change Start Point” button.
The pop -up screen appears.
2. Touch the “GPS” button.

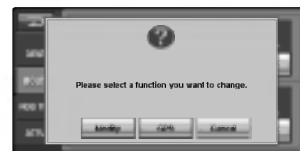

✦ Notes

- If you set a start point and a destination, the navigation displays a map that shows you the route. In this operation, the satellite-based global positioning system (GPS) is not used. Your current position is not detected and navigation does not keep track of your driving progress. Use the Change start Mode for trip planning.
- If you set a start point outside memory point, the simulation will be limited.

Navigation settings



Using Traffic Information (RDS-TMC)

You can check traffic information transmitted by the FM radio service through the Radio Data System (TMC) on the display. Such traffic information is updated periodically. When you receive traffic information, the Navigation System automatically displays an icon informing you of the traffic information. You can also select whether to recalculate the route to avoid a traffic jam.



TMC Event List

Traffic Information is displayed on the screen in a list format. This allows you to check how many traffic incidents have occurred, their location, and their distance from your current position.

Touching an incident you want to see allows you to view the detailed information about the incident. If the information cannot be displayed on one screen, touch ▲ or ▼ to view the remaining information.

When new traffic information is received, the current information is changed, or old information has been removed, the list is updated to reflect the new situation.

You can sort the traffic information by distance from your current position.

You can sort the traffic information in alphabetical order.

The traffic-related position is displayed on the map.

Notes

- A line indicates the length of the traffic jam. It appears only when the scale on the map is 800 m or lower.
 - Stop and go : Orange
 - Stopped traffic : Red
 - Closed/Blocked : black
- Icon for traffic information appears only when the scale on the map is 800 m or lower.
- If there is a traffic jam on your route (at least 1 km ahead on an ordinary road, while driving on the motorway, 3 km ahead), the navigation system automatically searches for detour possibility.

Navigation settings

Station Search

The RDS-Tuner of the navigation system automatically tunes to the radio station to receive available traffic information (RDS-TMC station). If reception is poor, you can switch to another station manually. Once the receiving radio station is selected, the system automatically tunes to stations that provide traffic information according to the location of the vehicle.

You can pre-select up to six TMC stations (Preset Station). From the list of the TMC stations, you can select the one you want to receive.

Available radio stations can be searched automatically. If a radio station with a good signal is found, the tuning mode is stopped.

Store the current RDS-TMC station in the preset list. If there are already 6 stations stored in the list, select one to be overwritten.

Display Icon

The name of the displayed traffic information items and list of icons appears on the screen.

1. Select the type of traffic information to display with the navigation system.
2. A yellow tick ✓ appears next to the selected traffic information.

Touching the "All" button selects all the traffic information.

Note

The traffic information in this section indicated the following types of traffic information ; stop and go, stopped traffic, closed/blocked roads.

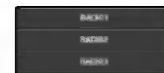

Display Icon

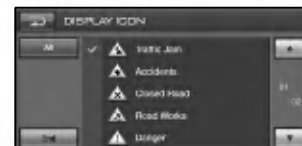

Navigation settings



TMC Option

- **Auto Seek Mode**
ON : When you receive traffic information, the Navigation System automatically seeks.
OFF : Cancels the function.
- **Event Alarm**
ON : Alarm sound rings if there are traffic jam sectors in the direction of the vehicles during towards the destination.
OFF : Cancels the function.
- **Dynamic Recalculation**
ON : This function is used to search for a new path without traffic jam if there are traffic jam sectors in the forward traveling direction of the vehicles during towards to the destination.
OFF : Cancels the function.

Navigation settings

Display

- **Memory Points**

ON : Displays on the screen points where the user registered memory points in the memory.

OFF : You can hide all points from the main navigation view at a stroke.

- **Track**

You can set the system to display tracking dots that show the route you have driven.

ON : Display tracking dots for all journeys.

OFF : Do not display tracking dots

- **Dimension**

2D : The 2D view is the straight-forward two-dimensional view. This is the default map view. In this view, the map is dynamically updated, and allows for manual panning and zooming.

3D : The 3D view is a simplified three-dimensional view showing the map in a basic 3D relief. It shows the basic outline and details of the surrounding roads and general area.

ANGLE : You can set the map to an easily viewable angle.

- **Color**

DAY : Always use day-driving background colour.

NIGHT : Always use as a night-driving background colour.

AUTO : Switch to night-driving background automatically when headlights are switched on.



Guidance

- **Merge Alarm**

ON : Alarm sound rings if there are crossing-road points in the forward traveling direction of the vehicle towards the destination.

OFF : Cancel the function.

- **Registered Point Alarm**

ON : If the Memory Point in the forward traveling direction of the vehicle towards the destination, the alarm sound rings.

OFF : Cancels the function.

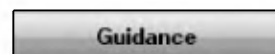

Navigation settings



Volume

Sound volume for the navigation.

Touch + or - buttons to change the guidance volume.

Mute : Items related to muting the sound volume can be set.

Notes

- Volume of the audio source is adjusted by the VOL dial of the unit.
- During navigation, press and hold the "NAVI" button to drop the volume.



Language

You can set the display language.

Touch the language you want to use.

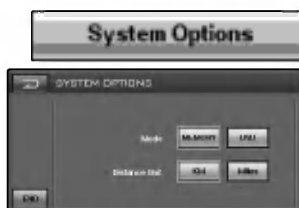

System Options

Mode

Touch if you wish to select memory navi mode. :

Touch if you wish to select DVD navi mode. :

- Please see page 56 for details.

Distance Unit

Km : Always display and announce in kilometers.

Mile : Always display and announce in miles.



Download

The new map is downloaded to the navigation system using the map disc.

Please see page 55 for details. (Install the map data in the memory.)



GPS Information

Please see page 56 for details. (Install the map data in the memory.)



Initialize

You can force all settings to return to their factory setting.

Cannot identify the current location. (GPS not receiving)

GPS cannot be used indoors and must be connected to a power source with ACC in a vehicle in a location where the signal from the sky can be received easily.

When initially connecting the GPS, it usually takes about 10 minutes to be working normally, but the connection speed can differ depending on the weather condition, and surrounding obstacles.

If the GPS connection is unstable for a long period of time, try the following.

- Check if the product is connected to a power source.
- Check if the back of the GPS product is in a location where the sky can be seen well.
- If there are high buildings or if you are under a tree, move to a location where there aren't any obstacles.
- Check the GPS receiving condition from the GPS menu.

Cannot hear the voice guide.

Check that volume is set to Mute to very small volume in the setup menu.

No guide sound comes out in the case of straight sector or not in the guide time.

In this case, an appropriate sound in the current position if pressing the NAVI button.

There is a difference between the driving road and the road on the map in the product.

Even though GPS is usually very accurate, there is a small margin for error.

When the GPS receiver is installed, there can be an error of about 10m. But for newly built roads, the problem could come from the data update to the map.

Cannot see the map.

Perhaps you cannot see the map even when you have executed the navigation menu.

This happens when the data within the memory is damaged. Delete all the data in the memory and install the data again.

If the issue persists after installation, contact the A/S center.

Map data is not newly updated.

The information registered in the map data is not recent.

The information registered in the map data must be updated on a regular basis.

○ Troubleshooting

The path guide can be different from the actual path. (Path guide error)

- When the road is closely parallel.
- When the splitting road angle is very small.
- When there is an adjacent road when turning.
- When driving on a road that is narrowing fast.
- When driving through the mountain or where the road is too curvy.
- When the starting, passing and arriving locations are too close within 1km.
- When you have set the starting, passing or arriving location more than 1km away from the road.
- When driving through the tunnel.
- When driving through high buildings.

Map matching

As mentioned, the GPS systems used by this Mobile Navigation System are susceptible to certain errors. Their calculations may on occasion place you in a location the map where no road exists. In this situation, the processing system understands that vehicles travel only on roads, and is able to correct your position by adjusting it to a nearby road. This is called map matching.

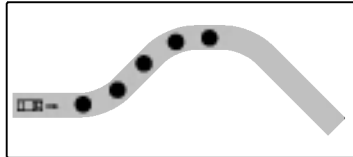

With map matching.

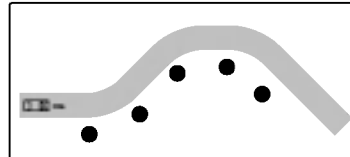

With no map matching.

Troubleshooting

Symptom	Cause	Correction
Power doesn't turn on. The unit doesn't operate.	<ul style="list-style-type: none"> Leads and connectors are not properly connected. The fuse is blown. Noise and other factors are causing the built-in microprocessor to operate incorrectly. 	<ul style="list-style-type: none"> Confirm once more that all connections are correct. Rectify the problem that caused the fuse to blow, and then replace it. Be very sure to install the correct fuse with the same rate. Turn the unit off and then on.
Playback is not possible.	<ul style="list-style-type: none"> The disc is dirty. The loaded disc is of a type this unit cannot play. 	<ul style="list-style-type: none"> Clean disc. Check what type the disc.
No sound is heard. The volume level will not rise.	<ul style="list-style-type: none"> Cables are not connected correctly. 	<ul style="list-style-type: none"> Connect the cables correctly.
There's no sound.	<ul style="list-style-type: none"> The volume level is low. 	<ul style="list-style-type: none"> Adjust the volume.
There's audio skipping.	<ul style="list-style-type: none"> This unit is not firmly secured. 	<ul style="list-style-type: none"> Secure this unit firmly.
The unit does not operate correctly even when the appropriate remote control buttons are pressed.	<ul style="list-style-type: none"> Battery power is low. Some operations are prohibited with certain discs. 	<ul style="list-style-type: none"> Load new battery. Check using another disc.

Troubleshooting

Language Codes

Use this list to input your desired language for the following initial settings:
Disc Audio, Disc Subtitle, Disc Menu.

Language	Code	Language	Code	Language	Code	Language	Code
Abkhazian	6566	Fiji	7074	Lingala	7678	Singhalese	8373
Afar	6565	Finnish	7073	Lithuanian	7684	Slovak	8375
Afrikaans	6570	French	7082	Macedonian	7775	Slovenian	8376
Albanian	8381	Frisian	7089	Malagasy	7771	Somali	8379
Ameharic	6577	Galician	7176	Malay	7783	Spanish	6983
Arabic	6582	Georgian	7565	Malayalam	7776	Sudanese	8385
Armenian	7289	German	6869	Maltese	7784	Swahili	8387
Assamese	6583	Greek	6976	Maori	7773	Swedish	8386
Aymara	6588	Greenlandic	7576	Marathi	7782	Tagalog	8476
Azerbaijani	6590	Guarani	7178	Moldavian	7779	Tajik	8471
Bashkir	6665	Gujarati	7185	Mongolian	7778	Tamil	8465
Basque	6985	Hausa	7265	Nauru	7865	Tatar	8484
Bengali; Bangla	6678	Hebrew	7387	Nepali	7869	Telugu	8469
Bhutani	6890	Hindi	7273	Norwegian	7879	Thai	8472
Bihari	6672	Hungarian	7285	Oriya	7982	Tibetan	6679
Breton	6682	Icelandic	7383	Panjabi	8065	Tigrinya	8473
Bulgarian	6671	Indonesian	7378	Pashto, Pushto	8083	Tonga	8479
Burmese	7789	Interlingua	7365	Persian	7065	Turkish	8482
Byelorussian	6669	Irish	7165	Polish	8076	Turkmen	8475
Cambodian	7577	Italian	7384	Portuguese	8084	Twi	8487
Catalan	6765	Japanese	7465	Quechua	8185	Ukrainian	8575
Chinese	9072	Javanese	7487	Rhaeto-Romance	8277	Urdu	8582
Corsican	6779	Kannada	7578	Rumanian	8279	Uzbek	8590
Croatian	7282	Kashmiri	7583	Russian	8285	Vietnamese	8673
Czech	6783	Kazakh	7575	Samoan	8377	Volapük	8679
Danish	6865	Kirghiz	7589	Sanskrit	8365	Welsh	6789
Dutch	7876	Korean	7579	Scots Gaelic	7168	Wolof	8779
English	6978	Kurdish	7585	Serbian	8382	Xhosa	8872
Esperanto	6979	Laothian	7679	Serbo-Croatian	8372	Yiddish	7473
Estonian	6984	Latin	7665	Shona	8378	Yoruba	8979
Faroese	7079	Latvian, Lettish	7686	Sindhi	8368	Zulu	9085

Area Codes

Choose a area code from this list.

Area	Code	Area	Code	Area	Code	Area	Code
Afghanistan	AF	Ethiopia	ET	Malaysia	MY	Saudi Arabia	SA
Argentina	AR	Fiji	FJ	Maldives	MV	Senegal	SN
Australia	AU	Finland	FI	Mexico	MX	Singapore	SG
Austria	AT	France	FR	Monaco	MC	Slovak Republic	SK
Belgium	BE	Germany	DE	Mongolia	MN	Slovenia	SI
Bhutan	BT	Great Britain	GB	Morocco	MA	South Africa	ZA
Bolivia	BO	Greece	GR	Nepal	NP	South Korea	KR
Brazil	BR	Greenland	GL	Netherlands	NL	Spain	ES
Cambodia	KH	Heard and McDonald Islands	HM	Netherlands Antilles	AN	Sri Lanka	LK
Canada	CA	Hong Kong	HK	New Zealand	NZ	Sweden	SE
Chile	CL	Hungary	HU	Nigeria	NG	Switzerland	CH
China	CN	India	IN	Norway	NO	Taiwan	TW
Colombia	CO	Indonesia	ID	Oman	OM	Thailand	TH
Congo	CG	Israel	IL	Pakistan	PK	Turkey	TR
Costa Rica	CR	Italy	IT	Panama	PA	Uganda	UG
Croatia	HR	Jamaica	JM	Paraguay	PY	Ukraine	UA
Czech Republic	CZ	Japan	JP	Philippines	PH	United States	US
Denmark	DK	Kenya	KE	Poland	PL	Uruguay	UY
Ecuador	EC	Kuwait	KW	Portugal	PT	Uzbekistan	UZ
Egypt	EG	Libya	LY	Romania	RO	Vietnam	VN
El Salvador	SV	Luxembourg	LU	Russian Federation	RU	Zimbabwe	ZW

Bluetooth phone compatibility list

- If even a phone as described in this list meets requirements of Bluetooth Hand-free Profile 1.0 and Object Push Profile 1.1, it can operate. However, it is noted that we cannot assure for operation by function.
- As difference in functional operation by model is mainly resulted from feature of a hand-free phone, consult manufacturer of a phone if you have any question.

Manufacturer	Model	Manufacturer	Model
Nokia	3230	Sony Ericsson	W810i
	6021		K700i
	6230		K750i
	6680		V800
	6630	Siemens	SL75
	8800	SP65	
Samsung	N70	LG	U8210
	SGH-Z500		U8290
	SGH-E7700		M4410
	SGH-D600		KU730
	SPH-V6900		KG800
Motorola	L6 (L7)		P7200
	V3		S5200
	E1		

Specifications

GENERAL

Output Power.....	50W x 4CH (Max.)
Power Source.....	DC 12V
Speaker impedance.....	4 Ω
Ground System.....	Negative
Dimensions (W x H x D).....	400 x 280 x 55 mm (Main unit)
Dimensions (W x H x D).....	256.8 x 163.8 x 40 mm (Hideaway unit)
Net Weight.....	2.28 kg (Main unit)
Net Weight.....	1.12 kg (Hideaway unit)

DISPLAY

LCD.....	7 inch TFT LCD
Resolution.....	480 X 234
Back Light.....	CCFL type (L-type)

CD/DVD/VCD SELECTION

Frequency Response.....	20 Hz-20 kHz
S/N Ratio.....	95 dB
Distortion.....	0.1 %
Channel Separation (1kHz).....	70 dB

RADIO SELECTION

FM

Frequency Range.....	87.5-107.9 or 87.5-108 MHz
S/N Ratio.....	55 dB
Distortion.....	1.0 %
Usable Sensitivity.....	12 dBμV

AM (MW)

Frequency Range.....	520-1720 or 522-1620 kHz
S/N Ratio.....	45 dB
Distortion.....	1.0 %
Usable Sensitivity.....	32 dBμV

NAVIGATION SELECTION

CPU.....	SPC5200CVR400B
OS.....	QNX v 6.3
SDRAM.....	64 MB
Memory (Map).....	2 GB CFC
Memory (OS).....	32 MB NOR Flash
Graphic.....	Fujitsu Coral-PA
GPS.....	GSC3f
Map.....	Navteq
Map Update.....	DVD ATAPI
User Interface.....	Touch screen

Support-Hotline

- * You can download the Update Software from <http://www.lge.com/support/software.jsp> for free.
- * You can purchase the Upgrade Map from LG Authorized Service Centres. For more information, contact Call Centre or Website.

LG Subsidiary	Country	Service Number
LG Electronics ESPANA S.A.	SPAIN	902 500 234
LG Electronics U.K. Ltd	U.K. / IRELAND	0870 873 5454
LG Electronics France	FRANCE	0825-826-822 0825-825-592
LG Electronics Deutschland GmbH	GERMANY	01805 4737 84
LG Electronics Italia S.p.A	ITALY	39 199600099
LG Electronics Hellas S.A	GREECE	+30-210-4800-564/8 801 11 200 900
LG Electronics Benelux B.V	BELGIUM LUXEMBOURG Netherlands	070-233-557 32-70-233-557 0900-543-5454
LG ELECTRONICS MAGYAR KFT	HUNGARY Bulgaria	36-06-40-545454 +359-070-1-5454
LG Electronics Polska Sp. z.o.o	POLAND	801 54 54 54
LG Electronics Portugal, S,A	PORTUGAL	808-78-5454
LG Electronics Nordic AB	SWEDEN DENMARK FINLAND NORWAY	0771 41 4379 8088 5758 0800 116 587 800 18 740
Austria	AUSTRIA	420 810 555 810
RUMANIA	RUMANIA	40 31 228 3542
CZECH REPUBLIC	CZECH SLOVAKIA	420 810 555 810 421 850 111 154

- * For the latest Call Centre numbers, please visit Website (www.lge.com)



P/NO : 3834RR0051G