



LG Electronics Inc.

A large, stylized grey letter 'L' graphic is positioned on the right side of the page. It has a thick, blocky appearance with a white outline. The top horizontal bar of the 'L' is slightly angled downwards to the right, and the vertical stem is also slightly angled to the right. The bottom horizontal bar is also slightly angled to the right.

**PLASMA TV
OWNER'S MANUAL**

**42PB2RR
42PB2RRH
50PB2RR
50PB2RRH**

Please read this manual carefully and completely before operating your set. Retain it for future reference.
Record model number and serial number of the set.
See the label attached on the back cover and quote this information to your dealer when you require service.

IMPORTANT SAFETY INSTRUCTIONS

Important safety instructions shall be provided with each apparatus. This information shall be given in a separate booklet or sheet, or be located before any operating instructions in an instruction for installation for use and supplied with the apparatus.

This information shall be given in a language acceptable to the country where the apparatus is intended to be used.

The important safety instructions shall be entitled "Important Safety Instructions". The following safety instructions shall be included where applicable, and, when used, shall be verbatim as follows. Additional safety information may be included by adding statements after the end of the following safety instruction list. At the manufacturer's option, a picture or drawing that illustrates the intent of a specific safety instruction may be placed immediately adjacent to that safety instruction :

WARNING

Read these instructions.

Keep these instructions.

Heed all warnings.

Follow all instructions.



- 1 Do not place the product in direct sunlight or near heat sources such as heat registers, stove and so on.

This may cause a fire.



- 2 Do not use the product in damp place such as a bathroom or any place where it is likely to get wet.

This may cause a fire or could give an electric shock.



- 3 Bend antenna cable between inside and outside building to prevent rain from flowing in.

This may cause water damaged inside the product and could give an electric shock.

- 4 Earth wire should be connected.

If the earth wire is not connected, there is possible a danger of electric shock caused by the current leakage.

If grounding methods are not possible, a separate circuit breaker should be employed and installed by a qualified electrician.

Do not connect ground to telephone wires, lightning rods or gas pipe.

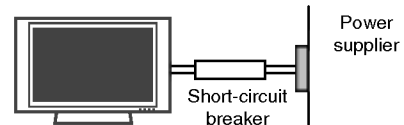

- 5 Do not placing anything containing liquid on top of the product.

This may cause a fire or could give an electric shock.



- 6 Wet Location Marking :

Apparatus shall not be exposed to dripping or splashing and no objects filled with liquids, such as vases, shall be placed on the apparatus.

- 7 Do not insert any object into the exhaust vent.

This may cause a fire or could give an electric shock.

- 8 Do not place heavy objects on the product.

This may cause serious injury to a child or adult.

WARNING

IMPORTANT SAFETY INSTRUCTIONS

WARNING

- 9** Do not use water the product while cleaning.
This may cause damaged the product or could give an electric shock.



- 10** In case of smoke or strange smell from the product, switch it off, unplug it from the wall outlet and contact your dealer or service center.

This may cause a fire or could give an electric shock.

- 11** Do not attempt to service the product yourself. Contact your dealer or service center.

This may cause damaged the product or could give an electric shock.



- 12** During a lightning thunder, unplug the product from the wall outlet and don't touch an antenna cable.

This may cause damaged the product or could give an electric shock.

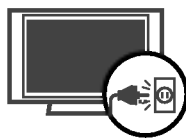

NOTE

- 1** Never touch the power plug with a wet hand.
This may cause an electric shock.

- 2** Disconnect from the mains and remove all connections before moving.

- 3** Do not place the product in a built-in installation such as a bookcase or rack.

Ventilation required.

- 4** When installing the product on a table, be careful not to place the edge of its stand.

This may cause the product to fall, causing serious injury to a child or adult, and serious damage to the product.

- 5** Do not place an outside antenna in the vicinity of overhead power lines or other electric light or power circuits.

This may cause an electric shock.

- 6** There should be enough distance between an outside antenna and power lines to keep the former from touching the latter even when the antenna falls.

This may cause an electric shock.

- 7** Do not pull the cord but the plug when unplugging.

This may cause a fire.

WARNING

NOTE

- 8** Ensure the power cord doesn't trail across any hot objects like a heater.

This may cause a fire or an electric shock.

- 9** Do not plug when the power cord or the plug is damaged or the connecting part of the power outlet is loose.

This may cause a fire or an electric shock.

- 10** Dispose of used batteries carefully to protect a child from eating them.

In case that it eats them, take it to see a doctor immediately.

- 11** When moving the product assembled with speakers do not carry holding the speakers.

This may cause the product to fall, causing serious injury to a child or adult, and serious damage to the product.

- 12** Unplug this product from the wall outlet before cleaning. Do not use liquid cleaners or aerosol cleaners.

This may cause damaged the product or could give an electric shock.

- 13** Contact the service center once a year to clean the internal part of the product.

Accumulated dust can cause mechanical failure.

- 14** The distance between eyes and the screen should be about 5 - 7 times as long as diagonal length of the screen.

If not, eyes will strain.

- 15** Unplug the product from the wall outlet when it is left unattended and unused for long periods of time.

Accumulated dust may cause a fire or an electric shock from deterioration or electric leakage.

- 16** Only use the specified batteries.

This may cause damaged the product or could give an electric shock.

CONTENTS

| | |
|-------------------|---|
| WARNING | 1 |
| BENEFIT | 6 |
| ACCESSORIES | 7 |

INTRODUCTION

| | |
|-------------------------------------|-------|
| Controls / Connection Options | 8-9 |
| Remote Control Key Functions | 10-11 |
| Home Menu | 12 |

INSTALLATION

| | |
|----------------------------------|----|
| Basic Connection | 13 |
| Attaching the TV to a wall | 14 |
| Swivel Function | 15 |
| Stand Installation | 16 |

CONNECTIONS & SETUP

| | |
|--------------------------------------|-------|
| Antenna Connection | 17 |
| VCR Setup | 18-19 |
| External Equipment Connections | 20 |
| External Stereo | 20 |
| AV out Setup | 21 |
| DVD Setup | 22-23 |
| HDSTB(SET-TOP BOX) Setup | 24-26 |
| PC Setup | 27-29 |

BASIC OPERATION

| | |
|--|----|
| Turning the Set On | 30 |
| Channel Selection | 30 |
| Volume Adjustment | 30 |
| On-Screen Menus Language Selection | 31 |

SPECIAL FUNCTIONS

DVR (Digital Video Recorder)

| | |
|--|-------|
| Time control | 32 |
| Progressing the Time control function .. | 33-34 |
| Recording | 35-36 |
| Watching & Record | 37 |
| Recorded TV | 38 |
| Recorded program Selection and Popup Menu | 38-39 |
| Playing recorded programs | 39 |
| Using the remote control | 40 |
| Manual Recording | 41 |
| Scheduled List | 42 |
| Video Quality | 42 |
| Format hard disk | 43 |

PIP/Double Window/POP

| | |
|---|----|
| Watching PIP/Double Window/POP | 44 |
| TV Program Selection for PIP | 44 |
| Selecting an Input Signal Source for the PIP/Double window | 44 |
| Sub Picture Size Adjustment (PIP mode only) | 45 |
| Moving the Sub picture (PIP mode only) ... | 45 |
| Swapping the PIP/Double window | 45 |
| Adjusting PIP Transparency (PIP mode only) | 45 |
| POP (Picture-out-of-Picture: Channel Scan) | 45 |

TV MENU

TV MENU

On Screen Menus Selection and Adjustment . 46

Channel Setup

Auto Program : Channel Search 47

Manual Program : Adding /Deleting Channels 48

Fine Tuning Adjustment 49

Booster 50

Favorite Channels setup 51

Picture Adjustment

Auto Picture Control (APC) 52

Manual Picture Control (APC-User Option) .. 53

Auto Color Temperature Control (ACC) 54

Manual Color Temperature Control (ACC-User Option) 55

XD 56

Advanced-Cinema Mode Setup 57

Advanced-Black Level 58

Reset 59

Sound Adjustment

Digital Auto Sound Processing (DASP) 60

Sound Control Adjustment (DASP-User Option) .. 61

Auto Volume Leveler (AVL) 62

Balance Adjustment 63

TV Speakers On/Off Setup 64

Stereo/SAP Broadcasts Setup 65

Time Setting

Clock Setup 66

On/Off Timer Setup 67

Auto Off 68

Sleep Timer 69

Special Features

Key Lock 70

ISM Method 71

Low power 72

Closed Captions 73

XD Demo 74

Index 75

Screen Adjustment

Auto Configure (RGB[PC] Mode Only) 76

Manual Configure 77

Selecting Wide VGA/XGA Mode 78

Aspect Ratio Control (ARC) 79

Initializing (Reset to Original Factory Settings) 80

APPENDIX

External Control Device Setup81-87

IR Codes88-89

Programming the Remote Control 90

Programming Codes 90-91

Troubleshooting Checklist 92-93

Maintenance 94

Product Specifications 95

INTRODUCTION

BENEFIT

What is a Plasma TV ?

Using plasma is the best way to achieve flat panel displays with excellent image quality and large screen sizes that are easily viewable. The Plasma TV can be thought of as a descendant of the neon lamp and or a series of fluorescent lamps.

How does it work?

Plasma TV is an array of cells, known as pixels, which are comprised of three sub-pixels, corresponding to the colors red, green, and blue. Gas in a plasma state is used to react with phosphors in each sub-pixel to produce colored light (red, green, or blue). These phosphors are the same types used in Cathode Ray Tube (CRT) devices such as televisions and common computer monitors.

Plasma TV offers a rich, dynamic display because each sub-pixel is individually controlled by advanced electronics to produce over 16 million different colors. This means that you get perfect images that are easily viewable in a display that is fewer than five inches thick.

160° - Wide angle range of vision

Your flat panel plasma screen offers an exceptionally broad viewing angle of over 160 degrees. This means that the display is clear and visible to viewers anywhere in the room.

Wide Screen

The wide screen offers a theater-like experience in your own home.

Multimedia

Connect your plasma display to a PC and use it for conferencing, games, and Internet browsing. The Picture-in-Picture feature allows you to view your PC and video images simultaneously.

Versatile

The light weight and thin size makes it easy to install your plasma display in a variety of locations where conventional TVs do not fit.

The Plasma TV Manufacturing Process: a few minute colored dots may be present on the Plasma TV screen

The Plasma TV is composed of 0.9 to 2.2 million cells. A few cell defects will normally occur in the Plasma TV manufacturing process. Several tiny, minute colored dots visible on the screen should be acceptable. This also occurs in other Plasma TV manufacturers' products. The tiny dots appearing does not mean that this Plasma TV is defective. Thus a few cell defects are not sufficient cause for the Plasma TV to be exchanged or returned. Our production technology minimizes these cell defects during the manufacture and operation of this product.

ACCESSORIES

Ensure that the following accessories are included with your set. If an accessory is missing, please contact the dealer where you purchased the set.

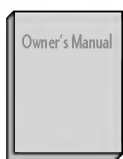

Owner's Manual



Batteries



Remote Control

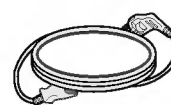

Power Cord



2-Wall brackets



2-eye-bolts



Polishing Cloth
Polish the screen with the cloth.

- * Slightly wipe stained spot on the exterior only with the polishing cloth for the product exterior if there is stain or fingerprint on surface of the exterior.
- * Do not wipe roughly when removing stain. Please be cautious of that excessive power may cause scratch or discoloration.

INTRODUCTION

CONTROLS

- This is a simplified representation of a front panel. Here shown may be somewhat different from your set.

Front Panel Controls

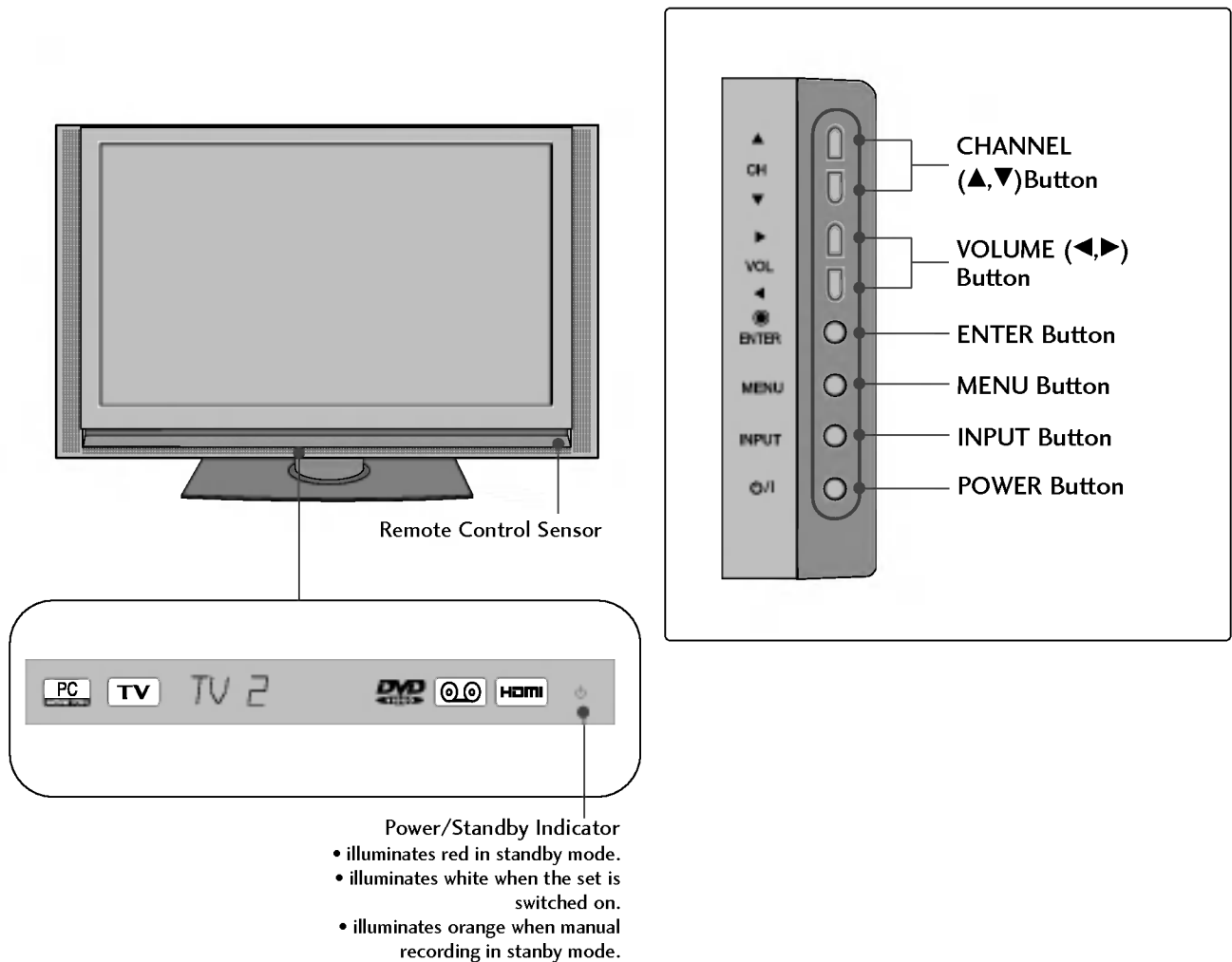

CONNECTION OPTION

Back Connection Panel

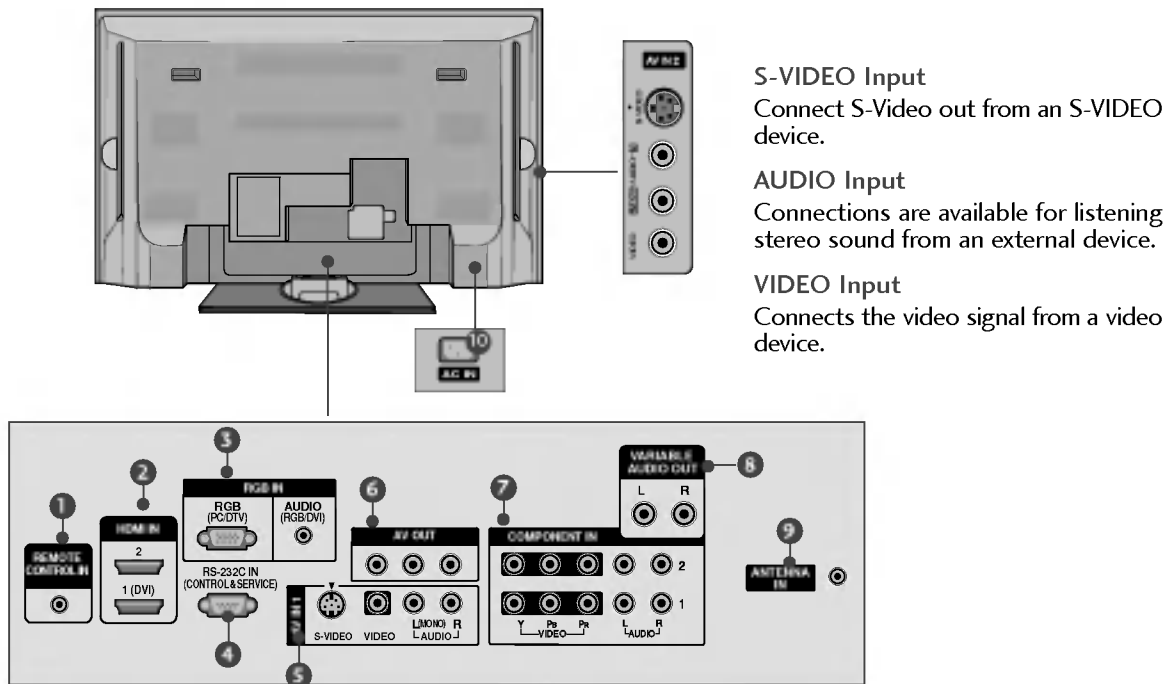

S-VIDEO Input

Connect S-Video out from an S-VIDEO device.

AUDIO Input

Connections are available for listening stereo sound from an external device.

VIDEO Input

Connects the video signal from a video device.

1 Remote Control Port

Connect your wired remote control.

2 HDMI IN

Connect a HDMI signal.
Or DVI(VIDEO)signal to the this port with a DVI to HDMI cable.

3 RGB/AUDIO IN

Connect the output from a settop box or PC to the appropriate input port.

4 RS-232C IN (CONTROL & SERVICE) PORT

Connect to the RS-232C port on a PC.

5 AV (Audio/Video) IN 1

Connect audio/video output from an external device to these jacks.

S-VIDEO

Connect S-Video out from an S-VIDEO device.

6 AV OUT

Connect a second TV or monitor.

7 COMPONENT IN

Connect a component video/audio device to these jacks.

8 VARIABLE AUDIO OUT

Connect an external amplifier or add a subwoofer to your surround sound system.

9 ANTENNA IN

Connect over-the air signals to this jack.

10 Power Cord Socket

For operation with AC power.

Caution: Never attempt to operate the TV on DC power.

INTRODUCTION

REMOTE CONTROL KEY FUNCTIONS

When using the remote control, aim it at the remote control sensor on the TV.

- POWER** Turns your TV or any other programmed equipment on or off, depending on mode.

TV INPUT Returns to the TV mode.

INPUT If you press the button once, the input source OSD will appear on screen as shown. Press the ▲ / ▼ button and then ENTER button to select the desired input source (TV, AV (or AV1/2), Component 1, Component 2, RGB, HDMI1/DVI, HDMI2).
- ARC** Change the aspect ratio. ► **p.79**

Brightness adjustment
 - Adjusts brightness on screen.
 - It returns to the default settings brightness by changing mode source.
- EXIT** Clears all on-screen displays and returns to TV viewing from any menu.

MEMORY/ERASE Memorizes or erases selected channel. ► **p.48**

TIME MACHINE Brings up the Home menu.

MENU Displays the main menu.

SLEEP Select the amount of time before your TV turns off automatically. ► **p.69**
- VOLUME UP /DOWN** Increases/decreases the sound level.

FCR Scroll through the programmed Favorite channels.

MUTE Switches the sound on or off.

CHANNEL UP/DOWN Select available channels.
- 1** **CAPTION** Selects CAPTION mode. ► **p.73**

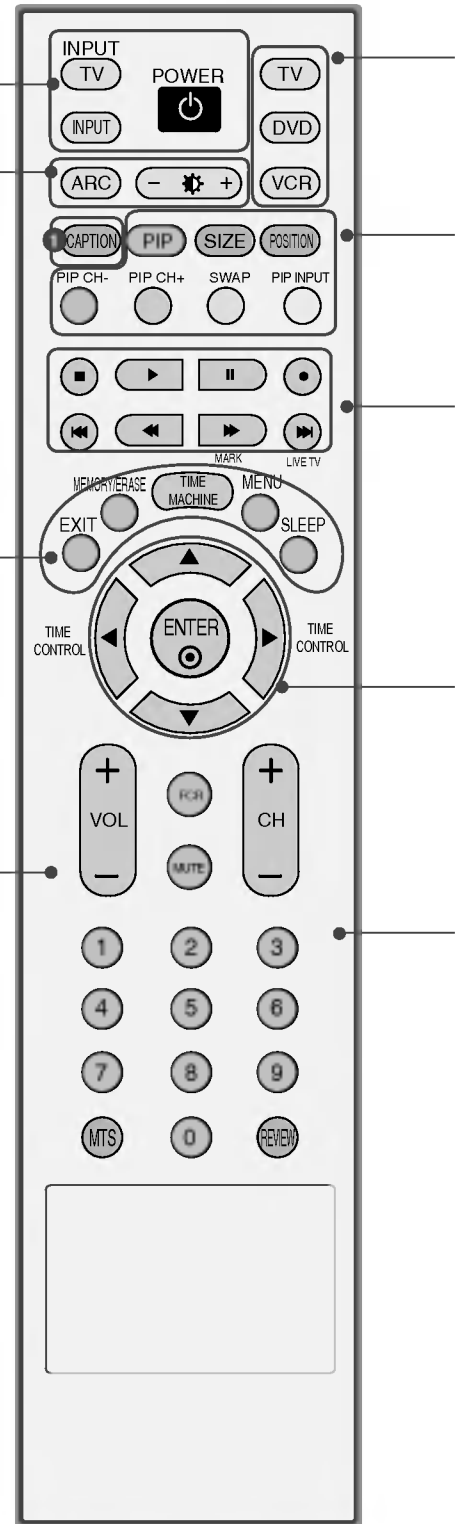

MODE Selects the remote operating mode: TV, VCR, DVD.

PIP Switches the sub picture PIP, DW, POP mode. ▶ **p.44**

SIZE Adjusts the sub picture size. ▶ **p.45**

POSITION Moves the sub picture. ▶ **p.45**

PIP CH - /+ Selects a channel for the sub picture. ▶ **p.44**

SWAP Alternates between main and sub picture.

PIP INPUT Select the connected input source for the sub-picture. ▶ **p.44**

VCR/DVD control buttons Control video cassette recorders or DVD players. These buttons are used for X Studio. For further details, see the 'X Studio' section.

MARK Selects the wanted functions. ▶ **p.40**

LIVE TV In TV, AV1, AV2, Component 1/2 480i modes, screen returns to the live program. ▶ **p.40**

THUMBSTICK (Up/Down/Left/Right/ENTER) Navigate the on-screen menus and adjust the system settings to your preference.

NUMBER button Scroll through the programmed Favorite channels.

MTS Selects the MTS sound: **Mono**, **Stereo**, or **SAP**. ▶ **p.65**

REVIEW Tune to the last channel viewed.

Installing Batteries

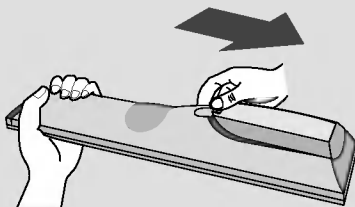

- Open the battery compartment cover on the back side and install the batteries matching correct polarity (+with +,-with -).
- Install two 1.5V AA batteries. Don't mix old or used batteries with new ones.
- Close cover.

Remote control effective range



- Use a remote control up to 7 meters distance and 30 degree (left/right) within the receiving unit scope.
- Dispose of used batteries in a recycle bin to preserve environment.

INTRODUCTION

HOME MENU

This menu is a contents guide.

In Home Menu, you enter the Recorded list of DVR, Manual Rec, Scheduled List or TV Menu.

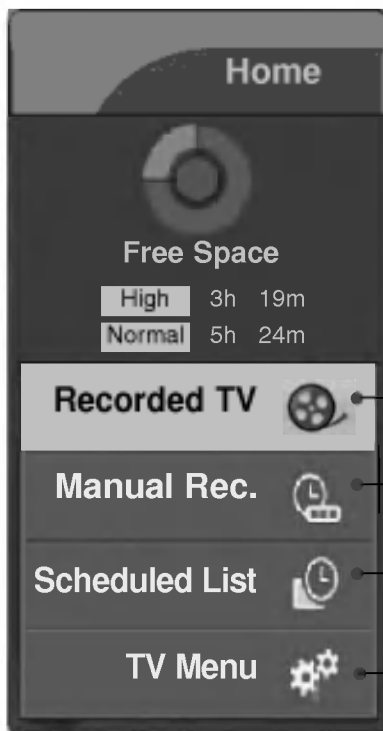
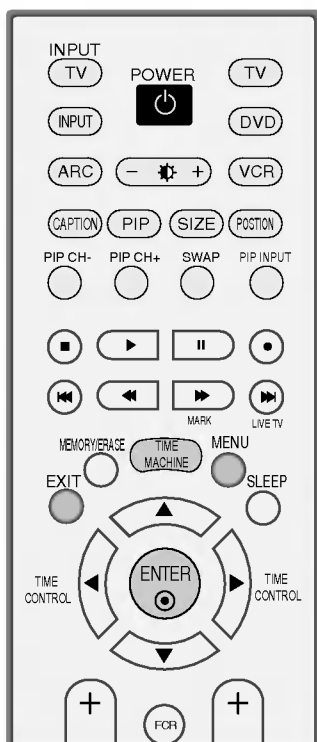

DVR
▶ p.32

TV Menu
▶ p.46

INSTALLATION

BASIC CONNECTION

- 1 Hold the **CABLE MANAGEMENT** with both hands and push it as shown.

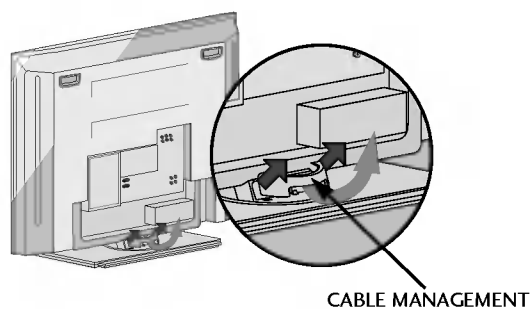

- 2 Connect the cables as necessary.
To connect an additional equipment, see the **External equipment Connections** section.

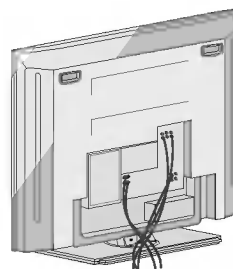

- 3 Reinstall the **CABLE MANAGEMENT** as shown.

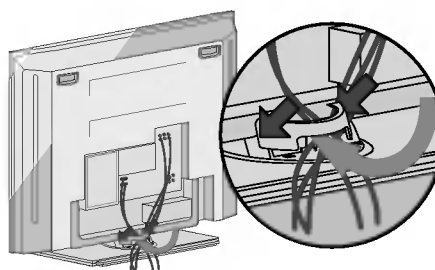

INSTALLATION

ATTACHING THE TV TO A WALL

- Set it up close to the wall so the set doesn't fall over when it is pushed backwards.
- The instructions shown below is a safer way to set up the set, which is to fix it on the wall so the set doesn't fall over when it is pulled in the forward direction. It will prevent the set from falling forward and hurting people. It will also prevent the set from damage caused by fall. Please make sure that children don't climb on or hang from the set.

INSTALLATION

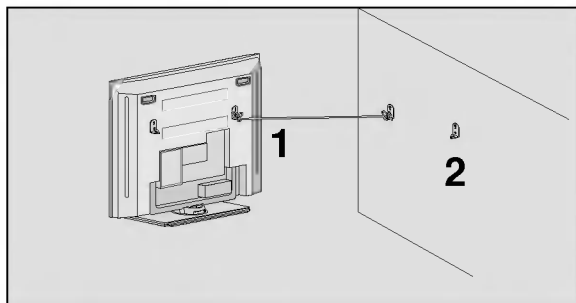

- 1 Use the eye-bolts or set brackets/bolts to fix the set to the wall as shown in the picture. (If your set has the bolts in the eye-bolts position before inserting the eye-bolts, loosen the bolts.)
* Insert the eye-bolts or set brackets/bolts and tighten them securely in the upper holes.
- 2 Secure the wall brackets with the bolts (not provided as parts of the set, must purchase separately) on the wall. Match the height of the bracket that is mounted on the wall.

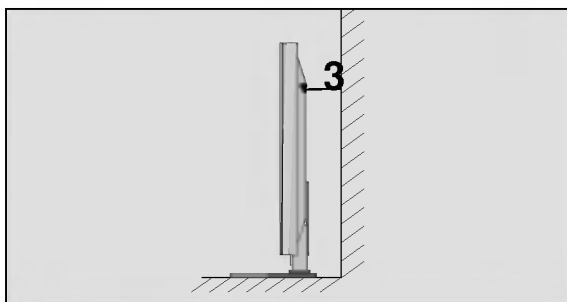

- 3 Use a sturdy rope (not provided as parts of the set, must purchase separately) to tie the set. It is safer to tie the rope so it becomes horizontal between the wall and the set.

NOTE

- ▶ When moving the set to another place undo the ropes first.
- ▶ Use a set holder or a cabinet that is big and strong enough for the size and weight of the set.
- ▶ To use the set safely make sure that the height of the bracket that is mounted on the wall is same as that of the set.

SWIVEL FUNCTION

- After installing the TV, you can adjust the the TV set manually turning it to the left or right direction by 20 degrees to suit your viewing position.

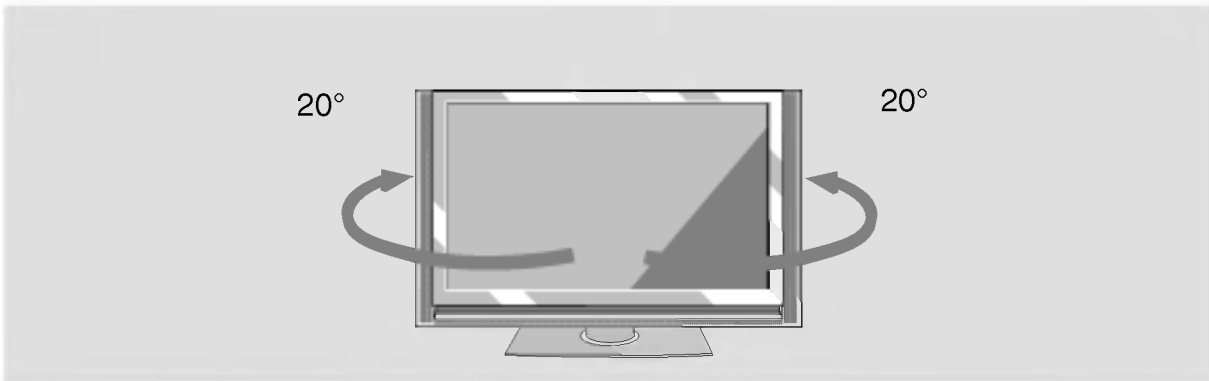

- Before adjusting the angle, you must loosen (to the left) the shaft bolt on the middle of stand's back. And when you acheve the desired position, you must close the shaft bolt to set the hole.(As shown below)

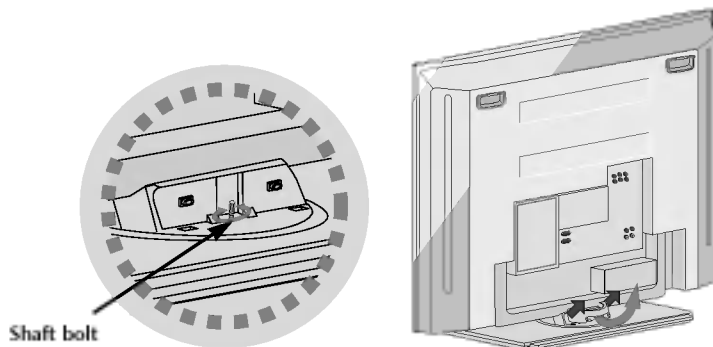

INSTALLATION

STAND INSTALLATION

- The set can be installed in various ways such as on a wall, or on a desktop etc.
- The set is designed to be mounted horizontally.

GROUNDING

Ensure that you connect the earth ground wire to prevent possible electric shock. If grounding methods are not possible, have a qualified electrician install a separate circuit breaker. Do not try to ground the unit by connecting it to telephone wires, lightening rods, or gas pipes.

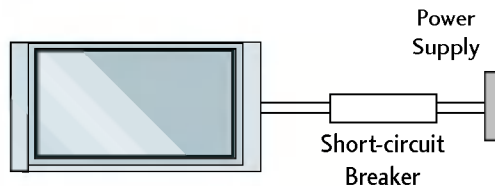

Desktop Pedestal Installation

For proper ventilation, allow a clearance of 4" on each side and from the wall.

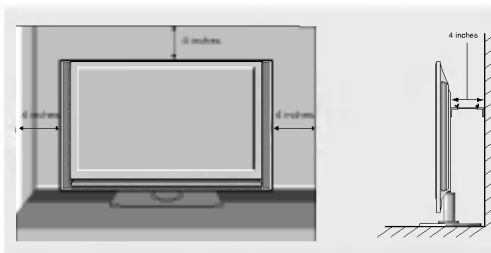
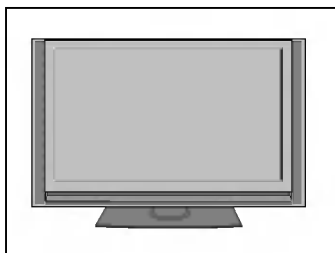

Wall Mount: Horizontal installation

For proper ventilation, allow a clearance of 4" on each side and from the wall. Detailed installation instructions are available from your dealer, see the optional Tilt Wall Mounting Bracket Installation and Setup Guide.

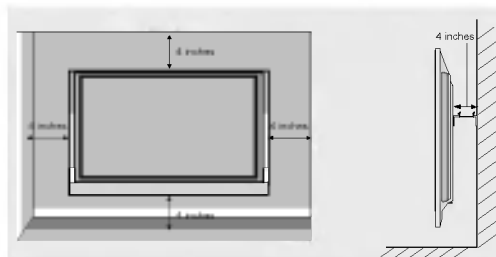
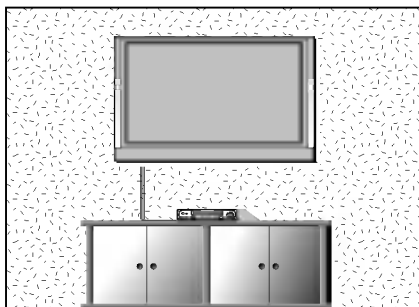

CONNECTIONS & SETUP

- To prevent the equipment damage, never plug in any power cords until you have finished connecting all equipment.

ANTENNA CONNECTION

Wall Antenna Socket or Outdoor Antenna without a Cable Box Connections.
For optimum picture quality, adjust antenna direction if needed.

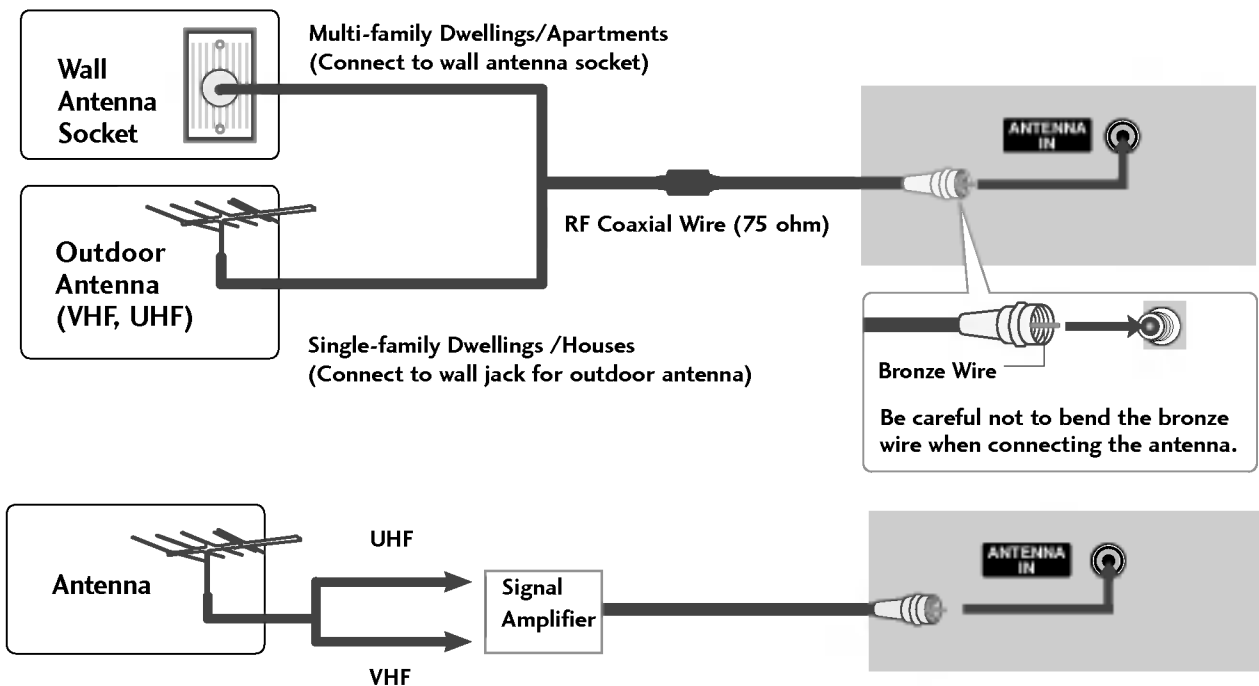

- To improve the picture quality in a poor signal area, please purchase a signal amplifier and install properly.
- If the antenna needs to be split for two TV's, install a 2-Way Signal Splitter.
- If the antenna is not installed properly, contact your dealer for assistance.

NOTE

- ▶ The TV will let you know when the analog and cable scans are complete.

CONNECTIONS & SETUP

VCR SETUP

- To avoid picture noise (interference), leave an adequate distance between the VCR and TV
- If the 4:3 picture format is used; the fixed images on the sides of the screen may remain visible on the screen. This phenomenon is common to all manufactures and in consequence the manufactures warranty does not cover the product bearing this phenomenon.

When connecting with an antenna

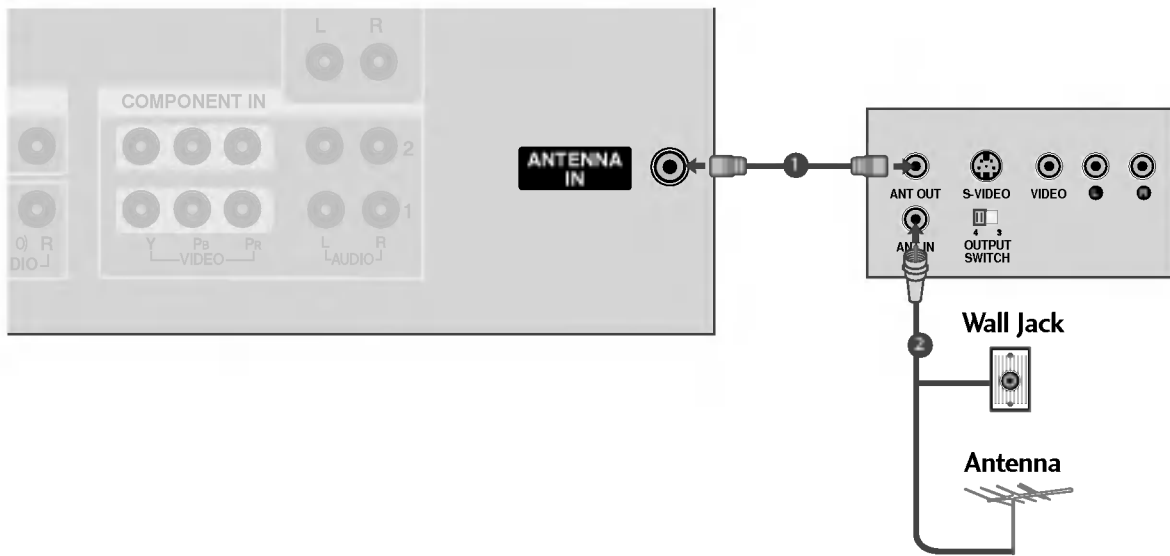

1. How to connect

- 1 Connect the RF antenna out socket of the VCR to the **Antenna** socket on the set.
- 2 Connect the antenna cable to the RF antenna in socket of the VCR.

2. How to use

- Set VCR output switch to 3 or 4 and then tune TV to the same channel number.
- Insert a video tape into the VCR and press PLAY on the VCR. (Refer to the VCR owner's manual.)

When connecting with a RCA cable

1. How to connect

- 1 Connect the **AUDIO/VIDEO** jacks between TV and VCR. Match the jack colors (Video = yellow, Audio Left = white, and Audio Right = red)

2. How to use

- Insert a video tape into the VCR and press PLAY on the VCR. (Refer to the VCR owner's manual.)
- Select **AV1** input source with using the **INPUT** button on the remote control.
- If connected to **AV IN2**, select **AV2** input source.

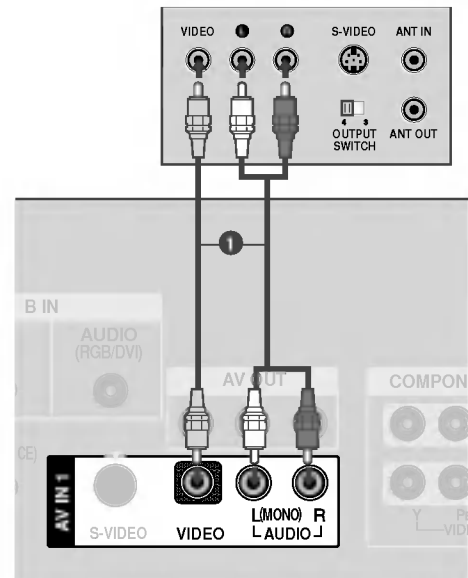

NOTE

- ▶ If you have a mono VCR, connect the audio cable from the VCR to the **AUDIO L/MONO** jack of the set.

When connecting with an S-Video cable

1. How to connect

- 1 Connect the S-VIDEO output of the VCR to the **S-VIDEO** input on the set.
- 2 Connect the audio outputs of the VCR to the **AUDIO** input jacks on the set.

2. How to use

- Insert a video tape into the VCR and press PLAY on the VCR. (Refer to the VCR owner's manual.)
- Select **AV1** input source with using the **INPUT** button on the remote control.
- If connected to **AV IN2**, select **AV2** input source.

NOTE

- ▶ The picture quality is improved: compared to normal composite (RCA cable) input.

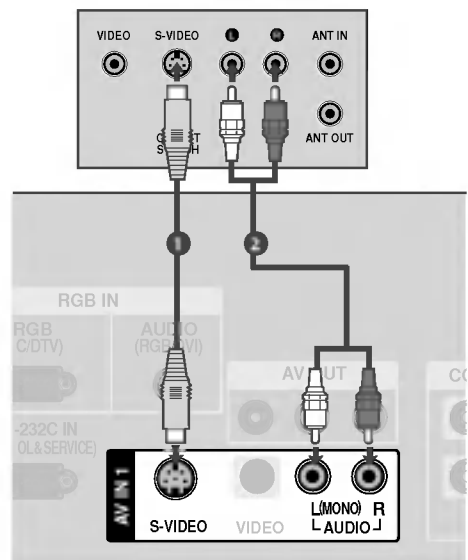

CAUTION

- ▶ Do not connect to both Video and S-Video at the same time. In the event that you connect both Video and the S-Video cables, only the S-Video will work.

CONNECTIONS & SETUP

EXTERNAL EQUIPMENT CONNECTIONS

1. How to connect

- 1 Connect the **AUDIO/VIDEO** jacks between TV and external equipment. Match the jack colors. (Video = yellow, Audio Left = white, and Audio Right = red)

2. How to use

- Select **AV1** input source with using the **INPUT** button on the remote control.
- If connected to **AV IN2** input, select **AV2** input source.
- Operate the corresponding external equipment.

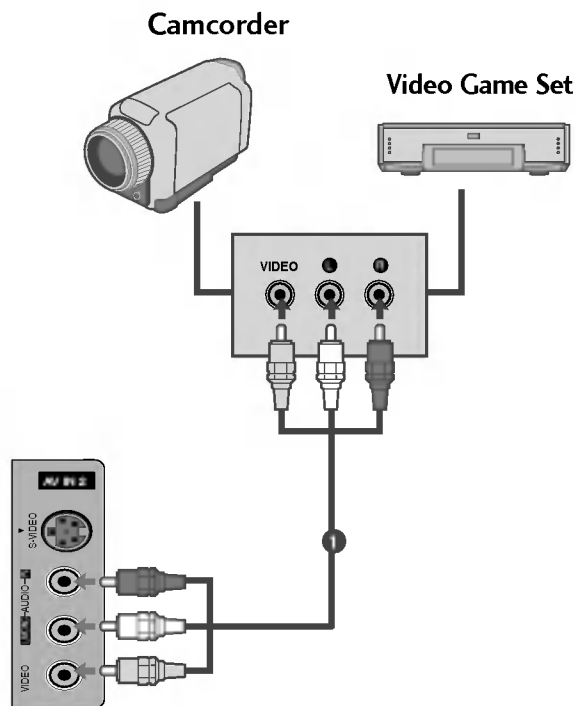

EXTERNAL STEREO

Use to connected either an external amplifier, or add a sub-woofer to your surround sound system.

1. How to connect

- 1 Connect the input jack of the stereos amplifier to the **VARIABLE AUDIO OUT** jacks on the set.
- 2 Set up your speakers through your analog stereo amplifier, according to the instructions provided with the amplifier.

NOTE

- ▶ When connecting with external audio equipments, such as amplifiers or speakers, please turn the TV speakers off. (▶ p.64)

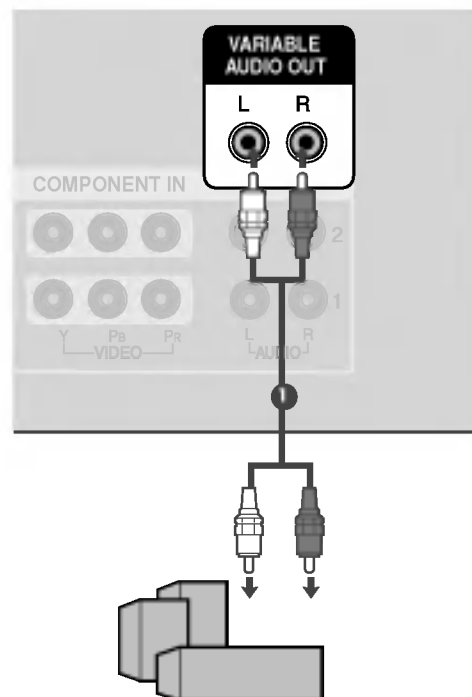

AV OUT SETUP

The TV has a special signal output capability which allows you to hook up the second TV or monitor.

1. How to connect

- 1 Connect the second TV or monitor to the TV's **AV OUT** jacks.
- 2 See the Operating Manual of the second TV or monitor for further details regarding that device's input settings.

! NOTE

- ▶ Component, RGB, HDMI input sources cannot be used for AV out.
- ▶ We recommend to use the AV OUT jacks for VCR recording.

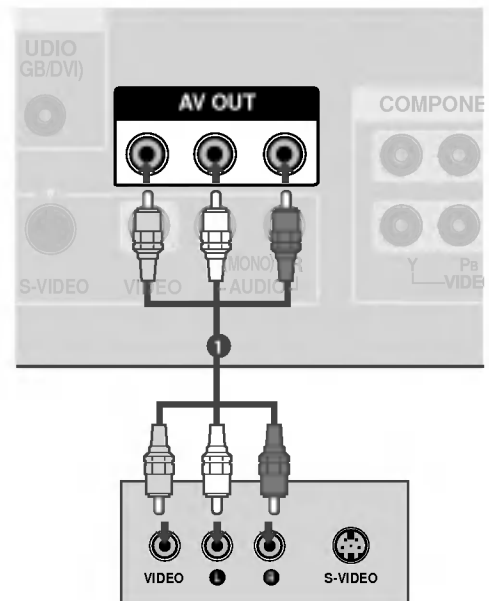

CONNECTIONS & SETUP

DVD SETUP

When connecting with a component cable

1. How to connect

- 1 Connect the video outputs (Y, PB, PR) of the DVD to the **COMPONENT IN VIDEO1** jacks on the set. Match the jack colors (Y = green, PB = blue, and PR = red).
- 2 Connect the audio outputs of the DVD to the **COMPONENT IN AUDIO1** jacks on the set.

2. How to use

- Turn on the DVD player, insert a DVD.
- Select **COMPONENT 1** input source with using the **INPUT** button on the remote control.
- If connected to **COMPONENT IN 2** input, select **COMPONENT 2** input source.
- Refer to the DVD player's manual for operating instructions.

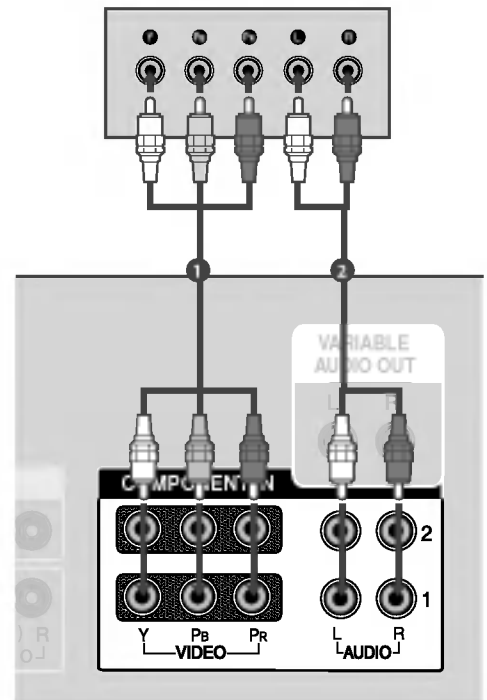

Component Input ports

To get better picture quality, connect a DVD player to the component input ports as shown below.

| | | | |
|----------------------------------|---|-----|-----|
| Component ports on the TV | Y | Pb | Pr |
| Video output ports on DVD player | Y | Pb | Pr |
| | Y | B-Y | R-Y |
| | Y | Cb | Cr |
| | Y | Pb | Pr |

When connecting with an S-Video cable

1. How to connect

- 1 Connect the S-VIDEO output of the DVD to the **S-VIDEO** input on the set.
- 2 Connect the audio outputs of the DVD to the **AUDIO** input jacks on the set.

2. How to use

- Turn on the DVD player, insert a DVD.
- Select **AV1** input source with using the **INPUT** button on the remote control.
- If connected to **AV IN2**, select **AV2** input source.
- Refer to the DVD player's manual for operating instructions.

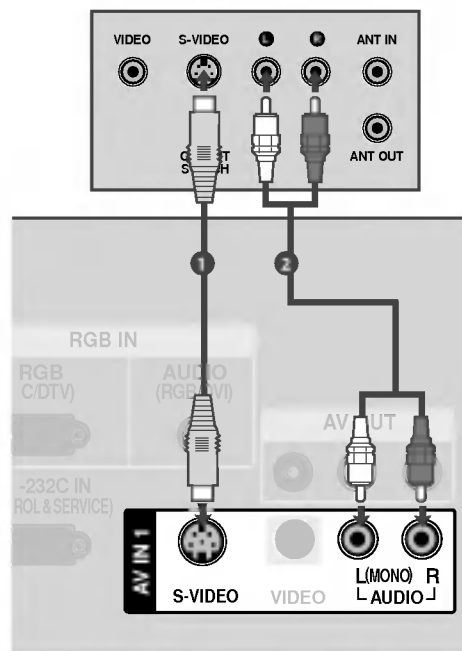

When connecting HDMI cable

1. How to connect

- 1 Connect the HDMI output of the DVD to the **HDMI IN 1 (DVI) or 2** jack on the set.
- 2 No separated audio connection is necessary.

2. How to use

- Select **HDMI1/DVI** or **HDMI2** input source with using the **INPUT** button on the remote control.
- Refer to the DVD player's manual for operating instructions.

NOTE

- ▶ If the DVD supports Auto HDMI function, the DVD output resolution will be automatically set to 1280x720p.
- ▶ If the DVD does not support Auto HDMI, you need to set the output resolution appropriately.

To get the best picture quality, adjust the output resolution of the DVD to 1280x720p.

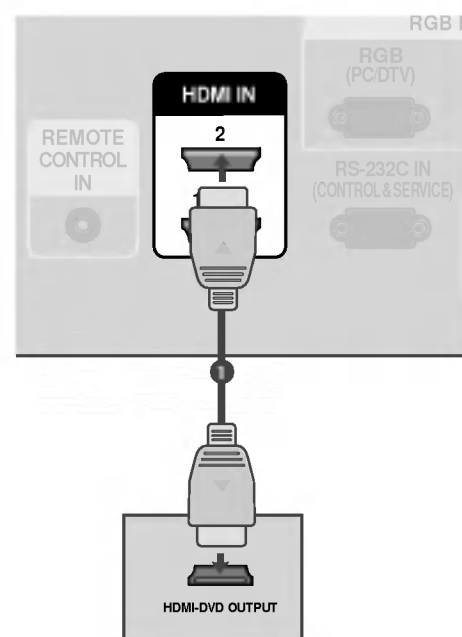

CONNECTIONS & SETUP

HDSTB SETUP

When connecting with a component cable

1. How to connect

- 1 Connect the video outputs (Y, PB, PR) of the digital set top box to the **COMPONENT IN VIDEO 1** jacks on the set. Match the jack colors (Y = green, PB = blue, and PR = red).
- 2 Connect the audio output of the digital set-top box to the **COMPONENT IN AUDIO 1** jacks on the set.

2. How to use

- Turn on the digital set-top box.
(Refer to the owner's manual for the digital set-top box.)
- Select **COMPONENT 1** input source with using the **INPUT** button on the remote control.
- If connected to **COMPONENT IN2** input, select **COMPONENT 2** input source.

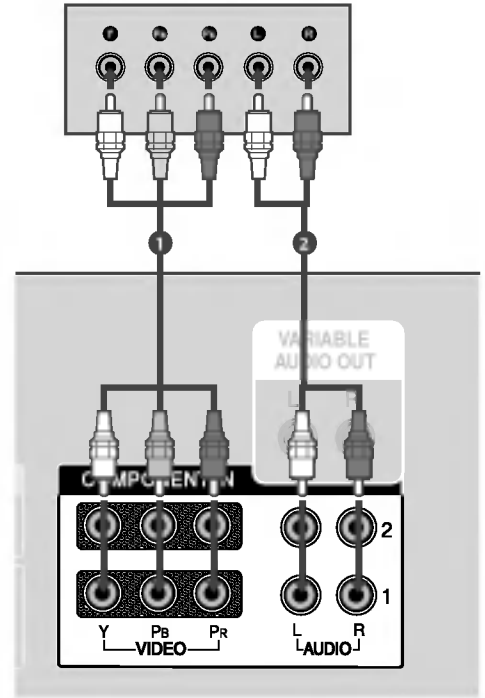

| Signal | Component 1/2 | HDMI1/DVI, RGB-DTV, HDMI2 |
|--------|---------------|---------------------------|
| 480i | Yes | No |
| 480p | Yes | Yes |
| 720p | Yes | Yes |
| 1080i | Yes | Yes |

When connecting with a D-sub 15 pin cable

1. How to connect

- 1 Connect the RGB output of the digital set-top box to the **RGB (PC/DTV)** jack on the set.
- 2 Connect the audio outputs of the set-top box to the **AUDIO (RGB/DVI)** jack on the set.

2. How to use

- Turn on the digital set-top box.
(Refer to the owner's manual for the digital set-top box.)
- Select **RGB-DTV** input source with using the **INPUT** button on the remote control.

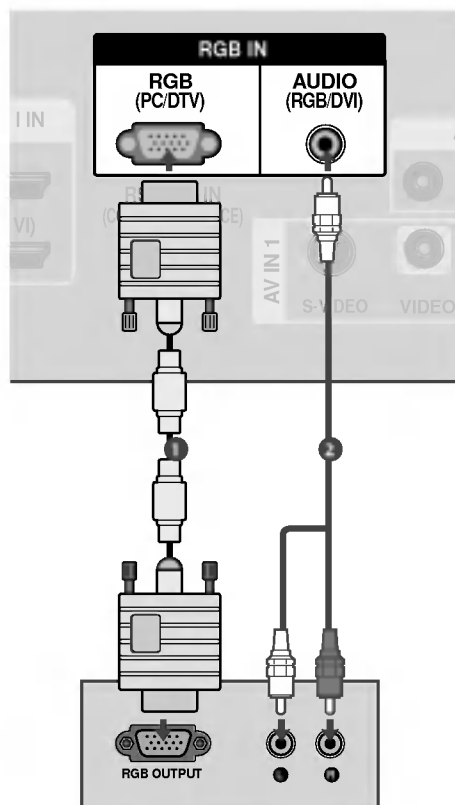

When connecting with a HDMI cable

1. How to connect

- 1 Connect the digital set-top box to **HDMI IN 1 (DVI)** or **2** jack on the set.
- 2 No separated audio connection is necessary.

2. How to use

- Turn on the digital set-top box.
(Refer to the owner's manual for the digital set-top box.)
- Select **HDMI1/DVI** or **HDMI2** input source with using the **INPUT** button on the remote control.

NOTE

- ▶ If the digital set-top box supports Auto HDMI function, the output resolution of the source device will be automatically set to 1280x720p.
- ▶ If the digital set-top box player does not support Auto HDMI, you need to set the output resolution appropriately.
To get the best picture quality, adjust the output resolution of the source device to 1280x720p.

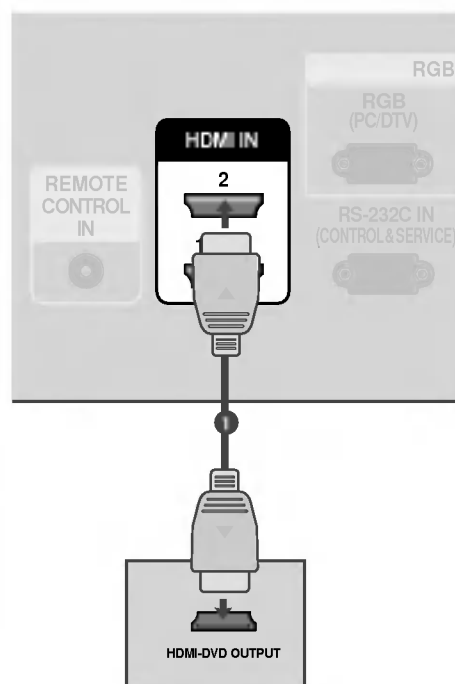

CONNECTIONS & SETUP

When connecting with a HDMI to DVI cable

1. How to connect

- 1 Connect the DVI output of the digital set-top box to the **HDMI IN 1 (DVI)** jack on the set.
- 2 Connect the audio output of the digital set-top box to the **AUDIO(RGB/DVI)** jack on the set.

2. How to use

- Turn on the digital set-top box. (Refer to the owner's manual for the digital set-top box.)
- Select **HDMI1/DVI** input source with using the **INPUT** button on the remote control.

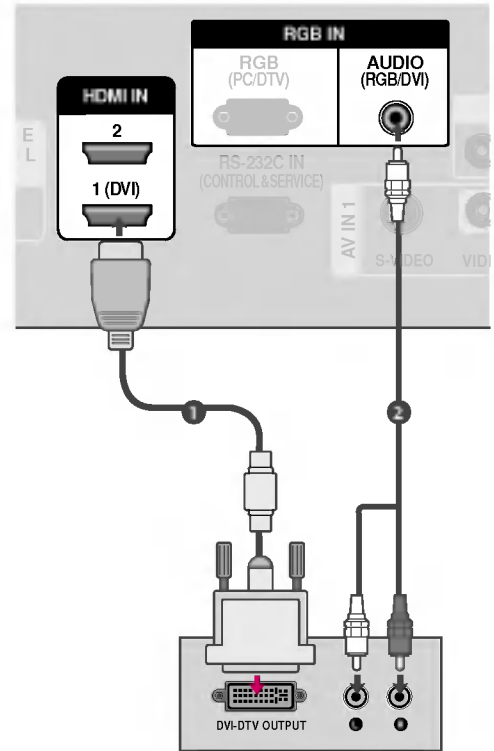

PC SETUP

This TV provides Plug and Play capability, meaning that the PC adjusts automatically to the TV's settings.

When connecting with a D-sub 15 pin cable

1. How to connect

- 1 Connect the RGB output of the PC to the **RGB (PC/DTV)** jack on the set.
- 2 Connect the PC audio output to the **AUDIO (RGB/DVI)** jack on the set.

2. How to use

- Turn on the PC and the set.
- Select **RGB-PC** input source with using the **INPUT** button on the remote control.

NOTE

- ▶ Check the image on your TV. There may be noise associated with the resolution, vertical pattern, contrast or brightness in PC mode. If noise is present, change the PC output to another resolution, change the refresh rate to another rate or adjust the brightness and contrast on the VIDEO menu until the picture is clear. If the refresh rate of the PC graphic card can not be changed, change the PC graphic card or consult the manufacturer of the PC graphic card.

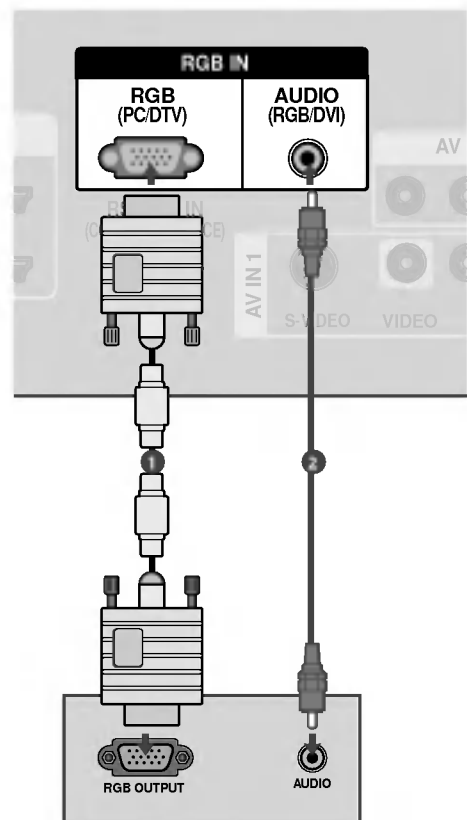

CONNECTIONS & SETUP

When connecting HDMI to DVI cable

1. How to connect

- 1 Connect the DVI output of the PC to the **HDMI IN 1 (DVI)** jack on the set.
- 2 Connect the PC audio output to the **AUDIO (RGB/DVI)** jack on the set.

2. How to use

- Turn on the PC and the set
- Select **HDMI1/DVI** input source with using the **INPUT** button on the remote control.

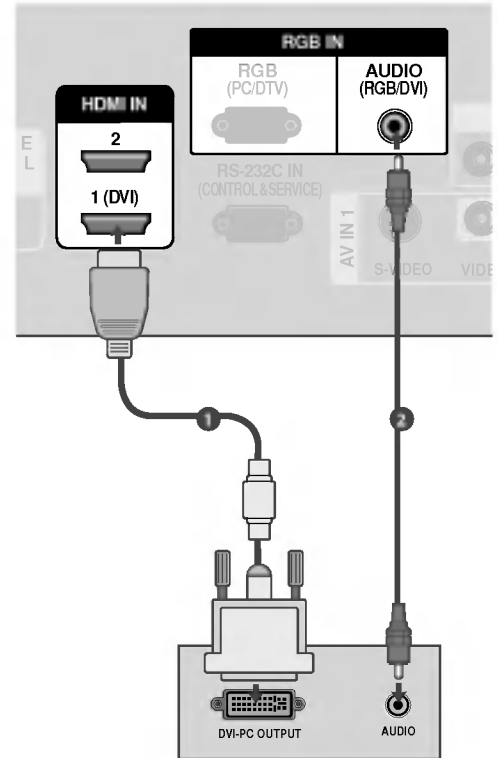

NOTE

- ▶ HDMI2 source does not support DVI source.
- ▶ If the PC has a DVI output and no HDMI output, a separated audio connection is necessary.
- ▶ If the PC does not support Auto DVI, you need to set the output resolution appropriately. To get the best picture quality, adjust the output resolution of PC graphics card's output resolution to 1024x768, 60Hz.

Supported Display Resolution (RGB / HDMI PC mode)

| Resolution | Horizontal Frequency(KHz) | Vertical Frequency(Hz) |
|------------|----------------------------|-------------------------|
| 640x350 | 31.468 | 70.09 |
| 720x400 | 31.469 | 70.08 |
| 640x480 | 31.469 37.500 | 59.94 75.00 |
| 848x480 | 31.500 37.799 39.375 | 60.00 70.00 75.00 |
| 852x480 | 31.500 37.799 39.375 | 60.00 70.00 75.00 |
| 800x600 | 37.879 46.875 | 60.31 75.00 |
| 832x624 | 49.725 | 74.55 |
| 1024x768 | 48.363 56.476 60.023 | 60.00 70.06 75.02 |
| 1152x870 | 68.681 | 75.06 |
| 1280x768 | 47.693 | 59.99 |
| 1360x768 | 47.700 | 60.00 |
| 1366x768 | 47.700 | 60.00 |

NOTE

- ▶ To get the the best picture quality, adjust the PC graphics card to 1024x768, 60Hz (42PB2RR/42PB2RRH), 1360x768, 60Hz(50PB2RR/50PB2RRH).
- ▶ Depending on the graphics card, DOS mode may not work if a HDMI to DVI Cable is in use.
- ▶ When Source Devices connected with HDMI Input, output TV SET Resolution (480p, 720p, 1080i) and TV SET Display fit EIA/CEA-861-B Specification to Screen. If not, refer to the Manual of HDMI Source Devices or contact your service center.
- ▶ If the HDMI Source Device is not connected to the Cable or if there is a poor cable connection, "No signal" is displayed in the HDMI Input. In this case, that Video Resolution is not supported.
- ▶ Avoid keeping a fixed image on the screen for a long period of time. The fixed image may become permanently imprinted on the screen.
- ▶ The synchronization input form for Horizontal and Vertical frequencies is separate.
- ▶ When you use too long RGB-PC cable, there might be a noise on the screen. We recommend using under 5m of the cable. It provides the best picture quality.
- ▶ This set does not support HDMI-PC.

BASIC OPERATION

TURNING THE SET ON

- 1 First, connect power cord correctly.
At this moment, the TV switches to standby mode.
 - In standby mode to turn TV on, press the **⏻/⏻** , **INPUT**, **CH ▲ / ▼** button on the TV or press the **POWER**, **TV**, **INPUT**, **CH +/-**, **Number(0~9)** button on the remote control and then the TV will switch on.

CHANNEL SELECTION

- 1 Press the **CH +/-** or **NUMBER** buttons to select a channel number.

VOLUME ADJUSTMENT

Adjust the volume to suit your personal preference.

- 1 Press the **VOL +/-** button to adjust the volume.
.....
- 2 If you want to switch the sound off, press the **MUTE** button.
.....
- 3 You can cancel the Mute function by pressing the **MUTE**, **VOL +/-** or **MTS** button.

NOTE

- ▶ If you intend to be away on vacation, disconnect the power plug from wall power outlet.

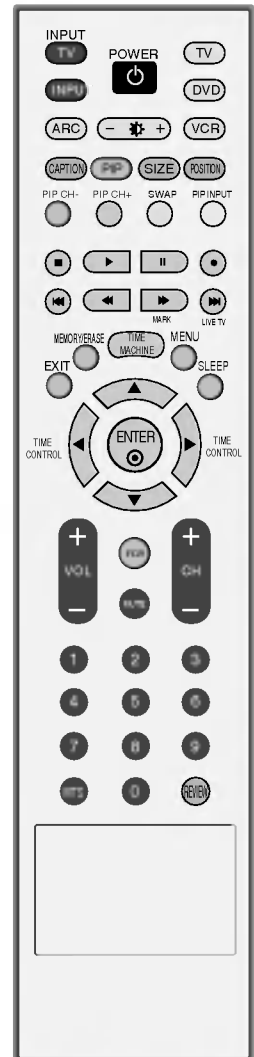

ON-SCREEN MENUS LANGUAGE SELECTION

The menus can be shown on the screen in the selected language.
First select your language.

1 Press the **MENU** button and then use ▲ or ▼ button to select the **SPECIAL** menu.

2 Press the ► button and then use ▲ or ▼ button to select **Language**.

3 Press the ► button and then use ▲ or ▼ button to select your desired language.
From this point on, the on-screen menus will be shown in the selected language.

4 Press the **EXIT** button to return to TV viewing or press **MENU** to return to the previous menu.

SPECIAL FUNCTIONS | DVR (Digital Video Recorder)

TIME CONTROL

- This function allows the unit to automatically record live TV and make it available for reviewing at any time.
- With Time control turned on, you may pause and rewind normal TV viewing at any time without missing any of the live broadcast.

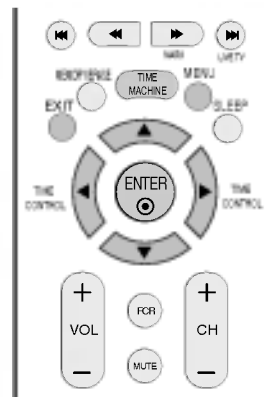

1 Press the **MENU** button and then use ▲ / ▼ button to select the **DVR** menu.

2 Press the ► button and then use ▲ / ▼ button to select the **Time control**.

3 Press the ► button and then use ▲ / ▼ button to select **On** or **Off**.

4 Press the **EXIT** button to return to normal TV viewing.



1



2 3

PROGRESSING THE TIME CONTROL FUNCTION



1 After selecting the **Time control On**, press the **ENTER** button.

- As soon as Time control starts, a progress bar indicating the current recording status is displayed in the bottom of the screen.
- Press the **EXIT** button to hide the 'Progress Bar' or press the **ENTER** button to display the 'Progress Bar'.
- This function is preserved even change a programme on progressing the Time control.

2 When finishing the Time control function, enter the option menu and turn **Time control Off**.

The 'Progress Bar'?

This function indicates a possible DVR reshooting section, a current on-screen and real on-broadcasting position, a section of section-recording.

- 1 Status of current displayed video.
- 2 Current save time.
- 3 15 minute intervals from Time control start time. (Total - one hour).
- 4 Indicates current Time control position.

NOTE

- ▶ DVR (Digital Video Recorder) : A device which records and plays broadcast program contents onto a hard disk in set or SET TOP BOX.
- ▶ In order to save hard-disk space, nothing is saved when there is no signal.
- ▶ The total storage space of the hard-disk is 80 GB. 4GB minimum is reserved for Time control.
- ▶ When turning power on, it may take up to maximum 3 minutes to initialize the HDD.
- ▶ The Recording function will not initiate for a copy-protected program.
- ▶ Because an analog broadcast is transferred to a digital signal, video that contains rapid movement may show "cross stripes". This happens when the analog signal is compressed and then restored in the digital signal. The unit will attempt to reduce this excessive picture noise.
- ▶ When using the PIP/DW, POP mode, Time control is stopped.
- ▶ Time control is available in TV, AV1, AV2, Component 1/2 (480i) mode.
- ▶ Time control is not available for Audio only channels.

SPECIAL FUNCTIONS | DVR (Digital Video Recorder)

Progressing the Time control function, play

- On progressing Time control, It can do a diversified playing.



Indicates that the current broadcast and displayed video differ.

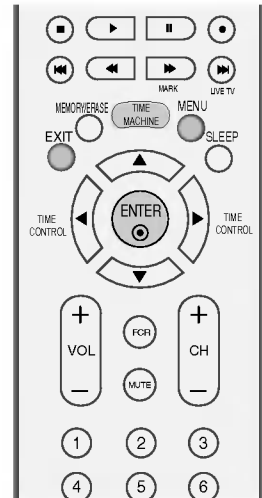
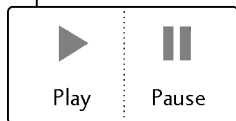

Using the remote control

You can shift playback to any point within playing the recorded program



When playing,

repeatedly, press the **REW**() button to speed up

->  -> .

repeatedly, press the **FF**() button to speed up

->  -> .

- Pressing these buttons repeatedly increases the fast forward/reverse speed.



Press the  or  button to move back and forth within the current program.



- Press the  button to jump at the front of the programme.





- Pressing the  button to jump at the end of the programme.

Press the  button to jump about 20 seconds forward.



- Pressing the  button to jump about 8 seconds backward.





During playback, press the **Pause**() button.

- Still screen is displayed.
- Repeatedly press the **Pause**() button to advance frame by frame.



- Press the **Pause**() button and then use the **FF**() button for slow motion (as showing the ).



- When using the  or  button during playback the cursor can be viewed on the screen.



Press the **PLAY**() button to return to normal playback.

If you want to return to the current live broadcast, press the  button.

RECORDING

- Use this function to record the program you are watching on the main screen.
- If you apply Main power off before finish recording it is not recorded the programs that was recording before.

Instant Record

This function records the currently displayed programme.

1 Select the desired programme to record and then press the **REC** button. During recording **REC** is displayed. Use this feature to record up to 2 hours of programming.

2 If you want to stop recording, press the **STOP** button.

■ While recording, if you press the **STOP** button fewer than 10 seconds, this message is displayed.

■ If you press the **STOP** button more than 10 seconds, this message is displayed.

Recording is not completed.
Recording time must exceed 10 seconds.

Recording is completed.

3 You can add/subtract recording time by pressing the **STOP** button while recording. Press the **◀** or **▶** button repeatedly to add/subtract to the recording time. Each time you press **◀** or **▶** button the recording duration changes as shown below.

No Change

➔ +10min ➔ +20min ➔ +30min ➔ +40min ➔ +50min ➔ +60min

➔ -10min ➔ -20min ➔ -30min ➔ -40min ➔ -50min ➔ -60min

SPECIAL FUNCTIONS | DVR (Digital Video Recorder)

The extra recording time added to existing setting equals the final recording time.

- 4 After adjusting the recording time, select **ENTER**. The Status bar will be displayed.

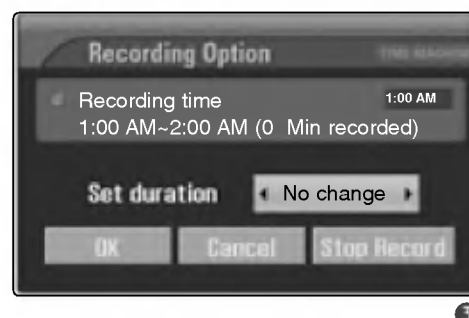
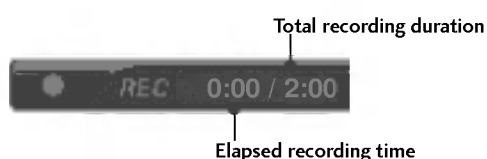

- Press the **EXIT** button to hide the Status bar. Press the **ENTER** button to display the Status bar.

- 5 Recording stops when the selected duration is reached or when you press the **STOP** button. Although recording has stopped, the Time control feature remains active.

NOTE

- ▶ When recording, if the available storage space becomes low, the recording will be automatically stopped.
- ▶ Recordings of less than 10 seconds will not be saved.
- ▶ To save disk space while recording broadcasts, no data will be saved if there is no signal.
- ▶ The recording function will not initiate for a copy-protected program.
- ▶ The displayed time slightly differ from the actual time.
- ▶ In no signal or film source, the displayed time slightly differ from the actual time.

- ▶ The recording can not be used with content-protected programs on progressing Time control .

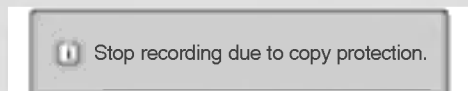

- ▶ If the old tape is recorded, this may cause damage to the recording quality.
- ▶ It will be stored separately the programme according to the colour system signal.

WATCHING & RECORD

- While recording, you can change programmes or inputs without disturbing the recording. The broadcast being recorded can be shown in the lower-right corner of the main screen.

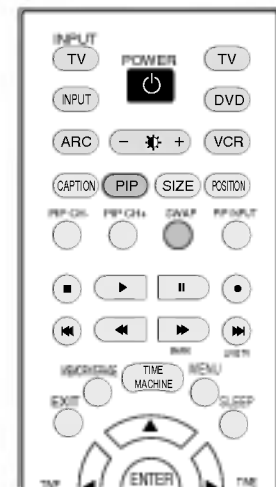

screen being recorded

- 1 After starting an Instant Record or Reserved Record, change the programme or input.
 - You can check the show being recorded in the lower-right corner the main screen (as shown right).
 - Press the **PIP** button to hide or show the program being recorded.
 - Press the **SWAP** button to return to the program being recorded in Watching & Record.
 - When changed to the programme recorded in Watching & Record, the screen is changed to Instant Record state or Reserved Record state.

| Record | Analog | AV1 | AV2 | Component 1/2(480i) |
|-------------|--------|-----|-----|---------------------|
| Watching | | | | |
| Analog | 0 | 0 | 0 | 0 |
| AV1 | 0 | x | 0 | 0 |
| AV2 | 0 | 0 | x | 0 |
| Component 1 | 0 | 0 | 0 | x |
| Component 2 | 0 | 0 | 0 | x |
| RGB | 0 | 0 | 0 | 0 |
| HDMI1/DVI | 0 | 0 | 0 | 0 |
| HDMI2 | 0 | 0 | 0 | 0 |

Watching & Record Input

* It's not available to select same channel in Analog mode.

CAUTION

- ▶ If you turn the power off on recording, this message is displayed as shown below.

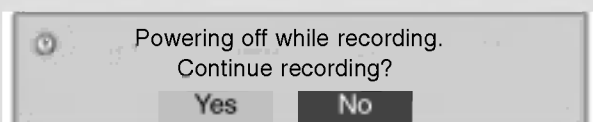

- ▶ If you selects No, recording stops and then power is off.
- ▶ If you selects Yes, recording continues and the power is turned off.

SPECIAL FUNCTIONS | DVR (Digital Video Recorder)

RECORDED TV

- You can watch the recorded program list at a glance.
- This function is available to use in DVR menu.

- 1 Press the **TIME MACHINE** button to display **HOME** menu. Use the **▲** or **▼** button to select the **Recorded TV** and then use the **ENTER** or **▶** button.

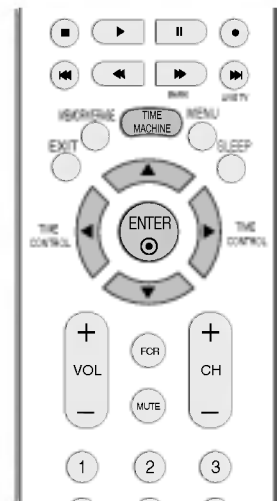
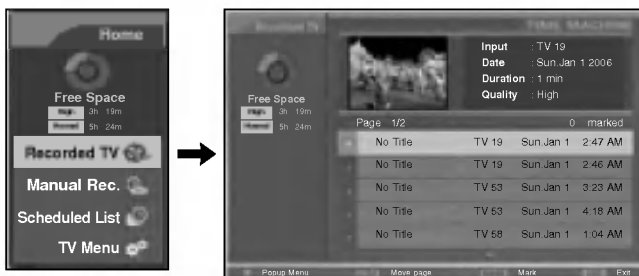

RECORDED PROGRAM SELECTION AND POPUP MENU

- The thumbnail recorded list is shown above.

- 1 Use the **CH+** or **CH-** button for page up/down navigation.

- 2 Use the **MARK** button to delete from the list. A is displayed next to the thumbnail photo if an item is marked.

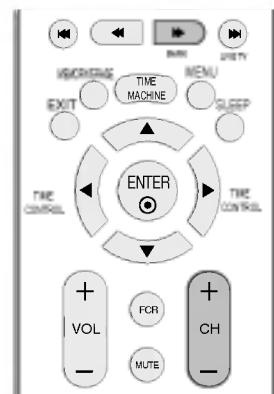

- 3 Use ▲▼◀▶ button to navigate the appropriate thumbnail photo, then press the **ENTER** button to open the Pop-up Menu.
 - ▶ **Play** : Begin playback of selected recording.
 - ▶ **Mark All** : mark all photos on the screen.
 - ▶ **Unmark All** : Change marked photos to unmarked photos.
 - ▶ **Delete** : Delete the selected recording.
 - ▶ **Rename** : Edit recorded program title.
 - ▶ **Cancel** : Close the Pop-up Menu.



- 4 Repeatedly, press **EXIT** button to return to TV viewing or press **TIME MACHINE** button to return to the **Home** menu.
 - If the HDD has a problem performing a function (Recording) related to the DVR, this message is displayed.
 - If the temperature is below zero (0°), a warning message is displayed and you need to initialize the HDD.

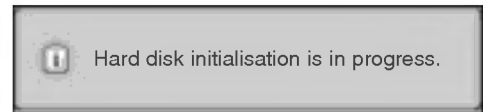

4

PLAYING RECORDED PROGRAMS

- You can play the selected program in the recorded program list.

- 1 Play a recorded program.
- 2 While playing, You can see a diversified playback screen as shown below.
 - At first, an icon showing current playback mode is displayed as marking **▶ PLAYING**. Then press the **ENTER** button to display the progress bar
 - To stop displaying the recorded programs icon, press the **EXIT** button.



































The 'Progress Bar'?

This function indicates a possible DVR reshewing section ,a current on-screen and real on-broadcasting position, a section of section-recording.

- 1 Indicates movement of recorded program.
- 2 Indicates status of recorded program.
- 3 Indicates elapsed playback time.
- 4 Indicates total playback time.
- 5 Indicates a quarter of program runtime.
- 6 Indicates current playback position.

USING THE REMOTE CONTROL

You can shift playback to any point within playing the recorded program.

| | |
|---|---|
|  | <p>When playing,</p> <p>repeatedly, press the REW() button to speed up  ->  -> </p> <p>->  -> .</p> <p>repeatedly, press the FF() button to speed up  ->  -> </p> <p>->  -> .</p> <ul style="list-style-type: none"> Pressing these buttons repeatedly increases the fast forward/reverse speed. |
|  | <p>Press the  or  button to move back and forth within the current program.</p> <ul style="list-style-type: none"> Press the  button to jump at the front of the programme. Pressing the  button to jump at the end of the programme. <p>Press the  button to jump about 20 seconds forward.</p> <ul style="list-style-type: none"> Pressing the  button to jump about 8 seconds backward. |
|  | <p>During playback, press the Pause() button.</p> <ul style="list-style-type: none"> Still screen is displayed. Repeatedly press the Pause() button to advance frame by frame. Press the Pause() button and then use the FF() button for slow motion (as showing the ) .) |
|  | <ul style="list-style-type: none"> When using the  or  button during playback the cursor can be viewed on the screen. |
|  | <p>Press the PLAY() button to return to normal playback.</p> |
|  | <ul style="list-style-type: none"> If you press the STOP() button, you can watch set. |

MANUAL RECORDING

- This function is easy to register to reserved recording.
- This function is available to use in DVR menu.
- When Manual Recording, it's stored the default sound of the set.

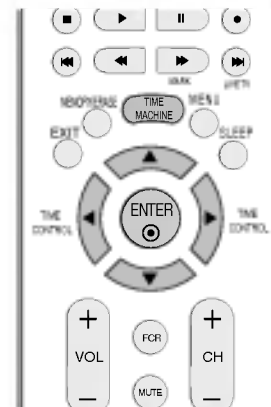

1 Press the **TIME MACHINE** button to display **Home** menu. Use the **▲** or **▼** button to select the **Manual Rec** and then use the **ENTER** or **▶** button.

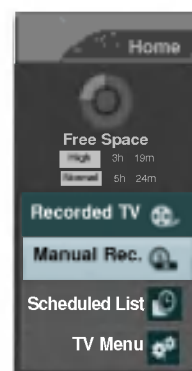

2 **Manual Rec** screen is displayed as shown below. Use the **▲▼◀▶** button to set the **Input, TV, Date, Time, Duration, Frequency** .

- ▶ **Input** : Select the input source from the TV, AV1, AV2, Component1, Component2.
- ▶ **TV** : Select either the current program or a scanned program.
- ▶ **Date** : You can select a date up to one month in the future.
- ▶ **Time /Duration** : Ensure you have set correctly.
- ▶ **Frequency** : Choose among Once, Daily and Weekly.



3 After setting the **Manual Rec**, press the **ENTER** button.

SPECIAL FUNCTIONS | DVR (Digital Video Recorder)

SCHEDULED LIST

- You can store up to 8 programmes.
- This function is available to use in DVR menu.

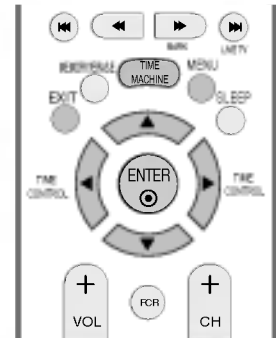

- 1 Press the **TIME MACHINE** button to display **Home** menu. Use the **▲** or **▼** button to select the **Scheduled List** and then use the **ENTER** or **▶** button.
- 2 **Scheduled List** screen is displayed as shown below. Use the **▲▼** button to select recorded programme.

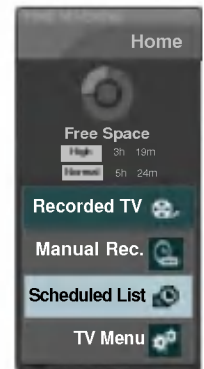

SPECIAL FUNCTIONS

VIDEO QUALITY

- It's not available to use this function on recording programme.

- 1 Press the **MENU** button and then use **▲ / ▼** button to select the **DVR** menu.
- 2 Press the **▶** button and then use **▲ / ▼** button to select the **Video Quality**.
- 3 Press the **▶** button and then use **▲ / ▼** button to select **High** or **Normal**.
- 4 Press the **EXIT** button to return to normal TV viewing.

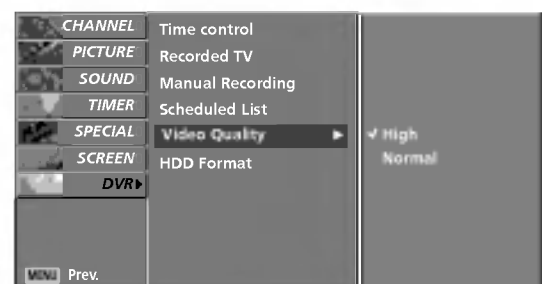

FORMAT HARD DISK

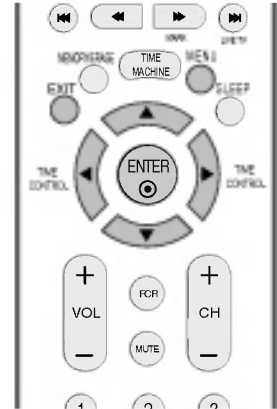

- 1 Press the **MENU** button and then use ▲ / ▼ button to select the **DVR** menu.
- 2 Press the ► button and then use ▲ / ▼ button to select the **HDD Format**.
- 3 Press the ► button to start **HDD Format**.



- if you press the ► button, this message is displayed.

Do you want to format HDD?

Yes No

- if you selects Yes, this message is displayed.

ⓘ Hard disk formatting is in progress.

- When completing, this message is displayed.

ⓘ Hard disk formatting is completed.



- 4 Press the **EXIT** button to return to normal TV viewing.

SPECIAL FUNCTIONS | PIP / DOUBLE WINDOW / POP

PIP lets you view 2 different inputs (sources) on your TV screen at the same time. One source will be large, and the other source will show a smaller inset image. Double Window mode splits the screen into two images, allowing two picture sources to be shown on the TV screen at the same time. Each source is given half the screen.

Watching PIP/Double Window/POP

Press the **PIP** button to access the sub picture. Each press of PIP changes the PIP options as shown below.

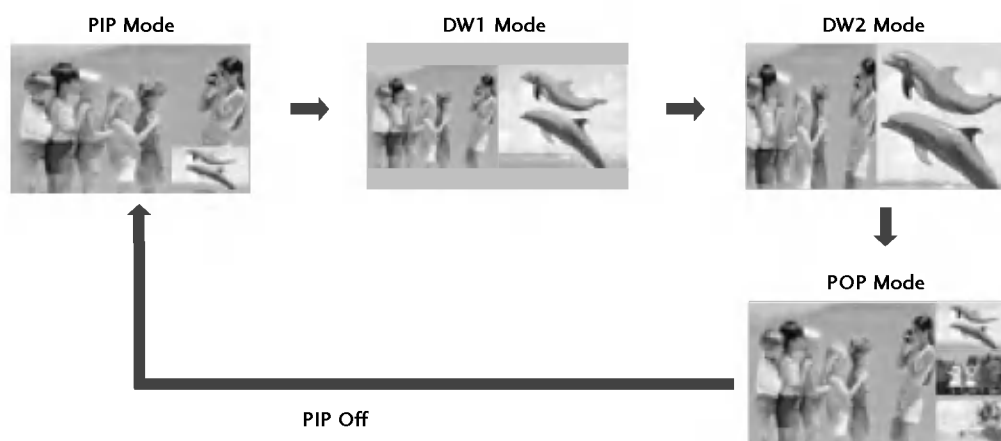

TV Program Selection for PIP

- 1 Use the **PIP CH +/-** button to select a channel for the sub picture. The selected channel number is displayed just below the input source of main picture.

Selecting an Input Signal Source for the PIP/Double Window

Use the **PIP INPUT** button to select the input source for the sub picture. Each press of **PIP INPUT** button changes the PIP source.

| Main Picture Source | Available Sub Picture Sources | |
|---------------------|-------------------------------|-----|
| | PIP/DW | POP |
| TV | All | TV |
| AV1 | All (Except AV1) | |
| AV2 | All (Except AV2) | |
| Component1 | All (Except Component1) | |
| Component2 | All (Except Component2) | |
| RGB | All (Except RGB) | |
| HDMI1/DVI | All (Except HDMI1/DVI, HDMI2) | |
| HDMI2 | All (Except HDMI1/DVI, HDMI2) | |

Sub Picture Size Adjustment (PIP mode only)

Press the **SIZE** button to adjust the sub picture size.

With **SIZE** button in PIP mode, sub picture is adjusted.

Moving the Sub Picture (PIP mode only)

Press the **POSITION** button.

Repeatedly press the **POSITION** button then sub picture moves.

Swapping the PIP/Double window

Press the **SWAP** button to switch the main and sub picture.

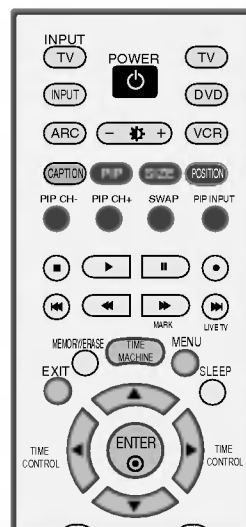

Adjusting PIP Transparency (PIP mode only)

- 1 Press the **MENU** button and then **▲** or **▼** button to select the **SCREEN** menu.
- 2 Press the **▶** button and then **▲** or **▼** button to select **PIP Transparency**.
- 3 Press the **▶** button and then **◀** or **▶** button to adjust **PIP Transparency**.
- 4 Press the **EXIT** button to return to normal TV viewing.

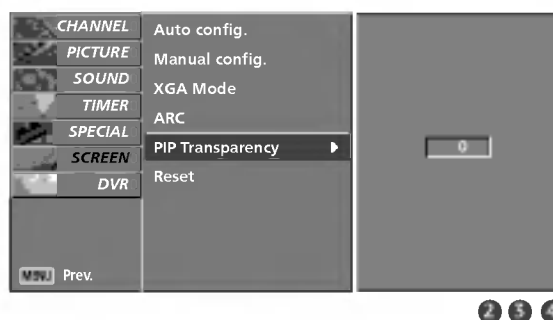

POP (Picture-out-of-Picture : Channel Scan)

Use POP to search the programs of all the memorized channels one-by-one on the 3 PIP screen display, (while the main picture source remains the current channel). The pictures of all the programmed channels are searched with the 3 POP screens. When watching TV for main picture, same TV channel for sub pictures are scanned.



TV MENU

ON SCREEN MENUS SELECTION AND ADJUSTMENT

Your TV's OSD (On Screen Display) may differ slightly from what is shown in this manual.

- 1 Press the **MENU** button and then use **▲** or **▼** button to select the each menu.
- 2 Press the **▶** button and then use **▲ ▼ ◀ ▶** button to display the available menus.

CHANNEL



PICTURE



SOUND



DVR



SCREEN

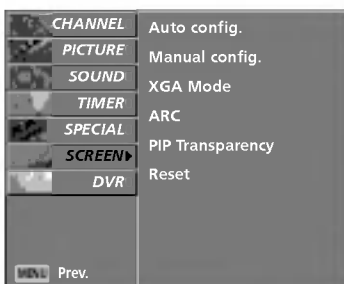

SPECIAL



TIMER



TV MENU | CHANNEL SETUP

AUTO PROGRAM: CHANNEL SEARCH

Auto Program should be used to memorize all the active channels in your area before you are able to use the TV.

There are two ways of storing channels in the TV's memory. You can use either.

One is called AUTO PROGRAM and the other is called MANUAL PROGRAM.

In AUTO PROGRAM mode, the TV will memorize the channels in ascending numerical order. If there are additional channels you want to add or delete, you can manually add or delete those channels with Manual Program.

Note: When you set up the Recording, Auto program menu is not available.

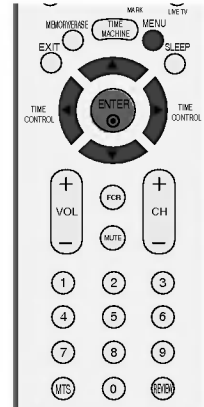

- Redo Auto Program if the TV is ever moved to another location.
- Auto Program will search for channels only through the Antenna jack.
- If channels numbers for broadcast over-the air TV and cable TV are duplicated where different channels have the same number, press the same number buttons again to toggle between:



(For example, press 17 to go to the channel, press 17 again to go to the duplicated channel.)

- 1 Press the **MENU** button and then **▲** or **▼** button to select the **CHANNEL** menu.
- 2 Press the **▶** button and then **▲** or **▼** button to select **Auto program**.
- 3 Press the **▶** button. **Auto program** starts the channel search.
- 4 If you want to stop auto programming, press the **MENU** button.
Only the channels found up to at that time are memorized.



1

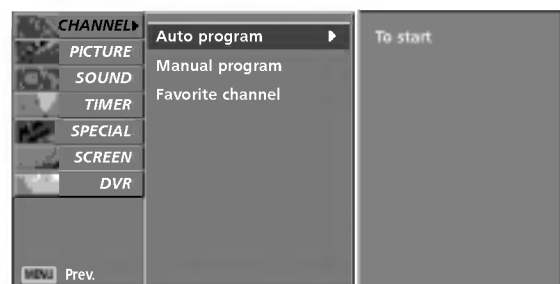

2 3

MANUAL PROGRAM : ADDING/DELETING CHANNELS

You can add or delete channels from the channel scan manually.
Note: When you set up the Time control or Recording, Adding/Deleting channels menu is not available.

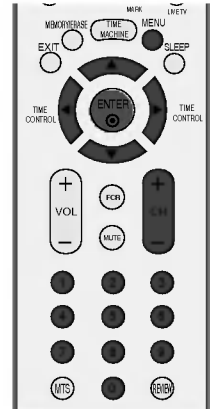

- 1 Use the **CH-/+** or **NUMBER** buttons to select the channel number you want to add or delete.

- 2 Press the **MEMORY/ERASE** button.

- 3 Press the **MEMORY/ERASE** button to select **Memory** or **Erase**.

- 4 Press the **ENTER** button.

■ You can also use the **Channel** menu to adjust **Manual program**.

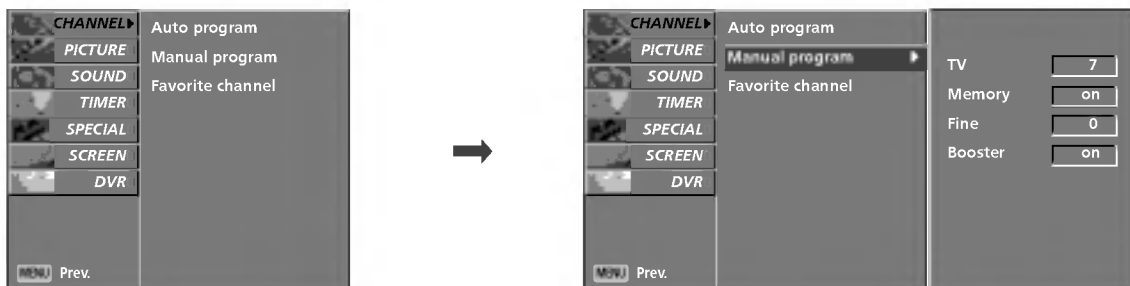

FINE TUNING ADJUSTMENT

Normally fine tuning is only necessary if reception is poor.

To remove fine tuning from a channel, reprogram the finely-tuned channel with Auto program or Manual Program.

If a finely-tuned channel is memorized, the color of the channel number changes to yellow.

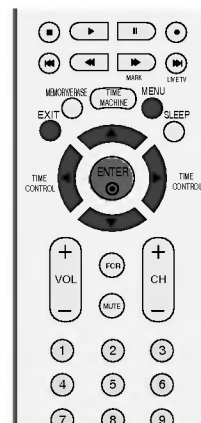

1 Press the **MENU** button and then **▲** or **▼** button to select the **CHANNEL** menu.

2 Press the **▶** button and then **▲** or **▼** button to select **Manual program**.

3 Press the **▶** button and then **▲** or **▼** button to select **Fine**.

4 Press the **◀** or **▶** button to adjust the picture to your preference.

5 Press the **ENTER** button to store it.

6 Press the **EXIT** button to return to TV viewing or press the **MENU** button to return to the previous menu.

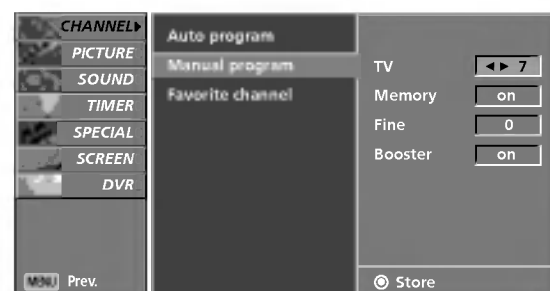

BOOSTER

If the reception is poor at the fringe area of TV signal, select **Booster** to **on**.

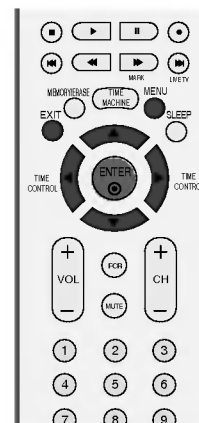

- 1 Press the **MENU** button and then **▲** or **▼** button to select the **CHANNEL** menu.

- 2 Press the **▶** button and then **▲** or **▼** button to select **Manual program**.

- 3 Press the **▶** button and then **▲** or **▼** button to select **Booster**.

- 4 Press the **◀** or **▶** button to select **On** or **Off**.

- 5 Press the **ENTER** button to store it.

- 6 Press the **EXIT** button to return to TV viewing or press the **MENU** button to return to the previous menu.



1



2

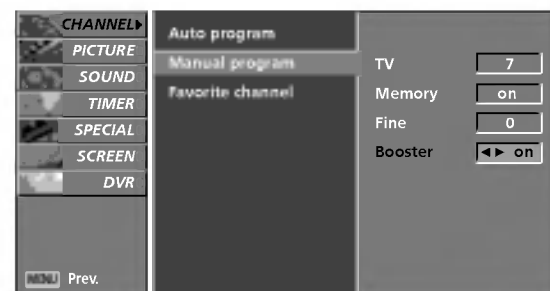

3

FAVORITE CHANNELS SETUP

Favorite Channels is a convenient feature that lets you quickly scan up to 8 channels of your choice without having to wait for the TV to scan through all the in-between channels.

To tune to a favorite channel, press the **FCR** (Favorite Channel Review) button repeatedly. The 8 favorite channels appear on the screen in numerical order.

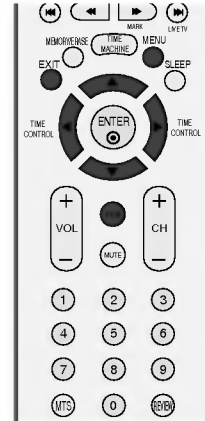

1 Press the **MENU** button and then **▲** or **▼** button to select the **CHANNEL** menu.



2 Press the **▶** button and then **▲** or **▼** button to select **Favorite Channel**.

3 Press the **▶** button and then **▲** or **▼** button to select the first favorite channel position.



4 Use the **◀** or **▶** button to set the desired channel number for first favorite channel.

5 Press the **EXIT** button to return to normal TV viewing.

6 Repeat steps 3 to 5 to memorize other favorite channels.

TV MENU | PICTURE ADJUSTMENT

AUTO PICTURE CONTROL (APC)

APC adjusts the TV for the best picture appearance. Select the preset value in the APC menu based on the program category. **Clear, Optimum, Soft** Settings are preset for optimum picture quality at the factory and are not adjustable.

In the **User1** and **User2** modes only, you can directly adjust the contrast, brightness, color, sharpness, tint.

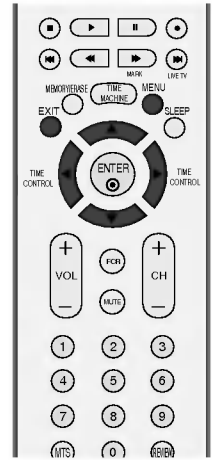

- 1 Press the **MENU** button and then ▲ or ▼ button to select the **PICTURE** menu.

- 2 Press the ► button and then ▲ or ▼ button to select **APC**.

- 3 Press the ► button and then ▲ or ▼ button to select **Clear, Optimum, Soft, User1** or **User2**.

- 4 Press the **EXIT** button to return to TV viewing or press the **MENU** button to return to the previous menu.

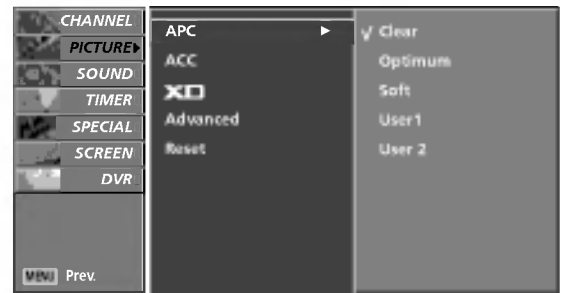

MANUAL PICTURE CONTROL (APC-USER OPTION)

Adjust the picture appearance to suit your preference and viewing situations.

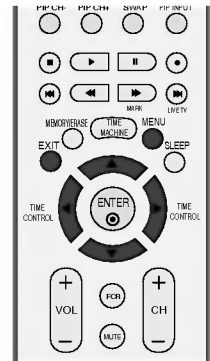

1 Press the **MENU** button and then **▲** or **▼** button to select the **PICTURE** menu.



2 Press the **▶** button and then **▲** or **▼** button to select **APC**.

3 Press the **▶** button and then **▲** or **▼** button to select **User 1** or **User 2**.

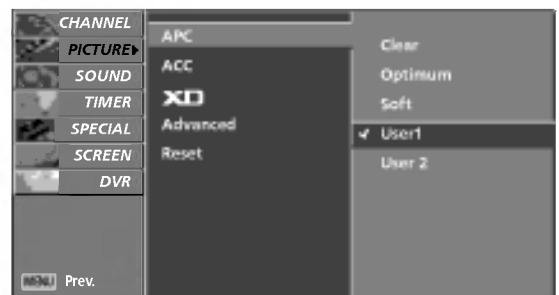

4 Press the **▶** button and then **▲** or **▼** button to select the desired picture option (**Contrast, Brightness, Color, Sharpness, and Tint**).

5 Press the **▶** button and then **◀** or **▶** button to make appropriate adjustments.

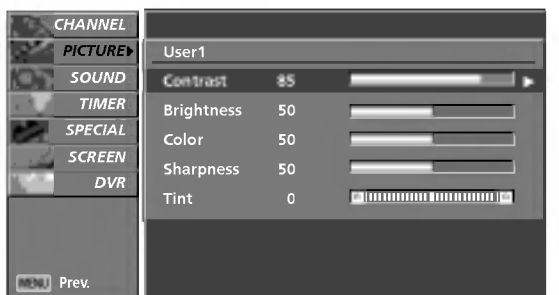

6 Press the **EXIT** button to return to TV viewing or press the **MENU** button to return to the previous menu.

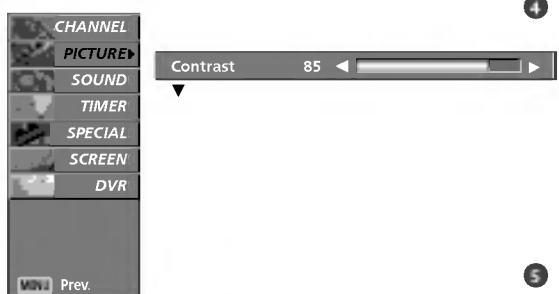

NOTE

- ▶ In RGB/HDMI-PC mode, you can't adjust color, sharpness and tint to the levels you prefer.

AUTO COLOR TEMPERATURE CONTROL (ACC)

Choose one of three automatic color adjustments. Set to warm to enhance hotter colors such as red, or set to cool to see less intense colors with more blue.

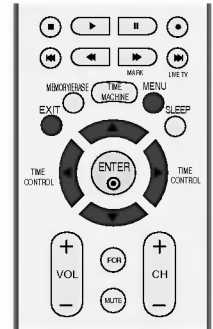

1 Press the **MENU** button and then **▲** or **▼** button to select the **PICTURE** menu.

2 Press the **▶** button and then **▲** or **▼** button to select **ACC**.

3 Press the **▶** button and then **▲** or **▼** button to select either **Cool**, **Normal**, **Warm**, or **User**.

4 Press **EXIT** button to return to TV viewing or press **MENU** button to return to the previous menu.

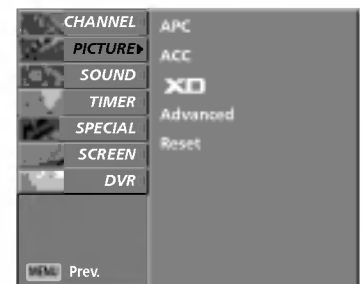

1

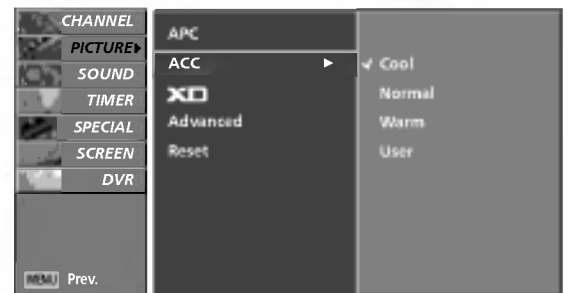

2 3

MANUAL COLOR TEMPERATURE CONTROL (ACC - USER OPTION)

You can also adjust the detailed settings (Red, Green, Blue) by selecting the **user** menu.

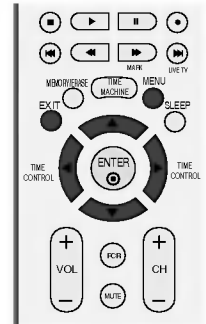

1 Press the **MENU** button and then ▲ or ▼ button to select the **PICTURE** menu.

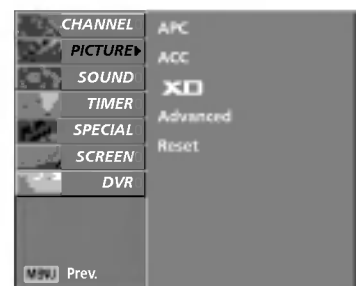

2 Press the ► button and then ▲ or ▼ button to select **ACC**.

3 Press the ► button and then ▲ or ▼ button to select **User**.



4 Press the ► button and then ▲ or ▼ button to select **Red, Green, or Blue**.

5 Press the ► button and then ◀ or ▶ button to make appropriate adjustments.

- The adjustment range of **Red, Green, or Blue** is -40 ~ 40.



6 Press the **EXIT** button to return to TV viewing or press the **MENU** button to return to the previous menu.

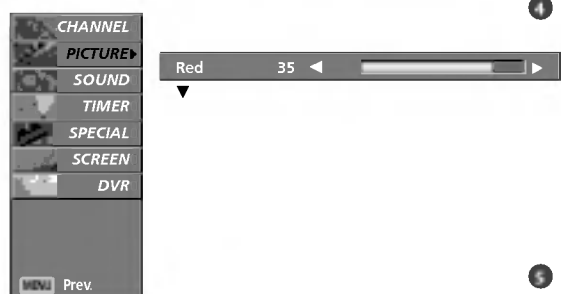

XD

XD is LG Electronic's unique picture improving technology to display a real HD source through an advanced digital signal processing algorithm.

When selecting APC options (Clear, Optimum and Soft), XD is automatically changed to Auto.

When selecting APC options (User 1 and User 2), you can choose the Auto / Manual.

When selecting the Manual, you can adjust the XD Contrast, XD color and XD Noise.

It's not available to use this function in RGB/HDMI-PC mode.

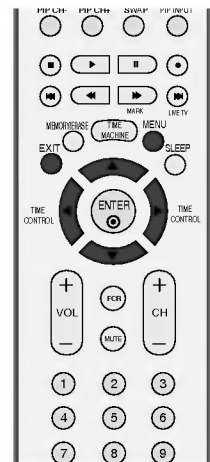

1 Press the **MENU** button and then use **▲** or **▼** button to select the **PICTURE** menu.

2 Press the **▶** button and then use **▲** or **▼** button to select **XD**.

3 Press the **▶** button and then use **▲** or **▼** button to select **Auto** or **Manual**.



Selecting the Manual

1. Press the **▶** button and then use **▲** or **▼** button to select **XD Contrast**, **XD Color** or **XD NR (Noise)**, **MPEG NR**.

- **XD Contrast:** Optimizing the contrast automatically according to the brightness of the reflection.
- **XD Color:** Adjusting the colors of the reflection automatically to reproduce as closely as possible to the natural colors.
- **XD NR (Noise) :** Removing the noise up to the point where it does not damage the original picture.
- **MPEG NR :** To reduce the picture noise which may appear on the screen during watching the TV.

2. Press the **◀** or **▶** button to select **On** or **Off**.

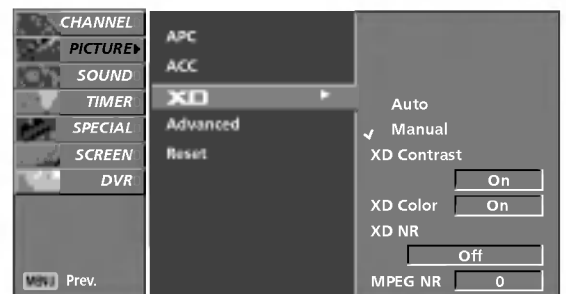

4 Press **EXIT** button to return to TV viewing or press **MENU** button to return to the previous menu.

ADVANCED-CINEMA MODE SETUP

Set up the TV for the best picture appearance for viewing movies.

When you operate Cinema (3:2 Pull-Down Mode or Cinema Correction Mode), the TV will adjust 24 fps video from movies to 30 fps video for display.

This feature operates only in Analog TV, AV and Component 480i mode.

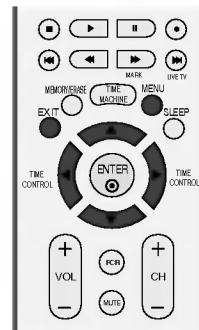

1 Press the **MENU** button and then **▲** or **▼** button to select the **PICTURE** menu.

2 Press the **▶** button and then **▲** or **▼** button to select **Advanced**.

3 Press the **▶** button and then **▲** or **▼** button to select **Cinema**.

4 Press the **◀** or **▶** button to select **On** or **Off**.

5 Press the **EXIT** button to return to TV viewing or press the **MENU** button to return to the previous menu.

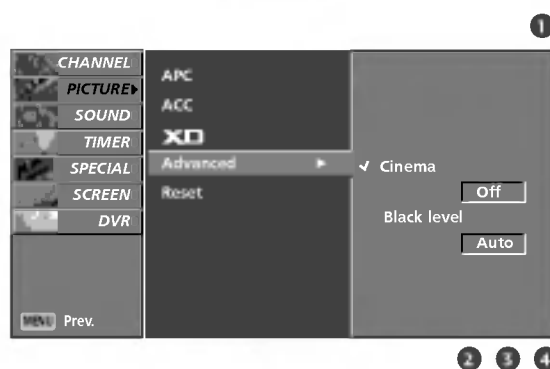

ADVANCED-BLACK LEVEL

Adjusting the contrast and the brightness of the screen using the black level of the screen.

This feature operates only in AV (NTSC-M) or HDMI mode.

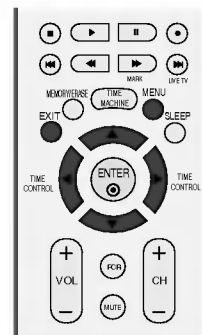

1 Press the **MENU** button and then ▲ or ▼ button to select the **PICTURE** menu.

2 Press the ► button and then ▲ or ▼ button to select **Advanced**.

3 Press the ► button and then ▲ or ▼ button to select **Black Level**.

4 Press the ◀ or ▶ button to select **Low** or **High**.

- **Low**
The screen gets darker.
- **High**
The screen gets brighter.

5 Press the **EXIT** button to return to TV viewing or press the **MENU** button to return to the previous menu.



1

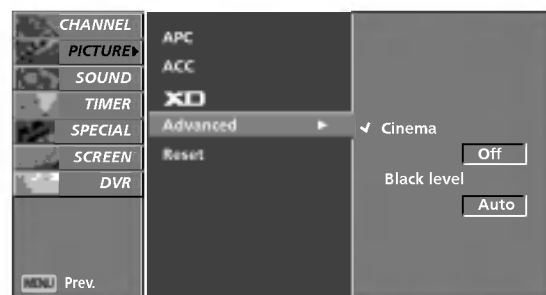

2 3 4

RESET

Use to quickly reset all the Picture menu options to their original factory preset values.

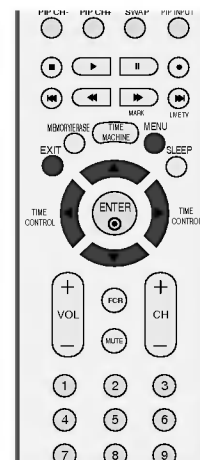

1 Press the **MENU** button and then ▲ or ▼ button to select the **PICTURE** menu.

2 Press the ► button and then ▲ or ▼ button to select **Reset**.

3 Press the ► button to initialize the adjusted value.

- Returns to the default settings APC, ACC, XD, Advanced at the factory.

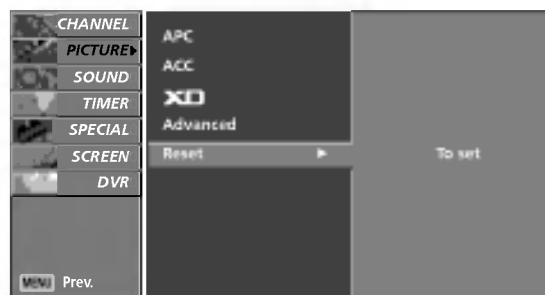

TV MENU | SOUND ADJUSTMENT

DIGITAL AUTO SOUND PROCESSING (DASP)

DASP lets you enjoy the best sound without any special adjustment because the TV sets the appropriate sound options based on the program content.

Surround MAX, Flat, Music, Movie, and Sports are preset for good sound quality at the factory and are not adjustable.

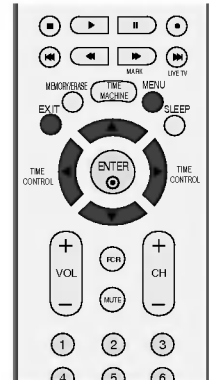

- Surround MAX** Select this option to sound realistic.
- Flat** The most commanding and natural audio.
- Music** Select this option to enjoy the original sound when listening to the music.
- Movie** Select this option to enjoy sublime sound.
- Sports** Select this option to watch sports broadcasting.
- User** Select this option to use the user-defined audio settings.

1 Press the **MENU** button and then **▲** or **▼** button to select the **SOUND** menu.

2 Press the **▶** button and then **▲** or **▼** button to select **DASP**.

3 Press the **▶** button and then **▲** or **▼** button to select **Surround MAX, Flat, Music, Movie, Sports** or **User**.

4 Press the **EXIT** button to return to TV viewing or press the **MENU** button to return to the previous menu.



1

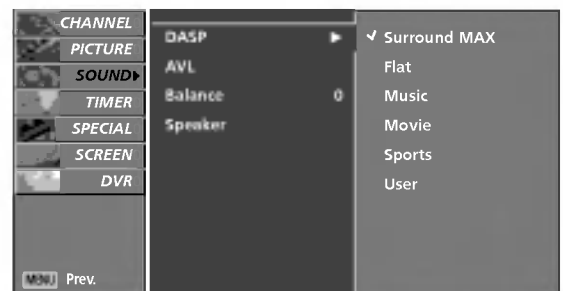

2 3

SOUND CONTROL ADJUSTMENT (DASP - USER OPTION)

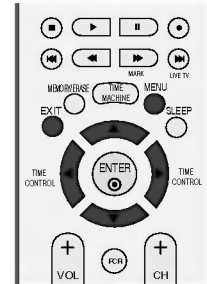

1 Press the **MENU** button and then ▲ or ▼ button to select the **SOUND** menu.

2 Press the ► button and then ▲ or ▼ button to select **DASP**.

3 Press the ► button and then ▲ or ▼ button to select **User**.

4 Press the ► button and then ▲ or ▼ button to select the desired sound option (**Treble** or **Bass**).

5 Press the ► button and then use ◀ or ▶ button to make appropriate adjustments.

6 Press the **EXIT** button to return to TV viewing or press the **MENU** button to return to the previous menu.

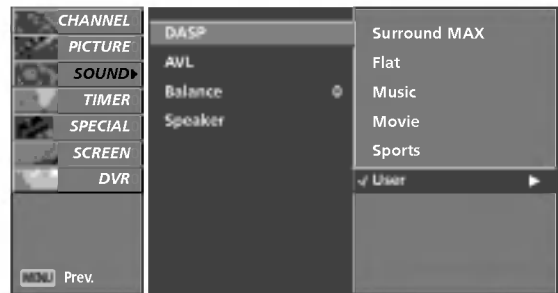

1 2 3



4 5

AUTO VOLUME LEVELER (AVL)

AVL automatically keeps on an equal volume level even if you change program.

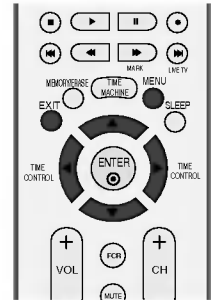

- 1 Press the **MENU** button and then ▲ or ▼ button to select the **SOUND** menu.

- 2 Press the ► button and then ▲ or ▼ button to select **AVL**.

- 3 Press the ► button and then ▲ or ▼ button to select **On** or **Off**.

- 4 Press the **EXIT** button to return to TV viewing or press the **MENU** button to return to the previous menu.



1

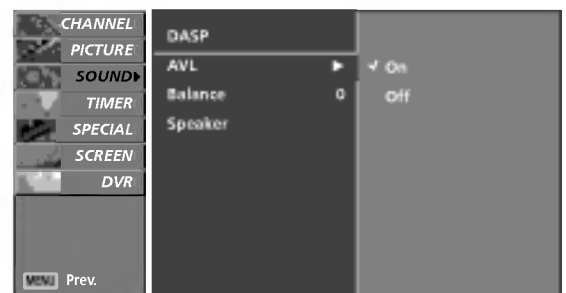

2 3

BALANCE ADJUSTMENT

Adjust the left/right sound of speaker to suit your taste and room situations.

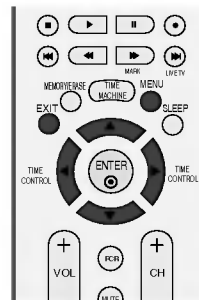

- 1 Press the **MENU** button and then ▲ or ▼ button to select the **SOUND** menu.
- 2 Press the ► button and then ▲ or ▼ button to select **Balance**.
- 3 Press the ► button and then ◀ or ▶ button to make desired adjustment.
- 4 Press the **EXIT** button to return to TV viewing or press the **MENU** button to return to the previous menu.



1



2



3

TV SPEAKERS ON/OFF SETUP

Turn the TV speakers off if using external audio equipment. Feature turns the TV Speakers option On or Off.

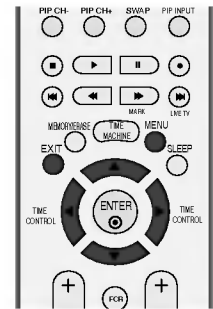

- 1 Press the **MENU** button and then ▲ or ▼ button to select the **SOUND** menu.

- 2 Press the ► button and then ▲ or ▼ button to select **Speaker**.

- 3 Press the ► button and then ▲ or ▼ button to select **On** or **Off**.

- 4 Press the **EXIT** button to return to TV viewing or press the **MENU** button to return to the previous menu.



1

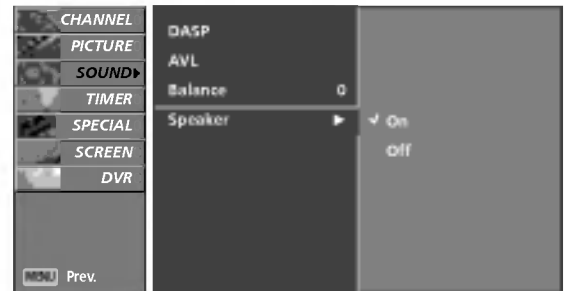

2 3

STEREO/SAP BROADCASTS SETUP

The TV can receive MTS stereo programs and any SAP (Secondary Audio Program) that accompanies the stereo program; if the broadcaster transmits one additional sound signal in addition to the original one.

Mono: The primary language is heard from left and right speakers. Signal mode is mono.

Stereo: The primary language is heard from left and right speakers. Signal mode is stereo.

SAP: The secondary language is heard from left and right speakers in mono sound.

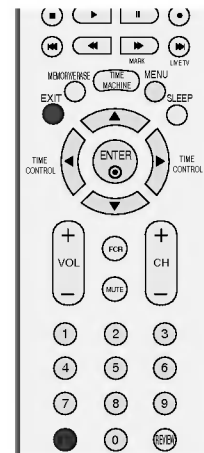

1 Use the **MTS** button to select your desired MTS mode in analog signal. Each time you press the **MTS** button, **Mono**, **Stereo**, or **SAP** appear in turn.

.....

2 Press **EXIT** button to save and return to TV viewing.

NOTE

- ▶ Select mono sound mode if the signal is not clear or in poor signal reception areas.
- ▶ **Stereo**, **SAP** modes are available only if included on the broadcast signal.

TV MENU | TIME SETTING

CLOCK SETUP

If the current time setting is wrong, reset the clock manually.

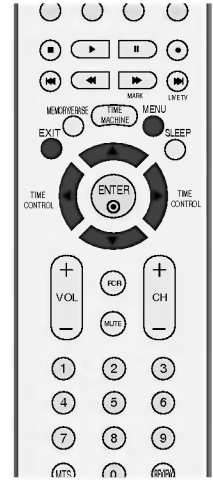

1 Press the **MENU** button and then ▲ or ▼ button to select the **TIMER** menu.

2 Press the ► button and then ▲ or ▼ button to select **Clock**.

3 Press the ► button and then use ▲ or ▼ button to set the Year.

4 Press the ► button and then use ▲ or ▼ button to set the Date and Time.

5 Press **EXIT** button to return to TV viewing or press **MENU** button to return to the previous menu.

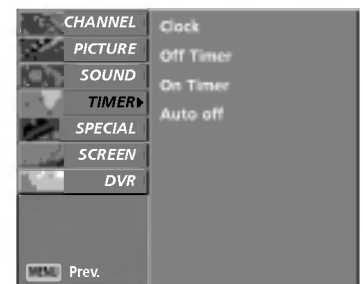

1

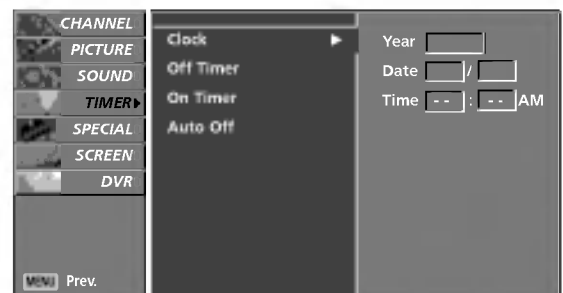

2 3 4

ON/OFF TIMER SETUP

The timer function operates only if the current time has been set.

The Off-Timer function overrides the On-Timer function if they are both set to the same time.

The TV must be in standby mode for the On-Timer to work.

If you do not press any button within 2 hours after the TV turns on with the On Timer function, the TV will automatically revert to standby mode.

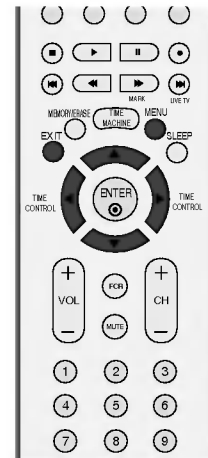

1 Press the **MENU** button and then **▲** or **▼** button to select the **TIMER** menu.

2 Press the **▶** button and then use **▲** or **▼** button to select **Off timer** or **On timer**.

3 Press the **▶** button and then use **▲** or **▼** button to select **On**.

■ To cancel the **On/Off timer** function, select **Off**.

4 Press the **▶** button and then use **▲** or **▼** button to set the hour.

5 Press the **▶** button and then use **▲** or **▼** button to set the minutes.

6 Only On timer

Press the **▶** button and then use **▲** or **▼** to set the sound level at turn-on.

Press the **▶** button and then use **▲** or **▼** to select the channel at turn-on.

7 Press **EXIT** button to return to TV viewing or press **MENU** button to return to the previous menu.



1

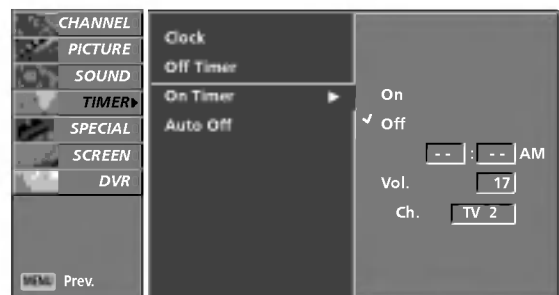

2 3 4 5 6

AUTO OFF

If set to on and there is no input signal, the TV turns off automatically after 10 minutes.

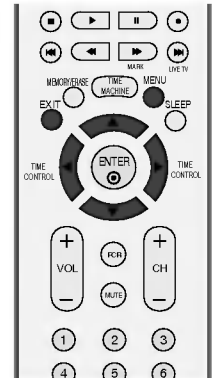

1 Press the **MENU** button and then use ▲ or ▼ button to select the **TIMER** menu.

2 Press the ► button and then use ▲ or ▼ button to select **Auto Off**.

3 Press the ► button and then use ▲ or ▼ button to select **On** or **Off**.

4 Press **EXIT** button to return to TV viewing or press **MENU** button to return to the previous menu.



1

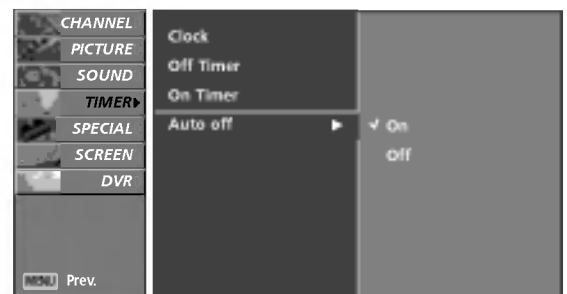

2 3

SLEEP TIMER

The Sleep Timer turns the TV off at the preset time.

Note that this setting is cleared when the TV is turned off.

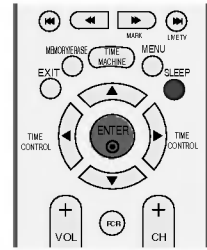

- 1 Press the **SLEEP** button repeatedly to select the number of minutes. First the - - - option appears on the screen, followed by the following sleep timer options : 10, 20, 30, 60, 90, 120, 180, and 240 minutes.
- 2 When the number of minutes you want is displayed on the screen, press the **ENTER** button. The timer begins to count down from the number of minutes selected.
- 3 To check the remaining minutes before the TV turns off, press the **SLEEP** button once.
- 4 To cancel the Sleep Timer, press the **SLEEP** button repeatedly to select - - -.

TV MENU | SPECIAL FEATURES

KEY LOCK

The TV can be set so that the remote control is needed to control it.

This feature can be used to prevent unauthorized viewing by locking out the front panel controls.

This TV is programmed to remember which option it was last set to even if you turn the set off.

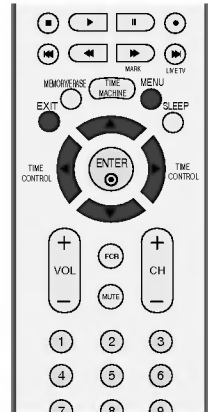

1 Press the **MENU** button and then use ▲ or ▼ button to select the **SPECIAL** menu.

2 Press the ► button and then use ▲ or ▼ button to select **Key lock**.

3 Press the ► button and then use ▲ or ▼ button to select **On** or **Off**.

4 Press **EXIT** button to return to TV viewing or press **MENU** button to return to the previous menu.



1

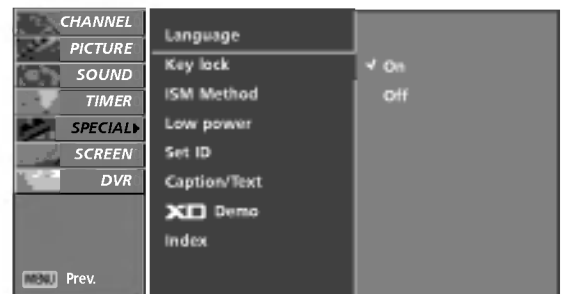

2 3

NOTE

- ▶ In **Key lock 'On'**, if the set is turned off, press the **⏻ / I**, **INPUT**, **CH ▲ / ▼** button on the set or **POWER**, **INPUT**, **TV**, **CH +/-** or **NUMBER** buttons on the remote control.
- ▶ With the **Key lock On**, the display '**Key lock**' appears on the screen if any button on the front panel is pressed while viewing the set.

ISM (IMAGE STICKING MINIMIZATION) METHOD

A frozen of still picture from a PC/video game displayed on the screen for prolonged periods will result in a ghost image remaining even when you change the image. Avoid allowing a fixed image to remain on the set's screen for a long period of time.

White wash

White wash removes permanent images from the screen.

Note: An excessive permanent image may be impossible to clear entirely with White Wash.

Orbiter

Orbiter may help prevent ghost images. However, it is best not to allow any fixed image to remain on the screen. To avoid a permanent image on the screen, the screen will move every 2 minutes.

Inversion

This is the function to invert the panel color of the screen. The panel color is automatically inverted every 30 minutes.

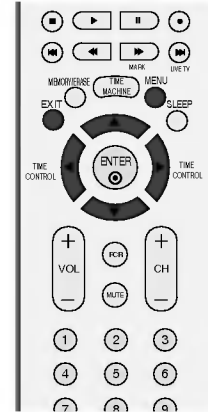

1 Press the **MENU** button and then use ▲ or ▼ button to select the **SPECIAL** menu.

2 Press the ► button and then use ▲ or ▼ button to select **ISM Method**.

3 Press the ► button and then use ▲ or ▼ button to select **Normal, White wash, Orbiter** or **Inversion**.

4 Press **EXIT** button to return to TV viewing or press **MENU** button to return to the previous menu.

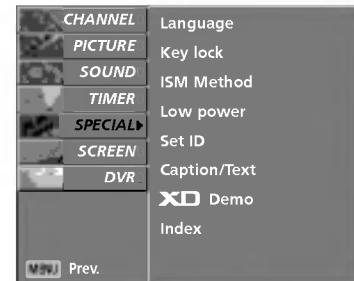

1

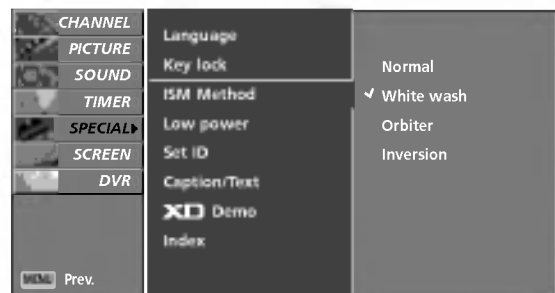

2 3

LOW POWER

This is the function to reduce the power consumption of the set.

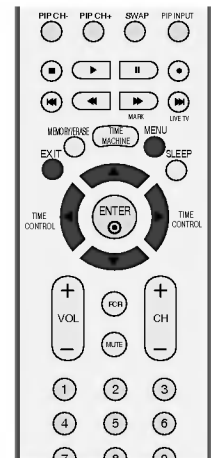

1 Press the **MENU** button and then use ▲ or ▼ button to select the **SPECIAL** menu.

2 Press the ► button and then use ▲ or ▼ button to select **Low power**.

3 Press the ► button and then use ▲ or ▼ button to select **On** or **Off**.

4 Press **EXIT** button to return to TV viewing or press **MENU** button to return to the previous menu.



1



2 3

CLOSED CAPTIONS

Closed captioning is a process which converts the audio portion of a television program into written words which then appear as subtitles on the television screen. Closed captions allow viewers to read the dialogue and narration of television programs.

Using Closed Captions

Captions are the subtitles of the dialogue and narration of television programs. For prerecorded programs, program dialogue can be arranged into captions in advance. Its possible to caption a live program by using a process called real-time captioning, which creates captions instantly. Real-time captioning is normally done by professional reporters using a machine shorthand system and computer for translation into English.

Captioning is an effective system for the hearing-impaired, and it can also aid in teaching language skills.

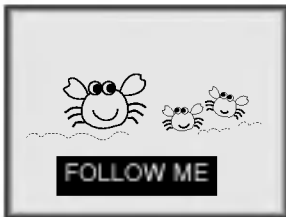

- The picture at left shows a typical caption.

Caption Tips

- Not all TV broadcasts include closed caption signals.
- Sometimes TV stations broadcast four different caption signals on the same channel. By selecting Mode1 to Mode2, you can choose which signal you view. Mode1 is usually the signal with the captions, while another mode might show demonstration or programming information.
- Your TV might not receive caption signals normally in the following situations.

1. Poor reception conditions are encountered:



• IGNITION:

Picture may flutter, drift, suffer from black spots, or horizontal streaking. Usually caused by interference from automobile ignition systems, neon lamps, electrical drills, and other electrical appliances.



• GHOSTS:

Ghosts are caused when the TV signal splits and follows two paths. One is the direct path and the other is reflected off tall buildings, hills or other objects. Changing the direction or position of the antenna may improve reception.



• SNOW:

If your receiver is located at the weak, fringe area of a TV signal, your picture may be marred by small dots. It may be necessary to install a special antenna to improve the picture.

2. An old, bad, or illegally recorded tape is being played.
3. Strong, random signals from a car or airplane interfere with the TV signal.
4. The signal from the antenna is weak.
5. The program wasn't captioned when it was produced, transmitted, or taped.

1 Use the **CAPTION** button repeatedly to select your caption Mode 1, Mode 2, Text1, Text4, or Off.

2 Press the **EXIT** button to return to TV viewing.

■ You can also adjust **Caption/Text** in the **SPECIAL** menu.

XD DEMO

Use it to see the difference between XD Demo on and XD Demo off.

Note: When you set up the Time control, XD Demo menu is not available.
It's not available to use this function in RGB/HDMI-PC mode.

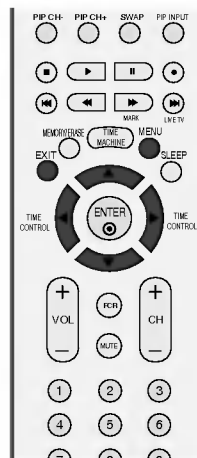

1 Press the **MENU** button and then use ▲ or ▼ button to select the **SPECIAL** menu.

2 Press the ► button and then use ▲ or ▼ button to select **XD Demo**.

3 Press the ► button to begin **XD Demo**.

4 To stop **XD Demo**, press the **MENU** button.

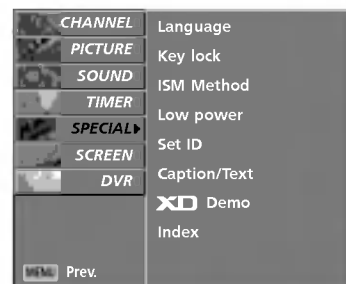

1

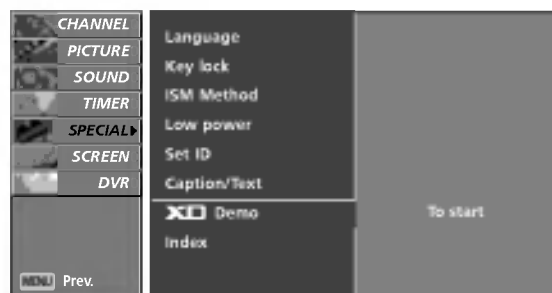

2 3

• XD Demo



INDEX

Switches LED Display on or off.

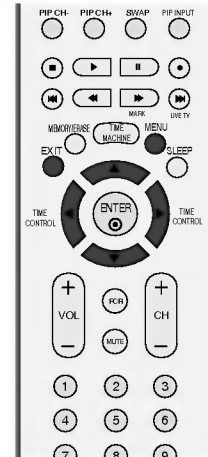

- 1 Press the **MENU** button and then use ▲ or ▼ button to select the **SPECIAL** menu.
- 2 Press the ► button and then use ▲ or ▼ button to select **Index**.
- 3 Press the ► button and then use ▲ or ▼ button to select **On** or **Off**.
- 4 Press **EXIT** button to return to TV viewing or press **MENU** button to return to the previous menu.

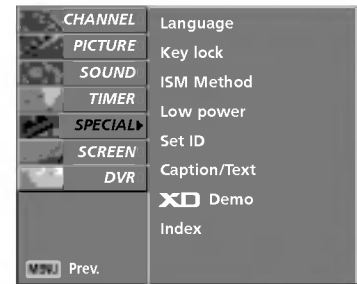

1



2 3

TV MENU | SCREEN ADJUSTMENT

AUTO CONFIGURE (RGB [PC] MODE ONLY)

Automatically adjusts picture position and minimizes image shaking.

Although the image is still not correct, your set is functioning properly but needs further adjustment.

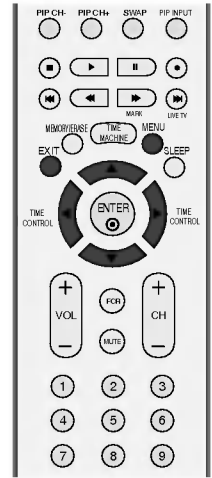

1 Press the **MENU** button and then use **▲** or **▼** button to select the **SCREEN** menu.

2 Press the **▶** button and then use **▲** or **▼** button to select **Auto config.**

3 Press the **▶** button to start **Auto config.**

- When **Auto config.** has finished, **OK** will be shown on screen.
- If the position of the image is still not correct, try Auto adjustment again.

4 If the picture needs to be adjusted more after Auto adjustment in RGB (PC), you can adjust the **Manual config.**

5 Press the **EXIT** button to return to TV viewing or press the **MENU** button to return to the previous menu.

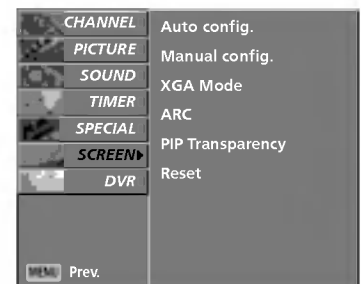

1

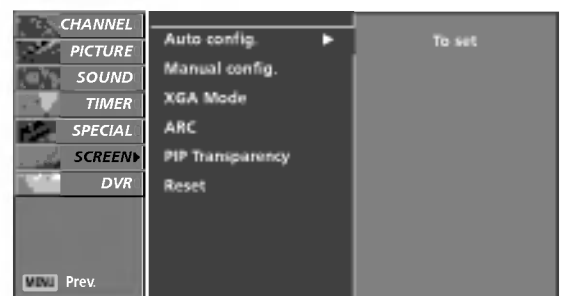

2 3

MANUAL CONFIGURE

If the picture isn't clear after auto adjustment and especially if characters are still trembling, adjust the picture phase manually.

This function works in the following mode : RGB-PC, RGB-DTV 480p/720p/1080i, Component 480p/720p/1080i, HDMI 480p/720p/1080i.

It's not available to use Phase, Clock function in RGB-DTV 480p/720p/1080i, Component 480p/720p/1080i, HDMI 480p/720p/1080i.

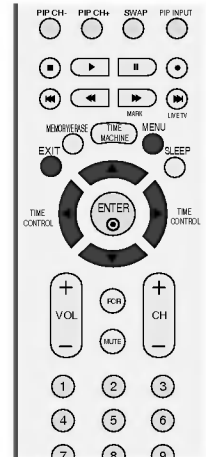

1 Press the **MENU** button and then use ▲ or ▼ button to select the **SCREEN** menu.

2 Press the ► button and then use ▲ or ▼ button to select **Manual config.**

3 Press the ► button and then use ▲ or ▼ button to select **Phase, Clock, H-position** or **V-position**.

■ **Phase**

This function allows you to remove any horizontal noise and clear or sharpen the image of characters.

■ **Clock**

This function is to minimize any vertical bars or stripes visible on the screen background. And the horizontal screen size will also change.

■ **H-position / V-position**

This function is to adjust picture to left/right and up/down as you prefer.

4 Press the ◀ / ▶ button to make appropriate adjustments.

5 Press the **EXIT** button to return to TV viewing or press the **MENU** button to return to the previous menu.



1

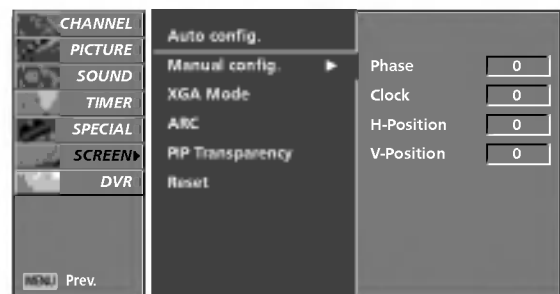

2 3 4

SELECTING WIDE VGA/XGA MODE

To see a normal picture, match the resolution of RGB mode and selection of VGA/XGA mode.

This function works in the following mode: RGB[PC] mode.

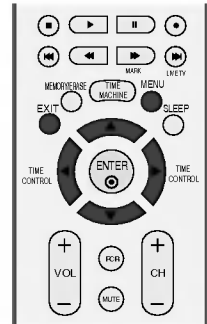

1 Press the **MENU** button and then use ▲ or ▼ button to select the **SCREEN** menu.

2 Press the ► button and then use ▲ or ▼ button to select **XGA mode (or VGA mode)**.

3 Press the ► button and then use ▲ or ▼ button to select the desired VGA/XGA resolution.

4 Press **EXIT** button to return to TV viewing or press **MENU** button to return to the previous menu.

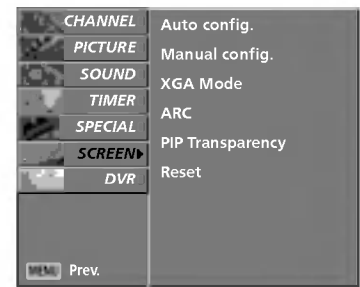

1

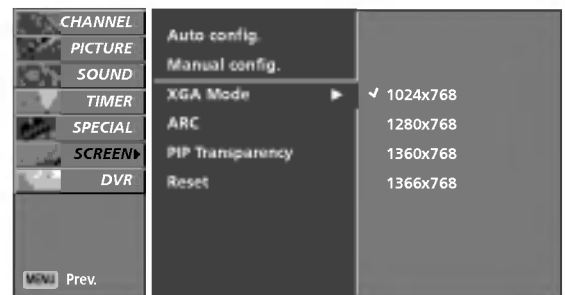

2 3

ASPECT RATIO CONTROL (ARC)

This feature lets you choose the way an analog picture with a 4:3 aspect ratio is displayed on your TV. When you receive an analog picture with a 4:3 aspect ratio on your 16:9 TV, you need to specify how the picture is to be displayed.

- Component (480p,720p,1080i), RGB DTV, HDMI1/DVI-DTV, HDMI2-DTV input source use 4:3, 16:9, Zoom1 or Zoom2 aspect ratio.
- RGB-PC and HDMI-PC input source use 4:3 or 16:9 aspect ratio.

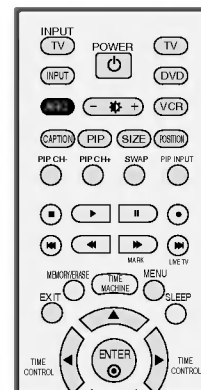

NOTE

- ▶ If a fixed image is displayed on the screen for a long time, the image may become imprinted on the screen and remain visible. This phenomenon is common to all manufactures and in consequence the manufactures warranty does not cover the product bearing this phenomenon.

1 Press the **ARC** button repeatedly to select the desired picture format.

You can also adjust **ARC** in the **SCREEN** menu.

4:3

Choose 4:3 when you want to view a picture with an original 4:3 aspect ratio.



16:9

Adjust the picture horizontally, in a linear proportion to fill the entire screen.



Horizon

The screen size is, more enlarged at both sides, to create a spectacular view.

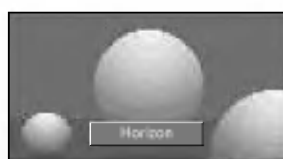

Zoom 1

Choose Zoom 1 when you want to view the picture without any alteration. However, the top and bottom portions of the picture will be cropped.

You can move the Zoom1 screen using ▲ or ▼ button.

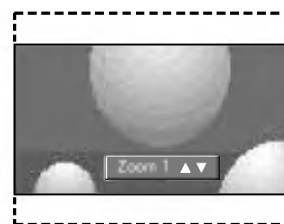

Zoom 2

Choose Zoom 2 when you want the picture to be altered, both vertically extended and cropped. The picture taking a halfway trade off between alteration and screen coverage.

You can move the Zoom2 screen using ▲ or ▼ button.



INITIALIZING (RESET TO ORIGINAL FACTORY SETTINGS)

This function operates in current mode.
To initialize the adjusted value.

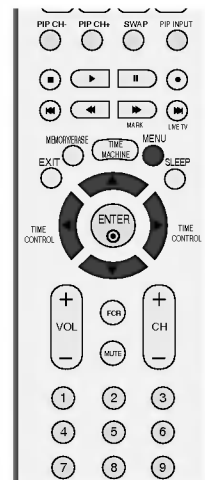

1 Press the **MENU** button and then use ▲ or ▼ button to select the **SCREEN** menu.

2 Press the ► button and then use ▲ or ▼ button to select **Reset**.

3 Press the ► button.

- You can initialize Position, PIP size, PIP position. (PIP size and PIP position are available to work in PIP mode only.)

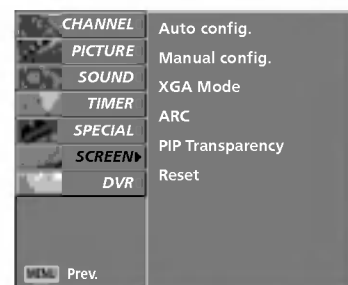

1

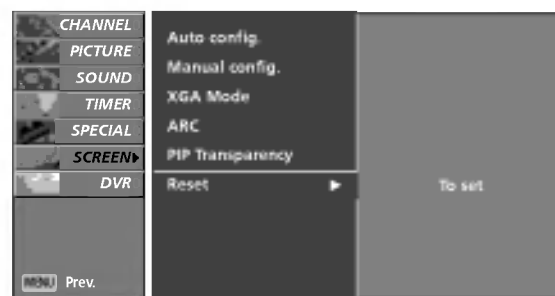

2 3

APPENDIX

EXTERNAL CONTROL DEVICE SETUP

Connect the RS-232C (serial port) input jack to an external control device (such as a computer or an A/V control system) to control the product's functions externally.

Connect the serial port of the control device to the RS-232C jack on the product back panel.

Note: RS-232C connection cables are not supplied with the product.

RS-232C Setup

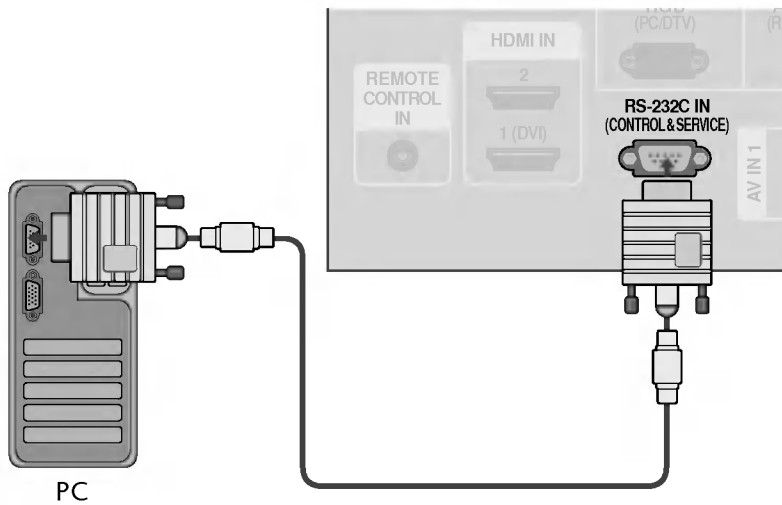

Type of Connector; D-Sub 9-Pin Male

| No. | Pin Name |
|-----|----------------------|
| 1 | No connection |
| 2 | RXD (Receive data) |
| 3 | TXD (Transmit data) |
| 4 | DTR (DTE side ready) |
| 5 | GND |
| 6 | DSR (DCE side ready) |
| 7 | RTS (Ready to send) |
| 8 | CTS (Clear to send) |
| 9 | No Connection |

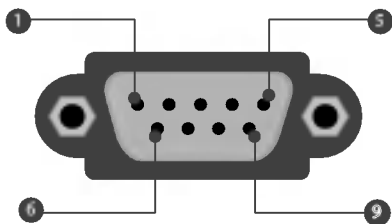

APPENDIX

RS-232C Configurations

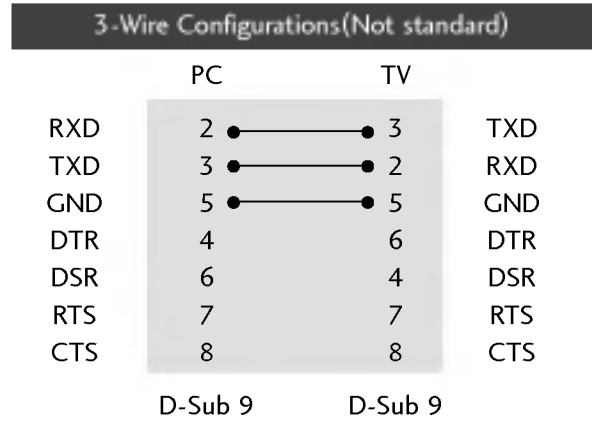
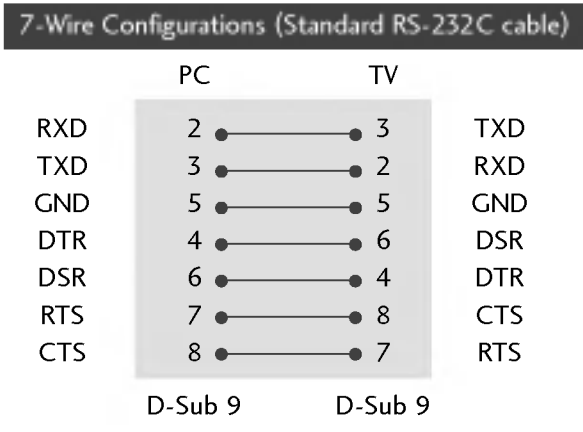

Set ID

Use this function to specify a TV ID number.
Refer to 'Real Data Mapping 1'. ▶ p.87.

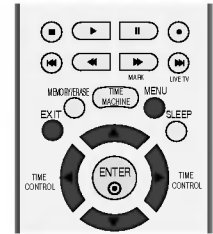

- 1 Press the **MENU** button and then use ▲ or ▼ button to select the **SPECIAL** menu.

- 2 Press the ► button and then use ▲ or ▼ button to select **Set ID**.

- 3 Press the ► button and then use ◀ or ▶ button to adjust **Set ID** to choose the desired TV ID number. The adjustment range of Set ID is 1~99.

- 4 Press **EXIT** button to return to TV viewing or press **MENU** button to return to the previous menu.

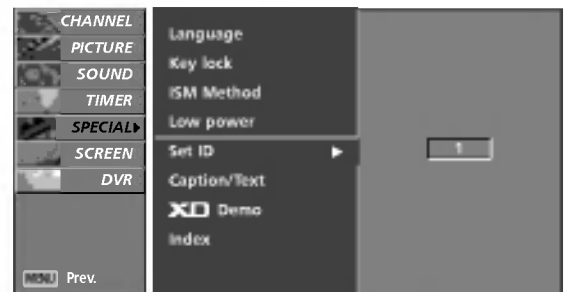

Communication Parameters

- Baud rate : 9600 bps (UART)
- Data length : 8 bits
- Parity : None
- Stop bit : 1 bit
- Communication code : ASCII code
- Use a crossed (reverse) cable.

Command Reference List

| | COMMAND1 | COMMAND2 | DATA (Hexadecimal) | | COMMAND1 | COMMAND2 | DATA (Hexadecimal) |
|---------------------------------|----------|----------|-----------------------|----------------------------|----------|----------|-----------------------|
| 01. Power | k | a | 0 ~ 1 | 17. Balance | k | t | 0 ~ 64 |
| 02. Aspect Ratio | k | c | ▶ P. 84 | 18. Color Temperature | k | u | 0 ~ 3 |
| 03. Screen Mute | k | d | 0 ~ 1 | 19. Red Adjustment | k | v | 0 ~ 50 |
| 04. Volume Mute | k | e | 0 ~ 1 | 20. Green Adjustment | k | w | 0 ~ 50 |
| 05. Volume Control | k | f | 0 ~ 64 | 21. Blue Adjustment | k | \$ | 0 ~ 50 |
| 06. Contrast | k | g | 0 ~ 64 | 22. Abnormal Status | k | z | FF |
| 07. Brightness | k | h | 0 ~ 64 | 23. ISM Method (option) | j | p | 0 ~ 3 |
| 08. Color | k | i | 0 ~ 64 | 24. Low Power (option) | j | q | 0 ~ 1 |
| 09. Tint | k | j | 0 ~ 64 | 25. Channel Tuning | m | a | ▶ P. 86 |
| 10. Sharpness | k | k | 0 ~ 64 | 26. Channel Add/del | m | b | ▶ P. 86 |
| 11. OSD Select | k | l | 0 ~ 1 | 27. Key | m | c | ▶ P. 89 |
| 12. Remote Control lock mode | k | m | 0 ~ 1 | 28. Auto Configure | j | u | 1 |
| 13. PIP/DW/POP | k | n | ▶ P. 85 | 29. Input selection (Main) | x | b | ▶ P. 87 |
| 14. PIP Position | k | q | 0 ~ 3 | 30. Input selection (Sub) | x | y | ▶ P. 87 |
| 15. Treble (option) | k | r | 0 ~ 64 | | | | |
| 16. Bass (option) | k | s | 0 ~ 64 | | | | |

Transmission / Receiving Protocol

Transmission

[Command1][Command2][][Set ID][][Data][Cr]

[Command 1] : First command to control the set.(j,k,mor x)

[Command 2] : Second command to control the set.

[Set ID] : You can adjust the set ID to choose desired TV ID number in Special menu. Adjustment range is 1 ~ 99. When selecting Set ID '0', every connected the TV is controlled. Set ID is indicated as decimal (1 ~ 99) on menu and as Hexa decimal (0x0~ 0x63) on transmission/receiving protocol.

[DATA] : To transmit command data.

Transmit 'FF' data to read status of command.

[Cr] : Carriage Return

ASCII code '0x0D'

[] : ASCII code 'space (0x20)'

OK Acknowledgement

[Command2][][Set ID][][OK][Data][x]

The TV transmits ACK (acknowledgement) based on this format when receiving normal data. At this time, if the data is data read mode, it indicates present status data. If the data is data write mode, it returns the data of the PC computer.

Error Acknowledgement

[Command2][][Set ID][][NG][Data][x]

The TV transmits ACK (acknowledgement) based on this format when receiving abnormal data from non-viable functions or communication errors.

Data1: Illegal Code

Data2: Not supported function

Data3: Wait more time

APPENDIX

01. Power (Command2:a)

To control Power On/Off of the TV.

Transmission [k][a][][Set ID][][Data][Cr]

Data 0 : Power Off Data 1 : Power On

Acknowledgement [a][][Set ID][][OK][Data][x]

To show Power On/Off.

Transmission [k][a][][Set ID][][FF][Cr]

Acknowledgement [a][][Set ID][][OK][Data][x]

* In a like manner, if other functions transmit 'FF' data based on this format, Acknowledgement data feedback presents status about each function.

* To change the Power on input the transmission more than twice.

02. Aspect Ratio (Command2:c) (Main picture size)

To adjust the screen format. (Main picture format)

You can also adjust the screen format using the ARC (Aspect Ratio Control) button on remote control or in the Screen menu.

Transmission [k][c][][Set ID][][Data][Cr]

Date 1: Normal screen (4:3) Date 4: Zoom1

Date 2: Wide screen (16:9) Date 5: Zoom2

Date 3: Horizon

Acknowledgement [c][][Set ID][][OK][Data][x]

* Using the RGB-PC, RGB-DTV, Component or HDMI input, you select either 16:9 or 4:3 screen aspect ratio.

03. Screen Mute (Command2:d)

To select screen mute on/off.

Transmission [k][d][][Set ID][][Data][Cr]

Data 0 : Screen mute off (Picture on)

Data 1 : Screen mute on (Picture off)

Acknowledgement [d][][Set ID][][OK][Data][x]

04. Volume Mute (Command2:e)

To control volume mute on/off.

You can also adjust mute using the MUTE button on remote control.

Transmission [k][e][][Set ID][][Data][Cr]

Data 0 : Volume mute on (Volume off)

Data 1 : Volume mute off (Volume on)

Acknowledgement [e][][Set ID][][OK][Data][x]

05. Volume Control (Command2:f)

To adjust volume.

You can also adjust volume with the volume buttons on remote control.

Transmission [k][f][][Set ID][][Data][Cr]

Data Min : 0 ~ Max : 64

Refer to 'Real data mapping 1'. See page 87.

Acknowledgement [f][][Set ID][][OK][Data][x]

06. Contrast (Command2:g)

To adjust screen contrast.

You can also adjust contrast in the Picture menu.

Transmission [k][g][][Set ID][][Data][Cr]

Data Min : 0 ~ Max : 64

Refer to 'Real data mapping 1'. See page 87.

Acknowledgement [g][][Set ID][][OK][Data][x]

07. Brightness (Command2:h)

To adjust screen brightness.

You can also adjust brightness in the Picture menu.

Transmission [k][h][][Set ID][][Data][Cr]

Data Min : 0 ~ Max : 64

Refer to 'Real data mapping 1'. See page 87.

Acknowledgement [h][][Set ID][][OK][Data][x]

08. Color (Command2:i)

To adjust the screen color.

You can also adjust color in the Picture menu.

Transmission [k][i][][Set ID][][Data][Cr]

Data Min : 0 ~ Max : 64

Refer to 'Real data mapping 1'. See page 87.

Acknowledgement [i][][Set ID][][OK][Data][x]

09. Tint (Command2:j)

To adjust the screen tint.

You can also adjust tint in the Picture menu.

Transmission [k][j][][Set ID][][Data][Cr]

Data Red : 0 ~ Green : 64

Refer to 'Real data mapping 1'. See page 87.

Acknowledgement [j][][Set ID][][OK][Data][x]

10. Sharpness (Command2:k)

To adjust the screen sharpness.

You can also adjust sharpness in the Picture menu.

Transmission [k][k][][Set ID][][Data][Cr]

Data Min: 0 ~ Max: 64

Refer to 'Real data mapping 1'. See page 87.

Acknowledgement [k][][Set ID][][OK][Data][x]

11. OSD Select (Command2:l)

To select OSD (On Screen Display) on/off when controlling remotely.

Transmission [k][l][][Set ID][][Data][Cr]

Data 0: OSD off

Data 1: OSD on

Acknowledgement [l][][Set ID][][OK][Data][x]

12. Remote Control Lock Mode (Command2:m)

To lock the remote control and the front panel controls on the set.

Transmission [k][m][][Set ID][][Data][Cr]

Data 0: Lock off

Data 1: Lock on

Acknowledgement [m][][Set ID][][OK][Data][x]

If you're not using the remote control and front panel controls on the TV, use this mode. When main power is on/off, remote control lock is released.

13. PIP / DW / POP (Command2:n)

To control the PIP (Picture In picture)/Double window.

You can also control the PIP/Double window using the PIP button on the remote control.

Transmission [k][n][][Set ID][][Data][Cr]

Data 0: PIP/DW off

Data 1: PIP

Data 2: DW1

Data 3: DW2

Data5: POP

Acknowledgement [n][][Set ID][][OK][Data][x]

14. PIP Position (Command2:q)

To select sub picture position for PIP.

You can also adjust the sub picture position using POSITION button on the remote control.

Transmission [k][q][][Set ID][][Data][Cr]

Data 0: Right down on screen

Data 1: Left down on screen

Data 2: Left up on screen

Data 3: Right up on screen

Acknowledgement [q][][Set ID][][OK][Data][x]

15. Treble (Command2:r)

To adjust treble.

You can also adjust treble in the Sound menu.

Transmission [k][r][][Set ID][][Data][Cr]

Data Min: 0 ~ Max: 64

Refer to 'Real data mapping 1'. See page 87.

Acknowledgement [r][][Set ID][][OK][Data][x]

16. Bass (Command2:s)

To adjust bass.

You can also adjust bass in the Sound menu.

Transmission [k][s][][Set ID][][Data][Cr]

Data Min: 0 ~ Max: 64

Refer to 'Real data mapping 1'. See page 87.

Acknowledgement [s][][Set ID][][OK][Data][x]

17. Balance (Command2:t)

To adjust balance.

You can also adjust balance in the Sound menu.

Transmission [k][t][][Set ID][][Data][Cr]

Data Min: 0 ~ Max: 64

Refer to 'Real data mapping 1'. See page 87.

Acknowledgement [t][][Set ID][][OK][Data][x]

18. Color Temperature (Command2:u)

To adjust color temperature.

You can also adjust ACC in the Picture menu.

Transmission [k][u][][Set ID][][Data][Cr]

Data 0: Cool 1: Normal 2: Warm 3: User

Acknowledgement [u][][Set ID][][OK][Data][x]

19. Red Adjustment (Command2:v)

To adjust red in color temperature.

Transmission [k][v][][Set ID][][Data][Cr]

Data Min: 0 ~ Max: 50

Refer to 'Real data mapping 2'. See page 87.

Acknowledgement [v][][Set ID][][OK][Data][x]

20. Green Adjustment (Command2:w)

To adjust red in color temperature.

Transmission [k][w][][Set ID][][Data][Cr]

Data Min: 0 ~ Max: 50

Refer to 'Real data mapping 2'. See page 87.

Acknowledgement [w][][Set ID][][OK][Data][x]

APPENDIX

21. Blue Adjustment (Command2:\$)

To adjust red in color temperature.

Transmission [k][\$][][Set ID][][Data][Cr]

Data Min: 0 ~ Max: 50

Refer to 'Real data mapping 2'. See page 87.

Acknowledgement [\$][][Set ID][][OK][Data][x]

22. Abnormal State (Command2:z)

To recognize an abnormal state.

Transmission [k][z][][Set ID][][FF][][Cr]

Data FF: Read

Acknowledgement [z][][Set ID][][OK][Data][x]

Data 0: Normal (Power on and signal exist)

Data 1: No signal (Power on)

Data 2: Turn the TV off by remote control

Data 3: Turn the TV off by sleep time function

Data 4: Turn the TV off by RS-232C function

Data 5: 5V down

Data 6: AC down

Data 7: Turn the TV off by Fan Alarm function (option)

Data 8: Turn the TV off by Off time function

Data 9: Turn the TV off by Auto sleep function

Data a: Turn the TV off by AV board detect

* This function is "read only".

23. ISM Method (Command1:j, Command2:p)

To control the ISM method. You can also adjust ISM Method in SPECIAL menu. (This feature is not available for all models.)

Transmission [j][p][][Set ID][][Data][Cr]

Data 0: Normal Mode Data 1: White Wash

Data 2: Orbiter Data 3: Inversion

Acknowledgement [p][][Set ID][][OK][Data][x]

24. Low Power (Command1:j, Command2:q)

To reduce the power consumption of the monitor.

You can also adjust Low Power in SPECIAL menu.

(This feature is not available for all models.)

Transmission [j][q][][Set ID][][Data][][Cr]

Data 0: Off Data 1: On

Acknowledgement [q][][Set ID][][OK][Data][x]

25. Channel Tuning (Command1:m, Command2:a)

Tune channel to following physical number.

Transmission [m][a][][Set ID][][Data0][][Data1][][Data2][][Data3][][Data4][][Data5][Cr]

Data 0: NTSC air : 02 ~ 45

NTSC cable : 01, 0E ~ 7D

Data 1 ~ 4: Don't care

Data 5: Attribute

Acknowledgement [a][][Set ID][][OK][Data0][Data1][Data2][Data3][Data4][Data5][x][a][][Set ID][][NG][Data0][x]

26. Channel Add/Del (Command1:m, Command2:b)

To add and delete the channels

Transmission [m][b][][Set ID][][Data][Cr]

Data 0: Delete Data 1: Add

Acknowledgement [b][][Set ID][][OK][Data][x]

27. Key (Command1:m, Command2:c)

To send IR remote key code.

Transmission [m][c][][Set ID][][Data][Cr]

Data: Key code - Refer to page 89.

Acknowledgement [c][][Set ID][][OK][Data][x]

28. Auto Configure (Command1:j, Command2:u)

To adjust picture position and minimize image shaking automatically. It works only in RGB (PC) mode.

Transmission [j][u][][Set ID][][Data][Cr]

Data 1: To set

Acknowledgement [u][][Set ID][][OK][Data][x]

29. Input selection (Command1:x, Command2:b) (Main Picture Input)

To select input source for TV.

Transmission [x][b][][Set ID][][Data][Cr]

Data: Structure

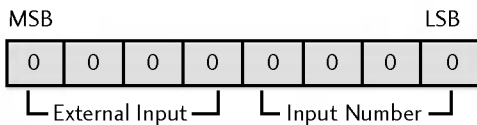

| External Input | | | | Data |
|----------------|---|---|---|-----------|
| 0 | 0 | 0 | 1 | Analog |
| 0 | 0 | 1 | 0 | AV |
| 0 | 1 | 0 | 0 | Component |
| 0 | 1 | 0 | 1 | RGB-DTV |
| 0 | 1 | 1 | 0 | RGB-PC |
| 1 | 0 | 0 | 1 | HDMI |

| Input Number | | | | Data |
|--------------|---|---|---|--------|
| 0 | 0 | 0 | 0 | Input1 |
| 0 | 0 | 0 | 1 | Input2 |

Acknowledgement [b][][Set ID][][OK][Data][x]

30. Input selection (Sub) (Command1:x, Command2:y)

To adjust input source for sub picture in PIP mode.

Transmission [x][y][][Set ID][][Data][Cr]

Data: Structure

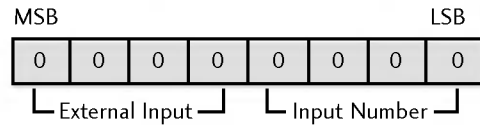

| External Input | | | | Data |
|----------------|---|---|---|-----------|
| 0 | 0 | 0 | 1 | Analog |
| 0 | 0 | 1 | 0 | AV |
| 0 | 1 | 0 | 0 | Component |
| 0 | 1 | 0 | 1 | RGB-DTV |
| 0 | 1 | 1 | 0 | RGB-PC |
| 1 | 0 | 0 | 1 | HDMI |

| Input Number | | | | Data |
|--------------|---|---|---|--------|
| 0 | 0 | 0 | 0 | Input1 |
| 0 | 0 | 0 | 1 | Input2 |

Acknowledgement [y][][Set ID][][OK][Data][x]

* Real data mapping 1

0 : Step 0
 ⋮
 A : Step 10 (Set ID 10)
 ⋮
 F : Step 15 (Set ID 15)
 10 : Step 16 (Set ID 16)
 ⋮
 64 : Step 100
 ⋮
 6E : Step 110
 ⋮
 73 : Step 115
 74 : Step 116
 ⋮
 C7 : Step 199
 ⋮
 FE : Step 254
 FF : Step 255

* Real data mapping 2

0 : -40
 1 : -39
 2 : -38
 ⋮
 28 : 0
 ⋮
 48 : +38
 49 : +39
 50 : +40

APPENDIX

IR CODES

1. How to Connect

- Connect your wired remote control to the Remote Control port on the TV.

2. Remote Control IR Codes

■ Output waveform

Single pulse, modulated with 37.917KHz signal at 455KHz

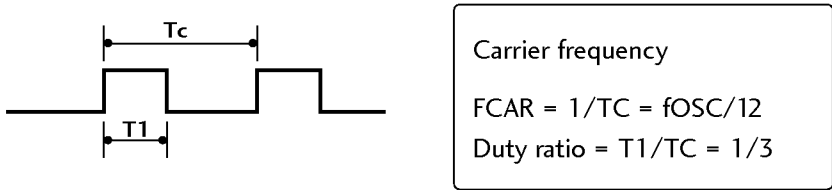

■ Configuration of frame

1st frame

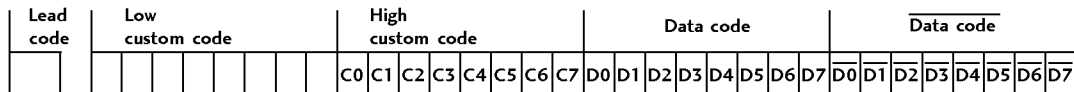

Repeat frame



■ Lead code

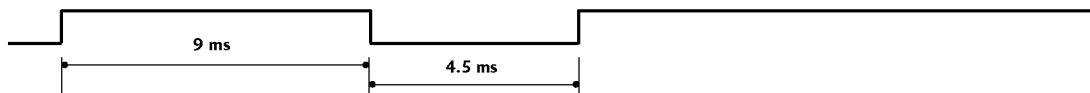

■ Repeat code

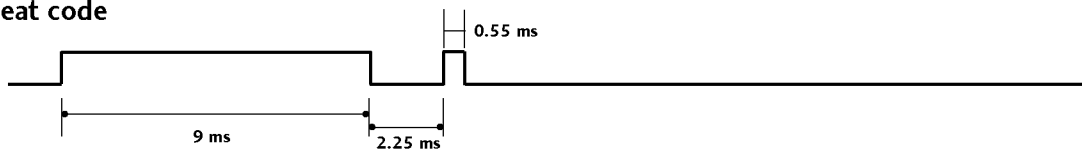

■ Bit description

Bit "0"

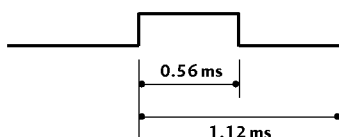

Bit "1"

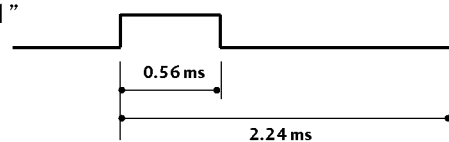

■ Frame interval: Tf

The waveform is transmitted as long as a key is depressed.

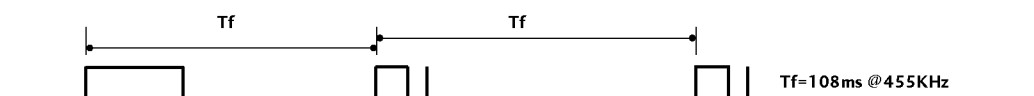

| Code (Hexa) | Function | Note | Code (Hexa) | Function | Note |
|-------------|--------------|--------------------------------------|-------------|------------------|-----------------------|
| 0F | TV | Remote control Button | 44 | ENTER | Remote control Button |
| 0B | INPUT | Remote control Button | 72 | PIP CH- | Remote control Button |
| 08 | POWER | Remote control Button (Power On/Off) | 71 | PIP CH+ | Remote control Button |
| C4 | POWER ON | Discrete IR Code (Only Power On) | 61 | PIP INPUT | Remote control Button |
| C5 | POWER OFF | Discrete IR Code (Only Power OFF) | 02 | VOL + | Remote control Button |
| 60 | PIP | Remote control Button | 03 | VOL - | Remote control Button |
| 0E | SLEEP | Remote control Button | 00 | CH + | Remote control Button |
| 39 | Caption | Remote control Button | 01 | CH - | Remote control Button |
| 0A | MTS | Remote control Button | 09 | MUTE | Remote control Button |
| 43 | MENU | Remote control Button | 55 | Memory/Erase | Remote control Button |
| 79 | ARC | Remote control Button | 10 ~ 19 | Number Key 0 ~ 9 | Remote control Button |
| 5B | EXIT | Remote control Button | 1E | FCR | Remote control Button |
| 07 | ◀ | Remote control Button | 1A | REVIEW | Remote control Button |
| 06 | ▶ | Remote control Button | 64 | SIZE | Remote control Button |
| 40 | ▲ | Remote control Button | 62 | POSITION | Remote control Button |
| 41 | ▼ | Remote control Button | E0 | 🔊+ | Remote control Button |
| B3 | LIVE TV | Remote control Button | E1 | 🔊- | Remote control Button |
| B0 | PLAY | Remote control Button | 63 | SWAP | R/C Button |
| BA | PAUSE | Remote control Button | | | |
| B1 | STOP | Remote control Button | | | |
| BD | REC | Remote control Button | | | |
| B4 | REW | Remote control Button | | | |
| B5 | FF | Remote control Button | | | |
| B2 | GOTOPREV | Remote control Button | | | |
| B3 | GOTONEXT | Remote control Button | | | |
| C8 | TIME MACHINE | Remote control Button | | | |

APPENDIX

PROGRAMMING THE REMOTE CONTROL

The provided universal remote control can be programmed to operate most remote-controllable devices. Note that the remote may not control all models of other brands.

Programming a code into a remote mode

- 1 To find out whether your remote control can operate each device without programming, turn on the device (such as a VCR) and press the corresponding mode button on the remote.
After that, press the **POWER** button. If the device is turned off and it responds properly the remote control need not be programmed. If not, the remote should be programmed to operate the device. The programming procedures are explained below.
- 2 Press the **MENU** and **MUTE** button continuously at the same time for two seconds; the currently selected device button is illuminated.
If you don't press any button for 20 seconds, the light on the mode button will be turned off. In that case, you have to repeat from step 2.
- 3 Enter the appropriate code from the code table on the following pages. When pressing the button, the light blinks at a time. If the device turned off, the programming is successful.
- 4 Press the **MENU** button to store the code. After blinking twice, this code is stored.
- 5 Test the remote control functions to see if the device responds properly. If not, steps 2-5.

PROGRAMMING CODES

DVD

| Brand | Codes | Brand | Codes | Brand | Codes |
|---------------|-----------------|------------|---------|----------|-------------|
| APEX DIGITAL | 022 | mitsubishi | 002 | RCA | 005 006 |
| DENON | 020 014 | NAD | 023 | SAMSUNG | 011 015 |
| GE | 005 006 | ONKYO | 008 017 | SONY | 007 |
| HARMAN KARDON | 027 | PANASONIC | 003 009 | THOMPSON | 005 006 |
| JVC | 012 | PHILIPS | 013 | TOSHIBA | 019 008 |
| LG | 001 010 016 025 | PIONEER | 004 026 | YAMAHA | 009 018 |
| MAGNAVOX | 013 | PROCEED | 021 | ZENITH | 010 016 025 |
| MARANTZ | 024 | PROSCAN | 005 006 | | |

VCRs

| Brand | Codes | Brand | Codes | Brand | Codes |
|----------------|-----------------|------------|-----------------|-----------------|-----------------|
| AIWA | 034 | MAGNAVOX | 031 033 034 041 | SAMSUNG | 032 040 102 104 |
| AKAI | 016 043 046 124 | | 067 068 | | 105 107 109 112 |
| | 125 146 | MARANTZ | 012 031 033 067 | | 113 115 120 122 |
| AMPRO | 072 | | 069 | | 125 |
| ANAM | 031 033 103 | MARTA | 101 | SANSUI | 022 043 048 135 |
| AUDIO DYNAMICS | 012 023 039 043 | MATSUI | 027 030 | SANYO | 003 007 010 014 |
| BROKSONIC | 035 037 129 | MEI | 031 033 | | 102 134 |
| CANON | 028 031 033 | MEMOREX | 003 010 014 031 | SCOTT | 017 037 112 129 |
| CAPEHART | 108 | | 033 034 053 072 | | 131 |
| CRAIG | 003 040 135 | | 101 102 134 139 | SEARS | 003 008 009 010 |
| CURTIS MATHES | 031 033 041 | MGA | 045 046 059 | | 013 014 017 020 |
| DAEWOO | 005 007 010 064 | MINOLTA | 013 020 | | 031 042 073 081 |
| | 065 108 110 111 | MITSUBISHI | 013 020 045 046 | | 101 |
| | 112 116 117 119 | | 049 051 059 061 | SHARP | 031 054 149 |
| DAYTRON | 108 | | 151 | SHINTOM | 024 |
| DBX | 012 023 039 043 | MTC | 034 040 | SONY | 003 009 031 052 |
| DYNATECH | 034 053 | MULTITECH | 024 034 | | 056 057 058 076 |
| ELECTROHOME | 059 | NEC | 012 023 039 043 | | 077 078 149 |
| EMERSON | 006 017 025 027 | | 048 | SOUNDESIGN | 034 |
| | 029 031 034 035 | NORDMENDE | 043 | STS | 013 |
| | 036 037 046 101 | OPTONICA | 053 054 | SYLVANIA | 031 033 034 059 |
| | 129 131 138 153 | PANASONIC | 066 070 074 083 | | 067 |
| FISHER | 003 008 009 010 | | 133 140 145 | SYMPHONIC | 034 |
| FUNAI | 034 | | | TANDY | 010 034 |
| GE | 031 033 063 072 | PENTAX | 013 020 031 033 | TATUNG | 039 043 |
| | 107 109 144 147 | | 063 | TEAC | 034 039 043 |
| GO VIDEO | 132 136 | PHILCO | 031 034 067 | TECHNICS | 031 033 070 |
| HARMAN KARDON | 012 045 | PHILIPS | 031 033 034 054 | TEKNIKA | 019 031 033 034 |
| HITACHI | 004 018 026 034 | | 067 071 101 | | 101 |
| | 043 063 137 150 | PILOT | 101 | THOMAS | 034 |
| INSTANTREPLAY | 031 033 | PIONEER | 013 021 048 | TMK | 006 |
| JCL | 031 033 | PORTLAND | 108 | TOSHIBA | 008 013 042 047 |
| JCPENNY | 012 013 015 033 | PULSAR | 072 | | 059 082 112 131 |
| | 040 066 101 | QUARTZ | 011 014 | TOTEVISION | 040 101 |
| JENSEN | 043 | QUASAR | 033 066 075 145 | UNITECH | 040 |
| JVC | 012 031 033 043 | RCA | 013 020 033 034 | VECTOR RESEARCH | 012 |
| | 048 050 055 060 | | 040 041 062 063 | VICTOR | 048 |
| | 130 150 152 | | 107 109 140 144 | VIDEO CONCEPTS | 012 034 046 |
| KENWOOD | 014 034 039 043 | | 145 147 | VIDEOSONIC | 040 |
| | 047 048 | REALISTIC | 003 008 010 014 | WARDS | 003 013 017 024 |
| LG (GOLDSTAR) | 001 012 013 020 | | 031 033 034 040 | | 031 033 034 040 |
| | 101 106 114 123 | | 053 054 101 | | 053 054 131 |
| LLOYD | 034 | RICO | 058 | YAMAHA | 012 034 039 043 |
| LXI | 003 009 013 014 | RUNCO | 148 | ZENITH | 034 048 056 |
| | 017 034 101 106 | SALORA | 014 | | 058 072 080 101 |
| MAGIN | 040 | | | | |

APPENDIX

TROUBLESHOOTING CHECKLIST

| The operation does not work normally. | |
|--|---|
| The remote control doesn't work | <ul style="list-style-type: none"> ■ Check to see if there is any object between the product and the remote control causing obstruction. Ensure you are pointing the remote control directly at the TV. ■ Ensure that the batteries are installed with correct polarity (+ to +, - to -). ■ Ensure that the correct remote operating mode is set: TV, VCR etc. ■ Install new batteries. |
| Power is suddenly turned off | <ul style="list-style-type: none"> ■ Is the sleep timer set? ■ Check the power control settings. Power interrupted. ■ No broadcast on station tuned with Auto off activated. |

| The video function does not work. | |
|--|---|
| No picture & No sound | <ul style="list-style-type: none"> ■ Check whether the product is turned on. ■ Try another channel. The problem may be with the broadcast. ■ Is the power cord inserted into wall power outlet? ■ Check your antenna direction and/or location. ■ Test the wall power outlet, plug another product's power cord into the outlet where the product's power cord was plugged in. |
| Picture appears slowly after switching on | <ul style="list-style-type: none"> ■ This is normal, the image is muted during the product startup process. Please contact your service center, if the picture has not appeared after five minutes. |
| No or poor color or poor picture | <ul style="list-style-type: none"> ■ Adjust Color in menu option. ■ Keep a sufficient distance between the product and the VCR. ■ Try another channel. The problem may be with the broadcast. ■ Are the video cables installed properly? ■ Activate any function to restore the brightness of the picture. |
| Horizontal/vertical bars or picture shaking | <ul style="list-style-type: none"> ■ Check for local interference such as an electrical appliance or power tool. |
| Poor reception on some channels | <ul style="list-style-type: none"> ■ Station or cable product experiencing problems, tune to another station. ■ Station signal is weak, reorient antenna to receive weaker station. ■ Check for sources of possible interference. |
| Lines or streaks in pictures | <ul style="list-style-type: none"> ■ Check antenna (Change the direction of the antenna). |

The audio function does not work.

| | |
|--|--|
| Picture OK & No sound | <ul style="list-style-type: none">■ Press the VOL or VOLUME button.■ Sound muted? Press MUTE button.■ Try another channel. The problem may be with the broadcast.■ Are the audio cables installed properly? |
| No output from one of the speakers | <ul style="list-style-type: none">■ Adjust Balance in menu option. |
| Unusual sound from inside the product | <ul style="list-style-type: none">■ A change in ambient humidity or temperature may result in an unusual noise when the product is turned on or off and does not indicate a fault with the product. |

There is a problem in PC mode. (Only PC mode applied)

| | |
|---|---|
| The signal is out of range. | <ul style="list-style-type: none">■ Adjust resolution, horizontal frequency, or vertical frequency.■ Check the input source. |
| Vertical bar or stripe on background & Horizontal Noise & Incorrect position | <ul style="list-style-type: none">■ Work the Auto configure or adjust clock, phase, or H/V position. (Option) |
| Screen color is unstable or single color | <ul style="list-style-type: none">■ Check the signal cable.■ Reinstall the PC video card. |

APPENDIX

MAINTENANCE

Early malfunctions can be prevented. Careful and regular cleaning can extend the amount of time you will have your new TV. Be sure to turn the power off and unplug the power cord before you begin any cleaning.

Cleaning the Screen

- 1 Here's a great way to keep the dust off your screen for a while. Wet a soft cloth in a mixture of lukewarm water and a little fabric softener or dish washing detergent. Wring the cloth until it's almost dry, and then use it to wipe the screen.
- 2 Make sure the excess water is off the screen, and then let it air-dry before you turn on your TV.

Cleaning the Cabinet

- To remove dirt or dust, wipe the cabinet with a soft, dry, lint-free cloth.
- Please be sure not to use a wet cloth.

Extended Absence

CAUTION

- ▶ If you expect to leave your TV dormant for a long time (such as a vacation), it's a good idea to unplug the power cord to protect against possible damage from lightning or power surges.

PRODUCT SPECIFICATIONS

| MODELS | | 42PB2RR/42PB2RRH (42PB2RR/42PB2RRH-ML) | 50PB2RR/50PB2RRH (50PB2RR/50PB2RRH-ML) |
|--|-----------------------|--|--|
| Dimensions (Width x Height x Depth) | including stand | 46.5 x 30.9 x 14.8 inches 1180.0 x 785.0 x 377.0 mm | 54.4 x 35.9 x 14.8 inches 1382.0 x 913.0 x 377.0 mm |
| | excluding stand | 46.5 x 28.5 x 4.1 inches 1180.0 x 724.0 x 104.0 mm | 54.4 x 33.4 x 4.9 inches 1382.0 x 848.5 x 125.0 mm |
| Weight | including stand | 80.0 pounds / 36.3 kg | 137.1 pounds / 62.2 kg |
| | excluding stand | 61.0 pounds / 27.7 kg | 108.5 pounds / 49.2 kg |
| Power requirement | | AC100-240V -50/60Hz | AC100-240V -50/60Hz |
| Television System | | NTSC, PAL-M/N | |
| Program Coverage | | VHF 2 ~ 13, UHF 14 ~ 69, CATV 1 ~ 125 | |
| External Antenna Impedance | | 75 ohm | |
| Environment condition | Operating Temperature | 32 ~ 104°F (0 ~ 40°C) | |
| | Operating Humidity | Less than 80% | |
| | Storage Temperature | -4 ~ 140°F (-20 ~ 60°C) | |
| | Storage Humidity | Less than 85% | |

■ The specifications shown above may be changed without prior notice for quality improvement.