



PLASMA TV OWNER'S MANUAL

Please read this manual carefully before operating your set.
Retain it for future reference.
Record model number and serial number of the set.
See the label attached on the back cover and quote this information to your dealer when you require service.

Model number :
Serial number :

P/NO : 38289 (RF052A, 017M/N TX)

Safety Instructions

WARNING

Do not place the set in direct sunlight or near heat sources such as heat registers, stove and so on.

- This may cause a fire.

Do not use the set in damp place such as a bathroom or any place where it is likely to get wet.

- This may cause a fire or could give an electric shock.

Bend antenna cable between inside and outside building to prevent rain from flowing in.

- This may cause water damaged inside the set and could give an electric shock.

Earth wire should be connected.

- If the earth wire is not connected, there is possible a danger of electric shock caused by the current leakage.
- If grounding methods are not possible, a separate circuit breaker should be employed and installed by a qualified electrician.

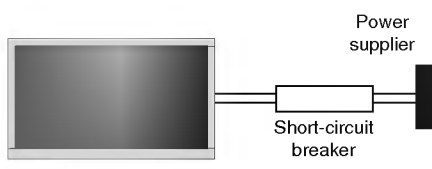

- Do not connect ground to telephone wires, lightning rods or gas pipe.

Apparatus shall not be exposed to dripping or splashing and no objects filled with liquids, such as vases, shall be placed on the apparatus.

WARNING in U.K. only

- * This set is supplied with a BS 1363 approved 13 amp mains plug, fused at 13 amp. When replacing the fuse always use a 13 amp BS 1362, BSI or ASTA approved type. Never use this plug with the fuse cover omitted. To obtain a replacement fuse cover contact your dealer or "LG Electronics U.K. Ltd." If the type of plug supplied is not suitable for the mains sockets in your home, then the plug should be removed and a suitable type fitted. A mains plug removed from the mains lead of this set must be destroyed. A mains plug with bared wires is hazardous if inserted in a mains socket. Do not connect either wire to the earth pin, marked with the letter E or with the earth symbol  or coloured green or green and yellow. If any other plug is fitted, use a 13 amp fuse, either in the plug, or at the distribution board. The wires in this mains lead are coloured in accordance with the following codes: BLUE: NEUTRAL, BROWN: LIVE. As the colours of the wires in the mains lead of this set may not correspond with the coloured marking identifying the terminals in your plug, proceed as follows: The wire which is coloured blue must be connected to the terminal which is marked with the letter N or coloured black. The wire which is coloured brown must be connected to the terminal which is marked with the letter L or coloured red.

Do not insert any object into the exhaust vent.

- This may cause a fire or could give an electric shock.

Do not place heavy objects on the set.

- This may cause serious injury to a child or adult.

Do not use water while cleaning the set.

- This may cause damaged the set or could give an electric shock.

In case of smoke or strange smell from the set, switch it off ,unplug it from the wall outlet and contact your dealer or service center.

- This may cause a fire or could give an electric shock.

Do not attempt to service the set yourself. Contact your dealer or service center.

- This may cause damaged the set or could give an electric shock.

During a lightning thunder, unplug the set from the wall outlet and don't touch an antenna cable.

- This may cause damaged the set or could give an electric shock.

DISCONNECTING DEVICE FROM MAINS

- Mains plug is the disconnecting device. The plug must remain readily operable.

WARNING

This is Class A product. In a domestic environment this product may cause radio interference in which case the user may be required to take adequate measures.

WARNING

TO REDUCE THE RISK OF FIRE AND ELECTRIC SHOCK, DO NOT EXPOSE THIS PRODUCT TO RAIN OR MOISTURE.

* Safety instructions have two kinds of information, and each meaning of it is as below.

⚠ WARNING The violation of this instruction may cause serious injuries and even death.

⚠ NOTES The violation of this instruction may cause light injuries or damage of the product.

⚠ Take care of danger that may happen under specific condition.

⚠ NOTES

Never touch the power plug with a wet hand.

- This may cause an electric shock.

Disconnect from the mains and remove all connections before moving.

Do not place the set in a built-in installation such as a bookcase or rack.

- Ventilation required.

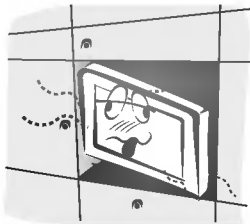

When installing the set on a table, be careful not to place the edge of its stand.

- This may cause the set to fall, causing serious injury to a child or adult, and serious damage to the set.



Do not place an outside antenna in the vicinity of overhead power lines or other electric light or power circuits.

- This may cause an electric shock.

There should be enough distance between an outside antenna and power lines to keep the former from touching the latter even when the antenna falls.

- This may cause an electric shock.

Do not pull the cord but the plug when unplugging.

- This may cause a fire.

Ensure the power cord doesn't trail across any hot objects like a heater.

- This may cause a fire or an electric shock.

Do not plug when the power cord or the plug is damaged or the connecting part of the power outlet is loose.

- This may cause a fire or an electric shock.

Dispose of used batteries carefully to protect a child from eating them.

- In case that it eats them, take it to see a doctor immediately.

When moving the set assembled with speakers do not carry holding the speakers.

- This may cause the set to fall, causing serious injury to a child or adult, and serious damage to the set.

Unplug this product from the wall outlet before cleaning. Do not use liquid cleaners or aerosol cleaners.

- This may cause damaged the set or could give an electric shock.

Contact the service center once a year to clean the internal part of the set.

- Accumulated dust can cause mechanical failure.

The distance between eyes and the screen should be about 5 ~ 7 times as long as diagonal length of the screen.

- If not, eyes will strain.

Unplug the set from the wall outlet when it is left unattended and unused for long periods of time or occurred a state of emergency.

- Accumulated dust may cause a fire or an electric shock from deterioration or electric leakage.

Contents

Safety Warnings	
Safety Instructions	2-3
Introduction	
Remote Control Key Functions	5
Location and Function of Controls	6-8
Installation	
External Equipment Viewing Setups	9
Displayable Monitor Specification	10
HDMI	11
Accessories	12
Installation Options	13
Operation	
Turning on the Set	14
On-Screen Menu Language Selection (option)	14
On screen menus	15
Channel Menu Options	
Auto Programme Tuning	16
Manual Programme Tuning	16
Fine Tuning	16
Assigning a Station Name	17
Booster (option)	17
Programme Edit	17
Favourite Programme	17
Calling up the Programme Table	17
Picture Menu Options	
PSM (Picture Status Memory)	18
CSM (Colour Status Memory)	18
Manual Colour Temperature Control	18
XD	18
sRGB	18
ACM (Active Colour Management)	18
Manual Picture Control	18
Sound Menu Options	
SSM (Sound Status Memory)	18
BBE	18
AVL (Auto Volume Leveler)	18
Adjusting Sound Control	18
TV speaker	19
Stereo/Dual Reception	19
NICAM Reception (option)	19
Time Menu Options	
Setting the Clock	19
Setting the On/Off Timer	19
Auto Sleep	19
Sleep Timer	19
Special Menu Options	
Child Lock	20
ISM (Image Sticking Minimization) Method	20
Low Power	20
XD Demo	20
Screen Menu Options	
Auto Configure	20
Manual Configure	20
Selecting Wide VGA/XGA mode	20
Setting Picture Format	21
Picture Size Zoom	21
Screen Position	21
Cinema	21
NR (Noise Reduction)	21
Initializing (Reset to original factory value)	21
Teletext (option)	
Teletext Language Selection	21
Switch on/off	21
SIMPLE Text (option)	22
TOP Text (option)	22
FASTEXT	22
Special Teletext Functions	22
Miscellaneous	
Troubleshooting Checklist	24
Product Specifications	25

After reading this manual, keep it in the place where the user can always contact easily.

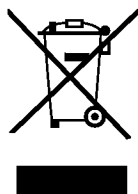

Disposal of your old appliance

1. When this crossed-out wheeled bin symbol is attached to a product it means the product is covered by the European Directive 2002/96/EC.
2. All electrical and electronic products should be disposed of separately from the municipal waste stream via designated collection facilities appointed by the government or the local authorities.
3. The correct disposal of your old appliance will help prevent potential negative consequences for the environment and human health.
4. For more detailed information about disposal of your old appliance, please contact your city office, waste disposal service or the shop where you purchased the product.

Remote Control Key Functions

- When using the remote control aim it at the remote control sensor of the set.
- There maybe a defect in consecutive operation of remote control in a specified brightness according to this set.

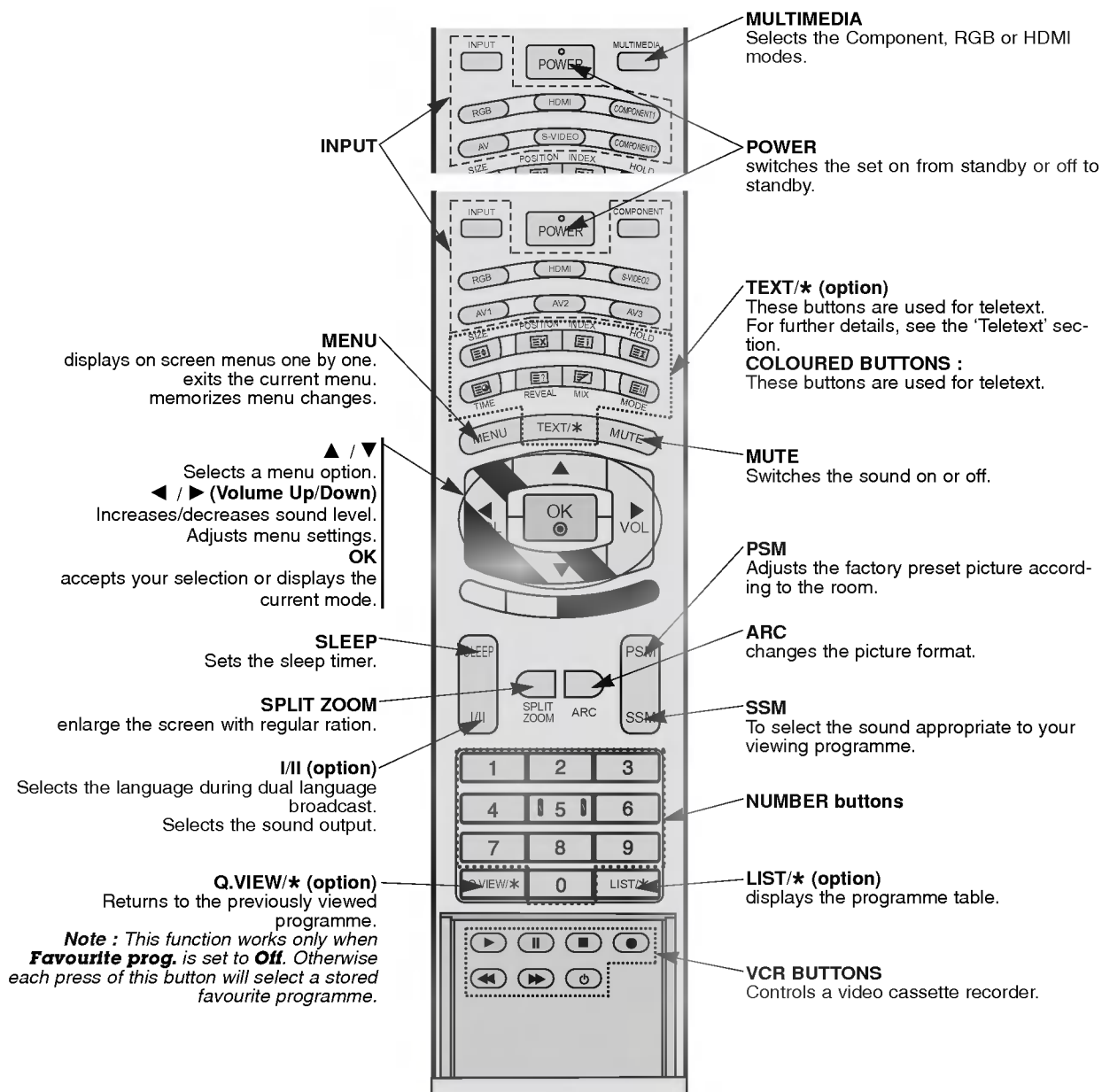

Installing Batteries

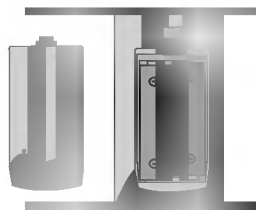

- Open the battery compartment cover on the back side and insert the batteries with correct polarity.
- Install two 1.5V alkaline batteries of AA type. Don't mix used batteries with new batteries.

Location and Function of Controls

- Shown is a simplified representation of the set.
- Here shown may be somewhat different from your set.

<Front Panel Controls>

42PM1MA/J series / 50PM1MA/J series

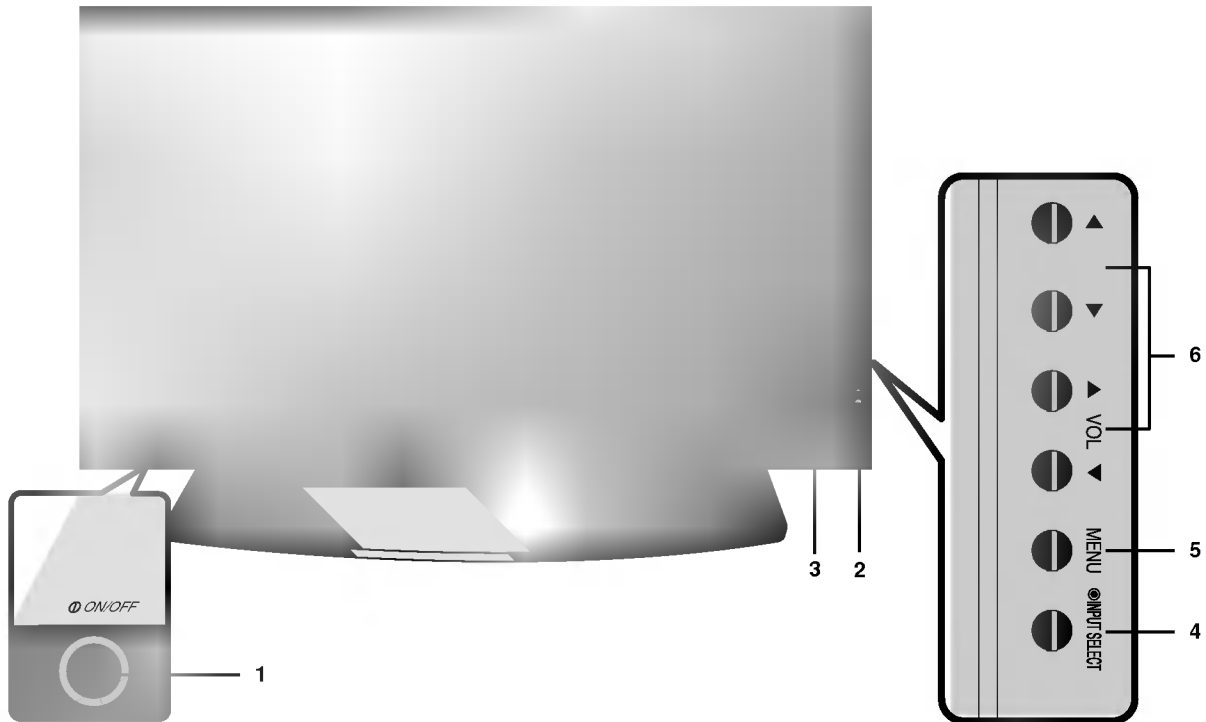

1. Main Power Button

2. Remote Control Sensor

3. Power Standby Indicator

Illuminates red in standby mode, Illuminates green when the set is turned on

4. INPUT SELECT Button

5. MENU

Displays on screen menus one by one.
Exits the current menu.
Memorizes menu changes.

6. ▲ / ▼

Selects a menu option.

◀ / ▶ (Volume Up/Down)

Increases/decreases sound level.

Adjusts menu settings.

<Front Panel Controls>

42PM3MVA/C/J series

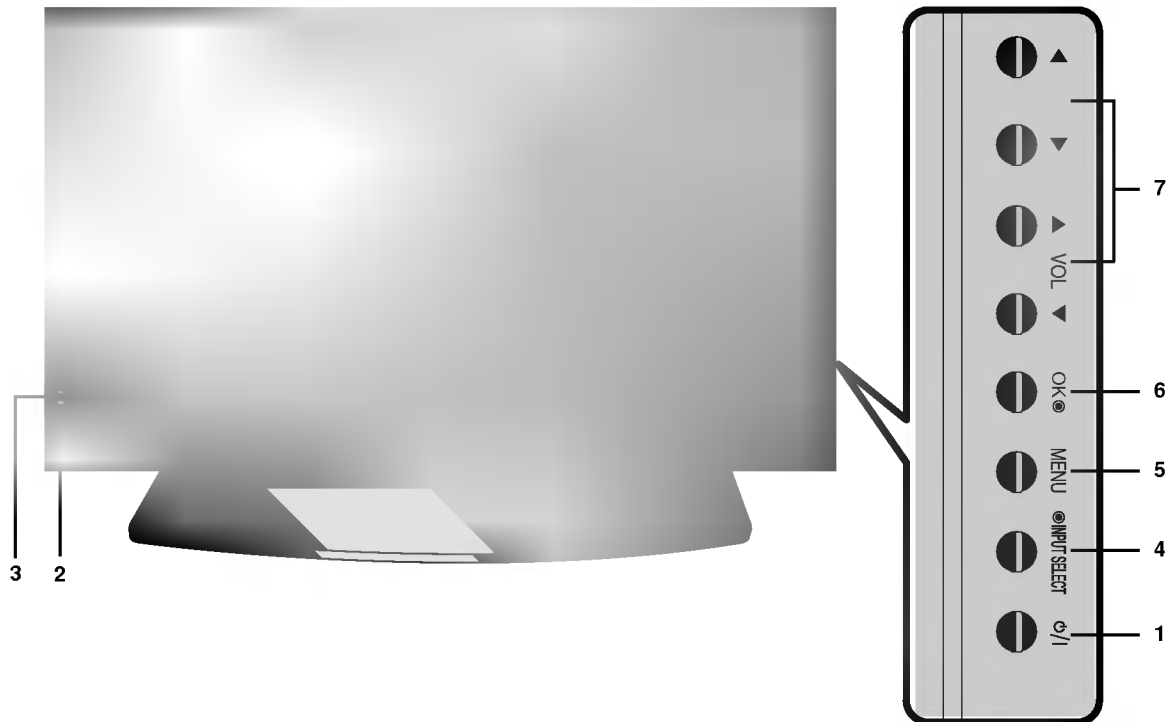

1. **Power Button**
Switches the set on from standby or off to standby.
2. **Remote Control Sensor**
3. **Power Standby Indicator**
Illuminates red in standby mode, Illuminates green when the set is turned on
4. **INPUT SELECT Button**
5. **MENU**
Displays on screen menus one by one.
Exits the current menu.
Memorizes menu changes.
6. **OK**
Accepts your selection or displays the current mode.
7. **▲ / ▼**
Selects a menu option.
◀ / ▶ (Volume Up/Down)
Increases/decreases sound level.
Adjusts menu settings.

Location and Function of Controls

<Back Panel>

RCA Type

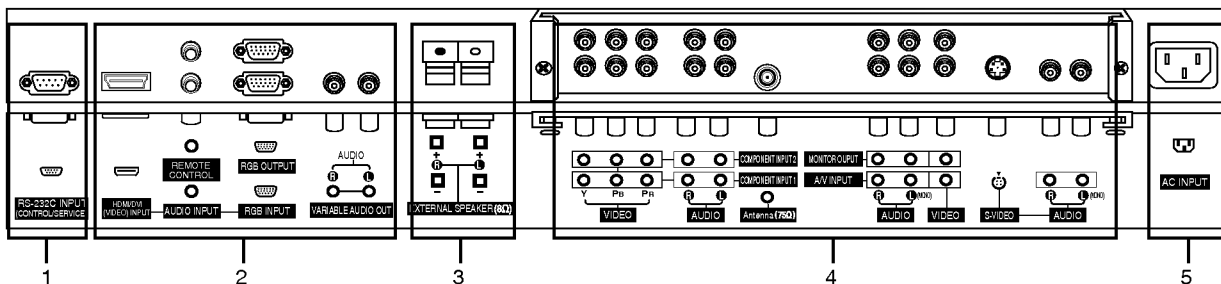

Scart Type

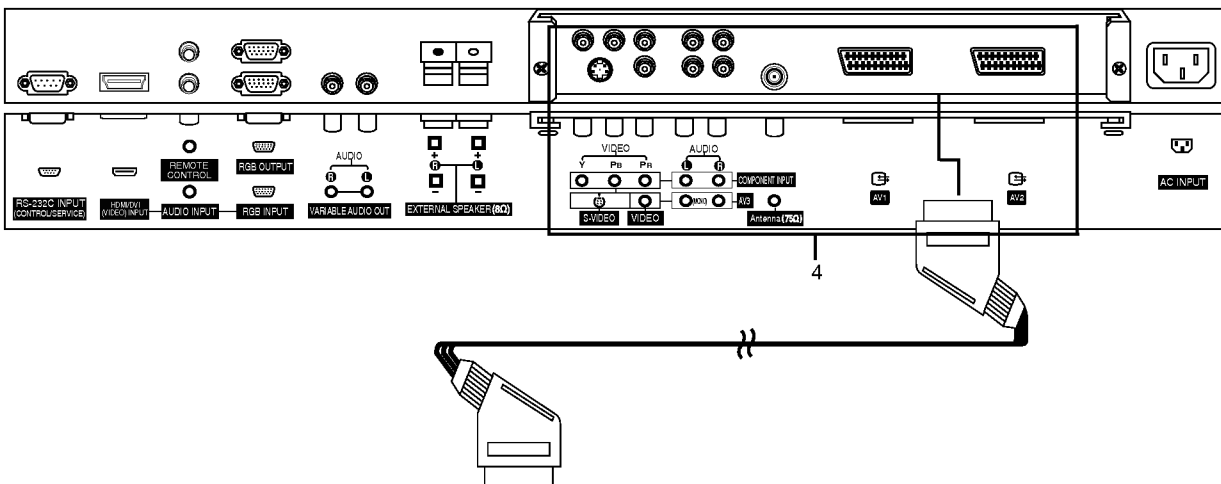

1. RS-232C INPUT (CONTROL/SERVICE) PORT
Connect to the RS-232C port on a PC.

2. HDMI/DVI (VIDEO) / AUDIO INPUT / RGB INPUT SOCKETS
Connect the monitor output socket of the PERSONAL COMPUTER to this socket.
Note: If you want to use RGB/DVI audio, we strongly recommend that you use the cable that has a core, or the EMI Filter core along with separate cable.

RGB OUTPUT SOCKET

You can watch the RGB signal on another set, connect RGB OUTPUT to another monitor's PC input port.

REMOTE CONTROL

VARIABLE AUDIO OUTPUT

3. EXTERNAL SPEAKER OUTPUT (8 ohm)

Connect to optional external speaker(s).
* For further information, refer to 'Speaker & Speaker Stand' manual.

4. COMPONENT / AUDIO INPUT SOCKETS
S-VIDEO / AUDIO (L/MONO) INPUT SOCKETS
VIDEO / AUDIO (L/MONO) INPUT SOCKETS

ANTENNA INPUT

EURO SCART SOCKET

Connect the euro scart socket of the VCR to these sockets.

Note:

- a. If you want to use the EURO scart cable, you have to use the signal shielded Euro scart cable.
- b. If you want to use your external hi-fi stereo system, turn off the internal speakers of the set.

5. POWER CORD SOCKET

This set operates on an AC power. The voltage is indicated on the Specifications page. Never attempt to operate the set on DC power.

External Equipment Viewing Setups

<Back Panel>

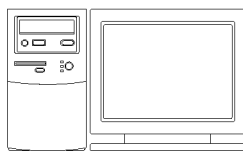
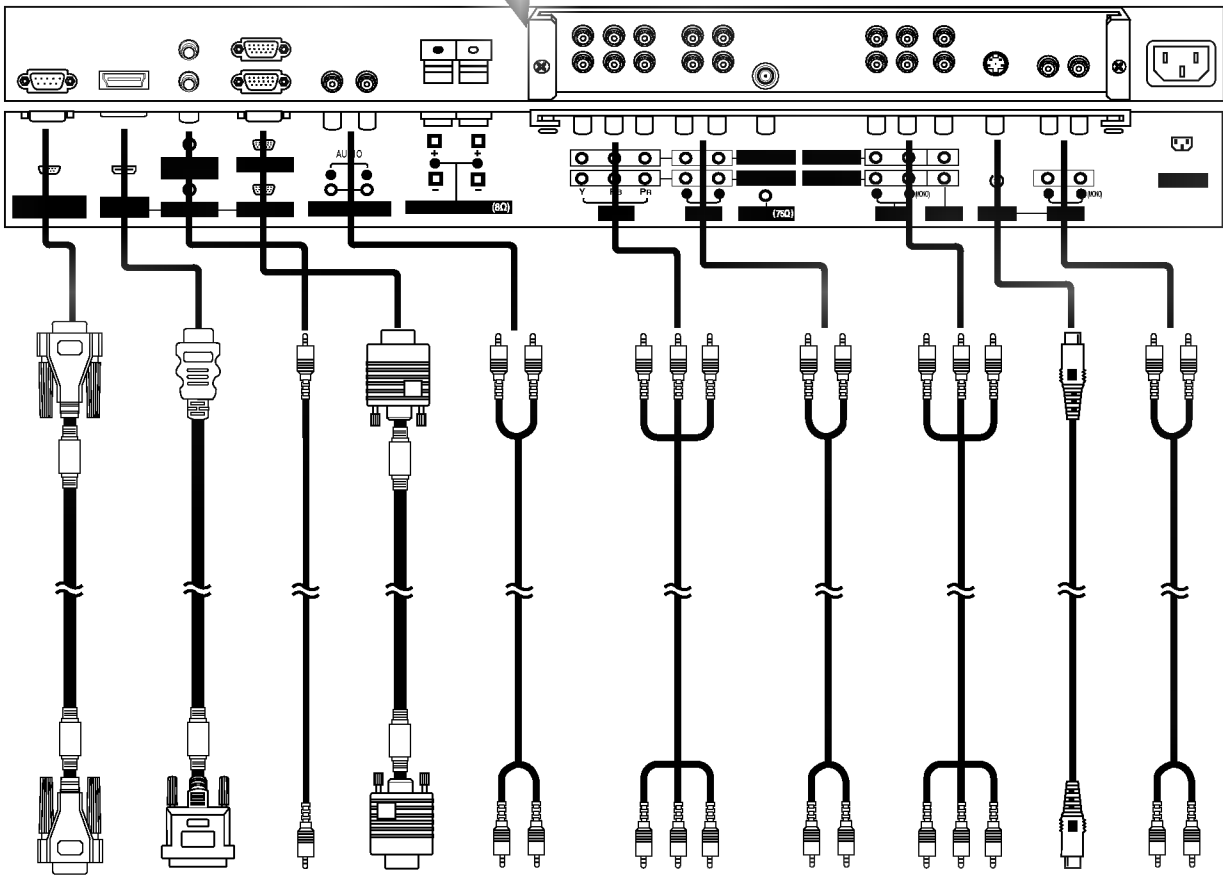

Connection to PC



Connection to AV equipment

Displayable Monitor Specification

RGB / HDMI mode

Resolution	Horizontal Frequency(KHz)	Vertical Frequency(Hz)
640x350	31.468	70.09
	37.861	85.08
720x400	31.469	70.08
	37.927	85.03
640x480	31.469	59.94
	35.000	66.66
	37.861	72.80
	37.500	75.00
848x480	43.269	85.00
	31.500	60.00
848x480	37.799	70.00
	39.375	75.00
	31.500	60.00
852x480	37.799	70.00
	39.375	75.00
	31.500	60.00
800x600	35.156	56.25
	37.879	60.31
	48.077	72.18
	46.875	75.00
832x624	53.674	85.06
	49.725	74.55
1024x768	48.363	60.00
	56.476	70.06
	60.023	75.02
	68.677	85.00
1152x864	54.348	60.05
	63.995	70.01
	67.500	75.00
1152x870	68.681	75.06
1280x960	60.023	60.02
1280x1024	63.981	60.02

42PM3MVA/C/J series

RGB / HDMI mode

Resolution	Horizontal Frequency(KHz)	Vertical Frequency(Hz)
640x350	31.468	70.09
	37.861	85.08
720x400	31.469	70.08
	37.927	85.03
640x480	31.469	59.94
	35.000	66.66
	37.861	72.80
	37.500	75.00
848x480	43.269	85.00
	31.500	60.00
848x480	37.799	70.00
	39.375	75.00
	31.500	60.00
852x480	37.799	70.00
	39.375	75.00
	31.500	60.00
800x600	35.156	56.25
	37.879	60.31
	48.077	72.18
	46.875	75.00
832x624	53.674	85.06
	49.725	74.55
1024x768	48.363	60.00
	56.476	70.06
	60.023	75.02
	68.677	85.00
1360x768	47.700	60.00
	59.625	75.02
1366x768	47.700	60.00
	59.625	75.02
1152x864	54.348	60.05
	63.995	70.01
	67.500	75.00
1152x870	68.681	75.06
1280x768	47.693	59.99
	60.091	74.93
1280x960	60.023	60.02
1280x1024	63.981	60.02

42PM1MA/J series
50PM1MA/J series

• Component/HDMI Input signal

Mode	Terminal	Component	RGB (DTV)	HDMI (DTV)
480i		o	x	x
576i		o	x	x
480p		o	o	o
576p		o	o	o
720p		o	o	o
1080i		o	o	o



- HDMI™, the HDMI logo and High-Definition Multimedia Interface are trademarks or registered trademarks of HDMI Licensing LLC.
- This set can receive the High-Definition Multimedia Interface (HDMI) or Input of Digital Visual Interface(DVI).
- This set supports HDCP (High-bandwidth Digital Contents Protection) Protocol for the set (480p, 720p, 1080i) modes.
- When you Connect with HDMI/DVI Source Devices (DVD Player or Set Top Box or PC) supporting Auto HDMI/DVI function, automatically, support Plug & Play and then set the HDMI/DVI Source Devices (1280 x 720p) (or 42PM3MVA/C/J series: 640 x 480p). After reading in HDMI/DVI Source Devices using Display Data Channel(DDC) Protocol, EDID stored in the set is used. If HDMI/DVI Source Devices not supported Auto HDMI/DVI is been, the Resolution is set, manually.
- To get the best picture quality, adjust the DVD Player or Set Top Box output resolution to 1280 x 720p (or 42PM3MVA/C/J series: 640 x 480p).
- To get the best picture quality, adjust the PC graphics card to 1024 x 768 (or 42PM3MVA/C/J series: 640 x 480), 60Hz.
- When Source Devices have DVI Output Connector, you must connect audio with separated cable.
(Refer to <How to connect>)

How to connect

1. When Source Devices (DVD Player or Set Top Box) support HDMI.
 - If Source Devices have HDMI Output Connector, Source Devices connect to the set with HDMI Cable .(not supplied with the product).
 - If Source Devices support Auto HDMI, automatically, Source Devices divert output resolution in 1280 x 720p (or 42PM3MVA/C/J series: 640 x 480p). But if not, resolution divert Manually Setting for reference Manual of Source Devices.
 - To get the best picture quality, adjust the DVD Player or Set Top Box output resolution to 1280 x 720p (or 42PM3MVA/C/J series: 640 x 480p).
 - Because HDMI sends Digital Video and Audio with one cable, need not especial Audio Cable for using HDMI Cable.
2. When Source Devices (DVD Player or Set Top Box) supports DVI.
 - If Source Devices have DVI Output Connector, Source Devices connect to the set with HDMI to DVI Cable (not supplied with the product).
 - If Source Devices support Auto DVI, automatically, Source Devices divert output resolution in 1280 x 720p (or 42PM3MVA/C/J series: 640 x 480p). But if not, resolution divert Manually Setting for reference Manual of Source Devices.
 - To get the best picture quality, adjust the DVD Player or Set Top Box output resolution to 1280 x 720p (or 42PM3MVA/C/J series: 640 x 480p).
 - In this case, Audio use other cable. When Source Devices have Analog Audio Output Connector, RGB/DVI Audio Input of the set connect to Audio Cable (not supplied with the product). And then you can listen to normal Audio.
3. When PC supports DVI.
 - If PC have DVI Output Connector, Source Devices connect to the set with HDMI to DVI Cable (not supplied with the product).
 - To get the best picture quality, adjust the PC graphics card to 1024 x 768 (or 42PM3MVA/C/J series: 640 x 480), 60Hz.
 - Use the the set's HDMI/DVI (VIDEO) for video connections, depending on your PC connector.
 - If the graphics card on the PC does not output analog RGB and DVI simultaneously, connect only one of either RGB Input or HDMI/DVI Input to display the PC on the set.
 - If the graphics card on the PC does output analog RGB and DVI simultaneously, the set to either RGB Input or HDMI/DVI

Input; (the other mode is set to Plug and Play automatically by the set.)

- Then, make the corresponding audio connections. If using a sound card, adjust the PC sound as required.
- In this case, Audio use other cable. When PC (or sound card of PC) have Analog Audio Output Connector, RGB/DVI Audio Input of the set connect to Analog Audio Cable (not supplied with the product). And then you can listen to normal Audio.

Reference

Cable sample (not supplied with the product)

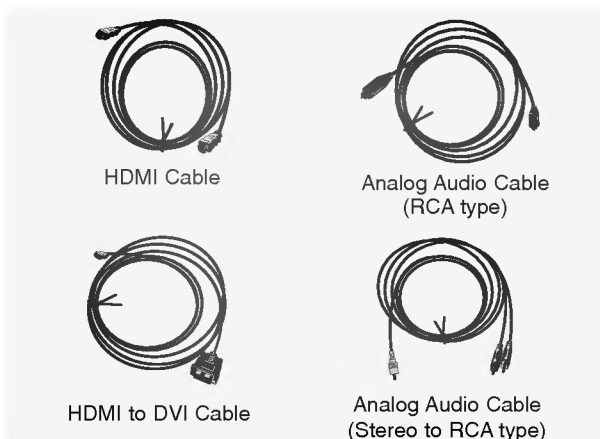

How to use

1. Connect the HDMI/DVI Source Devices(DVD Player or Set Top Box or PC) and the set.
2. Turn on the display by pressing the POWER button on the set and HDMI/DVI Source Devices remote control.
3. Select HDMI/DVI Input source in Main Input option of SPE-CIAL menu.
4. Check the image on your set. There may be noise associated with the resolution, vertical pattern, contrast or brightness in HDMI/DVI Source Devices. If noise is present, change the HDMI/DVI Source Devices to another resolution, change the refresh rate or adjust the brightness and contrast on the menu until the picture is clear. If the refresh rate of the PC graphics card can not changed, change the PC graphics card or consult the manufacturer of the PC graphics card.

Notes:

- Depending on the graphics card, DOS mode may not work if you use a HDMI to DVI Cable.
- Avoid keeping a fixed image on the set screen for a long period of time. The fixed image may become permanently imprinted on the screen. Use the Orbiter screen saver when possible.
- When Source Devices connected HDMI/DVI Input, output PC Resolution(VGA, SVGA, XGA), Position, Size may not fit to Screen. As shown the lower picture, press the **MENU** button to adjust the screen Position of the set and contact an PC graphics card service center.
- When Source Devices connected HDMI/DVI Input output the set Resolution(480p, 720p, 1080i), the set Display fit EIA/CEA-861-B Specification to Screen. If not, refer to the Manual of HDMI/DVI Source Devices or contact your service center.
- In case HDMI/DVI Source Devices is not connected Cable or poor cable connection, "No Signal" OSD display in HDMI/DVI Input. And In case of Video Resolution not supported the set output in HDMI/DVI Source Devices, "No Signal" OSD display. Refer to the Manual of HDMI/DVI Source Devices or contact your service center.

Accessories

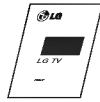

Owner's Manual



Remote Control handset



Power Cord

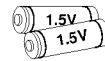

Alkaline batteries

Optional Extras

- Optional extras can be changed or modified for quality improvement without any notification new optional extras can be added.
- Contact your dealer for buying these items.

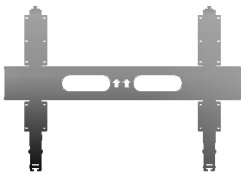

Tilt wall mounting bracket

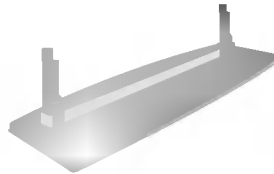

Desktop stand

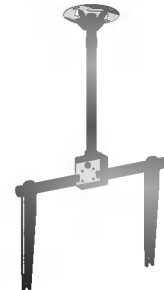

Ceiling mounting bracket

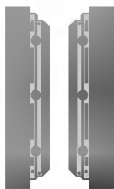

Speakers



Video cables



Audio cables

Installation Options

- The set can be installed in different ways such as on a wall, or on a desktop etc.
- Install this set only in a location where adequate ventilation is available.
- This set is designed so that it can be mounted either horizontally or vertically.

Wall Mount: Horizontal Installation

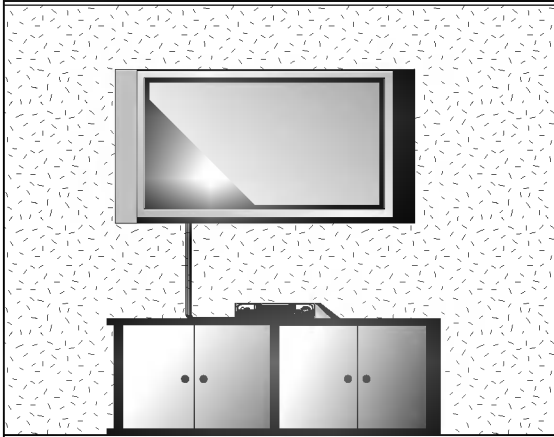

- The set can be installed on a wall as shown above. (For further information, refer to the optional 'Wall Mounting Bracket Installation and Setup Guide'.)
- Speakers are optional, and are shown for illustration only.

Wall Mount: Vertical Installation

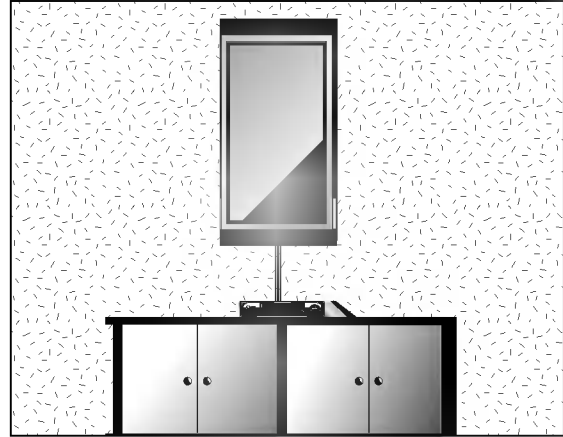

- The set can be installed vertically on the wall as shown above. (For further information, refer to the optional 'Wall Mounting Bracket Installation and Setup Guide'.)
 Caution: When installing the set vertically, the front panel controls must be in the left-down side position as shown above.
- Speakers are optional, and are shown for illustration only.
- **Note:** To use the set in a vertical orientation, the source's image must also be in a vertical format.

Desktop Pedestal Installation

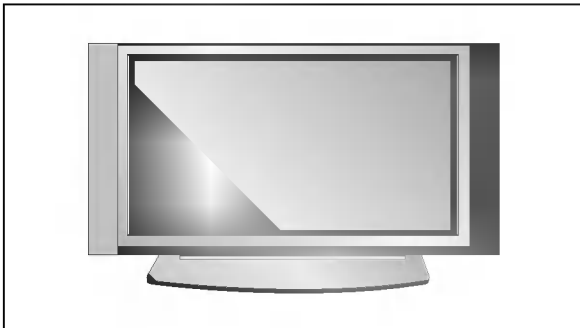

- The set can be mounted on a desk as shown above. (For further information, refer to the optional 'Desktop Stand Installation and Setup Guide'.)
- Speakers and speaker stands shown are optional, and are shown for example only.

To Mount on a Wall

Wall mount minimum allowable clearances for adequate ventilation.

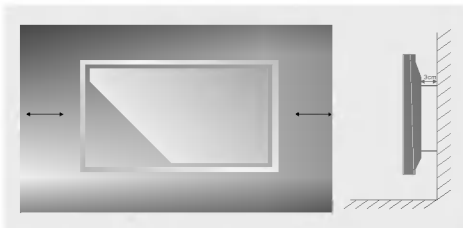

To Install on a Desktop

Pedestal mount minimum allowable clearances for adequate ventilation.

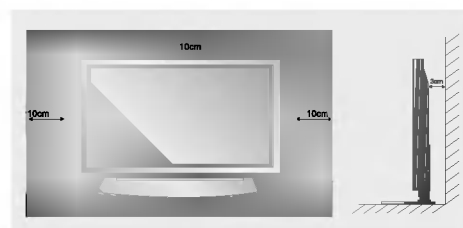

Turning on the Set

- When using the remote control, aim it at its sensor on the set.

42PM1MA/J series / 50PM1MA/J series



1. Connect power cord correctly.
2. Press the **⏻ ON/OFF** button on the set. At this moment, the set is switched to standby mode. Press the **INPUT SELECT** button on the set or press the **POWER, INPUT, MULTIMEDIA, ▲ / ▼** or **NUMBER** button on the remote control and then the set will switch on.



1. If the set was turned off with the **⏻ ON/OFF** button on the set
 - Press the **⏻ ON/OFF** button on the set to turn the set on.
2. If the set was turned off with the remote control and the **⏻ ON/OFF** button on the set
 - Press the **⏻ ON/OFF** button on the set and then press the **INPUT SELECT** button on the set or press the **POWER, INPUT, MULTIMEDIA, ▲ / ▼** or **NUMBER** button on the remote control to turn the set on.

42PM3MVA/C/J series



1. Connect power cord correctly, the set is switched to standby mode.
2. Press the **⏻ / I, INPUT SELECT** or **▲ / ▼** button on the set or press the **POWER, INPUT, MULTIMEDIA, ▲ / ▼** or **NUMBER** button on the remote control and then the set will switch on.



- If the set was turned off with the remote control power button and the **⏻ / I** button on the set
- Press the **⏻ / I, INPUT SELECT** or **▲ / ▼** button on the set or press the **POWER, INPUT, MULTIMEDIA, ▲ / ▼** or **NUMBER** button on the remote control to turn the set on.

On-Screen Menu Language Selection (option)

- The menus can be shown on the screen in the selected language. First select your language.
 1. Press the **MENU** button and then use **▲ / ▼** button to select the **SPECIAL** menu.
 2. Press the **▶** button and then use **▲ / ▼** button to select **Language**.
 3. Press the **▶** button and then use **▲ / ▼** button to select your desired language.
From this point on, the on-screen menus will be shown in the language of your choice.
 4. Repeatedly press the **MENU** button to return to normal viewing.

On screen menus

- The dialogue between you and your set takes place on screen with an operator menu. The buttons required for the operating steps are also displayed.

Menu selection

1. Press the **MENU** button and then **▲ / ▼** button to display each menu.
2. Press the **▶** button and then the **◀ / ▶** button to select a menu item.
3. Repeatedly press the **MENU** button to return to normal TV viewing.

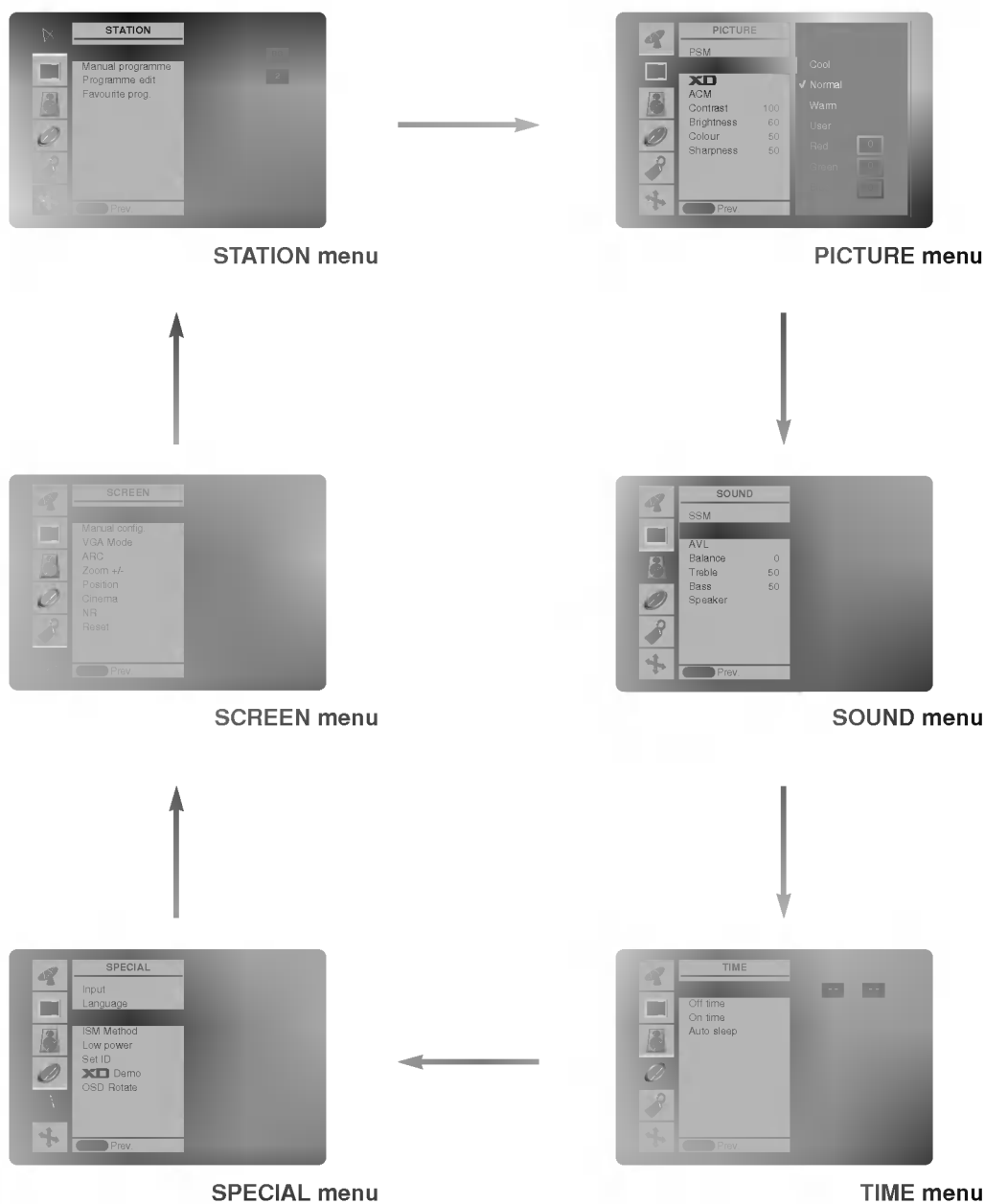

Channel Menu Options

Auto Programme Tuning

- All stations that can be received are stored by this method. It is recommended that you use auto programme during installation of this set.

1. Press the **MENU** button and then use **▲ / ▼** button to select the **STATION** menu.

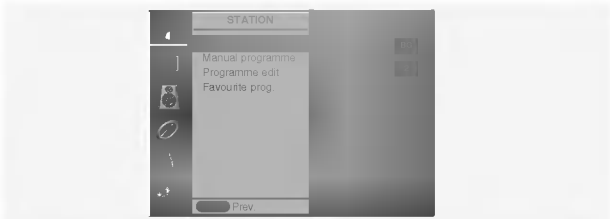

2. Press the **▶** button and then **▲ / ▼** button to select **Auto programme**.
3. Press the **▶** button to select **System**. Select a TV system with the **◀ / ▶** button;
 - L** : SECAM L/L' (option)
 - BG** : PAL B/G, SECAM B/G (Europe / East Europe / Asia / New Zealand / M.East / Africa / Australia)
 - I** : PAL I/II (U.K. / Ireland / Hong Kong / South Africa)
 - DK** : PAL D/K, SECAM D/K (East Europe / China / Africa / CIS)
 - M** : (USA / Korea / Philippines) (option)
4. Press the **▼** button to select **Storage from**. Select the beginning programme number with the **◀ / ▶** button or **NUMBER** buttons on the **Storage from** menu.
5. Press the **▼** button to select **Start**.
6. Press the **▶** button to begin auto programming. All receivable stations are stored.

Note : In some models, the station name is stored for stations which broadcast *VPS (Video Programme Service)*, *PDC (Programme Delivery Control)* or *TELETEXT* data. If no station name can be assigned to a station, the channel number is assigned and stored as **C (V/UHF 01-69)** or **S (Cable 01-47)**, followed by a number.

To stop auto programming, press the **MENU** button. When auto programming is completed, the **Programme edit** menu appears on the screen. See the 'Programme edit' section to edit the stored programme.

Manual Programme Tuning

- Manual programme lets you manually tune and arrange the stations in whatever order you desire. Also you can assign a station name with five characters to each programme number.

1. Press the **MENU** button and then use **▲ / ▼** button to select the **STATION** menu.
2. Press the **▶** button and then **▲ / ▼** button to select **Manual programme**.

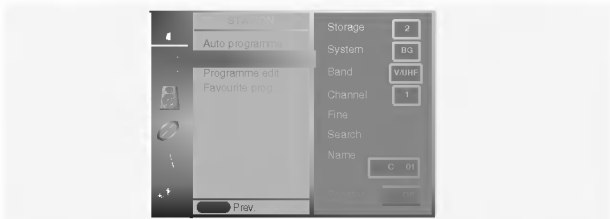

3. Press the **▶** button to select **Storage**. Select the desired programme number with the **◀ / ▶** button or **NUMBER** buttons on the **Storage** menu.
4. Press the **▼** button to select **System**. Select a TV system with the **◀ / ▶** button;
 - L** : SECAM L/L' (option)
 - BG** : PAL B/G, SECAM B/G (Europe / East Europe / Asia / New Zealand / M.East / Africa /Australia)
 - I** : PAL I/II (U.K. / Ireland / Hong Kong / South Africa)
 - DK** : PAL D/K, SECAM D/K (East Europe / China / Africa / CIS)
 - M** : (USA / Korea / Philippines) (option)
5. Press the **▼** button to select **Band**. Press the **◀ / ▶** button to select **V/UHF** or **Cable** as required.
6. Press the **▼** button to select **Channel**. You can select the desired channel number with the **◀ / ▶** button or **NUMBER** buttons. If possible, select the channel number directly with the number buttons.
7. Press the **▼** button to select **Search**. Press the **◀ / ▶** button to commence searching. If a station is found the search will stop.
8. Press the **OK** button to store it.
9. To store another station, repeat steps 3 to 8.

Fine Tuning

- Normally fine tuning is only necessary if reception is poor.

1. Repeat the 'Manual programme tuning' steps 1 to 2.
2. Press the **▶** button and then **▲ / ▼** button to select **Fine**.
3. Press the **◀ / ▶** button to fine tune for the best picture and sound.

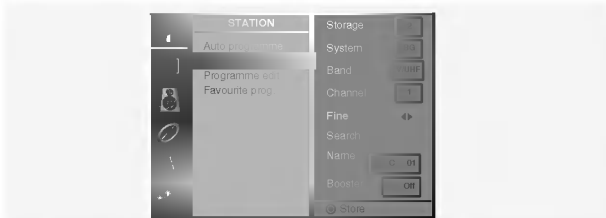

4. Press the **OK** button. The finely tuned programme will be indicated by a yellow number during programme selection.
5. Repeatedly press the **MENU** button to return to normal TV viewing.

Channel Menu Options

Assigning a Station Name

1. Repeat the 'Manual programme tuning' steps 1 to 2.
2. Press the ► button and then ▲ / ▼ button to select **Name**.
3. Press the ► button to display the **Name** menu.

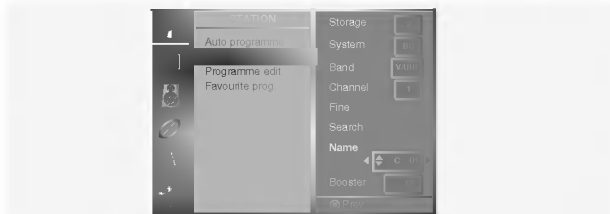

4. Press the ▲ button. You can use a blank, +, -, the alphabet **Z** to **Z** and the numeric **0** to **9**.
With the ▼ button you can select in the opposite direction.
5. Select the next position by pressing the ► button and then make your choice of the second character, and so on.
6. Press the **OK** button in twice.
7. Repeatedly press the **MENU** button to return to normal TV viewing.

Booster (option)

In some models, **Booster** is an optional function. Only a set with **Booster** can perform this function.

If the reception is poor at the fringe area of TV signal, select **Booster** to **On**.

1. Repeat the 'Manual programme tuning' steps 1 to 2.
2. Press the ► button and then ▲ / ▼ button to select **Booster**.
3. Press the ◀ / ▶ button to select **On** or **Off**.
4. Press the **OK** button.
5. Repeatedly press the **MENU** button to return to normal TV viewing.

Programme Edit

- This function enables you to delete or skip the stored programmes. Also you can move some stations to other programme numbers or copy a blank station data into the selected programme number.

1. Press the **MENU** button and then use ▲ / ▼ button to select the **STATION** menu.
2. Press the ► button and then ▲ / ▼ button to select **Programme edit**.
3. Press the ► button to display the **Programme edit** menu.

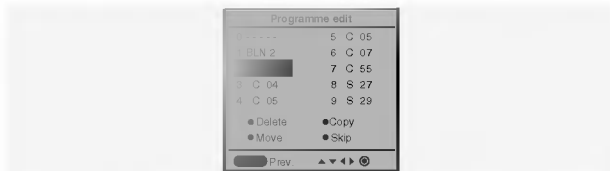

Deleting a programme

1. Select a programme to be deleted with the ▲ / ▼ or ◀ / ▶ button.
2. Press the **RED** button twice.
The selected programme is deleted, all the following programmes are shifted up one position.

Copying a programme

1. Select a programme to be copied with the ▲ / ▼ or ◀ / ▶ button.
2. Press the **GREEN** button.
All the following programmes are shifted down one position.

Moving a programme

1. Select a programme to be moved with the ▲ / ▼ or ◀ / ▶ button.
2. Press the **YELLOW** button.
3. Move the programme to the desired programme number with the ▲ / ▼ or ◀ / ▶ button.
4. Press the **YELLOW** button again to release this function.

Skipping a programme number

1. Select a programme number to be skipped with the ▲ / ▼ or ◀ / ▶ button.
2. Press the **BLUE** button. The skipped programme turns to blue.
3. Press the **BLUE** button again to release the skipped programme.
When a programme number is skipped it means that you will be unable to select it using the ▲ / ▼ button during normal TV viewing. If you want to select the skipped programme, directly enter the programme number with the **NUMBER** buttons or select it in the programme edit or table menu.

Favourite Programme

- This function lets you select your favourite programmes directly.

1. Press the **MENU** button and then use ▲ / ▼ button to select the **STATION** menu.
2. Press the ► button and then ▲ / ▼ button to select **Favourite programme**.
3. Press the ► button to display the **Favourite programme** menu.
4. Press the ► button and then ▲ / ▼ button to select **On**.
5. Press the ▲ / ▼ button to select -- ----.
6. Select a desired programme with the ◀ / ▶ button or **NUMBER** buttons. Any number under 10 is entered with a numeric '0' (or '00') in front of it, i.e. '05' (or '005') for 5.
7. To store another programme, repeat steps 5 to 6.
You can store up to 8 programmes.
8. Press the **OK** button.
9. Repeatedly press the **MENU** button to return to normal TV viewing.

Repeatedly press the **Q.VIEW/*** button to select stored favorite programmes.

Calling up the Programme Table

- You can check the programmes stored in the memory by displaying the programme table.

Displaying programme table

Press the **LIST/*** button to display the Programme table menu. The programme table appears on the screen.

- You may find some blue highlighted programmes shown. They have been set up in the programme edit mode.
- Some programmes with the channel number shown in the programme table indicate there is no station name assigned.

Selecting a programme in the programme table

Select a programme with the ▲ / ▼ or ◀ / ▶ button.

Then press the **OK** button.

The Plasma Display switches to the chosen programme number.

Paging through a programme table

There are 10 programme table pages in which contain 100 programmes.

Pressing the ▲ / ▼ or ◀ / ▶ button repeatedly turns the pages.

Press the **LIST/*** button to return to normal TV viewing.

Picture Menu Options

PSM (Picture Status Memory)

- This function adjusts the set to the best picture appearance.
- When adjusting picture options (contrast, brightness, colour, sharpness and tint (NTSC AV only)) manually, PSM is automatically changed to **User**.

1. Press the **PSM** button.
- Each press of the **PSM** button changes the screen display as shown below.

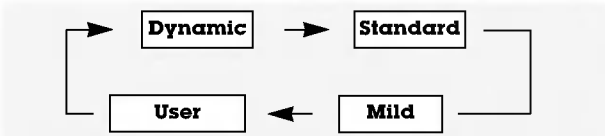

- You can also select **Dynamic, Standard, Mild** or **User** in the PICTURE menu.
- Picture options **Dynamic, Standard** and **Mild** are preset and programmed for good picture quality at the factory and cannot be changed.

CSM (Colour Status Memory)

- To initialize values (reset to default settings), select the **Normal** option.



Manual Colour Temperature Control

- You can adjust red, green, or blue to any colour temperature you prefer.

XD

- You can enjoy the vivid and hi-definition picture with LG's Excellent Digital Reality processor technology.
- It's not available to use this function in RGB[PC], HDMI[PC] mode.
- When selecting picture options (**Dynamic, Standard** and **Mild**) in PICTURE menu, **XD** is automatically changed to **On**.

sRGB

- When the set was connected to external equipment with sRGB function, It's adjusted a colour difference to display the equal image each other.
- This function works in the following mode:RGB[PC], HDMI[PC].

ACM (Active Colour Management)

- Adjust the **ACM** to select the desired skin colour option.
- This function is not available for use in RGB[PC], HDMI[PC] mode.
- It's not available to use this function in **XD Off** mode.

Manual Picture Control

- You can adjust picture contrast, brightness, colour, sharpness and tint (NTSC AV only) to the levels you prefer.
- It's not available to use colour, sharpness function in RGB[PC], HDMI[PC] mode.
- In the broadcasting system PAL/SECAM, the picture item Tint doesn't work.

Sound Menu Options

SSM (Sound Status Memory)

- This function lets you enjoy the best sound without any special adjustment because the set automatically selects the appropriate sound option based on the program content.
- When adjusting sound options (treble and bass) manually, SSM is automatically changed to **User**.

1. Press the **SSM** button.
2. Press the **SSM** button to select your desired sound.

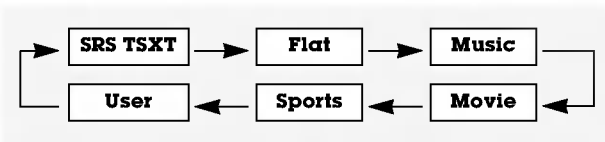

- **SRS** is a trademark of SRS Labs, Inc.
- TruSurround XT technology is incorporated under license from SRS Labs, Inc.

BBE

- BBE High Definition Sound restores clarity and presence for better speech intelligibility and musical realism.

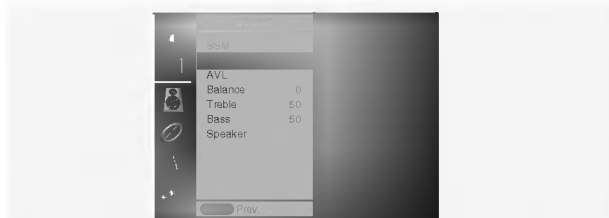

BBE. Manufactured under license from BBE Sound, Inc.

AVL (Auto Volume Leveler)

- This feature maintains an equal volume level; even if you change channels.

Adjusting Sound Control

Note : Treble, Bass or BBE aren't suitable to use **SRS TSXT**.

Sound Menu Options

TV Speaker

- You can adjust internal speaker status.
- In COMPONENT, RGB[PC] and HDMI[PC] mode, TV speaker/variable audio can be output even though there is no video signal.
- If you want to use your external hi-fi stereo system, turn off the internal speakers of the set.

Stereo / Dual Reception

- When a programme is selected, the sound information for the station appears after the programme number and station name disappear.

On Screen Display

Press the **I/II** button to received broadcast state.

Broadcast	On screen Display
Mono	MONO
Stereo	STEREO
Dual	DUAL I

Mono Sound Selection

In stereo reception if the stereo signal is weak, you can switch to mono by pressing the **I/II** button twice. In mono reception the depth of sound is improved. To switch back to stereo, press the **I/II** button twice again.

Language Selection for Dual Language Broadcast

If a programme received in two languages (dual language), you can switch to **DUAL I**, **DUAL II** or **DUAL I + II** by pressing the **I/II** button repeatedly.

- **DUAL I** sends the primary broadcast language to the loudspeakers.
- **DUAL II** sends the secondary broadcast language to the loudspeakers.

- **DUAL I + II** sends a separate language to each loudspeaker.

NICAM Reception (option)

- If your Plasma Display is equipped with the PDP Tuner for NICAM reception, the high quality NICAM (Near Instantaneous Companding Audio Multiplex) digital sound can be received.

Sound output can be selected according to the type of received broadcast as follows by pressing the **I/II** button repeatedly.

- When NICAM mono is received, you can select **NICAM MONO** or FM MONO.
- When NICAM stereo is received, you can select **NICAM STEREO** or FM MONO. If the stereo signal is weak, switch to FM mono.
- When NICAM dual is received, you can select **NICAM DUAL I**, **NICAM DUAL II**, **NICAM DUAL I + II**, or **MONO**. When FM mono is selected the display **MONO** appears on the screen.

Sound output selection

In AV, Component, RGB or HDMI mode, you can select output sound for the left and right loudspeakers.

Repeatedly press the **I/II** button to select the sound output.

- **L+R** : Audio signal from audio L input is sent to left loud-speaker and audio signal from audio R input is sent to right loud-speaker.
- **L+L** : Audio signal from audio L input is sent to left and right loud-speakers.
- **R+R** : Audio signal from audio R input is sent to left and right loud-speakers.

Time Menu Options

Setting the Clock

- If current time setting is erased by a power failure or the set is unplugged, reset the clock.

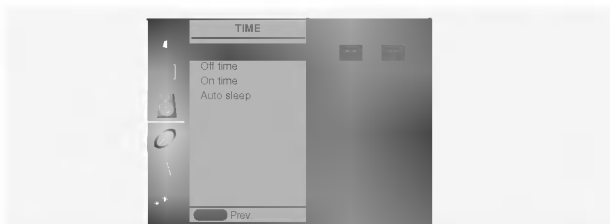

Setting the On/Off Timer

- Timer function operates only if current time has been already set.
- Off Timer function overrides on Timer function if they are set to the same time.
- The set must be in standby mode for the On Timer to work.
- Two hours after the set is switched on by the on time function it will automatically switch back to standby mode unless a button has been pressed.

Auto Sleep

- If there is no input signal, the monitor turn off automatically after 10 minutes.

Sleep Timer

- Sleep timer turns the set off at the preset time.
- Press the **SLEEP** button to select the number of minutes. The display **L^{zz} --- Min** will appear on the screen, followed by **10, 20, 30, 60, 90, 120, 180** and **240** minutes. The timer begins to count down from the number of minutes selected.

- To check the remaining sleep time, press the **SLEEP** button once.
- To cancel the sleep time, repeatedly press the **SLEEP** button until the display **L^{zz} --- Min** appears.
- If you turn the set off after setting the sleep timer, the setting will be erased.

Special Menu Options

Child Lock

- The set can be set up so that it can only be used with the remote control.
- This set programmed to remember which option it was last set to even if you turn the set off.
- In **Child lock 'On'**, if the set is turned off, press the **INPUT SELECT**, **▲ / ▼** button on the set or **POWER, INPUT** or **MULTIMEDIA**, **▲ / ▼** or **NUMBER** buttons on the remote control.
- With the **Child lock On**, the display '  **Child lock on**' appears on the screen if any button on the front panel is pressed while viewing the set.

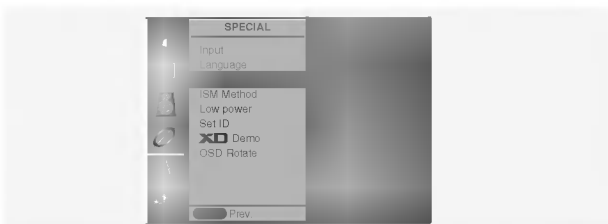

ISM (Image Sticking Minimization) Method

- Frozen still picture from a PC/video game displayed on the screen for prolonged periods will result in an ghost image remaining even when you change the image. Avoid allowing a fixed image to remain on the set's screen for a long period of time.

• White Wash :

White Wash removes permanent images from the screen.

Note: An excessive permanent image may be impossible to clear entirely with White Wash.

• Orbiter :

Orbiter may help prevent ghost images. However, it is best not to allow any fixed image to remain on the screen. To avoid a permanent image on the screen, the screen will move every 2 minutes.

• Inversion :

This is the function to invert the panel colour of the screen. The panel colour is automatically inverted every 30 minutes.

Low Power

- This is the function to reduce the power consumption of the set.

XD Demo

- Use it to see the difference between XD demo on and XD Demo off.
- It's not available to use this function in RGB[PC], HDMI[PC] mode.

Screen Menu Options

Auto Configure

- Automatically adjusts picture position and minimizes image shaking.
- This function works in the following mode : RGB[PC].
 - When **Auto config.** has finished, **Ok** will be shown on screen.
 - If the position of the image is still not correct, try Auto adjustment again.
- If picture needs to be adjusted more after Auto adjustment in RGB (PC), you can adjust the **Manual Config.**
- Although the image is still not correct, your set is functioning properly but needs further adjustment.
- The **Auto config.** functions don't need to be run for HDMI mode.

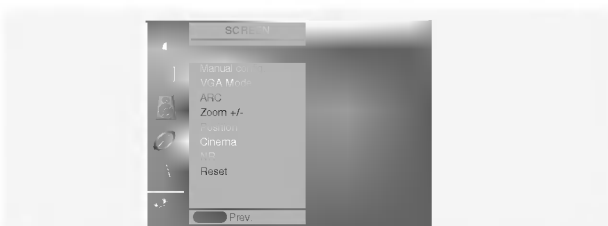

Manual Configure

- If the picture isn't clear after auto adjustment and especially that characters are still trembling, adjust the picture phase manually.
- To correct the screen size, adjust **Clock**.
- This function works in the following mode : RGB[PC], RGB[DTV], COMPONENT (480p/576p/720p/1080i), HDMI (480p/576p/720p/1080i).
- It's not available to use Phase, Clock function in RGB[DTV], COMPONENT (480p/576p/720p/1080i), HDMI (480p/576p/720p/1080i) mode.

Selecting Wide VGA/XGA mode

- To see a normal picture, match the resolution of RGB mode and selection of VGA/XGA mode.
- In some models, it's not available to selection of XGA mode.
- This function works in the following mode : RGB[PC].

Screen Menu Options

Setting Picture Format

- You can watch the screen in various picture formats; **Spectacle**, **Full** (option), **Original**, **4:3**, **16:9** (Wide), **14:9** and **Zoom**.

- **Spectacle**

When your TV receives the wide screen signal, following selection will lead you to adjust the picture horizontally, in non-linear proportion, to fill the entire screen.

- **Full** (option)

When your TV receives the wide screen signal, following selection will lead you to adjust the picture horizontally or vertically, in a linear proportion, to fill the entire screen fully.

- **Original**

When your TV receives the wide screen signal, it will be automatically changed to the picture format to be sent.

- **4:3**

Following selection will lead you to view a picture with an original 4:3 aspect ratio, with gray bars appearing at both the left and right sides.

- **16:9** (Wide)

Following selection will lead you to adjust the picture horizontally, in a linear proportion, to fill the entire screen (useful for viewing 4:3 formatted DVDs).

- **14:9**

You can enjoy the picture format of 14:9 or general TV programme through the 14:9 mode. The screen 14:9 is viewed just like that the screen 4:3 is magnified to the left / right.

- **Zoom**

Following selection will lead you to view the picture without any alternation, while filling the entire screen. However, the top and bottom portions of the picture will be cropped.

- You can only select **4:3** and **16:9** (Wide) in RGB[PC], HDMI[PC] mode only.

- You can only select **4:3**, **16:9** (Wide) and **Zoom** in RGB[DTV], HDMI[DTV], Component [DTV] mode only.
- You can only select **Spectacle**, **Full** (option), **4:3**, **16:9** (Wide), **14:9** and **Zoom** in Component [480i/576i] mode only.
- There might be uncomfortable in full mode. Then change into other mode.

Picture Size Zoom

- When enlarging or reducing the picture, the screen may be display unnatural picture.

Screen Position

- You are available to this function after adjusting Zoom In/Out.

Cinema

- When you watch the movie, this function adjusts the set to the best picture appearance.
- This function works in the following mode: AV, S-VIDEO, COMPONENT 480i/576i.

NR (Noise Reduction)

- You can select **3D NR** or **MPEG NR** to reduce the picture noise which may appear on the screen during watching the TV.
- This function is not available for use in RGB[PC], HDMI[PC] mode.
- 3D NR is not available for use in RGB, HDMI, Component[DTV] mode.

Initializing (Reset to original factory value)

This function operates in current mode.
To initialize the adjusted value.

- You can initialize Phase, Clock, H-Position, V-Position, Position, Zoom +/-, PIP size, PIP position, PIP Transparency and sub picture size of twin picture.

Teletext (option)

- Teletext (or TOP text) is an optional function, therefore only the set with the teletext system can receive the teletext broadcast.
- Teletext is a free service broadcast by most TV stations which gives up-to-the-minute information on news, weather, television programmes, share prices and many other topics.
- The teletext decoder of this set can support the SIMPLE, TOP and FASTEXT systems. SIMPLE (standard teletext) consists of a number of pages which are selected by directly entering the corresponding page number. TOP and FASTEXT are more modern methods allowing quick and easy selection of teletext information.

Teletext Language Selection (option)

1. Press the **MENU** button and then use **▲** / **▼** button to select the **SPECIAL** menu.
2. Press the **▶** button and then use **▲** / **▼** button to select **Language**.
3. Press the **▶** button and then use **◀** / **▶** button to select **Teletext Language**.
4. Press the **▲** / **▼** button to select the required language.

5. Repeatedly press the **MENU** button to return to normal TV viewing.

Note :

- a. Please select your local teletext language.
- b. If you don't, the teletext may not appear correctly on the screen.

Switch on/off

Press the **TEXT/★** button to switch to teletext.

- The initial page or last page appears on the screen. Two page numbers, TV station name, date and time are displayed on the screen headline. The first page number indicates your selection, while the second shows the current page displayed.

Press the **TEXT/★** button to switch off teletext.

Teletext (option)

SIMPLE Text (option)

Page selection

1. Enter the desired page number as a three digit number with the NUMBER buttons. If during selection you press a wrong number, you must complete the three digit number and then reenter the correct page number.
2. The ▲ / ▼ button can also be used to select the preceding or following page.

Programming a colour button in LIST mode (option)

If the TV is in SIMPLE text, TOP text or FASTEXT mode, press the  button to switch to LIST mode.

Four teletext page numbers of your choice can be colour coded and easily selected by pressing the corresponding coloured button on the remote control handset.

1. Press a coloured button.
2. Using the NUMBER buttons, select the page you wish to programme.
3. Press the OK button. The selected page is stored as the selected page number, blinking once to confirm this. From now on, you can select this page with the same coloured button.
4. The three other coloured buttons are programmed in this way.

TOP Text (option)

The user guide displays four fields-red, green, yellow and blue at the bottom of the screen. The yellow field denotes the next group and the blue field indicates the next block.

Block / group / page selection

1. With the blue button you can progress from block to block.
2. Use the yellow button to proceed to the next group with automatic overflow to the next block.
3. With the green button you can proceed to the next existing page with automatic overflow to the next group. (Alternatively the ▲ button can be used.)
4. The red button permits to return to previous selection. (Alternatively the ▼ button can be used.)

Direct page selection

Corresponding to the SIMPLE text mode, you can select a page by entering it as a three digit number using the NUMBER buttons in TOP mode.

FASTEXT

The teletext pages are colour coded along the bottom of the screen and are selected by pressing the corresponding coloured button.

Page selection

1. Press the  button to select the index page.
2. You can select the pages which are colour coded along the bottom line with the same coloured buttons.
3. Corresponding to the SIMPLE text mode, you can select a page by entering its three digit page number with the NUMBER buttons in FASTEXT mode.
4. The ▲ / ▼ button can also be used to select the preceding or following page.

Special Teletext Functions



REVEAL

Press this button to display concealed information, such as solutions of riddles or puzzles.

Press this button again to remove the information from the display.



SIZE

Selects double height text.

Press this button to enlarge the top half of the page.

Press this button again to enlarge the bottom half of the page.

Press this button again to return to the normal display.



UPDATE

Displays the TV picture on the screen while waiting for the new teletext page.

Press this button to view the updated teletext page.



HOLD

Stops the automatic page change which will occur if a teletext page consists of 2 or more sub pages. The number of sub pages and the sub page displayed is, usually, shown on the screen below the time. When this button is pressed the stop symbol is displayed at the top left-hand corner of the screen and the automatic page change is inhibited.

To continue press this button again.



MIX

Displays the teletext pages superimposed on the TV picture.

To switch the TV picture off press this button again.



TIME

This button has two functions:

a) When viewing a TV programme, press this button to display the time at the top right hand corner of the screen. Press this button again to remove the display.

b) In teletext mode, press this button to select a sub page number. The sub page number is displayed at the bottom of the screen. To hold or change the sub page, press the RED/ GREEN or ▲ / ▼ buttons. Press this button again to exit this function.

Notes

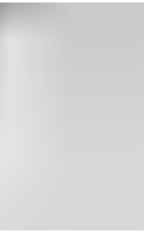

Troubleshooting Checklist

No picture & No sound	<ul style="list-style-type: none">• Check whether the set is turned on.• Power cord inserted into wall outlet?• Plug another product's power cord into the wall outlet where the set's power cord was plugged in.
Picture OK & No sound	<ul style="list-style-type: none">• Press the VOLUME (▶) button.• Sound muted? Press MUTE button. <p>Check whether the Speaker is "on" in the SOUND menu. (Refer to p.18)</p>
The remote control doesn't work	<ul style="list-style-type: none">• Check to see if there is any object between the set and the remote control causing obstruction.• Check to see if the batteries are installed with the correct polarities. (Refer to p.5)• Check if the remote control handset is set up to correct mode.• Install new batteries. (Refer to p.5)
Picture appears slowly, after switching on	<ul style="list-style-type: none">• This is normal as the image is muted during the startup process of the set. Please contact your service centre, if the picture has not appeared after five minutes.
No or Poor colour or Poor picture	<ul style="list-style-type: none">• Select Colour in the PICTURE menu and press the VOLUME (▶) button. (Refer to p.18)• Keep a certain distance between the set and the VCR.• Activate any function to restore the brightness of the picture. (If still picture is on the screen for more than 5 minutes, the screen gets dark.)
Horizontal/vertical bars or picture shaking	<ul style="list-style-type: none">• Check for local interference such as an electrical appliance or power tool.
No output from one of the speakers	<ul style="list-style-type: none">• Adjust Balance in the SOUND menu. (Refer to p.18)
Unusual sound from inside the set	<ul style="list-style-type: none">• A change in ambient humidity or temperature may result in an unusual noise at the time of switching off or on of the set and does not indicate a fault with the set.

Product Specifications

MODEL	42PM1MA 42PM1MA-TA 42PM1MA-ZA	42PM1MJ 42PM1MJ-TA	50PM1MA 50PM1MA-TA 50PM1MA-ZA	50PM1MJ 50PM1MJ-TA
Width (inches / mm)	42 / 1066		49.3 / 1253	
Height (inches / mm)	25.6 / 650		29.3 / 745	
Depth (inches / mm)	3.9 / 97.5		4 / 99.5	
Weight (pounds / kg)	66 / 30		90.4 / 41	
Power requirement	AC100-240V, 50/60Hz			
Operating Temperature Range	32 ~ 104°F (0 ~ 40°C)			
Operating Humidity Range	Less than 80%			

MODEL	42PM3MVA 42PM3MVA-TA 42PM3MVA-ZA	42PM3MVJ 42PM3MVJ-TA	42PM3MVC 42PM3MVC-TA 42PM3MVC-ZA
Width (inches / mm)	41.4 / 1050		48.2 / 1223
Height (inches / mm)	24.8 / 630		27.1 / 686.5
Depth (inches / mm)	3.6 / 91.5		11.7 / 295
Weight (pounds / kg)	50.1 / 23.1		66.2 / 30
Power requirement	AC100-240V, 50/60Hz		
Operating Temperature Range	32 ~ 104°F (0 ~ 40°C)		
Operating Humidity Range	Less than 80%		

- The specifications shown above may be changed without notice for quality improvement.

