

LG Electronics Inc.

LCD TV | OWNER'S MANUAL



LCD TV OWNER'S MANUAL

LCD TV MODELS

32LB1D	32LB1DB
37LB1D	37LB1DB
42LB1D	42LB1DB

Please read **Information Manual** included together before reading this manual and operating your set.

Please read this manual carefully before operating your set. Retain it for future reference. Record model number and serial number of your set. See the label attached on the back cover and quote this information to your dealer when you require service.

DVB
Digital Video
Broadcasting

Trademark of the DVB Digital Video
Broadcasting Project (1991 to 1996)

ID Numbers	4096 : 32LB1D	4298 : 32LB1DB
	4097 : 37LB1D	4299 : 37LB1DB
	4095 : 42LB1D	4297 : 42LB1DB

P/NO : 38289U1004A (0608-REV02)
Printed in Korea

LG Electronics Inc.

ACCESSORIES

ACCESSORIES

Ensure that the following accessories are included with your set. If any accessory is missing, please contact the dealer from where you purchased the set.

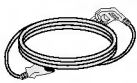

Power Cord



75Ω RF Coaxial



Owner's Manual

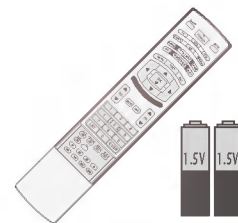

Remote Control /
Batteries



2-TV brackets
2-Wall brackets



2-bolts



Cable
Management
(Refer to p.10)



Twister Holder
Arrange the wires
with the twister holder.

CONTENTS

ACCESSORIES 1

INTRODUCTION

Controls	4
Connection Options	5
Remote Control Key Functions	6-8

INSTALLATION

Desktop Pedestal Installation	9
Stand Swivel	9
Wire Arrangement	10
Attaching the TV to a Wall	11

CONNECTIONS & SETUP

Antenna Connection	12
Insertion of CI Module	12
VCR Setup	13-15
External AV Source Setup	16
Picture Out Setup	16
Digital Audio Output	17
External Stereo	17
DVD Setup	18-20
HDSTB Setup	21-23
PC Setup	24-26

BASIC OPERATION

Turning on the set	27
Programme Selection	28
Volume Adjustment	28

SPECIAL FUNCTIONS

PIP/POP/Double Window

Watching PIP/Double Window/POP	29
Programme Selection for Sub Picture	29
Input Source Selection for Sub Picture	30
Sub Picture Size Adjustment	30
Moving the Sub Picture (PIP mode only)	30
Adjusting PIP Transparency (PIP mode only)	31
Swapping between main and sub pictures	31
POP (Picture-out-of-Picture: Programme Scan) ...	31

TELETEXT -In Digital mode

Teletext within Digital Service	32
Teletext in Digital Service	32

TELETEXT-In Analogue mode

Switch on/off	33
SIMPLE Text	33
TOP Text	34
FASTEXT	34
Special Teletext Functions	35

EPG (Electronic Programme Guide) - In Digital mode only

Switch on/off EPG	36
Select a programme	36
Button Function in NOW/NEXT Guide Mode	37
Button Function in 8 Days Guide Mode	37
Button Function in Date Change Mode	37
Button Function in Extended Description Box	38
Button Function in Record/Remind Setting Mode	38
Button Function in Timer List Mode	38

TV MENU

On Screen Menus Selection and Adjustment 39

STATION MENU OPTIONS

Auto programme-In Digital Mode 40
 Manual Programme Tuning -In Digital Mode 41
 Programme Edit -In Digital Mode 42-43
 CI [Common Interface] Information -In Digital Mode only 44
 5V Antenna Power -In Digital Mode only 45
 Booster -In Digital Mode only 46
 Diagnostics -In Digital Mode only 47
 Auto Programme Tuning -In Analogue Mode 48
 Manual Programme Tuning -In Analogue Mode 49
 Fine Tuning -In Analogue Mode 50
 Assigning a Station Name -In Analogue Mode 51
 Programme Edit -In Analogue Mode 52-53
 Favourite Programme -In Analogue Mode 54
 Calling the Programme Table 55

PICTURE MENU OPTIONS

Picture Status Memory (PSM) 56
 Picture Adjustment (PSM-User option) 57
 Colour Status Memory (CSM) 58
 Manual Colour Temperature Control (CSM - User option) 59
 XD Function 60
 XD - User Option 60
 NR (Noise Reduction) 61
 Advanced 62-63
 Advanced-Cinema 62
 Advanced-Black Level 63
 Reset 64

SOUND MENU OPTIONS

Sound Status Memory (SSM) 65
 Sound Frequency Adjustment (SSM - User option) 66
 Auto Volume Leveler (AVL) 67
 Balance Adjustment 68
 TV Speaker 69
 Audio Language -In Digital mode only 70
 Stereo/Dual Reception -In Analogue mode only 71
 NICAM Reception -In Analogue mode only 71
 Speaker Sound Output Selection 71

TIME MENU OPTIONS

Clock Setup 72
 On/Off Time 73
 Auto Sleep 74
 Sleep Timer 75

SPECIAL MENU OPTIONS

System Lock Setting 76
 Child Lock 77
 Factory Reset 78
 Software Update -In Digital mode only 79
 Subtitle Language -In Digital mode only 80
 Index 81

SCREEN MENU OPTIONS

Auto Configure- RGB [PC] mode only 82
 Manual Configure 83
 Setting the Picture Format 84
 Selecting Wide XCA mode 85
 XD demo 86
 Initializing (Reset to original factory settings) 87

APPENDIX

External Control Device Setup 88-95
 IR Codes 96-97
 Programming the Remote Control 98
 Programming Codes 99-100
 Troubleshooting Checklist 101-102
 Maintenance 103
 Product Specifications 104

INTRODUCTION

CONTROLS

■ Here shown may be somewhat different from your TV.

Front Panel Controls

INTRODUCTION



Intelligent Eye
Adjusts picture according to the surrounding conditions.

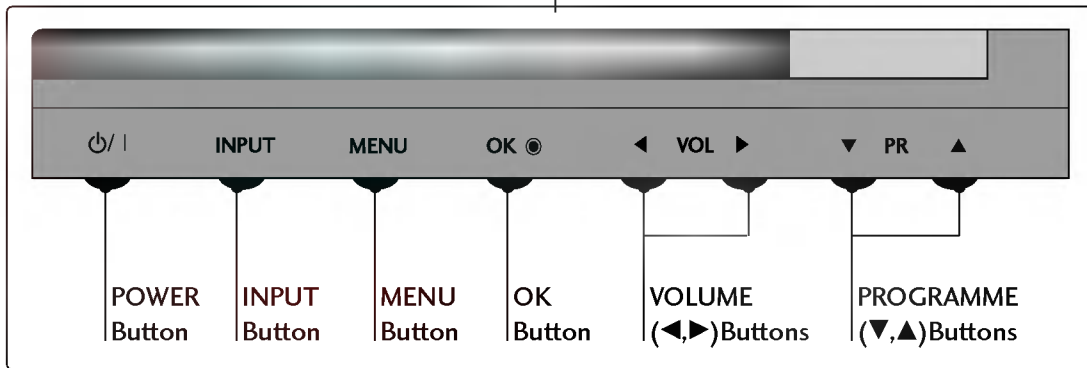

POWER Button INPUT Button MENU Button OK Button VOLUME (◀,▶)Buttons PROGRAMME (▼,▲)Buttons



Remote Control Sensor



TV



AV



DVD



RGB-PC



HDMI









Intelligent Eye



Power Standby Indicator

- illuminates red in standby mode.
- illuminates white when the set is switched on.

INDEX

<p> TV mode</p> <p> AV mode</p> <p> Component mode</p>	<p> RGB-PC mode</p> <p> HDMI1/DVI or HDMI2 mode</p> <p> Intelligent Eye</p>
---	--

4

CONNECTION OPTIONS

■ Here shown may be somewhat different from your set.

Back Connection Panel

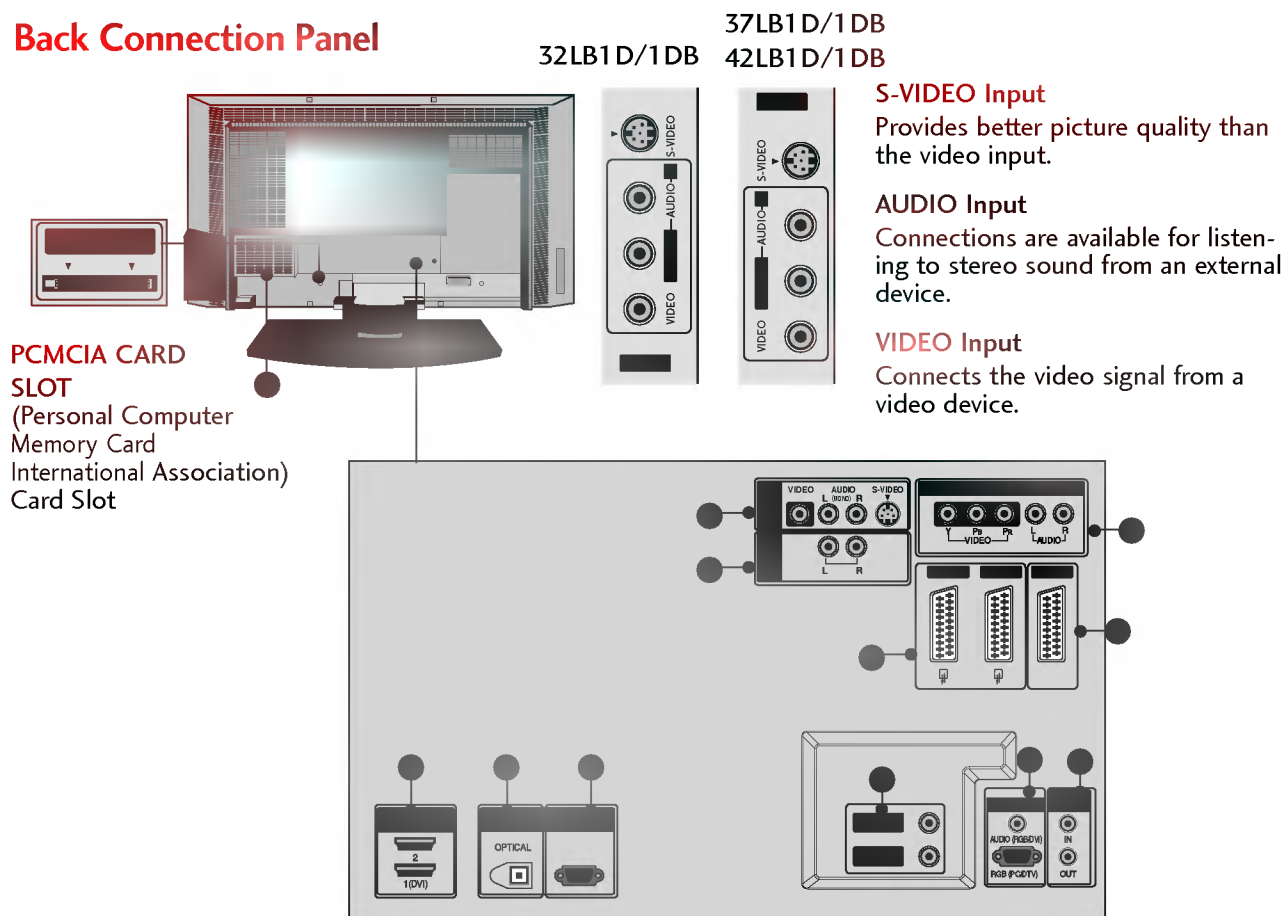

PCMCIA CARD SLOT
(Personal Computer Memory Card International Association) Card Slot

32LB1D/1DB

37LB1D/1DB

42LB1D/1DB

S-VIDEO Input

Provides better picture quality than the video input.

AUDIO Input

Connections are available for listening to stereo sound from an external device.

VIDEO Input

Connects the video signal from a video device.

- **AV (Audio/Video) IN 1-3**
Connect audio/video output from an external device to these jacks.
S-VIDEO
Connect S-Video out from an S-VIDEO device.
- **VARIABLE AUDIO**
Connect a external stereo amplifier.
- **COMPONENT IN**
Connect a component video/audio device to these jacks.
- **HDMI IN**
Connect a HDMI signal to 1 (DVI) or 2.
Or DVI(VIDEO)signal to the 1 (DVI) port with a HDMI to DVI cable.
- **DIGITAL AUDIO OUT**
Connect digital audio from various types of equipment.
Note: In standby mode, these ports do not work.
- **RS-232C IN (CONTROL & SERVICE) PORT**
Connect to the RS-232C port on a PC.
- **ANTENNA IN / ANTENNA OUT**
Connect cable signals to this jack.
- **RGB/AUDIO IN**
Connect the monitor output from a PC to the appropriate input port.
- **Remote Control Port**
Connect your wired remote control.
- **DTV OUT**
Connect a second TV or monitor.
- **Power Cord Socket**
For operation with AC power.
Caution:
Never attempt to operate the TV on DC power.

INTRODUCTION

REMOTE CONTROL KEY FUNCTIONS

When using the remote control, aim it at the remote control sensor on the TV.

<p>D/A TV (Digital TV /Analogue TV) Selects digital or analogue mode.</p> <p>POWER Switches the set between ON and STANDBY.</p> <p>INPUT <ul style="list-style-type: none"> • Selects the DTV, TV, AV, Component, RGB or HDMI/DVI modes. • Switches the set on from standby. </p>	
<p>MENU Displays on screen menus one by one. Exits the current menu. Memorizes menu changes.</p> <p>EXIT Clears all on-screen displays and returns to TV viewing from any menu.</p>	
<p>THUMBSTICK (Up/Down /Left/Right) <ul style="list-style-type: none"> • Adjusts menu settings. • Selects menu item. <p>OK Accepts your selection or displays the current mode.</p> <p>COLOURED BUTTONS They are used as per the indications or functions displayed on TV screen in case of Text displays (Teletext, EPG) and programme edit.</p> </p>	
<p>VOLUME UP /DOWN Increases/decreases sound level.</p> <p>MUTE Switches the sound on or off.</p> <p>FAV (FAVOURITE) Displays the selected favourite programmes.</p> <p>PROGRAMME UP/DOWN Selects a programme.</p> <p>LIST Displays the programme table. ► p.55</p> <p>Q.VIEW Returns to the previously viewed programme.</p> <p>NUMBER button</p>	
<p>I/II <ul style="list-style-type: none"> • Selects the language during dual language broadcast. ► p.71 • Selects the sound output. ► p.71 </p> <p>VCR/DVD control buttons Control video cassette recorders or DVD players.</p>	

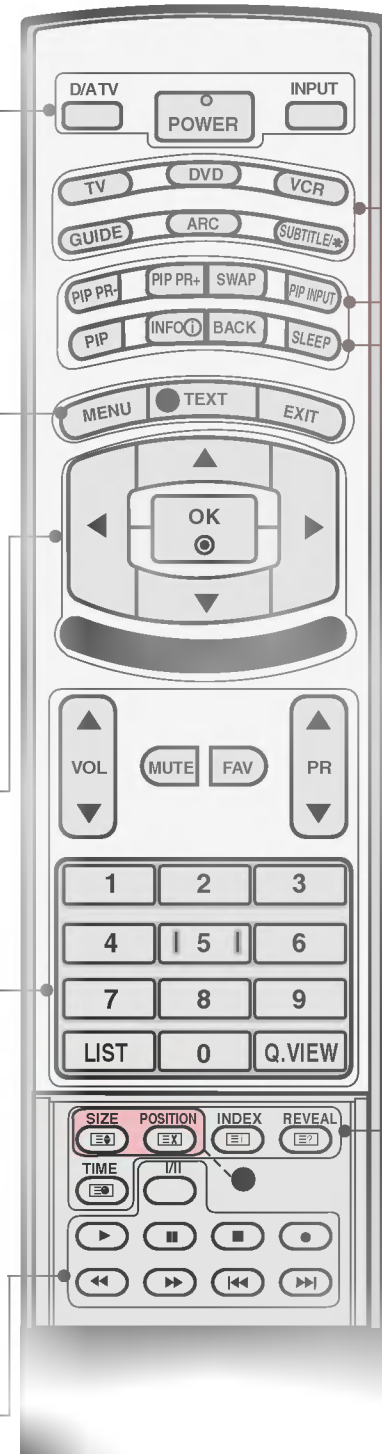

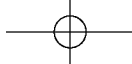

TV, DVD, VCR Select the remote operating mode: TV, DVD, or VCR.

GUIDE Shows programme schedule. ► **p.36**

ARC (Aspect Ratio Control) Selects your desired picture format. ► **p.84**

SUBTITLE/* Recalls your preferred subtitle in digital mode. ► **p.80**

PIP Switches the sub picture PIP, POP, Double Window or off mode. ► **p.29-31**

PIP PR +/- Selects the PIP programme. ► **p.29**

SWAP Alternates between main and sub picture. ► **p.31**

PIP INPUT Select the connected input source for the sub-picture. ► **p.30**

● **SIZE** Adjusts the sub picture size. ► **p.30**

● **POSITION** Moves the sub picture position. ► **p.30**

BACK Allow the user to move back one step in an interactive application, EPG or other user interaction function.

SLEEP Sets the sleep timer. ► **p.75**

● **TELETEXT BUTTONS** These buttons are used for teletext. Text button is used to enable teletext services while other buttons are for teletext functions. * For further details, see the 'Teletext' section. ► **p.32-35**

Installing Batteries

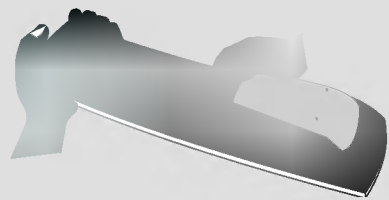

- Open the battery compartment cover on the back side and install the batteries matching correct polarity (+with +,-with -).
- Install two 1.5V AA batteries. Don't mix old or used batteries with new ones.
- Close cover.

Remote control effective range



- Use a remote control up to 7 meters distance and 30 degree (left/right) within the receiving unit scope.
- Dispose of used batteries in a recycle bin to preserve environment.

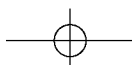
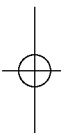

INTRODUCTION

INTRODUCTION



Brief Info.

What is Brief Info?

- : Brief Info shows the present screen information.
- : On Watching with the upper Input signal, press the **INFO** button.

How to use?

1. Press the **INFO** button to show the Brief Info on the screen.
2. Press the **INFO** button or **EXIT** button to exit.

Icon Function in Info. description Box	
	MHEG Programme
	Subtitle Programme
	Scramble Programme

Remote Control Buttons	Function
	Change to Now/Next
	The detail information on or off

DESKTOP PEDESTAL INSTALLATION

For proper ventilation, allow a clearance of 4 inches on each side from the wall.

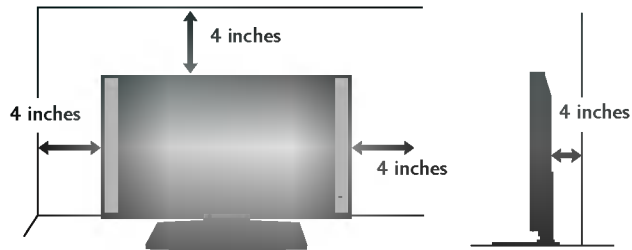

▲ CAUTION

- ▶ Ensure adequate ventilation by following the clearance recommendations.

SWIVEL STAND

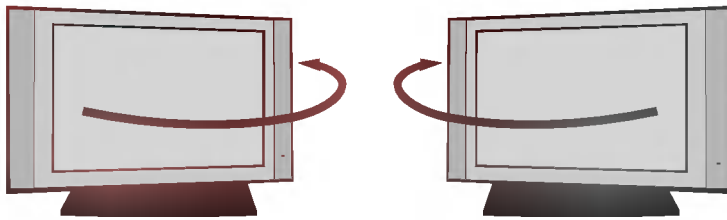

The TV can be conveniently swivelled on its stand 30° to the left or right to provide the optimum viewing angle.

INSTALLATION

WIRE ARRANGEMENT

- Connect the cables as necessary.
After connecting the cables neatly, arrange the cables to the Cable Holder.
To connect an additional equipment, see the **CONNECTIONS & SETUP** section.

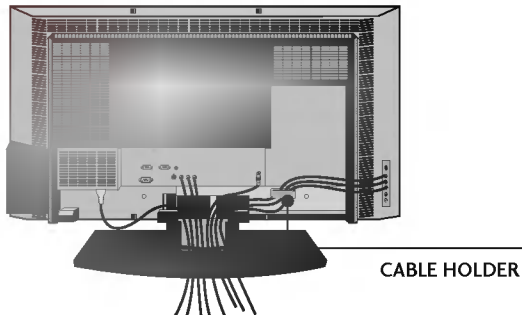

- Install the **CABLE MANAGEMENT** as shown.

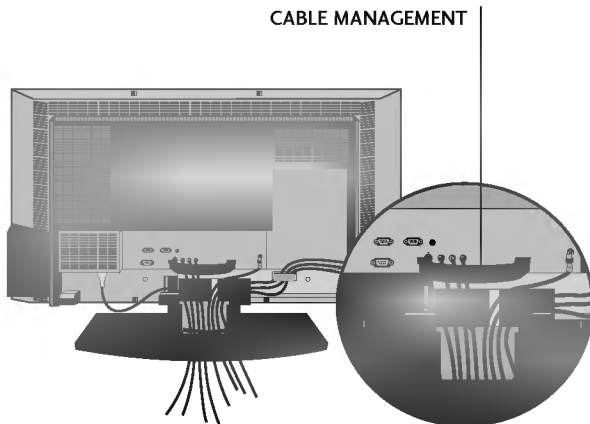

- Bundle the cables using the supplied twister holder.

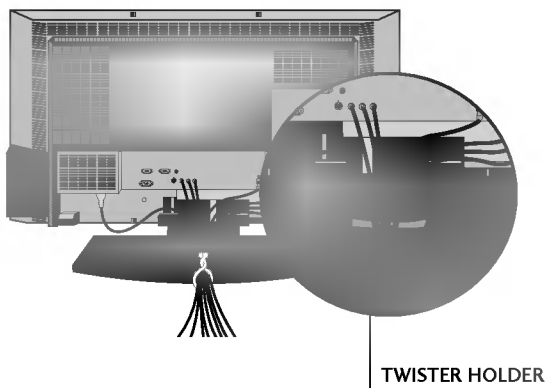

How to remove the **CABLE MANAGEMENT**

- ▶ Hold the **CABLE MANAGEMENT** with both hands and pull it upward.

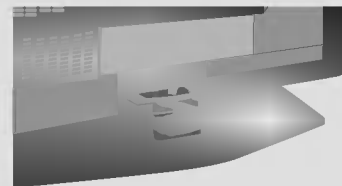

● **NOTE**

- ▶ Do not hold the **CABLE MANAGEMENT** when moving the product.
- If the product is dropped, you may be injured or the product may be broken.

ATTACHING THE TV TO A WALL

We recommend that you set up the TV close to a wall so it cannot fall over if pushed backwards. Additionally, we recommend that the TV be attached to a wall so it cannot be pulled in a forward direction, potentially causing injury or damaging the product.

Caution: Please make sure that children don't climb on or hang from the TV.

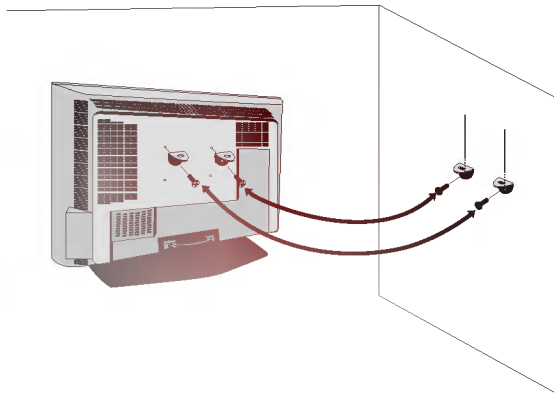

- Insert the TV brackets and bolts to tighten the product to the wall as shown in the picture. Secure the wall brackets with the bolts (not provided as parts of the product, must purchase separately) on the wall. Match the height of the bracket that is mounted on the wall to the holes in the product. Ensure the brackets are tightened securely.

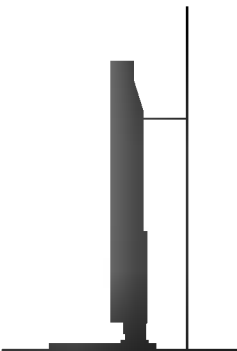

- Use a sturdy rope (not provided as parts of the product, must purchase separately) to tie the product. It is safer to tie the rope so it becomes horizontal between the wall and the product.

CONNECTIONS & SETUP

- All cables shown are not included with the TV.

ANTENNA CONNECTION

- For optimum picture quality, adjust antenna direction if needed.

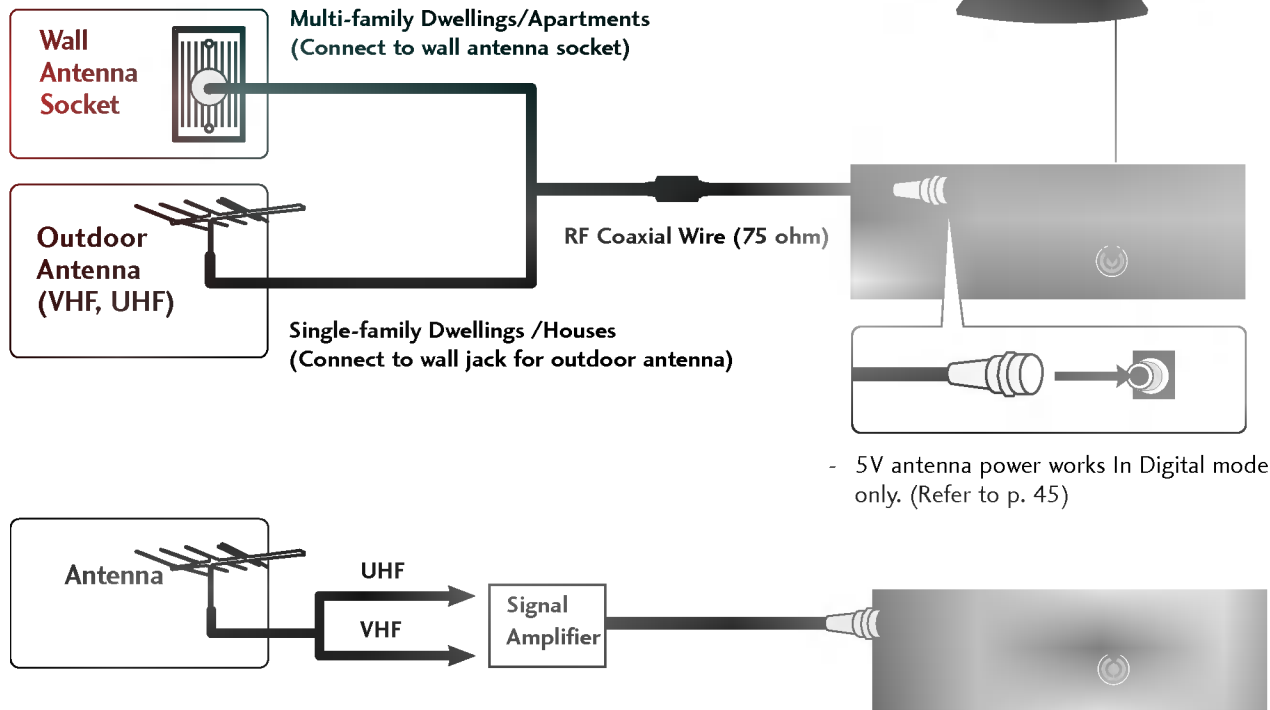

- To improve the picture quality in a poor signal area, please purchase a signal amplifier and install properly.
- If the antenna needs to be split for two TV's, install a 2-Way Signal Splitter.
- If the antenna is not installed properly, contact your dealer for assistance.

NOTE

- ▶ The TV will let you know when the analogue, cable, and digital programme scans are complete.

INSERTION OF CI MODULE

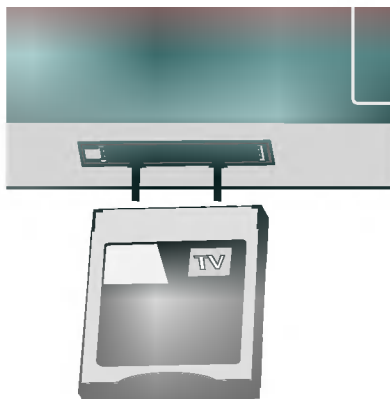

- To view the scrambled (pay) services in digital TV mode

Insert the CI Module to PCMCIA (Personal Computer Memory Card International Association) CARD SLOT of TV as shown. For further information, see p.44.

VCR SETUP

- To avoid picture noise (interference), leave an adequate distance between the VCR and TV
- If the 4:3 picture format is used; the fixed images on the sides of the screen may remain visible on the screen. This phenomenon is common to all manufactures and in consequence the manufactures warranty does not cover the product bearing this phenomenon.

When connecting with an antenna

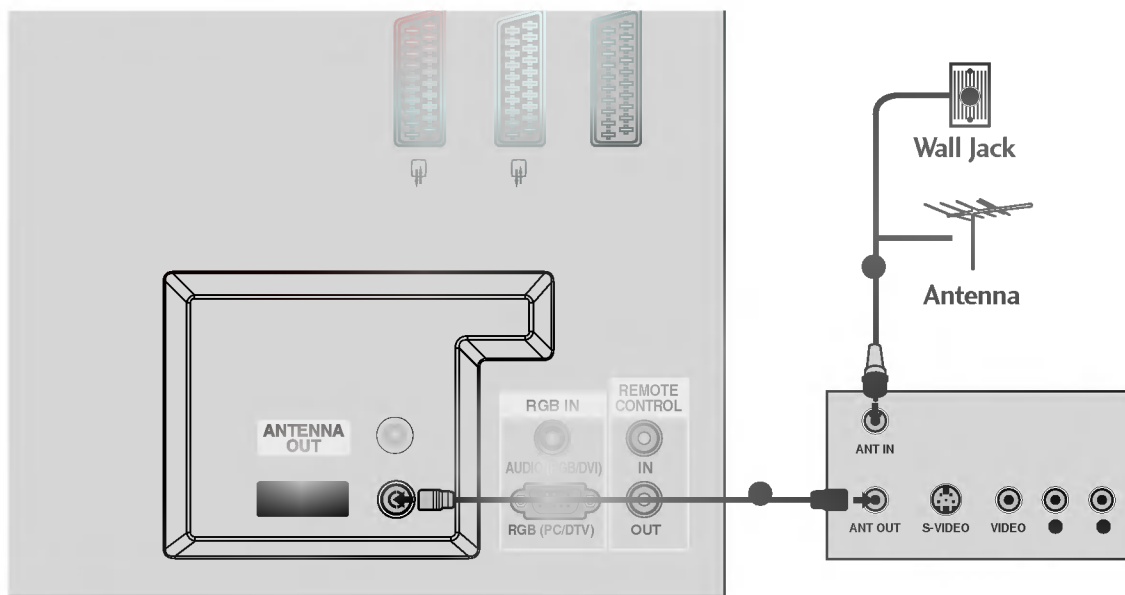

1. How to connect

- Connect the RF antenna out socket of the VCR to the **Antenna** socket on the set.
- Connect the antenna cable to the RF antenna in socket of the VCR.

2. How to use

- Press the **PLAY** button on the VCR and match the appropriate programme between the TV and VCR for viewing.

CONNECTIONS & SETUP

When connecting with a RCA cable

1. How to connect

- Connect the **AUDIO/VIDEO** jacks between TV and VCR. Match the jack colors (Video = yellow, Audio Left = white, and Audio Right = red)

2. How to use

- Insert a video tape into the VCR and press PLAY on the VCR. (Refer to the VCR owner's manual.)
- Select **AV3** input source with using the **INPUT** button on the remote control.
- If connected to **AV IN4**, select **AV4** input source.

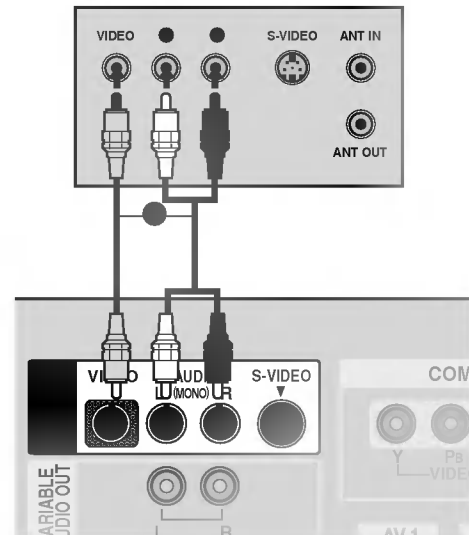

● NOTE

- ▶ If you have a mono VCR, connect the audio cable from the VCR to the **AUDIO L/MONO** jack of the set.

When connecting with an S-Video cable

1. How to connect

- Connect the **S-VIDEO** output of the VCR to the **S-VIDEO** input on the set.
- Connect the audio outputs of the VCR to the **AUDIO** input jacks on the set.

2. How to use

- Insert a video tape into the VCR and press PLAY on the VCR. (Refer to the VCR owner's manual.)
- Select **AV3** input source with using the **INPUT** button on the remote control.
- If connected to **AV IN4**, select **AV4** input source.

● NOTE

- ▶ The picture quality is improved: compared to normal composite (RCA cable) input.

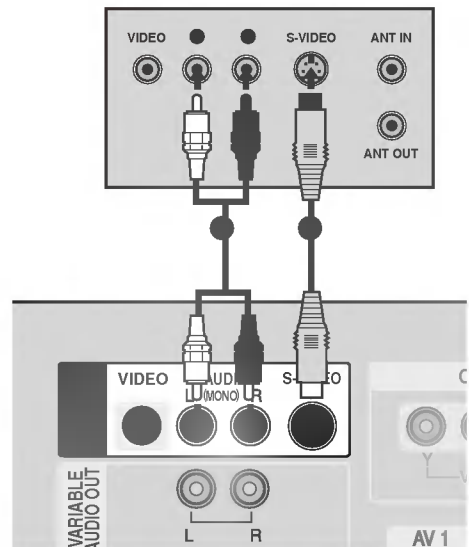

▲ CAUTION

- ▶ Do not connect to both Video and S-Video at the same time. In the event that you connect both Video and the S-Video cables, only the S-Video will work.

When connecting with a Euro scart

1. How to connect

- Connect the Euro scart socket of the VCR to the AV1 Euro scart socket on the set.

2. How to use

- Insert a video tape into the VCR and press PLAY on the VCR. (Refer to the VCR owner's manual.)
- Select **AV1** input source with using the **INPUT** button on the remote control.
- If connected to **AV2**, select **AV2** input source.

● NOTE

- ▶ If the **S-VIDEO(Y/C)** signal is received through the Euro scart socket 2 (**AV2**), you must change to the **SAV2** mode.
- ▶ Please use the shield scart cable.

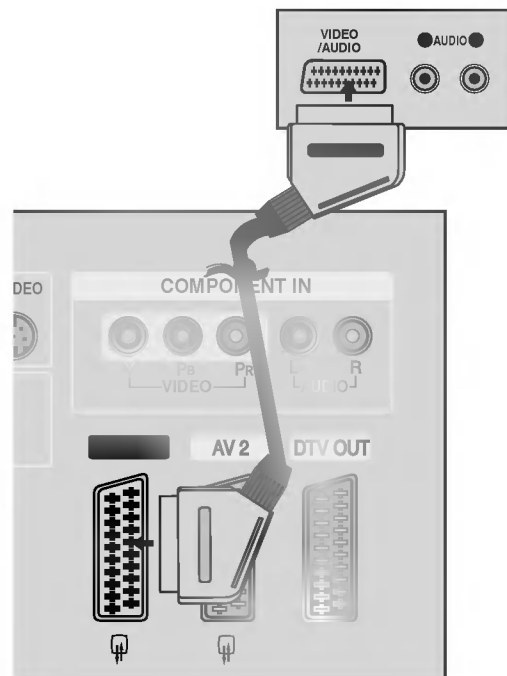

CONNECTIONS & SETUP

EXTERNAL A/V SOURCE SETUP

1. How to connect

- Connect the **AUDIO/VIDEO** jacks between TV and external equipment. Match the jack colors. (Video = yellow, Audio Left = white, and Audio Right = red)

2. How to use

- Select **AV4** input source with using the **INPUT** button on the remote control.
- If connected to **AV IN3** input, select **AV3** input source.
- Operate the corresponding external equipment.

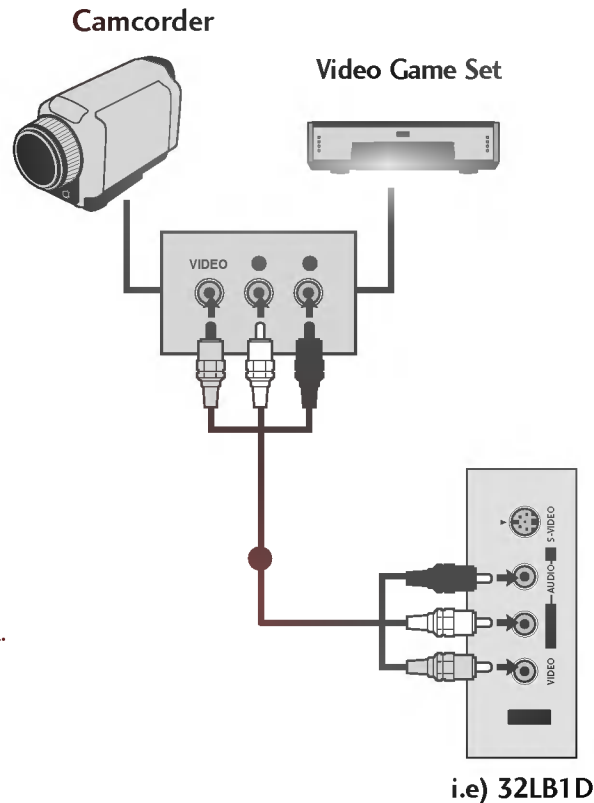

PICTURE OUT SETUP

- The set has a special signal output capability which allows you to hook up a second TV or monitor.

1. How to connect

- Connect the second TV or monitor to the TV's **DTV OUT** jacks.
- See the Operating Manual of the second TV or monitor for further details regarding that device's input settings.

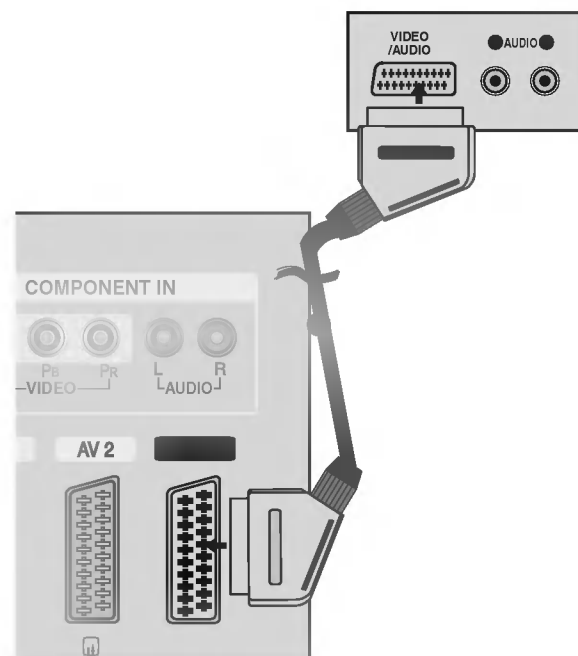

DIGITAL AUDIO OUTPUT

Send the TV's audio to external audio equipment via the Digital Audio Output (Optical) port.

1. How to connect

- Connect one end of an optical cable to the TV Digital Audio (Optical) Output port.
- Connect the other end of the optical cable to the digital audio (optical) input on the audio equipment.
- Set the "TV Speaker option - Off" in the SOUND menu. (▶ p.69). See the external audio equipment instruction manual for operation.

● NOTE

- ▶ When connecting with external audio equipments, such as amplifiers or speakers, please turn the TV speakers off. (▶ p.69)

▲ CAUTION

- ▶ Do not look into the optical output port. Looking at the laser beam may damage your vision.

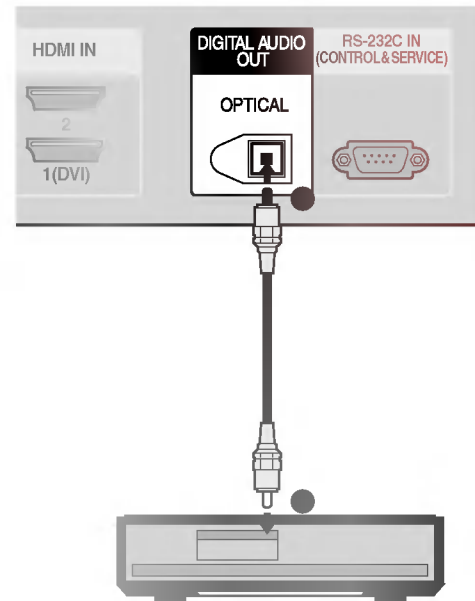

EXTERNAL STEREO

Use to connected either an external amplifier, or add a sub-woofer to your surround sound system.

1. How to connect

- Connect the input jack of the stereo's amplifier to the **VARIABLE AUDIO OUT** jacks on the set.
- Set up your speakers through your analog stereo amplifier, according to the instructions provided with the amplifier.

● NOTE

- ▶ When connecting with external audio equipments, such as amplifiers or speakers, please turn the TV speakers off. (▶ p.69)

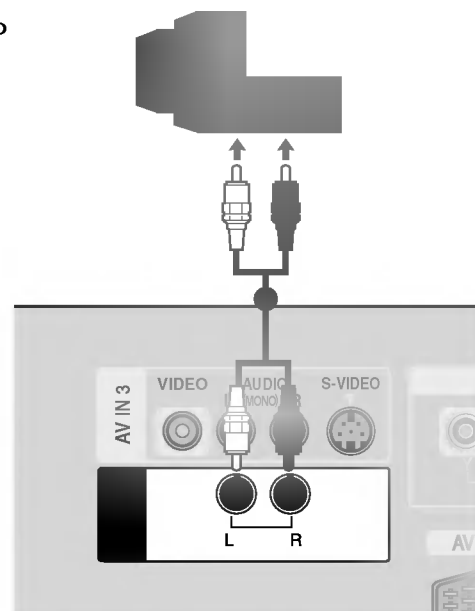

CONNECTIONS & SETUP

DVD SETUP

When connecting with a Component cable

1. How to connect

- Connect the video outputs (Y, PB, PR) of the DVD to the **COMPONENT IN VIDEO** jacks on the set.
Match the jack colors
(Y = green, PB = blue, and PR = red).

- Connect the audio outputs of the DVD to the **COMPONENT IN AUDIO** jacks on the set.

2. How to use

- Turn on the DVD player, insert a DVD.
- Select **COMPONENT** input source with using the **INPUT** button on the remote control.
- Refer to the DVD player's manual for operating instructions.

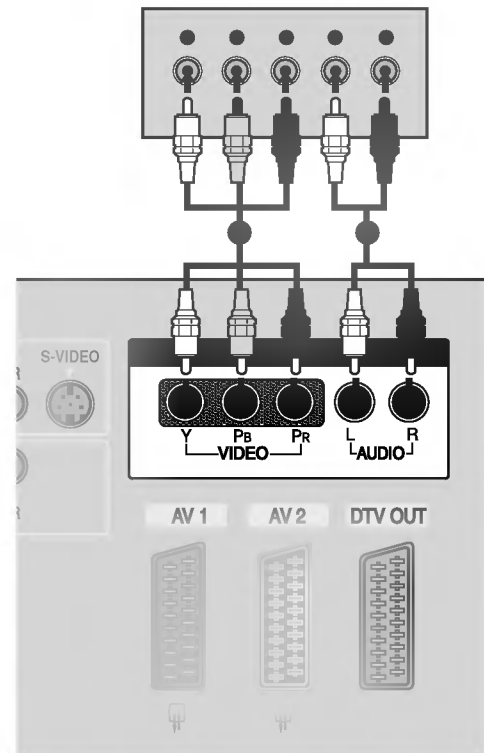

Component Input ports

To get better picture quality, connect a DVD player to the component input ports as shown below.

Component ports on the TV	Y		
Video output ports on DVD player	Y	Pb	
	Y	B-Y	
	Y	Cb	
	Y	Pb	

When connecting with an S-Video cable

1. How to connect

- Connect the S-VIDEO output of the DVD to the **S-VIDEO** input on the set.
- Connect the audio outputs of the DVD to the **AUDIO** input jacks on the set.

2. How to use

- Turn on the DVD player, insert a DVD.
- Select **AV3** input source with using the **INPUT** button on the remote control.
- If connected to **AV IN4**, select **AV4** input source.
- Refer to the DVD player's manual for operating instructions.

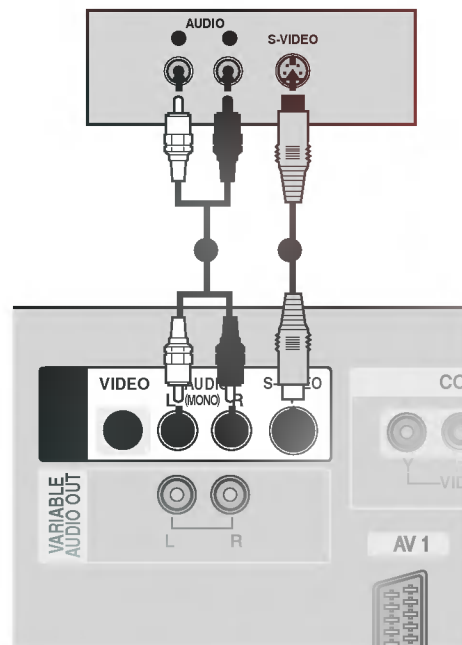

When connecting with a HDMI cable

1. How to connect

- Connect the HDMI output of the DVD to the **HDMI IN 1 (DVI)** or **2** jack on the set.
- No separated audio connection is necessary.

2. How to use

- Select **HDMI1/DVI** or **HDMI2** input source with using the **INPUT** button on the remote control.
- Refer to the DVD player's manual for operating instructions.

● NOTE

- ▶ If the DVD supports Auto HDMI function, the DVD output resolution will be automatically set to 1280x720p.
- ▶ If the DVD does not support Auto HDMI, you need to set the output resolution appropriately.
To get the best picture quality, adjust the output resolution of the DVD to 1280x720p.

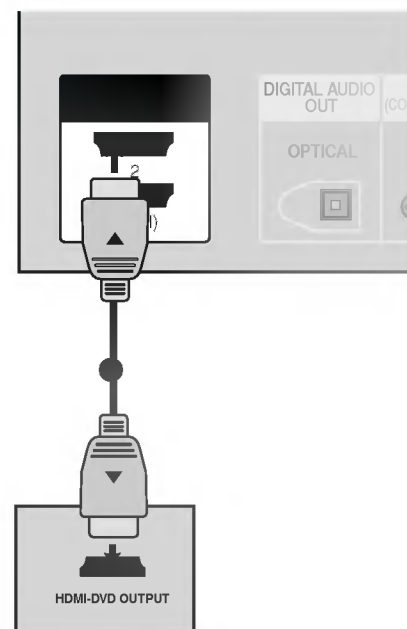

CONNECTIONS & SETUP

When connecting with a Euro scart

1. How to connect

- Connect the Euro scart socket of the DVD to the **AV1** Euro scart socket on the set.

2. How to use

- Turn on the DVD player, insert a DVD.
- Select **AV1** input source with using the **INPUT** button on the remote control.
- If connected to **AV2**, select **AV2** input source.
- Refer to the DVD player's manual for operating instructions.

● NOTE

- ▶ Please use the shield scart cable.

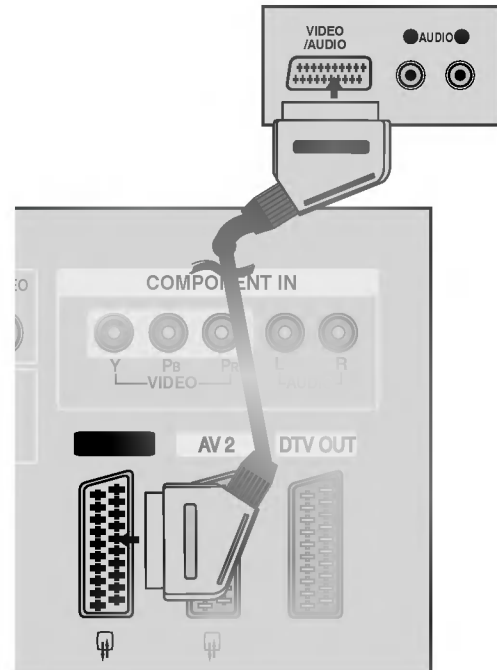

HDSTB SETUP

This TV can receive Digital Over-the-air/Cable signals without an external digital set-top box. However, if you do receive digital signals from a digital set-top box or other digital external device, refer to the figure as shown below.

When connecting with a Component cable

1. How to connect

- Connect the video outputs (Y, PB, PR) of the digital set-top box to the **COMPONENT IN VIDEO** jacks on the set. Match the jack colors (Y = green, PB = blue, and PR = red).
- Connect the audio output of the digital set-top box to the **COMPONENT IN AUDIO** jacks on the set.

2. How to use

- Turn on the digital set-top box.
(Refer to the owner's manual for the digital set-top box.)
- Select **COMPONENT** input source with using the **INPUT** button on the remote control.

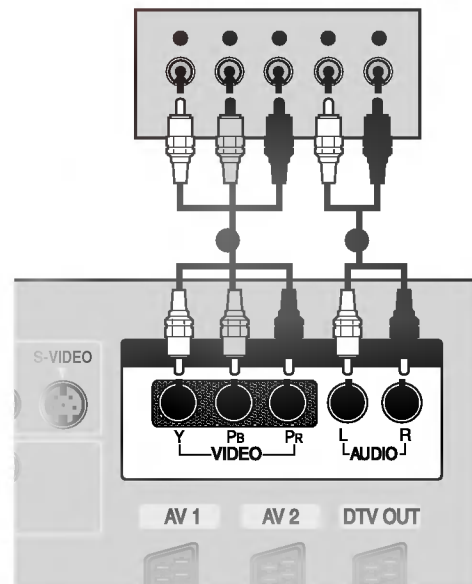

480i	Yes	No
576i	Yes	No
480p	Yes	Yes
576P	Yes	Yes
720p	Yes	Yes
1080i	Yes	Yes

CONNECTIONS & SETUP

When connecting with a D-sub 15pin cable

1. How to connect

- Connect the RGB output of the digital set-top box to the **RGB (PC/DTV)** jack on the set.
- Connect the audio outputs of the set-top box to the **AUDIO (RGB/DVI)** jack on the set.

2. How to use

- Turn on the digital set-top box.
(Refer to the owner's manual for the digital set-top box.)
- Select **RGB** input source with using the **INPUT** button on the remote control.

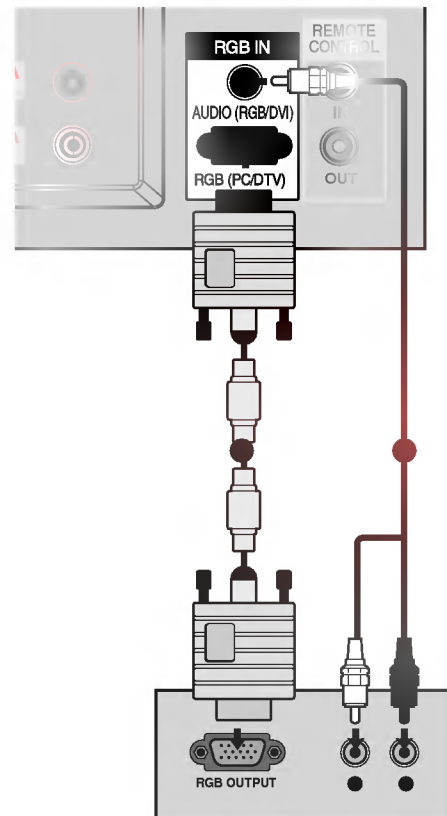

When connecting with a HDMI cable

1. How to connect

- Connect the digital set-top box to **HDMI IN 1 (DVI)** or **2** jack on the set.
- No separated audio connection is necessary.

2. How to use

- Turn on the digital set-top box.
(Refer to the owner's manual for the digital set-top box.)
- Select **HDMI1/DVI** or **HDMI2** input source with using the **INPUT** button on the remote control.

● NOTE

- ▶ If the digital set-top box supports Auto HDMI function, the output resolution of the source device will be automatically set to 1280x720p.
- ▶ If the digital set-top box player does not support Auto HDMI, you need to set the output resolution appropriately.
To get the best picture quality, adjust the output resolution of the source device to 1280x720p.

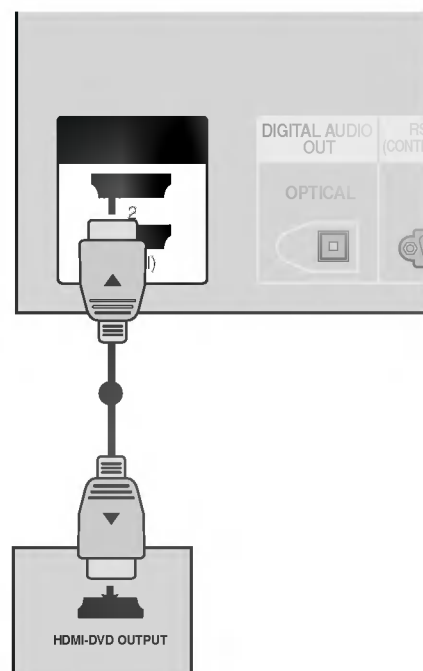

When connecting with a HDMI to DVI cable

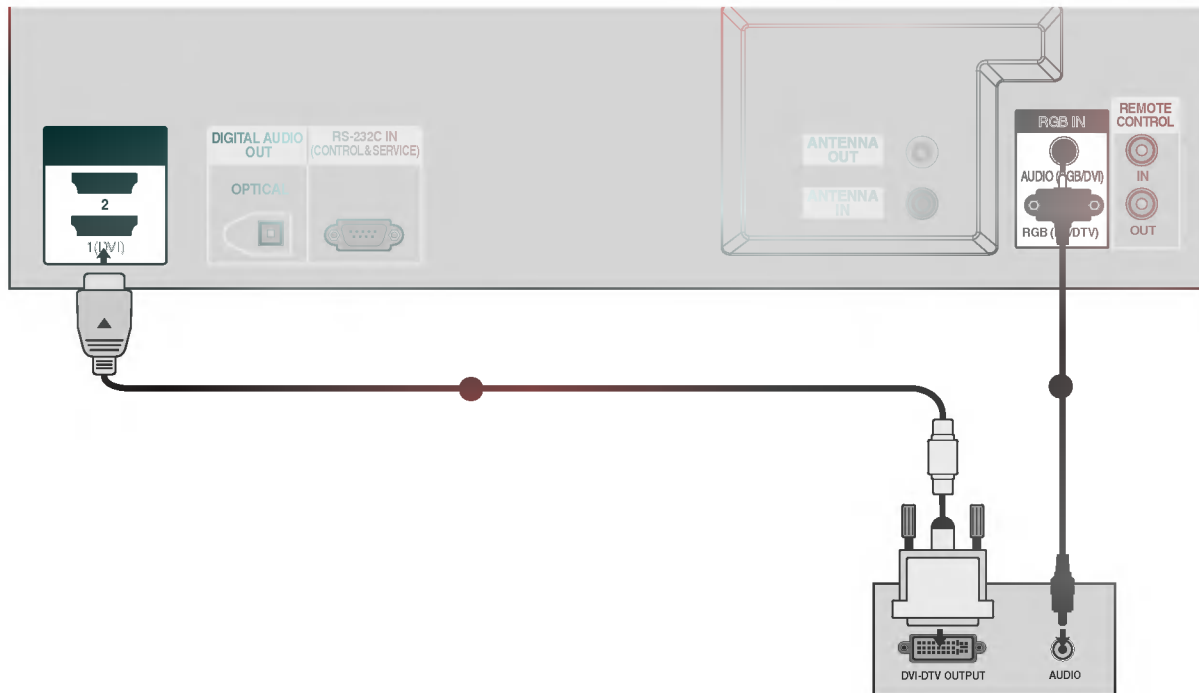

1. How to connect

- Connect the DVI output of the digital set-top box to the **HDMI IN 1 (DVI)** jack on the set.
- Connect the audio output of the digital set-top box to the **AUDIO (RGB/DVI)** jack on the set.

2. How to use

- Turn on the digital set-top box. (Refer to the owner's manual for the digital set-top box.)
- Select **HDMI1 /DVI** input source with using the **INPUT** button on the remote control.

● NOTE

- ▶ HDMI2 source does not support DVI source.
- ▶ If the digital set-top box has a DVI output and no HDMI output, a separated audio connection is necessary.

CONNECTIONS & SETUP

PC SETUP

This TV provides Plug and Play capability, meaning that the PC adjusts automatically to the TV's settings.

When connecting with a D-sub 15pin cable

1. How to connect

- Connect the RGB output of the PC to the **RGB (PC/DTV)** jack on the set.
- Connect the PC audio output to the **AUDIO (RGB/DVI)** jack on the set.

2. How to use

- Turn on the PC and the set.
- Select RGB input source with using the INPUT button on the remote control.

● NOTE

- ▶ Check the image on your TV. There may be noise associated with the resolution, vertical pattern, contrast or brightness in PC mode. If noise is present, change the PC output to another resolution, change the refresh rate to another rate or adjust the brightness and contrast on the VIDEO menu until the picture is clear. If the refresh rate of the PC graphic card can not be changed, change the PC graphic card or consult the manufacturer of the PC graphic card.

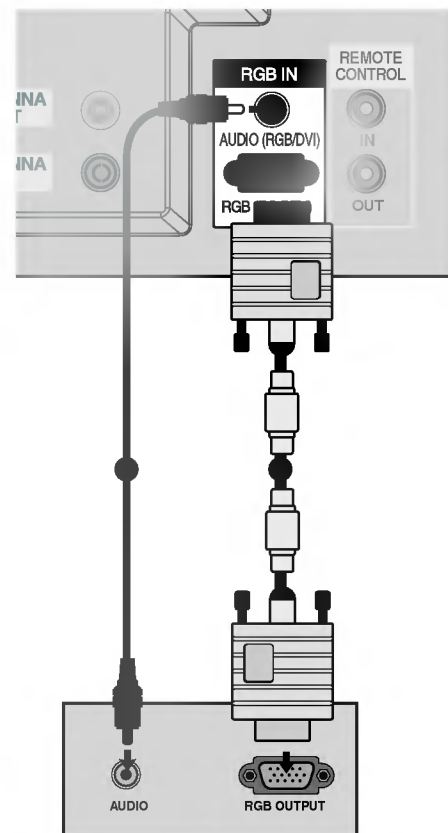

When connecting with a HDMI to DVI cable

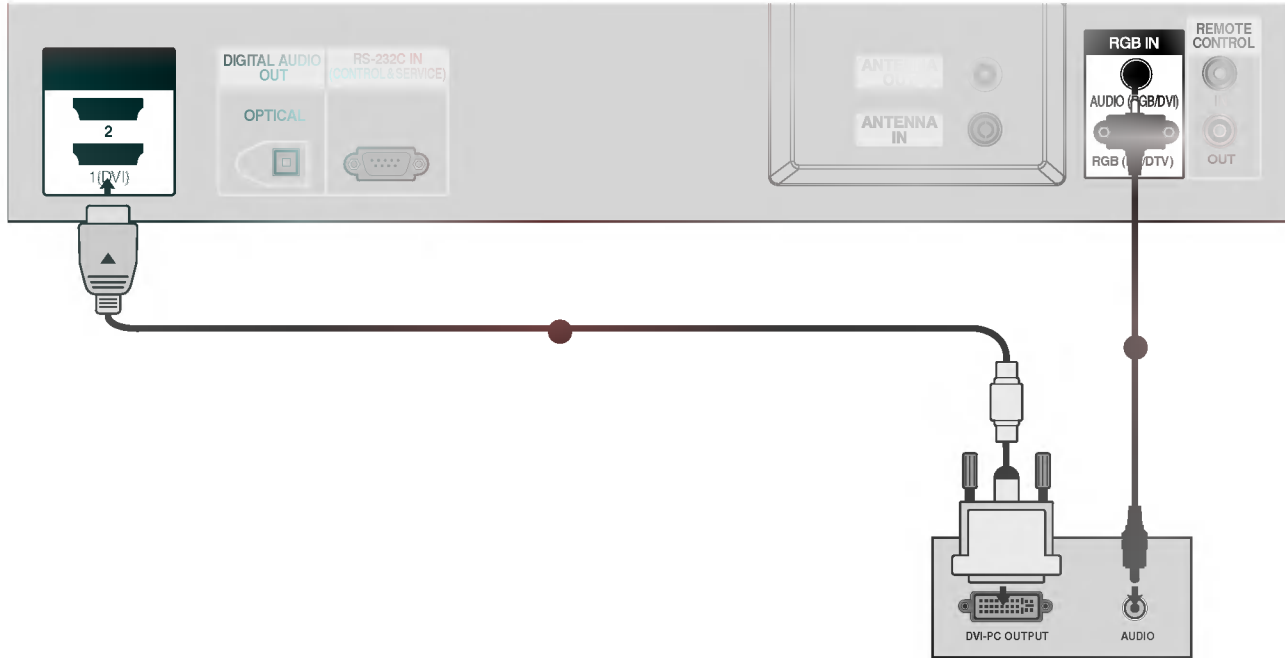

1. How to connect

- Connect the DVI output of the PC to the **HDMI IN 1 (DVI)** jack on the set.
- Connect the PC audio output to the **AUDIO (RGB/DVI)** jack on the set.

2. How to use

- Turn on the PC and the set
- Select **HDMI1/DVI** input source with using the **INPUT** button on the remote control.

● NOTE

- ▶ HDMI2 source does not support DVI source.
- ▶ If the PC has a DVI output and no HDMI output, a separated audio connection is necessary.
- ▶ If the PC does not support Auto DVI, you need to set the output resolution appropriately. To get the best picture quality, adjust the output resolution of PC graphics card's output resolution to 1024x768, 60Hz.

CONNECTIONS & SETUP

● NOTE

- ▶ Avoid keeping a fixed image on the set's screen for a long period of time. The fixed image may become permanently imprinted on the screen; use a screen saver when possible.
- ▶ The synchronization input waveform for Horizontal and Vertical frequencies are separate.
- ▶ If the resolution of PC is over UXGA, there will be no picture on the set.
- ▶ This set uses a VESA Plug and Play Solution. The set provides EDID data to the PC system with a DDC protocol. The PC adjusts automatically when using this set.
- ▶ DDC protocol is preset for RGB (Analog RGB), HDMI (Digital RGB) mode.
- ▶ If required, adjust the settings for Plug and Play functionally.
- ▶ If graphic card on the PC does not output analog and digital RGB simultaneously, connect only one of either RGB (PC/DTV) or HDMI IN (or HDMI/DVI IN to display the PC on the set.
- ▶ If graphic card on the PC does output analog and digital RGB simultaneously, set the set to either RGB or HDMI; (the other mode is set to Plug and Play automatically by the set.)
- ▶ DOS mode may not work depending on video card if you use a HDMI to DVI cable.
- ▶ When you use too long RGB-PC cable, there might be a noise on the screen. We recommend using under 5m of the cable. It provides the best picture quality.

Supported Display Resolution

RGB[PC] / HDMI[PC] mode

720x400	31.468	70.8
640x480	31.469	59.94
	37.684	75.00
800x600	37.879	60.31
	46.875	75
832x624	49.725	74.55
	48.363	60
1024x768	56.47	70
	60.123	75.029
1280x768	47.776	59.870
1360x768	47.720	59.799
1366x768	47.720	59.799

RGB[DTV] / HDMI[DTV] mode

720x576	31.25	50.00
640x480	31.5	59.94/60
720x480	31.47	59.94/60
1280x720	45.00	50.00
	44.96	59.94/60
1920x1080	28.13	50.00
	33.72	59.94/60

● NOTE

- ▶ The set is supported to 640x480 in HDMI[DTV] mode.

BASIC OPERATION

TURNING ON THE SET

- Connect power cord correctly, the set is switched to standby mode.
- Press the \odot / I, INPUT or PR \blacktriangle \blacktriangledown button on the set or press the POWER, INPUT, D/A TV, PR \blacktriangle \blacktriangledown or NUMBER buttons on the remote control and then the set will switch on.

Initializing setup



If the OSD (On Screen Display) is displayed on the screen as figure after turning on the set, you can adjust the Auto Programme tuning.

Note: It will automatically disappear after approx. 40 seconds unless a button is pressed.

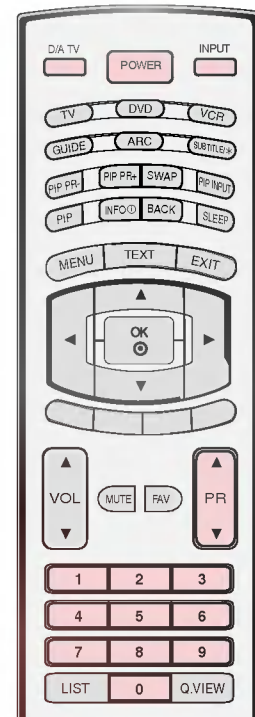

BASIC OPERATION

PROGRAMME SELECTION

- Press the **PR ▲ ▼** or **NUMBER** buttons to select a programme number.



VOLUME ADJUSTMENT

Adjust the volume to suit your personal preference.

- Press the **VOL ▲ ▼** button to adjust the volume.

 If you want to switch the sound off, press the **MUTE** button.

 You can cancel this function by pressing the **MUTE**,
VOL ▲ ▼, or **I/II** button.

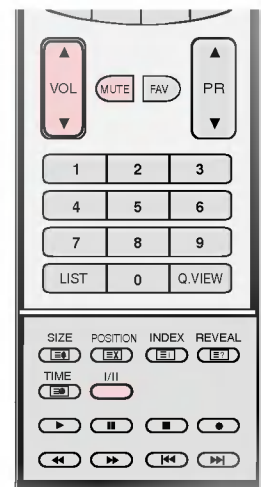

SPECIAL FUNCTIONS

PIP / POP / DOUBLE WINDOW

PIP lets you view 2 different inputs (sources) on the screen at the same time. One source will be large, and the other source will show a smaller inset image.

Double window mode splits the screen into 2, allowing 2 picture sources to be shown on the screen at the same time. Each source is given half the screen.

Watching PIP/Double Window/POP

Press the **PIP** button to access the sub picture.

Each press of PIP changes the PIP options as shown below.

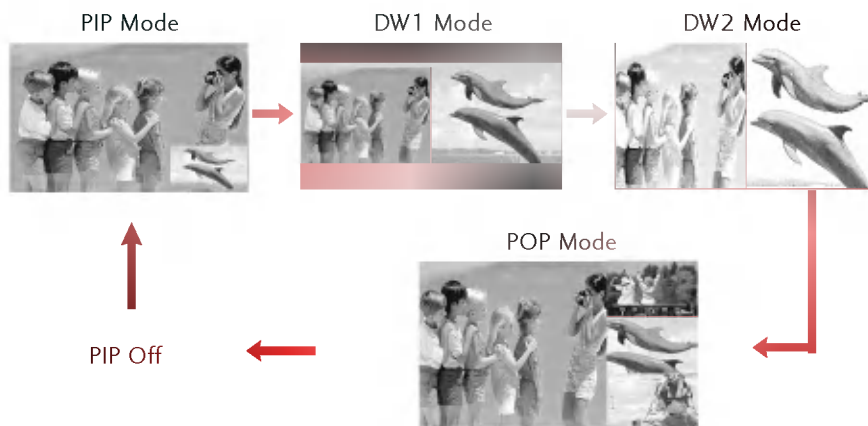

Programme Selection for Sub Picture

- Press the **PIP** button.
- Press the **PIP PR +/-** button to select a programme for the sub picture.
(You can't select DTV for main and sub picture simultaneously).

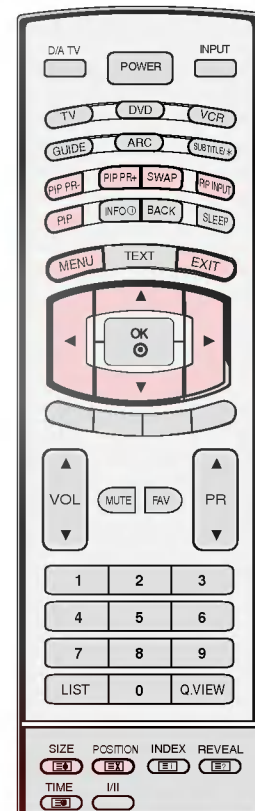

SPECIAL FUNCTIONS

PIP / POP / DOUBLE WINDOW

Input Source Selection for Sub Picture

Press the **PIP INPUT** button to select the input source for the sub picture.

Each press of **PIP INPUT** button is pressed, each input source for the sub picture is displayed.

When the sub picture quality get poor for sub picture, select Auto, PAL, SECAM or NTSC in PIP System menu.

● NOTE

- ▶ You can't select the same modes for main picture and sub picture simultaneously.
- ▶ When the main picture is DTV or HDMI mode, the sub picture isn't available to select DTV and HDMI modes.
- ▶ When the main picture is RGB mode, the sub picture isn't available to select HDMI modes.
- ▶ When the main picture is HDMI mode, the sub picture isn't available to select RGB modes.
- ▶ It's not available to use this function in Vertical Frequency 85Hz for sub picture.

Sub Picture Size Adjustment

- Press the **SIZE** button and then ◀ or ▶ button to adjust the sub picture size.

With **SIZE** button in DW1 modes, main and sub picture is adjusted simultaneously.

With **SIZE** button in PIP mode, sub picture is adjusted.



Moving the Sub Picture (PIP mode only)

- Press the **POSITION** button.
- Repeatedly press the ▲ ▼ ◀ ▶ button until desired position is achieved.

The sub picture moves up/down or left/right.





Adjusting PIP Transparency (PIP mode only)

- Press the **MENU** button and then **▲** or **▼** button to select the **PIP/DW** menu.
- Press the **▶** button and then **▲** or **▼** button to select **PIP Transparency**.
- Press the **▶** button and then **◀** or **▶** button to adjust PIP transparency.
- Press the **EXIT** button to return to normal TV viewing.

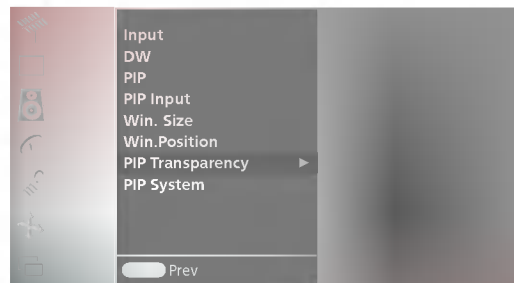

Swapping between main and sub pictures

Press the **SWAP** button to exchange the main and sub pictures.

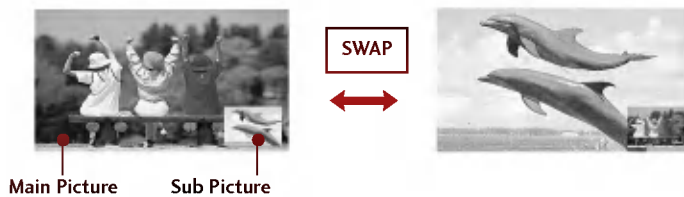

POP (Picture-out-of-Picture: Programme Scan)

Use POP to search the programmes of all the memorized channels one-by-one on the 3 PIP screen display, (while the main picture source remains the current channel). The pictures of all the programmed channels are searched with the 3 POP screen.

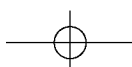
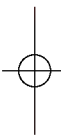

SPECIAL FUNCTIONS

TELETEXT - In Digital Mode

- The set gives you access to a digital teletext which is greatly improved in various aspects such as text, graphics and so on.
- This digital teletext can be accessed by special digital teletext services and specific services which broadcast digital teletext.
- You should select off from the subtitle language to display teletext by pressing **SUBTITLE/*** button.

Teletext within Digital Service

- Press the numeric or **PR ▲** or **▼** button to select a digital service which broadcasts digital teletext.
- Follow the indications on digital teletext and move onto the next step by pressing **TEXT, OK, ▲▼◀▶, RED, GREEN, YELLOW, BLUE** or **NUMBER** buttons and so on.
- To change digital teletext service, just select a different service by the numeric or **PR ▲ ▼** button.

If pressing the **MENU, GUIDE** or **INFO** button, the teletext service disappear temporarily. When pressing these buttons again, the teletext service is appeared.



Teletext in Digital Service

- Press the numeric or **PR ▲** or **▼** button to select a certain service which broadcasts digital teletext.
- Press the **TEXT** or colour button to switch on teletext.
- Follow the indications on digital teletext and move onto the next step by pressing **OK, ▲▼◀▶, RED, GREEN, YELLOW, BLUE** or **NUMBER** buttons and so on.
- Press the **TEXT** or colour button to switch off digital teletext and return to TV viewing.

Some services may allow you to access text services by pressing the **RED** button.

If pressing the **MENU, GUIDE** or **INFO** button, the teletext service disappear temporarily. When pressing these buttons again, the teletext service is appeared.

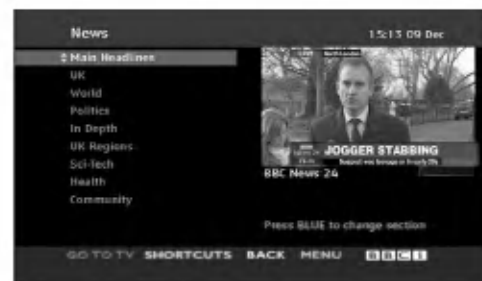

TELETEXT - *In Analogue Mode*

- Teletext is a free service broadcast by most TV stations which gives up-to-the-minute information on news, weather, television programmes, share prices and many other topics.
- The teletext decoder of this set can support the SIMPLE, TOP and FASTEXT systems. SIMPLE (standard teletext) consists of a number of pages which are selected by directly entering the corresponding page number. TOP and FASTEXT are more modern methods allowing quick and easy selection of teletext information.

Switch on/off

- 1 Press the **TEXT** button to switch to teletext. The initial page or last page appears on the screen.
Two page numbers, TV station name, date and time are displayed on the screen headline. The first page number indicates your selection, while the second shows the current page displayed.
 - 2 Press the **TEXT** or **EXIT** button to switch off teletext. The previous mode reappears.
-

SIMPLE Text

■ Page selection

- 1 Enter the desired page number as a three digit number with the **NUMBER** buttons.
If during selection you press a wrong number, you must complete the three digit number and then re-enter the correct page number.
 - 2 The **PR ▲** or **▼** button can be used to select the preceding or following page.
-

SPECIAL FUNCTIONS

TELETEXT - *In Analogue Mode*

TOP Text

- The user guide displays four fields-red, green, yellow and blue at the bottom of the screen. The yellow field denotes the next group and the blue field indicates the next block.

■ Block / group / page selection

- 1 With the **BLUE** button you can progress from block to block.
- 2 Use the **YELLOW** button to proceed to the next group with automatic overflow to the next block.
- 3 With the **GREEN** button you can proceed to the next existing page with automatic overflow to the next group. Alternatively the **PR ▲** button can be used.
- 4 The **RED** button permits to return to previous selection. Alternatively the **PR ▼** button can be used.

■ Direct page selection

- 1 Corresponding to the SIMPLE teletext mode, you can select a page by entering it as a three digit number using the **NUMBER** buttons in TOP mode.

FASTEXT

- The teletext pages are colour coded along the bottom of the screen and are selected by pressing the corresponding coloured button.

■ Page selection

- 1 Press the **≡** button to select the index page.
- 2 You can select the pages which are colour coded along the bottom line with the same coloured buttons.
- 3 Corresponding to the SIMPLE teletext mode, you can select a page by entering its three digit page number with the **NUMBER** buttons in FASTEXT mode.
- 4 The **PR ▲** or **▼** button can be used to select the preceding or following page.

Special Teletext Functions



REVEAL

Press this button to display concealed information, such as solutions of riddles or puzzles.
Press this button again to remove the information from the display.

SIZE

Selects double height text.
Press this button to enlarge the top half of the page.
Press this button again to enlarge the bottom half of the page.
Press this button again to return to the normal display.

POSITION

Displays the picture on the screen while waiting for the new teletext page.
The display  will appear at the top left hand corner of the screen.
When the updated page is available then display  will change to the page number.
Press this button to view the updated teletext page.

TIME

When viewing a TV programme, press this button to display the time at the top right hand corner of the screen.
Press this button again to remove the display.
In the teletext mode, press this button to select a sub page number.
The sub page number is displayed at the bottom of the screen.
To hold or change the sub page, press the **RED**, **GREEN**, **◀ ▶** or **NUMBER** buttons.
Press again to exit this function.

SPECIAL FUNCTIONS

EPG (ELECTRONIC PROGRAMME GUIDE)

- *In Digital Mode only*

- This system has an Electronic Programme Guide (EPG) to help your navigation through all the possible viewing options.
- The EPG supplies information such as programme listings, start and end times for all available services. In addition, detailed information about the programme is often available in the EPG (the availability and amount of these programme details will vary, depending on the particular broadcaster).
- This function can be used only when the EPG information is broadcasted by broadcasting companies.
- The EPG displays the programme description for next 8 days.

Switch on/off EPG

- Press the **GUIDE** button to switch on EPG.
- Press the **GUIDE** or **EXIT** button again to switch off EPG and return to TV viewing.

Select a programme

- Press the **▲ ▼ ◀ ▶**, **PR ▲** or **▼** button to select desired programme, then press the **OK** button to display the selected programme.



Button Function in NOW/NEXT Guide Mode

Remote Control Buttons	Function
RED	Change EPG mode
YELLOW	Enter Timer Record/Remind setting mode
BLUE	Enter Timer Record/Remind list mode
⊙	Change to the selected channel
◀ or ▶	Select NOW or NEXT Programme
▲ or ▼	Select the Broadcasting Programme
PR ▲ or ▼	Page Up/Down
GUIDE/EXIT	Switch off EPG
FAV	Displayed when the Favourite Programme.
i	The detail information on or off



Button Function in 8 Days Guide Mode

Remote Control Buttons	Function
RED	Change EPG mode
GREEN	Enter Date Change mode
YELLOW	Enter Timer Record/Remind setting mode
BLUE	Enter Timer Record/Remind list mode
⊙	Change to the selected channel
◀ or ▶	Select NOW or NEXT Programme
▲ or ▼	Select the Broadcasting Programme
PR ▲ or ▼	Page Up/Down
GUIDE/EXIT	Switch off EPG
FAV	Displayed when the Favourite Programme.
i	The detail information on or off



Button Function in Date Change Mode

Remote Control Buttons	Function
GREEN	Enter 8 Days Guide Mode
⊙	Change to the selected date
◀ or ▶	Select a date
▼	Switch off Date setting mode
GUIDE/EXIT	Switch off EPG



SPECIAL FUNCTIONS

EPG (ELECTRONIC PROGRAMME GUIDE)

- In Digital Mode only

Button Function in Extended Description Box

Remote Control Buttons	Function
▲ or ▼	Text Up/Down
PR ▲ or ▼	Programme Up/Down
i	The detail information on or off
GUIDE/EXIT	Switch off EPG



Button Function in Record/Remind Setting Mode

- This function is available only when recording equipment that use pin8 recording signalling has been connected to the DTV-OUT terminal, using a SCART cable.

Remote Control Buttons	Function
RED	Change to Guide or Timer list mode
⊙	Save Timer Record/Remind
◀ or ▶	Select Type, Service, Date or Start/End time
▲ or ▼	Function setting



Button Function in Timer List Mode

Remote Control Buttons	Function
RED	Add new Manual Timer setting mode
GREEN	Enter Timer list editing mode
YELLOW	Delete the selected item
BLUE	Change to Guide mode
▲ or ▼	Select Timer list



TV MENU

ON SCREEN MENUS SELECTION AND ADJUSTMENT

Your TV's OSD (On Screen Display) may differ slightly from what is shown in this manual.

- Press the **MENU** button and then use ▲ or ▼ button to select each menu.
- Press the ► button and then use ▲ ▼ ◀ ▶ button to display the available menus.

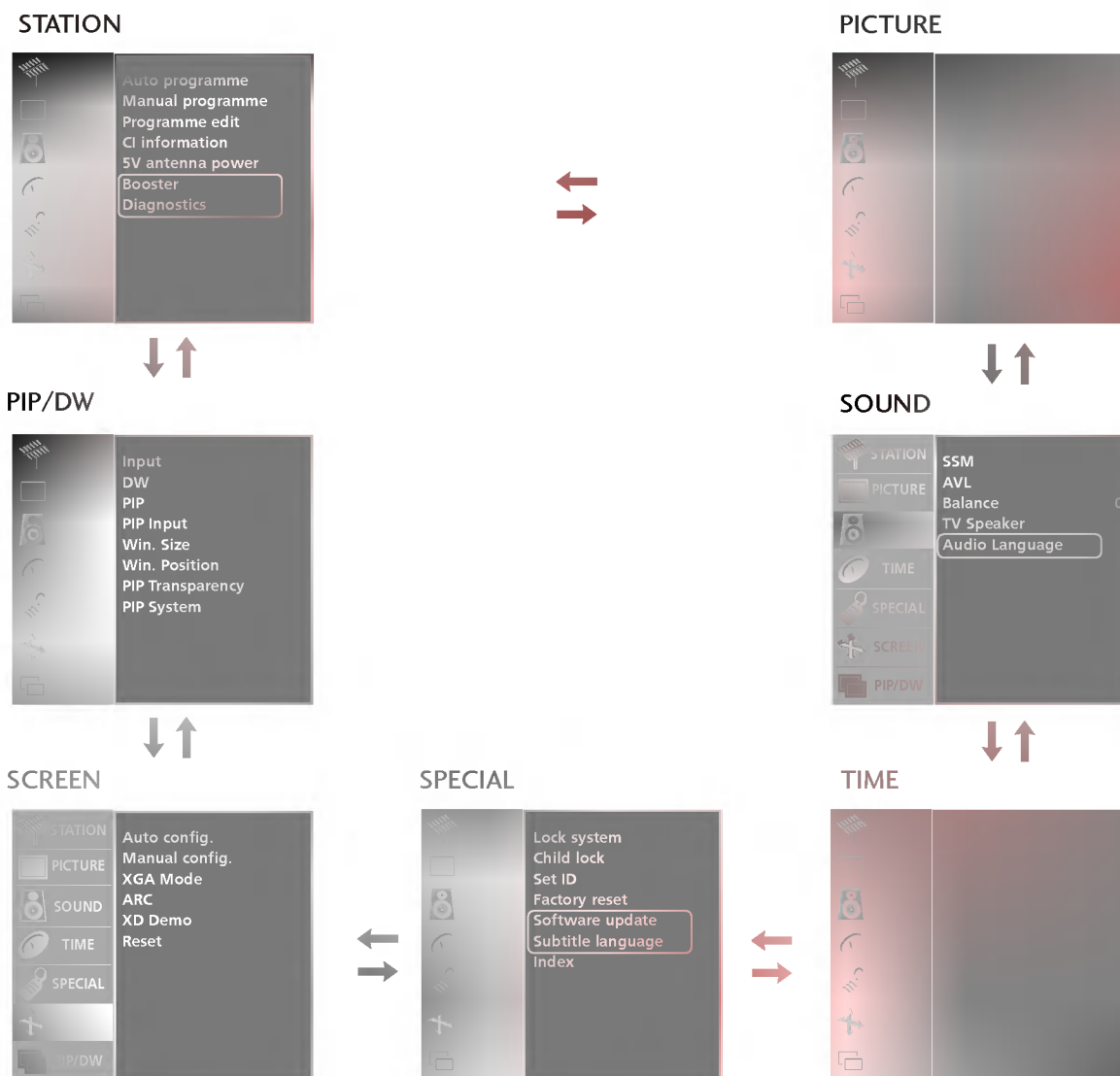

● NOTE

- ▶ In Analogue mode, 5V antenna power, CI information, Booster, Diagnostics, Audio Language, Software update and Subtitle language will not display.
- ▶ In Digital mode, Favourite programme will not display on the STATION menu.

TV MENU / STATION MENU OPTIONS

AUTO PROGRAMME - In Digital Mode

Use it to automatically find and store all of the programmes.
 When you start auto programming in digital mode, all the stored service information will be deleted.

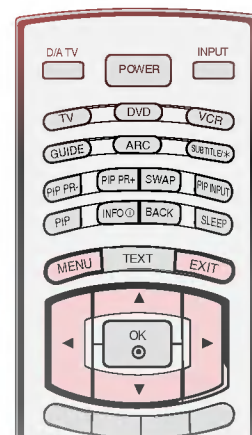

● Press the **MENU** button and then **▲** or **▼** button to select the **STATION** menu.

● Press the **▶** button and then **▲** or **▼** button to select button to select **Auto programme**.

● Press the **▶** button and then **▶** button to begin auto programming.

The message “All of service-information will be updated. Continue?” will appear.

If you want to keep on auto programming select **YES** with using the **◀** or **▶** button. Then, press the **OK** button. Otherwise select **NO**.

To stop auto programming, press the **MENU** button.

● Press the **EXIT** button to return to TV viewing or press the **MENU** button to return to the previous menu.

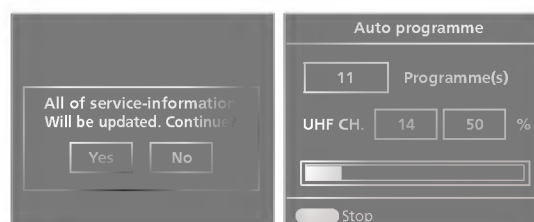
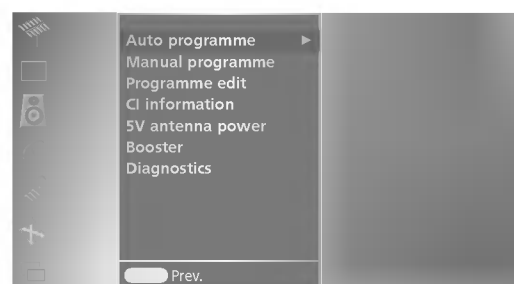
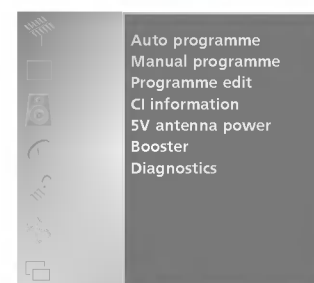

MANUAL PROGRAMME TUNING - In Digital Mode

Manual programme lets you manually add a programme to your programme list.

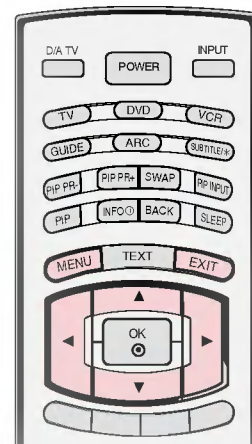

Press the **MENU** button and then ▲ or ▼ button to select the **STATION** menu.

Press the ► button and then ▲ or ▼ button to select **Manual programme**.

Press the ► button and then ▲ or ▼ button or **NUMBER** buttons to select the desired channel number.

Press the **OK** button to save.

When the channel number you want to add is already added in programme list, the message “Service-information of the channel will be updated. Continue?” will appear.

If you want to keep on manual programming, select **YES** with using the◀ or ► button.

Then, press the **OK** button. Otherwise select NO.

Press the **EXIT** button to return to TV viewing or press the **MENU** button to return to the previous menu.

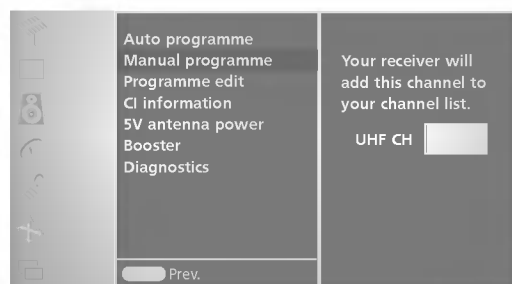
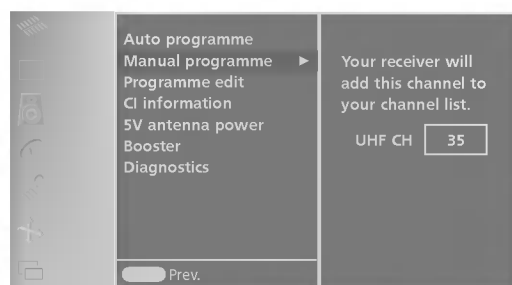
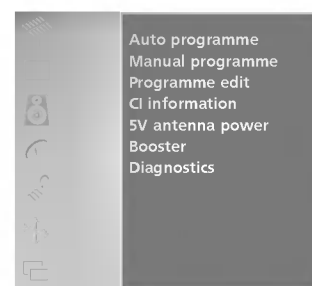

TV MENU / STATION MENU OPTIONS

PROGRAMME EDIT - *In Digital Mode*

When a programme number is skipped, it means that you will be unable to select it using PR ▲ or ▼ button during TV viewing.

If you want to select the skipped programme, directly enter the programme number with the NUMBER buttons or select it in the Programme edit menu.

This function enables you to skip the stored programmes.

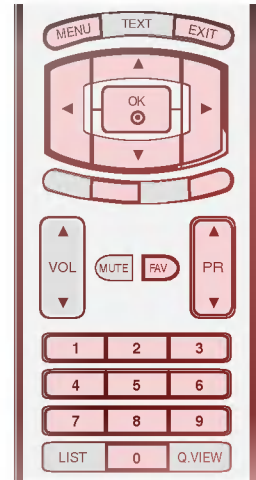

● Press the **MENU** button and then ▲ or ▼ button to select the **STATION** menu.

● Press the ► button and then ▲ or ▼ button to select **Programme edit**.

● Press the ► button to enter the Programme edit menu.





● Select a programme to be stored or skipped with the ▲▼◀▶ button.

● Press the **BLUE** button repeatedly to have the programme skipped or stored.

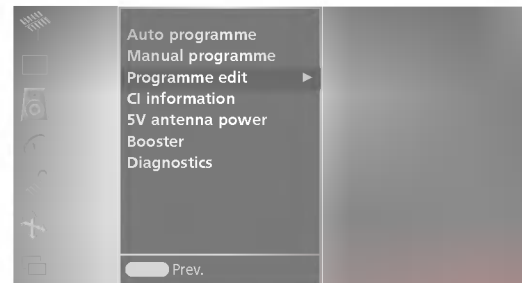
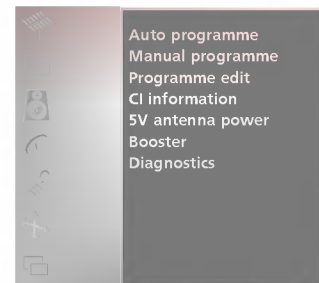
In case of programmes to be skipped, skipped programme shows in blue colour and these programmes will not be selected by the PR ▲ or ▼ buttons during TV viewing.

● Press the **EXIT** button to return to TV viewing or press the **MENU** button to return to the previous menu.



	Displayed when the TV Programme.
	Displayed when the Favourite Programme.
	Displayed when the Locked Programme.
	Displayed when the Radio Programme.
	Displayed when the Teletext Programme.

■ Skipping a programme number

● Select a programme number to be skipped with the ▲ ▼ ◀ ▶ button.

● Press the **BLUE** button. The skipped programme number turns to blue.

● Press the **BLUE** button again to release the skipped programme.

When a programme number is skipped it means that you will be unable to select it using the **PR** ▲ or ▼ button during normal TV viewing.

If you want to select the skipped programme, directly enter the programme number with the **NUMBER** buttons or select it in the programme edit or EPG.

● Press the **EXIT** button to return to TV viewing or press the **MENU** button to return to the previous menu.

■ Locking a programme (In Lock System On mode only)

● Select a programme to be locked with the ▲ ▼ ◀ ▶ button.

● Press the **GREEN** button. The lock mark will appear in front of that programme number.

● Press the **GREEN** button again to release this function.

Note :

- ▶ To watch a locked programme, input a 4-digit password in Lock system. Be sure to remember this number!
- ▶ If you forgot your password, press '7', '7', '7', '7' on the remote control handset.
- ▶ If you select other programme after releasing a locked programme and then return to the locked programme within 1 minute, you needn't input a password to select the locked programme.

■ Selecting favourite programme

● Select your favourite programme number by pressing ▲ ▼ ◀ ▶ button and then press the **FAV** button on your remote control handset.

It will automatically include the selected programme into your favourite programme list and heart-mark will appear in front of that programme number.

TV MENU / STATION MENU OPTIONS

CI [COMMON INTERFACE] INFORMATION

- In Digital Mode only

This function enables you to watch some scrambled services (pay services). If you remove the CI Module, you can't watch the pay services. When the module is inserted to CI slot, you can access the module menu.

To purchase a module and smart card, contact your supplying dealer. Do not often insert or remove a CAM module from the set. It may cause a trouble. When the set turned on after inserting the CI Module, you often can't hear the sound.

There might be unnatural picture according to CI module and smart card.

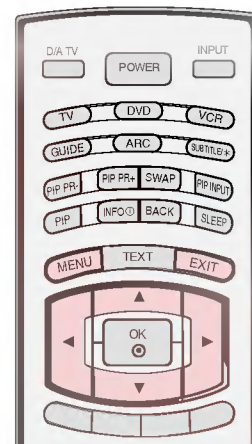

● Press the **MENU** button and then ▲ or ▼ button to select the **STATION** menu.

● Press the ► button and then ▲ or ▼ button to select **CI Information**.

● Press the ► button and then ► button.

● Press the ▲ or ▼ button to select the desired item: Module information, smart card information, language, or software download etc.

● Press the **OK** button.

● Press the **EXIT** button to return to TV viewing.

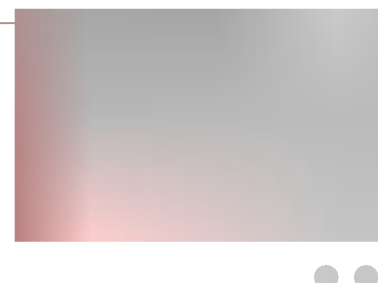
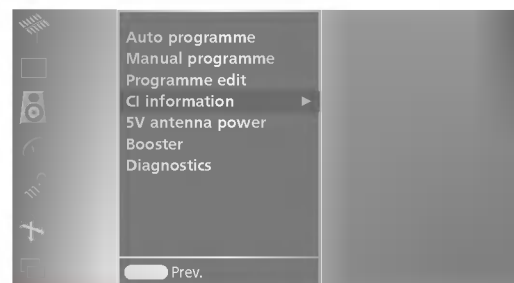
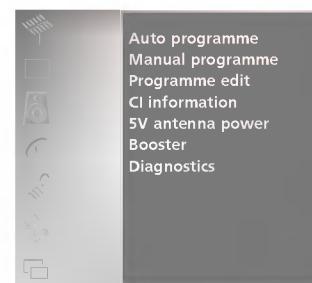

• This OSD is only for illustration and the menu options and screen format will vary according to the Digital pay services provider.

• It's possible for you to change CI (Common Interface) menu screen and service by your dealer.

TV MENU / STATION MENU OPTIONS

5V ANTENNA POWER - *In Digital Mode only*

Even if there isn't a special 5V adapter power in the external antenna, this function can output 5V in the set.

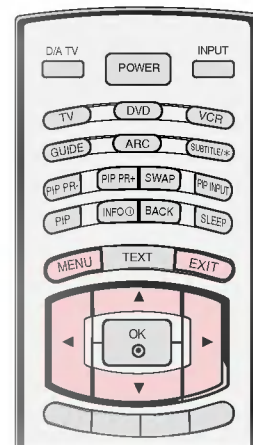

● Press the **MENU** button and then ▲ or ▼ button to select the **STATION** menu.

● Press the ► button and then ▲ or ▼ button to select **5V antenna power**.

● Press the ► button and then use ▲ or ▼ button to select **On** or **Off**.

In **5V antenna power On**, if the set is short-circuit, it will automatically return to **Off**.

The message "**Antenna feed overloaded. Automatically switched off.**" will appear.

● Press the **EXIT** button to return to TV viewing.

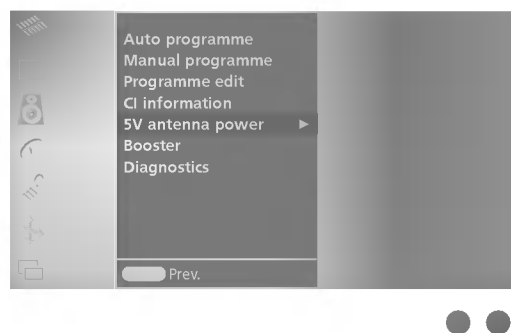
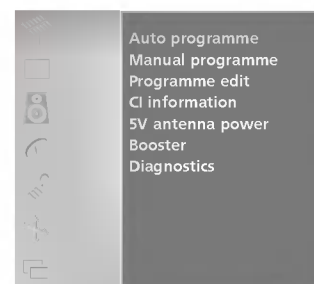

TV MENU / STATION MENU OPTIONS

BOOSTER - *In Digital Mode only*

If the reception is poor at the fringe area of TV signal, select **Booster** to **On**.

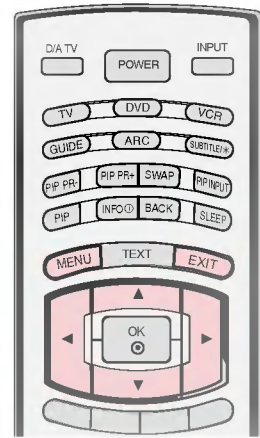

● Press the **MENU** button and then ▲ or ▼ button to select the **STATION** menu.

● Press the ► button and then use ▲ or ▼ button to select **Booster**.

● Press the ► button and then use ▲ or ▼ button to select **On** or **Off**.

● Press the **EXIT** button to return to TV viewing.

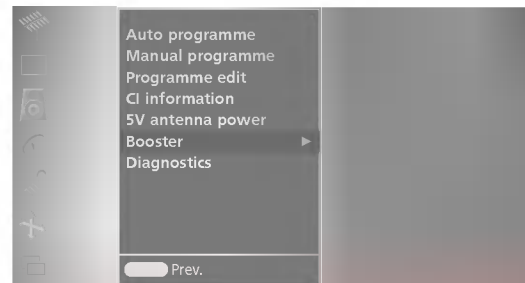
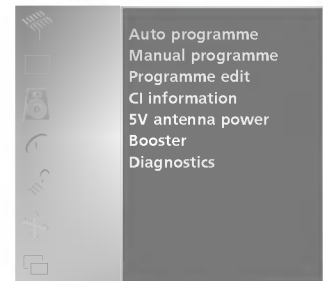

TV MENU / STATION MENU OPTIONS

DIAGNOSTICS - In Digital Mode only

This function enables you to watch Manufacturer, Model/Type, Serial Number and Software Version.

It's displayed the information and signal strength of the turned MUX.

It's displayed the signal information and service name of the selected MUX.

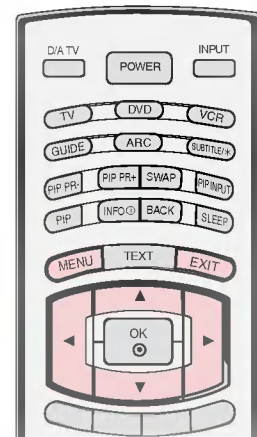

- Press the **MENU** button and then ▲ or ▼ button to select the **STATION** menu.

- Press the ► button and then use ▲ or ▼ button to select **Diagnostics**.

- Press the ► button to display Manufacturer, Model/Type, Serial Number and Software Version.

- Press the **EXIT** button to return to TV viewing.

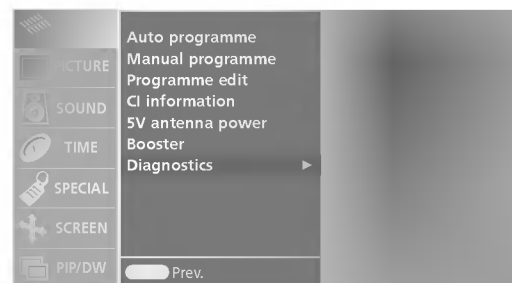
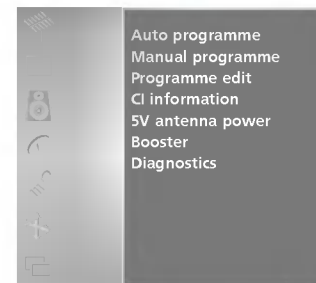

TV MENU / STATION MENU OPTIONS

TV MENU / STATION MENU OPTIONS

AUTO PROGRAMME TUNING - *In Analogue Mode*

All stations that can be received are stored by this method. It is recommended that you use auto programme during installation of this set.

- Press the **MENU** button and then ▲ or ▼ button to select the **STATION** menu.
- Press the ► button and then use ▲ or ▼ button to select Auto programme.
- Press the ► button to select System. Select a TV system with the ◀ or ► button;

L : SECAM L/L' (France)

BG : PAL B/G, SECAM B/G (Europe / East Europe / Asia / New Zealand / M.East / Africa / Australia)

I : PAL I/II (U.K. / Ireland / Hong Kong / South Africa)

DK : PAL D/K, SECAM D/K (East Europe / China / Africa / CIS)

- Press the ▼ button to select **Storage from**.

Select the beginning programme number with the ◀ or ► button or **NUMBER** buttons on the Storage from menu.

- Press the ▼ button to select **Start**.

The station name is stored for stations which broadcast VPS (Video Programme Service), PDC (Programme Delivery Control) or TELETEXT data.

If no station name can be assigned to a station, the channel number is assigned and stored as C (V/UHF 01-69) or S (Cable 01-47), followed by a number.

To stop auto programming, press the **MENU** button.

When auto programming is completed, the **Programme edit** menu appears on the screen.

See the '**Programme edit**' section to edit the stored programme.

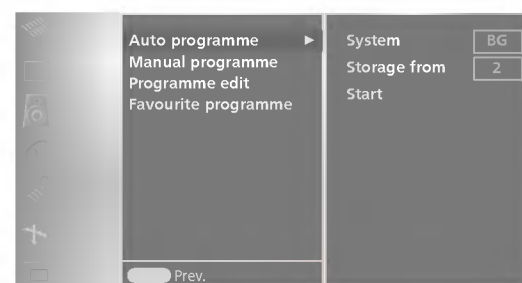
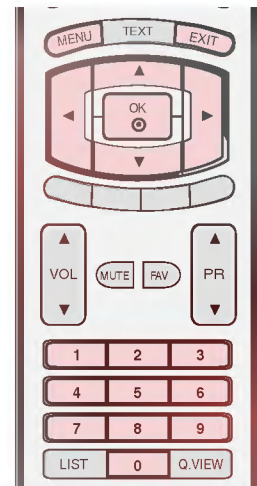

MANUAL PROGRAMME TUNING - In Analogue Mode

Manual programme lets you manually tune and arrange the stations in whatever order you desire. Also you can assign a station name with five characters to each programme number.

● Press the **MENU** button and then **▲** or **▼** button to select the **STATION** menu.

● Press the **▶** button and then use **▲** or **▼** button to select **Manual programme**.

● Press the **▶** button to select **Storage**.

Select the desired programme number with the **◀** or **▶** button or **NUMBER** buttons on the Storage menu.

● Press the **▼** button to select System. Select a TV system with the **◀** or **▶** button;

L: SECAM L/L' (France)

BG: PAL B/G, SECAM B/G (Europe / East Europe / Asia / New Zealand / M.East / Africa / Australia)

I: PAL I/II (U.K. / Ireland / Hong Kong / South Africa)

DK: PAL D/K, SECAM D/K (East Europe / China / Africa / CIS)

● Press the **▼** button to select **Band**. Press the **◀** or **▶** button to select **V/UHF** or **Cable** as required.

● Press the **▼** button to select **Channel**. You can select the desired channel number with the **◀** or **▶** button or **NUMBER** buttons.

If possible, select the channel number directly with the **NUMBER** buttons.

● Press the **▼** button to select Search. Press the **◀** or **▶** button to commence searching. If a station is found the search will stop.

● Press the **OK** button to store it.

● To store another station, repeat steps 3 to 8.

● Press the **EXIT** button to return to TV viewing or press the **MENU** button to return to the previous menu.

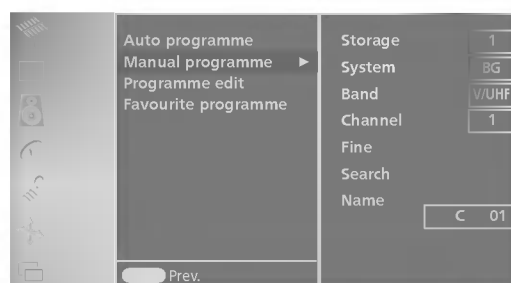
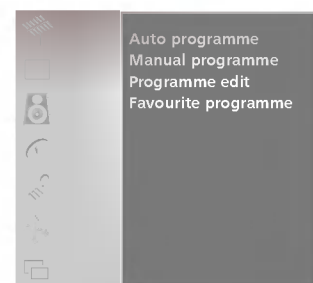
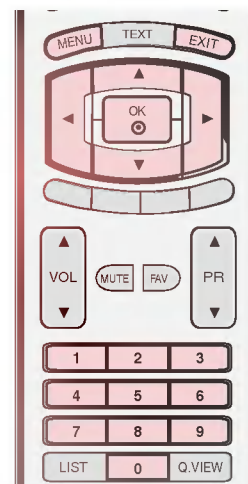

TV MENU / STATION MENU OPTIONS

FINE TUNING - *In Analogue Mode*

Normally fine tuning is only necessary if reception is poor. The finely tuned programme will be indicated by a yellow number during programme selection.

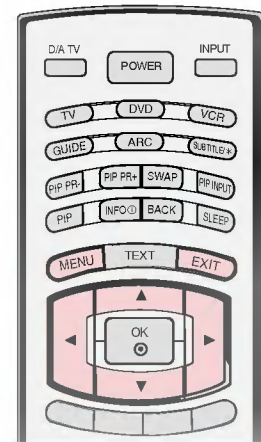

- Press the **MENU** button and then ▲ or ▼ button to select the **STATION** menu.

- Press the ► button and then use ▲ or ▼ button to select **Manual programme**.

- Press the ► button and then use ▲ or ▼ button to select **Fine**.

- Press the ► button and then ◀ or ▶ button to fine tune for the best picture and sound.

- Press the **OK** button to store it.

- Press the **EXIT** button to return to TV viewing or press the **MENU** button to return to the previous menu.



ASSIGNING A STATION NAME - In Analogue Mode

You can assign a station name with five characters to each programme number.

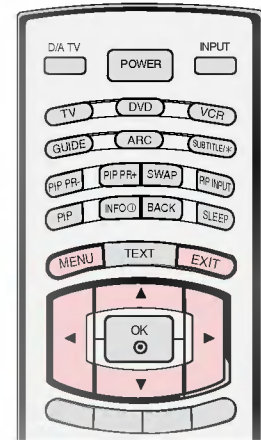

- Press the **MENU** button and then ▲ or ▼ button to select the **STATION** menu.
- Press the ► button and then use ▲ or ▼ button to select **Manual programme**.
- Press the ► button and then use ▲ or ▼ button to select **Name**.
- Press the ► button and then use ▲ or ▼ button. You can use the alphabet **A** to **Z**, the number **0** to **9**, **+/-**, and blank.
- Press the ◀ or ▶ button to select the position and make your choice of the second character, and so on.
- Press the **OK** button to store it.
- Press the **EXIT** button to return to TV viewing or press the **MENU** button to return to the previous menu.



TV MENU / STATION MENU OPTIONS

PROGRAMME EDIT - *In Analogue Mode*

This function enables you to delete or skip the stored programmes. Also you can move some stations to other programme numbers or copy a blank station data into the selected programme number.

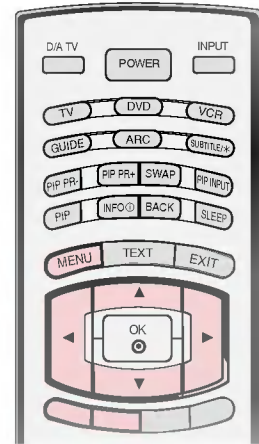

- Press the **MENU** button and then **▲** or **▼** button to select the **STATION** menu.
- Press the **▶** button and then **▲** or **▼** button to select **Programme edit**.
- Press the **▶** button.



■ Deleting a programme

- Select a programme to be deleted with the **▲▼◀▶** button.
- Press the **RED** button twice. The selected programme is deleted, all the following programmes are shifted up one position.



■ Copying a programme

- Select a programme to be copied with the **▲▼◀▶** button.
- Press the **GREEN** button. All the following programmes are shifted down one position.



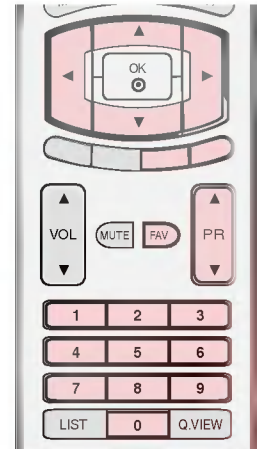

■ Moving a programme

- Select a programme to be moved with ▲▼◀▶ button.
 - Press the **YELLOW** button.
 - Move the programme to the desired programme number with the ▲▼◀▶ button.
 - Press the **YELLOW** button again to release this function.
-

■ Skipping a programme number

- Select a programme number to be skipped with ▲▼◀▶ button.
 - Press the **BLUE** button. The skipped programme number turns to blue.
 - Press the **BLUE** button to release the skipped programme.
 - When a programme number is skipped it means that you will be unable to select it using the **PR** ▲ or ▼ button during normal TV viewing.
-

If you want to select the skipped programme, directly enter the programme number with the **NUMBER** buttons or select it in the programme edit or table menu.

■ Selecting Favourite Programme

- Select your favourite programme number with ▲▼◀▶ button.
 - Press the **FAV** button.
-

The selected programme will be added to the favourite programme list and heart-mark will appear in front of that programme number.

TV MENU / STATION MENU OPTIONS

FAVOURITE PROGRAMME- *In Analogue Mode*

This function lets you select your favourite programmes directly.

Repeatedly press the FAV button to select stored favourite programmes.

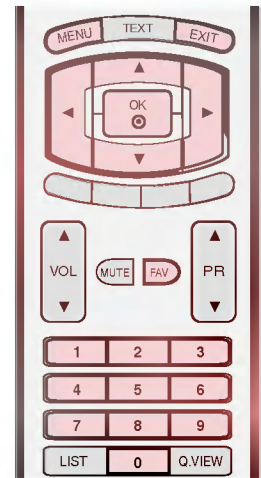

- Press the **MENU** button and then ▲ or ▼ button to the **STATION** menu.
- Press the ► button and then ▲ or ▼ button to select Favourite programme.
- Press the ► button and then ▲ or ▼ button to select - - - - -.
- Select a desired programme with the ◀▶ button or **NUMBER** buttons.

Any number under 10 is entered with a numeric '0' in front of it, i.e. '05' for 5.

- To store another programme, repeat steps 3 to 4.

You can store up to 18 programmes.

- Press the **EXIT** button to return to TV viewing or press the **MENU** button to return to the previous menu.



CALLING THE PROGRAMME TABLE

You can check the programmes stored in the memory by displaying the programme table.

■ Displaying programme LIST

- Press the **LIST** button to display the **PROGRAMME LIST** menu.

The programme list appears on the screen.

- You may find some blue programmes. They have been set up to be skipped by auto programming or in the programme edit mode.
- Some programmes with the channel number shown in the programme LIST indicate there is no station name assigned.

■ Selecting a programme in the programme list

- Select a programme with the **▲▼◀▶** button.
- Press the **OK** button. The set switches to the chosen programme number.

■ Paging through a programme list

There are 6 programme LIST pages which total contain 100 programmes.

- Press the **▲▼◀▶** button repeatedly to turns the pages.
- Press the **LIST** button to return to TV viewing.

■ Displaying favourite programme table

Press the **FAV** button to display the Favourite Programme table menu.

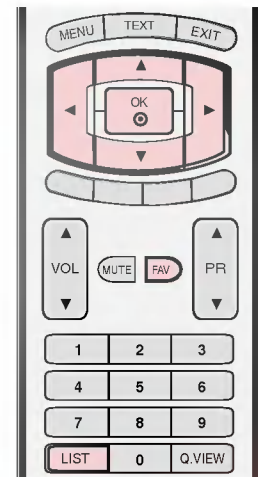

In Digital Mode

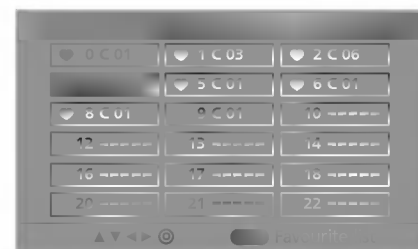

In Analogue Mode

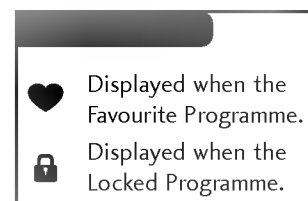

TV MENU / PICTURE MENU OPTIONS

PICTURE STATUS MEMORY (PSM)

PSM adjusts the set for the best picture appearance. Select the preset value in the PSM menu based on the programme category.

When adjusting User options (contrast, brightness, colour, and sharpness or tint) manually, PSM automatically changes to User 1/2.

Dynamic, Standard and Mild are programmed for optimum picture reproduction at the factory and cannot be changed.

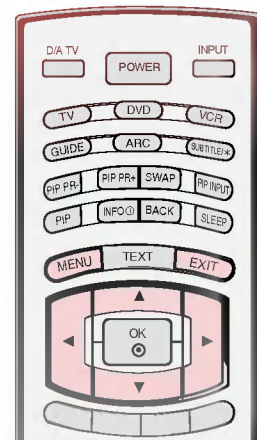

● Press the **MENU** button and then ▲ or ▼ button to select the **PICTURE** menu.

● Press the ► button and then ▲ or ▼ button to select **PSM**.

● Press the ► button and then ▲ or ▼ button to select **Intelligent Eye, Dynamic, Standard, Mild, User 1, or User 2**.

Intelligent Eye

The picture is automatically adjusted to most suitable according to the surrounding conditions.

Dynamic

Select this option to display with a sharp image.

Standard

The most general and natural screen display status.

Mild

Select this option to display with a mild image.

User 1/2

Select this option to use the user-defined setting.

● Press the **EXIT** button to return to TV viewing or press the **MENU** button to return to the previous menu.

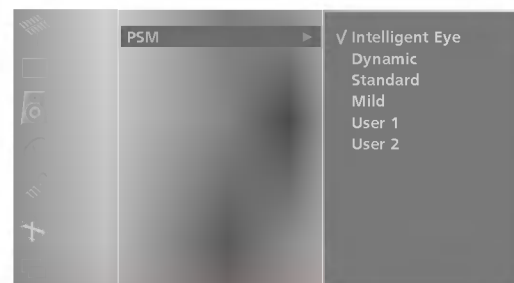
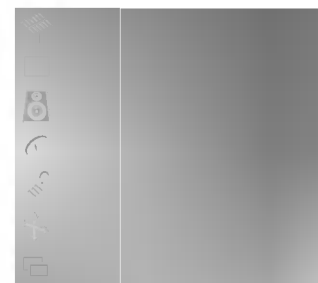

PICTURE ADJUSTMENT (PSM-USER OPTION)

You can adjust picture contrast, brightness, colour intensity, sharpness and tint to the levels you prefer.

- Press the **MENU** button and then **▲** or **▼** button to select the **PICTURE** menu.
- Press the **▶** button and then **▲** or **▼** button to select **PSM**.
- Press the **▶** button and then **▲** or **▼** button to select **User 1** or **User 2**.
- Press the **▶** button and then **▲** or **▼** button to select the desired picture option (**Contrast**, **Brightness**, **Colour**, **Sharpness**, or **Tint**).

Contrast

Adjusts the difference between the light and dark levels in the picture.

Brightness

Increases or decreases amount of white in the your picture.

Colour

Adjusts intensity of all colours.

Sharpness

Adjusts the level of crispness in the edges between the light and dark areas of the picture. The lower the level, the softer the image.

Tint

Adjusts the balance between red and green levels.

- Press the **▶** button and then **◀** or **▶** button to make appropriate adjustments.
- Press the **EXIT** button to return to TV viewing or press the **MENU** button to return to the previous menu.

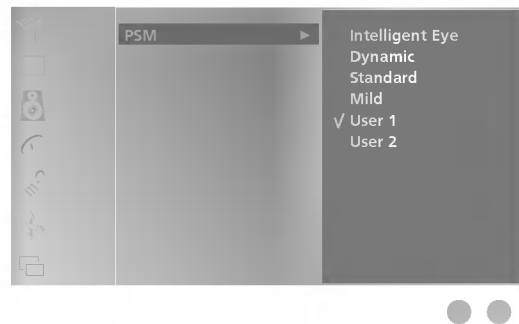
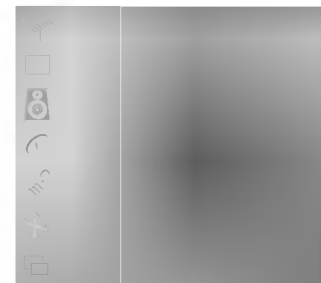
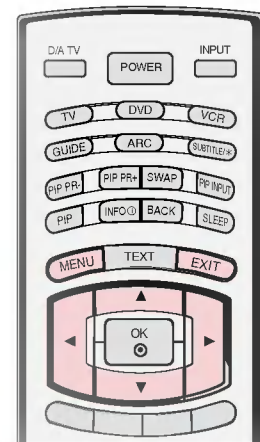

TV MENU / PICTURE MENU OPTIONS

COLOUR STATUS MEMORY (CSM)

To initialize values (reset to default settings), select the Normal option.

When adjusting colour temperature options (red, green, or blue) manually, CSM automatically changes to User.

Choose one of three automatic colour adjustments. Set to warm to enhance hotter colours such as red, or set to cool to see less intense colours with more blue.

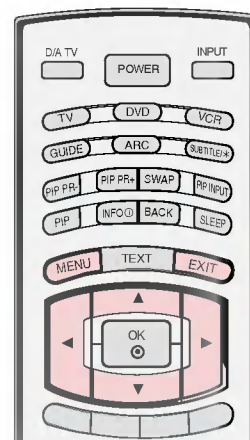

- Press the **MENU** button and then ▲ or ▼ button to select the **PICTURE** menu.
- Press the ► button and then ▲ or ▼ button to select **CSM**.
- Press the ► button and then ▲ or ▼ button to select either **Cool**, **Normal**, **Warm**, or **User**.
- Press the **EXIT** button to return to TV viewing or press the **MENU** button to return to the previous menu.



MANUAL COLOUR TEMPERATURE CONTROL (CSM - USER OPTION)

You can adjust red, green, blue to any colour temperature you prefer.

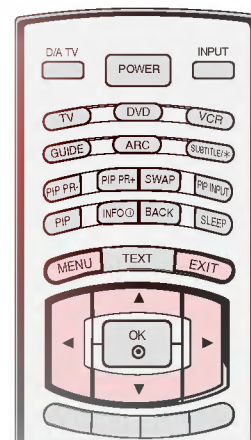

- Press the **MENU** button and then ▲ or ▼ button to select the **PICTURE** menu.
- Press the ► button and then ▲ or ▼ button to select **CSM**.
- Press the ► button and then ▲ or ▼ button to select **User**.
- Press the ► button and then ▲ or ▼ button to select **Red, Green, or Blue**.
- Press the ► button and then ◀ or ▶ button to make appropriate adjustments.
 - The adjustment range of **Red, Green, or Blue** is -40 ~ +40.
- Press the **EXIT** button to return to TV viewing or press the **MENU** button to return to the previous menu.

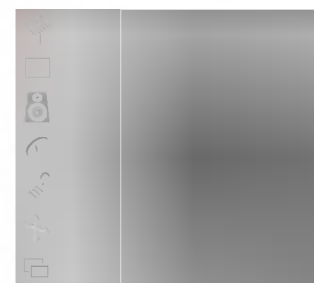

TV MENU / PICTURE MENU OPTIONS

XD FUNCTION

XD is LG Electronic's unique picture improving technology to display a real HD source through an advanced digital signal processing algorithm.

- Press the **MENU** button and then **▲** or **▼** button to select the **PICTURE** menu.
- Press the **▶** button and then **▲** or **▼** button to select **XD**.
- Press the **▶** button and then **▲** or **▼** button to select **On** or **Off**.
- Press the **EXIT** button to return to TV viewing or press the **MENU** button to return to the previous menu.

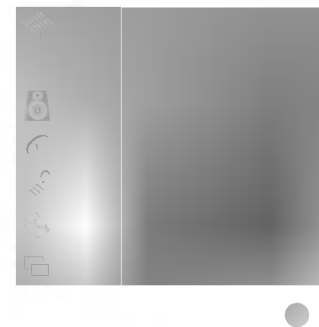
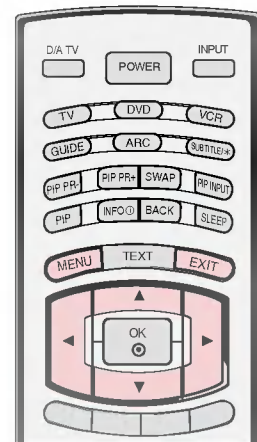

XD - USER OPTION

This function can adjust to select the desired skin colour option.

This function is not available for use in RGB[PC], HDMI[PC] mode.

It's not available to use this function in XD Off mode.

- Press the **MENU** button and then **▲** or **▼** button to select the **PICTURE** menu.
- Press the **▶** button and then **▲** or **▼** button to select **XD**.
- Press the **▶** button and then **▲** or **▼** button to select **On**.
- Press the **▶** button and then **▲** or **▼** button to select **Fleshtone**, **Greentone** or **Bluetone**.
- Press the **◀** or **▶** button to make appropriate adjustments.
 - The adjustment range of **Fleshtone**, **Greentone** or **Bluetone** is 0 ~ 3.
- Press the **EXIT** button to return to TV viewing or press the **MENU** button to return to the previous menu.

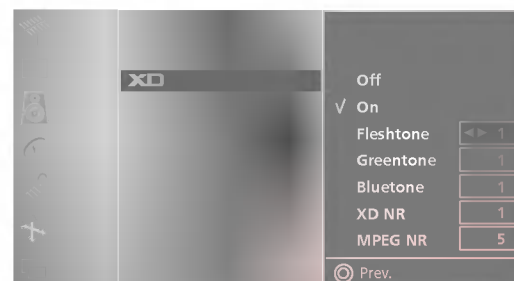
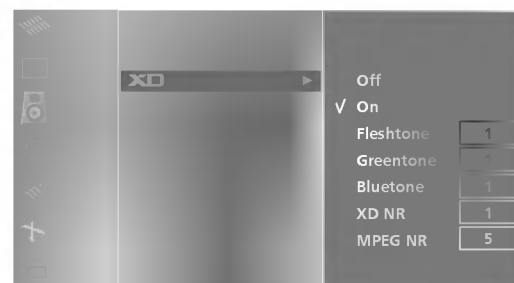

NR (NOISE REDUCTION)

You can select XD NR or MPEG NR to reduce the picture noise which may appear on the screen during watching the TV.

This function is not available for use in RGB[PC], HDMI[PC] mode.

It's not available to use this function in XD Off mode.

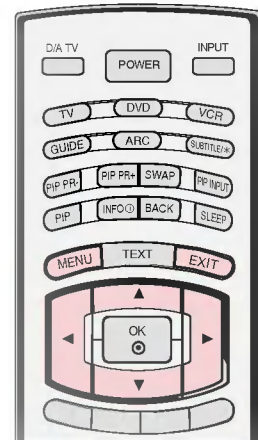

- Press the **MENU** button and then ▲ or ▼ button to select the **PICTURE** menu.
- Press the ► button and then ▲ or ▼ button to select **XD**.
- Press the ► button and then ▲ or ▼ button to select **On**.
- Press the ► button and then ▲ or ▼ button to select **XD NR** or **MPEG NR**.
- Press the ◀ or ▶ button to make appropriate adjustments.
- Press the **EXIT** button to return to TV viewing or press the **MENU** button to return to the previous menu.

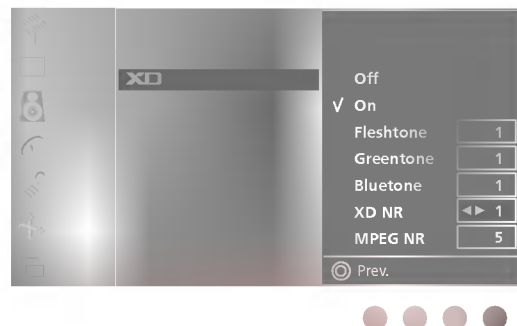
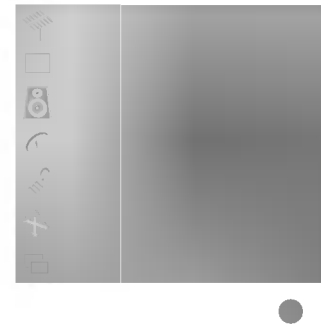

TV MENU / PICTURE MENU OPTIONS

ADVANCED - CINEMA

Set up the TV for the best picture appearance for viewing movies.

This function works in the following mode: TV, AV1, AV2, AV3, AV4, SAV2 or COMPONENT 480i/576i.

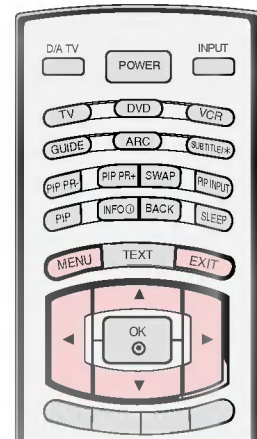

- Press the **MENU** button and then ▲ or ▼ button to select the **PICTURE** menu.

- Press the ► button and then ▲ or ▼ button to select **Advanced**.

- Press the ► button and then ▲ or ▼ button to select **Cinema**.

- Press the ◀ or ► button to select **On** or **Off**.

- Press the **EXIT** button to return to TV viewing or press the **MENU** button to return to the previous menu.

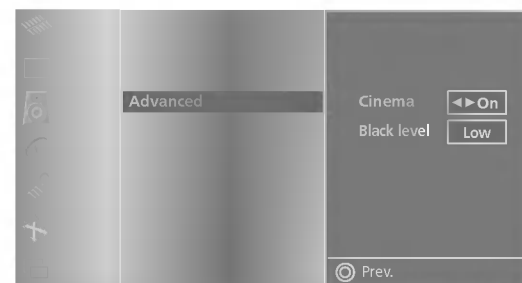
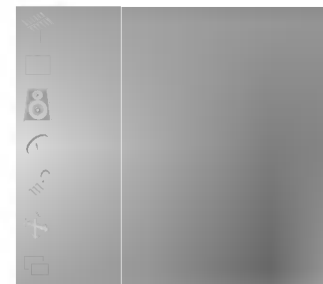

ADVANCED - BLACK LEVEL

Adjusting the contrast and brightness of the screen using the black level of the screen.

This function is available for use in HDMI mode.

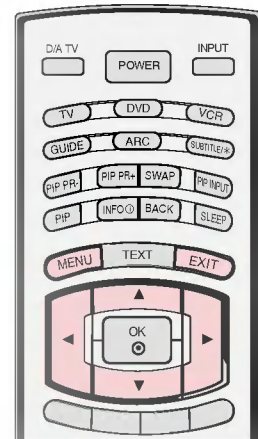

- Press the **MENU** button and then ▲ or ▼ button to select the **PICTURE** menu.
- Press the ► button and then ▲ or ▼ button to select **Advanced**.
- Press the ► button and then ▲ or ▼ button to select **Black level**.
- Press the ◀ or ▶ button to select **Low** or **High**.

Low

The reflection of the screen gets darker.

High

The reflection of the screen gets brighter.

- Press the **EXIT** button to return to TV viewing or press the **MENU** button to return to the previous menu.

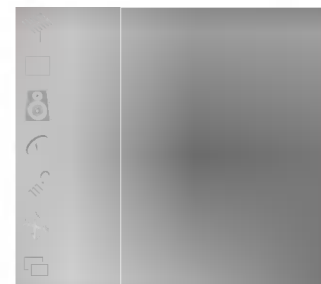

TV MENU / PICTURE MENU OPTIONS

RESET

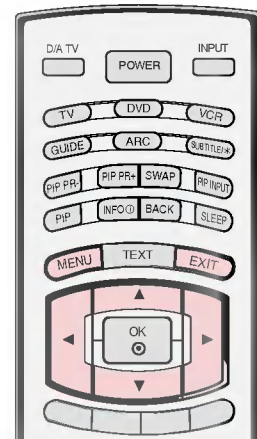

-
- Press the **MENU** button and then ▲ or ▼ button to select the **PICTURE** menu.

 - Press the ► button and then ▲ or ▼ button to select **Reset**.

 - Press the ► button to initialize the adjusted value.
 - You can initialize PSM, CSM, XD and Advanced.
-

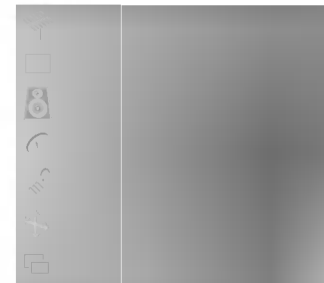

TV MENU / SOUND MENU OPTIONS

SOUND STATUS MEMORY (SSM)

You can select your preferred sound setting; Flat, Music, Movie or Sports and you can also adjust the sound frequency of the equalizer. SSM lets you enjoy the best sound without any special adjustment because the set sets the appropriate sound options based on the programme content.

When adjusting sound equalizer manually, SSM automatically switches User.

Flat, Music, Movie, and Sports are preset for good sound quality at the factory and are not adjustable.

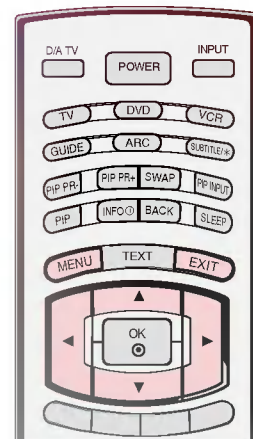

- Press the **MENU** button and then ▲ or ▼ button to select the **SOUND** menu.
- Press the ► button and then ▲ or ▼ button to select **SSM**.
- Press the ► button and then ▲ or ▼ button to select **SRS TSXT, Flat, Music, Movie, Sports, or User**.

- Flat** The most commanding and natural audio.
- Music** Select this option to enjoy the original sound when listening to the music.
- Movie** Select this option to enjoy sublime sound.
- Sports** Select this option to watch sports broadcasting.
- User** Select this option to use the user-defined audio settings.

- Press the **EXIT** button to return to TV viewing or press the **MENU** button to return to the previous menu.

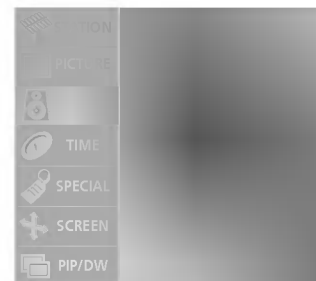

NOTE

- ▶  is a trademark of SRS Labs, Inc.
- ▶ TruSurround XT technology is incorporated under license from SRS Labs, Inc.

TV MENU / SOUND MENU OPTIONS

SOUND FREQUENCY ADJUSTMENT (SSM - USER OPTION)

Adjust the sound equalizer.

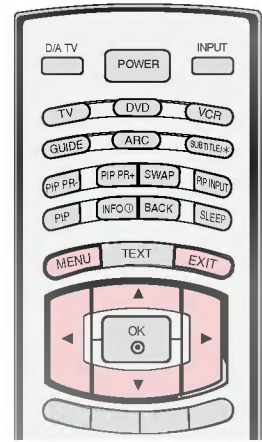

- Press the **MENU** button and then ▲ or ▼ button to select the **SOUND** menu.

- Press the ► button and then ▲ or ▼ button to select **SSM**.

- Press the ► button and then ▲ or ▼ button to select **User**.

- Press the ► button.

- Select a sound band by pressing the ▲ or ▼ button.
Make appropriate sound level with the ◀ or ▶ button.

- Press the **EXIT** button to return to TV viewing or press the **MENU** button to return to the previous menu.

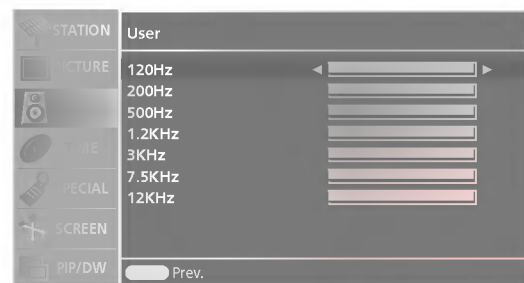
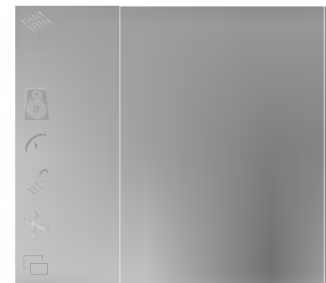

AUTO VOLUME LEVELER (AVL)

AVL automatically keeps on an equal volume level even if you change programmes.

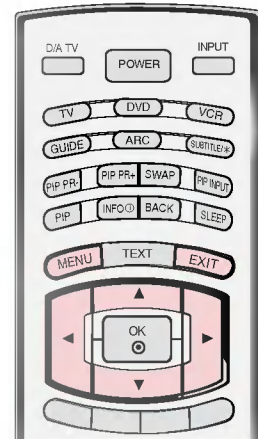

- Press the **MENU** button and then ▲ or ▼ button to select the **SOUND** menu.

- Press the ► button and then ▲ or ▼ button to select **AVL**.

- Press the ► button and then ▲ or ▼ button to select **Off** or **On**.

- Press the **EXIT** button to return to TV viewing or press the **MENU** button to return to the previous menu.

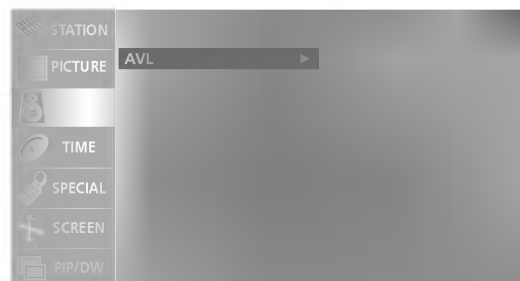
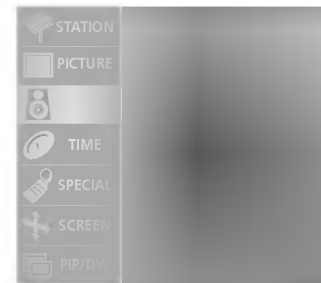

TV MENU / SOUND MENU OPTIONS

BALANCE ADJUSTMENT

You can adjust the sound balance of speaker to the levels you prefer.

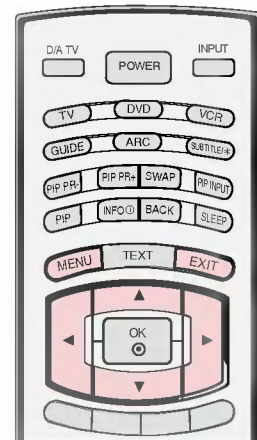

- Press the **MENU** button and then ▲ or ▼ button to select the **SOUND** menu.

- Press the ► button and then ▲ or ▼ button to select **Balance**.

- Press the ► button and then ◀ or ▶ button to make desired adjustment.

- Press the **EXIT** button to return to TV viewing or press the **MENU** button to return to the previous menu.

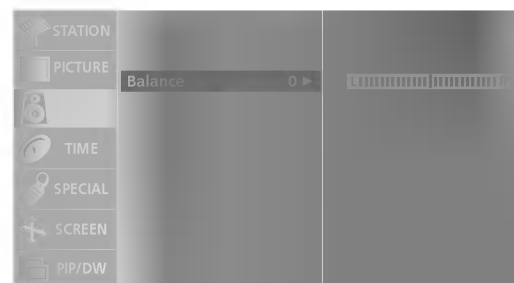
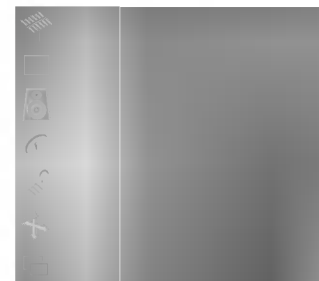

TV SPEAKER

You can adjust the internal speaker status.

In AV1, AV2, SAV2, AV3, AV4, COMPONENT, RGB, HDMI1/DVI, and HDMI2, TV speaker and/or variable audio can be outputted even though there is no video signal.

If you want to use your external hi-fi stereo system, turn off the internal speakers of the set.

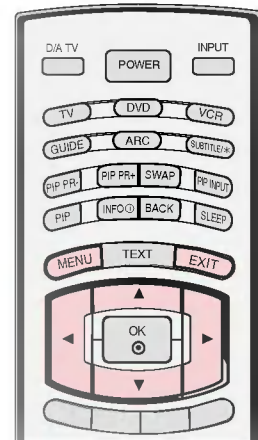

-
- Press the **MENU** button and then ▲ or ▼ button to select the **SOUND** menu.

 - Press the ► button and then ▲ or ▼ button to select **TV Speaker**.

 - Press the ► button and then ▲ or ▼ button to select **Off** or **On**.

 - Press the **EXIT** button to return to TV viewing or press the **MENU** button to return to the previous menu.
-

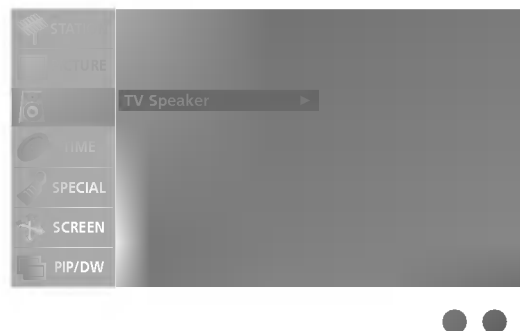
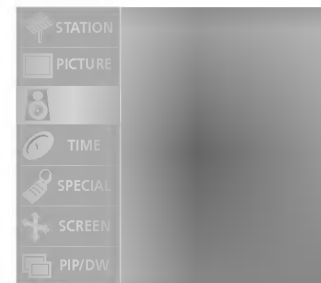

TV MENU / SOUND MENU OPTIONS

TV MENU / SOUND MENU OPTIONS

AUDIO LANGUAGE

- In Digital Mode only

This function lets you select your preferred language for audio.

If the audio data in selected language is not broadcasted, English audio will be played.

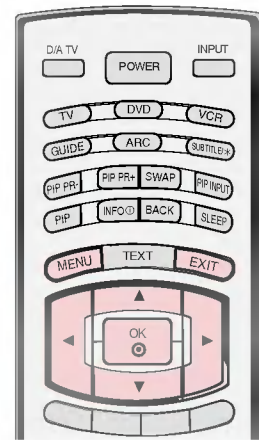

- Press the **MENU** button and then **▲** or **▼** button to select the **SOUND** menu.

- Press the **▶** button and then **▲** or **▼** button to select **Audio language**.

- Press the **▶** button and then **▲** or **▼** button to select **English, Welsh, or Gaelic**.

- Press the **EXIT** button to return to TV viewing or press the **MENU** button to return to the previous menu.

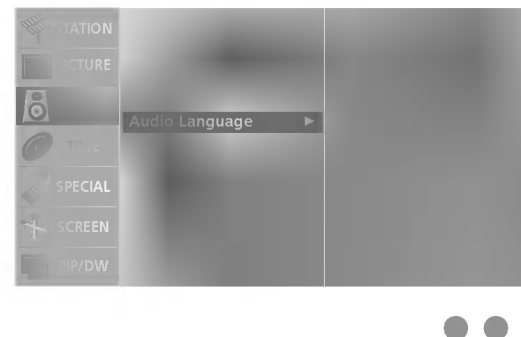

- When two or more audio languages are broadcasted, you can select audio language with the I/II button on the remote control.

- Press the **▲** or **▼** button to select an audio language.

- Press the **◀** or **▶** button to select L+R, L+L or R+R.



N.A	Not Available
Audio	Audio only service
	Audio for Visual Impaired
	Audio for Hearing Impaired

Notes: The audio which has not a language code will be displayed a 3 character.

TV MENU / SOUND MENU OPTIONS

STEREO/DUAL RECEPTION- *In Analogue Mode only*

When a programme is selected, the sound information for the station appears after the programme number and station name disappear.

Broadcast	On Screen Display
Mono	MONO
Stereo	STEREO
Dual	DUAL I

■ Mono sound selection

If the stereo signal is weak in stereo reception, you can switch to mono by pressing the I/II button twice.

In mono reception, the depth of sound is improved.

To switch back to stereo, press the I/II button twice again.

■ Language selection for dual language broadcast

If a programme received two languages (dual language), you can switch to DUAL I, DUAL II or DUAL I+II by pressing the I/II button repeatedly.

DUAL I Sends the primary broadcast language to the loudspeakers.

DUAL II Sends the secondary broadcast language to the loudspeakers.

DUAL I+II Sends a separate language to each loudspeaker.

NICAM RECEPTION- *In Analogue Mode only*

If the set is equipped with the receiver for NICAM reception, the high quality NICAM (Near Instantaneous Companding Audio Multiplex) digital sound can be received.

Sound output can be selected according to the type of received broadcast as follows by pressing the I/II button repeatedly.

- When NICAM mono is received, you can select NICAM MONO or MONO.
- When NICAM stereo is received, you can select NICAM STEREO or MONO. If the stereo signal is weak, switch to MONO.
- When NICAM dual is received, you can select NICAM DUAL I, NICAM DUAL II or NICAM DUAL I+II or MONO.

SPEAKER SOUND OUTPUT SELECTION

In AV1, AV2, SAV2, AV3, AV4, Component, RGB, HDMI1/DVI or HDMI2 mode, you can select output sound for the left and right loudspeakers.

- Repeatedly press the I/II button to select the sound output.
 - L+R: Audio signal from audio L input is sent to the left loud speaker and audio signal from audio R input is sent to the right loud speaker.
 - L+L: Audio signal from audio L input is sent to left and right loud speakers.
 - R+R: Audio signal from audio R input is sent to left and right loud speakers.

TV MENU / TIME MENU OPTIONS

CLOCK SETUP

The clock is set automatically when receiving the digital signal. (You can set the clock if the TV has no DTV signal.)

You must set to the time correctly before using on/off time function.

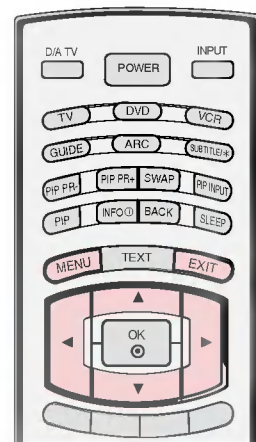

● Press the **MENU** button and then ▲ or ▼ button to select the **TIME** menu.

● Press the ► button and then ▲ or ▼ button to select **Clock**.

● Press the ► button and then ◀ or ▶ button to select either the year, date, or time option.

Once selected, use the ▲ or ▼ button to set the year, date, and time options.

● Press the **EXIT** button to return to TV viewing or press the **MENU** button to return to the previous menu.

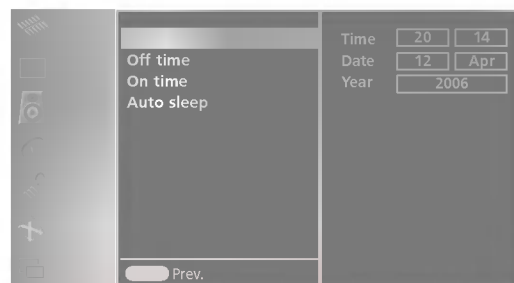
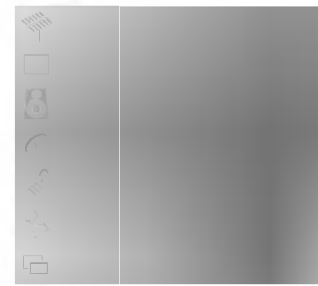

ON/OFF TIME

The Off time automatically switches the set to standby at the preset time.

Two hours after the set is switched on by the on time function it will automatically switch back to standby mode unless a button has been pressed.

Once the on time/off time is set, these functions operate daily at the preset time.

Off time function overrides On timer function if they are set both to the same time.

The set must be in standby mode for the On timer to work.

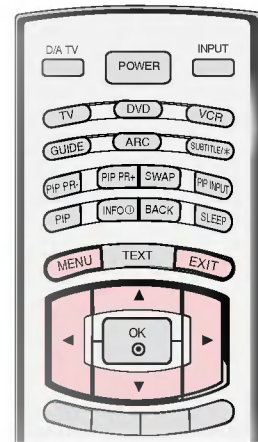

- Press the **MENU** button and then **▲** or **▼** button to select the **TIME** menu.
- Press the **▶** button and then **▲** or **▼** button to select **Off time/On time**.
- Press the **▶** button and then **▲** or **▼** button to select **On**.
 - To cancel **On/Off timer** function, select **Off**.
- Press the **▶** button and then **▲** or **▼** button to set the hour.
- Press the **▶** button and then **▲** or **▼** button to set the minutes.
- **For only On timer function**
 - **Programme:** Press the **▶** button and then **▲** or **▼** button to select TV or DTV. And then, Press the **▶** button and then **▲** or **▼** button to select the programme.
 - **Volume:** Press the **▶** button and then **▲** or **▼** button to adjust volume level at turn-on.
- Press the **EXIT** button to return to TV viewing or press the **MENU** button to return to the previous menu.

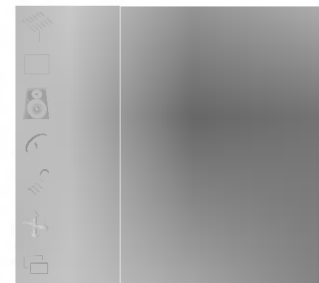

TV MENU / TIME MENU OPTIONS

AUTO SLEEP

If set to on and there is no input signal, the set turns off automatically after 10 minutes.

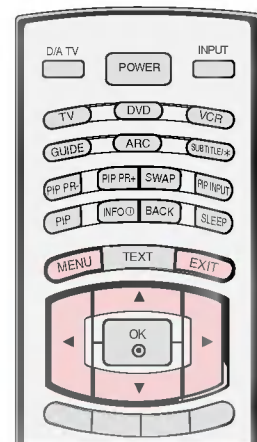

- Press the **MENU** button and then ▲ or ▼ button to select the **TIME** menu.

- Press the ► button and then ▲ or ▼ button to select **Auto sleep**.

- Press the ► button and then ▲ or ▼ button to select **Off** or **On**.

- Press the **EXIT** button to return to TV viewing or press the **MENU** button to return to the previous menu.

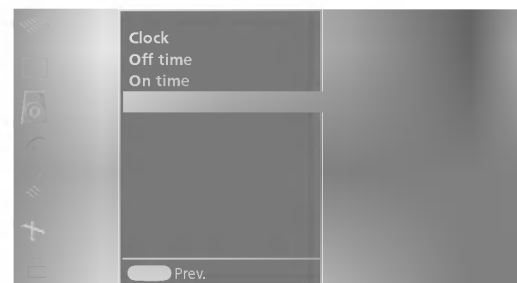
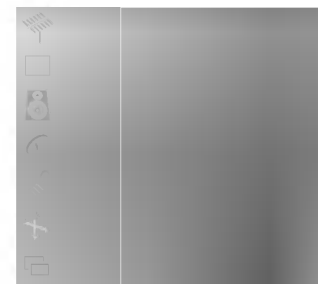

SLEEP TIMER

You don't have to remember to switch the set off before you go to sleep.

The sleep timer automatically switches the set to standby after the preset time has elapsed.

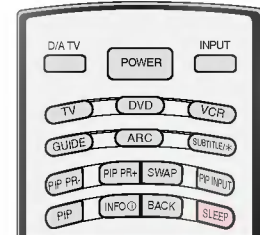

-
- Press the **SLEEP** button repeatedly to select the number of minutes.

.....

The display ' - - - Min ' will appear on the screen, followed by 10, 20, 30, 60, 90, 120, 180 and 240.

.....
 - When the number of minutes you want is displayed on the screen, the timer begins to count down from the number of minutes selected.

.....
 - To view the remaining sleep time, press the **SLEEP** button once.

.....
 - To cancel the sleep time, repeatedly press the **SLEEP** button until the display ' - - - Min ' appears.

.....
 - When you switch the set off, the set releases the preset sleep time.
-



TV MENU / SPECIAL MENU OPTIONS

SYSTEM LOCK SETTING

If you first enter the password, press '0', '0', '0', '0' on the remote control handset.

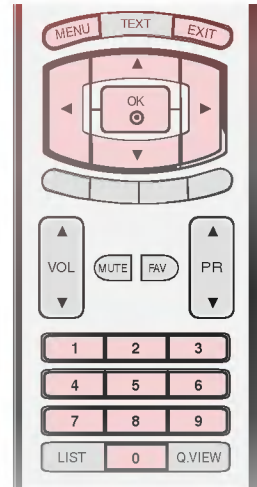

- Press the **MENU** button and then ▲ or ▼ button to select the **SPECIAL** menu.
- Press the ► button and then ▲ or ▼ button to select **Lock system**.
- Press the ► button and then ▲ or ▼ button to select **On**.

To set the password

Press the ► button and then use **NUMBER** buttons to input a 4-digit password.

Be sure to remember this number!

Re-enter new password for confirm.

If you forgot your password, press '7', '7', '7', '7' on the remote control handset.

- Press the **EXIT** button to return to TV viewing or press the **MENU** button to return to the previous menu.

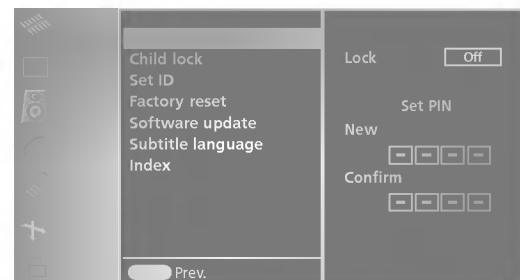
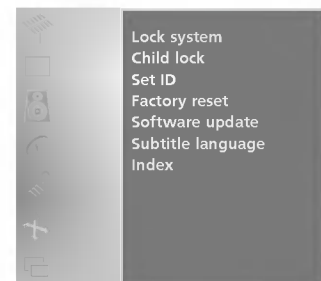

CHILD LOCK

The set can be set so that the remote control is needed to control it.

This feature can be used to prevent unauthorized viewing. This set is programmed to remember which option it was last set to even if you turn the set off.

- Press the **MENU** button and then **▲** or **▼** button to select the **SPECIAL** menu.
- Press the **▶** button and then **▲** or **▼** button to select **Child lock**.
- Press the **▶** button and then **▲** or **▼** button to select **Off** or **On**.

In **Child lock 'On'**, if the set is turned off, press the **⊙ / I**, **INPUT**, **PR ▲** or **▼** button on the set or **POWER**, **INPUT**, **D/A TV**, **PR ▲ ▼** or **NUMBER** buttons on the remote control.

With the **Child lock On**, the display '**▲ Child lock on**' appears on the screen if any button on the front panel is pressed while viewing the set.

- Press the **EXIT** button to return to TV viewing or press the **MENU** button to return to the previous menu.

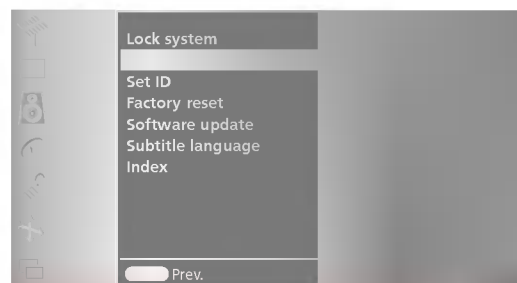
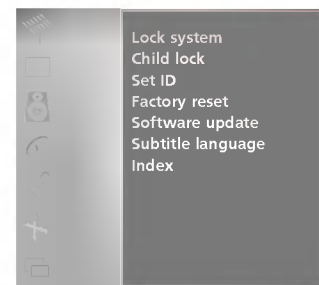
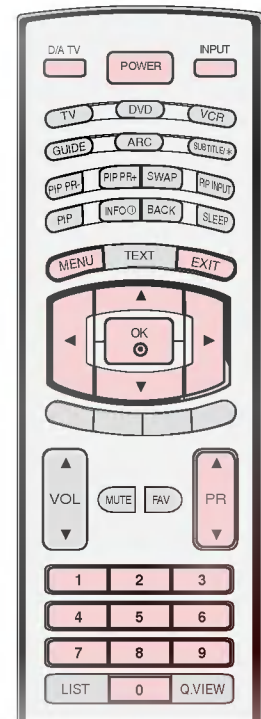

TV MENU / SPECIAL MENU OPTIONS

FACTORY RESET

Use to quickly reset all the menu options to their original factory preset values.

This function deletes all TV programmes.

To begin Factory Reset, input a 4-digit password in Lock system. Be sure to remember this number!

If you forgot your password, press '7', '7', '7', '7' on the remote control handset.

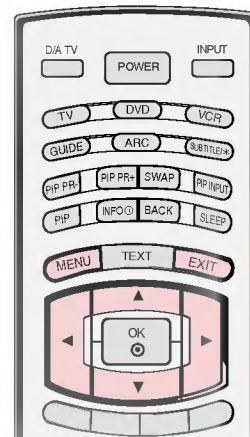

- Press the **MENU** button and then ▲ or ▼ button to select the **SPECIAL** menu.
- Press the ► button and then ▲ or ▼ button to select **Factory reset**.
- Press the ► button to reset the menu options to original values.

After finishing Factory Reset, the set will reboot.

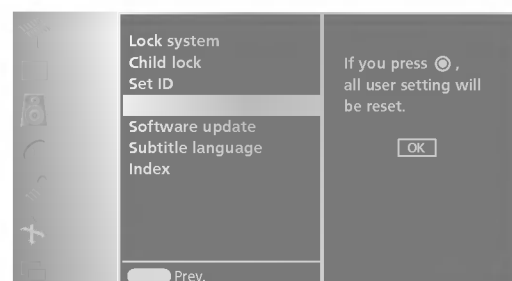
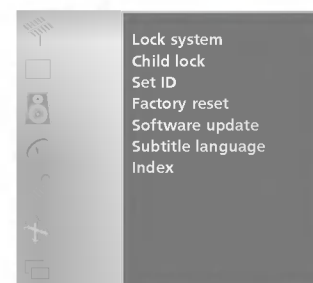

SOFTWARE UPDATE - *In Digital Mode only*

Software Update, means software can be downloaded through the digital terrestrial broadcasting system.

- Press the **MENU** button and then **▲** or **▼** button to select the **SPECIAL** menu.

- Press the **▶** button and then **▲** or **▼** button to select **Software update**.

- Press the **▶** button and then **▲** or **▼** button to select **Off** or **On**.
 - If you select **On**, a user confirm message box will be displayed to notify that new software is found.

- Press the **EXIT** button to return to TV viewing or press the **MENU** button to return to the previous menu.

* When setting "Software Update"



Occasionally, a transmission of updated digital software information will result in the following menu on the TV screen.



Select the **YES** using the **◀** or **▶** button and when you see the following picture.



After Software Update is completed, the System takes about one minute to restart.

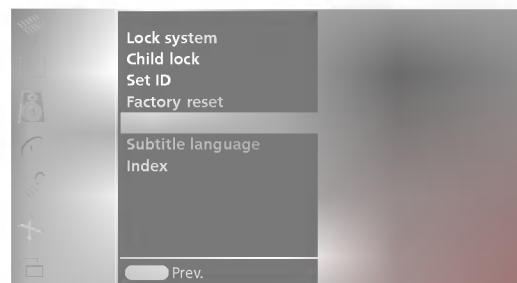
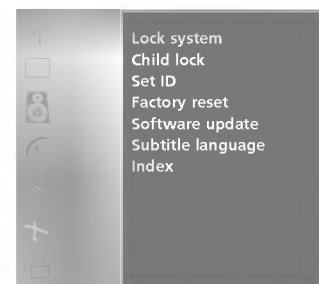
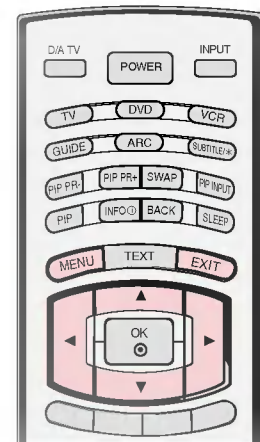

- During Progress of Software Update, please note the following:

- The power of the set must not be interrupted.
- The set must not be switched off.
- The antenna must not be disconnected.
- During this time, you should not switch off the power to the set.
- At this time, you should not work power On/Off.
- After Software Update, you can confirm the updated software version in Diagnostics menu.

TV MENU / SPECIAL MENU OPTIONS

SUBTITLE LANGUAGE - *In Digital Mode only*

If the subtitle data in selected language is not broadcasted, English subtitle will be displayed.

Use this function when two or more subtitle languages are broadcasted.

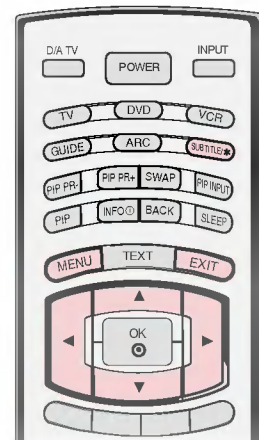

- Press the **MENU** button and then ▲ or ▼ button to select the **SPECIAL** menu.
 - Press the ► button and then ▲ or ▼ button to select **Subtitle language**.
 - Press the ► button and then ▲ or ▼ button to select **English, Welsh, or Gaelic**.
 - Press the **EXIT** button to return to TV viewing or press the **MENU** button to return to the previous menu.
- You can select Subtitle language with the **SUBTITLE/*** on the remote control. When two or more subtitle languages are broadcasted.

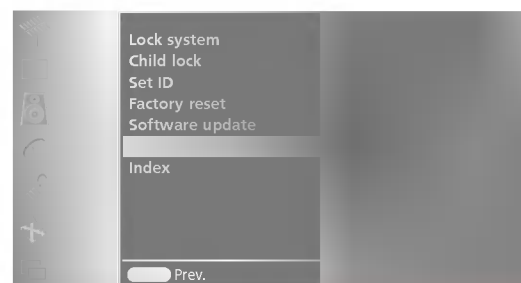
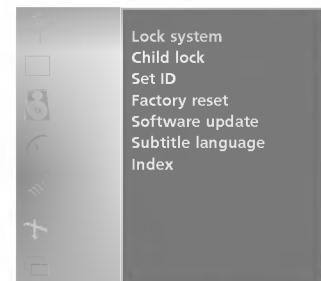

INDEX

Switches LED display on or off.

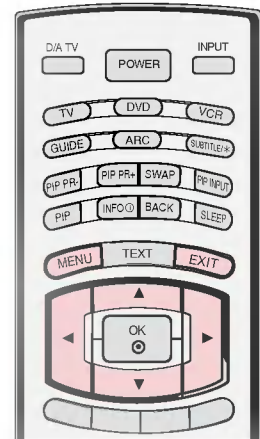

- Press the **MENU** button and then ▲ or ▼ button to select the **SPECIAL** menu.

- Press the ► button and then ▲ or ▼ button to select **Index**.

- Press the ► button and then ▲ or ▼ button to select **On** or **Off**.

If you select 'On', the LED Display illuminates brightly.

- Press the **EXIT** button to return to TV viewing or press the **MENU** button to return to the previous menu.

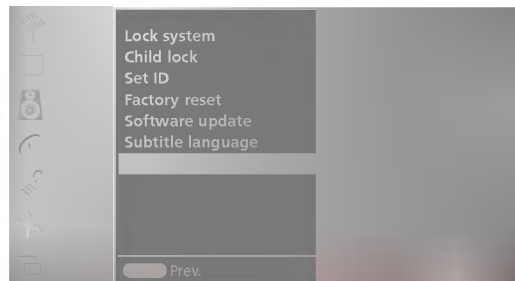
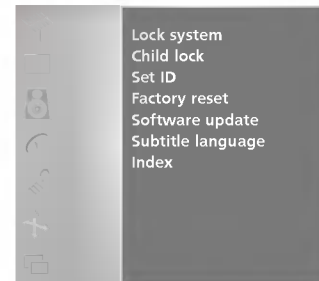

TV MENU / SPECIAL MENU OPTIONS

TV MENU / SCREEN MENU OPTIONS

AUTO CONFIGURE - RGB [PC] Mode Only

This function is for the automatic adjustment of the screen position, clock, and phase.

The displayed image will disappear for a few seconds while the auto configuration is in progress.

Although the image is still not correct, your set is functioning properly but needs further adjustment.

The Auto config. functions don't need to be run for HDMI mode.

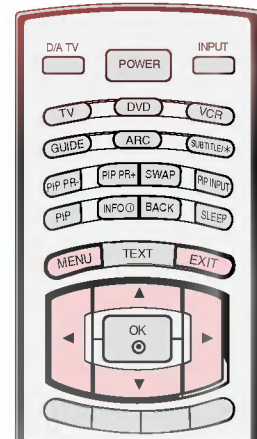

- Press the **MENU** button and then **▲** or **▼** button to select the **SCREEN** menu.

- Press the **▶** button and then **▲** or **▼** button to select **Auto config.**

- Press the **▶** button to start Auto config.

When Auto config. has finished, **OK** will be shown on screen.

If the position of the image is still not correct, try Auto adjustment again.

If picture needs to be adjusted more after Auto adjustment in RGB (PC), you can adjust the **Manual config.**

- Press the **EXIT** button to return to TV viewing or press the **MENU** button to return to the previous menu.

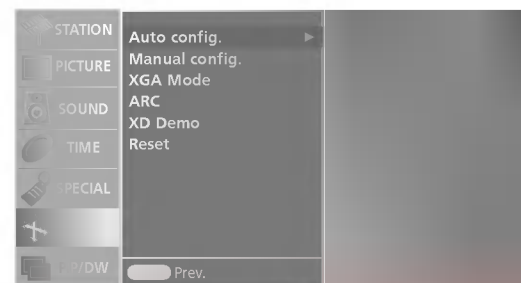

MANUAL CONFIGURE

If the picture isn't clear after auto adjustment and especially if characters are still trembling, adjust the picture phase manually.

To correct the screen size, adjust Clock.

- Press the **MENU** button and then **▲** or **▼** button to select the **SCREEN** menu.
- Press the **▶** button and then **▲** or **▼** button to select **Manual config.**
- Press the **▶** button and then **▲** or **▼** button to select **Phase, Clock, H-Position** or **V-Position**.

Clock This function is to minimize any vertical bars or stripes visible on the screen background. And the horizontal screen size will also change.

Phase This function allows you to remove any horizontal noise and clear or sharpen the image of characters.

- Press the **◀** or **▶** button to make appropriate adjustments.
- Press the **EXIT** button to return to TV viewing or press the **MENU** button to return to the previous menu.

NOTE

- ▶ This function works in the following mode : RGB[PC], RGB[DTV], COMPONENT (480p/576p/720p/1080i), HDMI (480p/576p/720p/1080i).
- ▶ It's not available to use Phase, Clock function in RGB[DTV], COMPONENT (480p/576p/720p/1080i), HDMI (480p/576p/720p/1080i) mode.

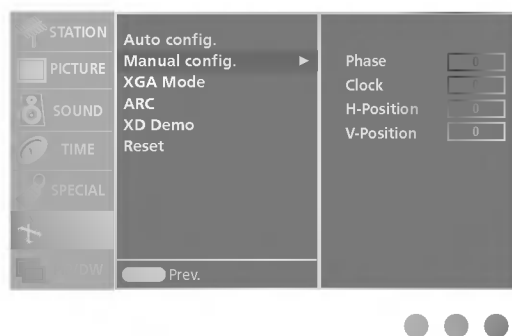
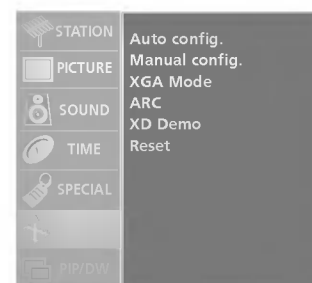
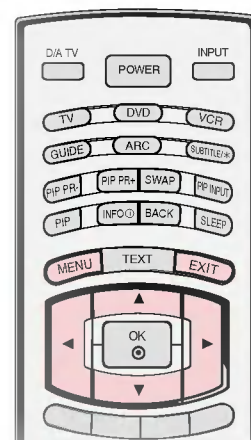

TV MENU / SCREEN MENU OPTIONS

SETTING THE PICTURE FORMAT

You can watch the screen in various picture formats; Spectacle, Full (option), Original, 4:3, 16:9 (Wide), 14:9 and Zoom.

If a fixed image is displayed on the screen for a long time, that fixed image may become imprinted on the screen and remain visible.

There might be uncomfortable in Full mode. Then change into other mode.

You can adjust the enlarge proportion of picture using ▲ or ▼ button.

● Press the **MENU** button and then use ▲ or ▼ button to select the **SCREEN** menu.

● Press the ► button and then use ▲ or ▼ button to select **ARC**.

● Press the ► button and then use ▲ or ▼ button to select Spectacle, Full (option), Original, 4:3, 16:9 (Wide), 14:9 or Zoom.

● Spectacle

When your set receives the wide screen signal, when selected it will adjust the picture horizontally, in non-linear proportion, to fill the entire screen.

● Full (option)

When your set receives the wide screen signal, when selected it will adjust the picture horizontally or vertically, in a linear proportion, to fill the entire screen fully.

● Original

When your set receives the wide screen signal, it will be automatically changed to the picture format to be sent.

● 4:3

Following selection will lead you to view a picture with an original 4:3 aspect ratio, with gray bars appearing at both the left and right sides.

● 16:9 (Wide)

Following selection will lead you to adjust the picture horizontally, in a linear proportion, to fill the entire screen (useful for viewing 4:3 formatted DVDs).

● 14:9

You can enjoy the picture format of 14:9 or general TV programme through the 14:9 mode. The screen 14:9 is viewed just like that the screen 4:3 is magnified to the left / right.

● Zoom

Following selection will lead you to view the picture without any alternation, while filling the entire screen. However, the top and bottom portions of the picture will be cropped.

● Press the **EXIT** button to return to TV viewing or press the **MENU** button to return to the previous menu.



● NOTE

- ▶ You can only select **4:3** and **16:9** (Wide) in RGB[PC], HDMI[PC] mode only.
- ▶ You can only select **4:3**, **16:9** (Wide) and **Zoom** in RGB[DTV], HDMI[DTV], Component [DTV] mode only.
- ▶ You can only select **Spectacle**, **Full**, **4:3**, **16:9** (Wide), **14:9** and **Zoom** in Component [480i/576i] mode only.

SELECTING WIDE XGA MODE

To see a normal picture, match the resolution of RGB mode and selection of XGA mode.

This function works in the following mode: RGB[PC] mode.

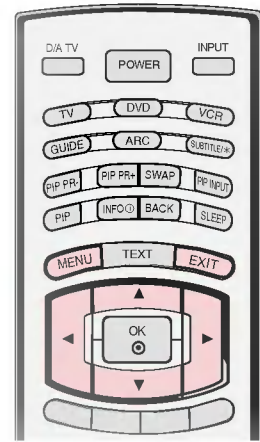

- Press the **MENU** button and then ▲ or ▼ button to select the **SCREEN** menu.

- Press the ► button and then ▲ or ▼ button to select **XGA Mode**.

- Press the ► button and then ▲ or ▼ button to select the desired XGA resolution.

- Press the **EXIT** button to return to TV viewing or press the **MENU** button to return to the previous menu.

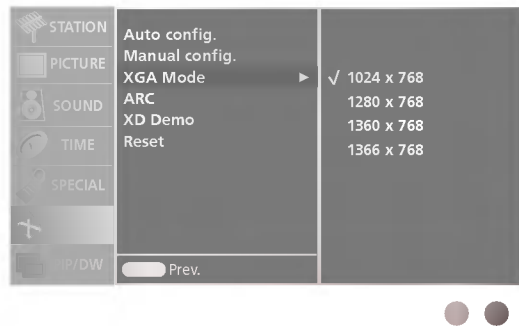

TV MENU / SCREEN MENU OPTIONS

XD DEMO

Use it to see the difference between XD demo on and XD Demo off.

It's not available to use this function in RGB[PC], HDMI[PC] mode.

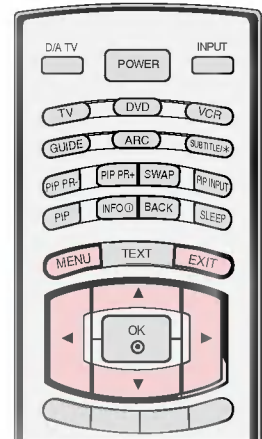

- Press the **MENU** button and then ▲ or ▼ button to select the **SCREEN** menu.

- Press the ► button and then ▲ or ▼ button to select **XD Demo**.

- Press the ► button to begin **XD Demo**.

- To stop XD Demo, press the **EXIT** button.

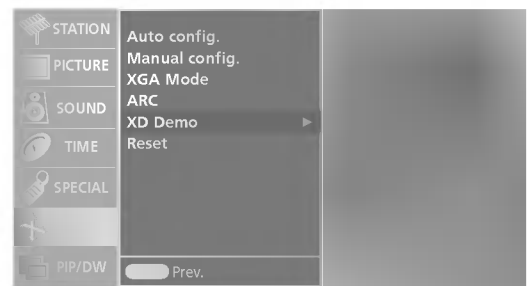

INITIALIZING (RESET TO ORIGINAL FACTORY SETTINGS)

This function operates in current mode.
To initialize the adjusted value

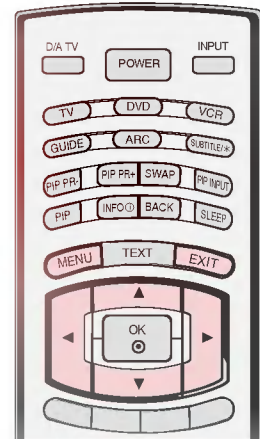

- Press the **MENU** button and then ▲ or ▼ button to select the **SCREEN** menu.

- Press the ► button and then ▲ or ▼ button to select **Reset**.

- Press the ► button.

You can initialize PIP size, PIP position, PIP Transparency and sub picture size of double window.

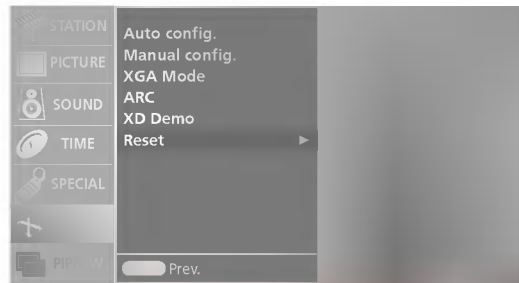

TV MENU / SCREEN MENU OPTIONS

APPENDIX

EXTERNAL CONTROL DEVICE SETUP

Connect the RS-232C (serial port) input jack to an external control device (such as a computer or an A/V control system) to control the product's functions externally.

Connect the serial port of the control device to the RS-232C jack on the product back panel.

Note: RS-232C connection cables are not supplied with the product.

RS-232C Setup

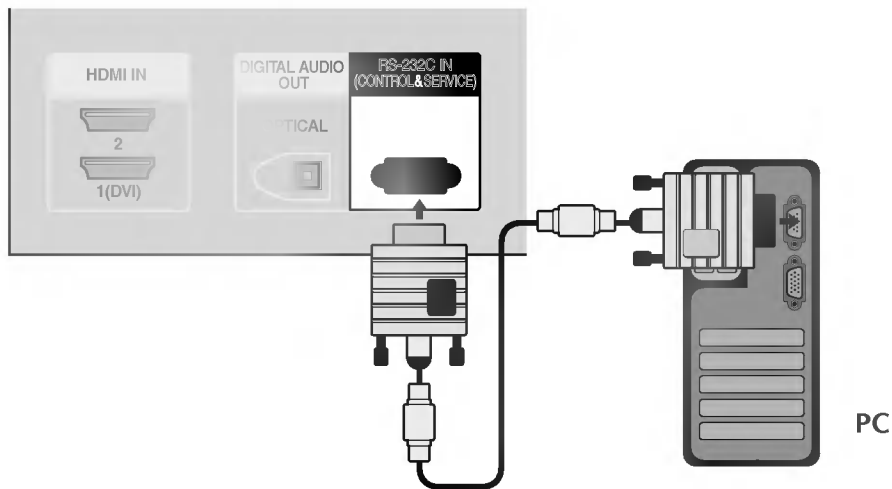

Type of Connector; D-Sub 9-Pin Male

1	No connection
2	RXD (Receive data)
3	TXD (Transmit data)
4	DTR (DTE side ready)
5	GND
6	DSR (DCE side ready)
7	RTS (Ready to send)
8	CTS (Clear to send)
9	No Connection

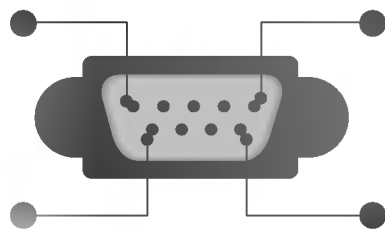

RS-232C Configurations

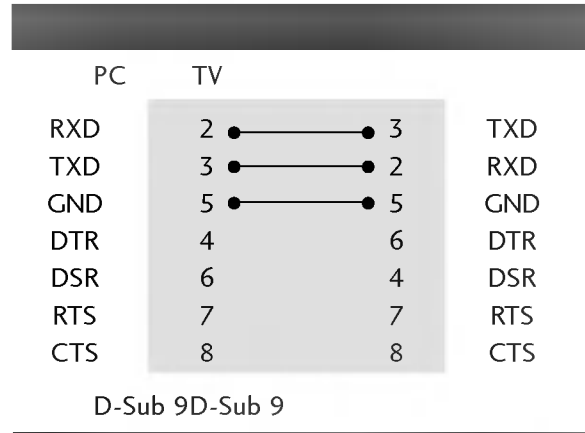
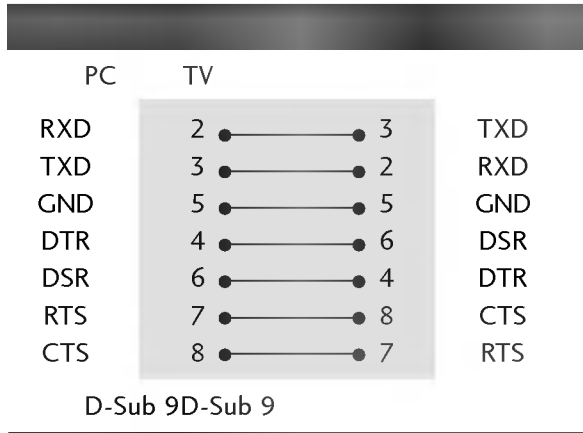

Set ID

Use this function to specify a TV ID number.
Refer to 'Real Data Mapping1'. ▶ p.95

- Press the **MENU** button and then use ▲ or ▼ button to select the **SPECIAL** menu.
- Press the ► button and then use ▲ or ▼ button to select **Set ID**.
- Press the ► button and then use ◀ or ▶ button to adjust **Set ID** to choose the desired TV ID number. The adjustment range of SET ID is 1 ~99.
- Press **EXIT** button to return to TV viewing or press **MENU** button to return to the previous menu.

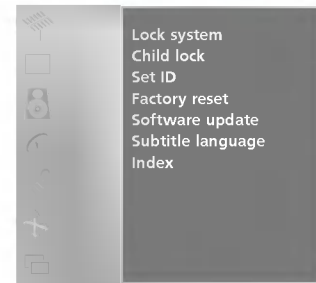
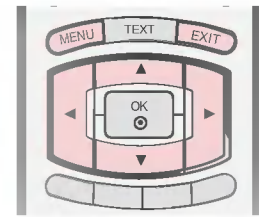

Communication Parameters

- Baud rate : 9600 bps (UART)
- Data length : 8 bits
- Parity : None
- Stop bit : 1 bit
- Communication code : ASCII code
- Use a crossed (reverse) cable.

APPENDIX

Command Reference List

01. Power	k	a	0 ~ 1	14. PIP/DW	k	n	0 ~ 3
02. Input Select	k	b	(▶ p.91)	15. PIP Position	k	q	0 ~ 3
03. Aspect Ratio	k	c	(▶ p.91)	16. Balance	k	t	0 ~ 64
04. Screen Mute	k	d	0 ~ 1	17. Colour Temperature	k	u	0 ~ 3
05. Volume Mute	k	e	0 ~ 1	18. Red Adjustment	k	v	0 ~ 50
06. Volume Control	k	f	0 ~ 64	19. Green Adjustment	k	w	0 ~ 50
07. Contrast	k	g	0 ~ 64	20. Blue Adjustment	k	\$	0 ~ 50
08. Brightness	k	h	0 ~ 64	21. PIP input Source	k	y	(▶ p.93)
09. Colour	k	i	0 ~ 64	22. Abnormal Status	k	z	0 ~ a
10. Tint	k	j	0 ~ 64	23. Picture Size Setting for DW Mode	j	t	0 ~ 20
11. Sharpness	k	k	0 ~ 64	24. Auto Configure	j	u	1
12. OSD Select	k	l	0 ~ 1	25. Channel Select Command	m	a	(▶ p.94)
13. Remote Control Lock Mode	k	m	0 ~ 1	26. Send IR Code	m	c	(▶ p.94)
				27. Input select	x	b	(▶ p.94)
				28. Input select (PIP)	x	y	(▶ p.95)

* When setting the 22 ~ 28, a menu doesn't display on screen.

Transmission / Receiving Protocol

[Command1][Command2][][Set ID][][Data][Cr]

[Command 1] : First command to control the set.(j, k, m or x)

[Command 2] : Second command to control the set.

[Set ID] : You can adjust the set ID to choose desired TV ID number in Setup menu. Adjustment range is 1 ~ 99. When selecting Set ID '0', every connected the TV is controlled. Set ID is indicated as decimal (1 ~ 99) on menu and as Hexa decimal (0x0 ~ 0x63) on transmission/receiving protocol.

[DATA] : To transmit command data.

Transmit 'FF' data to read status of command.

[Cr] : Carriage Return

ASCII code '0x0D'

[] : ASCII code 'space (0x20)'

[Command2][][Set ID][][OK][Data][x]

The TV transmits ACK (acknowledgement) based on this format when receiving normal data. At this time, if the data is data read mode, it indicates present status data. If the data is data write mode, it returns the data of the PC computer.

[Command2][][Set ID][][NG][Data][x]

The TV transmits ACK (acknowledgement) based on this format when receiving abnormal data from non-viable functions or communication errors.

Data1: Illegal Code

Data2: Not supported function

Data3: Wait more time

01. Power (Command 2 : a)

- ▶ To control Power On/Off of the set.

Transmission

```
[k][a][ ][Set ID][ ][Data][Cr]
```

Data 0 : Power Off 1 : Power On

Ack

```
[a][ ][Set ID][ ][OK][Data][x]
```

- ▶ To show Power On/Off.

Transmission

```
[k][a][ ][Set ID][ ][FF][Cr]
```

Ack

```
[a][ ][Set ID][ ][OK][Data][x]
```

* In like manner, if other functions transmit '0xFF' data based on this format, Acknowledgement data feed back presents status about each function.

02. Input Select (Command 2 : b)

- ▶ To select input source for the set.
You can also select an input source using the INPUT button on the set's remote control.

Transmission

```
[k][b][ ][Set ID][ ][Data][Cr]
```

Data 0 : DTV 4 : Component
1 : Analogue 6 : RGB-DTV
2 : AV1 7 : RGB-PC
3 : AV2

Ack

```
[b][ ][Set ID][ ][OK][Data][x]
```

03. Aspect Ratio (Command 2 : c) (Main Picture Size)

- ▶ To adjust the screen format. (Main picture format)
You can also adjust the screen format using the ARC (Aspect Ratio Control) button on remote control or in the SCREEN menu.

Transmission

```
[k][c][ ][Set ID][ ][Data][Cr]
```

Data 1 : Normal screen (4:3)
2 : Wide screen (16:9)
3 : Horizon (Spectacle)
4 : Zoom
6 : Original
7 : 14:9
8 : Full

Ack

```
[c][ ][Set ID][ ][OK][Data][x]
```

* Using the PC input, you select either 16:9 or 4:3 screen aspect ratio.

04. Screen Mute (Command 2 : d)

- ▶ To select screen mute on/off.

Transmission

```
[k][d][ ][Set ID][ ][Data][Cr]
```

Data 0 : Screen mute off (Picture on)
1 : Screen mute on (Picture off)

Ack

```
[d][ ][Set ID][ ][OK][Data][x]
```

05. Volume Mute (Command 2 : e)

- ▶ To control volume mute on/off.
You can also adjust mute using the MUTE button on remote control.

Transmission

```
[k][e][ ][Set ID][ ][Data][Cr]
```

Data 0 : Volume mute off (Volume on)
1 : Volume mute on (Volume off)

Ack

```
[e][ ][Set ID][ ][OK][Data][x]
```

06. Volume Control (Command 2 : f)

- ▶ To adjust volume.
You can also adjust volume with the VOLUME buttons on remote control.

Transmission

```
[k][f][ ][Set ID][ ][Data][Cr]
```

Data Min : 0 ~ Max : 64
* Refer to 'Real data mapping 1'. See page 95.

Ack

```
[f][ ][Set ID][ ][OK][Data][x]
```

07. Contrast (Command 2 : g)

- ▶ To adjust screen contrast.
You can also adjust contrast in the PICTURE menu.

Transmission

```
[k][g][ ][Set ID][ ][Data][Cr]
```

Data Min : 0 ~ Max : 64
* Refer to 'Real data mapping 1'. See page 95.

Ack

```
[g][ ][Set ID][ ][OK][Data][x]
```

08. Brightness (Command 2 : h)

- ▶ To adjust screen brightness.
You can also adjust brightness in the PICTURE menu.

Transmission

```
[k][h][ ][Set ID][ ][Data][Cr]
```

Data Min : 0 ~ Max : 64
* Refer to 'Real data mapping 1'. See page 95.

Ack

```
[h][ ][Set ID][ ][OK][Data][x]
```

APPENDIX

09. Colour (Command 2 : i)

- ▶ To adjust the screen colour.
You can also adjust colour in the PICTURE menu.

Transmission

[k][i][][Set ID][][Data][Cr]

Data Min : 0 ~ Max : 64

* Refer to 'Real data mapping 1'. See page 95.

Ack

[i][][Set ID][][OK][Data][x]

10. Tint (Command 2 : j) (option)

- ▶ To adjust the screen tint.
You can also adjust tint in the PICTURE menu.

Transmission

[k][j][][Set ID][][Data][Cr]

Data Red : 0 ~ Green : 64

* Refer to 'Real data mapping 1'. See page 95.

Ack

[j][][Set ID][][OK][Data][x]

11. Sharpness (Command 2 : k)

- ▶ To adjust the screen sharpness.
You can also adjust sharpness in the PICTURE menu.

Transmission

[k][k][][Set ID][][Data][Cr]

Data Min : 0 ~ Max : 64

* Refer to 'Real data mapping 1'. See page 95.

Ack

[k][][Set ID][][OK][Data][x]

12. OSD Select (Command 2 : l)

- ▶ To select OSD (On Screen Display) on/off when controlling remotely.

Transmission

[k][l][][Set ID][][Data][Cr]

Data 0 : OSD off 1 : OSD on

Ack

[l][][Set ID][][OK][Data][x]

13. Remote control lock mode (Command 2 : m)

- ▶ To lock the front panel controls on the monitor and remote control.

Transmission

[k][m][][Set ID][][Data][Cr]

Data 0 : Lock off 1 : Lock on

Ack

[m][][Set ID][][OK][Data][x]

* If you're not using the remote control, use this mode.
When main power is on/off, external control lock is released.

14. PIP / DW (Command 2 : n)

- ▶ To control the PIP (Picture In picture)/DW.
You can also control the PIP/DW using the PIP button on the remote control or in the PIP/DW menu.

Transmission

[k][n][][Set ID][][Data][Cr]

Data 0: PIP/DW off 3: DW2

1: PIP 5: POP

2: DW1

Ack

[n][][Set ID][][OK][Data][x]

15. PIP Position (Command 2 : q)

- ▶ To select sub picture position for PIP. You can also adjust the sub picture position using POSITION button on the remote control or in the PIP/DW menu.

Transmission

[k][q][][Set ID][][Data][Cr]

Data 0 : Right down on screen

1 : Left down on screen

2 : Left up on screen

3 : Right up on screen

Ack

[q][][Set ID][][OK][Data][x]

16. Balance (Command 2 : t)

- ▶ To adjust balance.
You can also adjust balance in the SOUND menu.

Transmission

[k][t][][Set ID][][Data][Cr]

Data Min : 0 ~ Max : 64

* Refer to 'Real data mapping 1'. See page 95.

Ack

[t][][Set ID][][OK][Data][x]

17. Colour Temperature (Command 2 : u)

- ▶ To adjust colour temperature.
You can also adjust CSM in the PICTURE menu.

Transmission

[k][u][][Set ID][][Data][Cr]

Data 0: Cool 1: Normal 2: Warm 3: User

Ack

[u][][Set ID][][OK][Data][x]

18. Red Adjustment (Command 2 : v)

- ▶ To adjust red in colour temperature.

Transmission

```
[k][v][ ][Set ID][ ][Data][Cr]
```

Data Min : 0 ~ Max : 50

* Refer to 'Real data mapping 2'. See page 95.

Ack

```
[v][ ][Set ID][ ][OK][Data][x]
```

19. Green Adjustment (Command 2 : w)

- ▶ To adjust green in colour temperature.

Transmission

```
[k][w][ ][Set ID][ ][Data][Cr]
```

Data Min : 0 ~ Max : 50

* Refer to 'Real data mapping 2'. See page 95.

Ack

```
[w][ ][Set ID][ ][OK][Data][x]
```

20. Blue Adjustment (Command 2 : \$)

- ▶ To adjust blue in colour temperature.

Transmission

```
[k][$][ ][Set ID][ ][Data][Cr]
```

Data Min : 0 ~ Max : 50

* Refer to 'Real data mapping 2'. See page 95.

Ack

```
[$][ ][Set ID][ ][OK][Data][x]
```

21. PIP Input Select (Command 2 : y)

- ▶ To select input source for sub picture in PIP/Twin picture mode. You can also adjust input source for sub picture using PIP INPUT button on remote control.

Transmission

```
[k][y][ ][Set ID][ ][Data][Cr]
```

Data 0 : DTV	4 : Component
1 : Analogue	6 : RGB-DTV
2 : AV1	7 : RGB-PC
3 : AV2	

Ack

```
[y][ ][Set ID][ ][OK][Data][x]
```

22. Abnormal State (Command 2 : z)

- ▶ To recognize an abnormal state.

Transmission

```
[k][z][ ][Set ID][ ][FF][ ][Cr]
```

Data FF : Read

Ack

```
[z][ ][Set ID][ ][OK][Data][x]
```

Data 0: Normal (Power on and signal exist)

1: No signal (Power on)

2: Turn the monitor off by remote control

3: Turn the monitor off by sleep time function

4: Turn the monitor off by RS-232C function

5: 5V down

6: AC down

8: Turn the monitor off by Off time function

9: Turn the monitor off by Auto sleep function

a: Turn the monitor off by AV board detect

* This function is "read only".

23. Picture Size Setting for DW Mode (Command 1 : j, Command 2 : t)

- ▶ To select the PIP picture format. You can also select the PIP picture format using the SIZE on the remote control.

Transmission

```
[j][t][ ][Set ID][ ][Data][Cr]
```

Data Min: 0 ~ Max: 20

* Refer to 'Real data mapping 1'. See page 95.

Ack

```
[t][ ][Set ID][ ][OK/NG][Data][x]
```

24. Auto Configure (Command 1 : j, Command 2 : u)

- ▶ To adjust picture position and minimize image shaking automatically. It works only in RGB (PC) mode.

Transmission

```
[j][u][ ][Set ID][ ][Data][Cr]
```

Data 1: To set

Ack

```
[u][ ][Set ID][ ][OK/NG][Data][x]
```

APPENDIX

25. Channel Select Command (Command 1 : m, Command 2 : a)

► Select channel to following physical number.

Transmission

[m][a][][Set ID][][Data0][][Data1][][Data2][Cr]

Data0 :High channel data

Data1 :Low channel data

ex. No. 47 -> 00 2F (2FH)
No. 394 -> 01 88 (188H)

Data2 0x00 : ATV Main

0x01 : ATV Sub

0x10 : DTV Main

0x11 : DTV Sub

Channel data range

Analogue - Min: 00 ~ Max: 63 (0~99)

Digital - Min: 00 ~ Max: 3E7 (0~999)

ex) In ATV Main and DTV Sub mode

1. Auto Programme or Manual Programme
2. "ma 1 00 08 00" --> Select 8 channel (ATV Main)
3. "ma 1 00 0E 11" --> Select 14 channel (DTV Sub)

Ack

[a][][Set ID][][OK/NG][Data][x]

Data Min: 00 ~ Max: FF

26. Send IR Code (Command 1 : m, Command 2 : c)

► To send IR remote key code.

Transmission

[m][c][][Set ID][][Data][Cr]

Data Key code - Refer to page 97.

Ack

[c][][Set ID][][OK/NG][Data][x]

27. Input select (Command 1 : x, Command 2 : b) (Main Picture Input)

► To select input source for main picture.

Transmission

[x][b][][Set ID][][Data][Cr]

Data Structure

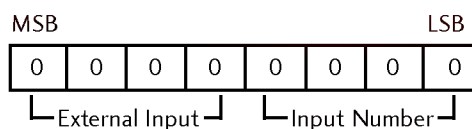

External Input				Data
0	0	0	0	DTV
0	0	0	1	Analogue
0	0	1	0	AV
0	0	1	1	SAV
0	1	0	0	Component
0	1	0	1	RGB-DTV
0	1	1	0	RGB-PC
1	0	0	1	HDMI-DTV
1	0	1	0	HDMI-PC

Input Number				Data
0	0	0	0	Input1
0	0	0	1	Input2
0	0	1	0	Input3
0	0	1	1	Input4
0	1	0	0	Input5
0	1	0	1	Input6

Ack

[b][][Set ID][][OK/NG][Data][x]

28. Input select (Command 1 : x, Command 2 : y)

► To adjust input source for sub picture in PIP mode.

Transmission

[x][y][][Set ID][][Data][Cr]

Data Structure

MSB LSB

0	0	0	0	0	0	0	0
---	---	---	---	---	---	---	---

└─ External Input ─┘ └─ Input Number ─┘

External Input				Data
0	0	0	0	DTV
0	0	0	1	Analogue
0	0	1	0	AV
0	0	1	1	SAV
0	1	0	0	Component
0	1	0	1	RGB-DTV
0	1	1	0	RGB-PC
1	0	0	1	HDMI-DTV
1	0	1	0	HDMI-PC

Input Number				Data
0	0	0	0	Input1
0	0	0	1	Input2
0	0	1	0	Input3
0	0	1	1	Input4
0	1	0	0	Input5
0	1	0	1	Input6

Ack

[y][][Set ID][][OK/NG][Data][x]

* Real data mapping 1

0 : Step 0
 ⋮
 A : Step 10 (Set ID 10)
 ⋮
 F : Step 15 (Set ID 15)
 10 : Step 16 (Set ID 16)
 ⋮
 64 : Step 100
 ⋮
 6E : Step 110
 ⋮
 73 : Step 115
 74 : Step 116
 ⋮
 C7 : Step 199
 ⋮
 FE : Step 254
 FF : Step 255

* Real data mapping 2

0 : -40
 1 : -39
 2 : -38
 ⋮
 28 : 0
 ⋮
 4E : +38
 4F : +39
 50 : +40

APPENDIX

IR CODES

1. How to Connect

- Connect your wired remote control to the Remote Control port on the TV.

2. Remote Control IR Codes

■ Output waveform

Single pulse, modulated with 37.917KHz signal at 455KHz

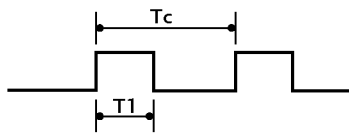

Carrier frequency
 $FCAR = 1/TC = fOSC/12$
 Duty ratio = $T1/TC = 1/3$

■ Configuration of frame

1st frame

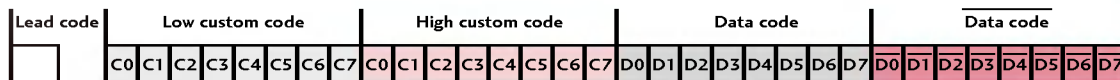

Repeat frame

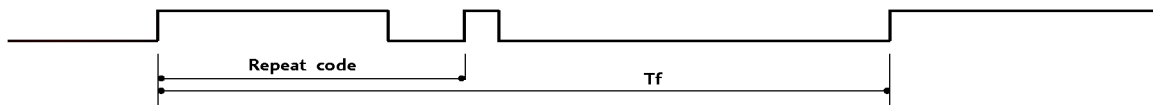

■ Lead code

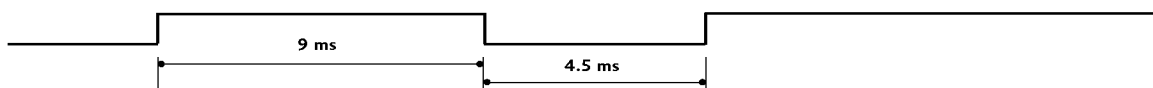

■ Repeat code

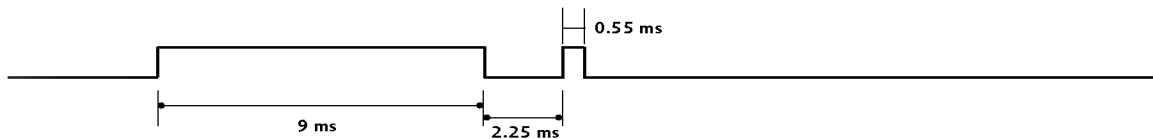

■ Bit description



■ Frame interval: Tf

The waveform is transmitted as long as a key is depressed.

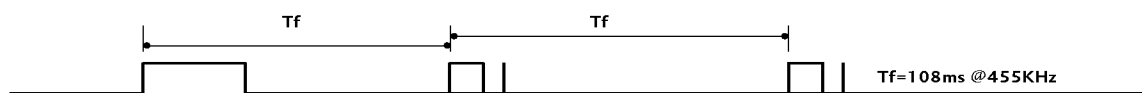

00	PR ▲	Remote control Button		TV	Discrete IR Code
01	PR ▼	Remote control Button			(TV Input Selection)
02	VOL ▲	Remote control Button	5A	AV1	Discrete IR Code
03	VOL ▼	Remote control Button			(AV1 Input Selection)
40	▲	Remote control Button		AV2	Discrete IR Code
41	▼	Remote control Button			(AV2 Input Selection)
07	◀	Remote control Button	D1	AV3	Discrete IR Code
06	▶	Remote control Button			(AV3 Input Selection)
08	POWER	Remote control Button (Power On/Off)		AV4	Discrete IR Code
09	MUTE	Remote control Button			(AV4 Input Selection)
10-19	Number Key 0-9	Remote control Button	D3	SAV2	Discrete IR Code
0B	INPUT	Remote control Button			(SAV2 Input Selection)
AA	INFO i	Remote control Button		COMPONENT1	Discrete IR Code
AB	GUIDE	Remote control Button			(Component1 Input Selection)
39	SUBTITLE	Remote control Button	D5	RGB-PC	Discrete IR Code
5B	EXIT	Remote control Button			(RGB Input Selection)
1F	FAV	Remote control Button		HDMI	Discrete IR Code
1A	Q.VIEW	Remote control Button			(HDMI Input Selection)
50	D/A TV	Remote control Button	76	Ratio 4:3	Discrete IR Code
0A	I/II	Remote control Button			(Only 4:3 Mode)
0E	SLEEP	Remote control Button		Ratio 16:9	Discrete IR Code
43	MENU	Remote control Button			(Only 16:9 Mode)
44	OK	Remote control Button	AF	Ratio Zoom	Discrete IR Code
53	LIST	Remote control Button			(Only Zoom Mode)
20	TEXT	Remote control Button		POWER ON	Discrete IR Code
60	PIP	Remote control Button			(Only Power On)
C0	PIP PR +	Remote control Button	C5	POWER OFF	Discrete IR Code
C1	PIP PR -	Remote control Button			(Only Power Off)
C2	SWAP	Remote control Button		REVEAL	Remote control Button
C3	PIP INPUT	Remote control Button	26	TIME	Remote control Button
61	BLUE	Remote control Button		UPDATE / POSITION	Remote control Button
63	YELLOW	Remote control Button	64	SIZE	Remote control Button
71	GREEN	Remote control Button		INDEX	Remote control Button
72	RED	Remote control Button			
28	BACK	Remote control Button			
79	ARC	Remote control Button			

APPENDIX

PROGRAMMING THE REMOTE CONTROL

The remote is a multi-brand or a universal remote. It can be programmed to operate most remote-controllable devices of other manufacturers.

Note that the remote may not control all models of other brands.

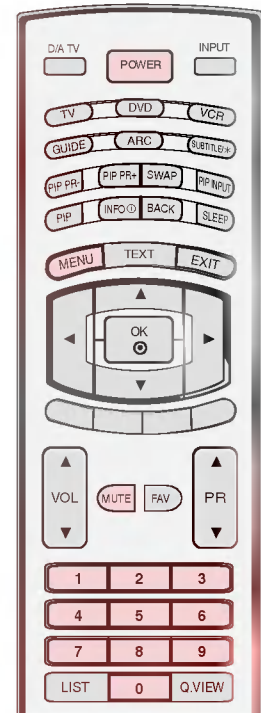

- To find out whether your remote can operate the device without programming, turn on the device such as a VCR and press the corresponding mode button on the remote.

After that, press the POWER button. If the device is turned off then it responds properly and the remote need not to be programmed.

If not, the remote should be programmed to operate the device. The programming procedures are explained below.

- Press the MENU and MUTE button continuously at the same time for 2 seconds, the current selected device button will be illuminated.

If you don't press any button for 20 seconds, the light on the mode button will be turned off. In that case, you have to repeat from step 2.

- Enter code numbers using the number button on the remote by referring the code table on the following pages. When pressing the button, the light blinks at a time.

If the device turned off, the programming is successful.

- Press the MENU button to store the code. After blinking twice, this code is stored.
- Test the remote functions to see if the device responds properly. If not, repeat from step 2.

PROGRAMMING CODES

VCRs

AIWA	034	MAGNAVOX	031 033 034 041	SAMSUNG	032 040 102 104
AKAI	016 043 046 124		067 068		105 107 109 112
	125 146	MARANTZ	012 031 033 067		113 115 120 122
AMPRO	072		069		125
ANAM	031 033 103	MARTA	101	SANSUI	022 043 048 135
AUDIO DYNAMICS	012 023 039 043	MATSUI	027 030	SANYO	003 007 010 014
BROKSONIC	035 037 129	MEI	031 033		102 134
CANON	028 031 033	MEMOREX	003 010 014 031	SCOTT	017 037 112 129
CAPEHART	108		033 034 053 072		131
CRAIG	003 040 135		101 102 134 139	SEARS	003 008 009 010
CURTIS MATHES	031 033 041	MGA	045 046 059		013 014 017 020
DAEWOO	005 007 010 064	MINOLTA	013 020		031 042 073 081
	065 108 110 111	MITSUBISHI	013 020 045 046		101
	112 116 117 119		049 051 059 061	SHARP	031 054 149
DAYTRON	108		151	SHINTOM	024
DBX	012 023 039 043	MTC	034 040	SONY	003 009 031 052
DYNATECH	034 053	MULTITECH	024 034		056 057 058 076
ELECTROHOME	059	NEC	012 023 039 043		077 078 149
EMERSON	006 017 025 027		048	SOUNDESIGN	034
	029 031 034 035	NORDMENDE	043	STS	013
	036 037 046 101	OPTONICA	053 054	SYLVANIA	031 033 034 059
	129 131 138 153	PANASONIC	066 070 074 083		067
FISHER	003 008 009 010		133 140 145	SYMPHONIC	034
FUNAI	034			TANDY	010 034
GE	031 033 063 072	PENTAX	013 020 031 033	TATUNG	039 043
	107 109 144 147		063	TEAC	034 039 043
GO VIDEO	132 136	PHILCO	031 034 067	TECHNICS	031 033 070
HARMAN KARDON	012 045	PHILIPS	031 033 034 054	TEKNIKA	019 031 033 034
HITACHI	004 018 026 034		067 071 101		101
	043 063 137 150	PILOT	101	THOMAS	034
INSTANTREPLAY	031 033	PIONEER	013 021 048	TMK	006
JCL	031 033	PORTLAND	108	TOSHIBA	008 013 042 047
JCPENNY	012 013 015 033	PULSAR	072		059 082 112 131
	040 066 101	QUARTZ	011 014	TOTEVISION	040 101
JENSEN	043	QUASAR	033 066 075 145	UNITECH	040
JVC	012 031 033 043	RCA	013 020 033 034	VECTOR RESEARCH	012
	048 050 055 060		040 041 062 063	VICTOR	048
	130 150 152		107 109 140 144	VIDEO CONCEPTS	012 034 046
KENWOOD	014 034 039 043		145 147	VIDEOSONIC	040
	047 048	REALISTIC	003 008 010 014	WARDS	003 013 017 024
LG (GOLDSTAR)	001 012 013 020		031 033 034 040		031 033 034 040
	101 106 114 123		053 054 101		053 054 131
LLOYD	034	RICO	058	YAMAHA	012 034 039 043
LXI	003 009 013 014	RUNCO	148	ZENITH	034 048 056
	017 034 101 106	SALORA	014		058 072 080 101
MAGIN	040				

APPENDIX

VCRs

ABC	003 004 039 042		074	REMRANT	025
	046 052 053	LG (GOLDSTAR)	001 106 101 005	SAMSUNG	102 107 030 068
AJIN	112	M-NET	037	SCIENTIFIC ATLANTA	003 011 041 042
ANTRONIK	014	MACOM	033		043 045 046
ARCHER	005 007 014 024	MAGNAVOX	010 012 064 079	SHERITECH	022
CABLE STAR	026	MEMOREX	100	SIGNAL	030
CENTURION	092	MOVIE TIME	028 032	SIGNATURE	052
CENTURY	007	NSC	015 028 038 071	SL MARX	030
CITIZEN	007		073	SPRUCER	047 078
COLOUR VOICE	065 090	OAK	016 031 037 053	STARCOM	002 004 008 009
COMBANO	080 081	PANASONIC	044 047	STARGATE	008 030
COMTRONICS	019 030	PARAGON	100	TADIRAN	030
DIAMOND	023			TAEKWANG	110
EAGLE	020 030 040	PHILIPS	006 012 013 020	TAIHAN	105
EASTERN	057 062 066		065 085 090	TANDY	017
ELECTRICORD	032	PIONEER	034 051 052 063	TEXSCAN	029
GE	072		076	TOCOM	039 040 056
GEMINI	008 022 025 054	POST NEWS WEEK	016	TOSHIBA	100
GI	052 074	PRUCER	059	UNIKA	007 014 024
GOLDEN CHANNEL	030	PTS	011 048 071 072	UNITED CABLE	004 053
HAMLIN	049 050 055		073 074	UNIVERSAL	005 007 014 024
HITACHI	052 055	PULSAR	100		026 027 032 035
HOSPITALITY	070 077	RCA	047	VIEWSTAR	012 015 018 086
JERROLD	002 003 004 008	REGAL	049 050		087 088 089
	009 010 052 069	REGENCY	057	ZENITH	100 114 060 093

DVD

APEX DIGITAL	022	MITSUBISHI	002	RCA	005 006
DENON	020 014	NAD	023	SAMSUNG	011 015
GE	005 006	ONKYO	008 017	SONY	007
HARMAN KARDON	027	PANASONIC	003 009	THOMPSON	005 006
JVC	012	PHILIPS	013	TOSHIBA	019 008
LG	001 010 016 025	PIONEER	004 026	YAMAHA	009 018
MAGNAVOX	013	PROCEED	021	ZENITH	010 016 025
MARANTZ	024	PROSCAN	005 006		

TROUBLESHOOTING CHECKLIST

The remote control doesn't work	<ul style="list-style-type: none"> ■ Check to see if there is any object between the product and the remote control causing obstruction. Ensure you are pointing the remote control directly at the TV. ■ Ensure that the batteries are installed with correct polarity (+ to +, - to -). ■ Ensure that the correct remote operating mode is set: TV, VCR etc. ■ Install new batteries.
Power is suddenly turned off	<ul style="list-style-type: none"> ■ Is the sleep timer set? ■ Check the power control settings. Power interrupted ■ No broadcast on station tuned with Auto off activated.

No picture & No sound	<ul style="list-style-type: none"> ■ Check whether the product is turned on. ■ Try another channel. The problem may be with the broadcast. ■ Is the power cord inserted into wall power outlet? ■ Check your antenna direction and/or location. ■ Test the wall power outlet, plug another product's power cord into the outlet where the product's power cord was plugged in.
Picture appears slowly after switching on	<ul style="list-style-type: none"> ■ This is normal, the image is muted during the product startup process. Please contact your service center, if the picture has not appeared after five minutes.
No or poor color or poor picture	<ul style="list-style-type: none"> ■ Adjust Color in menu option. ■ Keep a sufficient distance between the product and the VCR. ■ Try another channel. The problem may be with the broadcast. ■ Are the video cables installed properly? ■ Activate any function to restore the brightness of the picture.
Horizontal/vertical bars or picture shaking	<ul style="list-style-type: none"> ■ Check for local interference such as an electrical appliance or power tool.
Poor reception on some channels	<ul style="list-style-type: none"> ■ Station or cable product experiencing problems, tune to another station.
Lines or streaks in pictures	<ul style="list-style-type: none"> ■ Station signal is weak, reorient antenna to receive weaker station. ■ Check for sources of possible interference. ■ Check antenna (Change the direction of the antenna).

APPENDIX

Picture OK & No sound	<ul style="list-style-type: none"> ■ Press the VOL or VOLUME button. ■ Sound muted? Press MUTE button. ■ Try another channel. The problem may be with the broadcast. ■ Are the audio cables installed properly?
No output from one of the speakers	<ul style="list-style-type: none"> ■ Adjust Balance in menu option.
Unusual sound from inside the product	<ul style="list-style-type: none"> ■ A change in ambient humidity or temperature may result in an unusual noise when the product is turned on or off and does not indicate a fault with the product.

The signal is out of range	<ul style="list-style-type: none"> ■ Adjust resolution, horizontal frequency, or vertical frequency. ■ Check the input source.
Vertical bar or stripe on background & Horizontal Noise & Incorrect position	<ul style="list-style-type: none"> ■ Work the Auto configure or adjust clock, phase, or H/V position. (Option)
Screen color is unstable or single color	<ul style="list-style-type: none"> ■ Check the signal cable. ■ Reinstall the PC video card.

MAINTENANCE

Early malfunctions can be prevented. Careful and regular cleaning can extend the amount of time you can enjoy your new TV.

Caution: Be sure to turn the power off and unplug the power cord before you begin any cleaning.

Cleaning the Screen

- Here's a great way to keep the dust off your screen for a while. Wet a soft cloth in a mixture of lukewarm water and a little fabric softener or dish washing detergent. Wring the cloth until it's almost dry, and then use it to wipe the screen.
- Make sure the excess water is off the screen, and then let it air-dry before you turn on your TV.

Cleaning the Cabinet

- To remove dirt or dust, wipe the cabinet with a soft, dry, lint-free cloth.
- Please be sure not to use a wet cloth.

Extended Absence

▲ CAUTION

- ▶ If you expect to leave your TV dormant for a long time (such as a vacation), it's a good idea to unplug the power cord to protect against possible damage from lightning or power surges.

APPENDIX

PRODUCT SPECIFICATIONS

Dimensions (Width x Height x Depth)	Including stand	35.9 x 23.6 x 10.2 inches 911.4 x 599.0 x 259.0 mm	41.1 x 27.3 x 10.2 inches 1045.8 x 693.8 x 260.4 mm	46.2 x 30.2 x 11.8 inches 1175 x 768 x 300 mm
	Excluding stand	35.9 x 20.1 x 4.9 inches 911.4 x 511.5 x 124.2 mm	41.1 x 23.6 x 5.2 inches 1045.8 x 594.4 x 133.0 mm	46.2 x 26.4 x 5.7 inches 1175 x 670 x 143.8 mm
Weight	including stand	53.1 pounds / 24.1 kg	69.6 pounds / 31.6 kg	91.2 pounds / 41.4 kg
	excluding stand	42.5 pounds / 19.3 kg	55.7 pounds / 25.3 kg	72.3 pounds / 32.8 kg
Power requirement	AC100-240V ~ 50/60Hz			
Television System	PAL/SECAM B/G/D/K, PAL I/II, SECAM L/L'			
Program Coverage	VHF: E2 ~ E12, UHF: E21 ~ E69, CATV: S1 ~ S20, HYPER: S21 ~ S47			
External Antenna Impedance	75 ohm			
Environment condition	Operating Temperature	32 ~ 104°F (0 ~ 40°C)		
	Operating Humidity	Less than 80%		
	Storage Temperature	-4 ~ 140°F (-20 ~ 60°C)		
	Storage Humidity	Less than 85%		

■ The specifications shown above may be changed without prior notice for quality improvement.

