



**KIA MOTORS**

## ***Car CD/MP3/WMA Receiver***

### ***OWNER'S MANUAL***

***MODEL : LAC-M5520EK, LAC-M5521EK  
LAC-M5530EK, LAC-M5531EK***



Please read this instruction booklet carefully and completely before connecting, operating or adjusting this product.



# Table of Contents

## INTRODUCTION

Table of Contents . . . . .	2
Safety Precautions . . . . .	3
Before Use . . . . .	4
Front Panel . . . . .	5

## PREPARATION

Connections . . . . .	6-7
-----------------------	-----

## OPERATION

Basic Operation . . . . .	8-9
Turning the unit on . . . . .	8
Turning the unit off . . . . .	8
Selecting a source . . . . .	8
Adjusting the volume . . . . .	8
SOUND Adjustment . . . . .	9
RDS Operation . . . . .	10-11
RDS Display Options . . . . .	10
RDS AF/REG FUNCTION . . . . .	10
LOCAL/DX selection in EON-TA mode . . . . .	10
RDS MODE Adjustment . . . . .	11
Radio Operation . . . . .	12
Listening to radio stations . . . . .	12
Auto Search Memory . . . . .	12
Storing and recalling broadcast frequencies . . . . .	12

Operation with Audio CD, MP3/WMA Disc . . . . .	13-14
Playing an Audio CD and MP3/WMA Disc . . . . .	13-14

## REFERENCE

Troubleshooting . . . . .	15
Specifications	



### Disposal of your old appliance

1. When this crossed-out wheeled bin symbol is attached to a product it means the product is covered by the European Directive 2002/96/EC.
2. All electrical and electronic products should be disposed of separately from the municipal waste stream via designated collection facilities appointed by the government or the local authorities.
3. The correct disposal of your old appliance will help prevent potential negative consequences for the environment and human health.
4. For more detailed information about disposal of your old appliance, please contact your city office, waste disposal service or the shop where you purchased the product.

INTRODUCTION



# Safety Precautions



**CAUTION**  
**RISK OF ELECTRIC SHOCK DO NOT OPEN**





Warning: To reduce the risk of electric shock, do not remove the cover or back of this product. There are no user-serviceable parts inside. Refer servicing to qualified service personnel.



Warning: To reduce the risk of fire or electric shock, do not expose this product to dripping or splashing water, rain, or moisture.

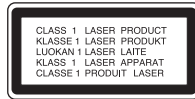

Warning: Due to high temperature outside of the unit, please use the unit only installed in a car.



Caution: Protect this product from moisture.



Caution: If the battery is disconnected or discharged, the preset memory will be erased and must be reprogrammed.

## CAUTION:

This unit employs a Laser System.

To ensure proper use of this product, please read this owner's manual carefully and retain for future reference.

Should the unit require maintenance, contact an authorized service location (see service procedure).

Use of controls, adjustments, or the performance of procedures other than those specified herein may result in hazardous radiation exposure.

To prevent direct exposure to the laser beam, do not open the enclosure. Visible laser radiation when open. **DO NOT STARE INTO BEAM.**



## Before Use

To ensure proper use of this product, please read this owner's manual carefully and retain for future reference.

### Symbols Used in this Manual



The lightning flash symbol alerts you to the presence of dangerous voltage within the product enclosure that may constitute a risk of electric shock.



Indicates hazards likely to cause harm to the unit itself or other material damage.

#### NOTE

Indicates special notes and operating features.

### Notes on Discs

#### Handling Discs

Do not touch the playback side of the disc. Hold the disc by the edges so that fingerprints do not get on the surface. Never stick paper or tape on the disc.



#### Storing Discs

After playing, store the disc in its case. Do not expose the disc to direct sunlight or sources of heat and never leave it in a parked car exposed to direct sunlight.

#### Cleaning Discs

Fingerprints and dust on the disc can cause poor picture quality and sound distortion. Before playing, clean the disc with a clean cloth. Wipe the disc from the center out.

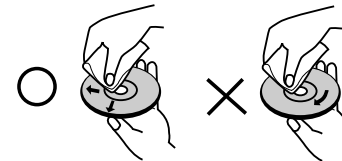

Do not use strong solvents such as alcohol, benzene, thinner, commercially available cleaners, or anti-static spray intended for older vinyl records.

This unit cannot be operated with 8cm disc (use 12cm discs only).

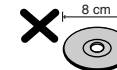



## Front Panel

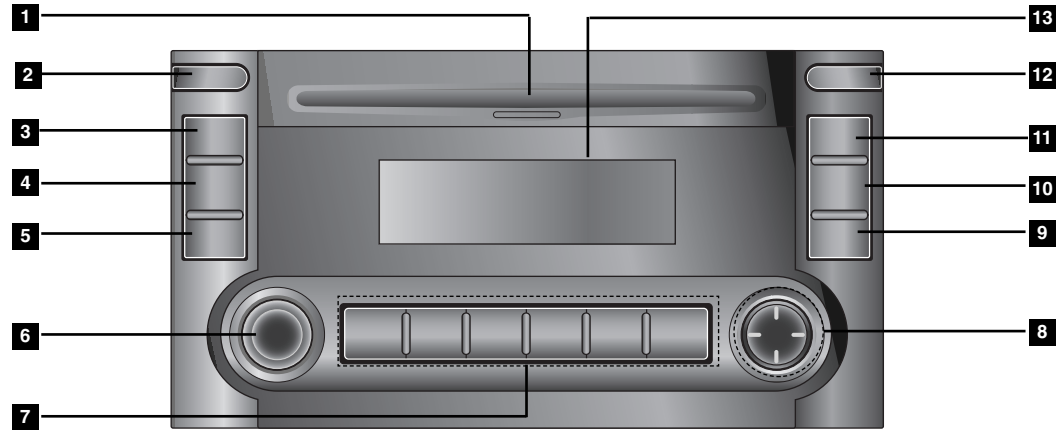

- 1** CD disc slot
- 2** POWER/SOURCE (⏻) button
- 3** MUTE button
- 4** BAND button
- 5** AUTO STORE/PRESET SCAN (AS/PS) button
- 6** • VOLUME KNOB
  - CONTROL UP/DOWN dial
- 7** • Preset Station buttons. (1-6)
  - CD PLAY/PAUSE (1 ▶/||) button
  - INTRO SCAN (2 SCAN ) button
  - REPEAT (3 RPT) button
  - SHUFFLE (4 SHF) button
  - MP3/WMA TRACK +/-10 (5 -10/ 6 +10) button

- 8** • ALTERNATIVE FREQUENCIES (AF) button
  - TA button
  - CD SKIP/SEARCH (⏮ / ⏭) button
  - SEEK/TUNE (-/+ ) button
- 9** DISPLAY (DISP) button
- 10** EQUALIZER/XDSS (EQ/XDSS) button
- 11** SOUND OPT.MENU button
- 12** EJECT (⏏) button
- 13** DISPLAY WINDOW



# Connections

## Connecting to the Car

Before connecting, make sure that the ignition switch is set to OFF, and remove the battery ⊖ terminal to avoid short circuits.

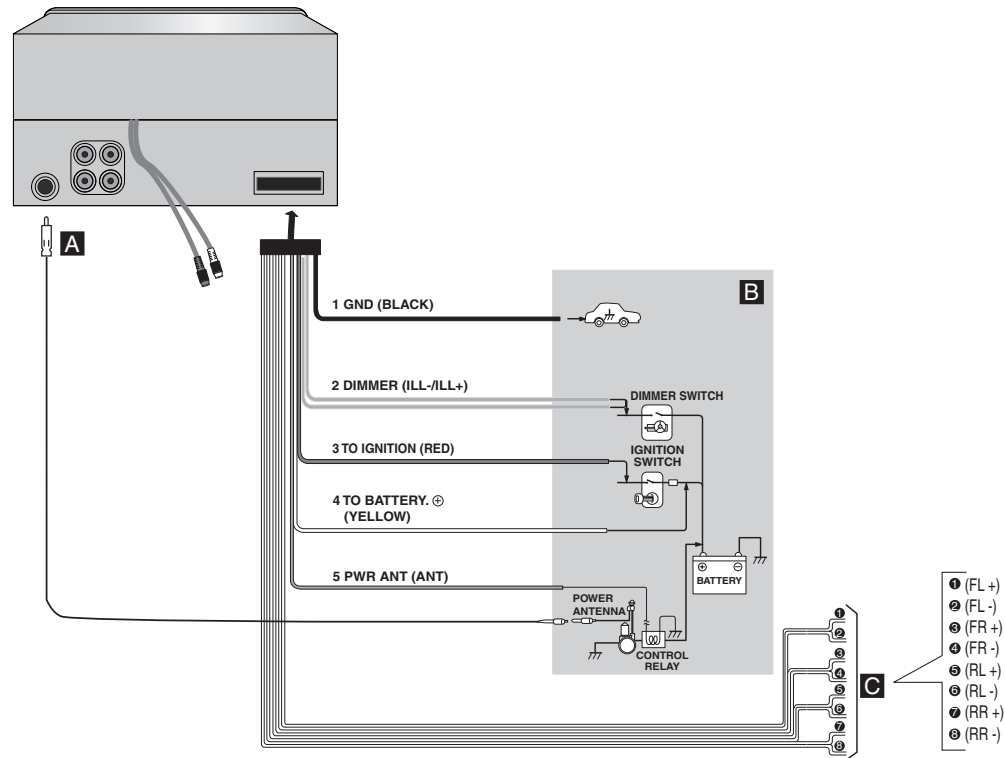

PREPARATION



# Connections

## Connecting to the Car

### A From the antenna

### B To the wiring of vehicle leads Colors

- 1 **GND (BLACK)** : This lead is for connection to the Ground.
- 2 **ILL-/ILL+** : This lead is for connection to the Dimmer line
- 3 **ACC(RED)** : This lead is for connection to the terminal from which the power is supplied when the ignition switch is set to ACC.
- 4 **B+(YELLOW)** : This lead is for connection to the Battery (back-up) terminal from which the power is always supplied.
- 5 **ANT** : This lead is for connection to the power antenna.

### C Speaker Connections

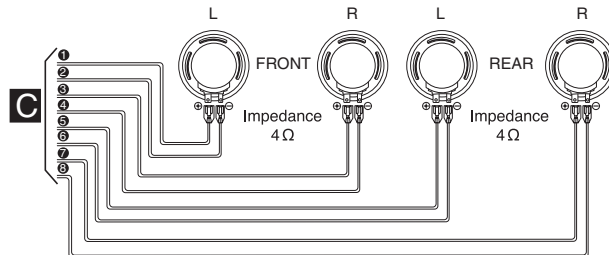

## Connecting to Optional Equipment

You can use VCR or other unit connected to the AUX IN connector.

1. Connect a VCR or auxiliary device, etc to the AUX IN connector.
2. Press **POWER/SOURCE** (⏻) button to select the AUX IN.
  - Connect the **AUDIO OUTPUT** connector of this unit to the **AUDIO INPUT** connector of Auxiliary Equipment.

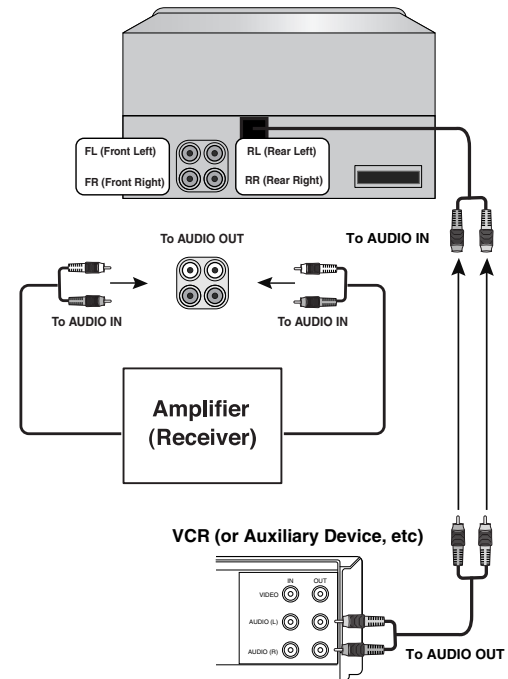

PREPARATION



## Basic Operation

### Turning the unit on

Press **POWER/SOURCE** (⏻) or any other button on the front panel.

### Turning the unit off

Press **POWER/SOURCE** (⏻) on the front panel for more than 1.2 seconds to turn the unit off.

### Selecting a source

You can select a source you want to listen to.

Press **POWER/SOURCE** (⏻) to select a source.

Press **POWER/SOURCE** (⏻) repeatedly to switch between the following sources:

Tuner → CD → AUX IN → Tuner...

### **NOTE**

- When you turn the unit off, the current volume level is automatically memorized. Whenever you turn the unit back on, it will operate at the memorized volume level.

### Adjusting the volume

Use **VOLUME** to adjust the sound level.

Rotate the **VOLUME KNOB** on the front panel to increase or decrease the volume.





## Basic Operation

### SOUND Adjustment

#### Using the EQ (Equalizer)

The equalizer lets you adjust the equalization to match the acoustic characteristics of the car's interior as desired. There are 5 stored equalizer curves which you can easily recall at any time.

Here is a list of the equalizer curves:

- EQ POP : Reproduces pop music acoustics.
- EQ CLASSIC : Reproduces orchestral music acoustics.
- EQ ROCK : Reproduces rock music acoustics.
- EQ JAZZ : Reproduces jazz music acoustics.
- EQ VOCAL: Reproduces vocal music acoustics.

1. Press **EQ/XDSS** on the front panel to select the equalizer.
2. Press **EQ/XDSS** repeatedly to choose between the following Equalizer settings.  
POP → CLASSIC → ROCK → JAZZ → VOCAL  
→ FLAT (NO display) → POP...

#### **MUTE**

1. Press **MUTE** to cut the sound.
2. To cancel it press **MUTE** again.(or any other button on the front panel.)

#### **SOUND OPT.MENU**

1. Press the **SOUND OPT.MENU** button repeatedly to select the mode you want to adjust from volume, bass, treble, balance and fader. The mode indicator lights up in the following order.

→ VOL → BAS → TRB → BAL → FAD ]

2. Turn left or right CONTROL UP/DOWN to adjust the sound quality.

	Turn right	Turn left
<b>VOL</b>	Increase the volume level.	Decrease the volume level.
<b>BAS</b>	Increase the bass level.	Decrease the bass level.
<b>TRB</b>	Increase the Treble level.	Decrease the Treble level.
<b>BAL</b>	Decrease the level of the left speaker(s).	Decrease the level of the right speaker(s).
<b>FAD</b>	Decrease the level of the front speaker(s).	Decrease the level of the rear speaker(s).

#### **NOTE**

The unit cannot adjust the bass and treble in the **EQ/XDSS** on mode.

#### **XDSS (Extreme Dynamic Sound System)**

**XDSS ON** : Press and hold the **EQ/XDSS** button to reinforce treble, bass and surround effect.

**XDSS OFF** : To cancel it press and hold **EQ/XDSS** again.



## RDS Operation

### RDS Display Options

In normal RDS operation the display will indicate the station name. Pressing **DISP** on the front panel enables you to cycle through the various data types in the sequence:

(FREQUENCY→PTY→RT→PS)

- **PTY** (Program type recognition)
- **RT** (Radio text recognition)
- **PS** (Program Service name)
- **PI** (Program Identification)
- **AF** (Alternative Frequencies for the actual program)
- **TP** (Traffic Program Identification)
- **TA** (Traffic Announcement Identification)
- **EON** (Enhanced Other Networks)

### NOTES

- RDS is only available for FM reception.

### RDS AF/REG FUNCTION

To switch on or off the AF function (Network-Tracking), shortly press the '**AF**' button. To switch on or off the REG function (Regional Network Tracking), long press the '**AF**' button more than 2 seconds).

### LOCAL/DX selection in EON-TA mode

In the EON-TA mode, pressing the TA button for more than 2 seconds, causes only local and strong stations to be received. When the TA button is pressed for more than 2 seconds, it receives all stations, including distant and weak ones. It is recommended to set the TA button to the local position to receive local stations with good sound quality.



## RDS Operation

### RDS MODE Adjustment

1. Press the **SOUND OPT.MENU** button for more than 1.2 seconds it is activated selecting mode.
2. After, pressing **SOUND OPT.MENU** button repeatedly for selecting.
3. Turn left or right **CONTROL UP/DOWN** to select the indicator.

### TA SEEK mode

When the newly tuned station does not receive TP information for 5 sec, the receiver retunes to the next station which has the same PI as the last station's, but has the TP information.

### TA ALARM mode

When a newly tuned station has no TP information for 5 sec, a double beep sound is output.

### PI SOUND mode

If the sound of a station with different PI is heard intermittently, the receiver mutes the sound after 1 second.

### PI MUTE mode

If the situation described above is repeated, the receiver instantly mutes the sound.

### RETUNE L mode

The waiting time for starting TA search or PI search is programmable. Retune time is set to 90 seconds.

### RETUNE S mode

The waiting time for starting TA search or PI search is selectable. Retune time is set to 30 seconds.

### BEEP 2ND mode

The beep is only generated when a key is long pressed (1 sec)

### BEEP ALL mode

The beep is generated when any key is pressed.



## Radio Operation

### Listening to radio stations

1. Press the **POWER/SOURCE** (⏻) button to turn the unit on.
  - When you select a source the unit is turned on.
2. Press the **POWER/SOURCE** (⏻) button to select the tuner.
3. Press the **BAND** button to select a band.
  - Press the **BAND** button until the desired band is displayed, FM1, FM2, FM3, MW(AM).
4. To perform seek tuning, press the ◀-/+▶ with quick presses.
  - The tuner will scan the frequencies until a broadcast with strong enough reception is found.
  - You can cancel seek tuning by pressing the ◀-/+▶ with quick presses.
5. To perform manual tuning, press and hold the ◀-/+▶ on the remote control for 1 second. And then press the ◀-/+▶ with quick presses.
  - The frequencies move up or down step by step.

#### **NOTES**

- When the selected frequency is being broadcast in stereo, the “((S T))” indicator will light.

### Auto Search Memory

This function lets you automatically store the six strongest broadcast frequencies.

1. Press the **POWER/SOURCE** (⏻) button to select the tuner.
2. Press the **AS/PS** button on the front panel for about 1 second.
  - Scanning starts from the currently displayed frequency to higher frequencies and stops when 6 stations have been preset or the receivable frequencies have been scanned once.

#### **NOTES**

- The presetting is not performed if there is no station to be tuned in.
- When automatic presetting is performed, the previous preset stations are automatically erased.
- To stop the automatic presetting, press the **BAND** or the **AS/PS** button.

#### **To scan the preset stations**

Press the **AS/PS** button on the front panel.  
To stop the scanning, press the **AS/PS** button.

#### **To tune in the preset stations**

Press **BAND** to select the desired band and press the desired number buttons (1-6) on the remote control.  
The number of the preset station button is displayed and the preset station is received.

### Storing and recalling broadcast frequencies

You can easily store up to six broadcast frequencies for later recall with the touch of a button.

1. Select the desired frequency
2. Press one of the **preset station** buttons (1 - 6) for more than 1 seconds. The number of the pressed preset station button is displayed.
3. Repeat steps 1 and 2 to preset other stations.

#### **NOTES**

- As F1, F2, F3 have the same frequency range, up to 18 station can be preset for FM.
- When a station is preset on the preset station button on which another station of the same band has already been preset, the previously preset station is automatically erased.



## Operation with Audio CD, MP3/WMA Disc

### Playing an Audio CD and MP3/WMA Disc

**CD** **MP3** **WMA**

The unit can play MP3/WMA formatted recordings on CD-ROM, CD-R or CD-RW discs.

Before playing MP3/WMA recordings, read the notes on MP3/WMA Recordings on page 16 (backcover page).

### **Pause** **CD** **MP3** **WMA**

1. Press **PLAY/PAUSE** (▶/||) during playback.
2. To return to playback, press **PLAY/PAUSE** (▶/||) again.

### **Moving to another Track** **CD** **MP3** **WMA**

- Press the ◀ -/+ ▶ briefly during playback to go to the next track or to return to the beginning of the current track.
- Press ◀ - twice briefly to step back to the previous track.  
(If playing times is less then 3 seconds this function is not operated.)

### **Search** **CD**

Press and hold the ◀ -/+ ▶ for about 1 second during playback and then release at the point you want.



## Operation with Audio CD, MP3/WMA Disc

### Repeat

1. Press **RPT** during playback. **CD** **MP3** **WMA**  
The "RPT" appears in the display window.  
(All of the music on the disc is played repeatedly)
2. Press **RPT** again.  
The "RPT" disappears in the display window.  
(The repeat mode is cancelled.)

### Shuffle

1. Press **SHF** during playback. **CD** **MP3** **WMA**  
The "SHF" appears in the display window.  
(All of the music on the disc is played randomly)
2. Press **SHF** again.  
The "SHF" disappears in the display window.  
(The random playback is cancelled.)

### NOTE

- During random playback, if you press **◀** - button, you won't go back to the previous track

### MP3/WMA TRACK -10/+10

During playback, press the -10 button to go back to the previous 10th track, and press +10 button to go forward to the next 10th track.

### Intro scan

1. Press **SCAN**. **CD** **MP3** **WMA**  
The "SCAN" appears in the display window.  
(The first 10 seconds of all of the songs on the disc is played)
2. Press **SCAN** again.  
The "SCAN" disappears in the display window.  
(The intro scan is cancelled.)

### ID3 TAG **MP3** **WMA**

When playing a disc containing information, you can see the information (ID3 TAG, Title, Artist and Album) in the display window. If there is no information "NO TEXT" will be shown in the display window.

Press the **DISP** button twice during MP3/WMA file playback.



## Troubleshooting

Symptom	Cause	Correction
Power doesn't turn on. The unit doesn't operate.	<ul style="list-style-type: none"><li>• Leads and connectors are not properly connected.</li><li>• The fuse is blown.</li><li>• Noise and other factors are causing the built-in microprocessor to operate incorrectly.</li></ul>	<ul style="list-style-type: none"><li>• Confirm once more that all connections are correct.</li><li>• Rectify the problem that caused the fuse to blow, and then replace it. Be very sure to install the correct fuse with the same rate.</li><li>• Turn the unit off and then on.</li></ul>
Playback is not possible.	<ul style="list-style-type: none"><li>• The disc is dirty.</li><li>• The loaded disc is of a type this unit cannot play.</li></ul>	<ul style="list-style-type: none"><li>• Clean disc.</li><li>• Check what type the disc is.</li></ul>
No sound is heard. The volume level will not rise.	<ul style="list-style-type: none"><li>• Cables are not connected correctly.</li></ul>	<ul style="list-style-type: none"><li>• Connect the cables correctly.</li></ul>
There's no sound.	<ul style="list-style-type: none"><li>• The volume level is low.</li></ul>	<ul style="list-style-type: none"><li>• Adjust the volume.</li></ul>
There's audio skipping.	<ul style="list-style-type: none"><li>• This unit is not firmly secured.</li></ul>	<ul style="list-style-type: none"><li>• Secure this unit firmly.</li></ul>

REFERENCE

## Specifications

**MP3/WMA Disc compatibility with this unit is limited as follows:**

1. Sampling Frequency / 32 - 48kHz (MP3)  
22.05 - 48kHz (WMA)
2. Bit rate / within 32 - 320kbps (include VBR) (MP3)  
16 - 192kbps (WMA)
3. CD-R/CD-RW physical format should be "ISO 9660"
4. If you record MP3/WMA files using software which cannot create a FILE SYSTEM, for example "Direct-CD" etc., it is impossible to playback MP3/WMA files. We recommend that you use "Easy-CD Creator" which creates an ISO9660 file system.

**Customers should also note that permission is required in order to download MP3/WMA files and music from the Internet. Our company has no right to grant such permission. Permission should always be sought from the copyright owner.**

### General

Output Power	.50W x 4CH(Max.)
Power Source	DC 12 V
Speaker impedance	.4 $\Omega$
Ground System	Negative type
Dimensions (W x H x D)	.188 x 100 x 173 mm (Without Front Panel)
Net Weight (approx.)	1.78 kg

### FM tuner

Frequency Range	87.5-107.9MHz or 87.5-108 MHz or 65-74 MHz, 87.5-108 MHz
S/N Ratio	.55 dB
Distortion	.1.0%
Usable sensitivity	.12 dB $\mu$ V

### MW(AM) tuner

Frequency Range	.520-1720kHz or 522-1620 kHz
S/N Ratio	.45 dB
Distortion	.1.0%
Usable sensitivity	.32 dB $\mu$ V

### CD

Frequency Response	.40 - 20000 Hz
S/N Ratio	.70 dB
Distortion	.0.15%

- Design and specifications are subject to change without notice.

P/NO : 3834RR0031X