



Safety Precautions

Please read these safety precautions carefully before using the product.

 **Warning** If you ignore the warning message, you may be seriously injured or there is a possibility of accident or death.

 **Caution** If you ignore the caution message, you may be slightly injured or the product may be damaged

Precautions in installing the Product

Warning

- **Keep away from heat sources like electrical heaters.**
 - Electrical shock, fire, malfunction or deformation may occur.
- **Keep the packing anti-moisture material or vinyl packing out of the reach of children.**
 - Anti-moisture material is harmful if swallowed. If swallowed by mistake, force the patient to vomit and visit the nearest hospital. Additionally, vinyl packing can cause suffocation. Keep it out of the reach of children.
- **Do not put heavy objects on the product or sit upon it.**
 - If the product collapses or is dropped, you may be injured. Children must pay particular attention.
- **Do not leave the power or signal cable unattended on the pathway.**
 - The passerby can falter, which can cause electrical shock, fire, product breakdown or injury.
- **Install the product in a neat and dry place.**
 - Dust or moisture can cause electrical shock, fire or product damage.
- **If you can smell smoke or other odors or hear a strange sound unplug the power cord and contact the service center.**
 - If you continue to use without taking proper measures, electrical shock or fire can occur.
- **If you dropped the product or the case is broken, turn off the product and unplug the power cord.**
 - If you continue to use without taking proper measures, electrical shock or fire can occur. Contact the service center.
- **Do not drop metallic objects such as coins, hair pins, chopsticks or wire into the product, or inflammable objects such as paper and matches. Children must pay particular attention.**
 - Electrical shock, fire or injury can occur. If a foreign object is dropped into the product, unplug the power cord and contact the service center.

Caution

- **Make sure the product ventilation hole is not blocked. Install the product in a suitably wide place (more than 10cm from the wall)**
 - If you install the product too close to the wall, it may be deformed or fire can break out due to internal heat.
- **Do not block the ventilation hole of the product by a tablecloth or curtain.**
 - The product can be deformed or fire can break out due to overheating inside the product.
- **Install the product on a flat and stable place that has no risk of dropping the product.**
 - If the product is dropped, you may be injured or the product may be broken.
- **Install the product where no EMI occurs.**
- **Keep the product away from direct sunlight.**
 - The product can be damaged.

Safety Precautions

Electrical Power Related Precautions

Warning

- **Make sure to connect the power cable to the grounded current.**
 - You may be electrocuted or injured.
- **Use the rated voltage only.**
 - The product can be damaged, or you may be electrocuted.
- **During a thunder or lightning storm, unplug the power cable or signal cable.**
 - You may be electrocuted or a fire can break out.
- **Do not connect several extension cords, electrical appliances or electrical heaters to a single outlet. Use a power bar with a grounding terminal designed for exclusive use with the computer.**
 - A fire can break out due to overheating.
- **Do not touch the power plug with wet hands. Additionally, if the cord pin is wet or covered with dust, dry the power plug completely or wipe dust off.**
 - You may be electrocuted due to excess moisture.
- **If you don't intend to use the product for a long time, unplug the power cable from the product.**
 - Covering dust can cause a fire, or insulation deterioration can cause electric leakage, electric shock or fire.
- **Fix the power cable completely.**
 - If the power cable is not fixed completely, a fire can break out.
- **Hold the plug when pulling out the power cable. Do not bend the power cord with excessive force or put heavy objects on the power cord.**
 - The power line can be damaged, which may cause electric shock or fire.
- **Do not insert a conductor (like a metal chopstick) into one end of the power cable while the other end is connected to the input terminal on the wall. Additionally, do not touch the power cable right after plugging into the wall input terminal.**
 - You may be electrocuted.
- **The power supply cord is used as the main disconnection device. Ensure that the socket-outlet is easily accessible after installation.**

Caution

- **Do not unplug the power cord while the product is in use.**
 - Electrical shock can damage the product.

Precautions in Moving the Product

Warning

- **Make sure to turn off the product.**
 - You may be electrocuted or the product can be damaged.
- **Make sure to remove all cables before moving the product.**
 - You may be electrocuted or the product can be damaged.

Safety Precautions

Caution

- **Do not shock the product when moving it.**
 - You may be electrocuted or the product can be damaged
 - **Do not dispose the product-packing box. Use it when you move.**
 - **Make the panel face forward and hold it with both hands to move.**
 - If you drop the product, the damaged product can cause electric shock or fire. Contact with the service center for repair.
-

Precautions in Using the Product

Warning

- **Do not disassemble, repair or modify the product at your own discretion.**
 - Fire or electric shock accident can occur.
 - Contact the service center for check, calibration or repair.
- **Do not spray water on the product or scrub with an inflammable substance (thinner or benzene).**
Fire or electric shock accident can occur
- **Keep the product away from water.**
 - Fire or electric shock accident can occur.

Caution

- **Do not put or store inflammable substances near the product.**
 - There is a danger of explosion or fire due careless handling of the inflammable substances.
 - **When cleaning the brown tube surface, unplug the power cord and scrub with soft cloth to prevent scratching. Do not clean with a wet cloth.**
 - The water can sink into the product, which can cause electric shock or serious malfunction.
 - **Take a rest from time to time to protect your vision.**
 - **Keep the product clean at all times.**
 - **Take a comfortable and natural position when working with a product to relax the muscles.**
 - **Take a regular break when working with a product for a long time.**
 - **Do not press strongly upon the panel with a hand or sharp object such as nail, pencil or pen, or make a scratch on it.**
 - **Keep proper distance from the product.**
 - Your vision may be impaired if you look at the product too closely.
 - **Set the appropriate resolution and clock by referring to the User's Guide.**
 - Your vision can be impaired.
 - **Use authorized detergent only when cleaning the product. (Do not use benzene, thinner or alcohol.)**
 - Product can be deformed.
-

On Disposal

- The fluorescent lamp used in this product contains a small amount of mercury.
- Do not dispose of this product with general household waste.
Disposal of this product must be carried out in accordance to the regulations of your local authority.

Name and Function of the Parts

Name of the Remote Control Buttons



MUTE

Use the this button so that no sound comes out temporarily.

POWER

Able to power On/Off.

SOURCE

INPUT SELECT

TV
AV1
AV2
S-Video
RGB
DVI

If you press the button once, the following Input Signal Window will appear. Select the signal type you want using the ▲ ▼ button.

TV/AV : TV/AV button.

TV → AV1 → AV2 → S-Video

I/II : Bilingual choice and sound mode selection

Press this button.

[TV]

- To switch from **Stereo** to **Mono** sound in case of stereo transmission, or from **Nicam Stereo** to **Nicam Mono**, in case of digital transmission.
- to switch from **Nicam Dual I** to **Nicam Dual II** or **Nicam Dual I+II** in case of Nicam Dual transmission.
- to choose between **Dual I**, **Dual II** or **Dual I+II** in case of bilingual transmission :
 - Dual I** sends the primary broadcast language to the loudspeakers ;
 - Dual II** sends the secondary broadcast language to the loudspeakers ;
 - Dual I+II** sends a separate language to each loudspeakers.

[AV]

In AV mode, you can select output sound for the left and right loudspeakers.

Repeatedly press the **I/II** button to select the sound output.

- L+L : Audio signal from audio L input is sent to left and right loud-speakers.
- L+R : Audio signal from audio L input is sent to left loud-speaker and audio signal from audio R input is sent to right loud-speaker.
- R+R : Audio signal from audio R input is sent to left and right loud- speakers.

■ **NOTE** : In case of weak stereo sound signals, with stereo or Nicam stereo transmission, select mono reception.

Name and Function of the Parts

● Name of the Remote Control Buttons



MENU

Use this button to enter the On Screen Display menu.

EXIT

Use this button to exit the On Screen Display menu.

***/SSM (Sound Status Memory)**

Use this button to select the sound tone.

Press repeatedly to select **Flat, Music, Movie, Speech, User** sound tone.

PR (▲ ▼) Buttons

Able to change channel.

VOL (◀ ▶) Buttons

Able to adjust sound.

OK Button

Use when functional adjustment is completed.

Number buttons

Able to directly select and change channel.

AUTO Button

- This function is to automatically search the available channels. It is available to the TV signal inputs only.
- This function is to automatically adjust your display image to the ideal settings for the current screen resolution size (display mode). It is available to the PC analog signal input only.

SWAP function Button

To switch the main-screen and sub-screen in PIP/POP/PBP mode.

● Inserting batteries into remote control.

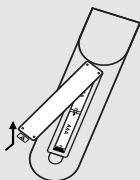

1. Take out the battery cap.

2. Insert the batteries with correct polarity (+/-).

3. Close the battery cap.

- You can use a remote control 7 meter distance and 30 degree (left/right) within the receiving unit scope.
- Dispose of used batteries in the recycle bin to prevent environmental pollution.

Name and Function of the Parts

● Name of the Remote Control Buttons



SLEEP : SLEEP Timer

You can set a time period after which the TV / AV1 / AV2 / S-Video should switch itself to standby. Press the key repeatedly to select the number of minutes.

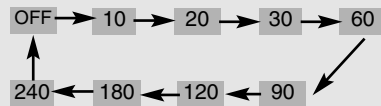

LIST : Programme list

To display the programme list (0~ 99).

PROGRAMME LIST			
0	1	2	3
4	5	6	7
8	9	10	11
12	13	14	15
16	17	18	19

Note: TV channels displayed in blue have been setup to be skipped in the Programme Edit menu

Q.VIEW : QUICK VIEW Button

* Favourite Program On : Rotate Favourite channel.

* Favourite Program Off : To display the previously selected TV channel.

APC / PSM Button

Press repeatedly to select **Dynamic**, **Standard**, **Mild**, **Game** or **User** picture mode. This function is not supported in PC mode.

Name and Function of the Parts

Remote Control - PIP/POP/PBP function



1. Swap Button

You can swap the main screen and the sub-screen when the PIP/POP/PBP function is used.

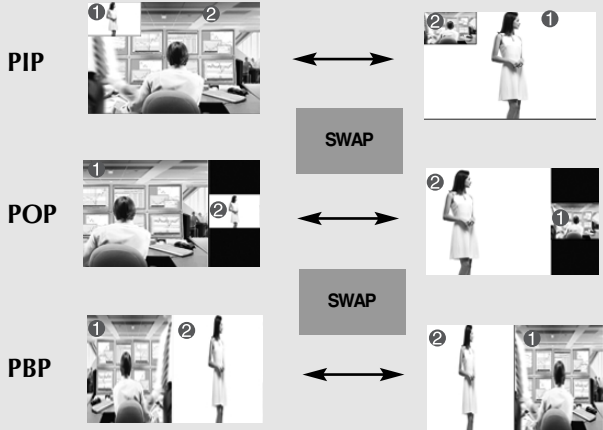

2. PIP (Picture in Picture) Button

The sub-screen is changed in the order shown below.

: SMALL -> MEDIUM -> LARGE -> OFF

3. POP (Picture out Picture) Button

The sub-screen moves to the next mode whenever you press this button.

: POP ON -> PBP(FULL) -> PBP(4:3) -> OFF



POP ON

PBP (FULL)

PBP (4:3)

<Table of PIP/POP/PBP Function Support>

Main Screen Sub-Screen	DVI	RGB	TV	AV1	AV2	S-Video
DVI	X	X	●	●	●	●
RGB	X	X	●	●	●	●
TV	●	●	X	X	X	X
AV1	●	●	X	X	X	X
AV2	●	●	X	X	X	X
S-Video	●	●	X	X	X	X

When 'Input Signal 1' comes on in the main screen, only 'Input Signal 2' can be displayed on the sub-screen. On the contrary, if the main screen displays 'Input Signal 2', the sub-screen can display 'Input Signal 1' only. You can swap 'Input Signal 1' and 'Input Signal 2' using the SWAP button.

Name and Function of the Parts

Remote Control - Using the Teletext function

Please select your local teletext language. (page A29)

If you don't, the teletext may not appear correctly on the screen.



MODE

The mode will be switched in the Teletext mode.

TIME

When viewing a TV programme, press this button to display the time at the top right hand corner of the screen.
press this button to select a sub page number. The sub page number is displayed at the bottom of the screen. To hold or change the sub page, press the RED/GREEN, ▲ ▼ or NUMBER buttons. Press again to exit this function.

MIX

Display the teletext pages superimposed on the TV picture. To switch the TV picture off press this button again.

REVEAL

Press the button to reveal/conceal the hidden information, such as solutions to riddles and puzzles. Press this button again to remove the information from the display.

Name and Function of the Parts

Remote Control - Using the Teletext function

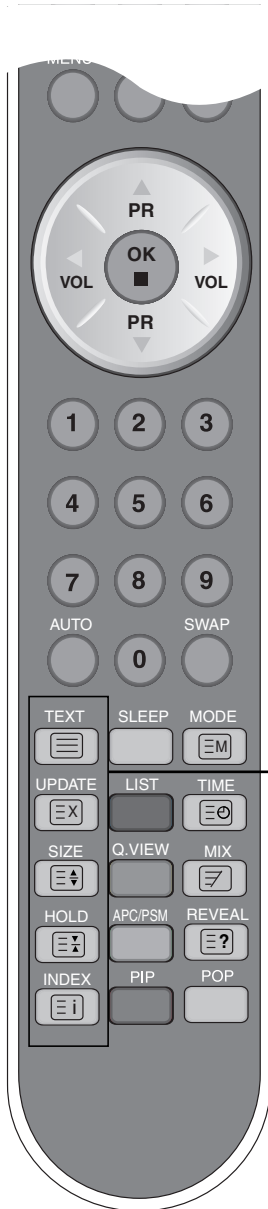

TEXT

To select the teletext on or off. The main index page or the last selected page appears on the screen together with an information headline and an option line at the bottom of the screen.

UPDATE

Press the button to appear the TV programme. At the top of screen indicates that you are still in the teletext mode. Before interrupting teletext, you may select a page number. When the page has been found, the information line appears briefly on your screen. Press the button again to reappear teletext.

SIZE

Press the button repeatedly to display the upper part, the lower part and then to return to the normal page size.

HOLD

Press the button to stop the automatically rotating of the sub-pages. Press the button again to continue the automatic rotating again.

INDEX

To display the main index.

Name and Function of the Parts

Rear View

To connect the input signal cable, audio cable, and others, pull out and eliminate the back cap using the handle.

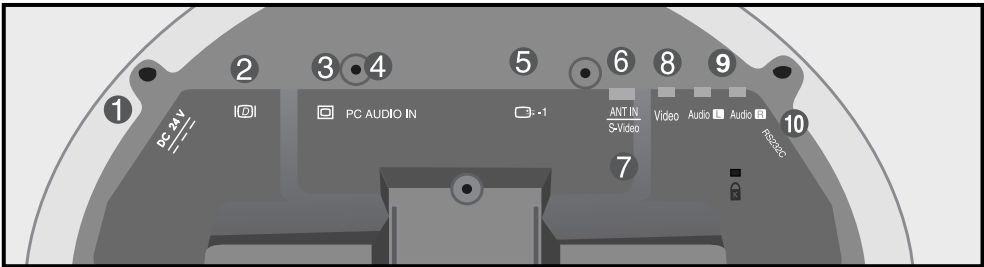
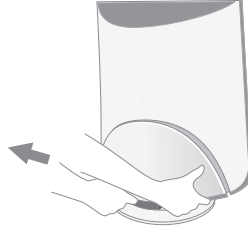

- ① Power Connector : Connect the DC Adapter
- ② D-Sub Analogue Signal Connector
- ③ DVI Signal Connector
- ④ PC Sound Jack
: Connect the audio cable to the *LINE OUT jack of the PC sound card.
- ⑤ SCART Input/Output Terminal : Connect the SCART cable.
- ⑥ TV Tuner Jack : Connect the antenna cable.
- ⑦ S-Video Input Terminal.
- ⑧ Video(CVBS) Input Terminal.
- ⑨ Audio(CVBS) Input Terminal.
- ⑩ RS-232C Serial Ports

*LINE OUT

A terminal used to connect to the speaker including a built-in amplifier (Amp). Make sure that the connecting terminal of the PC sound card is checked before connecting. If the Audio Out of PC sound card has only Speaker Out, reduce the PC volume.

If the Audio Out of the PC sound card supports both Speaker Out and Line Out, convert to Line Out using the card jumper of the program (Refer to the Sound Card Manual).

Connecting to External Devices

■ ■ ■ When Connecting to your PC

1 First of all, see if the computer, product and the peripherals are turned off. Then, connect the signal input cable and audio cable.

A When connecting with the DVI-D signal input cable.

B When connecting with the D-Sub signal input cable.

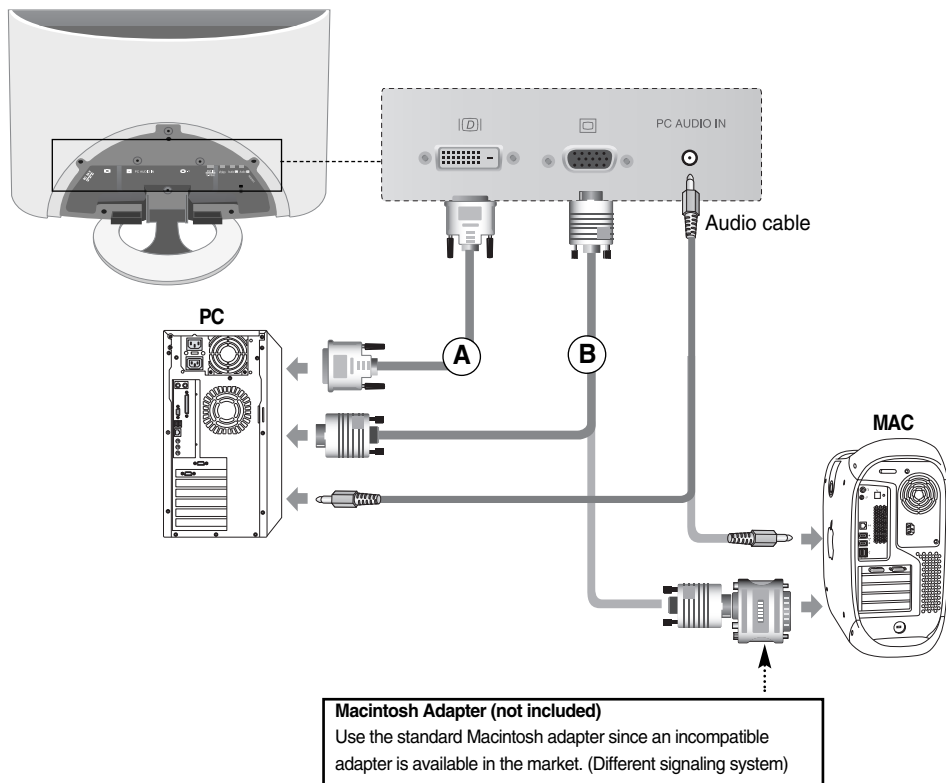

2 Connect the power cord.

* When connecting to a wall outlet.

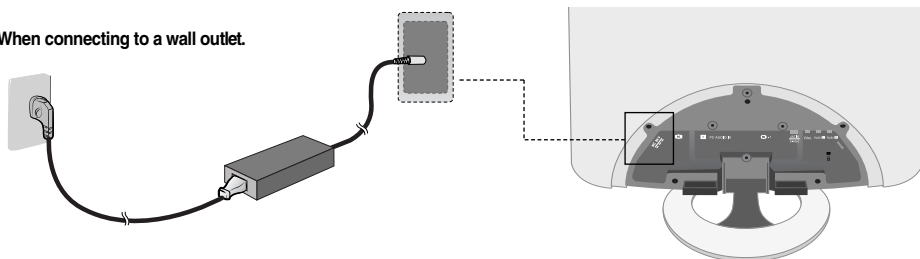

Connecting to External Devices

- 3 Turn on power by touching the Power On/Off sensor on the product.

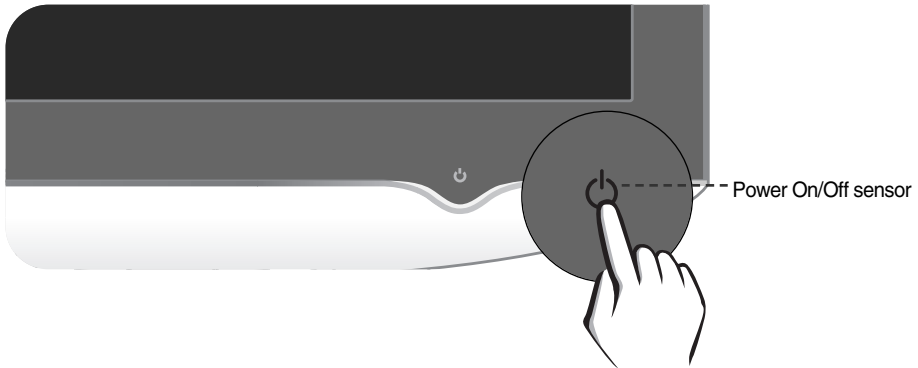

- 4 Turn on the PC.

- 5 Select an input signal.
Press the SOURCE button on the remote control to select the input signal.

SOURCE → ▼▲ → OK

Or, press the SOURCE button at the front side of the product.

SOURCE → ▼▲ → SET/AUTO

- A** When connecting with a DVI-D signal input cable.
• Select **DVI** : DVI-D digital signal.
- B** When connecting with a D-Sub signal cable.
• Select **RGB** : D-Sub analogue signal.

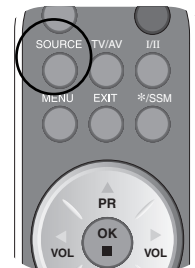
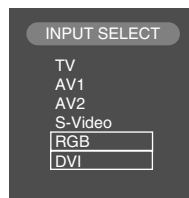

Note

- **How to connect to two computers.**
Connect the signal cables (DVI and D-Sub) to each computer.
Press the SOURCE button in a remote control to select the computer to use.
- **Directly connect to a grounded power outlet on the wall or a power bar with a ground wire.**

Connecting to External Devices

■ ■ ■ When watching VCR/DVD

- 1 **A** Connect the video cable as shown in the below figure and then connect the power cord (See page A11).

When connecting with a SCART cable.

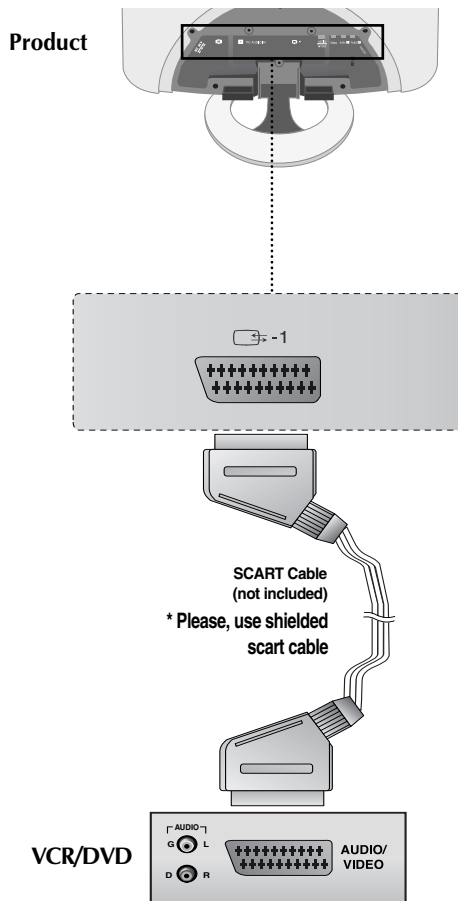

Connecting to External Devices

B When connecting with a S-Video cable /RCA cable.

- Connect to the S-Video input terminal to watch high image quality movies.

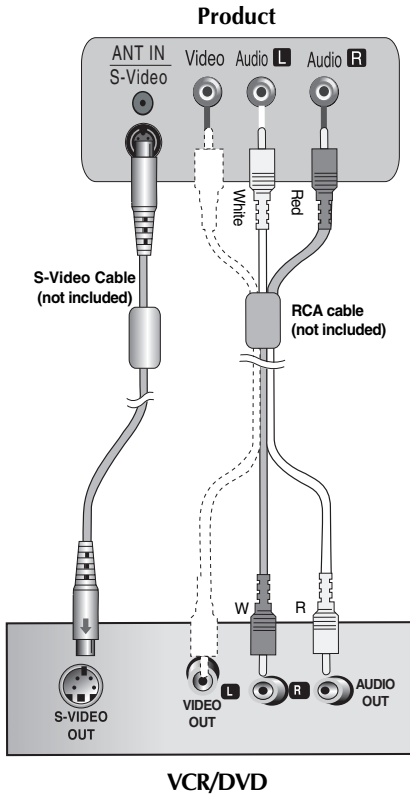

C When connecting with a RCA cable.

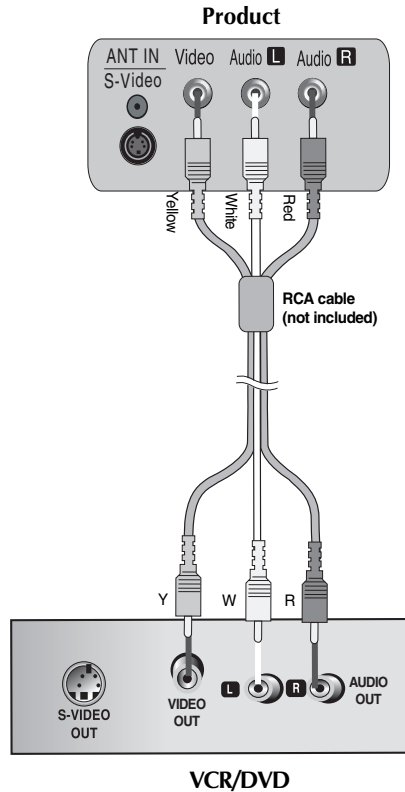

2 Select an input signal.

Press the **SOURCE** button on the remote control to select the input signal.

SOURCE → ▼▲ → OK

Or, press the **SOURCE** button at the front side of the product.

SOURCE → ▼▲ → SET/AUTO

- A** When connecting with an SCART cable.
 - Select **AV1**
- B** When connecting with an S-Video cable/ RCA cable.
 - Select **S-Video**
- C** When connecting with a RCA cable.
 - Select **AV2**

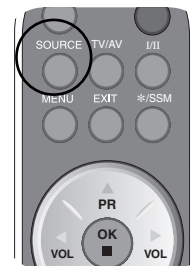
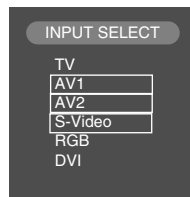

Connecting to External Devices

■ ■ ■ When watching HDTV/DVD

- 1 Connect the video/audio cable as shown in the below figure and then, connect the power cord (See page A11).

When connecting with a COMPONENT board.

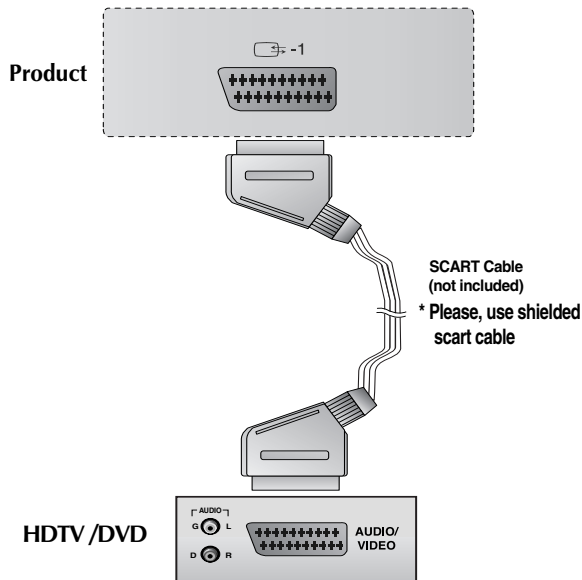

- 2 Select an input signal.
Press the SOURCE button on the remote control to select the input signal.

SOURCE → ▼▲ → OK

Or, press the SOURCE button at the front side of the product.

SOURCE → ▼▲ → SET/AUTO

When connecting with an SCART cable.

- Select AV1

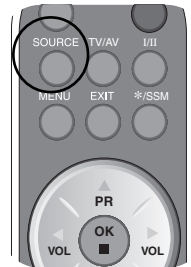
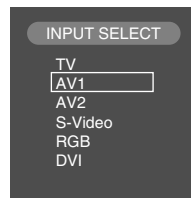

Connecting to External Devices

■ ■ ■ When watching DVI-D(HDCP) from the DVD/Set-top BOX

- 1 When connecting the video/audio cable as shown in the below figure and then connect the power cord. (See page A11)

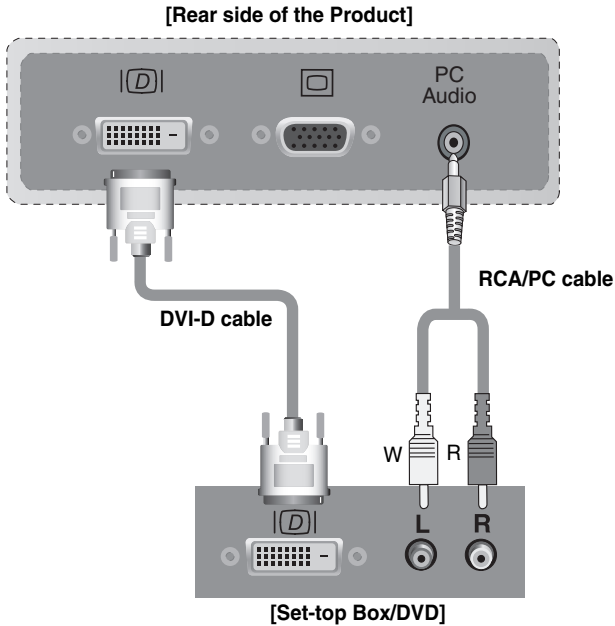

- 2 Press the SOURCE button at the front side of the product.

SOURCE → ▼▲ → SET/AUTO

- Select DVI

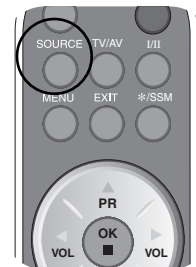
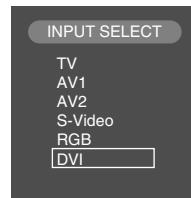

Connecting to External Devices

■ ■ ■ When watching the TV

- 1 See if the antenna cable is connected at the rear side of the product and then, connect the power cord (see page A11).

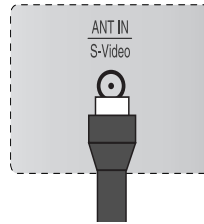
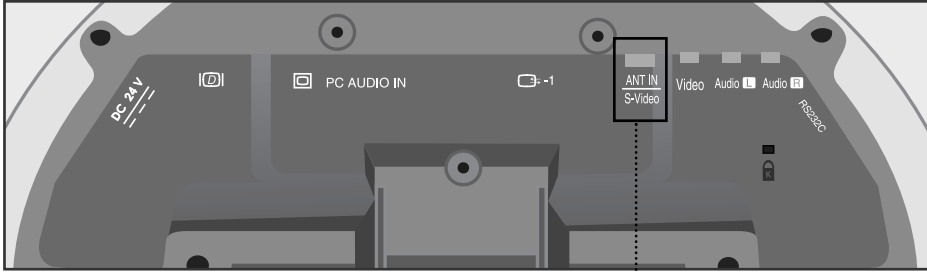

Antenna Cable
(Not Included)

- 2 Select an input signal.
Press the SOURCE button on the remote control to select the input signal.

SOURCE → ▼▲ → OK

Or, press the SOURCE button at the front side of the product.

SOURCE → ▼▲ → SET/AUTO

- Select TV

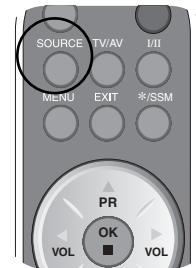
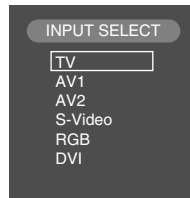

Connecting to External Devices

■ ■ ■ To arrange the cables

- 1 After connecting the cables neatly, arrange the cables to the **Cable Holder** as shown in the following figure.

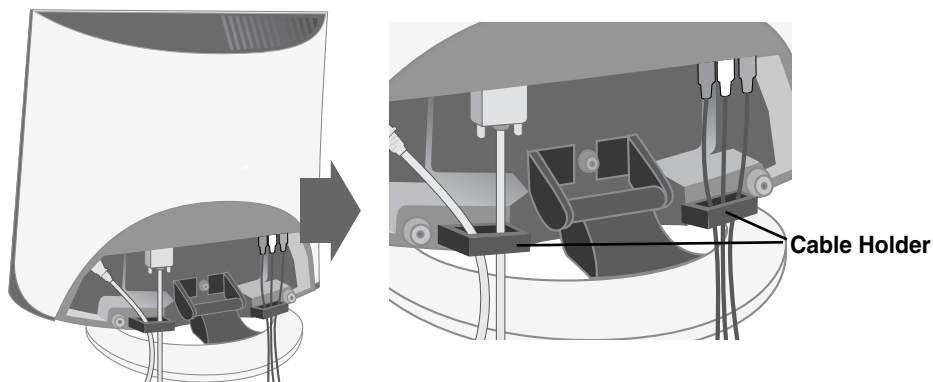

- 2 After connecting the cable, push and close the back cap using both hands as shown in the picture below.



Selecting and Adjusting the Screen

● Name of the Buttons in the Screen Adjustment Unit

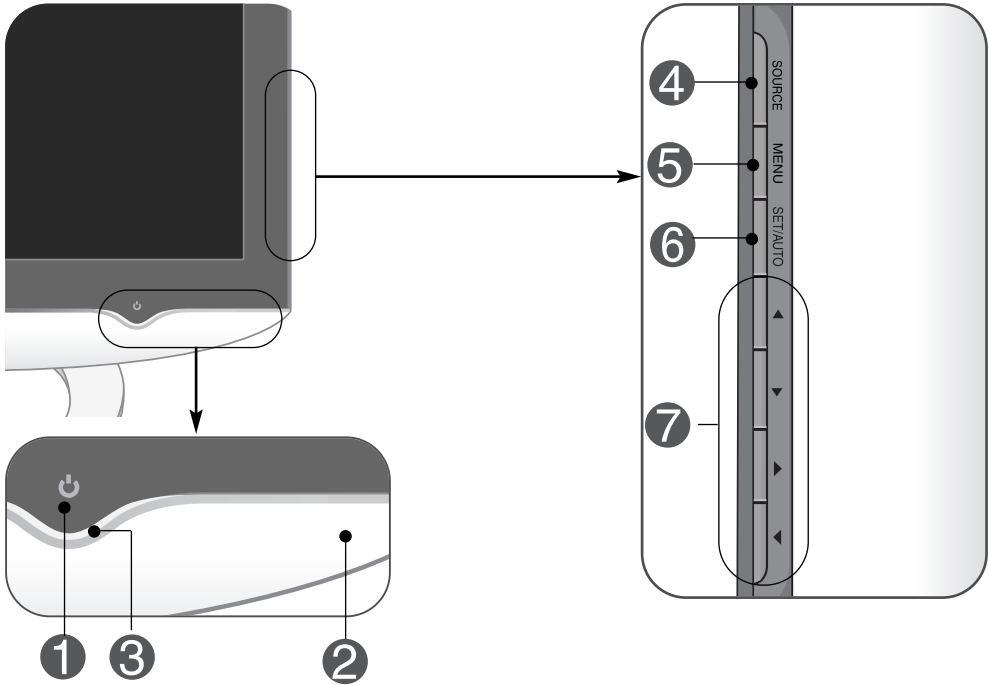

1

**Power On/Off
sensor**

- Touch the Power On/Off sensor to turn on the power.
Touch the Power On/Off sensor again to turn it off.

2

IR Receiver

- The unit that receives the signal from the remote control.
(Cannot be seen from the exterior.)

3

Power Indicator

- This Indicator lights up blue when the display operates normally (on mode). If the display is in sleep (Energy Saving) mode, this indicator colour changes to amber.

Selecting and Adjusting the Screen

● Name of the Buttons in the Screen Adjustment Unit

4

SOURCE Button

SOURCE → ▼▲ → **SET/AUTO**

- Select the input signal

TV	Television
AV1	SCART
AV2	Composite Video
S-Video	Separate Video
RGB	15-pin D-Sub analogue signal
DVI	DVI digital signal

INPUT SELECT

TV
AV1
AV2
S-Video
RGB
DVI

5

MENU Button

- Use this button to show/hide the OSD (On Screen Display) menu screen.

6

SET/AUTO Button

[For PC Analog signal]

Auto in progress

For optimal display change
resolution to 1360 X768

[Other signals]

- The current signal and mode information will be displayed.

7

**OSD Select /
Adjust Button**

- Use this button to select an icon or adjust the setting in the OSD screen.



- Use this button to directly control brightness and contrast of the PC signal (RGB / DVI).

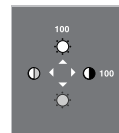







- Adjust the volume.



Selecting and Adjusting the Screen

● OSD (On Screen Display) menu

Icon	Function Description
 STATION	Set/Select the channel when using the TV .
 PICTURE	Adjusting Screen Colour.
 SOUND	Adjusting the audio function.
 TIME	Adjusting the timer function.
 SPECIAL	Selecting the options.
 SCREEN	Screen Adjustment.
 PIP/POP/PBP	Adjusting PIP/POP/PBP Mode (Multiple Screen) Functions.



Note

OSD(On Screen Display)

The OSD function enables you to adjust the screen status conveniently since it provides graphical presentation.

Selecting and Adjusting the Screen



Set/Selects the channel when using the TV

Auto programme

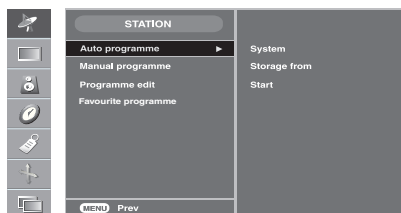

System Press the **▼▲** buttons to select the TV system of the country or part of the world from where you want to receive the TV channels.
If you want to receive 'SECAM L' channel, change the SYSTEM menu to 'L' before launching an automatic search.
L: SECAM L/L (France)
BG : PAL B/G, SECAM B/G (Europe/East Europe)
I : PAL I/II (U.K/Ireland)
DK : PAL D/K, SECAM D/K (East Europe)

Storage from To select a programme number or enter the programme number with the number buttons from where you want to start searching for new channels. If you want to keep the channels 1 to 10 stored earlier, enter programme number 11. Your TV search for new channels from number 11 onwards.

Start Press **OK** button to start automatic programming. all available TV channels are searched for and stored automatically. To stop auto programming, press the **MENU** or **EXIT** button. When auto programming is completed, the programme list menu appears.

Manual programme



To change the channel.
(Change each item in Manual Program and press the "Menu" button to save the settings)

System Press the **▼▲** buttons to select the TV system of the country or part of the world from where you want to receive the TV channels.
L: SECAM L/L (France)
BG : PAL B/G, SECAM B/G (Europe/East Europe)
I : PAL I/II (U.K/Ireland)
DK : PAL D/K, SECAM D/K (East Europe)

Storage Press the **▼▲** buttons to select the channel number or enter the programme number with the number buttons in where you want to store channel.

Channel Press the **▼▲** buttons to select V/UHF for aerial channels or CABLE for cable channels. If you know the C-(01~69) or S-channel number(01~47), enter it directly with the digit buttons 0 to 9.
To select the channel reception type. : V/UHF / CABLE

Selecting and Adjusting the Screen



Set/Selects the channel when using the TV

- Name** To see the assigned channel name.
It is possible to change the name stored in the memory or to assign a name to a TV channel which has not yet been entered. A name with up to 5 letters or numbers can be given to the programme numbers 0 to 99.
Press the ◀ ▶ buttons to move cursor to be changed. -> Press the ▼ ▲ buttons to select a character.(space, number 0~9, and alphabet A~Z, +,-) -> Press **OK/MENU** button).
- Search** Use the ◀ ▶ buttons to search next channel backward or forward direction.

Programme edit



- Delete** Press the ▼ ▲ ◀ ▶ buttons to select a TV channel to be deleted. -> Press the red key on the remote control -> The background colour of the selected channel will change to red.
Press the Delete button one more time to delete the selected channel. All the following channels are shifted up one position.
- Copy** Press the ▼ ▲ ◀ ▶ buttons to select a TV channel to be copied. -> Press the green key on the remote control. All the following channel numbers are shifted down one position.
- Move** Press the ▼ ▲ ◀ ▶ buttons to select a channel number to be moved. -> Press the yellow key on the remote control. -> Press the ▼ ▲ ◀ ▶ buttons to move the TV channel to the desired channel number. -> Press the yellow key again to release this function.
- Skip** Press the ▼ ▲ ◀ ▶ buttons to select a channel number to be skipped. -> Press the blue key on the remote control. The skipped TV channel is displayed in blue.

Favourite programme



This function lets you select your favourite programmes directly. (8 channel)
Press the ▼ ▲ ◀ ▶ buttons to select a channel number.

* **Q.VIEW button(remote control)** :
Rotate Favourite channel.

Selecting and Adjusting the Screen



Adjusting Screen Colour

PSM

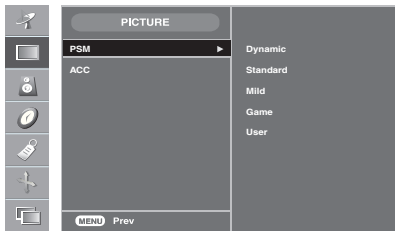

TV/AV1/AV2/S-Video input only

The **PSM** function automatically adjusts the screen image quality depending on the AV/TV usage environment.

- **Dynamic** : Select this option to display with a sharp image.
- **Standard** : The most general and natural screen display status.
- **Mild** : Select this option to display with a mild image.
- **Game** : Select this option to enjoy dynamic image when playing a game.
- **User** : Select this option to use the user-defined settings.

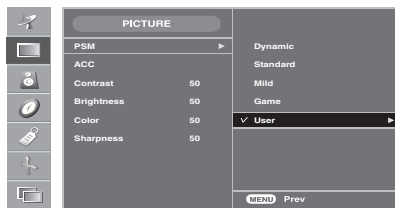

Contrast

To adjust the contrast of the screen.

Brightness

To adjust the brightness of the screen.

Color

To adjust the color to desired level.

Sharpness

To adjust the clearness of the screen.

Tint

To adjust the tint to desired level. (only 60Hz signal)

ACC

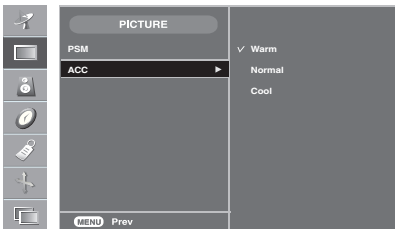

Selecting a factory setting colour set.

- **Warm** : Slightly reddish white.
- **Normal** : Slightly bluish white.
- **Cool** : Slightly purplish white.



Note

If the **PSM**' setting in the Picture menu is set to **Dynamic**, **Standard**, **Mild** or **Game** the subsequent menus will be automatically set.

Selecting and Adjusting the Screen



Adjusting Screen Colour

CSM



RGB / DVI input only

• 6500K/9300K

Selecting a factory setting colour set.

6500K: Slightly reddish white.

9300K: Slightly bluish white.

- **User** : Select this option to use the user-defined settings.

Contrast

To adjust the contrast of the screen.

Brightness

To adjust the brightness of the screen.

Red / Green / Blue

Set your own colour levels.

Selecting and Adjusting the Screen



Adjusting the audio function

SSM

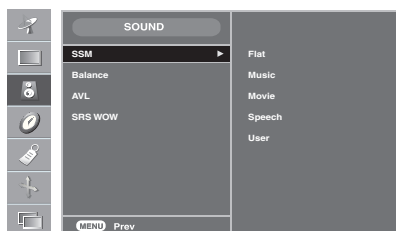

The best sound tone quality will be selected automatically depending on the video type that you're currently watching.

- **Flat**
The most commanding and natural audio.
- **Music**
Select this option to enjoy the original sound when listening to the music.
- **Movie**
Select this option to enjoy sublime sound.
- **Speech**
Select this option to watch sports broadcasting.
- **User**
Select this option to use the user-defined audio settings.
 - 1) Select a sound band by pressing the ◀ ▶ button.
 - 2) Make appropriate sound level with the ▼ ▲ button.
 - 3) Press the OK button to store it for sound User.

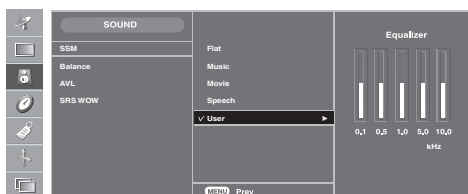

Balance Use this function to balance sound from the left and right speakers.

AVL To adjust uneven sound volumes across all channels or signals automatically to the most appropriate level. To use this feature, select **ON**. (It is adjustable to the TV input signal only.)

SRS WOW Set the **SRS WOW** menu on.
The **SRS WOW** function plays back the mono or stereo sound input with the dynamic surround effects. It will provide rich and profound sound tone. If you set the **SRS WOW** on, **SSM** setting can not be adjusted.



Note

When connected to your computer and the '**SSM**' setting in the audio menu is one of **Flat**, **Movie**, **Music** or **Speech**, the available menus are **Balance**, **SRS WOW**.



is a trademark of SRS Labs, Inc.
technology is incorporated under license from SRS Labs, Inc.

Selecting and Adjusting the Screen



Adjusting the timer function

Clock

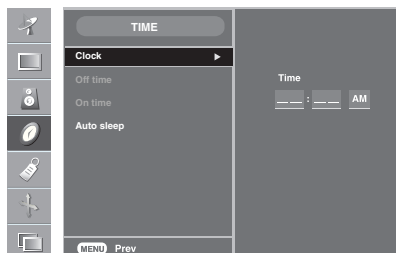

This function is used to set up of current time.

You must set the time correctly before using on/off timer function.

- 1) Press the **MENU** button and then use **▼▲** button to select the **TIME** menu.
- 2) Press the **▶** button and then use **▼▲** button to select the **Clock** menu.
- 3) Press **▶** button and then use **▼▲** button to set the hour(01~12).
- 4) Press **▶** button and then use **▼▲** button to set the minutes(00~59).
- 5) Press **▶** button and then use **▼▲** button to set the morning(AM) or afternoon(PM).
The default value is __:__.

Off / On time (Setting is available, however, operation is only allowed upon **TV/AV1/AV2/S-Video** input)
The off timer automatically switches the set to standby at the pre-set time.

- 1) Press the **MENU** button and then use **▼▲** button to select the **TIME** menu.
- 2) Press the **▶** button and then use **▼▲** button to select **Off time** or **On time**.
- 3) Press the **▶** button and then use **▼▲** button to set the hour(01~12).
- 4) Press the **▶** button and then use **▼▲** button to set the minutes(00~59).
- 5) Press the **▶** button and then use **▼▲** button to set the morning(AM) or afternoon(PM).
- 6) Press the **▶** button and then use **▼▲** button to select **On** or **Off**.
- 7) Only **On time** function; Press the **▶** button and then **▼▲** button to adjust volume level and program number.
- 8) Press the **OK/MENU** button to save.

Auto sleep (Setting is available, however, operation is only allowed upon **TV/AV1/AV2/S-Video** input)
If **Auto sleep** is active and there is no input signal, Make sure there is no remote control input. the TV switches to Standby mode automatically after 10 minutes.

- 1) Press the **MENU** button and then use **▼▲** button to select the **TIME** menu.
- 2) Press the **▶** button and then use **▼▲** button to select the **Auto sleep** menu.
- 3) Press the **▶** button and then use **▼▲** button to select **On** or **Off**.
- 4) Press the **OK/MENU** button to save.



Note

- In the event of power interruption (disconnection or power failure), the **Clock** must be reset.
- Once the **On** or **Off time** is set, these functions operate daily at the preset time.
- The set must be in off mode for the **On time** to work.

Selecting and Adjusting the Screen



Selecting the options

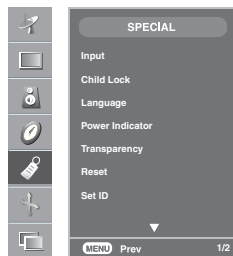

Input

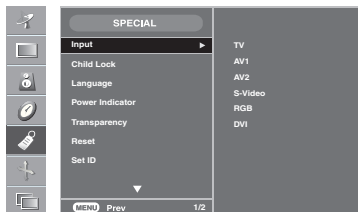

If you press the button once, the following Input Signal Window will appear. Select the signal type you want using the ▼▲ button.

Child lock

Use the ▼▲ buttons to select **ON** or **OFF**. The TV can be set up so that it can only be used with the remote control. This feature can prevent unauthorized viewing.

In order to lock the OSD screen adjustment, set the **Child lock** tab to the **'On'** position.

In order to unlock it, do the following :

* Push the **MENU** button on the remote control and set **Child lock** to the **'Off'** position.

Language

To choose the language in which the control names are displayed.

Power Indicator

Use this function to set the power indicator on the front side of the product to **On** or **Off**.

Transparency

To adjust the transparency of the OSD menu screen.

Reset

Use this function to reset the product to the factory default. However, language selection will not be initialized. (**PICTURE, SOUND, SPECIAL** menu)

Set ID

You can assign a unique **Set ID NO (name assignment)** to each product when several products are connected for display. Specify the number(1-99) using the ▼▲ button and exit. Use the assigned Set ID to individually control each product using the Product control Program.

Teletext

Please select your local teletext language.

If you don't, the teletext may not appear correctly on the screen.

This feature is not available in all countries.

Selecting and Adjusting the Screen



Screen Adjustment

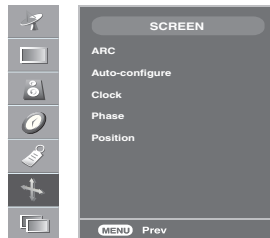

ARC To select the image size of the screen.

<TV/AV1/AV2/S-Video input only>

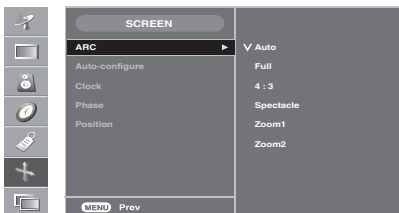

<RGB/DVI input only>

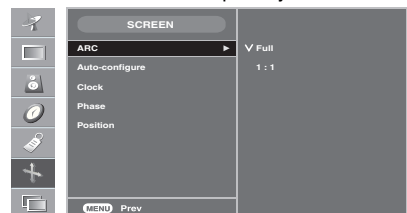

The screen aspect ratio is changed according to broadcasting system signal.

Auto

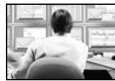

Full



4:3



Spectacle



Zoom1

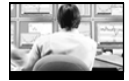

Zoom2

Auto-Configure

This function is suitable for analogue signal input only. This button is for the automatic adjustment of the screen **Position**, **Clock** and **Phase**.

Clock

This function is suitable for analogue signal input only. To minimize any vertical bars or stripes visible on the screen background. The horizontal screen size will also change.

Phase

This function is suitable for analogue signal input only. To adjust the focus of the display. This item allows you to remove any horizontal noise and clear or sharpen the image of characters.

Position

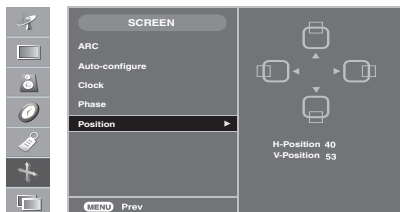

This function is suitable for analogue signal input only. To adjust position of the screen. Press the ► button to display the sub-menu for position.

- ◀ Left
 - ▶ Right
 - ▲ Up
 - ▼ Down
- Moving the screen position horizontally.
- Moving the screen position vertically.



Note

When the Interlace Signal is inputted at the RGB source input level, the **Auto-Configure**, **Clock**, **Phase** and **Position** menu can't be used.

Selecting and Adjusting the Screen



Adjusting PIP/POP/PBP Mode (Multiple Screen) Functions

(To adjust the sub screen)

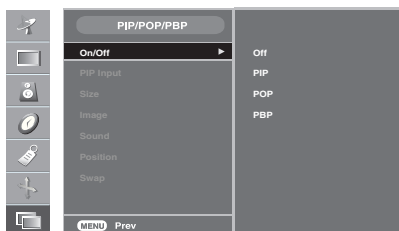

On/Off

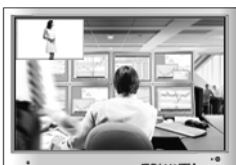

PIP

After selecting **PIP** in the **PIP/POP/PBP On/Off** menu, the following menu items can be adjusted.

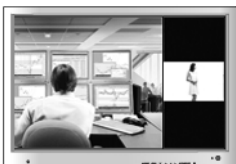

POP

After selecting **POP** in the **PIP/POP/PBP On/Off** menu, the following menu items can be adjusted.



PBP

After selecting **PBP** in the **PIP/POP/PBP On/Off** menu, the following menu items can be adjusted.

PIP Input To select an input signal for PIP/POP/PBP.

Size To adjust the size of the PIP/PBP screen. (PIP : Small, Medium, Large / PBP : Full, 4:3)

Image To adjust the image of the PIP/POP/PBP screen; Press the ► button to display the sub-menu for PIP/POP/PBP image. Use the ◀ buttons to adjust the item to the desired level. The items of the sub-menu may vary depending on the type of the source.

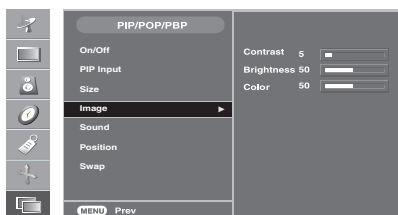

■ **Contrast**

Adjust PIP/POP/PBP screen contrast.

■ **Brightness**

Adjust PIP/POP/PBP screen brightness.

■ **Color**

Adjust the PIP/POP/PBP screen colour.
(PIP mode : TV/AV1/AV2/S-Video input only)

* The sub-menu can differ according to the type of the input signal.

Sound To turn the PIP/POP/PBP sound on/off.

Selecting and Adjusting the Screen



Adjusting PIP/POP/PBP Mode (Multiple Screen) Functions

Position

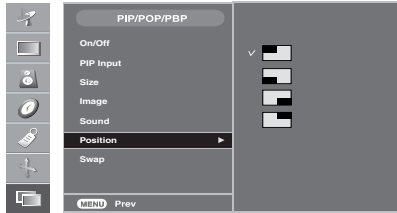

To adjust the position of PIP screen.

Swap

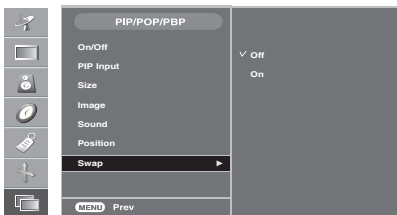

To switch the main-screen and sub-screen in PIP/POP/PBP mode.

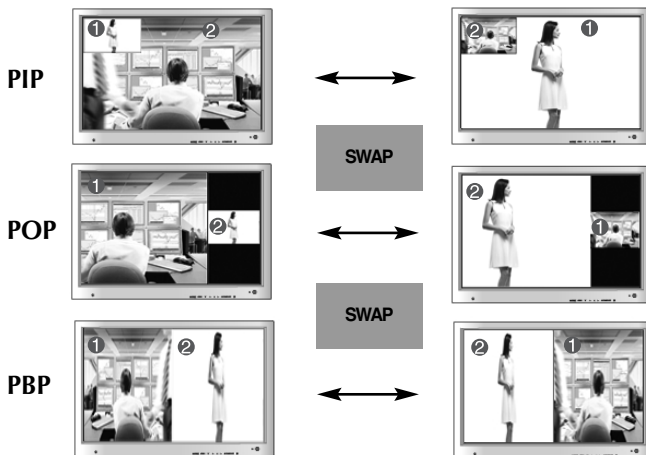

Note

When the Interlace signal, such as the Set-top Box, is inputted at the RGB and DVI source input level, the following will be shown.

- (1) If Interlace Signal is inputted in RGB, PIP/POP/PBP cannot be used.
- (2) If Interlace Signal is inputted in DVI, PIP/POP/PBP cannot be used.
- (3) When TV, AV1, AV2, and S-Video is selected as the main screen for PIP/POP/PBP
If the sub-screen is an Interlace Signal inputted RGB or DVI, the screen will be displayed but the contents will not be displayed.

Troubleshooting

No image is displayed

- **Is the product power cord connected?**
 - See if the power cord is properly connected to the outlet.
- **Does the power indicator is turned on?**
 - See if the power switch is turned on.
- **Power is on, power indicator is blue but the screen appears extremely dark.**
 - Adjust brightness and contrast again.
- **Does the power indicator look yellow?**
 - If the product is in power saving mode, move the mouse or press any key.
- **Does the 'Out of range' message appear?**
 - The signal from the PC (video card) is out of the vertical or horizontal frequency range of the product. Adjust the frequency range by referring to the Specifications in this user's guide.
 - * **Maximum resolution**
 - D-Sub : 1600 x 1200 @60Hz
 - DVI : 1360 x 768 @60Hz
- **Does the 'Check signal cable' message appear?**
 - The signal cable between PC and product is not connected. Check the signal cable.
 - Press the '**SOURCE**' menu in the remote control to check the input signal.

'Unknown Product' message appears when the product is connected.

- **Did you install the driver?**
 - Install the product driver, which is provided with the product, or download it from the web site. (<http://www.lge.com>)
 - See if the plug&play function is supported by referring to the video card user's guide.

'Controls locked' message appears.

- **The 'Controls locked' message appears when pressing the Menu button.**
 - The control locking function prevents unintentional OSD setting change due to careless usage. To unlock the controls, simultaneously press the MENU button and ► button for several seconds. (You cannot set this function using the remote control buttons. You can set this function in the product only.)



Note

* **Vertical frequency:** To enable the user to watch the product display, screen image should be changed tens of times every second like a fluorescent lamp. The vertical frequency or refresh rate is the times of image display per second. The unit is Hz.

* **Horizontal frequency:** The horizontal interval is the time to display one vertical line. When 1 is divided by the horizontal interval, the number of horizontal lines displayed every second can be tabulated as the horizontal frequency. The unit is kHz.

Troubleshooting

The screen image looks abnormal.

■ **Is the screen position wrong?**

- D-Sub analogue signal – press the SET/AUTO button at the front side of the product to automatically select the optimal screen status that fits into the current mode. If adjustment is not satisfactory, use the Position OSD menu.

■ **Do thin lines appear on the background screen?**

- See if the video card resolution and frequency are supported by the product. If the frequency is out of range, set to the recommended resolution in the Control Panel – Display – Setting menu.

■ **Horizontal noise appears or the characters look blurred.**

- D-Sub analogue signal – press the SET/AUTO button at the front side of the product to automatically select an optimal screen status that fits into the current mode. If adjustment is not satisfactory, use the Clock OSD menu.

■ **Screen size is automatically adjusted when connected to the PC.**

- D-Sub analogue signal – press the SET/AUTO button at the front side of the product to automatically select an optimal screen status that fits into the current mode. If adjustment is not satisfactory, use the Phase OSD menu.

■ **Brightness differs in the main and sub screen when connected to the PC.**

- If the screen size is not full when connected to the PC, execute the PIP/POP/PBP to change to full screen mode.

■ **The screen is displayed abnormally.**

- You cannot adjust brightness and tint in the PIP/POP/PBP Screen menu for the sub-screen among PIP/POP/PBP menus. Therefore, brightness can be different for the sub-screen.

■ **No sound appears in the TV channel display window.**

- The proper input signal is not connected to the signal port. Connect the signal cable that matches with the source input signal.

- See if the TV sound is set to mono. If it is, the sound will not be displayed.

After-image appears on the product.

■ **After-image appears when the product is turned off.**

- If you use a fixed image for a long time, the pixels may be damaged quickly. Use the screensaver function.

Troubleshooting

The audio function does not work.

- **No sound?**
 - See if the audio cable is connected properly.
 - Adjust the volume.
 - See if the sound is set properly.
- **No sound is available when the PIP/POP/PBP mode is engaged.**
 - See if the Sound is set to On in the PIP/POP/PBP menu.
- **Sound is too dull.**
 - Select the appropriate equalize sound.
- **Sound is too low.**
 - Adjust the volume.

The TV function does not work.

- **The TV signal is not being received.**
 - See if you have selected the proper channel mode.
 - Use the automatic channel setup function.
 - See if the TV antenna is properly connected.

The screen size function in the OSD menu does not work.

- **The screen size function in the OSD menu does not work.**
 - See if the PIP/POP/PBP function is in use. If the PIP/POP/PBP function is in use, the screen size function may not work.

Screen colour is abnormal.

- **Screen has poor colour resolution (16 colours).**
 - Set the number of colours to more than 24 bits (true colour)
Select Control Panel – Display – Settings – Colour Table menu in Windows.
- **Screen colour is unstable or mono-coloured.**
 - Check the connection status of the signal cable.
Or, re-insert the PC video card.
- **Do black spots appear on the screen?**
 - Several pixels (red, green, white or black colour) may appear on the screen, which can be attributable to the unique characteristics of the LCD panel. It is not a malfunction of the LCD.

Specifications

The product specifications can change without prior notice for product improvement.

LCD Panel	Screen Type	22.95 inch (582.96 mm) TFT (Thin Film Transistor) LCD (Liquid Crystal Display) Panel Visible diagonal size: 582.96 mm
	Pixel Pitch	0.372 mm
Video Signal	Max. Resolution	D-Sub : 1600 X 1200 @60Hz DVI-D : 1360 X 768 @60Hz
	Recommended Resolution	D-Sub : WXGA 1360 X 768 @60Hz DVI-D : WXGA 1360 X 768 @60Hz
	Horizontal Frequency	D-Sub : SXGA : 30 - 92 kHz, UXGA : 30 - 76 kHz DVI-D : SXGA : 30 - 92 kHz
	Vertical Frequency	SXGA : 56 - 85 Hz, UXGA : 56 - 60 Hz
	Synchronization Type	Separate/Composite/SOG (Sync On Green)/Digital
Input Connector	15-pin D-Sub type, DVI-D (digital), S-Video, Composite video, SCART, TV	
Power (Adapter)	Rated Voltage	24 V  3.5 A
	Power Consumption	On Mode : 110 W Sleep Mode : ≤ 5 W Off Mode : ≤ 3 W
AC/DC Adapter	Delta ADP-120TB B	
Tilt	Tilt Range	-5° ~20°
Dimension/Weight	Size (WxDxH)	588 mm x 260 mm x 447 mm
	Weight (excl. package)	10.9 kg (24 lbs)
Environmental Conditions	Operational Condition	Temperature: 10°C ~ 35°C , Humidity: 10% ~ 80%
	Storage Condition	Temperature: -20°C ~ 60°C , Humidity: 5% ~ 90%

Specifications

● PC Mode – Preset Mode

Preset mode		Horizontal Frequency (kHz)	Vertical Frequency (Hz)	Preset mode		Horizontal Frequency (kHz)	Vertical Frequency (Hz)
1	VGA 640 x 350	31.469	70	11	VESA 1024 x 768	60.123	75
2	VGA 720 x 400	31.468	70	12	VESA 1024 x 768	68.68	85
3	VGA 640 x 480	31.469	60	13	VESA 1280 x 720	44.772	60
4	VESA 640 x 480	37.500	75	14	VESA 1360 x 768	47.72	60
5	VESA 640 x 480	43.269	85	15	VESA 1280 x 1024	63.981	60
6	VESA 800 x 600	37.879	60	16	VESA 1280 x 1024	79.98	75
7	VESA 800 x 600	46.875	75	17	VESA 1600 x 1200	75.00	60
8	VESA 800 x 600	53.674	85	RGB : Mode 1 ~ Mode 17 DVI : Mode 1 ~ Mode 14			
9	MAC 832 x 624	49.725	75				
10	VESA 1024 x 768	48.363	60				

● Power Indicator

Mode	Product
On Mode	Blue
Sleep Mode	Amber
Off Mode	-

VESA wall mounting

Connected to another object. (stand type and wall-mounted type.)

This product accepts a VESA-compliant mounting interfacepad.(This has to be purchased separately if required.)

For further information, refer to the VESA Wall Mounting Instruction Guide.

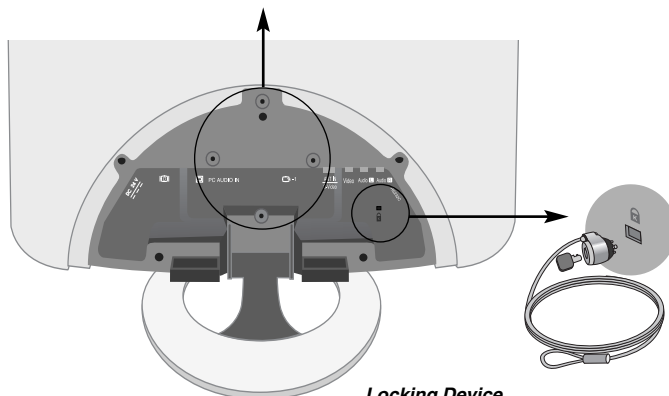

Locking Device

Use this locking cable (This has to be purchased separately if required.) to prevent theft.

Specifications

DVI-D

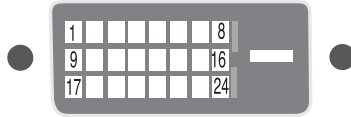

No.	Signal
1	T. M. D. S. Data 2-
2	T. M. D. S. Data 2+
3	T. M. D. S. Data 2/4 Shield
4	T. M. D. S. Data 4-
5	T. M. D. S. Data 4+
6	DDC Clock
7	DDC Data
8	Analogue Vertical Synchronization
9	T. M. D. S. Data 1-
10	T. M. D. S. Data 1+
11	T. M. D. S. Data 1/3 Shield
12	T. M. D. S. Data 3-
13	T. M. D. S. Data 3+
14	+5V Power
15	Grounding (return for +5V, horizontal sync and vertical sync)
16	Hot Plug Detect
17	T. M. D. S. Data 0-
18	T. M. D. S. Data 0+
19	T. M. D. S. Data 0/5 Shield
20	T. M. D. S. Data 5-
21	T. M. D. S. Data 5+
22	T. M. D. S. Clock Shield
23	T. M. D. S. Clock+
24	T. M. D. S. Clock

T.M.D.S. (Transition Minimized Differential Signaling)