



LG

Cassette-Type Air Conditioner

OWNER'S MANUAL

LG

ENGLISH

ITALIANO

ESPAÑOL

FRANÇAIS

DEUTSCH

IMPORTANT

Please read through this manual. It contains valuable information about your air conditioner. This manual may help save time and money by explaining proper product maintenance and preventing improper use.

PRECAUTIONS

Pay close attention to precautions in order to prevent potential hazards and damage from misuse or improper installation. LG is not responsible for any damages caused by misuse of the product.

Prior to installation, this air-conditioning unit must be submitted for approval by the utility service which provides electricity (EN 61000-3 Norm.)

TABLE OF CONTENTS

1. Safety Precautions

2. Operating Instructions

3. Care and Maintenance

4. Before you call for service

For Your Records

Write the model and serial numbers here:

Model # _____

Serial # _____

You can find them on a label on the side of each unit.

Dealer's Name _____

Date Purchased _____

Read This Manual

Inside you will find many helpful hints on how to use and maintain your air conditioner properly. Just a little preventive care on your part can save you a great deal of time and money over the life of your air conditioner.

You'll find many answers to common problems in the chart of troubleshooting tips. If you review our chart of **Troubleshooting Tips** first, you may not need to call for service at all.





CAUTION

- Contact the authorized service technician for repair or maintenance of this unit.
- Contact the installer for installation of this unit.
- The air conditioner is not intended for use by young children or invalids without supervision.
- Young children should be supervised to ensure that they do not play with the air conditioner.
- When the power cord is to be replaced, replacement work shall be performed by authorized personnel only.
- Installation work must be performed in accordance with the national wiring standards by authorized personnel only.



To prevent injury and property damage, follow these instructions.

⚠ Incorrect operation due to ignoring instructions will cause harm or damage, the seriousness of which is indicated by the following symbols.

	WARNING This symbol shows the possibility of death or serious injury.
	CAUTION This symbol indicates the possibility of injury or damage to property.



	Never Do This
	Always Do This







Installation precautions

 **WARNING** 

■ **Do not install, remove and reinstall the unit by yourself.**

- Improper installation will cause water leakage, electrical shock, or fire. Please consult authorized dealer or specialist for the installation work. Please note fault caused by improper installation is not covered by warranty.
- Unit must be installed in an easily accessible area. Any additional cost required to hire a special equipment to service the unit will be the responsibility of the customer.

 **WARNING** 

<p> Do not damage or use an unspecified power cable.</p> <ul style="list-style-type: none"> • It will cause electrical shock or fire. • If the supply cord is damaged, it must be replaced by a service agent or a similarly qualified person in order to avoid a hazard. 	<p> Do not operate switches with wet hands.</p> <ul style="list-style-type: none"> • It may cause electrical shock. 	<p> Plug in the power plug properly.</p> <ul style="list-style-type: none"> • It will cause electrical shock or fire due to heat generation.
<p> Do not operate or stop the unit by inserting or pulling out the power plug.</p> <ul style="list-style-type: none"> • It will cause electrical shock or fire due to heat generation. 	<p> Do not expose the skin to cool air directly for a long time.</p> <ul style="list-style-type: none"> • This could damage your health. 	<p> Repair or relocation should not be done by the customer.</p> <ul style="list-style-type: none"> • If this is done incorrectly, it may cause a fire, electric shock, injury by dropping of the unit, water leakage, etc. Consult your dealer.
<p> If an abnormality (smell of burning, etc) occurs, stop the air conditioner, and turn off the breaker.</p> <ul style="list-style-type: none"> • If the unit continues to be operated in an abnormal condition, it may cause a fire, trouble, etc. In this case, consult your dealer. 		

⚠ CAUTION

- Contact the authorized Service technician for repair or maintenance of this unit.
- Contact the installer for installation of this unit.
- The air conditioner is not intended for use by young children or infirm persons without supervision.
- Young children should be supervised to ensure that they do not play with the air conditioner.

⚠ CAUTION

⊘ Do not clean the air conditioner with water.

- Water may enter the unit and degrade the insulation. It may cause an electric shock.

ⓘ Ventilate well when used together with a stove, etc.

- An oxygen shortage may occur.

ⓘ When the unit is to be cleaned, switch off, and turn off the breaker.

- Since the fan rotates at high speed during operation, it may cause an injury.

⊘ Do not put a pet or house plant where will be exposed to direct air flow.

- This could injure the pet or plant.

⊘ Do not apply an insecticide or flammable spray.

- It may cause a fire or deformation of the cabinet.

⊘ Do not leave on installation stand which is damaged.

- The unit may drop or fall down and cause an injury.

⊘ Do not put a stove, etc. where is exposed to direct air flow.

- It may cause imperfect combustion.

ⓘ When the unit is not going to be used for a long time, turn off the breaker.

- It may cause an injury.

⊘ Do not step on the outdoor unit and do not put anything on it.

- It may cause an injury through dropping or falling down.

⊘ Do not operate for a long time in high humidity, e.g. leaving a door or window open.

- In the cooling mode, if it is operated in a room with high humidity (80%r.h. or more) for a long time, water condensed in the air conditioner may drop and may wet and spoil furniture, etc.

⊘ Do not step onto an unstable bench when attaching/detaching the panel.

- It may cause an injury, etc. by falling down.

⊘ Do not use for special purposes.

- Do not use this air conditioner to preserve precision devices, food, animal, plants and art objects. It may cause deterioration of quality, etc.

ⓘ If the supply cord is damaged, it must be replaced by a special cord or assembly available from the manufacturer of its service agent.

- If will cause electrical shock or fire.

ⓘ When the air filter is to be removed, do not touch the metal parts of the indoor unit.

- It may cause an injury.

⊘ Do not insert hands through vanes when the air conditioner is operating.

- It will cause an injury by the rotating blower.

Indoor Unit, Outdoor Unit

Indoor Unit

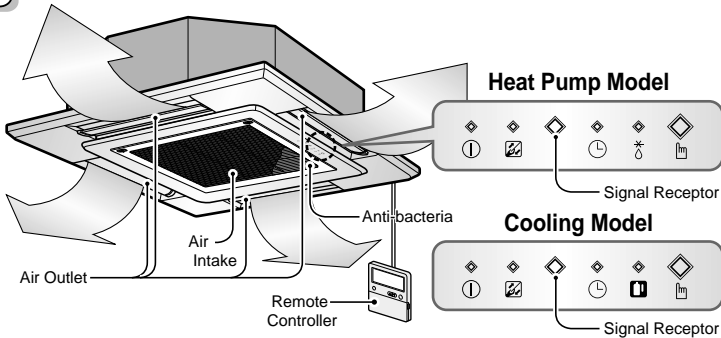

Signal Receptor

Receives the signals from the remote control.
(Signal receiving sound: two short beeps or one long beep.)

Operation Indication Lamps

⓪	On/Off	: Lights up during the system operation.
ⓧ	Filter Sign	: Lights up after 2400 hours from the time of first operating unit. (Refer to page 19.)
⌚	Timer	: Lights up during Timer operation.
❄️	Defrost Mode	: Lights up during Defrost Mode or Hot Start operation. (Heat pump model only)
🏠	Outdoor Unit Operation	: Lights up during outdoor unit operation. (Cooling model only)
👉	Forced Operation	: Operation procedures when the remote control can't be used.

Outdoor Unit

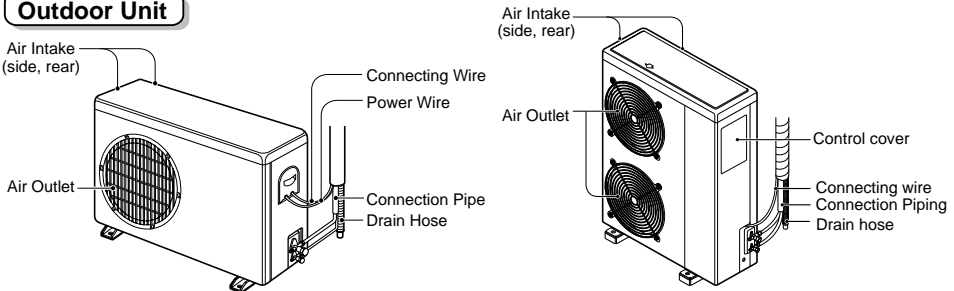

Heat pump model: Cassette Type Air Conditioner for cooling and heating
Cooling model: Cassette Type Air Conditioner for cooling

Name and Function of Remote Controller

Remote Controller

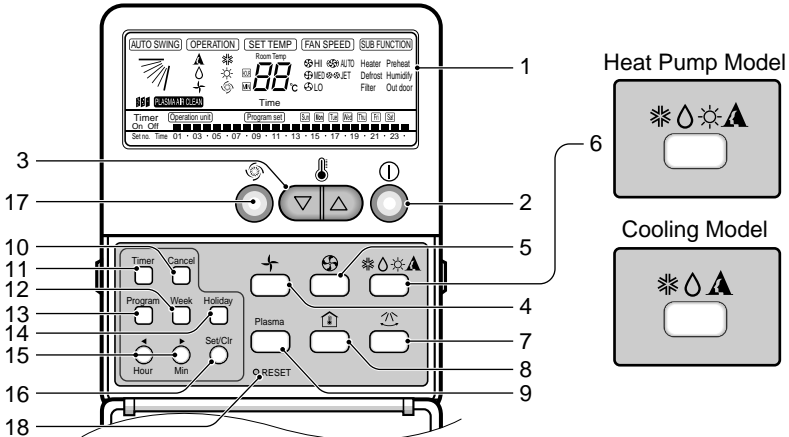

- 1 Operation display**
Displays the operation conditions.
- 2 On/Off Button**
Operation starts when this button is pressed, and stops when the button is pressed again.
- 3 Set Temperature Button**
Used to set the temperature when the desired temperature is obtained.
- 4 FAN Operation Button**
Used to circulate room air without cooling or heating.
- 5 Fan Speed Button**
Used to set the desired fan speed.
- 6 Operation Mode Selection Button**
Used to select the operation mode.
 - Auto Operation Mode
 - Cooling Operation Mode
 - Soft Dry Operation Mode
 - Heating Operation Mode(except cooling model)
- 7 Auto Swing Button**
Used to swing up and down.
- 8 Room Temperature Checking Button**
Used to check the room temperature.
- 9 Plasma Air Clean Button (optional)**
- 10 Timer Cancel Button**
Used to cancel the timer.
- 11 Timer Set Button**
Used to set the timer when the desired time is obtained.
- 12 Week Button**
Used to set a day of the week.
- 13 Program Button**
Used to set the weekly timer.
- 14 Holiday Button**
Used to set a holiday of the week.
- 15 Time Set Button**
Used to set the time of the day and change the time in the weekly timer Function.
- 16 Set and Clear Button**
Used to set and clear the weekly timer.
- 17 Jet Cool Button**
Used to select jet cool mode.
- 18 Reset Button**
Used to set the current time and clear the setting time.

※ Display temperature can be different from actual room temperature if the remote controller is installed at the place where sun-rays are falling directly or the place nearby heat source.

Wireless Remote Controller (optional)

This air-conditioner is equipped with wired remote controller basically. But if you want to be available with wireless remote controller, you pay for it.

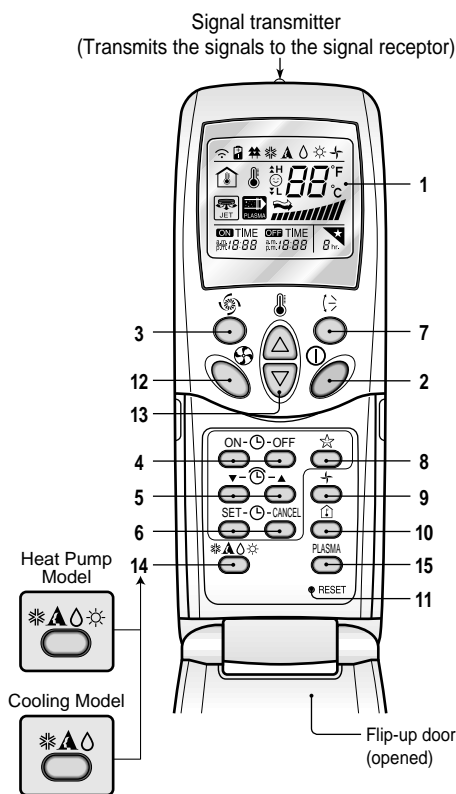

- 1 OPERATION DISPLAY**
Displays the operation conditions.
- 2 ON/OFF BUTTON**
Operation starts when this button is pressed and stops when the button is pressed again.
- 3 JET COOL BUTTON**
Used to select jet cool mode.
- 4 ON/OFF TIMER BUTTONS**
Used to set the time of starting and stopping operation.
- 5 TIME SETTING BUTTONS**
Used to adjust the time.
- 6 TIMER SET/CANCEL BUTTONS**
Used to set the timer when the desired time is obtained and to cancel the Timer operation.
- 7 AIR SWING BUTTON**
Used to swing up and down.
- 8 SLEEP MODE BUTTON**
Used to set Sleep Mode Auto operation.
- 9 AIR CIRCULATION BUTTON**
Used to circulate the room air without cooling or heating (turns indoor fan on/off).
- 10 ROOM TEMPERATURE CHECKING BUTTON**
Used to check the room temperature.
- 11 RESET BUTTON**
Used prior to resetting time or after replacing batteries.
- 12 INDOOR FAN SPEED SELECTOR**
Used to select fan speed in four steps-low, medium, high, or CHAOS.
- 13 ROOM TEMPERATURE SETTING BUTTONS**
Used to select the room temperature.
- 14 OPERATION MODE SELECTION BUTTON**
Used to select the operation mode.
- 15 PLASMA AIR CLEAN BUTTON(OPTIONAL)**

CAUTION

of handling the Remote Controller

- Aim at the signal receptor on the wired remote controller so as to operate.
- The remote control signal can be received at a distance of up to about 7m.
- Be sure that there are no obstructions between the remote controller and the signal receptor.
- Do not drop or throw the remote controller.
- Do not place the remote controller in a location exposed to direct sunlight, or near the heating unit, or any other heat source.
- Block a strong light over the signal receptor with a curtain or etc. so as to prevent the abnormal operation. (ex:electronic quick start, ELBA, inverter type fluorescent lamp)

Set the Current Time and day of the Week

Unless you press any button about 5 (sometimes 10) seconds while setting function, the setting mode returns to initial mode.

1 Press the '  ' button.

Each time the button is pressed, the number is changed from 0 0 to 2 3.
This number indicates current hour.

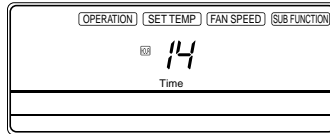
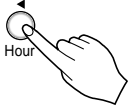

For example, if it is 14:25, press  button 14 times.

2 Press the '  ' button.

Each time the button is pressed, the number increases from 0 0 to 5 9.
This number indicates current minute.

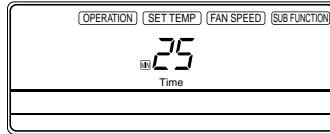
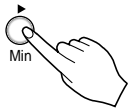



For example, if it is 14:25, press  button 25 times.

3 Press '  ' button.

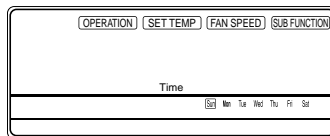
Each time the button is pressed, a day of the week is shifted from Sunday to Saturday.



For example, if today is Wed, press  button 3 times.

4 Press the '  ' button.

If you want to confirm the current time and a day of the week, click the Reset button.

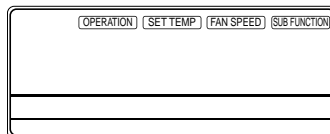

Weekly Programming

1 Press the Program button.

The remote controller is displayed like a picture. Then ' ', ' ' and '01' is blinked.

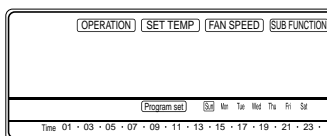

2 Press the ' ' button.

Press button repeatedly until desired mode appears.



For example, if you want Thu, press button 4 times.

3 Select the time you want.

Press or button, then blinking letter is shown.

If you press button, then ' ' shape appears.

' ' shape means that five o'clock is reserved.

Using below buttons, you can reserve time.

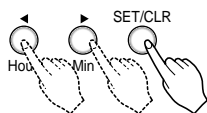

* For example, the air-conditioner is on 6,7,8 and 13~22 o'clock.

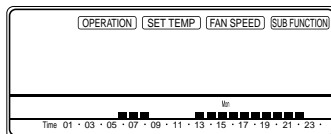

Holiday Setting

If Tuesday is a holiday in this week, you may set a holiday.

- 1 Press the Program button.

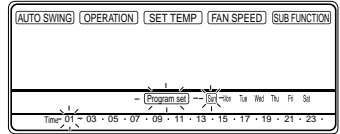

- 2 Press the Week button.
Select the Tuesday.

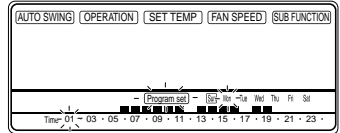

- 3 Press the Holiday button.



Then the remote controller will be displayed 'Tue'.
The outside rectangular means holiday.

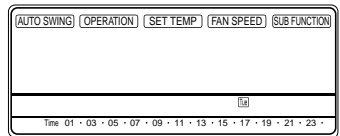



Timer Setting

If you want to turn it 'ON' during 'OFF' mode or turn it 'OFF' during 'ON' mode, you can use timer setting function.

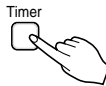
- 1 Press the Timer button.



- 2 Press  or  button, then you can control the desired time.

If you press  button, the display panel shows (ex : ).

It means 3 hours later, it will stop while 'ON' mode, it will operate while 'OFF' mode.

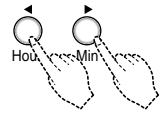

- 3 If you want to cancel the timer setting function, press the Cancel button.

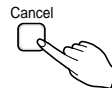

Self-diagnosis Function

'CH' will flash in the remote controller display when a problem occurs.
Then please contact your dealer.

Operation Mode

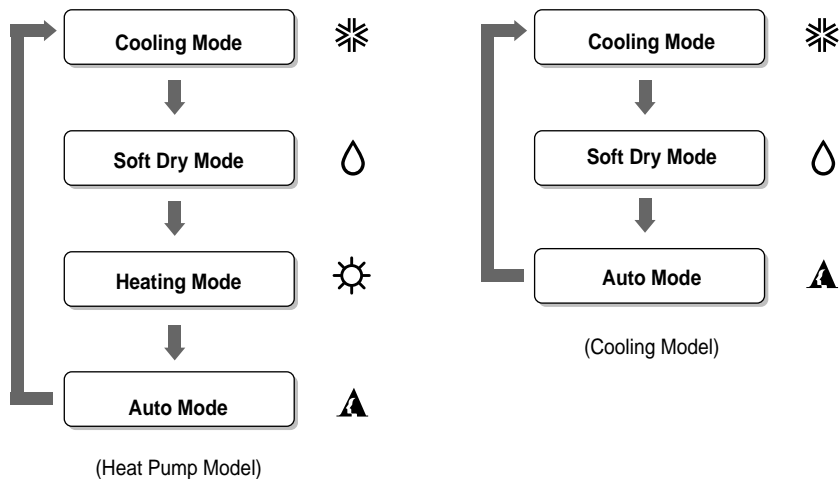

Operation Procedure

1st On/Off Button

2nd Operation Mode Selection Button

3rd Room Temperature Setting Button

4th Indoor Fan Speed Selection Button

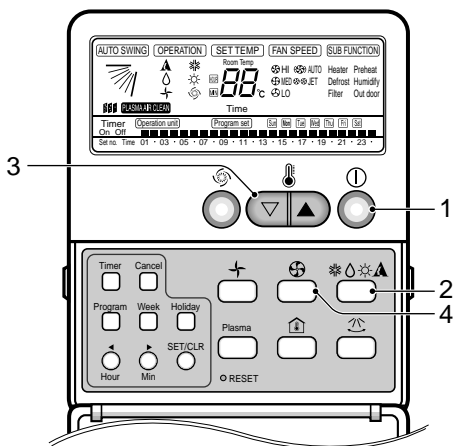

Cooling Operation Mode

1 Press the On/Off Button.

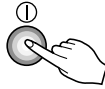

2 Select Cooling Operation.
Press the Operation Mode Selection Button.

Each time the button is pressed, the operation mode is shifted in the arrow direction.

HEAT PUMP MODEL

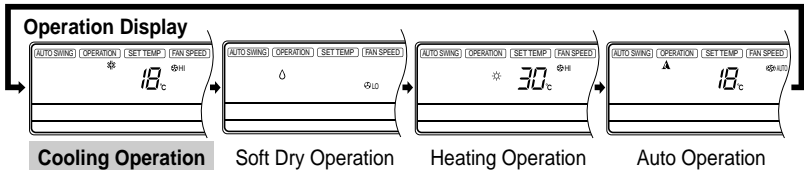

COOLING MODEL

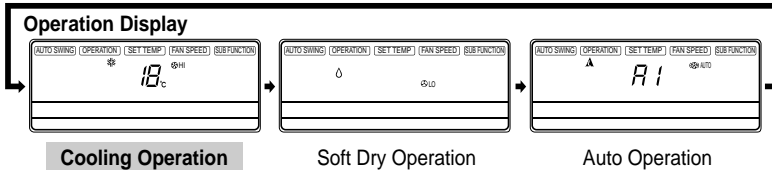

3 Set the temperature lower than the room temperature.

• The temperature can be set within a range of 18°C ~ 30°C by 1°C .

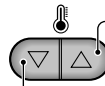
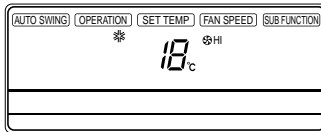

To raise the Temperature.

To lower the Temperature.

4 Set the fan speed.

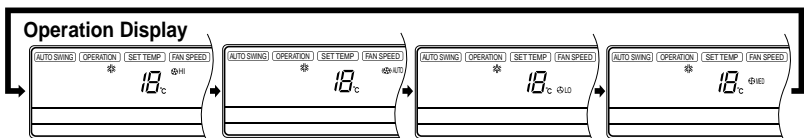

- Select the fan speed in four steps-high, Auto, low, medium.
- The display shows high fan speed.
- Each time the button is pressed, the fan speed mode is shifted.

Soft Dry Operation Mode

This mode dehumidifies without overcooling.

1 Press the On/Off Button.

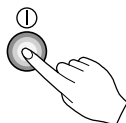

2 Select Soft Dry Operation.

Press the operation Mode Selection Button.

Each time the button is pressed, the operation mode is shifted in the arrow direction.

HEAT PUMP MODEL

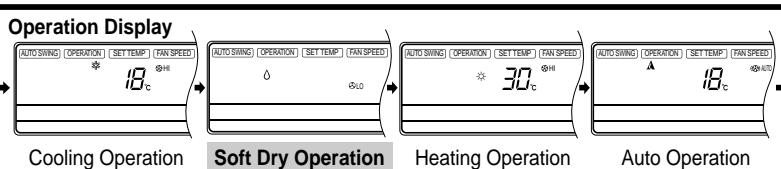

COOLING MODEL

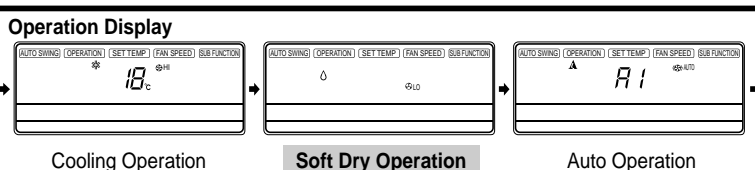

3 During Dry Operation.

- The indoor fan speed is automatically set to the low, so the shift of the indoor fan speed is impossible because of already being set to the best speed for Dry Operation by Micom Control.

Heating Operation Mode (Heat pump model only)

1 Press the On/Off Button.

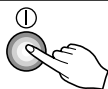

2 Select Heating Operation.

Press the Operation Mode Selection Button.
Each time the button is pressed, the operation mode is shifted in the arrow direction.

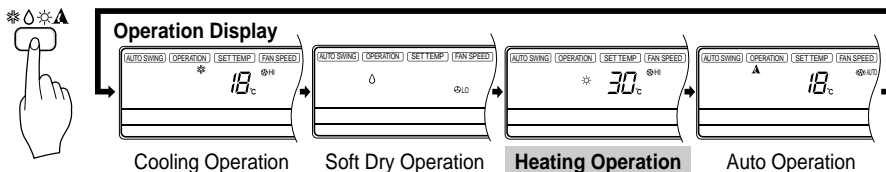

3 Set the temperature higher than the room temperature. • The temperature can be set within a range of 16°C~30°C by 1°C.

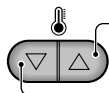
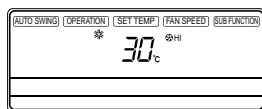

To raise the Temperature.

To lower the Temperature.

4 Set the fan speed.

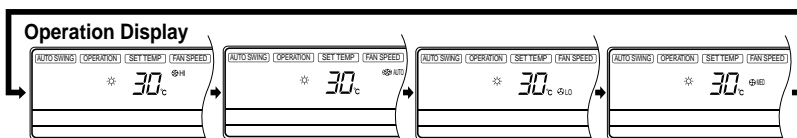

- Select the fan speed in four steps-high, Auto, low, medium.
- The display shows high fan speed
- Each time the button is pressed, the fan speed mode is shifted.

5 This air-conditioner is set to the hot start control in order not to discharge the cold air during the heating operation. This time, the remote controller indicates 'Preheat'.

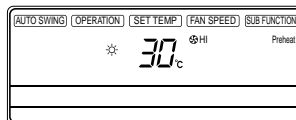

6 If the outdoor temperature is too low during the heating operation, this air-conditioner is set to the defrosting operation and the remote controller indicates 'Defrost'.

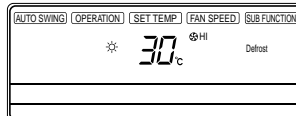

Auto Operation Mode (Cooling model)

1 Press the On/Off Button.



2 To select **Auto Operation**, press the Operation Mode Selection button. Each time the button is pressed, the operation mode is shifted in the direction of the arrow.

COOLING MODEL

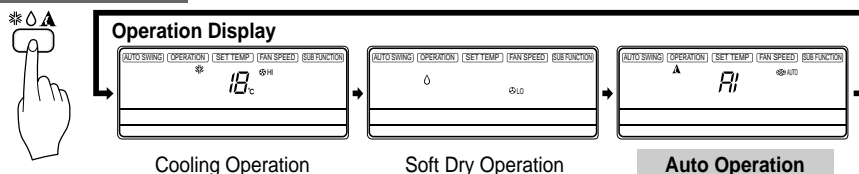

3 The temperature and fan speed are automatically set by the electronic controls based on the actual room temperature. If you want to change the set temperature, close the door on the remote control and press the Room Temperature Setting buttons. The cooler or warmer you feel, the more times (up to two times) you should press the button. The set temperature will then be changed. The temperature can be set within a range of -2~2 by 1 level.

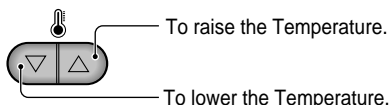
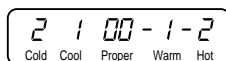
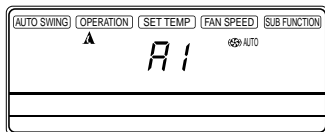

(This indication will be shifted to the initial Auto Mode Display state after 5 seconds.)

During Auto Operation:

- You cannot switch the indoor fan speed. It has already been set by the Fuzzy rule.
- If the system is not operating as desired, manually switch to another mode. The system will not automatically switch from the cooling mode to the heating mode, or from heating to cooling, it must be done by manually resetting.
- During Auto Operation, pressing the chaos swing button makes the horizontal louvers swing up and down automatically. If you want to stop auto-swing, press the chaos swing button again.

Auto Operation Mode (Heat pump model)

1 Press the On/Off Button.



2 To select **Auto Operation**, press the Operation Mode Selection button. Each time the button is pressed, the operation mode is shifted in the direction of the arrow.

HEAT PUMP MODEL

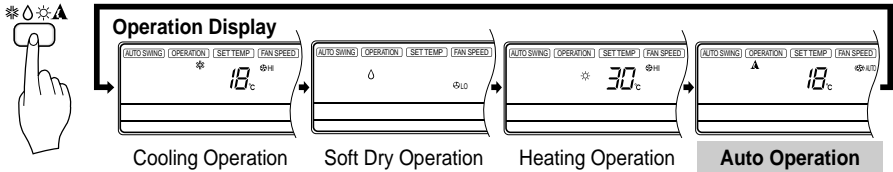

3 The setting temperature can be changed, when the set temperature button is pressed.

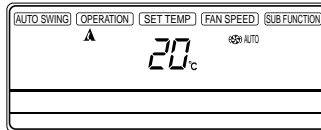

• The temperature can be set within a range of 18°C~30°C by 1°C.

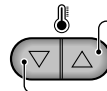

To raise the Temperature.

To lower the Temperature.

During Auto Operation:

- You can switch the indoor fan speed.
- The system will automatically switch from the cooling mode to the heating mode, or from heating to cooling, when you select Auto Operation mode.

FAN Operation Mode

1 Press the On/Off Button.



2 Press FAN Operation Button.

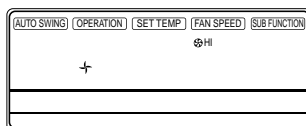

3 Each time Fan Speed button is pressed, the fan speed mode is shifted in the arrow direction.

• Fan speed is high.

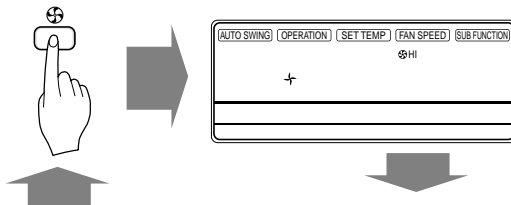

• Fan speed is medium.

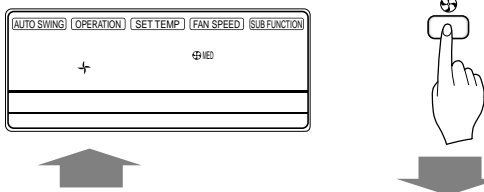

• Fan speed is low.

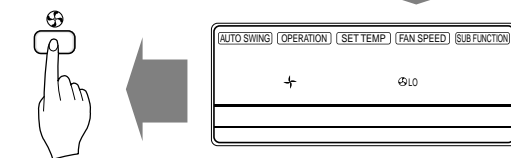

Jet Cool Operation Mode

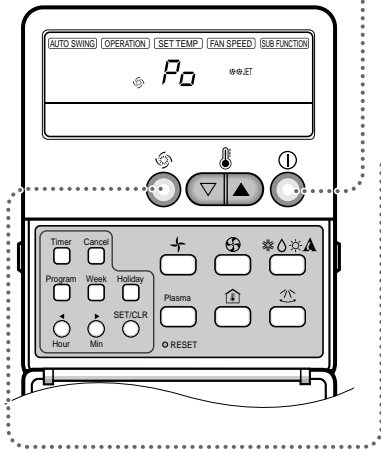

- 1** Press the On/Off button.
The unit will respond with a beep.



- 2** Press the **Jet Cool** button to operate the speed cooling mode and the unit will operate in super high fan speed on cooling mode.



- 3** To cancel the **Jet Cool** mode, press the **Jet Cool** button again or the **Fan Speed** button or the **room Set Temperature** button and the unit will operate in high fan speed on cooling mode.

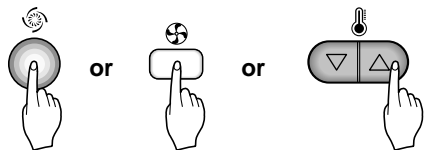

NOTE:

- ❑ During the Jet Cool function at any moment, the A/C starts to blow the cool air at extremely high speed setting the room temp. automatically to 18°C. It is especially used to cool the room temp. in the shortest time in a hot summer.
In heating mode however, the Jet Cool function is not available.
- ❑ In order to return to the normal cooling mode from the Jet Cool mode, you just press either the operation mode selection button, airflow volume selection or temp. setting button or the Jet Cool button again.

Auto Swing Mode

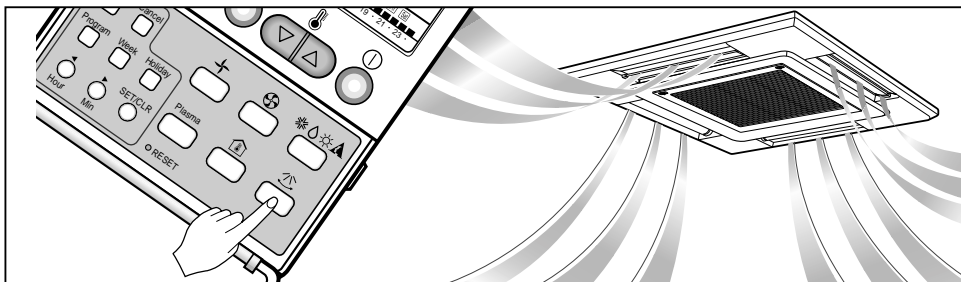

- 1** Press the On/Off button.
(Confirm the unit on operation.)



- 2** Press the Auto Swing button then the horizontal louvers swing up and down automatically.



- 3** Press again the Auto Swing button to cancel the Auto Swing mode.



Child Lock Function

This is the Function that any children cannot used to the air-conditioner.

Operation procedure

- 1 To set the Child-Lock Function**

Press the Timer button and Minute Set button for three seconds. Then the operation mode shift to child lock mode and it is displayed 'CL' in the operation display. When you press any button in this time, the remote controller is not converted to any selected mode and the 'CL' is displayed in the remote controller for about three seconds. But the Room Temperature function is operated in spite of child lock mode.

- 2 To cancel the Child-Lock Function**

Press the Timer button and Minute Set button for three seconds. Then the child-lock mode is cancelled and the preselected mode is displayed in the remote controller.

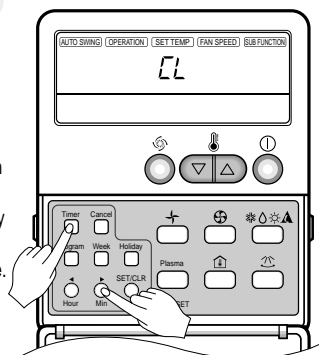

Helpful information

Fan speed and cooling capacity.

The cooling capacity indicated in the specification is the value when the fan speed is set to high, and the capacity will be lower at low or medium fan speed.

High fan speed is recommended when you wish to cool the room quickly.

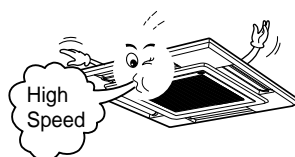

Forced Operation

Operation procedures when the remote control can't be used.
 Press the tact switch (Forced operation) for 2 seconds.
 If you want to stop operation, press again the tact switch.
 In case the power comes on again after power failure on the Forced Operation mode, the operating conditions are automatically set as follows:
 During Forced Operation, the initial mode continues.

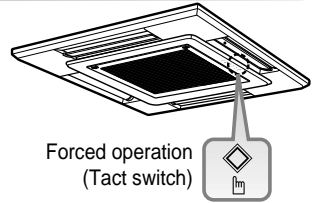

	Cooling Model	Heat pump Model	
		Room Temp. \geq set Temp.-2°C	Room Temp. $<$ set Temp.-2°C
Operating mode	Cooling	Cooling	Heating
Indoor FAN Speed	High	set available	set available
Setting Temperature	22°C	set available	set available

Auto Restart Function

In case the power comes on again after a power failure, Auto Restarting Operation is the function to operate procedures automatically to the previous operating conditions.

Tips for Filter sign LED

- 1 Filter sign lamp (LED) is ON.
- 2 If LED indicating filter sign lamp is ON, clean the filter.
- 3 After cleaning the filter, press the Timer button and button of wired remote controller at the same time for 3 sec. Then filter sign LED is OFF.

PLASMA Purification Operation (Optional)

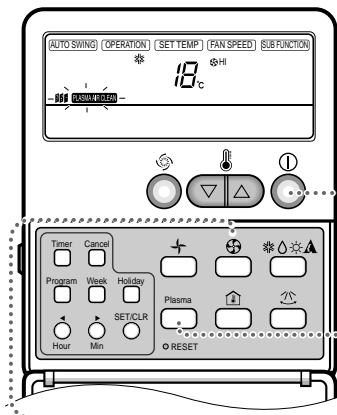

- 1 Press the On/Off button. The unit will respond with a beep.



- 2 Open the door on the remote control. Press the PLASMA air purifying operation ON/OFF button. Operation will start when the button is pressed and stop when the button is pressed again.



- 3 Set the fan speed again with door of the remote control closed. You can select the fan speed in four steps-low, medium, high or Auto. Each time the button is pressed, the fan speed mode is shifted.



* Air purifying operation (PLASMA) with cooling, heating or any other operations.

Care and Maintenance

Care and maintenance of the air conditioner

Indoor Unit

Grille, Case and Remote Control

☐ Turn the system off before cleaning. To clean, wipe with a soft, dry cloth. Do not use bleach or abrasives.

NOTE:

Supply power must be disconnected before cleaning the indoor unit.

Air Filters

The air filters behind the front grille should be checked and cleaned once every 2 weeks or more often if necessary.

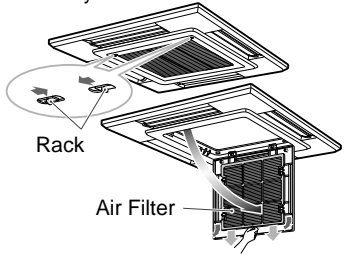

- Never use any of the followings:
 - Water hotter than 40°C. Could cause deformation and/or discoloration.
 - Volatile substances. Could damage the surfaces of the air conditioner.

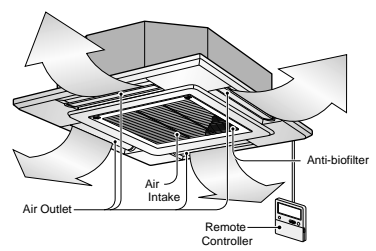

- 1 Remove the Air filters.
 - Take hold of the tab and pull slightly forward to remove the filter.

CAUTION

When the air filter is to be removed, do not touch the metal parts of the indoor unit. It may cause an injury.

- 2 Clean dirt from the air filter using a vacuum cleaner or washing with water.
 - If dirt is conspicuous, wash with a neutral detergent in lukewarm water.
 - If hot water (50°C or more) is used, it may be deformed.
- 3 After washing with water, dry well in the shade.
 - Do not expose the air filter to direct sunlight or heat from a fire when drying it.
- 4 Install the air filter.

Outdoor Unit

The heat exchanger coils and panel vents of the outdoor unit should be checked regularly. If clogged with dirt or soot, the heat exchanger and panel vents may be professionally steam cleaned.

NOTE:

Dirty or clogged coils will reduce the operating efficiency of the system and cause higher operating costs.

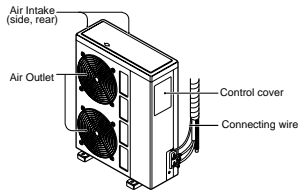
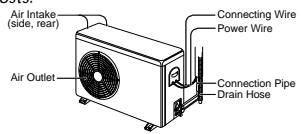

Purifying filter (Optional)

Cleaning

The PLASMA filter behind the air filters should be checked and cleaned once every 3 months or more often if necessary.

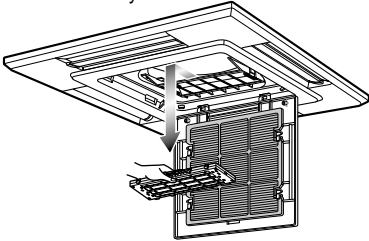

- 1 After removing the air filters, pull slightly forward to remove the PLASMA filter.
- 2 Dip the PLASMA filter into the water mixed with neutral detergent, for 20~30 minutes.
- 3 Dry the PLASMA filter in the shade for a day (Especially, the humidity must be removed perfectly on this parts).
- 4 Note the cuts of electric discharge lines.
- 5 Re-install the PLASMA filter to the original position.



Don't touch this PLASMA Filter within 10 seconds after opening the inlet grille, it may cause an electric shock.

Replacement

• Recommended use period : About 2 years

- 1 Open front panel and remove air filter.

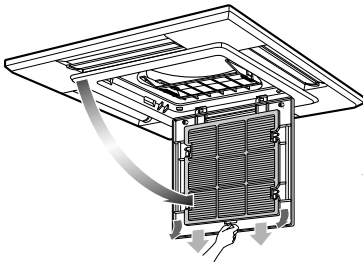

- 2 Remove air purifying filter.
- 3 Insert new air purifying filter.

- 4 Reinsert air filter and close front panel.

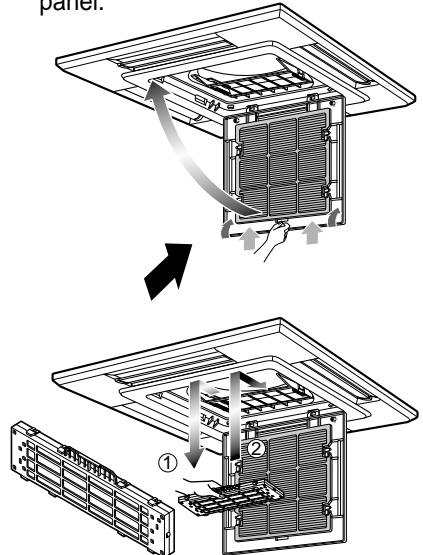

When the air conditioner is not GOING to be used for a long time.

When it is not going to be used for a long time.

- 1 Operate the air conditioner at the following settings for 2 to 3 hours.
 - Type of operation: Fan operation mode. (Refer to page 17.)
 - This will dry out the internal mechanisms.

- 2 Turn off the breaker.



CAUTION
Turn off the breaker when the air conditioner is not going to be used for a long time.

Dirt may collect and may cause a fire.

When the air conditioner is to be used again.

- 1 Clean the air filter and install it in the indoor unit.
(Refer to page 21 for cleaning it.)
- 2 Check that the air inlet and outlet of the indoor/outdoor unit are not blocked.
- 3 Check that the ground wire is connected correctly. It may be connect to the indoor unit side.

Helpful information

The air filters and your electric bill. If the air filters become clogged with dust, the cooling capacity will drop, and 6% of the electricity used to operate the air conditioner will be wasted.

Operation Tips

⊘ Do not overcool the room.

This is not good for the health and wastes electricity.

ⓘ Make sure that the doors and windows are shut tight.

Avoid opening doors and windows as much as possible to keep the cool air in the room.

ⓘ Keep blinds or curtains closed.

Do not let direct sunshine enter the room when the air conditioner is in operation.

ⓘ Clean the air filter regularly.

Blockages in the air filter reduce the airflow and lower cooling and dehumidifying effects. Clean at least once every two weeks.

ⓘ Keep the room temperature uniform.

Adjust the vertical and horizontal airflow direction to ensure a uniform temperature in the room.

ⓘ Ventilate the room occasionally.

Since windows are kept closed, it is a good idea to open them and ventilate the room now and then.

Troubleshooting Tips! Save time and money!

Check the following points before requesting repairs or service.... If the malfunction persist, please contact your dealer.

Case	Explanation	See page
The air conditioner does not operate.	• Have you made a mistake in timer operation?	10
	• Has the fuse blown or has the circuit breaker been tripped?	-
The room has a peculiar odor.	• Check that this is not a damp smell exuded by the walls, carpet, furniture or cloth items in the room.	-
It seems that condensation is leaking from the air conditioner.	• Condensation occurs when the airflow from the air conditioner cools the warm room air.	-
Air conditioner does not operate for about 3 minutes when restart.	• This is the protector of the mechanism.	-
	• Wait about three minutes and operation will begin.	-
Does not cool or heat effectively.	• Is the air filter dirty? See air filter cleaning instructions.	21
	• The room may have been very hot when the room air conditioner was first turned on. Allow time for it to cool down.	-
	• Has the setting temperature been set incorrectly?	12, 14
	• Are the indoor unit's air inlet or outlet vents obstructed?	-
The air conditioner operation is noisy.	• For a noise that sounds like water flowing. -This is the sound of freon flowing inside the air conditioner unit.	-
	• For a noise that sounds like the compressed air releasing into atmosphere. -This is the sound of the dehumidifying water being processed inside the air conditioning unit.	-
Crack sound is heard.	• This sound is generated by the expansion/contraction of the inlet grille, etc. due to changes of temperature.	-
Filter sign lamp (LED) is ON.	• Cleaning the filter, press the Timer button and button of wired remote controller at the same time for 3 sec.	-
Remote control display is faint, or no display at all.	• Has the circuit breaker been tripped?	-
	• Are the batteries inserted in the opposite (+) and (-) directions?	-

