



## 2.1CH Home Theater System

### OWNER'S MANUAL

MODEL: J10HD

SPEAKERS: J10HD-SF/J10HD-SA



Before connecting, operating or adjusting this product,  
please read this instruction booklet carefully and  
completely.



**CAUTION: THESE SERVICING INSTRUCTIONS ARE FOR USE BY QUALIFIED SERVICE PERSONNEL ONLY. TO REDUCE THE RISK OF ELECTRIC SHOCK DO NOT PERFORM ANY SERVICING OTHER THAN THAT CONTAINED IN THE OPERATING INSTRUCTIONS UNLESS YOU ARE QUALIFIED TO DO SO.**



**Caution: The apparatus should not be exposed to water (dripping or splashing) and no objects filled with liquids, such as vases, should be placed on the apparatus.**

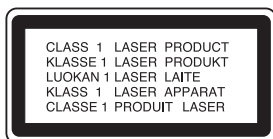

**CAUTION:**  
CLASS 3B VISIBLE AND INVISIBLE LASER RADIATION WHEN OPEN AND INTERLOCKS DEFEATED AVOID EXPOSURE TO THE BEAM.



**CAUTION: This product employs a Laser System.**

**To ensure proper use of this product, please read this owner's manual carefully and retain for future reference. Should the unit require maintenance, contact an authorized service center.**

**Use of controls, adjustments, or the performance of procedures other than those specified herein may result in hazardous radiation exposure.**

**To prevent direct exposure to laser beam, do not try to open the enclosure. Visible laser radiation when open. DO NOT STARE INTO BEAM.**



**WARNING: Do not install this equipment in a confined space such as a bookcase or similar unit.**



This product is manufactured to comply with the EEC DIRECTIVE 89/336/EEC, 93/68/EEC and 73/23/EEC.

The main label is attached on the exterior of the bottom of the apparatus.

## CAUTION concerning the Power Cord

**Most appliances recommend they be placed upon a dedicated circuit;**

That is, a single outlet circuit which powers only that appliance and has no additional outlets or branch circuits. Check the specification page of this owner's manual to be certain.

Do not overload wall outlets. Overloaded wall outlets, loose or damaged wall outlets, extension cords, frayed power cords, or damaged or cracked wire insulation are dangerous. Any of these conditions could result in electric shock or fire. Periodically examine the cord of your appliance, and if its appearance indicates damage or deterioration, unplug it, discontinue use of the appliance, and have the cord replaced with an exact replacement part by an authorized servicer.

Protect the power cord from physical or mechanical abuse, such as being twisted, kinked, pinched, closed in a door, or walked upon. Pay particular attention to plugs, wall outlets, and the point where the cord exits the appliance.

To disconnect power from the mains, pull out the mains cord plug. When installing the product, ensure that the plug is easily accessible.

## SERIAL NUMBER:

You can find the serial number on the bottom of the unit. This number is unique to this unit and not available to others. You should record requested information here and retain this guide as a permanent record of your purchase.

Model No. \_\_\_\_\_

Serial No. \_\_\_\_\_



## Disposal of your old appliance

1. When this crossed-out wheeled bin symbol is attached to a product it means the product is covered by the European Directive 2002/96/EC.
2. All electrical and electronic products should be disposed of separately from the municipal waste stream via designated collection facilities appointed by the government or the local authorities.
3. The correct disposal of your old appliance will help prevent potential negative consequences for the environment and human health.
4. For more detailed information about disposal of your old appliance, please contact your city office, waste disposal service or the shop where you purchased the product.

Manufactured under license from Dolby Laboratories. "Dolby" and the double-D symbol are trademarks of Dolby Laboratories.

"DTS" and "DTS 2.0" are trademarks of Digital Theater Systems, Inc.

# Gracenote® End User License Agreement

Version 20061005

This application or device contains software from Gracenote, Inc. of Emeryville, California ("Gracenote"). The software from Gracenote (the "Gracenote Software") enables this application to perform disc and/or file identification and obtain music-related information, including name, artist, track, and title information ("Gracenote Data") from online servers or embedded databases (collectively, "Gracenote Servers") and to perform other functions. You may use Gracenote Data only by means of the intended End-User functions of this application or device.

You agree that you will use Gracenote Data, the Gracenote Software, and Gracenote Servers for your own personal non-commercial use only. You agree not to assign, copy, transfer or transmit the Gracenote Software or any Gracenote Data to any third party. **YOU AGREE NOT TO USE OR EXPLOIT GRACENOTE DATA, THE GRACENOTE SOFTWARE, OR GRACENOTE SERVERS, EXCEPT AS EXPRESSLY PERMITTED HEREIN.**

You agree that your non-exclusive license to use the Gracenote Data, the Gracenote Software, and Gracenote Servers will terminate if you violate these restrictions. If your license terminates, you agree to cease any and all use of the Gracenote Data, the Gracenote Software, and Gracenote Servers. Gracenote reserves all rights in Gracenote Data, the Gracenote Software, and the Gracenote Servers, including all ownership rights. Under no circumstances will Gracenote become liable for any payment to you for any information that you provide. You agree that Gracenote, Inc. may enforce its rights under this Agreement against you directly in its own name.

The Gracenote service uses a unique identifier to track queries for statistical purposes. The purpose of a randomly assigned numeric identifier is to allow the Gracenote service to count queries without knowing anything about who you are. For more information, see the web page for the Gracenote Privacy Policy for the Gracenote service.

The Gracenote Software and each item of Gracenote Data are licensed to you "AS IS." Gracenote makes no representations or warranties, express or implied, regarding the accuracy of any Gracenote Data from in the Gracenote Servers. Gracenote reserves the right to delete data from the Gracenote Servers or to change data categories for any cause that Gracenote deems sufficient. No warranty is made that the Gracenote Software or Gracenote Servers are error-free or that functioning of Gracenote Software or Gracenote Servers will be uninterrupted. Gracenote is not obligated to provide you with new enhanced or additional data types or categories that Gracenote may provide in the future and is free to discontinue its services at any time.

**GRACENOTE DISCLAIMS ALL WARRANTIES EXPRESS OR IMPLIED, INCLUDING, BUT NOT LIMITED TO, IMPLIED WARRANTIES OF MERCHANTABILITY, FITNESS FOR A PARTICULAR PURPOSE, TITLE, AND NON-INFRINGEMENT. GRACENOTE DOES NOT WARRANT THE RESULTS THAT WILL BE OBTAINED BY YOUR USE OF THE GRACENOTE SOFTWARE OR ANY GRACENOTE SERVER. IN NO CASE WILL GRACENOTE BE LIABLE FOR ANY CONSEQUENTIAL OR INCIDENTAL DAMAGES OR FOR ANY LOST PROFITS OR LOST REVENUES.**

© Gracenote 2006

# Contents

<b>Introduction</b> .....	<b>5-10</b>
Symbol Used in this Manual .....	5
Notes on Discs .....	5
Playable Discs .....	6
Regional Code .....	6
Availability of copying or moving feature .....	6
About the internal hard disk drive .....	7
Playing media files using the USB feature .....	7
Main Unit .....	8
Active Subwoofer .....	9
Remote Control .....	10
Remote Control Operation .....	10
<b>Hookup and Settings</b> .....	<b>11-17</b>
Making system connections .....	11-12
HDMI connection .....	13
Using the Home Menu .....	14
Initial Settings .....	14
General Settings .....	14
TV Aspect .....	14
Display Mode .....	14
PBC (Version 2.0) .....	15
Initialization .....	15
Language Settings .....	15
Audio Settings .....	15
DRC (Dynamic Range Control) .....	15
Vocal .....	15
HD AV Sync .....	15
2.1 Speaker Setup .....	15
Lock (Parental Control) Settings .....	16
Set Password / Rating / Area Code .....	16
DivX Registration Code .....	16
Displaying Disc Information on-screen .....	17
<b>Playback</b> .....	<b>18-30</b>
General Playback Features .....	18-20
Playing a DivX Movie File .....	21
Playing an Audio CD or MP3/WMA file .....	22-23
Identifying the audio CD tracks or the stored music files in the hard disk .....	24
Program Playback with Audio CD and MP3/WMA file .....	25
Viewing a JPEG File .....	26-27
Editing a MP3/WMA, JPEG, DivX file .....	28-29
AUX/MOBILE/SCART/OPTICAL (Listening to an external source) .....	30
Using Apple iPod .....	30
<b>Recording</b> .....	<b>31-32</b>
Ripping CDs (for audio CDs) .....	31
To find your ripped tracks .....	31
Recording from radio .....	31
Timeshift .....	32

<b>Reference</b> .....	<b>33-38</b>
Additional Information .....	33
Presetting the Radio Stations .....	33
Listening to the Radio .....	33
RDS Operation .....	34
Programme Search (PTY) .....	34
Sleep .....	35
Dimmer .....	35
XTS pro .....	35
Virtual sound .....	35
Controlling Your TV with the Supplied Remote Control .....	35
Language Codes .....	36
Area Codes .....	36
Troubleshooting .....	37
Specifications .....	38

## Copyright

- Recording equipment should be used only for lawful copying and you are advised to check carefully what is lawful copying in the area in which you are making a copy. Copying of copyright material such as films or music is unlawful unless permitted by a legal exception or consented to by the rights owner.
- This product incorporates copyright protection technology that is protected by method claims of certain U.S. patents and other intellectual property rights owned by Macrovision Corporation and other rights owners. Use of this copyright protection technology must be authorized by Macrovision Corporation, and is intended for home and other limited viewing uses only, unless otherwise authorized by Macrovision corporation. Reverse engineering or disassembly is prohibited.
- CONSUMERS SHOULD NOTE THAT NOT ALL HIGH DEFINITION TELEVISION SETS ARE FULLY COMPATIBLE WITH THIS PRODUCT AND MAY CAUSE ARTIFACTS TO BE DISPLAYED IN THE PICTURE. IN CASE OF 625 PROGRESSIVE SCAN PICTURE PROBLEMS, IT IS RECOMMENDED THAT THE USER SWITCH THE CONNECTION TO THE 'STANDARD DEFINITION' OUTPUT. IF THERE ARE QUESTIONS REGARDING OUR TV SET COMPATIBILITY WITH THIS MODEL 625p HDD/DVD RECORDER, PLEASE CONTACT OUR CUSTOMER SERVICE CENTER.

# Introduction

To ensure proper use of this product, please read this owner's manual carefully and retain for future reference.

This manual provides information on the operation and maintenance of your unit. Should the unit require service, contact an authorized service location.

## Symbol Used in this Manual



The lightning flash symbol alerts you to the presence of dangerous voltage within the product enclosure that may constitute a risk of electric shock.



The exclamation point alerts you to the presence of important operating and maintenance / servicing instructions.



Indicates hazards likely to cause harm to the unit itself or other material damage.

### Note:

Indicates special notes and operating features.

### Tip:

Indicates tips and hints for making the task easier.

A section whose title has one of the following symbols are applicable only to the disc represented by the symbol.

<b>ALL</b>	All discs and file listed below
<b>DVD</b>	DVD and finalized DVD±R/RW
<b>VCD</b>	Video CDs
<b>ACD</b>	Audio CDs
<b>DivX</b>	DivX files
<b>MP3</b>	MP3 files
<b>WMA</b>	WMA files
<b>JPEG</b>	JPEG files

## About the Symbol Display

"" may appear on your TV display during operation and indicates that the function explained in this owner's manual is not available on that specific media.

## Notes on Discs

### Handling Discs

Do not touch the playback side of the disc. Hold the disc by the edges so that fingerprints do not get on the surface. Never stick paper or tape on the disc.

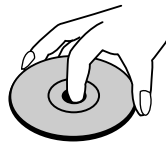

### Storing Discs

After playing, store the disc in its case. Do not expose the disc to direct sunlight or sources of heat and never leave it in a parked car exposed to direct sunlight.

### Cleaning Discs

Fingerprints and dust on the disc can cause poor picture quality and sound distortion. Before playing, clean the disc with a clean cloth. Wipe the disc from the center out.

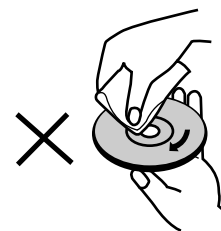
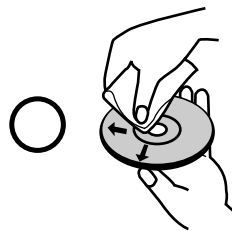

Do not use strong solvents such as alcohol, benzene, thinner, commercially available cleaners, or anti-static spray intended for older vinyl records.

## Moisture Condensation

Never operate this product immediately after moving it from a cold location to a warm location. Leave it for two or three hours without operating it. If you use this product in such a situation, it may damage discs and internal parts.

## Playable Discs



### DVD (8 cm / 12 cm disc)

- Discs such as movies that can be purchased or rented



### Video CD (VCD) (8 cm / 12 cm disc)

- VIDEO CDs or CD-Rs/CD-RWs in VIDEO CD/Super VIDEO CD format



### Audio CD (8 cm / 12 cm disc)

- Music CDs or CD-Rs/CD-RWs in music CD format that can be purchased



### CD-R/CD-RW (8 cm / 12 cm disc)

- CD-R/CD-RW discs that contain audio titles, DivX, MP3, WMA, or JPEG files.

### Notes:

- Depending on the conditions of the recording equipment or the CD-R/RW (or DVD±R/RW) disc itself, some CD-R/RW (or DVD±R/RW) discs cannot be played on the unit.
- Do not attach any seal or label to either side (the labeled side or the recorded side) of a disc.
- Do not use irregularly shaped CDs (e.g., heart-shaped or octagonal). Doing so may result in malfunctions.
- Depending on the recording software & the finalization, some recorded discs (CD-R/RW or DVD±R/RW) may not be playable.
- DVD-R/RW, DVD+R/RW and CD-R/RW discs recorded using a personal computer or a DVD or CD Unit may not play if the disc is damaged or dirty, or if there is dirt or condensation on the Unit's lens.
- If you record a disc using a personal computer, even if it is recorded in a compatible format, there are cases in which it may not play because of the settings of the application software used to create the disc. (Check with the software publisher for more detailed information.)
- This unit requires discs and recordings to meet certain technical standards in order to achieve optimal playback quality. Pre-recorded DVDs are automatically set to these standards. There are many different types of recordable disc formats (including CD-R containing MP3 or WMA files) and these require certain pre-existing conditions (see above) to ensure compatible playback.
- Customers should note that permission is required in order to download MP3 / WMA files and music from the Internet. Our company has no right to grant such permission. Permission should always be sought from the copyright owner.

## Regional Code

This unit has a regional code printed on the bottom of the unit. This unit can play only DVD discs labeled same as the bottom of the unit or "ALL".

### Notes on Regional Codes

- Most DVD discs have a globe with one or more numbers in it clearly visible on the cover. This number must match your unit's regional code or the disc cannot play.
- If you try to play a DVD with a different regional code from the unit, the message "Incorrect region code. Can't play back" appears on the TV screen.

## Availability of copying or moving feature

From	To	MP3/WMA	JPEG	DivX	Audio CD	Video CD
HDD	DISC	No	No	No	No	No
HDD	USB device	No	No	No	No	No
DISC	HDD	<b>Yes</b>	<b>Yes</b>	<b>Yes</b>	No*	No
DISC	USB device	No	No	No	No	No
USB device	DISC	No	No	No	No	No
USB device	HDD	<b>Yes</b>	<b>Yes</b>	<b>Yes</b>	No	No

\* You can rip Audio CD tracks to the hard disk.

## About the internal hard disk drive

The internal hard disk drive (HDD) is a fragile piece of equipment. Please use the unit following the guidelines below to protect against possible HDD failure.

We recommend that you back up your important recordings onto DVD discs in order to protect against accidental loss.

- Do not move the unit while it is on.
  - Install and use the unit on a stable, level surface.
  - Do not block the rear vent/cooling fan.
  - Do not use the unit in excessively hot or humid places, or in places that may be subject to sudden changes in temperature. Sudden changes in temperature can cause condensation to form inside the unit. This can be a cause of HDD failure.
  - While the unit is switched on, do not unplug from the wall socket or switch the electricity off from the breaker switch.
  - Do not move the unit immediately after switching it off. If you need to move the unit, please follow the steps below:
    1. After the message POWER OFF is shown in the display, wait at least two minutes.
    2. Unplug from the wall socket.
    3. Move the unit.
  - If there's a power failure while the unit is on there is a chance that some data on the HDD will be lost.
  - The HDD is very delicate. If used improperly or in an unsuitable environment, it is possible that the HDD will fail after a few years of use. Signs of problems include playback unexpectedly freezing and noticeable block noise (mosaic) in the picture. However, sometimes there will be no warning signs of HDD failure.
- If the HDD fails, no playback of recorded material will be possible. In this case it will be necessary to replace the HDD unit.

## Playing media files using the USB feature

You can enjoy the media files such as pictures (JPEG), movies (DivX) and tunes (MP3/WMA) saved in an MP3 player or USB memory by connecting the storage device to the USB port of this unit.

1. Connect the USB device to the USB port of the unit.
2. Press HOME on the remote control.
3. Select [MUSIC], [PHOTO] or [MOVIE] option. Details for the options are on page 14.

### Compatible Devices

1. Devices which require additional program installation when you have connected it to a computer, are not supported.
2. MP3 Player: Flash type MP3 player.
  - The MP3 player requiring installation of a driver is not supported.
3. USB Flash Drive: Devices that support USB2.0 or USB1.1.

### Notes:

- **Do not extract the USB device in operating (play, copy, move, etc.).**
- A back up demands to prevent a data damage.
- If you use a USB extension cable or USB hub, the USB device might not be recognized.
- This unit can support USB 2.0 or USB 1.1.
- A device using NTFS file system is not supported. (Only FAT (16/32) file system is supported.)
- The USB function of this unit does not support all USB devices.
- Digital camera and mobile phone are not supported.
- This unit is not supported when the total number of files is 1000 or more.

## Main Unit

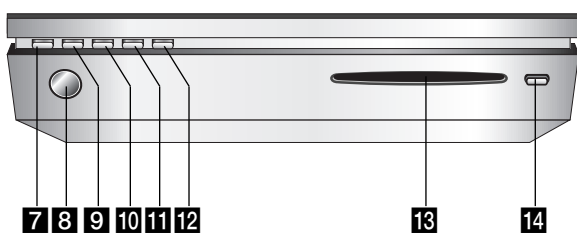
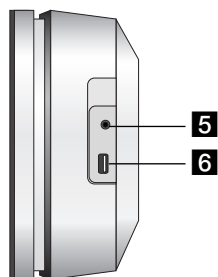
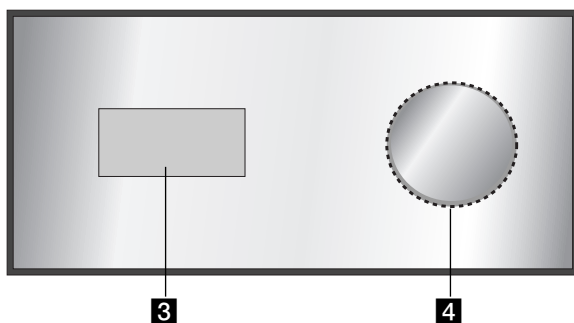
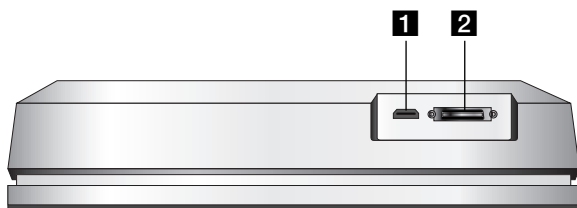

### 1 HDMI Connector (Type A)

HDMI output providing a high quality interface for digital audio and video.

### 2 SYSTEM Connector

Connect the main unit to the active subwoofer.

### 3 Display window

### 4 \* Touch pad

You can point to, select, and scroll objects on the display window.

You can also change the volume by moving your finger around the touch wheel.

### 5 PHONES

3.5 mm headphone jack.

#### Tips:

- Adjust the volume to a moderate level before you plug in the headphones.
- Connecting headphones will switch off the speakers.

### 6 USB

Connect to a USB port of multimedia (USB memory etc.)

### 7

Switches the unit ON or OFF.

### 8 Remote Sensor

Point the unit remote control here.

### 9 HOME

Accesses or removes the HOME menu.

### 10 PLAY

Starts playback

### 11 STOP

Stops playback or recording.

### 12 REC

Starts recording.

### 13 CD slot loader

#### Notes:

- Do not push a disc forcibly into the CD slot.
- Do not pull or push a disc while a disc is ejected.
- Press EJECT again to reinsert the disc after ejecting it.

### 14 EJECT

Ejects or inserts a disc from the slot loader.



### \* Touch pad

This unit has touch sensitive controls that respond to the touch of your fingers.

#### Notes:

- Do not place objects on the top panel of the main unit.
- Do not touch the touch pad hard to make it work.
- Slowly and lightly touch the touch pad.
- Touch the touch pad with bare hands and do not touch the touch pad with wet hands.

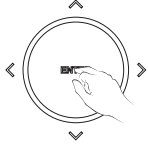
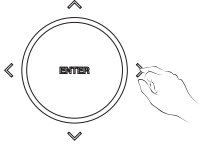
Action			
Description	Move your finger around the touch wheel	Tap ENTER	Tap $\wedge$ , $\vee$ , $\langle$ , or $\rangle$
Function	Adjust the volume	Select a menu item	Move up, down, left, or right

## Active Subwoofer

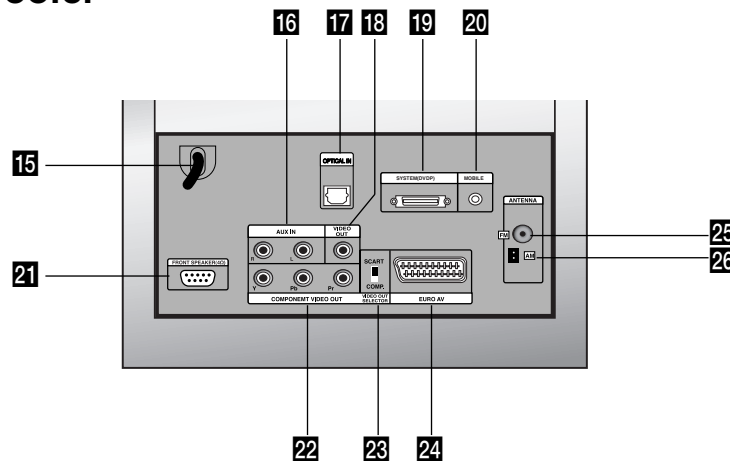

#### 15 AC Power Cord

Plug into the power source.

#### 16 AUX IN

Connect an auxiliary audio input source.

#### 17 OPTICAL IN

Connect an optical output of digital device.

#### 18 VIDEO OUT

Connect to a Video Input on TV.

#### 19 SYSTEM (DVDP)

Connect the active subwoofer to the main unit.

#### 20 MOBILE

Connect an external device (e.g. Portable audio devices)

#### 21 FRONT SPEAKER (4Ω)

A speaker system can be connected to this terminal.

#### 22 COMPONENT VIDEO OUT (Y Pb Pr)

Connect to a TV with Y Pb Pr inputs.

#### 23 VIDEO OUT SELECTOR

Select either COMPONENT or RGB signal of EURO AV terminal depending on how you connect the unit to the TV.

#### 24 EURO AV

Connect to a TV with SCART jack.

#### 25 FM ANTENNA

Connect the FM antenna to this terminal.

#### 26 AM ANTENNA

Connect the AM antenna to this terminal.

## Remote Control

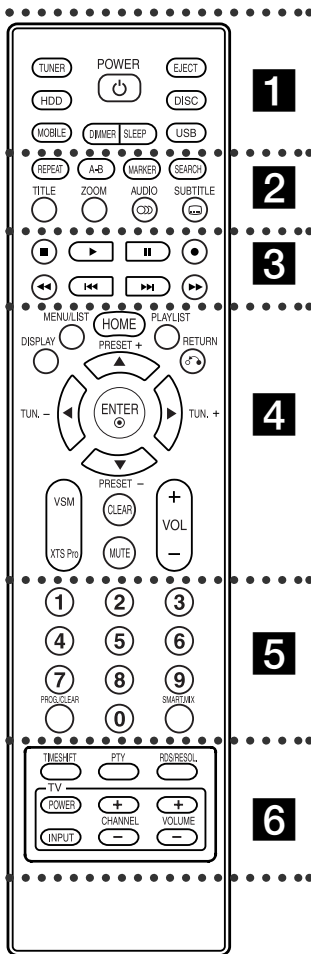

..... **1** .....

**TUNER:** Selects an FM or AM broadcast.

**HDD:** Selects an HDD mode.

**MOBILE:** Selects a MOBILE mode.

**POWER:** Switches the unit ON or OFF.

**DIMMER:** Press to change brightness of the display window on the top panel during power-on status.

## Remote Control Operation

Point the Remote Control at the remote sensor and press the buttons.

**SLEEP:** Set the system to turn off automatically at a specified time.

**EJECT:** Ejects or inserts disc from the slot loader.

**DISC:** Selects a DISC mode.

**USB:** Selects a USB mode.

..... **2** .....

**REPEAT:** Repeat chapter, track, title or all.

**A-B:** Repeats sequence between two points (A and B)

**MARKER:** Marks any point during playback.

**SEARCH:** Displays Marker Search menu.

**TITLE:** Displays the disc's Title menu, if available.

**ZOOM:** Enlarges video image.

**AUDIO:** Selects an audio language or audio channel. Selects STEREO or MONO (Radio).

**SUBTITLE:** Selects a subtitle language.

..... **3** .....

■ **(STOP):** Stops playback or recording.

▶ **(PLAY):** Starts playback.

⏸ **(PAUSE) :** Pause playback temporarily.

● **(REC):** Starts recording.

◀◀ / ▶▶ **(SCAN):** Search backward or forward.

◀◀◀ / ▶▶▶ **(SKIP):** Go to next or previous chapter or track.

..... **4** .....

**DISPLAY:** Accesses On-Screen Display.

**MENU/LIST:** Accesses menu on a DVD disc.

**HOME:** Accesses or removes the HOME menu.

**PLAYLIST:** Displays playlists of HDD Music List.

**RETURN (↩):** Removes the menu.

**PRESET(+/-):** Select programme of Radio.

**TUN.(+/-):** Tunes in the desired radio station.

◀ / ▶ / ▲ / ▼ **(left/right/up/down):** Selects an option in the menu.

**ENTER:** Confirms menu selections.

**VSM:** Selects the virtual sound.

**XTS Pro:** To enjoy more natural and realistic sound.

**CLEAR:** Removes a mark on the Marker Search menu.

**MUTE:** Turns the sound on and off temporarily.

**VOLUME (+/-):** Adjusts speaker volume.

..... **5** .....

**0-9 numerical buttons:** Selects numbered options in a menu.

**PROG./CLEAR:** Accesses or removes program menu. Stores a radio station's frequency in the tuner's memory.

**SMART. MIX:** Creates playlists of certain genre of music.

..... **6** .....

**TIMESHIFT:** Activates pause live radio/playback (timeshift) for a live radio program.

**PTY:** To start a search for a specific PTY type.

**RDS/RESOL.:** To view the various displays of the RDS options. Sets the output resolution for HDMI.

**TV Control Buttons:** See page 35.

## Remote Control Battery Installation

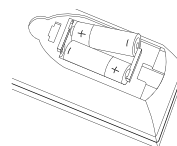

Remove the battery cover on the rear of the Remote Control, and insert two (size AA) batteries with + and - matched correctly.



### Caution

Do not mix old and new batteries. Never mix different types of batteries (standard, alkaline, etc.).

# Hookup and Settings

## Making system connections

Turn off your unit before you set the VIDEO OUT SELECTOR. When using the COMPONENT VIDEO OUT jacks, set the VIDEO OUT SELECTOR to COMP. When using the SCART jack, set the VIDEO OUT SELECTOR to SCART.

### ⚠ Caution

Do not plug the active subwoofer into an AC power(mains) outlet until all the components are connected.

## Connecting the active subwoofer to the unit

Connect one end of the system cable (S1) into the **SYSTEM** jack on the rear of the unit. Connect the other end of the system cable (S1) into the **SYSTEM (DVDP)** jack on the rear of the active subwoofer. Tighten both screws on the connector.

### Note:

The jacks for the system cable are keyed so that the cable connectors only connect in one way.

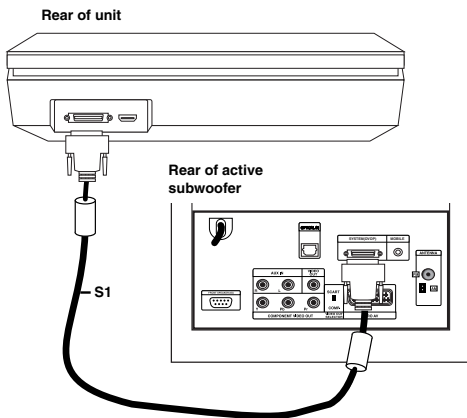

## Connecting the speakers to the active subwoofer

1. Connect one end of the speaker cable (S2) into the FRONT SPEAKER (4Ω) jack on the rear of the active subwoofer. Tighten both screws on the connector.

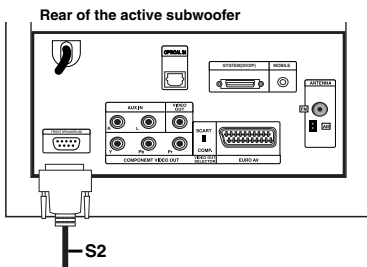

2. Connect the **L** (left) speaker cable (S2) into the rear jack of the left speaker. Connect the **R** (right) speaker cable (S2) into the rear jack of the right speaker.

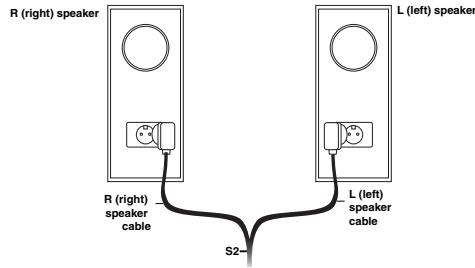

### Note:

Make sure cable connectors are fully inserted and seated firmly in the speaker jacks.

## Connecting the supplied antennas

The rear of the active subwoofer provides jacks for the AM and FM antennas included with your system.

### Note:

An outdoor antenna may be used in place of the supplied indoor antennas. To add an outdoor antenna, consult a qualified installer.

Follow all safety instructions supplied with the antenna.

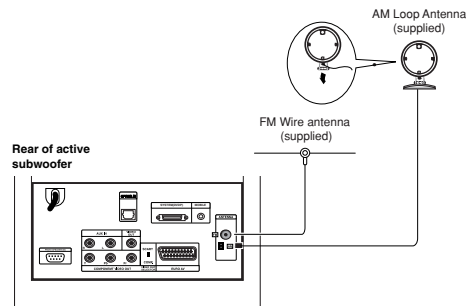

## FM antenna

Connect the FM antenna into the **FM** jack on the rear of the active subwoofer. Spread out the antenna arms and move them around to establish optimum FM reception. Extend the antenna as far from the unit and other equipment as possible.

## AM antenna

Connect the AM loop antenna into the **AM** jack on the rear of the active subwoofer. Place the antenna loop away from the unit and other equipment as possible. Stand it on the supplied base or mount it to a wall.

## Connecting Your TV to the active subwoofer

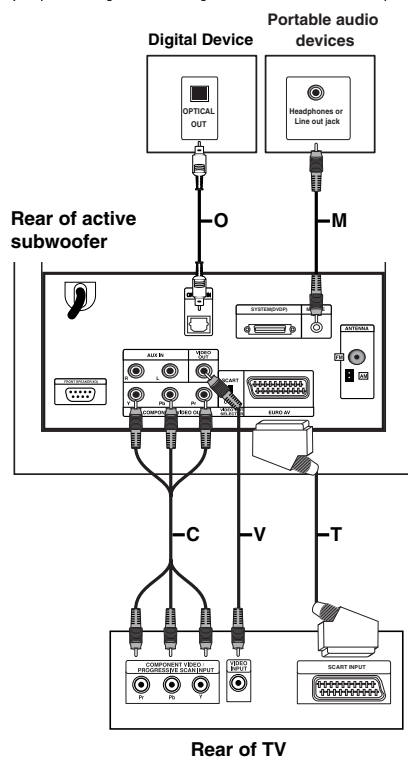

### Video connection

Connect the **VIDEO OUT** jack on the rear of the active subwoofer into the video input jack on your TV using the video cable (**V**).

### Component video connection

Connect the **COMPONENT VIDEO OUT** jacks on the rear of the active subwoofer into the corresponding input jacks on your TV using a component video cable (**C**). If your television is a high-definition or "digital ready" television, you may take advantage of the unit's progressive scan output for the highest video resolution possible. If your TV does not accept the progressive scan format, the picture will appear scrambled if you try progressive scan on the unit. Set the resolution to 576P using RDS/RESOL. button for progressive signal.

#### **Note:**

Progressive scan does not work with the analog video connection (yellow VIDEO OUT jack).

### SCART connection

Connect the **EURO AV** scart jack on the rear of the active subwoofer into the corresponding input jack on your TV using the scart cable (**T**).

### Optical digital connection

Connect an optical output of digital device into the **OPTICAL IN** jack on the rear of the active subwoofer using optical cable (**O**).



#### **Caution**

When you use HDMI connection, if the resolution is set to 720p or 1080i, the **VIDEO OUT** and **EURO AV** connections are not available.

### Connecting an additional appliance

There are two options for connecting an additional appliance to the unit.

- Option A: **AUX IN (L/R)** jacks (e.g. VCR, Laser disc player)
- Option B: **MOBILE** jack (e.g. Portable audio devices)

#### Option A: **AUX IN (L/R)** jacks

1. Connect the red plug of the red/white audio cables to the red jack **AUX IN R** and white plug to the white jack **AUX IN L**.
2. Connect the other end of the audio cables to audio output jacks of the additional appliance.

#### **Note:**

If the connected device has only a single audio output jack, connect it to the **AUX IN L** jack.

#### Option B: **MOBILE** jack

1. Connect one end of an audio cable (M) with a 3.5 millimeter stereo miniplug into the **MOBILE** jack on the rear of the active subwoofer.
2. Connect the other end of an audio cable (M) with a 3.5 millimeter stereo miniplug into the headphone jack (or line out jack) of the additional appliance.

## HDMI connection

If you have a HDMI TV or monitor, you can connect it to this unit using a HDMI cable.

1. Connect the HDMI jack on the unit to the HDMI jack on a HDMI compatible TV or monitor (H).
2. Set the TV's source to HDMI (refer to TV's Owner's manual).

### Notes:

- The arrow on the cable connector body should face up for correct alignment with the connector on the unit.

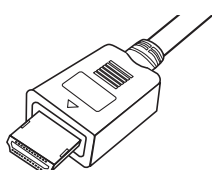

(Type A)

- If there is noise or lines on the screen, please check the HDMI cable.
- If you press RDS/RESOL. in tuner (RADIO) mode, the resolution is not changed.

### Tip :

When you use HDMI connection, you can change the resolution (576p, 720p, or 1080i) for the HDMI output using RDS/RESOL. button.

### Caution

Changing the resolution when the unit is connected with HDMI connector may result in malfunctions. To solve the problem, turn off the unit and then turn it on again.

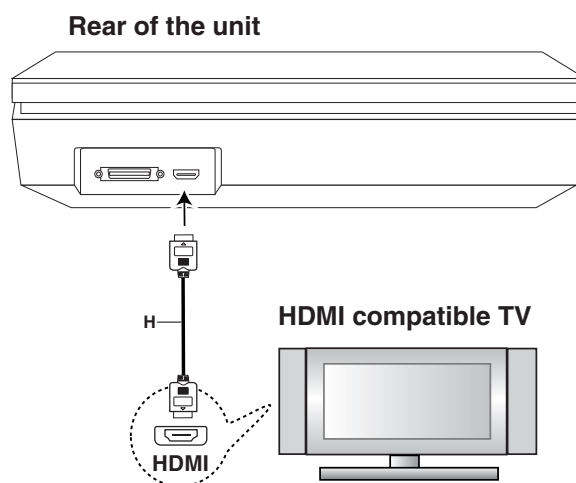

### About HDMI

HDMI (High Definition Multimedia Interface) supports both video and audio on a single digital connection for use with DVD Players, Set-Top Boxes, and other AV devices.

HDMI was developed to provide the technologies of HDCP (High Definition Contents Protection). HDCP is used to protect digital content transmitted and received.

HDMI has the capability to support standard, enhanced, or high-definition video plus standard to multi-channel surround-sound audio, HDMI features include uncompressed digital video, a bandwidth of up to 5 gigabytes per second, one connector (instead of several cables and connectors), and communication between the AV source and AV devices such as DTVs.

*HDMI, the HDMI logo and High-Definition Multimedia Interface are trademarks or registered trademarks of HDMI licensing LLC.*

### Additional Information for HDMI

- When you connect a HDMI or DVI compatible device make sure of the followings:
  - Try switching off the HDMI/DVI device and this unit. Next, switch on the HDMI/DVI device and leave it for around 30 seconds, then switch on this unit.
  - The connected device's video input is set correctly for this unit.
  - The connected device is compatible with 720x576p, 1280x720p, or 1920x1080i video input.
- Not all HDCP-compatible DVI devices will work with this unit.
  - The picture will not be displayed properly with non-HDCP device.
  - When the connected TV cannot accept the resolution you selected, you may not see normal picture on the TV screen.

## Using the Home Menu

From the Home Menu screen you can access all the Media for playback and recording of the unit.

1. Press HOME to display the Home Menu screen.
2. Use the ◀ / ▶ buttons to select a main option you want. Sub options appears.
3. Use the ▲ / ▼ and ENTER buttons to select the sub option you want.

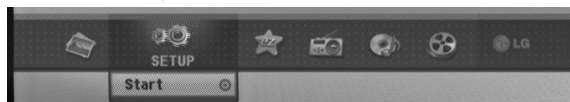

4. To exit the HOME menu, press HOME.

### MOVIE

- **HDD Divx:** Displays the [Movie List] menu for HDD. (See page 21)
- **DISC:**
  - Displays [Movie List] menu for DivX disc. (See page 21)
  - Plays back Video CD or DVD-Video disc. (See page 18-20)
- **USB Divx:** Displays the [Movie List] for USB device. (See page 21)

### PHOTO (See page 26-27)

- **HDD:** Displays [Photo List] menu for HDD.
- **DISC:** Displays [Photo List] menu for disc.
- **USB:** Displays the [Photo List] for USB device.

### SETUP (See page 14)

- **Start:** Displays Setup menu.

### Easy Menu

- **CD Ripping:** Rips Audio CD tracks into the hard disk. (See page 31)
- **AUX:** Selects an auxiliary mode. (See page 30)
- **SCART:** Selects SCART mode. (See page 30)
- **OPTICAL:** Selects OPTICAL mode. (See page 30)

### RADIO

- **Listen:** Selects a Radio mode.

### MUSIC (See page 22-25)

- **HDD:** Displays [Music List] menu for HDD.
- **DISC:** Displays [Music List] (or Audio CD) menu for disc.
- **USB:** Displays the [Music List] for USB device.

## Initial Settings

In this menu system, there are several ways to customize the settings provided. Most menus consist of three levels to set up the options, but some require greater depth for the variety of settings.

## General Operation

1. Select SETUP and press ENTER
2. Use ▲ / ▼ to select the desired option.
3. While the desired item is selected, press ▶ to move to the second level.
4. Use ▲ / ▼ to select the second desired option.
5. Press ▶ to move to the third level.
6. Use ▲ / ▼ to select the desired setting then press ENTER to confirm your selection. Some items require additional steps.
7. Press RETURN (↵) to exit the Setup menu.

### Note:

Press ◀ to go back to the previous level.

## General Settings



### TV Aspect

Selects the aspect ratio of the connected TV (4:3 standard or wide).

- [4:3] Select this when connecting to a 4:3 screen TV. When you select [4:3], set [Display Mode] below.
- [16:9] Select this when connecting to a wide-screen TV or TV with a wide mode function.

### Display Mode

Selects how to display a wide picture on the screen when [4:3] is selected in [TV Aspect].

- [Letter Box] Displays a wide picture with bands on the upper and lower portions of the screen.
- [Pan Scan] Automatically displays a wide picture on the entire screen and cuts off the portions that do not fit.

### Note:

When you set the resolution to 720p or 1080i, TV Aspect and Display Mode are disabled.

## PBC (Version 2.0)

PBC stands for Playback Control and refers to special menus and navigation features that are available on some Video CDs.

- [ON] Video CDs are played according to the PBC, if available.
- [OFF] Video CDs are played the same way as Audio CDs.

## Initialization

You can reset the unit to its original factory settings and initialize the HDD.

- [Factory Set] If you need to, you can reset the unit to all its factory settings. Some options cannot be reset. (Rating, Password, and Area Code)
- [HDD format] Initializes the HDD (Hard Disk Drive): everything recorded on the HDD will be erased.
  1. Select [Initialization] option then press ►.
  2. Press ▲ / ▼ to select the desired option then press ENTER.  
The confirm message will appear.
  3. Use ◀ / ▶ to select [Ok] or [Cancel] then press ENTER.

## Language Settings



### Display Menu

Select a language for the Setup menu and on-screen display.

### Disc Menu/Audio/Subtitle

- [Original] Refers to the original language in which the disc was recorded.
- [Others] To select another language, press number buttons then ENTER to enter the corresponding 4-digit number according to the language code list in the reference chapter (see page 36). If you enter the wrong language code, press ◀.
- [OFF] (for Disc Subtitle) : Turn off Subtitle.

## Audio Settings

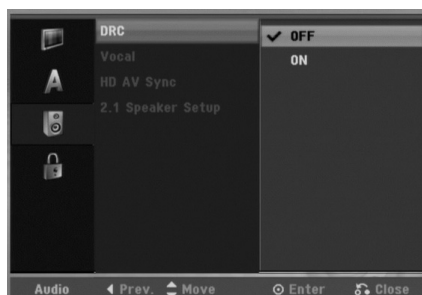

### DRC (Dynamic Range Control)

With the DVD format, you can hear a program's soundtrack in the most accurate and realistic presentation possible, thanks to digital audio technology. However, you may wish to compress the dynamic range of the audio output (the difference between the loudest sounds and the quietest ones). Then, you may listen to a movie at a lower volume without losing clarity of sound. Set DRC to [ON] for this effect.

### Vocal

Set Vocal to [ON] only when a multi-channel karaoke DVD is playing. The karaoke channels on the disc will mix into normal stereo sound.

### HD AV Sync

When using Digital TV;

Sometimes AV signal could not be transmitted simultaneously because of later transmission of video signal compared to audio signal.

Because it takes some time to convert analog video signal to digital one in the Digital TV.

And it means that you may not enjoy picture on the screen and sound from speaker at the same time even though it is one scene.

In the HD AV Sync menu, you could adjust delay time to audio signal for simultaneous AV signal transmission

- Delay time could be set up with 10msec unit. (0 ~ 300msec)
- Delay time is different with each TV Brand. So you need to adjust optimal delay time complying with your TV.

### 2.1 Speaker Setup

Make the following settings for the built-in 2.1 channel surround decoder.

1. Select [2.1 Speaker Setup] option then press ►.
2. Press ► to select a speaker that you want to adjust.  
(L: Left speaker/R: Right speaker/W: Active subwoofer)
3. Press ▲ / ▼ to adjust the output level of the selected speaker.
4. Press ENTER to store the setting.

## Lock (Parental Control) Settings

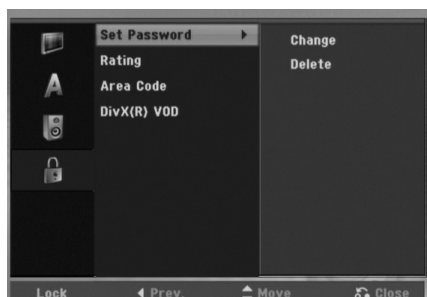

### Set Password

1. Select [Set Password] option then press ►.
2. To access the Rating, Password and Area Code features, you must input the 4-digit password you created.

If you have not yet entered a password you are prompted to do so. Input a 4-digit password and press ENTER. Enter it again and press ENTER to verify. If you make a mistake before pressing ENTER, press ◀.

To change the password, select the [Change], press ENTER and input the old 4-digit password. And input the new 4-digit password then press ENTER. Input it again to verify.

To delete the password, select [Delete] then press ENTER.

Input the 4-digit password you created and press ENTER.

### If you forget your 4-digit password

If you forget your password, to clear the current password, follow the procedure below.

1. Display Setup menu then select an 1 level icon.
2. Use the Number buttons to enter the 6-digit number "210499".
3. Select [Yes] then press ENTER. The 4-digit password is cleared. Enter a new password.

### Rating

Blocks playback of rated DVDs based on their content. Not all discs are rated.

1. Select [Rating] option then press ►.
2. Follow step 2 as shown "Set Password".
3. Select a rating using the ▲ / ▼ buttons.  
[1] - [8]: Rating one (1) has the most restrictions and rating eight (8) is the least restrictive.  
[No Limit]: If you select [No Limit], parental control is not active and the disc plays in full.
4. Press ENTER to confirm your rating selection.

### Note:

If you set a rating for the unit, all disc scenes with the same rating or lower are played. Higher rated scenes are not played unless an alternate scene is available on the disc. The alternative must have the same rating or a lower one. If no suitable alternative is found, playback stops. You must enter the 4-digit password or change the rating level in order to play the disc.

### Area Code

Enter the code of an area whose standards were used to rate the DVD video disc, referring to the list (See "Area Codes", page 36.).

1. Select [Area Code] option then press ►.
2. Follow step 2 as shown "Set Password".
3. Select the first character using the ▲ / ▼ buttons.
4. Shift the cursor using ► buttons and select the second character using ▲ / ▼ buttons.
5. Press ENTER to confirm your area code selection.

### DivX Registration Code

We provide you the DivX® VOD (Video On Demand) registration code that allows you to rent and purchase videos using the DivX® VOD service. For more information, visit [www.divx.com/vod](http://www.divx.com/vod).

1. Select [DivX(R) VOD] option then press ►.
2. Press ENTER and the registration code will appear.
3. Use the registration code to purchase or rent the videos from DivX® VOD service at [www.divx.com/vod](http://www.divx.com/vod). Follow the instructions and download the video onto a disc for playback on this unit.

### Note:

All the downloaded videos from DivX® VOD can only be played back on this unit.



## Displaying Disc Information on-screen

You can display various information about the disc loaded on-screen.

1. Press DISPLAY to show various playback information.  
The items displayed differ depending on the disc type or playing status.



2. You can select an item by pressing ▲ / ▼ and change or select the setting by pressing ◀ / ▶. For details about each item, see the pages in parentheses.
  - [Title]: Current title (or track) number/total number of titles (or tracks)
  - [Chapter]: Current chapter number/total number of chapters.
  - [Time]: Elapsed playing time (See page 20)
  - [Audio]: Selected audio language (DVD VIDEO only) or audio channel (See page 19)
  - [Subtitle]: Selected subtitle (See page 19)
  - [Angle]: Selected angle/total number of angles (See page 20)
  - [Sound]: Selected sound mode (See page 20)

**Note:**

If no button is pressed for 10 seconds, the on-screen display disappears.

# Playback

## General Playback Features





1. Insert your chosen disc into CD loader, with the playback side down.
2. Starts playback using HOME menu (see page 14).
3. To stop the playback, press ■ (STOP).  
The unit records the stopped point, depending on the disc. "■■■" appears on the screen briefly.  
Press ► (PLAY) to resume playback (from the scene point). If you press ■ (STOP) again or eject the disc ("■" appears on the screen.), the unit will clear the stopped point.
4. Press EJECT to remove the disc.

### Note:

If Parental Control is set and the disc is not within the Rating settings (not authorized), the 4-digit code must be entered and/or the disc must be authorized (see "Rating", on page 16).

Buttons	Operations	Discs
EJECT	Ejects or inserts a disc.	<b>ALL</b>
(PAUSE)	During playback, press    to pause playback. Press    repeatedly to play Frame-by-Frame.	<b>ALL</b> <b>DVD VCD DivX</b>
◀◀ / ▶▶ (SKIP)	During playback, press ◀◀ or ▶▶ to return to the beginning of the current chapter/track or to go to the next chapter/track. Press ◀◀ twice briefly to step back to the previous chapter/track. <b>Tips:</b> <ul style="list-style-type: none"> <li>• To go directly to any chapter during DVD playback, press DISPLAY and press ▲ / ▼ to select the chapter icon. Then, input the chapter number or use ◀ / ▶.</li> <li>• On an Audio CD, to go directly to any track, enter the track number using the numbered buttons (0-9) during playback.</li> </ul>	<b>ALL</b>
◀◀ / ▶▶ (SCAN)	During playback, press ◀◀ or ▶▶ repeatedly to select the required scan speed. DVD, DivX ; 4 steps Video CD, Audio CD; 3 steps	<b>DVD VCD DivX</b> <b>ACD</b>
	While the playback is paused, press ◀◀ or ▶▶ repeatedly to play in slow motion. DVD; 4 steps DivX; 4 steps (Forward only) Video CD; 3 steps (Forward only)	<b>DVD VCD DivX</b>
ZOOM	During playback or pause mode, press ZOOM to enlarge the video image. (x1 size → x2 size → x4 size → x1 size (normal size)) You can move through the zoomed picture using ◀ ▶ ▲ ▼ buttons.	<b>DVD VCD</b>

## General Playback Features (Continued)

Buttons	Operations	Discs
REPEAT	<p>During playback, press REPEAT repeatedly to select a desired repeat mode.</p> <p>DVD (Title/Chapter/Off) Video CD, DivX (Title/ALL/Off) Audio CD, MP3/WMA (TRACK/ALL/(OFF))</p> <p><b>Notes:</b></p> <ul style="list-style-type: none"> <li>On a Video CD with PBC, you must set PBC to [OFF] in the Setup menu to use the Repeat function. See page 15.</li> <li>If you press ►► once during Repeat Chapter (Track) playback, the repeat playback cancels.</li> </ul>	<p><b>DVD VCD ACD</b> <b>MP3 WMA DivX</b></p>
A-B	<p>During playback, each press of A-B button to select point A and point B and repeats a sequence from point A (Starting point) to point B (End point).</p>	<p><b>DVD VCD ACD</b> <b>MP3 WMA DivX</b></p>
TITLE	<p>If the current DVD title has a menu, the title menu appears on the screen. Otherwise, the disc menu may appear.</p>	<p><b>DVD</b></p>
MENU/LIST	<p>The disc menu appears on the screen.</p>	<p><b>DVD</b></p>
SUBTITLE (  )	<p>During playback, press SUBTITLE (  ) then press ◀ / ▶ repeatedly to select a desired subtitle language.</p>	<p><b>DVD DivX</b></p>
AUDIO (  )	<p>Press AUDIO (  ) then press ◀ / ▶ repeatedly to hear a different audio language or audio track.</p>	<p><b>DVD DivX</b></p>
	<p>Press AUDIO (  ) then press ◀ / ▶ repeatedly during playback to hear a different audio channel (STEREO, LEFT or RIGHT).</p>	<p><b>VCD</b></p>

### If a menu screen is displayed **DVD VCD**

The menu screen may be displayed first after loading a DVD or Video CD which contains a menu.

#### **DVD**

Use the ◀ / ▶ / ▲ / ▼ buttons to select the title/chapter you want to view, then press ENTER to start playback.

Press TITLE or MENU/LIST to return to the menu screen.

#### **VCD**

- Use the number buttons to select the track you want to view.  
Press RETURN (↵) to return to the menu screen.
- Menu setting and the exact operating procedures for using the menu may differ depending on the disc. Follow the instructions on the each menu screen. You may also set PBC to [OFF] under Setup menu (see page 15).

### Moving to another TITLE **DVD DivX VCD**

When a disc has more than one title, you can move to another title as follows:

- Press DISPLAY during playback then use ▲ / ▼ to select the title icon. Then, press the appropriate numbered button (0-9) or ◀ / ▶ to select a title number.

#### **Note:**

On a Video CD with PBC, you must set PBC to OFF in the Setup menu. See page 15

### Time Search **DVD DivX VCD**

To start playing at any chosen time on the disc:

1. Press DISPLAY during playback. The time search box shows the elapsed playing time.
2. Press ▲ / ▼ to select the time icon and "--:--:--" appears.
3. Input the required start time in hours, minutes, and seconds from left to right.
4. Press ENTER to confirm. Playback starts from the selected time.

#### **Note:**

On a Video CD with PBC, you must set PBC to OFF in the Setup menu. See page 15

### Marker Search **DVD VCD DivX**

#### **To enter a Marker**

You can start playback from up to nine memorized points. To enter a marker, press MARKER at the desired point on the disc during playback. The Marker icon appears on the TV screen briefly. Repeat to enter up to nine markers.

### To Recall or Clear a Marked Scene

1. During disc playback, press SEARCH. The marker search menu appears on the screen.
2. Within 5 seconds, press ◀ / ▶ to select a marker number that you want to recall or clear.
3. Press ENTER and playback starts from the marked scene. Or, press CLEAR and the marker number is erased from the list.

### Camera Angle **DVD**

If the disc contains scenes recorded at different camera angles, you can change to a different camera angle during playback.

1. Press DISPLAY during playback.  
The On-Screen Display appears on the TV screen.
2. Use ▲ / ▼ to select the Angle icon in the On-Screen Display.
3. Use ◀ / ▶ to select a desired angle.  
The number of the current angle appears on the TV screen.

### Virtual Surround **DVD DivX**

This unit can produce a Virtual Surround effect, which simulates multi-channel audio playback from two conventional stereo speakers, instead of the five or more speakers normally required to listen to multi-channel audio from a home theater system.

1. Press DISPLAY during playback. The On-Screen Display appears on the TV screen.
2. Use ▲ / ▼ to select the Sound icon in the On-Screen Display.
3. Use ◀ / ▶ to select "VIRTUAL".  
To turn off the 3D Surround effect, select "Normal".

You can also set the Virtual Surround by pressing VSM repeatedly.

### Last Condition Memory **DVD VCD**

This unit memorizes the user settings for the last disc that you have viewed. Settings remain in memory even if you remove the disc from the unit. If you load a disc that had its settings memorized, the latest stop position is automatically recalled.

#### **Note:**

Settings are stored in memory for use any time.

## Playing a DivX Movie File

The unit can play Divx files. Before playing DivX files, read "DivX file requirement" on right.

1. Press HOME then select [MOVIE] option.
2. Select a media that contains DivX file(s) then press ENTER.  
The [Movie List] menu appears on the TV screen.



3. Press ▲ / ▼ to select a folder, and press ENTER. A list of files in the folder appears. If you are in a file list and want to return to the Folder list, use the ▲ / ▼ buttons on the remote to highlight [..] and press ENTER.
4. If you want to view a divx movie file, press ▲ / ▼ to highlight a file and press ► (PLAY). You can use variable playback functions. Refer to pages 18-20.
5. Press ■ (STOP) to stop the playback. The [Movie List] menu appears.

### Notice for displaying the DivX subtitle

If the subtitle does not display properly, please follow the steps below.

1. Press ■ when the subtitle appears.
2. Press and hold SUBTITLE about 5 seconds. The language code will appear.
3. Press SUBTITLE to select another language code until the subtitle is displayed properly.
4. Press ► (PLAY) to continue playback.

### Movie List menu options

1. Press ▲ / ▼ to select a folder/file on the [Movie List] menu then press ENTER. [Movie List] menu options appear. The menu options displayed differ depending on the selected media.
  - [Play] Start playback the selected title.
  - [Open] Opens the folder and a list of files in the folder appears.
2. Press ▲ / ▼ / ◀ / ▶ to select an option, and press ENTER.
  - [Delete] Deletes the file(s) or folder(s) from the media.
  - [Rename] Edits the file name. (page 28)
  - [Move] Moves the file(s) to another folder or media. (page 29)
  - [Copy] Copies the file(s) to another folder or media. (page 29)

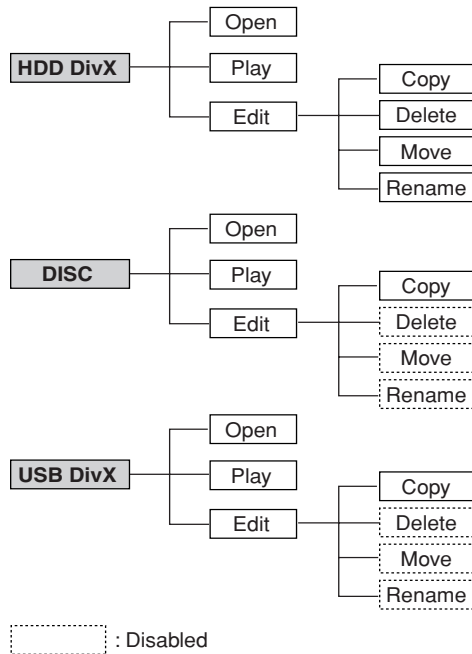

### DivX file requirement

**Available resolution size:** 720x576 (W x H) pixel

**DivX file extensions:** ".avi", ".divx"

**Playable DivX subtitle:** ".smi", ".srt", ".ssa", ".sub (Micro DVD format)", ".txt (Micro DVD format)"

**Playable Codec format:** "DIV3", "DIVX", "DX40", "DX50", "3ivx", "MP4V2", "MP4V3"

**Playable Audio format:** "AC3", "PCM", "MP3", "DTS"

- Sampling frequency: within 16 - 48 kHz (MP3)
- Bit rate: within 32 - 320kbps (MP3)

**CD-R Format:** ISO 9660 and JOLIET.

**DVD±R/RW Format:** ISO 9660 (UDF Bridge format)

**Maximum Files/Disc:** Less than 999 (total number of files and folders)

#### Notes on DivX format

- If the number of the screen frame is over 29.97 frames per second, this unit may not operate normally.
- If the video and audio structure of recorded file is not interleaved, returns to the menu screen.

## Playing an Audio CD or MP3/WMA file

- The unit can play audio CDs and MP3/WMA files. Before playing MP3/WMA files, read "MP3/WMA audio file requirement" on page 23.
- The Gracenote® music recognition service enables your unit to look up from its built-in database the CD track information (including album, artist, track information). It allows the ripped CD tracks to be properly categorized (for example, under Artist, Album or Song List) and also stored with the existing files in the hard disk.



Music recognition technology and related data are provided by Gracenote®.

Gracenote is the industry standard in music recognition technology and related content delivery. For more information, visit [www.gracenote.com](http://www.gracenote.com).

CD and music-related data from Gracenote, Inc., copyright © 2000-2006 Gracenote. Gracenote Software, copyright © 2000-2006 Gracenote. This product and service may practice one or more of the following U.S. Patents: #5,987,525; #6,061,680; #6,154,773, #6,161,132, #6,230,192, #6,230,207, #6,240,459, #6,330,593, and other patents issued or pending. Some services supplied under license from Open Globe, Inc. for U.S. Patent: #6,304,523.

Gracenote and CDDb are registered trademarks of Gracenote. The Gracenote logo and logotype, and the "Powered by Gracenote" logo are trademarks of Gracenote.

1. Press HOME.  
The HOME menu appears.
2. Select [MUSIC] option.
3. Select a media that contains MP3/WMA or audio title then press ENTER.  
The [Music List] menu appears on the TV screen.

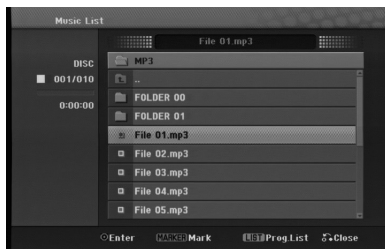

4. Use ▲/▼ to select a track then press ► (PLAY).  
Playback starts.  
You can use variable playback functions.  
Refer to pages 18-19.

### Tips:

- If you want to move to the upper directory, use the ▲ / ▼ to highlight and press ENTER.
- Press and hold ▲ to move to the previous page.  
Press and hold ▼ to move to the next page.

5. To stop playback at any time, press STOP.

## Audio CD and Music menu options

1. Press ▲ / ▼ to select a folder/file on the Audio CD or Music menu then press ENTER.  
The menu options appear.  
The menu options displayed differ depending on the selected media.
2. Press ▲ / ▼ / ◀ / ▶ to select an option, and press ENTER.
  - [Play] Start playback the selected title.
  - [Random] Start or cancel random playback.
  - [Open] Opens the folder and a list of files in the folder appears
  - [Delete] Deletes the file(s) from the media.
  - [Rename] Edits the file name. (page 28)
  - [Move] Moves the file(s) to another folder or media. (page 29)
  - [Copy] Copies the file(s) to another folder or media. (page 29)
  - [Prog. add] Adds the track(s) to Program list. (page 25)
  - [Ripping] Rips audio tracks from your Audio CDs and store them as MP3 files in the hard disk.
  - [Identify] Identify the audio CD tracks or music files.

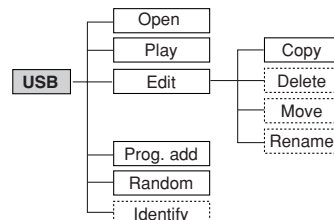
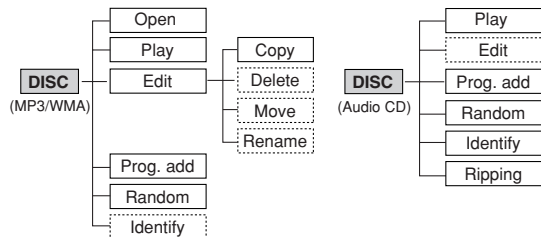
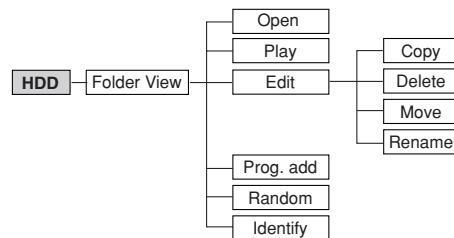

: Disabled

## Music List Folder (HDD)

- [Folder View] The identified and unidentified audio files in the hard disk are displayed in the folder list view.
- [Song List] The identified audio files in the hard disk are displayed in the file list view.
- [Artist] The identified audio files in the hard disk is displayed by the artist's name.
- [Album] The identified audio files in the hard disk is displayed by the album title.

## Random

1. Press ▲ / ▼ to select a file then press ENTER. The menu options appear.
2. Press ▲ / ▼ to select [Random] option then press ENTER. The unit automatically begins random playback and "RANDOM" appears on the menu screen.
3. To return to normal playback, select [Random] option again then press ENTER.

### Tip:

By pressing ►► during Random playback, the unit selects another track and resumes Random playback.

## Updating your Gracenote® music recognition service database (Monthly)

By updating your Gracenote® music recognition service database, you can ensure your unit has the latest disc information. To download the update files, visit <http://www.lgservice.com/> → SUPPORT → Software

1. Download the update files to your computer from the Web site.
  - Notes:**
    - The update file size will be about 8-10 MB.
    - The downloading time will vary, depends on your computer environment.
    - The update time takes about 8 hours.
2. Connect the USB storage device to your computer or load a blank disc on your computer's optical disc drive.
  - Note:**
    - If you use the USB storage device, format it after saving a backup for your data in the USB storage device.
3. Store the update file on the connected USB storage device or the loaded disc.
4. Connect the USB storage device to your unit or load disc on your unit's CD slot loader.
5. Press HOME and select [MUSIC] option.
6. Select [DISC] or [USB] option and press ENTER.
7. Select a update file and press ENTER. The menu option appears on the menu.

8. Select [Update] option then press ENTER.

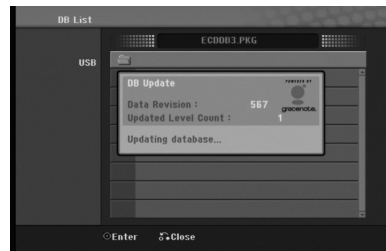

- Data Revision: Indicates the number of the updated data.
- Updated Level Count: Indicates the number of the previously updated \*.PKG file.

### Notes:

- After unexpected errors such as disconnection of the power plug by the end user, power failure, etc. occur during update, and then the unit powers on again, all of the updating files are deleted. On the other words, even the previously updated files are deleted. In this case, you need to update the files again.
- Do not press POWER (or ⏻) during update.
- Release the sleep mode before update.

## MP3/WMA audio file requirement

### File extensions

“.mp3”, “.wma”.

### Sampling frequency:

within 16 - 48 kHz (MP3), within 8 - 48kHz (WMA)

### Bit rate:

within 32 - 320kbps (MP3), 5 - 192kbps (WMA)

### CD-R Format:

ISO 9660 and JOLIET.

### DVD±R/RW Format:

ISO 9660 (UDF Bridge format)

### Maximum Files/Disc:

Less than 999 (total number of files and folders)

## Identifying the audio CD tracks or the stored music files in the hard disk

You can identify the audio CD tracks or music files from built-in database the CD track information.

### Note:

This unit enables you to identify the recorded files from radio, but the identifying will not work.

### Identifying the audio CD tracks

1. Insert a audio CD into disc loader.
2. Select any track to identify.

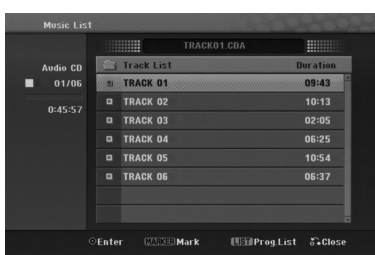

3. Press ENTER.  
The menu options appear on the menu.
4. Use ▲ / ▼ to select [Identify] option then press ENTER. The track name is changed to the correct song title.

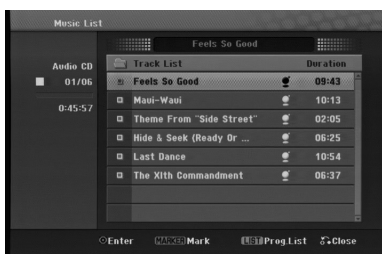

### Identifying the stored music files in the hard disk (MP3 only)

If you identify the stored music files, the identified files are properly categorized (for example under Artist, Album or Song List).

1. Press HOME and select [MUSIC] option.
2. Select [HDD] option and press ENTER.
3. Select [Folder View] and press ENTER.
4. In the screen of Folder View, select a music file you wish to identify.

#### Selecting multiple tracks

1. Press MARKER.  
A check mark appears on the track.  
Press MARKER again to cancel the marked track.

2. Repeat step 1 to mark additional track.

5. Press ENTER.  
The menu options appear on the menu.
6. Select [Identify] option then press ENTER.  
Make signature and search matched song.
7. The list of titles that are similar to your request appears.
8. In the list of titles, select the title that matches your music file with confirming that the Artist and Album information is correct.

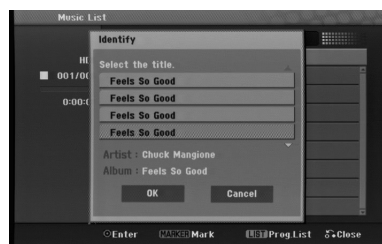

9. Press ENTER.  
[OK] is highlighted.  
You can select [OK] or [cancel] by pressing ◀ or ▶.
10. Press ENTER again.  
If you select [OK], the track name is changed to the selected song title. If you select the multiple files, repeat the identifying process.

### Note:

In most cases, this unit is able to identify the correct information from the built-in database the CD track information during the identifying process. However, this unit might not be able to identify complete or accurate information from the database.

This can happen for a number of reasons:

- The CD information is not in the database. (This happens most frequently with commercial CDs that are very new or relatively rare.
- The CD information is in the database, but the information in the database is inaccurate or incomplete.
- This unit cannot identify the WMA files.
- This unit cannot identify the stored MP3 files in the disc or in the USB device. To identify the stored MP3 files in the disc or in the USB device, copy them to the hard disk.

### Creating a Smart Playlist

You can create playlists of certain genre of music.

1. Press HOME and select [MUSIC] option.
2. Select [HDD] option and press ENTER.
3. Select [Song List], [Artist] or [Album].
4. In the screen of song list, Artist or Album select a file you wish to create a smart playlist.
5. Press SMART.MIX.

### MP3 audio file requirement (Identify)

#### Sampling frequency:

within 32 - 48 kHz

#### Bit rate:

within 32 - 320kbps



## Program Playback with Audio CD and MP3/WMA file

Program Playback enables you to make custom playlists of Audio CD or MP3/WMA tracks. Programs can contain up to 99 Audio CD tracks or 256 MP3/WMA files.

1. Use ▲ / ▼ to select a track/file (or folder) on the Audio CD or Music menu.

### Selecting multiple files/tracks (folders)

1. Press **MARKER**.  
A check mark appears on the file/track or folder. Press **MARKER** again to cancel the marked file/track or folder.
2. Repeat step 1 to mark additional file/track (folders).

2. Press **ENTER**.  
The options appear on the left side of the menu.
3. Use ▲ / ▼ to select the [Prog. add] option then press **ENTER**.
4. Repeat steps 1-3 to mark additional tracks.

### Note:

If you select a folder for Programmed Playback, all tracks/files in the folder are added to the Program List.

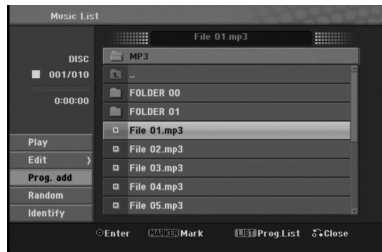

5. Use ► to move to the Program list.  
The programmed track you selected last is highlighted on the Program list.
6. Use ▲ / ▼ to select the track you want to start playing.
7. Press ► (PLAY) to start.  
Playback stops after playing the last programmed track in the Program list.
8. To exit Program Playback and resume normal playback, select a track on the original list by pressing ◀ and ▲ / ▼ and press ► (PLAY).

### Tips:

- You can access or remove the Program list screen by pressing **MENU/LIST**.
- You can not remove the Program list screen during the programmed playback and the programmed **■■■**.

## Program list menu options

1. Press ▲ / ▼ to select a track/file on the Program list then press **ENTER**.  
The menu options appear.



2. Use ▲ / ▼ to select an option then press **ENTER** to confirm your selection.
  - [Play] Playback begins in the order in which you programmed the tracks from the selected track.
  - [Random] Start or cancel random playback.
  - [Delete] Deletes the track(s) from the Program list menu.

## Repeat Programmed Tracks

Press **REPEAT** to select the desired Repeat mode.

- [TRACK] Repeats the current track.
- [ALL] Repeats all tracks on the Program List.
- [OFF] Cancels Repeat mode (no display).

## Erasing a Track from the Program list

1. Select the track you wish to erase from the Program list. Use **MARKER** button to select multiple tracks.
2. Press **ENTER**. The menu options appears
3. Select [Delete] option then press **ENTER**.

## Viewing a JPEG File

This unit can play JPEG files. Before playing JPEG recordings, read "Photo file requirement" on page 27

1. Press HOME.  
The HOME menu appears.
2. Select [PHOTO] option.
3. Select a media that contains JPEG file then press ENTER.  
The [Photo List] menu appears on the TV screen.



4. Use ▲ / ▼ to select a file, then press ENTER.  
The menu options appear on the left side of the menu.

### Tips:

- If you want to move to the upper directory, use the ▲ / ▼ to highlight and press ENTER.
- You can also display HOME menu to select another media by pressing HOME.

5. Use ▲ / ▼ to select [Full Screen] then press ENTER.  
The selected image is displayed in full screen.  
Depending upon the size and number of JPEG files, it could take a long time for the unit to read the files.

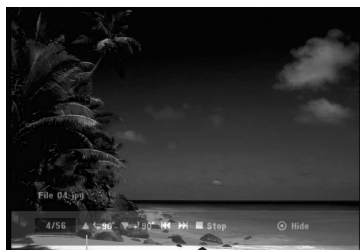

Press ENTER to appear or disappear this menu during viewing the full screen.

6. To stop viewing at any time, press STOP.  
The [Photo List] menu appears.

## Photo List menu options

1. Press ▲ / ▼ to select a file on the [Photo List] menu then press ENTER.  
The menu options appear.  
The menu options displayed differ depending on the selected media.

### Selecting multiple files (folders)

1. Press MARKER.  
A check mark appears on the file or folder.  
Press MARKER again to cancel the marked file or folder.
  2. Repeat step 1 to mark additional file (folders).
2. Use ▲ / ▼ to select an option then press ENTER to confirm your selection.
    - [Open] Opens the folder and a list of files in the folder appears
    - [Full Screen] Shows the selected file as full screen.
    - [Delete] Deletes the selected file from the media.
    - [Slide Show] Displays Slide Show menu.
    - [Rename] Edits the file name. (page 28)
    - [Move] Moves the file(s) to another folder (album) or media. (page 29)
    - [Copy] Copies the file(s) to another folder or media. (page 29)

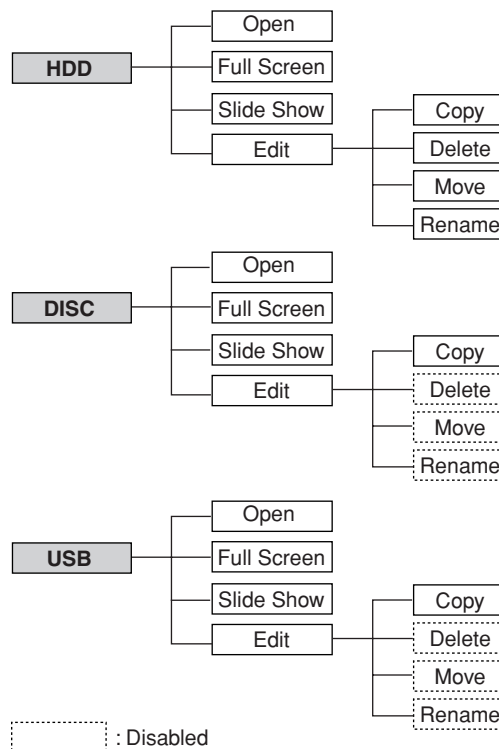

**Tip:**

You can create new folder in the HDD.  
Select [Edit-Copy-New Album] option then press ENTER. "NONAME###" folder is created.

**Photo file requirement****File extensions**

".jpg"

**Photo size:**

Less than 4MB recommended

**CD-R Format:**

ISO 9660 and JOLIET.

**DVD±R/RW Format:**

ISO 9660 (UDF Bridge format)

**Maximum Files/Disc:**

Less than 999 (total number of files and folders)

**Notes on JPEG file**

Progressive and lossless compression JPEG image files are not supported.

**Skip Images**

While viewing a picture, press **◀◀** or **▶▶** once to return to the previous file or advance to the next file.

**Rotate Images**

Use **▲** / **▼** while viewing a picture to flip the picture counterclockwise or clockwise.

**View Slide Shows**

Slide show will automatically go to next picture at a specified interval.

1. Select [Slide Show] option on the [Photo List] menu.
2. Press ENTER.  
The Slide Show menu appears.

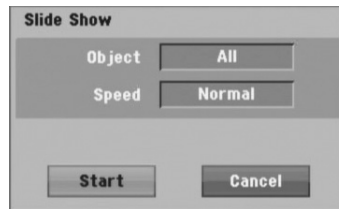

3. Use **◀** / **▶** / **▲** / **▼** to set the options.  
[Object] option:
  - [Selected] Views slide show only selected files with MARKER button. Use the MARKER button to select multiple files.
  - [All] Views slide show all files.
 [Speed] option:  
Sets the Slide Show speed to [Slow], [Normal], or [Fast].
4. Select the [Start] option then press ENTER to start the Slide Show.
5. Press STOP to stop the Slide Show and returns to the [Photo List] menu.

**To Pause the Slide Show**

1. Press **⏸** to pause slide show.
2. When you want to continue slide show, press **⏸** or **▶** (PLAY).

## Editing a MP3/WMA, JPEG, DivX file

These descriptions are MP3 file's operation for example, other kind's files are operated same way.

### Note:

- The MP3/WMA, JPEG, and DivX files on the disc or HDD cannot be copied or moved to USB device.

## Erasing a file(s)/folder(s) from the HDD

You can erase MP3/WMA, JPEG or DivX file(s)/ folder(s) on the HDD.

1. Select a file you wish to erase on the menu.

### Selecting multiple files (folders)

1. Press **MARKER**.  
A check mark appears on the file or folder.  
Press **MARKER** again to cancel the marked file or folder.
2. Repeat step 1 to mark additional file (folders).

2. Press **ENTER**.

The menu options appear on the menu.



3. Select [**Delete**] option then press **ENTER**.  
The selected file(s) is deleted.

## Naming a file on the HDD

You can name the files on the HDD independently.

1. Select a file you wish to rename on the menu.
2. Press **ENTER**.  
The menu options appear on the menu.
3. Select [**Edit**] option then press **ENTER**.  
Edit options appears.



4. Select [**Rename**] option then press **ENTER**.  
Keyboard menu appears.

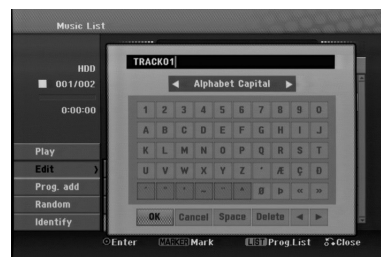

5. Enter a name for the title. Use **◀ / ▶ / ▲ / ▼** to select a character then press **ENTER** to confirm your selection.
  - **OK**: Select to finish.
  - **Cancel**: Cancels all entered characters.  
A file name remains unchanged.
  - **Space**: Inserts a space at the cursor position.
  - **Delete**: Deletes the previous character at the cursor position.
  - **◀ / ▶**: Moves cursor to left or right.
6. Choose **OK** then press **ENTER** to fix the name and return to the previous menu screen.
7. Press **RETURN** (↵) repeatedly to exit the menu.

## Copying a file(s) to another media or folder

You can copy a file(s)/folder(s) to HDD or folder.

1. Select a file you wish to copy on the menu.

### Selecting multiple files (folders)

1. Press **MARKER**.  
A check mark appears on the file or folder.  
Press **MARKER** again to cancel the marked file or folder.
2. Repeat step 1 to mark additional file (folders).

2. Press **ENTER**.  
The menu options appear on the menu.
3. Select **[Edit]** option then press **ENTER**.  
Edit options appears.
4. Select **[Copy]** option then press **ENTER**.  
Copy menu appears.



5. You can select a album (folder) to copy.  
Select a album (folder).  
Also, you can create new album (folder). Select **[New Album]** option on the Copy menu then press **ENTER**.  
"NONAME###" folder is created.
6. Select **[Copy]** option then press **ENTER** to begin copying.

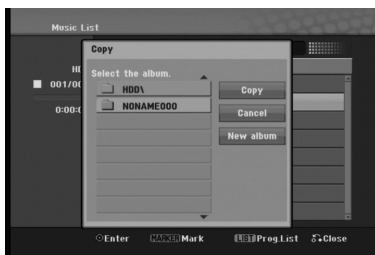

### Note:

If a folder's depth is more than 5 level, the copy is not available.

## Moving a file(s)

You can move a file(s)/folder(s) to HDD or folder. After moving, the file(s)/folder(s) are deleted from the current location.

1. Follow steps 1-3 as shown left.
2. Press **ENTER**.  
The options appear on the left side of the menu.
3. Select **[Move]** option then press **ENTER**.  
Move menu will appear.



4. You can select a album (folder) to move.  
Select a album (folder).  
Also, you can create new album (folder). Select **[New Album]** option on the Move menu then press **ENTER**.  
"NONAME###" folder is created.
5. Select **[Move]** option then press **ENTER** to begin moving.



## AUX/MOBILE/SCART/OPTICAL (Listening to an external source)

You can listen to the sound of the connected external device through your unit.

1. Check the external device has been properly connected. (See **Connecting an additional appliance** on page 12.)
2. Press MOBILE on the remote control to select MOBILE mode. (If you are in any menu mode, remove it completely by pressing RETURN or HOME repeatedly.)  

or

Press HOME and ◀ or ▶ to select Easy Menu, and then select AUX, SCART or OPTICAL.
3. To avoid noise distortion, turn down the volume on your external device.
4. Press PLAY on the connected device to start playback.
5. To adjust the sound and volume, use the sound controls on your external device and this unit.

### **Note:**

In MOBILE mode, ▶ (PLAY), ■■, ◀◀ and ▶▶ buttons operate only on the connected Apple iPod through an Apple iPod universal dock with a built-in infrared (IR) receiver. To release the MOBILE mode, press mode button (TUNER, HDD, DISC, USB) you want, or press HOME.

## Using Apple iPod

You can perform the basic operations of your iPod using the supplied remote control with this unit.

### **Notes:**

- You need an Apple iPod universal dock with a built-in infrared (IR) receiver and an audio cable with a 3.5 millimeter stereo miniplug.
  - It works with all iPod models that have a dock connector.
  - Depending on the type of iPod, you may need to insert one of the dock adapters into the dock slot before you station your iPod.
  - Adjust the volume to a moderate level before you connect your iPod and this unit.
1. Station your iPod in the dock.
  2. Connect one end of an audio cable with a 3.5 millimeter stereo miniplug into the **MOBILE** jack on the rear of the active subwoofer.
  3. Connect the other end of an audio cable with a 3.5 millimeter stereo miniplug into the dock line out jack.
  4. Press MOBILE on the remote control to select MOBILE mode.
  5. Point the supplied remote control with this unit at the front of the dock.
  6. Press ▶ (PLAY), ■■, ◀◀ or ▶▶ on the supplied remote control with this unit to turn iPod on.
  7. You can control play (▶), pause (■■) and skip (◀◀/▶▶).  
You can turn iPod off by pressing and holding ▶ (PLAY) or ■■ on the supplied remote control with this unit.

# Recording

By ripping CDs and recording from radio you can build your music library on hard disk.

## Ripping CDs (for audio CDs)

After you identify a audio CD, if you rip the audio CD, the ripped CD tracks are properly categorized (for example, under Artist, Album or Song List) and also stored with the existing files in the hard disk.

1. Insert a CD into disc loader, CD graphic printed side facing you.
2. Press HOME and select [MUSIC] option.
3. Select [DISC] option and press ENTER.
4. In the screen of track list, select a track you wish to rip.

### Selecting multiple tracks

1. Press **MARKER**.  
A check mark appears on the track.  
Press **MARKER** again to cancel the marked track.

2. Repeat step 1 to mark additional track.

5. Press ENTER.  
The menu options appear on the menu.
6. Select [Ripping] option then press ENTER.  
Ripping options appears.
7. You can select a album (folder) to copy.  
Select a album (folder).  
Also, you can create new album (folder). Select [New Album] option on the ripping menu press ENTER.  
"NONAME###" folder is created.
8. Select [Ripping] option then press ENTER to begin ripping.



### Notes:

- If you a folder's depth is more 5 level, the copy is not available.
- It takes some time to convert the ripped tracks into MP3 files.
- If you rip and then play back the disc encoded with DTS, there will be only the noise of an unprocessed DTS signal.

## To find your ripped tracks

You can find and playback the ripped tracks in hard disk.

1. Press HOME and select [MUSIC] option.
2. Select [HDD] option and press ENTER.
3. If unidentified, you can find them only in [Folder View].

## Recording from radio

- A maximum of 5-hour recording can be made from the radio.
  - The minimum required time is 3 seconds.
1. In radio mode, tune to the desired radio station.
  2. Press **●** (or REC on the front of unit). Recording starts.
  3. To stop recording, press **■** (or STOP on the front of unit). The recording is saved as a MP3 file under **AUDIO RECORDING** folder in **MUSIC\_HDD Folder View**. A file name is given, e.g. RECORDINGxxx.mp3 (where xxx denotes a number)

### Notes:

- This unit enables you to identify the recorded files from radio, but the identifying will not work.
- When you insert a disc into disc loader during recording from radio, the recording stops.
- Do not press EJECT during recording from radio.

## Timeshift **HDD**

Do not miss a part from a live broadcast.

If the telephone rings while you are listening to your favorite live broadcast, just press **TIMESHIFT** and **||** before answering the phone.

When the timeshift function is activated, the sound will be muted and the broadcast is then recorded for later listening to.

After the phone call or listening to interruption, press **▶** (PLAY) or **◀/▶** listen to the program. Press **■** (STOP) to return to the live broadcast. If you stop the timeshift, the recording is deleted.

## Timeshift (Pause, Live Radio/Playback) Operation **HDD**

You can store a program in the HDD storage cache temporarily.

### Press **TIMESHIFT** while listening to a radio program.

The Progress Bar display appears on the screen as shown below. The Progress Bar changes to timeshift icon after 10 seconds.

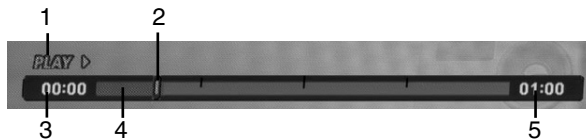

1. Indicates playback mode.
2. Indicates current Timeshift position.
3. Indicates Timeshift start time.
4. Indicates Timeshift elapsed time.
5. Indicates the time that is one hour from Timeshift start time.

### **Tip:**

You can use trick play functions (Scan, etc.) during timeshift. Refer to Playback Operation on pages 18-20.

### **Notes:**

- After 3 hours, the Timeshift will stop automatically.
- When you insert a disc into disc loader during the timeshift, the timeshift stops.
- Do not press **EJECT** during the timeshift.

## Jump to Start or End during Timeshift

1. Press **ENTER** during timeshift. The menu will appear.
2. Press **◀** and playback starts from the very beginning of the timeshift. Press **▶** and jumps to the very end of the timeshift then goes to pause mode.

## To Exit the Timeshift

1. Press **STOP** to exit Timeshift function. Confirm message will appear.
2. Use **◀ / ▶** to select [Yes] then press **ENTER**.



# Reference

## Additional Information

### Presetting the Radio Stations

You can preset 50 stations for FM and AM (MW). Before tuning, make sure that you have turned down the volume.

1. Press TUNER on the remote control. (If you are in any menu mode, remove it completely by pressing RETURN or HOME repeatedly.)  
or  
On the home menu screen, select RADIO and then press ENTER.
2. And then every time you press TUNER, FM and AM (MW) changes alternately.
3. Press and hold TUN.- or TUN.+ on the remote control for about three seconds until the frequency indication starts to change, then release. Scanning stops when the unit tunes in a station.
4. Press PROG./CLEAR on the remote control. A preset number will flash in the display window.
5. Press PRESET + or PRESET - on the remote control to select the preset number you want.
6. Press PROG./CLEAR on the remote control. The station is stored.
7. Repeat steps 3 to 6 to store other stations.

### To tune in a station with a weak signal

Press TUN.- or TUN.+ repeatedly in step 3 to tune in the station manually.

### To clear all the stored stations

Press and hold PROG./CLEAR for about five seconds and "ERASE ALL" is appeared in the display window and then press PROG./CLEAR again, the stations are cleared.

- If you have accidentally entered into the "ERASE ALL" mode and you do not wish to clear the memory, do not press any key. After a few seconds "ERASE ALL" will go off by itself and change to normal mode.

### Note:

If all stations have already been entered, the PRESET FULL message will appear in the display window for a moment and then a preset number will flash. To change the preset number, follow the steps 5-6 as above.

## Listening to the Radio

Preset radio stations in the unit's memory first (see "Presetting the radio stations" on the left).

1. Press TUNER until AM (MW) or FM appears in the display window.  
The last received station is tuned in.
2. Press PRESET + or PRESET - repeatedly on the remote control to select the preset station you want.  
Each time you press this button, the unit tunes in one preset station at a time.
3. Adjust the volume by pressing VOL + or VOL- on the remote control repeatedly.

### To turn off the radio

Press POWER to turn the unit off or select another function mode (HDD, MOBILE, DISC, USB).

### To listen to non-preset radio stations

- Use manual or automatic tuning.
- For manual tuning, press TUN.- or TUN.+ on the remote control repeatedly.
- For automatic tuning, press and hold TUN.- or TUN.+ on the remote control for about three seconds on the remote control.

### To select a preset radio station directly

You can use the number buttons on the remote control to select a preset radio station directly. For example, to listen to the preset station 4, press 4 on the remote control. To listen to the preset station 19, press 1 and then 9 (within 3 seconds).

### For your reference

- **If an FM program is noisy**  
Press AUDIO repeatedly on the remote control so that "STEREO" changes to MONO in the display window. There will be no stereo effect, but the reception will improve. Press this button repeatedly again to change "MONO" to "STEREO".
- **To improve reception**  
Reorient the supplied antennas.

## RDS Operation

This unit is equipped with RDS (Radio Data System), which brings a wide range of information to FM radio. Now in use in many countries, RDS is a system for transmitting station call signs or network information, a description of station programme type text message about the station or specifics of musical selection and the correct time.

## RDS Tuning

When a FM station is tuned in and it contains RDS data, the unit will automatically display the station's call sign as well as indicators for the RDS services programme (PS), programme type recognition (PTY), Radiotext (RT) and Clock Time (CT) if transmitted by the station.

## RDS Display Options

The RDS system is capable of transmitting a wide variety of information in addition to the initial call sign that appears when a station is first tuned. In normal RDS operation the display will indicate the station name, broadcast network or call letters.

Pressing **RDS/RESOL.** and **▲** or **▼** enables you to cycle through the various data types:

- **PTY (Programme type recognition)**- The name of the programme type is shown in the Display Window.
- **RT (Radiotext)**- A "text" message contains special information from the broadcast station. Note that this message may scroll across the display to permit message.
- **CT (Time controlled by the channel)**- Enables the unit to receive the actual time and show it in the Display Window.
- **PS (Programme Service name)**- The name of the channel is shown in the Display Window.

### Note:

Some RDS stations may not choose to include some of these additional features. If the data required for the selected mode is not being transmitted, the Display Window will show a **PTY NONE, RT NONE, CT NONE, PS NONE** message.

## Programme Search (PTY)

A major benefit of RDS is its ability to encode broadcasts with Programme Type (PTY) codes that indicate the type of material being broadcast. The following list shows the abbreviations used to indicate each PTY along with an explanation of the PTY.

News	News
Affairs	Current Affairs
Info	Information
Sport	Sports
Educate	Educational
Drama	Drama
Culture	Culture
Science	Science
Varied	Varied Speech Programme
Pop M	Popular Music
Rock M	Rock Music
Easy M	Easy Listening Music
Light M	Classical Music
Classics	Serious Classical Music
Other M	Other Music
Weather	Weather Information
Finance	Financial Programmes
Children	Children's Programmes
Social	Social Affairs Programmes
Religion	Religious Broadcasts
Phone In	Phone-In Programmes
Travel	Travel and Touring
Leisure	Leisure and Hobby
Jazz	Jazz Music
Country	Country Music
Nation M	National Music
Oldies	Oldies Music
Folk M	Folk Music
Document	Documentary Programmes
TEST	Station Alarm Test Message
Alarm !	Emergency Broadcast Information

You may search for a specific Programme Type (PTY) by following these steps:

1. Press TUNER to select FM mode.
2. Press PTY on the remote control, the display will show the last PTY in use.
3. Press **▲** or **▼** to select a desired PTY.
4. When the desired the PTY is selected, press **◀** or **▶**.  
The unit will go into an automatic search mode. When a station is tuned, the search will stop.

## Sleep

You can set a certain period of time after which the unit will switch to standby.

1. On the remote control, press SLEEP repeatedly to select the desired time period options (in minutes):
  - Display shows the selected option briefly and returns to its previous status.
2. To view the time countdown to the standby mode, press SLEEP again.  
To deactivate the sleep timer, press SLEEP until previous status is displayed.

or

Press POWER to switch the unit to standby (or  on the front of the unit).

## Dimmer

This function will change the brightness of the display window on the top panel during in power-on status. Press DIMMER repeatedly.

## XTS pro

Each time you press **XTS pro** the setting changes in the following order.

NORMAL ↔ XTS-P ON

- **XTS-P ON**  
The unique sound quality of the LG Technology creates the optimum sound for you to play the perfect playback of the original sound and to feel the living sound source.
- **NORMAL**  
XTS-P mode tune off

## Virtual sound

Press **VSM** to set the virtual sound.

Source	Display	Effect
2.1 ch.	VIRTUAL ON	3D STEREO
5.1 ch	VIRTUAL ON	Virtual sound

- **3D STEREO**  
Realtime 3D positioned sound rendering technology with stereo sources, optimized for stereo speakers. Listeners may experience amazing virtual surround effects with their own multimedia players.
- **Virtual sound**  
A pending downmix technology converts 5.1 channel to 2 channel sound having directional information of audio. And it makes a 2 channel or 2.1 channel feel 5.1 channel sound.

## Controlling Your TV with the Supplied Remote Control

You can control the sound level, input source, and power switch of your LG/GoldStar TV with the supplied remote.

1. While holding down TV POWER button, press CHANNEL + or -.
2. Release TV POWER button.

You can control your TV using the buttons below.

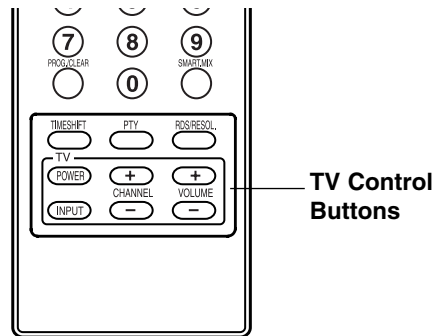

By pressing	You can
POWER	Turn the TV on or off.
INPUT	Switch the TV's input source between the TV and other input sources.
CHANNEL +/-	Scans up or down through memorized channels.
VOLUME +/-	Adjust the volume of the TV.

### Note:

When you replace the batteries of the remote, you may have reset the remote control.

## Language Codes

Use this list to input your desired language for the following initial settings:  
Disc Audio, Disc Subtitle, Disc Menu.

Language	Code	Language	Code	Language	Code	Language	Code
Abkhazian	6566	Fiji	7074	Lingala	7678	Singhalese	8373
Afar	6565	Finnish	7073	Lithuanian	7684	Slovak	8375
Afrikaans	6570	French	7082	Macedonian	7775	Slovenian	8376
Albanian	8381	Frisian	7089	Malagasy	7771	Somali	8379
Ameharic	6577	Galician	7176	Malay	7783	Spanish	6983
Arabic	6582	Georgian	7565	Malayalam	7776	Sudanese	8385
Armenian	7289	German	6869	Maltese	7784	Swahili	8387
Assamese	6583	Greek	6976	Maori	7773	Swedish	8386
Aymara	6588	Greenlandic	7576	Marathi	7782	Tagalog	8476
Azerbaijani	6590	Guarani	7178	Moldavian	7779	Tajik	8471
Bashkir	6665	Gujarati	7185	Mongolian	7778	Tamil	8465
Basque	6985	Hausa	7265	Nauru	7865	Tatar	8484
Bengali; Bangla	6678	Hebrew	7387	Nepali	7869	Telugu	8469
Bhutani	6890	Hindi	7273	Norwegian	7879	Thai	8472
Bihari	6672	Hungarian	7285	Oriya	7982	Tibetan	6679
Breton	6682	Icelandic	7383	Panjabi	8065	Tigrinya	8473
Bulgarian	6671	Indonesian	7378	Pashto, Pushto	8083	Tonga	8479
Burmese	7789	Interlingua	7365	Persian	7065	Turkish	8482
Byelorussian	6669	Irish	7165	Polish	8076	Turkmen	8475
Cambodian	7577	Italian	7384	Portuguese	8084	Twi	8487
Catalan	6765	Japanese	7465	Quechua	8185	Ukrainian	8575
Chinese	9072	Javanese	7487	Rhaeto-Romance	8277	Urdu	8582
Corsican	6779	Kannada	7578	Rumanian	8279	Uzbek	8590
Croatian	7282	Kashmiri	7583	Russian	8285	Vietnamese	8673
Czech	6783	Kazakh	7575	Samoaan	8377	Volapük	8679
Danish	6865	Kirghiz	7589	Sanskrit	8365	Welsh	6789
Dutch	7876	Korean	7579	Scots Gaelic	7168	Wolof	8779
English	6978	Kurdish	7585	Serbian	8382	Xhosa	8872
Esperanto	6979	Laothian	7679	Serbo-Croatian	8372	Yiddish	7473
Estonian	6984	Latin	7665	Shona	8378	Yoruba	8979
Faroese	7079	Latvian, Lettish	7686	Sindhi	8368	Zulu	9085

## Area Codes

Choose an area code from this list.

Area	Code	Area	Code	Area	Code	Area	Code
Afghanistan	AF	Ethiopia	ET	Malaysia	MY	Saudi Arabia	SA
Argentina	AR	Fiji	FJ	Maldives	MV	Senegal	SN
Australia	AU	Finland	FI	Mexico	MX	Singapore	SG
Austria	AT	France	FR	Monaco	MC	Slovak Republic	SK
Belgium	BE	Germany	DE	Mongolia	MN	Slovenia	SI
Bhutan	BT	Great Britain	GB	Morocco	MA	South Africa	ZA
Bolivia	BO	Greece	GR	Nepal	NP	South Korea	KR
Brazil	BR	Greenland	GL	Netherlands	NL	Spain	ES
Cambodia	KH	Heard and McDonald Islands	HM	Netherlands Antilles	AN	Sri Lanka	LK
Canada	CA	Hungary	HU	New Zealand	NZ	Sweden	SE
Chile	CL	India	IN	Nigeria	NG	Switzerland	CH
China	CN	Indonesia	ID	Norway	NO	Thailand	TH
Colombia	CO	Israel	IL	Oman	OM	Turkey	TR
Congo	CG	Italy	IT	Pakistan	PK	Uganda	UG
Costa Rica	CR	Jamaica	JM	Panama	PA	Ukraine	UA
Croatia	HR	Japan	JP	Paraguay	PY	United States	US
Czech Republic	CZ	Kenya	KE	Philippines	PH	Uruguay	UY
Denmark	DK	Kuwait	KW	Poland	PL	Uzbekistan	UZ
Ecuador	EC	Libya	LY	Portugal	PT	Vietnam	VN
Egypt	EG	Luxembourg	LU	Romania	RO	Zimbabwe	ZW
El Salvador	SV			Russian Federation	RU		

## Troubleshooting

Check the following guide for the possible cause of a problem before contacting service.

Symptom	Cause	Solution
No power.	<ul style="list-style-type: none"> <li>The power cord is disconnected.</li> </ul>	<ul style="list-style-type: none"> <li>Plug the power cord into the wall outlet securely.</li> </ul>
No picture.	<ul style="list-style-type: none"> <li>The TV is not set to receive unit signal output.</li> </ul>	<ul style="list-style-type: none"> <li>Select the appropriate video input mode on the TV so the picture from the unit appears on the TV screen.</li> </ul>
	<ul style="list-style-type: none"> <li>The video cable is not connected securely.</li> </ul>	<ul style="list-style-type: none"> <li>Connect the video cable securely.</li> </ul>
	<ul style="list-style-type: none"> <li>The connected TV power is turned off.</li> </ul>	<ul style="list-style-type: none"> <li>Turn on the TV.</li> </ul>
Sound cannot be heard or is of poor quality.	<ul style="list-style-type: none"> <li>The volume is minimized.</li> </ul>	<ul style="list-style-type: none"> <li>Adjust the volume.</li> </ul>
	<ul style="list-style-type: none"> <li>The headphones are connected.</li> </ul>	<ul style="list-style-type: none"> <li>Disconnect the headphones.</li> </ul>
	<ul style="list-style-type: none"> <li>The MUTE button is switched on.</li> </ul>	<ul style="list-style-type: none"> <li>Switch off MUTE.</li> </ul>
The playback picture is poor.	<ul style="list-style-type: none"> <li>The disc is dirty.</li> </ul>	<ul style="list-style-type: none"> <li>Clean the disc.</li> </ul>
The unit does not start playback.	<ul style="list-style-type: none"> <li>An unplayable disc is inserted.</li> </ul>	<ul style="list-style-type: none"> <li>Insert a playable disc. (Check the disc type, color system, and regional code.)</li> </ul>
	<ul style="list-style-type: none"> <li>The disc is placed upside down.</li> </ul>	<ul style="list-style-type: none"> <li>Place the disc with the playback side down.</li> </ul>
	<ul style="list-style-type: none"> <li>The disc is dirty.</li> </ul>	<ul style="list-style-type: none"> <li>Clean the disc.</li> </ul>
	<ul style="list-style-type: none"> <li>The Rating level is set.</li> </ul>	<ul style="list-style-type: none"> <li>Cancel the Rating function or change the rating level.</li> </ul>
Radio reception is poor	<ul style="list-style-type: none"> <li>The signal is too weak.</li> </ul>	<ul style="list-style-type: none"> <li>Adjust the antenna or connect an external antenna for better reception.</li> </ul>
The remote control does not work properly.	<ul style="list-style-type: none"> <li>The remote control is not pointed at the remote sensor of the unit.</li> </ul>	<ul style="list-style-type: none"> <li>Point the remote control at the remote sensor of the unit.</li> </ul>
	<ul style="list-style-type: none"> <li>The remote control is too far from the unit.</li> </ul>	<ul style="list-style-type: none"> <li>Operate the remote control within 7 m.</li> </ul>
	<ul style="list-style-type: none"> <li>There is an obstacle in the path of the remote control and the unit.</li> </ul>	<ul style="list-style-type: none"> <li>Remove the obstacle.</li> </ul>
	<ul style="list-style-type: none"> <li>The batteries in the remote control are exhausted.</li> </ul>	<ul style="list-style-type: none"> <li>Replace the batteries with new ones.</li> </ul>
The display window is dim, and the light on the touch pad and the active subwoofer are turned off.	<ul style="list-style-type: none"> <li>The dimmer function is activated.</li> </ul>	<ul style="list-style-type: none"> <li>Switch off DIMMER.</li> </ul>
▶ (PLAY),    , ◀◀ and ▶▶ buttons do not operate.	<ul style="list-style-type: none"> <li>This unit is in MOBILE mode.</li> </ul>	<ul style="list-style-type: none"> <li>To release the MOBILE mode, press mode button (TUNER, HDD, DISC, USB) you want, or press HOME.</li> </ul>

### Resetting the unit

If you observe any of the following symptoms...

- The unit is plugged in, but the power will not turn on or off.
- The unit is not operating normally.

...you can reset the unit as follows:

- Press and hold the POWER button for at least five seconds. This will force the unit to power off then turn the unit back on.
- Unplug the power cord, wait at least five seconds, and then plug it in again.

## Specifications

### General

Dimensions (approx.)	326 X 215 X 78 mm (w x h x d) without foot
Net weight (approx.)	3.1kg
Operating temperature	5°C to 35°C
Operating humidity	5 % to 90 %

### Audio recording format

Sampling frequency	44.1kHz
Compression format	MP3
Sampling bitrate	128Kbps

### Recording

Recordable media	HDD (80GB)
------------------	------------

### Playback

Frequency response	DVD (PCM 48 kHz): 20 Hz to 20 kHz, CD: 20 Hz to 20 kHz DVD (PCM 96 kHz): 20 Hz to 44 kHz
Signal-to-noise ratio	More than 85 dB (SPEAKER OUT)
Harmonic distortion	Less than 0.007% (SPEAKER OUT)
Dynamic range	More than 85 dB (SPEAKER OUT)

### Inputs

Audio input (optical audio)	3 V (p-p), 75 Ω, Optical connector x 1
VIDEO IN	1.0 Vp-p 75 ohms, sync negative, SCART x 1
AUDIO IN	0 dBm more than 47 kohms, RCA jack (L, R) x 1 / SCART x 1

### Outputs

VIDEO OUT	1 Vp-p 75 Ω, sync negative, RCA jack x 1 / SCART x 1
COMPONENT VIDEO OUT	(Y) 1.0 V (p-p), 75 Ω, negative sync, RCA jack x 1 (Pb)/(Pr) 0.7 V (p-p), 75 Ω, RCA jack x 2
HDMI video/audio output	19 pin (HDMI standard, Type A)

### Amplifier

Output power	Front: 75W + 75W (4Ω at 1 kHz, THD 10 %) Subwoofer: 150W (3Ω at 60 Hz, THD 10 %)
--------------	---

### Tuner Specifications

Tuning Range (FM)	87.5 - 108 MHz
Intermediate Frequency (FM)	10.7 MHz
Signal-to-noise ratio	60 dB (Mono)
Tuning Range (AM)	522 - 1,620 kHz
Intermediate Frequency (AM)	450 kHz
Antenna	Wire antenna (FM) Loop antenna (AM)

### Speakers

#### Front (J10HD-SF)

Type:	2 Way 3 Speaker
Impedance:	4 Ω
Frequency Response:	100 - 20,000 Hz
Sound Pressure Level:	82 dB/W (1m)
Max. Input Power:	150W
Net Dimensions (WxHxD):	104 x 328 x 216 mm
Net Weight:	2.9 kg

#### Active Subwoofer (J10HD-SA)

Power requirements:	AC 200-240V, 50/60 Hz
Power consumption:	75W
Type:	1 Way 1 Speaker
Impedance:	3 Ω
Frequency Response:	65 - 1,500 Hz
Sound Pressure Level:	80 dB/W (1m)
Max. Input Power:	300W
Net Dimensions (WxHxD):	216x 328 x 317 mm
Net Weight:	8.3 kg

- Designs and specifications are subject to change without notice for improvement.



P/NO : MFL30582477