

WASHING MACHINE OWNER'S MANUAL

MODEL : WP-750(N,R)(P)/WP-800(N,R)(P)
WP-791(N,R)(P)

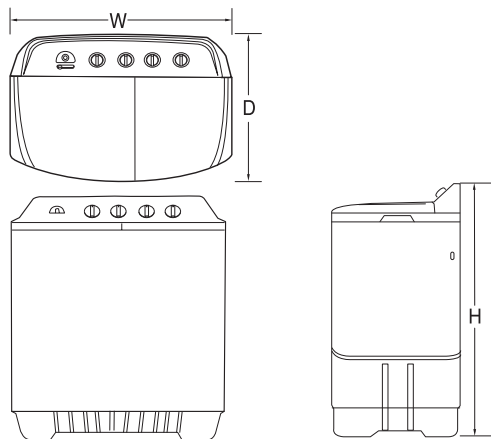

Power source	ON SPECIFICATION LABEL	
Water Level	H : 50 Litres	
Water Pressure	Less than 100kPa (1kgf/cm ²)	
Dimension	700 x 430 x 920 mm. (W x D x H)	
Weight	For Non-Pump Model	19 kg
	For Pump Model	19.6 kg

How to read the manufactured month and year from the label stuck on the back of the product.

EX) 7 0 1 T W A A 0 0 0 1

Serial No.
Password code
Product code
Month
Year (The last digit to year)

Main service part list : Refer to below listed part name when you need service call.

Part name	Remark
- WASH MOTOR	90 W (Output)
- SPIN MOTOR	25-40 W (Output)
- S.D.BASKET	PLASTIC
- CYCLE TIMER ASSEMBLY	
- CAPACITOR	
- GEAR CASE ASSEMBLY	

P/No. : MFL38271101

Specification
(N,R) : Pulsator Type
(P) : Pump Model Only
P/No. : MFL38271101

CAUTION

CAUTION

<p>Installation Area</p> <ul style="list-style-type: none"> Avoid area exposed to snow, rain, or where humidity is high. It may cause electric shock. 	<p>Heat</p> <ul style="list-style-type: none"> Avoid electric heater, candle light, cigarette light, bug smoker, etc. near the machine. It may ignite or deform plastic part.
<p>Switch Area</p> <ul style="list-style-type: none"> Avoid watering on the switch area. It may cause electric shock or fire. 	<p>Hot water</p> <ul style="list-style-type: none"> Avoid using hot water over 50 °C. It may deform plastic parts or cause malfunction.
<p>Volatile Material</p> <ul style="list-style-type: none"> Do not use volatile material such as Benzene, Gasoline, bug killer. Do not leave strong alkaline substance such as bleach inside the tub. Damage on plastic surface and rubber parts may occur. 	<p>In Operation</p> <ul style="list-style-type: none"> Do not insert the hand inside the spin dryer basket while the machine is in operation (Do not let children climb on the machine or climb into the tub. Injury may occur.) Do not drain the water out of the wash tub while the spin dryer basket is in operation. Otherwise the spin motor could be damaged.
<p>Installation</p> <ul style="list-style-type: none"> Install the washing machine on a horizontal support. Otherwise, it may cause vibration and noise. 	<p>Power Cord</p> <ul style="list-style-type: none"> If the power supply cord is damaged, it must only be replaced by the manufacture or its service agent or a similarly qualified person in order to avoid a hazard. <p>Electric Outlet</p> <ul style="list-style-type: none"> Avoid connecting several electric devices to single outlet. It may cause fire.
<ul style="list-style-type: none"> Be sure to disconnect the power cord from the electric outlet before starting care and maintenance. Be sure to earth the washer to prevent electric shock. To reduce the risk of electric shock, do not install the washer in humid spaces. 	
<p>Connecting the drain hose</p> <p>For Non-Pump Model</p> <ul style="list-style-type: none"> Be sure to earth the hose so that it is not kinked; kinks or sharp bending in the hose will prevent proper drainage. Make sure water is drained smoothly by placing a base under the machine or by applying other appropriate mean. <p>For Pump Model</p> <ul style="list-style-type: none"> L ≤ 1 m. 	

FEATURES

Pulsator Table

 Use for WP-****N(P)	
 Use for WP-****R(P)	

①

Water Supply Selector

②

Wash Timer

③

Wash Program

④

Drain Selector

⑤

Spin Timer

⑥

For pump model only

- 1. Water Supply Inlet**
Connect here with the inlet hose from the water faucet to feed water to the tub.
- 2. Water Selector**
Select "WASH" to supply water for washing and rinsing and "SPIN" for spin shower rinse.
- 3. Wash Timer**
Select the desired time for washing or rinsing.
- 4. Wash Program**
Set the program to "Gentle", "Normal", "Strong" according to kinds and quantity of the laundry.

- 5. Drain Selector**
 - For Non-Pump Model**
Select "Wash • Rinse" for washing and rinsing and "Drain" to drain the water out of the tub.
 - For Pump Model**
Select "Wash • Rinse" for washing, rinsing and turn off the drain pump and "Drain" to drain the water out of Cabinet, and "Off" to turn off the drain pump.
- 6. Spin Timer**
Connect here with the inlet hose from the water faucet to feed water to the tub.

INSTALLATION

Installation area

- Set on flat and firm floor
- Incorrect installation may cause severe noise and break down.



- Maintain more than 10 cm between the side of drain hose and the wall.
- A carpet must not obstruct the ventilation openings.

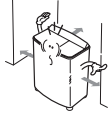

Connecting the earth wire

- Install the earth wire to prevent short-circuit due to leaking current and electric shock.
- It is attached at the back of the washer.
- Connect it to the metal water pipe. If the water pipe is made of plastic, it does not have the earth effect.
- Do not connect the earth wire to the gas pipe, lightning arrester, telephone connector, etc.

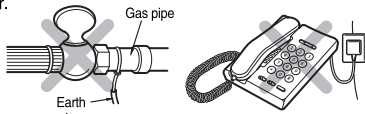

※ Warning-the appliance with two-pronged plug must be grounded.

Connecting the power plug

- Insert the power plug into the outlet.
- Before connecting the power plug, check if the voltage setting of the washer matches the outlet voltage.
- If AC outlet with ground terminal is used, grounding is not needed. If not, never forget earthing (Refer earthing method above).
- The appliance must be positioned so that the plug is accessible.

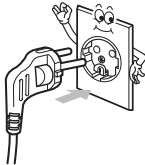

Voltage Change (only for dual voltage)

- This washer is assembled for 220V, but can be changed from 220V to 110V(or 127V).
- Check your electrical source and follow the diagram below to convert voltage.

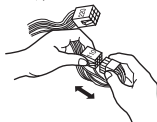

Other earthing method

- After connecting the earth wire to the earth copper plate, bury it at least 75cm deep under the wet ground.
- Connect to the earthing-only outlet.
- When installing it in an area where earthing is not possible, purchase a short-circuit breaker connect it to the outlet.

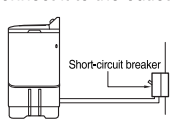
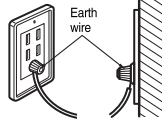
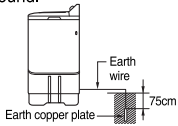

4

INSTALLATION & HOW TO WASH

Before washing

1. Check the washing instruction labels on the clothing to be washed.
2. Remove all objects from the pockets of the clothing. Objects left in the pockets may damage clothing or break the washing machine (could cause the drain hose to clog).
3. After separating oiled or dyed clothing, wash.
4. For your convenience hang up the wash cover on the right or left side of the washing machine tub when not in use.

Remove this before washing



How to wash

1 Set the drain selector
For Non-Pump Model, *For Pump Model*
Set as "off" position, *Set as "Wash + Rinse" position,*

3 Open water supply and fill water till water level mark "H". That is because clothes can absorb adequate amount of water and water will not short.

5 Select the wash program to "Gentle", "Normal" or "Strong" according to the kinds and quantity of the laundry. (Refer to Tabel 2)
Gentle Normal Strong

2 Set the water selector to "WASH"

4 Put the appropriate amount of detergent and the laundry into the wash tub. And add water to the desired water level which you want.

6 Set the desired wash time.

7 When washing is finished, locate the drain selector to "Drain" position and drain the water out.

For Non-Pump Model *For Pump Model*

8 Spinning in the spin dryer basket. Move the laundry into the spin dryer basket. Put the laundry down lightly. Place the safety cover horizontally on the laundry. Set the desired spin time with the spin timer.

5

HOW TO RINSE & HOW TO SPIN

Inter spin rinse

- Interim spin rinse prior to regular rinsing helps removing sudsy water from the laundry and improve rinsing efficiency. Also is helpful to water saving.

1 After washing.
• Move the laundry into the spin dryer basket.
• Place the safety cover horizontally on the laundry.

2 Set the water selector to "SPIN"

4 After interim spin rinse, move the laundry into the wash tub for rinsing.

3 Set the desired spin flow appropriately.

Note for spinning

1. Put the laundry evenly into the spin dryer basket.
2. Put the laundry down lightly.
3. Place the safety cover horizontally over the laundry, washing machine will be damage if the safety cover is not placed.
4. Close the spin dryer cover.
5. Do not drain the water out of wash tub while the spin dryer basket is in operation.
- If the spin dryer basket is off-balance and vibrates excessively, stop the spinning, rearrange the clothes evenly, and then resume spinning.

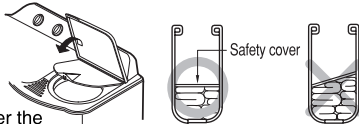

CARE

Overflow filter & Rotation filter-C

1. Pull the overflow filter forward from the wash tub in the direction of the arrow.
2. Lift up the area ④ of the over flow filter and take out the rotation filter-C by pulling in direction as shown.
3. Turn the net over and rinse in water.
4. Use a brush or hand to remove all of the lint which has adhered to the overflow filter.
5. Insert the overflow filter back into the wash tub.
6. Insert the rotation filter-C back into the overflow filter.

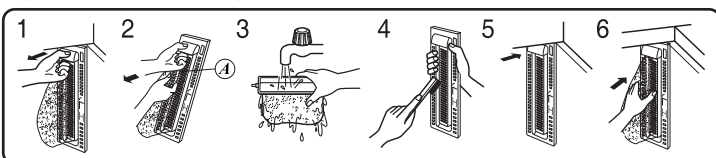

6

REFERENCE

TABLE 1. WEIGHT GUIDE FOR CLOTHES

Type of clothing	Type of fabric	Weight per piece
Under shirt	Cotton	150g(53.0oz)
Handkerchief	Cotton	50g(1.8oz)
Bath towel	Cotton	300g(10.6oz)
Shirt	Mixed fabric	200g(7.1oz)
Socks (1 pair)	Mixed fabric	50g(1.8oz)
Pajama (shirt and pants)	Cotton	500g(17.6oz)
Winter undershirt	Cotton	600g(21.2oz)
Workclothes	Mixed fabric	800g(28.2oz)
Blouse	Mixed fabric	200g(7.1oz)

TABLE 2. GUIDE FOR WASHING

Type of fabric	Wash Selector	Wash Time	Amount of laundry	Water Level	Amount of Water	Amount of detergent
Synthetics, Silk, Woolen, Knits	Gentle	2 ~ 5 min.	0.5 ~ 2 kg	-	30 l	30 g
Cotton, Linen	Normal	5 ~ 10 min.	2 ~ 3 kg	-	40 l	40 g
Very soiled cotton and linen	Strong	10 ~ 15 min.	3 kg~	H	50 l	50 g

- Amount of laundry is based on dry laundry.
- Detergent amount is based on a general synthetic detergent.
- If washing and spinning must be operated together, starting washing and spinning operation shall be done at the same time to cope with EMC requirement.

TROUBLESHOOTING GUIDE

Before Requesting Service

Problem	Checking point
Motor does not operate,	<ul style="list-style-type: none"> • Is the power cord firmly plugged in? • Is the timer turned to a suitable point except "Off" ?
Spin dryer basket does not operate.	<ul style="list-style-type: none"> • Is there any clothing dropped between the basket and tub? • Is the spin dryer cover closed? • Is the laundry gathered to one side of the spin dryer basket?
No draining <i>For Non-Pump Model</i> <i>For Pump Model</i>	<ul style="list-style-type: none"> • Is there lint stuck in the plunger valve? • Is the end of the drain hose guide located at an exceed height? • Is the drain pump operated?

7