



SXS REFRIGERATOR

User's Guide

Please read this guide thoroughly before operating and keep it handy for reference at all times.

SXS REFRIGERATEUR

Manuel d'utilisation

Prière de lire attentivement le présent manuel avant d'utiliser le réfrigérateur. Conserver à portée de main pour pouvoir le consulter à tout moment.

FRIGORÍFICO **SXS**

Guía de usuario

Lea detenidamente estas instrucciones antes utilizar el frigorífico y guárdelas como referencia para el futuro.

Table of Contents

Introduction	Entry	3
	Important safety instructions	3
	Identification of parts	4
Installation	Where to install	5
	Door removal	6
	Door replacement	7
	Water supply installation	7
	Height adjustment	8
Operation	Setup	9
	Adjusting the temperatures and functions	9
	Refreshment center (Applicable to some models only)	15
	Shelf (Applicable to some models only)	16
	Wine holder (Applicable to some models only)	16
	Egg Box (Applicable to some models only)	17
	Humidity control in the vegetable compartment	17
	Deodorizer (Applicable to some models only)	17
	OptiFresh temperature bin	18
	OptiFresh (Applicable to some models only)	18
Suggestion on food storage	Location of foods	19
	Storing foods	20
Care and maintenance	How to remove and replace parts	21
	General information	24
	Cleaning	24
	Troubleshooting	25

Entry

The model and serial numbers are found on the inner case or back of refrigerator compartment of this unit. These numbers are unique to this unit and not available to others. You should record requested information here and retain this guide as a permanent record of your purchase. Staple your receipt here.

Date of purchase _____
 Dealer _____
 Dealer address _____
 Dealer phone _____
 Model _____
 Serial _____

Important safety instructions

Before use, this refrigerator must be properly installed and located in accordance with the installation instructions in this manual.

Never unplug your refrigerator by pulling on the power cord. Always grip the plug firmly and pull it straight out from the outlet.

When moving your appliance away from the wall, be careful not to roll over the power cord or to damage it in any way. Do not crush or damage the water line.

After your refrigerator is in operation, do not touch the cold surfaces in the freezer compartment, particularly when your hands are damp or wet. Skin could adhere to these extremely cold surfaces.

Unplug the power cord from the power outlet for cleaning or other requirements. Never touch it with wet hands because you can get an electric shock or be injured.

Never damage, bend, kink, pull out, or twist the power cord because damage to the power cord can cause product failure, fire, or electric shock. If you have doubts the appliance is properly grounded, consult a qualified electrician.

Never place glass products in the freezer because they may be broken from expansion when their contents are frozen.

Never put your hands within the ice storage bin of the automatic icemaker. You can be injured by the operation of the automatic icemaker.

The appliance is not intended for use by young children without supervision.

Young children should be supervised to ensure that they do not play with the appliance.

Never allow anyone to climb, sit, stand, or hang on the door. These actions may damage the refrigerator and even tip it over, causing severe personal injury.

The refrigerator-freezer should be so positioned that the supply plug is accessible for quick disconnection in the event of an emergency.

If the supply cord is damaged, it must be replaced by the manufacturer or its service agent or a similarly qualified person in order to avoid any hazard.

Do not modify or extend the Power Cord length.

- It may cause electric shock or fire.



Accessibility of supply plug

Supply cord replacement

Warning

Child entrapment warning**DANGER: Risk of child entrapment.**

Before you throw away your old refrigerator or freezer take off the doors but leave the shelves in place so that children may not easily climb inside.

The appliance is not intended for use by young children without supervision.

Young children should be supervised to ensure that they do not play with the appliance.

Don't store

Don't store or use gasoline or other flammable vapor and liquids in the vicinity of this or any other appliance.

Grounding

In the event of an electric short circuit, grounding (earthing) reduces the risk of electric shock by providing an escape wire for the electric current.

In order to prevent possible electric shock, this appliance must be grounded.

Improper use of the grounding plug can result in an electric shock. Consult a qualified electrician or service person if the grounding instructions are not completely understood, or if you have doubts on whether the appliance is properly grounded.

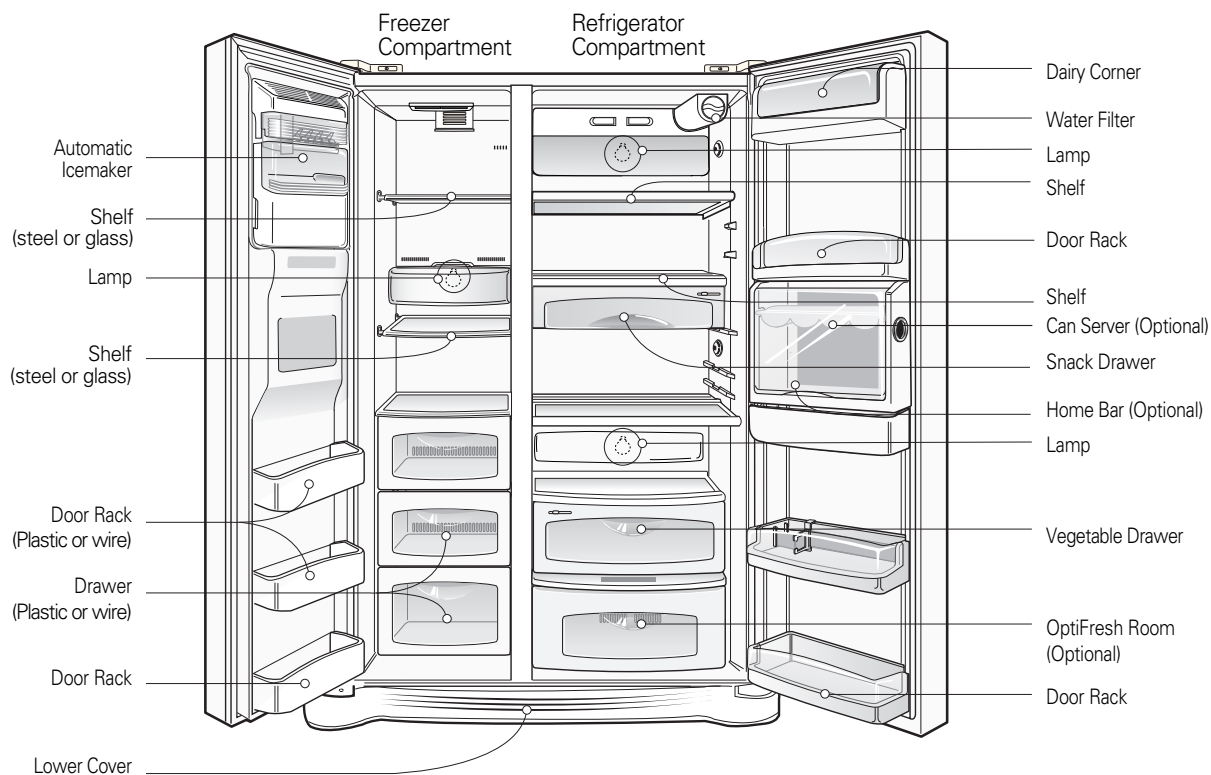
Identification of parts**NOTE**

- Parts, features, and options vary by model. Your model may not include every option.

Where to install

Strong and even floor

Unstable installation may cause vibration and noise. If the floor to install the refrigerator on is not even, make the refrigerator level by rotating the height adjusting screw.

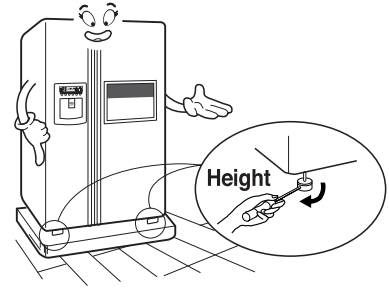

A proper distance from adjacent items

To ensure proper air circulation around the fridge-freezer, please maintain sufficient space on both the sides as well as top and maintain at least 2 inches (5 cm) from the rear wall.

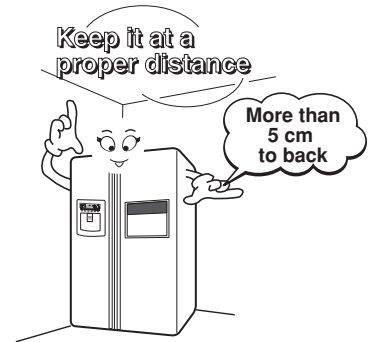

Where water supply can be easily connected in a dry place

Select a place where a water supply can be easily connected between the automatic ice maker and dispenser. Installing the refrigerator in a wet or damp area may cause rust and may be an electrical hazard.

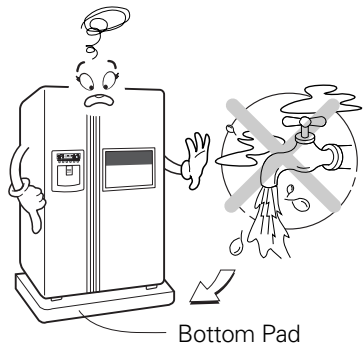

Where it is free from heat

If this refrigerator is installed where the ambient temperature is high, the freezing capacity is deteriorated and the cost of electricity used increases.

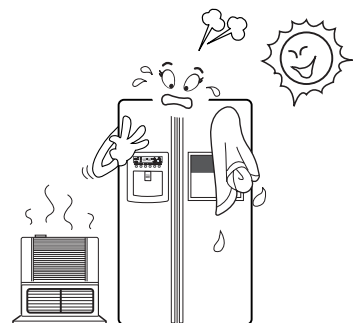

NOTE

- Install the refrigerator at a place where the ambient temperature is 5°C ~ 43°C. Ambient temperature outside this range may cause product malfunction. Also, the tube between the dispenser and automatic ice maker may freeze.

Door removal

Warning

Electric Shock Hazard

Disconnect electrical supply to refrigerator before installing. Failure to do so could result in death or serious injury.

If your entrance door is too narrow for the refrigerator to pass through, remove the refrigerator door and pass the refrigerator laterally.

Remove the lower cover by lifting upward, and then pull up the water feed tube while pressing the release ring ① shown in the figure to the right.

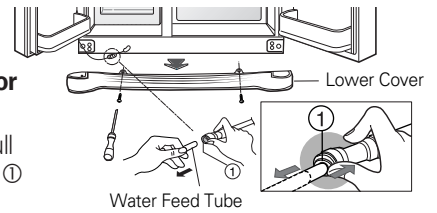

Remove lower cover and water feed tube

NOTE

- If a tube end is deformed or abraded, trim the part away. Disconnecting the tube under the door causes about 2 liters water to flow out. Please put up a big container to prevent it.

Remove the freezer compartment door

1) Remove the hinge cover by loosening the screws. Disconnect all connections except the ground line.



2) Remove the keeper by rotating it counter clockwise ① and then lifting the upper hinge up ②.

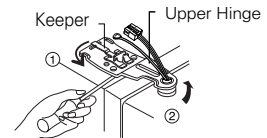

NOTE

- When removing the upper hinge, be careful that the door does not fall forward.

3) Remove the freezer compartment door by lifting it upward. This time, the door should be lifted enough for the water feed tube to be completely pulled out.

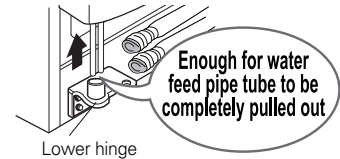

NOTE

- After removing the door, take it into the kitchen where you are installing the refrigerator. Lay it down on a blanket and be careful to avoid damaging the water feed tube.

Remove the refrigerator door

1) Loosen the hinge cover screws and remove the cover. Remove connection wire, if any, except for the ground line.

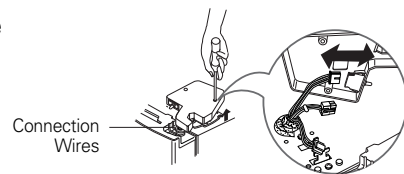

2) Remove keeper by rotating it clockwise (①) and then remove the upper hinge by lifting it up (②).

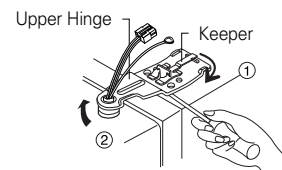

3) Remove the refrigerator compartment door by lifting it up.

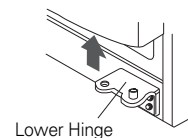

Pass the refrigerator

Pass the refrigerator laterally through the access door as shown in the right figure.

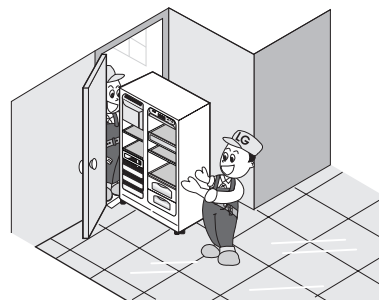

Door replacement

Mount them in the reverse sequence of removal after they pass through the access door.

Water supply installation

Before installation

- Automatic icemaker operation needs water pressure of 147~834 kPa (1.5~8.5 kgf/cm²) (That is, an instant paper cup (180 cc) will be fully filled within 3 seconds.)
- If water pressure is less than 147 kPa. It is necessary to purchase a separate pressure pump for normal automatic icemaking and cool water feed.
- Keep the total length of the feed water pipe tube within 8 m. Be careful for the tube to avoid being kinked. If the tube is longer than 8 m, the pressure may drop to an unacceptable level.
- Install the water supply line where it will not be affected by heat.

Warning

- Connect to potable water supply only.
- Refer to instructions with water filter kit for installation.

Disposal of the old appliance

This appliance contains fluids (refrigerant and lubricant) and is made of parts and materials which are reusable and/or recyclable. All the important materials should be sent to the collection center of waste material and can be reused after rework (recycling). For recycling, please contact the local agency.

Height adjustment

If the freezer compartment door is lower than the refrigerator compartment door

Level them by inserting a flat (- type) driver into the groove of the left height adjusting screw and rotating it clockwise (⌚).

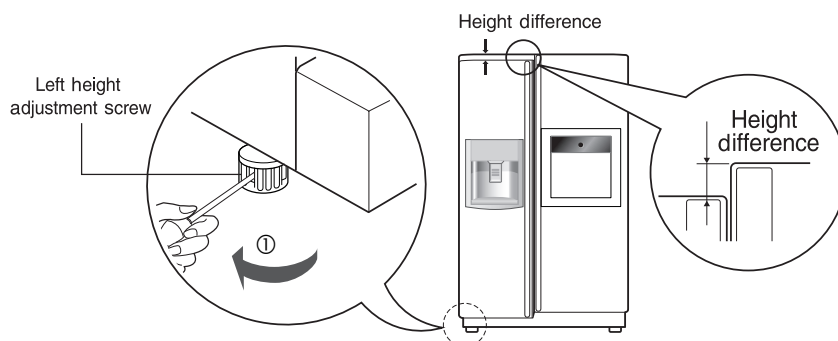

If the freezer compartment door is higher than the refrigerator compartment door

Level them by inserting a flat (- type) driver into the groove of the right height adjusting screw and rotating it clockwise (⌚).

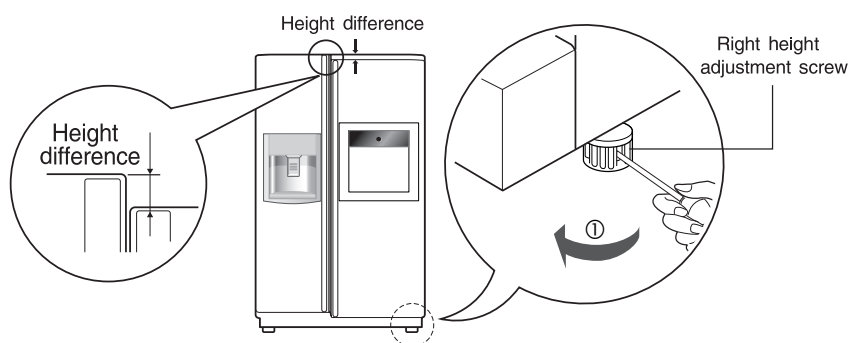

After leveling the door height

The refrigerator door will close smoothly by raising the front side by adjusting the height adjusting screw. If the door does not close properly because it is improperly adjusted, the performance of the refrigerator will be affected.

Next

1. Wipe off all dust accumulated during shipping and clean your appliance thoroughly.
2. Install accessories such as the ice cube box, cover evaporating tray, etc., in their proper places. They are packed together to prevent possible damage during shipping.
3. Connect the power supply cord (or plug) to the outlet. Use this appliance on a dedicated circuit.

Setup

When your refrigerator is first installed, allow it to stabilize at normal operating temperatures 2~3 hours prior to filling it with fresh or frozen foods. If operation is interrupted, wait 5 minutes before restarting.

Adjusting the temperatures and functions

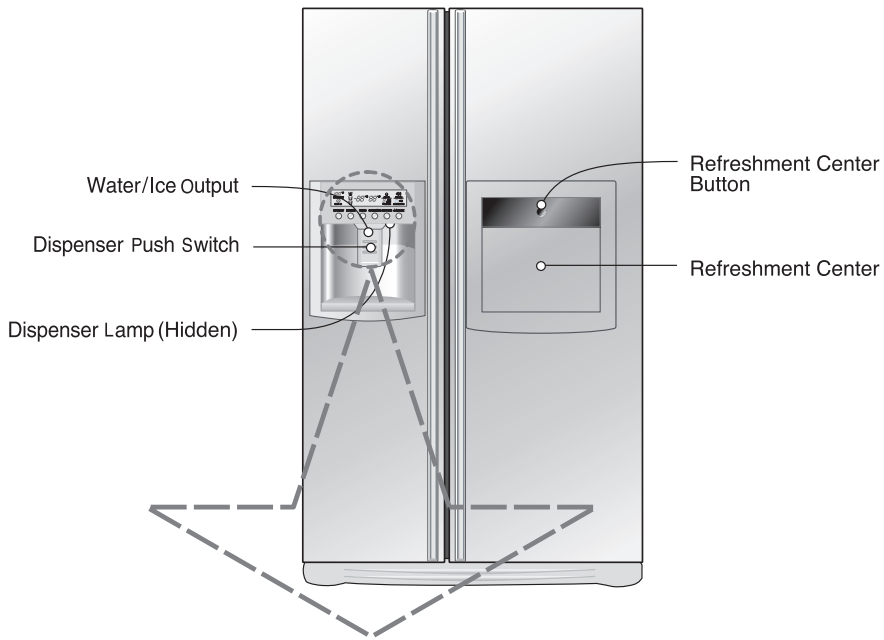

Function display board

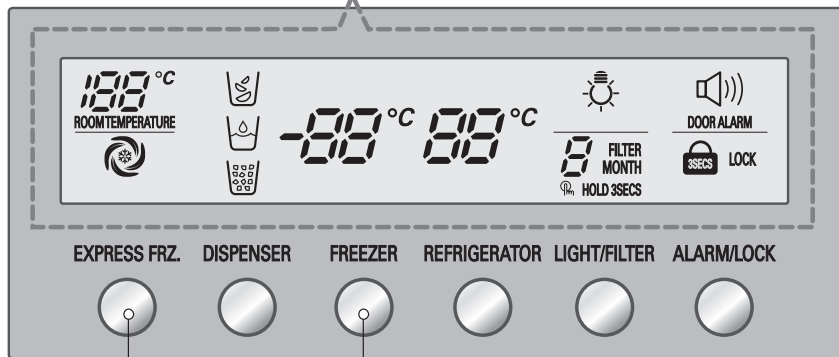

Display Power Saving Mode

NOTE

- Your model may not include every option.
- The control display is operated by touch. Excessive moisture on the display may cause a malfunction. Please keep display clean and dry.

Display Power Saving Mode

This function places the display into power saving mode until the next time the door is opened.

Press the FREEZER and EXPRESS FREEZER buttons simultaneously and hold them for 5 seconds until the Ding sounds. All LCDs will then turn ON, then OFF. When the power saving mode is activated, the display will remain off until the next time the door is opened. Then, it will come on whenever a door is opened or a button is pressed and remain on for 20 seconds after the last door opening or button selection. To deactivate the power saving mode, press the FREEZER and EXPRESS FREEZER buttons simultaneously and hold them for 5 seconds until the Ding sounds.

You can adjust temperature of freezer compartment and refrigerator Compartment.

How to adjust the temperature in the freezer compartment

Freezer Compartment temperature adjustment



How to adjust the temperature in the refrigerator compartment

Refrigerator Compartment temperature adjustment



* Whenever pressing button, setting is repeated in the order of (Weak) → (Middle Weak) → (Middle) → (Middle Strong) → (Strong).

- The actual inner temperature varies depending on the food status, as the indicated setting temperature is a target temperature, not actual temperature within refrigerator.
- Refrigeration function is weak in the initial time. Please adjust temperature as above after using refrigerator for minimum 2~3 days.

How to use dispenser

- Select among crushed ice, water, and cubed ice and press the push switch with a glass or other container.

Crushed Ice

Light the crushed ice lamp by pressing the selection button.

- Crushed ice will be dispensed by pressing the push switch with a glass.

Water

Light the water lamp by pressing the selection button.

- Water will be dispensed by pressing the push switch with a glass.

Cubed Ice

Light the cubed ice lamp by pressing the selection button.

- Cubed ice will be dispensed by pressing the push switch with a glass.

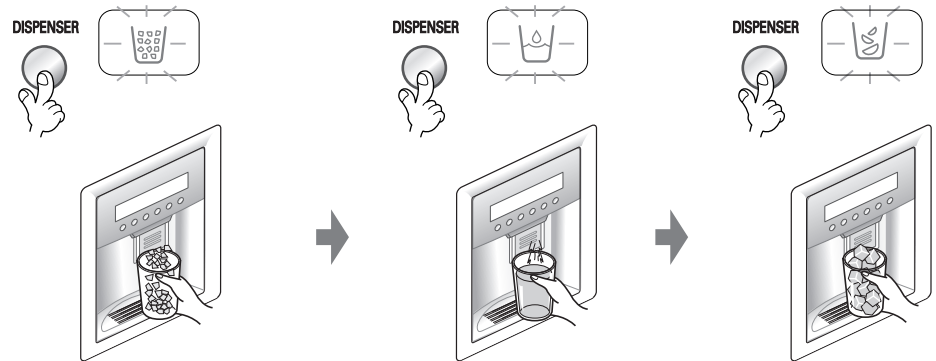

- **Reference** : Hold your cup in place for a couple of seconds after dispensing ice or water so the last few drops go in to your cup instead of the floor.

Automatic icemaker

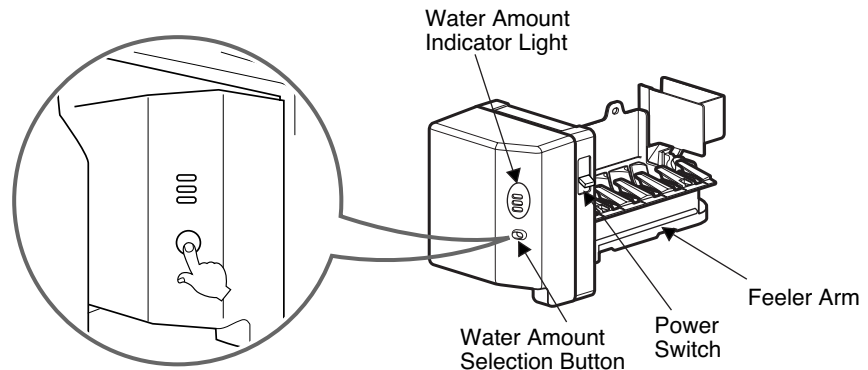

- The automatic icemaker can automatically make 6 cubes at a time, 70~120 pieces per day. This quantity may vary by circumstance, including ambient temperature, door opening, freezer load. etc.
- Icemaking stops when the ice storage bin is full.
- If you don't want to use the automatic icemaker, turn the icemaker switch to OFF. If you want to use automatic icemaker again, change the switch to ON.
- The water amount will vary depending on the water amount selection button. Setting, as well as the water pressure of the connected water line.

NOTE

- It is normal that a noise is produced when ice drops into the ice storage bin.

When ice dispensing does not operate smoothly

Ice is lumped together

- If the ice lumps together, take it out, break it apart, and put it back into the storage bin.
- When the icemaker produces too small or lumped together ice, the amount of water supplied to the ice maker needs to be adjusted. Contact the service center.
- ✧ If ice is not used frequently, it may lump together.

Power failure

- Water may drop from the refrigerator. Take the ice storage bin out and discard all the ice then dry it and place it back. After the power is restored, the refrigerator defaults to crushed ice.

The unit is newly installed

- It takes about 12 hours for a newly installed refrigerator to make ice.

CAUTION

Throw away the first few batches of ice. The first ice and water may include particles or odor from the water supply line or the water tank.

This is also necessary if the refrigerator has not been used for a long time.

Never store beverage cans or other foods in ice storage bin for the purpose of rapid cooling. It may damage the automatic ice maker.

Shake the bin occasionally to cause the ice to settle.

Ice may pile up just around the icemaker causing the icemaker to think that the ice storage bin is full.

If discolored ice is dispensed, contact an Authorized Service Center immediately. Do not use the ice or water until the problem is corrected.

Express freezer

Please select this function for prompt freezer.

- OFF → ON → OFF is repeated whenever pressing  button.
- The arrow mark graphic remains at the On status after flickering 4 times when selecting Special Refrigeration On.
- Prompt freezer function automatically turns off after a fixed time passes.

EXPRESS FRZ.

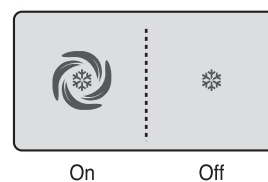

Lock

This button stops operation of different button and dispenser function.

- Locking or Release is repeated whenever the  is pressed more than 3 seconds.
- If you use the ALARM/LOCK button, none of the other buttons will work until you unlock them.

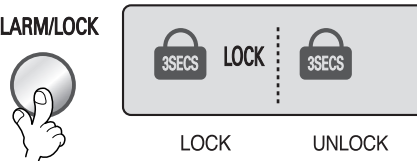

Door alarm

Door open warning

- A warning tone will sound 3 times at thirty-second intervals if the refrigerator or freezer door is left open for more than sixty seconds.
- Please contact with the local service center if warning continue to sound even after closing the door.

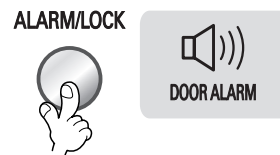

Filter condition (filter replacement cycle) display function

- There is a replacement indicator light for the water filter cartridge on the dispenser.
- The water filter should be replaced every six months.
- The filter light comes on to let you know when to replace filter.
- After replacing the filter, press and hold the filter button more than 3 seconds to reset the indicator.

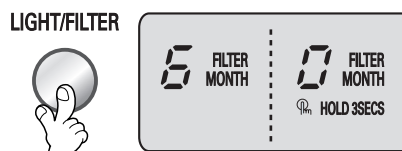

Dispenser light

This button turn the dispenser light in the dispenser on an off.

- The dispenser light function is turned ON or OFF by pressing Light/Filter button.
- If the dispenser light stays on for more than 7 minutes, it will turn off automatically.
- Some models have an auto mode that uses a light sensor to turn the dispenser light on and off.

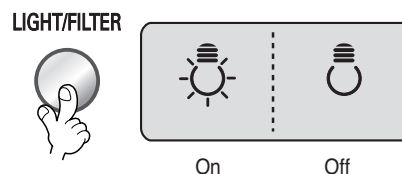

*Auto light is not applicable to all models.

Other functions**Ambient Temperature Display Window.**

- Temperature is displayed only between -9°C ~ 49°C.
- Temperature less than -9°C is indicated with LO and temperature more than 49°C is indicated with HI.

**Diagnostic (failure detection) function**

- The diagnostic function automatically detects failure when failure is found in product during the use of refrigerator.
- If your refrigerator fails, do not turn off the power. Instead, contact a local authorized service center or call our support line for assistance. Turning off the appliance will make it more difficult for the service technician to determine the problem.

How ice/cold water is supplied

Water is cooled while stored in the water tank in freezer door, and then sent to the dispenser.

Ice is made in the automatic icemaker and sent to the dispenser.

Cautions**Throw away the ice (about 20 pieces) and water (about 7 glasses) first made after refrigerator installation.**

This is also necessary when the refrigerator has not been used for a long time.

Keep children away from the dispenser.

Children may play with or damage the controls.

Be careful that food does not block the ice passage.

If foods are placed at the entrance of ice passage, the dispenser may malfunction. The passage may also become blocked with frost if only crushed ice is used. Remove the frost that accumulates.

Storing cans or other items in the ice bin may damage the icemaker or the container may burst.**Never use thin crystal glass or crockery to collect ice.**

Such glasses or containers may be broken, and glass fragments could be in the ice.

Put ice first into a glass before filling water or other beverages.

Water may be splashed if ice is added to existing liquid in a glass.

Keep your hands out of the ice door and passage.

You might break something or injure yourself.

Never remove the ice maker cover.**Shake the ice bin occasionally to level the ice in it.**

Sometimes the ice piles up near the icemaker, causing the icemaker to misinterpret the bin level and stop producing ice.

If you find ice or water dispensed unexpectedly, contact an Authorized Service Center. (Contact a local authorized service center.)**Never use too narrow or deep glass.**

Ice may be jammed in the ice passage and, thus, the refrigerator may fail.

Keep the glass at a proper distance from ice outlet.

A glass too close to the outlet may prevent ice from coming out.

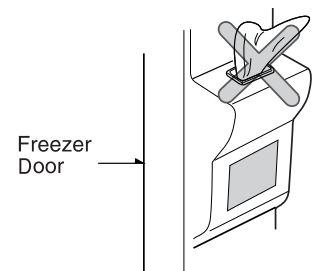

Refreshment center (Applicable to some models only)

How to use

Open the refreshment center door.

- You can access the refreshment center without opening refrigerator door and thus saving electricity.
- Inner lamp is lit in refrigerator compartment when the refreshment center door opens. Thus it is easy to identify the contents.

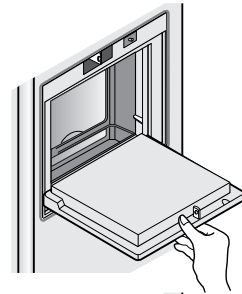

Use the refreshment center door as a stand

- Never use the refreshment center door as a chopping board and take care not to damage it with sharp tools.
- Never rest your arms or severely press on it.

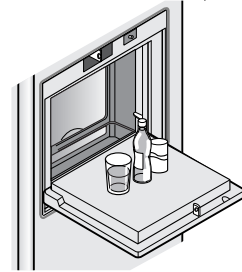

Never take out the inner refreshment center cover

- The refreshment center can not function normally without the cover.

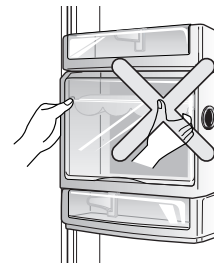

Never place heavy items on the refreshment center door or allow children to hang it on.

- Not only can the refreshment center door may be damaged, but also children may be hurt.

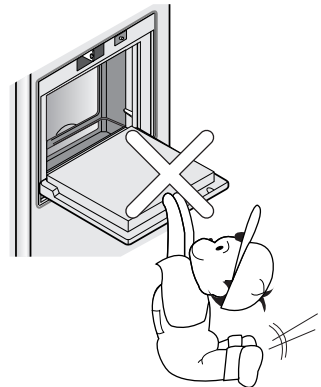

Shelf (Applicable to some models only)

Shelf height adjustment

The refrigerator compartment shelves are adjustable so you can locate them according to your needs.

- **Slide Shelf**
Pull the shelf ahead and take off it while lifting both front and rear part.

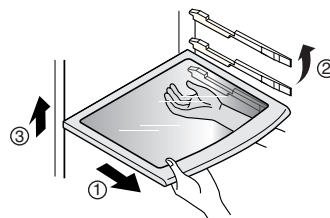

- **Fixed Shelf, Folding Shelf**
Lightly lift up the front part of shelf to pull it ahead and then take off it while lifting the rear part of shelf.

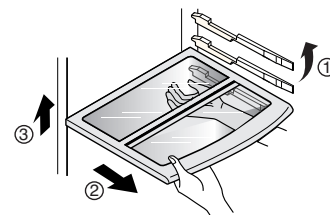

NOTE

- Make sure the shelf is horizontal. If not, it may drop.

Slide-Under Shelf

You can store taller items such as a gallon container or bottles by simply pushing in front half of shelf underneath back half of shelf. Pull toward you to return to a full shelf.

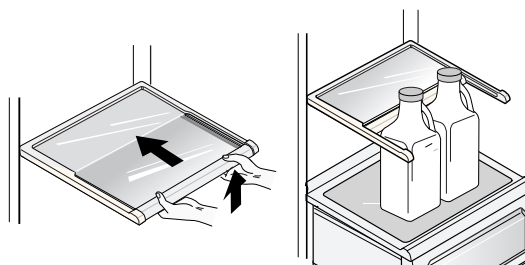

Wine holder (Applicable to some models only)

Wine holder adjustment (Type 1)

Bottles can be stored laterally with this wine corner.
This can be attached to any shelf.

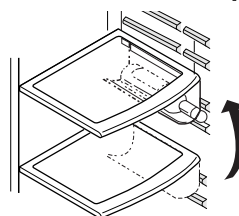

In case of inserting the wine holder :

Pull the wine holder downward as in ② after inserting it into the side anchoring part of the shelf as in ① by catching it upward as in ①.

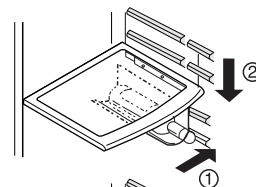

In case of separating the wine holder :

Pull the wine holder inward as in ④ after holding it upward as in ③ by catching it.

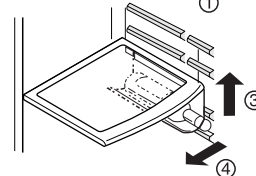

(Type 2)

Bottles can be stored laterally with this wine rack.

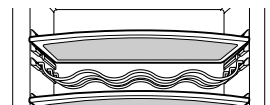

Egg Box (Applicable to some models only)

You can move the egg box to a place you want and select another form of box according to the amount of eggs.

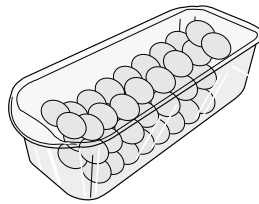

[Normal]

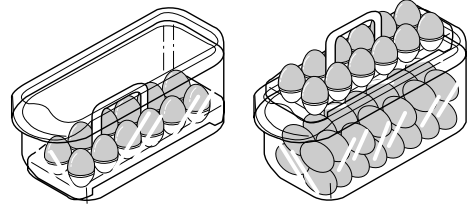

[For Many Eggs]

NOTE

- Never use the egg box as an ice storage bin. It can break.
- Never store the egg box in the freezer compartment or fresh compartment.

Humidity control in the vegetable compartment

The humidity can be controlled by adjusting the humidity control switch to the left or right when storing vegetables or fruits.

High humidity

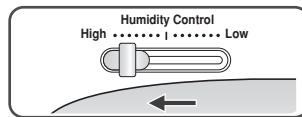

Low humidity

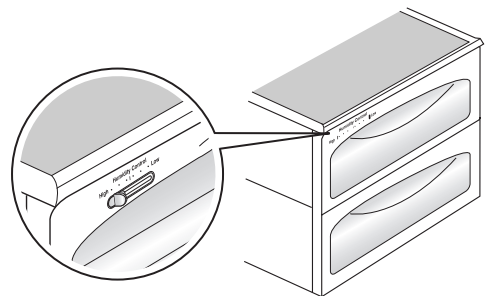
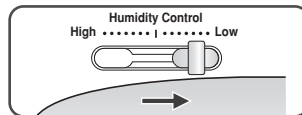

Deodorizer (Applicable to some models only)

This system efficiently absorbs strong odors by using the optical catalyst. This system does not have any effect on stored food.

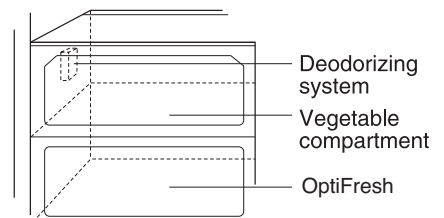

How to use the deodorizing system

- Since it is already installed onto the cool air intake duct from the refrigerator compartment, you need no separate installation.
- Please use closed containers to store food with pungent odors. Otherwise, this odor can be absorbed by other food in the compartment.

OptiFresh temperature bin



Method to use

You can select the optimum temperature to store some types of foods.

- Vegetables, fruits, cold storage items requiring humidity maintenance can be stored under optimal condition by pressing the button.

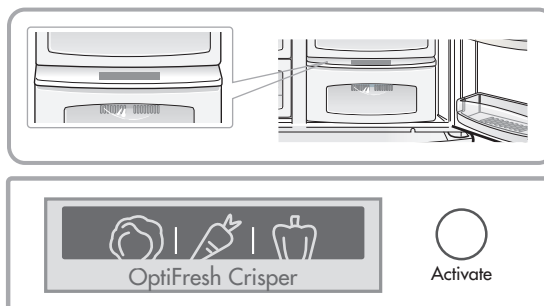

- If you open the refrigerator door, an indicator lamp shows the status of the OptiFresh. The lamp goes off when the door is closed.
- Press the button to cycle between ON and OFF.

OptiFresh (Applicable to some models only)

When removing OptiFresh

- First, remove the vegetable bin.
- After holding both ends of the OptiFresh ① and ② pull it outward.

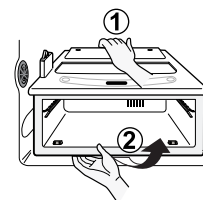



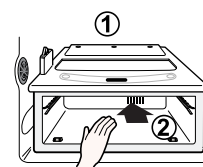

When installing OptiFresh

- Fit the OptiFresh case on to the ledge ① and gently slide it in ②.
- If forced, the connecting parts can be damaged.

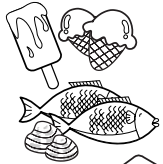

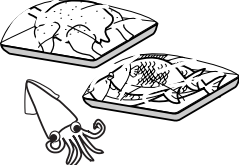
Location of foods

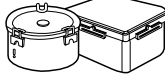
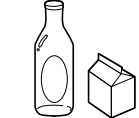
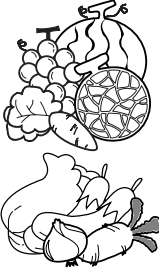
Snack drawer	Store small foods such as bread, snacks, etc.	
Freezer compartment shelf	Store various frozen foods such as meat, fish, ice cream, frozen snacks, etc.	
Freezer compartment door rack	Store small packed frozen food. Items stored in the door racks don't stay quite as cold as in the rest of the freezer. Store ice cream and similar items on a shelf in the freezer instead.	
Freezer compartment drawer	Store meat, fish, chicken, etc. after wrapping them with thin foil. Store dry.	
Milk product corner	Store milk products such as butter, cheese, etc.	
Refrigerator compartment shelf	Do not pack the freezer or refrigerator tightly. Allow a little room for proper air circulation to aid cooling.	
Refrigerator compartment door rack	Store small packed food or beverages such as milk, juice, etc.	
Vegetable drawer	Store vegetables or fruits.	
		

Storing foods

- Store fresh food in the refrigerator compartment. How food is frozen and thawed is an important factor in maintaining its freshness and flavor.
- Do not store food which spoils easily at low temperatures, such as bananas and melons.
- Allow hot food to cool prior to storing, placing hot food in the refrigerator could spoil other food, and lead to higher energy consumption.
- When storing the food, cover it with vinyl wrap or store in a container with a lid. This prevents moisture from evaporating, and helps food to keep its flavor and nutrition.
- Do not block air vents with food. Smooth circulation of chilled air keeps refrigerator temperatures even.
- Do not open the door frequently. Opening the door lets warm air enter the refrigerator, and cause temperatures to rise.
- Never overload the door racks because they may push against by inner racks so that the door cannot be fully closed.

Freezer compartment

- Do not store bottles in the freezer compartment, they may break when frozen.
- Do not refreeze food that has been thawed. This causes loss of flavor and nutrition.
- When storing frozen food like ice cream for a long period, place it on the freezer shelf, not in the door rack.
- Do not touch the cold foods or containers, especially made of metal, with wet hands and place glass products in the freezer compartment.
 - Damp skin can freeze and stick to cold surfaces, causing frostbite and other serious injuries.

Refrigerator compartment

- Avoid placing moist food in top refrigerator shelves, it could freeze from direct contact with chilled air.
- Always clean food prior to refrigeration. Vegetables and fruits should be washed and wiped, and packed food should be wiped, to prevent adjacent food from spoiling.
- When storing eggs in their storage rack or box, ensure that they are fresh, and always store them in an upright position to keep them fresh longer.

NOTE

- If you keep the refrigerator in a hot and humid place, frequent opening of the door or storing a lot of vegetables in it may cause condensation to form. Wipe the condensation with a clean cloth or a paper towel.

How to remove and replace parts

NOTE

- Dismantling is done in the reverse sequence of assembly.
Be sure to unplug the power plug before dismantling and assembly.
Never apply severe force to dismantle parts. Parts may be damaged.

Freezer compartment lamp

To remove the lamp cover, separate the shelf over the lamp cover and pull the lamp cover forwards ② while pressing the bottom side of the lamp cover upwards ①. Turn the bulb counterclockwise.
Use a 40-watt bulb (max.) which can be purchased at a service center.

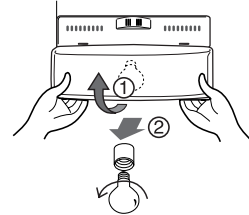

Freezer compartment shelf

To remove a shelf, push the shelf to the left ①, lift the left part of the shelf a bit ②, lift the right part up ③, and take it out.

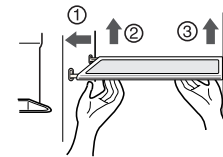

Door rack and support

Lift the door rack holding both sides ① and pull it out ②.

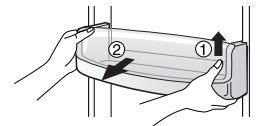

Ice storage bin

Hold the ice storage bin as shown in the right figure and pull it out ② while slightly lifting it ①.

- Do not dismantle the ice storage bin unless it is necessary.
- Use both hands to remove the ice bin to avoid dropping it.

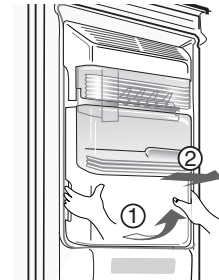

After dispenser is used

The water collector has no self-draining function. It should be cleaned regularly. Remove the cover by pulling the front side of water collector cover and dry it with a cloth.

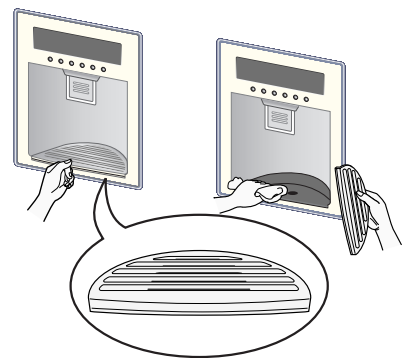

Upper lamp in refrigerator compartment

To remove the lamp cover, pull the lamp cover forward while pressing the bottom side of the lamp cover upward. Turn the bulb counterclockwise. Use a 40-watt bulb (max.) which can be purchased at a service center.

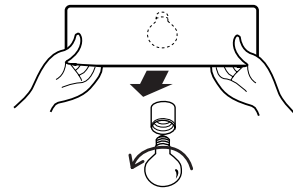

Lower lamp in refrigerator compartment

Separate the lamp cover by holding both lower sides of it and pulling it forward. Turn the bulb counterclockwise. Use a 40-watt bulb (max.) which can be purchased at a service center.

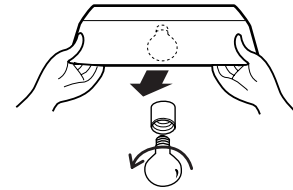

Lamp in refrigerator compartment

To remove the lamp cover, press the protrusion under the lamp cover to the front and then pull the lamp cover out. Turn the bulb counterclockwise. Max. 40 W bulb for refrigerator is used and can be purchased at a service center.

Refreshment center

- Separate the bin (①) to upward.
- Separate the upper rack of the refreshment center and then pull out the refreshment center cover (②).
- The refreshment center can be removed by pulling it upwards.

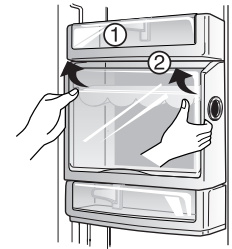

NOTE

- Be sure to remove the necessary door racks and other parts to allow clearance to remove the vegetable compartment, snack, drawer, and home bar cover.

Vegetable compartment cover

- To remove the vegetable compartment cover, pull out the vegetable compartment a bit to the front ①, lift the front part of the vegetable compartment cover as shown by ②, and take it out.

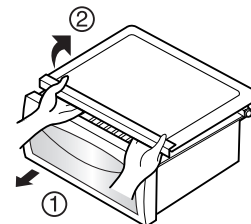

Filter replacement

We recommend replacing the filter when the water filter indicator light turns on or your water dispenser or ice maker decreases noticeably. After changing the water filter cartridge, reset the water filter status display and indicator light by pressing and holding the **BUTTON** for 3 seconds.

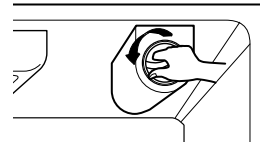

- 1) Remove the old cartridge.
Rotate the knob of the cartridge counter clockwise. When the cartridge is removed, you will feel it click out of place.
Pull out the cartridge.

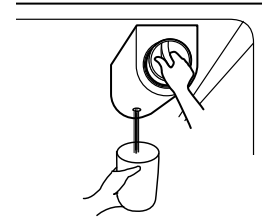

NOTE

- Replacing filter causes small amount of water (around 25 cc) to flow out. Please put up a cup under the hole to prevent it.

- 2) Replace with a new cartridge.
Take the new cartridge out of its packaging and remove protective cover from the o-rings. With cartridge knob in the vertical position, push the new filter cartridge into the cover until it stops.
If you can't turn the filter from side to side, it isn't fully inserted. Push it in firmly and twist it into place. You will hear the snap when it clicks into place. Using its handle, twist the cartridge clockwise about 1/4 turn. You will hear the snap when it clicks into place.

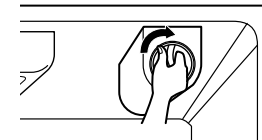
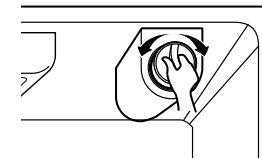

- 3) Flushing the Water System After Replacing Filter.
Dispense water through the water dispenser for 3 minutes to purge the system.

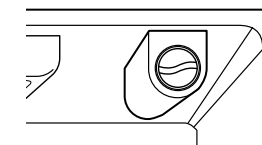

General information

Vacation time	<p>During average length vacations, you will probably find it best to leave the refrigerator in operation. Place freezable items in freezer for longer life.</p> <p>When you plan to store the refrigerator, remove all food, disconnect the power cord, clean the interior thoroughly, and block the doors open to prevent mold and mildew. Be certain the stored refrigerator does not present a child entrapment danger.</p>
Power failure	<p>Most power failures that are corrected in an hour or two will not affect your refrigerator temperatures. However, you should minimize the number of door openings while the power is off.</p>
If you move	<p>Unload the refrigerator to relocate it. (This is probably not necessary to pull it out for cleaning behind it.) Be sure to let the refrigerator warm up to room temperature, and dry the inside before closing the doors to pack it for moving.</p> <p>To avoid damaging the height adjusting screws, turn them all the way into the base.</p>
Anti-condensation pipe	<p>The outside wall of the refrigerator cabinet may sometimes get warm, especially just after installation. Don't be alarmed. This is due to the anti-condensation pipe, which pumps hot refrigerant to prevent sweating on the outer cabinet wall.</p>

Cleaning

It is important that your refrigerator be kept clean to prevent undesirable odors. Spilled food should be wiped up immediately, since it may acidify and stain plastic surfaces if allowed to settle.

Exterior	<p>Use a lukewarm solution of mild soap or detergent to clean the durable finish of your refrigerator. Wipe with a clean damp cloth and then dry.</p>
Interior	<p>Regular cleaning is recommended. Wash all compartments with a baking soda solution or a mild detergent and warm water. Rinse and dry. Be sure to allow the soda to dissolve completely so it will not act as an abrasive compound.</p>
After cleaning	<p>Please verify that the power cord is not damaged, power plug is not overheated, or power plug is well inserted into the power consent.</p>
Warning	<p>Always remove the power cord from the wall outlet prior to cleaning in the vicinity of electrical parts (lamps, switches, controls, etc.).</p> <p>Wipe up excess moisture with a sponge or cloth to prevent water or liquid from getting into any electrical part and causing an electric shock.</p> <p>Never use metallic scouring pads, brushes, coarse abrasive cleaners, strong alkaline solutions, or flammable or toxic cleaning liquids on any surface.</p> <p>Do not touch frozen surfaces with wet or damp hands, because damp objects will stick to extremely cold surfaces.</p>

Troubleshooting

Before calling for service, review this list. It may save you both time and expense. This list includes common occurrences that are not the result of defective workmanship or materials in this appliance.

Occurrence	Possible Cause	Solution
Normal Operations Refrigerator		
Refrigerator compressor does not run.	Refrigerator control is off.	Set refrigerator control.
	Refrigerator is in defrost cycle.	This is normal for a fully automatic defrosting refrigerator. The defrost cycle occurs periodically.
	Plug at wall outlet is disconnected.	Make sure plug is tightly pushed into outlet.
	Power outage. Check house lights.	Call local electric company.
Refrigerator runs too much or too long	Refrigerator is larger than the previous one you owned.	This is normal. Larger, more efficient units run longer.
	Room or outside weather is hot.	It is normal for the refrigerator to work longer under these conditions.
	Refrigerator has recently been disconnected for a period of time.	It takes a few hours for the refrigerator to come down to room temperature completely.
	Automatic icemaker is operating.	Operation of the ice maker causes the refrigerator to run slightly longer.
	Large amounts of warm or hot food may have been stored recently.	Warm food will cause the refrigerator to run longer until the desired temperature is reached.
	Doors are opened too frequently or too long.	Warm air entering the refrigerator causes it to run more. Open the door less often.
	Refrigerator or freezer door may be slightly open.	Make sure the refrigerator is level. Keep food and containers from blocking the door. See problem section OPENING/CLOSING of doors.
	Refrigerator control is set too cold.	Adjust the refrigerator control to a warmer setting until the refrigerator temperature is satisfactory.
	Refrigerator or freezer gasket is dirty, worn, cracked, or poorly fitted.	Clean or change gasket. Leaks in the door seal will cause the refrigerator to run longer in order to maintain desired temperatures.

Occurrence	Possible Cause	Solution
Refrigerator compressor does not run.	Thermostat is keeping the refrigerator at a constant temperature.	This is normal. The Refrigerator goes on and off to keep the temperature constant.
Temperatures are too cold		
Temperature in the freezer is too cold but the Refrigerator Temperature is Satisfactory.	Freezer control is set too cold	Adjust the freezer control to a warmer setting until the freezer temperature is satisfactory.
Temperature in the refrigerator is too cold and the freezer temperature is satisfactory.	Refrigerator control is set too cold.	Adjust the refrigerator control to a warmer setting
Food stored in drawers freezes.	Refrigerator control is set too cold.	Adjust the refrigerator to a warmer setting.
Meat stored in fresh meat drawer freezes.	Meat should be stored at a temperature just below the freezing point of water (0°C) for maximum fresh storage time.	It is normal for ice crystals to form due to the moisture content of meat.
Temperatures are too warm		
Temperatures in the refrigerator or freezer are too warm.	Freezer control is set too warm.	Adjust the freezer or refrigerator control to a colder setting until the freezer or refrigerator temperature is satisfactory.
	Refrigerator control is set too warm. Refrigerator control has some effect on freezer temperature.	Adjust the freezer or refrigerator control to a colder setting until the freezer or refrigerator temperature is satisfactory.
	Doors are opened too frequently or too long.	Warm air enters the refrigerator/ freezer whenever the door is opened. Open the door less often.
	Door is slightly open.	Close the door completely.
	Large amounts of warm or hot food may have been stored recently.	Wait until the refrigerator or freezer has had a chance to reach its selected temperature.
	Refrigerator has recently been disconnected for a period of time.	A refrigerator requires several hours to cool down completely.
Temperature in the refrigerator is too warm but the freezer temperature is satisfactory.	Refrigerator control is set too warm.	Adjust the refrigerator control to a colder setting.

Occurrence	Possible Cause	Solution
Sound and Noise		
Louder sound levels when Refrigerator is on.	Today's refrigerators have increased storage capacity and maintain more even temperatures.	It is normal for sound levels to be higher.
Louder sound levels when compressor comes on.	Refrigerator operates at higher pressures during the start of the ON cycle.	This is normal. The sound will level off as the refrigerator continues to run.
Vibrating or rattling noise.	Floor is uneven or weak. Refrigerator rocks on the floor when it is moved slightly.	Be sure floor is level and solid and can adequately support refrigerator.
	Items placed on the top of the refrigerator are vibrating.	Remove items.
	Dishes are vibrating on the shelves in the refrigerator.	It is normal for dishes to vibrate slightly. Move dishes slightly. Make sure refrigerator is level and firmly set on floor.
	Refrigerator is touching wall or cabinets.	Move refrigerator so that it does not touch the wall or refrigerator.
Water/Moisture /Ice Inside Refrigerator		
Moisture collects on the inside walls of the refrigerator.	The weather is hot and humid which increases the rate of frost buildup and internal sweating.	This is normal.
	Door is slightly open.	See problem section Opening/Closing of doors.
	Door is opened too often or too long.	Open the door less often.
Water/Moisture/Ice Outside Refrigerator		
Moisture forms on the outside of the refrigerator or between doors.	Weather is humid.	This is normal in humid weather. When humidity is lower, the moisture should disappear.
	Door is slightly open, causing cold air from the inside the refrigerator to meet warm air from the outside.	Close the door completely.
Moisture forms on the dispenser or refreshment center	Moisture may be formed in high temperature and high humidity since heater turns off if not opening the doors for a long time.	Wipe the moisture and open the doors again.

Occurrence	Possible Cause	Solution
Odors in Refrigerator	Interior needs to be cleaned.	Clean interior with sponge, warm water, and baking soda. Be sure the soda is completely dissolved so it will not act as an abrasive compound.
	Food with strong odor is in the refrigerator.	Cover food completely.
	Some containers and wrapping materials produce odors.	Use a different container or brand of wrapping materials.
Opening/Closing of Doors/Drawers		
Door(s) will not close.	Food package is keeping door open.	Move packages that keep door from closing.
Door(s) will not close.	Door was closed too hard, causing other door to open slightly.	Close both doors gently.
	Refrigerator is not level. It rocks on the floor when it is moved slightly.	Adjust the height adjusting screw.
	Floor is uneven or weak. Refrigerator rocks on the floor when it is moved slightly.	Be sure floor is level and can adequately support refrigerator. Contact carpenter to correct sagging or sloping floor.
	Refrigerator is touching wall or cabinets.	Move refrigerator.
Drawers are difficult to move.	Food is touching shelf on top of the drawer	Keep less food in drawer.
	Track that drawer slides on is dirty.	Clean drawer and track.
Dispenser		
Dispenser will not dispense ice	Ice storage bin is empty.	When the first supply of ice is dropped into the bin, the dispenser should operate.
	Freezer temperature is set too warm.	Turn the freezer control to a higher setting so that ice cubes will be made. When the first supply of ice is made, the dispenser should operate.
	Household water line valve is not open.	Open household water line valve and allow sufficient time for ice to be made. When ice is made, dispenser should operate.
	Refrigerator or freezer door is not closed.	Be sure both doors are closed.

Occurrence	Possible Cause	Solution
Dispenser will not dispense ice.	Ice has melted and frozen around auger due to infrequent use, temperature fluctuations, and/or power outages.	Remove ice storage bin, and thaw and the contents. Clean bin, wipe dry, and replace in proper position. When new ice is made, dispenser should operate.
Ice dispenser is jammed.	Ice cubes are jammed between the ice maker arm and back of the bin.	Remove the ice cubes that are jamming the dispenser.
	Ice cubes are frozen together.	Use the dispenser often so that cubes do not freeze together.
	Ice cubes that have been purchased or made in some other way have been used in the dispenser.	Only the ice cubes made by the ice maker should be used with the dispenser.
Dispenser will not dispense water.	Household water line valve is not open.	Open household water line valve.
	Refrigerator or freezer door is not closed.	Be sure both doors are closed.
Water has an odd taste and/or odor.	Water has been in the tank for too long.	Draw and discard 7 glasses of water to freshen the supply. Draw and discard an additional 7 glasses to completely rinse out tank.
	Unit not properly connected to cold water line.	Connect unit to cold water line which supplies water to kitchen faucet.
Sound of ice dropping	This sound is normally made when automatically made ice is dropped into ice storage bin. Volume may vary according to refrigerator's location.	
Sound of water supply	This sound is normally made when ice maker is supplied with water after dropping the automatically made ice.	
Other	Please thoroughly read Automatic Icemaker and Dispenser in this manual.	



LG Electronics Inc.

LG Twin Tower, 20, Yoido-Dong,
Youngdungpo-Gu, Seoul, 150-721, Korea.
<http://www.lge.com>