



LG Window-Type Air Conditioner

OWNER'S MANUAL

LG

ENGLISH

ITALIANO

ESPAÑOL

FRANÇAIS

DEUTSCH

IMPORTANT

Please read through this manual. It contains valuable information about your air conditioner. This manual may help save time and money by explaining proper product maintenance and preventing improper use.

PRECAUTIONS

Pay close attention to precautions in order to prevent potential hazards and damage from misuse or improper installation. LG is not responsible for any damages caused by misuse of the product.

Model: W06LC W06LH W06LCR W06LHR W06AC W06ACR
W07LC W07LH W07LCR W07LHR W07AC W07ACR
W08LC W08LH W08LCR W08LHR W08AC W08ACR
W09LC W09LH W09LCR W09LHR W09AC W09ACR
W10LC W10LH W10LCR W10LHR W10AC W10ACR
W12LC W12LH W12LCR W12LHR W12AC W12ACR
W14LC W14LH W14LCR W14LHR W14AC W14ACR
W18LC W18LH W18LCR W18LHR W18AC W18ACR
W22LC W22LH W22LCR W22LHR W22AC W22ACR
W24LC W24LH W24LCR W24LHR W24AC W24ACR

Prior to installation, this air-conditioning unit must be submitted for approval by the utility service which provides electricity (EN 61000-3 Norm.)

TABLE OF CONTENTS

1. Safety Precautions

2. Operating Instructions

3. Care and Maintenance

4. Hardware Installation

5. Common Issues

For Your Records

Write the model and serial numbers here:

Model # _____

Serial # _____

You can find them on a label on the side of each unit.

Dealer's Name _____

Date Purchased _____

Read This Manual

Inside you will find many helpful hints on how to use and maintain your air conditioner properly. Just a little preventive care on your part can save you a great deal of time and money over the life of your air conditioner.

You'll find many answers to common problems in the chart of troubleshooting tips. If you review our chart of **Troubleshooting Tips** first, you may not need to call for service at all.



CAUTION

- Contact the authorized service technician for repair or maintenance of this unit.
- Contact the installer for installation of this unit.
- The air conditioner is not intended for use by young children or invalids without supervision.
- Young children should be supervised to ensure that they do not play with the air conditioner.
- When the power cord is to be replaced, replacement work shall be performed by authorized personnel only.
- Installation work must be performed in accordance with the national wiring standards by authorized personnel only.

Precautions

To prevent injury and property damage, follow these instructions.

⚠ Incorrect operation due to ignoring instructions will cause harm or damage, the seriousness of which is indicated by the following symbols.

	WARNING This symbol shows the possibility of death or serious injury.
	CAUTION This symbol indicates the possibility of injury or damage to property.

	Never Do This
	Always Do This

■ The following items are classified by these symbols.

WARNING

<p> Plug in the power plug properly.</p> <ul style="list-style-type: none"> • Otherwise, it will cause electric shock or fire due to heat generation or electric shock. 	<p> Do not operate or stop the unit by inserting or pulling out the power plug.</p> <ul style="list-style-type: none"> • It will cause electric shock or fire due to heat generation. 	<p> Do not damage or use an unspecified power cord.</p> <ul style="list-style-type: none"> • It will cause electric shock or fire. • In the supply cord is damaged, it must be replaced by the manufacturer or its service agent or a similarly qualified person in order to avoid a hazard. (Y Attachment)
<p> Do not modify power cord length or share the outlet with other appliances.</p> <ul style="list-style-type: none"> • It will cause electric shock or fire due to heat generation. 	<p> Do not operate with wet hands or in damp environment.</p> <ul style="list-style-type: none"> • It may cause electric shock. 	<p> Do not direct airflow at room occupants only.</p> <ul style="list-style-type: none"> • This could damage your health.
<p> Always perform grounding work.</p> <ul style="list-style-type: none"> • No grounding may cause electric shock. 	<p> Do not allow water to run into electric parts.</p> <ul style="list-style-type: none"> • It may cause failure of machine or electric shock. 	<p> Always install air leakage breaker and a dedicated switching board.</p> <ul style="list-style-type: none"> • No installation may cause fire and electric shock accident.
<p> Unplug the unit if strange sounds, smell, or smoke comes from it.</p> <ul style="list-style-type: none"> • It may cause fire and electric shock accident. 	<p> Do not use the socket if it is loose or damaged.</p> <ul style="list-style-type: none"> • It may cause fire and electric shock. 	<p> Do not open the entrance during operation.</p> <ul style="list-style-type: none"> • It may cause electric shock.
<p> Keep firearms away.</p> <ul style="list-style-type: none"> • It may cause fire. 	<p> Do not use the power cord close to the heating tools.</p> <ul style="list-style-type: none"> • It may cause fire and electric shock. 	<p> Do not use the power cord near flammable gas or combustibles, such as gasoline, benzene, thinner, etc.</p> <ul style="list-style-type: none"> • It may cause an explosion or fire.



WARNING

ⓘ **Ventilate before operating air conditioner when gas goes out.**

- It may cause explosion, fire and, burn.

ⓘ **Do not disassemble or modify products randomly.**

- It may cause failure and electric shock.



CAUTION

ⓘ **Never touch the metal parts of the unit when removing the filter.**

- They are sharp and may cause injury.

ⓘ **Do not clean the air conditioner with water.**

- Water may enter the unit and degrade the insulation. It may cause an electric shock.

ⓘ **Ventilate well when used together with a stove, etc.**

- An oxygen shortage may occur.

ⓘ **When cleaning the unit, first make sure the power and breaker are turned off.**

- Since the fan rotates at high speed during operation, it may cause injury.

ⓘ **Do not put a pet or house plant where it will be exposed to direct air flow.**

- This could injure the pet or plant.

ⓘ **Do not use appliance for special purpose such as animals or vegetables, precision machine, or conservation of art articles.**

- It may cause damage of animals or vegetables or loss of property.

ⓘ **Stop operation and close the window in storm or hurricane.**

- Operation with windows opened may cause wetting of indoor and soaking of household furniture.

ⓘ **Hold the plug by the head of the power plug when taking it out.**

- It may cause electric shock and damage.

ⓘ **Turn off the main power switch when not using it for a long time.**

- It may cause failure of product or fire.

ⓘ **Do not place obstacles around the absorption inlet or instead of blowing-out inlet.**

- It may cause failure of appliance or accident.

ⓘ **Ensure that an installation console of the outdoor appliance is not damaged due to the use for a long time.**

- If leaving appliance damaged, there is concern of damage due to the falling of product.

ⓘ **Always insert the filters securely. Clean it once every two weeks.**

- Operation without filters may cause failure.

ⓘ **Do not use strong detergent such as wax or thinner but use a soft cloth.**

- Appearance may be deteriorated due to change of product color or scratching of its surface.

ⓘ **Do not place heavy object on the power cord and take care so that the cord should not be pressed.**

- There is danger of fire or electric shock.

ⓘ **Do not drink water drained from air conditioner.**

- It contains contaminants and will make you sick.

ⓘ **Use caution when unpacking and installing. Sharp edges could cause injury.**

ⓘ **If water enters the product, turn the power switch of the main body of appliance off. After taking the power-plug out from the socket, contact with the service center.**

Preparing for operation

- 1 Contact an installation specialist for installation.
- 2 Plug in the power plug properly.
- 3 Do not use a damaged or non-standard power cord.
- 4 Do not share the same outlet with other appliances
- 5 Do not use an extension cord.
- 6 Do not start/stop operation by plugging/unplugging the power cord.

Usage

- 1 Being exposed to direct airflow for an extended period of time could be hazardous to your health. Do not expose occupants, pets, or plants to direct airflow for extended periods of time.
- 2 Due to the possibility of oxygen deficiency, ventilate the room when used together with stoves or other heating devices.
- 3 Do not use this air conditioner for non-specified special purposes (e.g. preserving precision devices, food, pets, plants, and art objects). Usage in such a manner could harm such property.

Cleaning and maintenance

- 1 Do not touch the metal parts of the unit when removing the filter. Injuries can occur when handling sharp metal edges.
- 2 Do not use water to clean inside the air conditioner. Exposure to water can destroy the insulation, leading to possible electric shock.
- 3 When cleaning the unit, first make sure that the power and breaker are turned off. The fan rotates at a very high speed during operation. There is a possibility of injury if the unit's power is accidentally triggered on while cleaning inner parts of the unit.

Service

For repair and maintenance, contact your authorized service dealer.

Controls

The controls will look like one of the following.

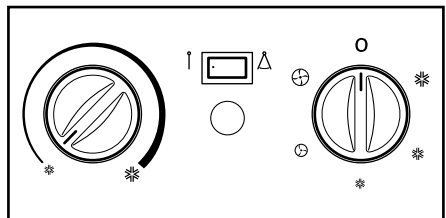
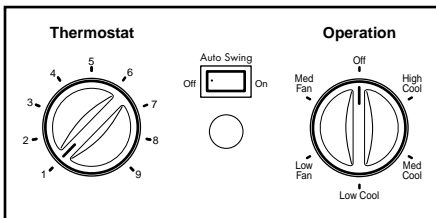
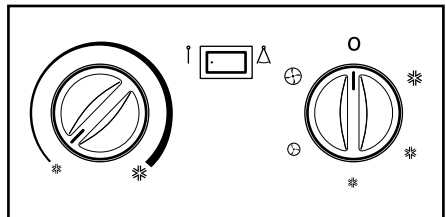
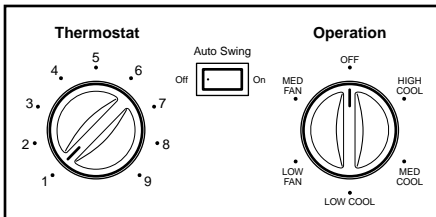
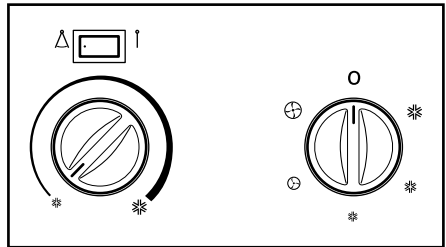
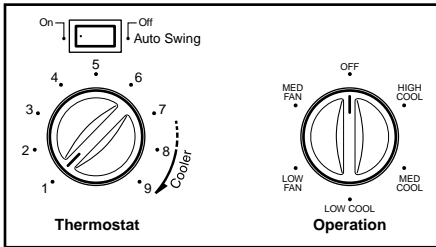
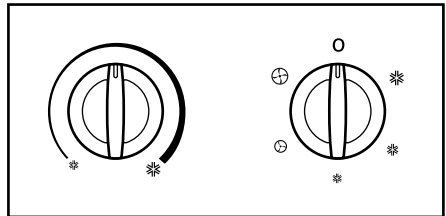
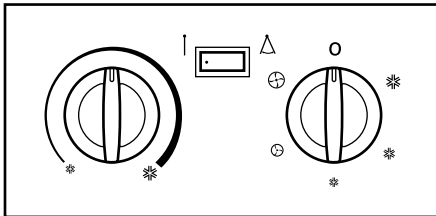
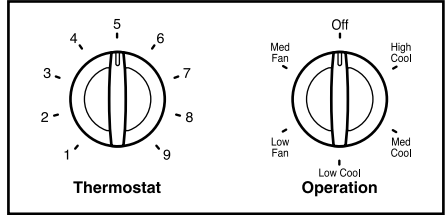
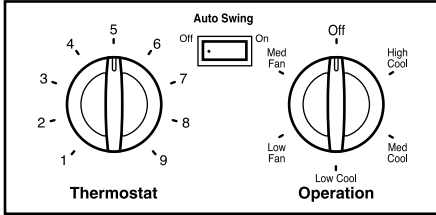

■ OPERATION

High Cool (❄), **Med Cool** (❄) and

Low Cool (❄) provide cooling with different fan speeds. **Med Fan** (⚙) or **Low Fan** (⚙) provides air circulation and filtering without cooling. **Off** (○) turns the air conditioner off.

NOTE: If you move the switch from a cool setting to off or to a fan setting, wait at least 3 minutes before switching back to a cool setting.

Cooling Descriptions

For Normal Cooling- Select **High Cool** or **Med Cool** with the **Operation** knob at the midpoint of **Thermostat** knob.

For Maximum Cooling- Select **High Cool** with the **Operation** knob at the highest number available on your **Thermostat** knob.

For Quieter & Nighttime Cooling- Select **Low Cool** with the **Operation knob** at the midpoint of **Thermostat** knob.

■ THERMOSTAT

The **THERMOSTAT** is used to maintain the room temperature. The compressor will cycle on and off to keep the room at the same level of comfort. When you turn the knob to a higher number(the right side) and the indoor air will become cooler.

The 5 or 6 position (the middle position of arc) is a normal setting for average conditions.

■ AUTO SWING

Auto swing switch controls the horizontal air direction by air swing system (not on all models).

ON (⚙) : Auto swing is operated.

OFF (⚙) : Auto swing is not operated.



CAUTION

When the air conditioner has been performed its cooling operation and is turned off or set to the fan position, wait at least 3 minutes before resetting to the cooling operation again.

Controls

The controls will look like one of the following.

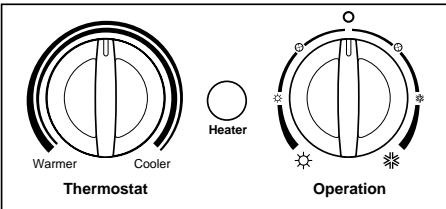
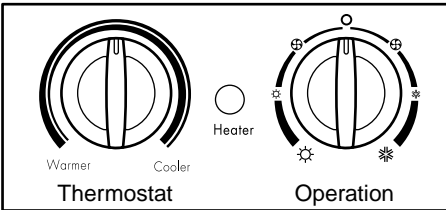
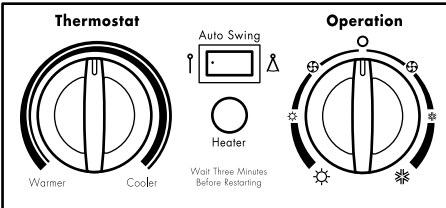
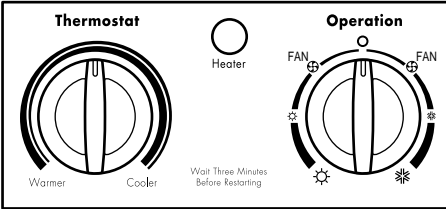

■ AUTO SWING (for some models)

ON () : Air swing is operated while OPERATION knob is set to the COOL or HEAT position.

OFF () : Stops the operation of air swing.

■ THERMOSTAT

Turn the thermostat control to the desired setting. The control position is a normal setting for average conditions. You can change this setting, if necessary, in accordance with your temperature preference.

The thermostat automatically controls cooling or heating, but the fan runs continuously whenever the air conditioner is in operation. If the room is too warm, turn the thermostat control clockwise. If the room is too cool, turn the thermostat control counterclockwise.

■ HEATER () LAMP

When the unit sets heating operation condition, the green lamp is lighted.

When the frost settles on the heat exchanger of the outside, defrosting is made automatically and the green lamp is turned off.

The unit may give a "hiss" and the fan motor stops for 1 to 10 minutes.

This should not be regarded as a problem.

After defrosting, the heating operation begins again.

■ OPERATION

OFF () : Turns the air conditioner off.

LOW FAN () : Permits the low fan speed operation without cooling (heating).

LOW COOL () : Permits cooling with the low fan speed operation.

HIGH COOL () : Permits cooling with the high fan speed operation.

LOW HEAT () : Permits heating with the low fan speed operation.

HIGH HEAT () : Permits heating with the high fan speed operation.



CAUTION

When the air conditioner has been performed its cooling operation and is turned off or set to the fan position, wait at least 3 minutes before resetting to the cooling operation again.

The remote control and control panel will look like one of the following pictures.

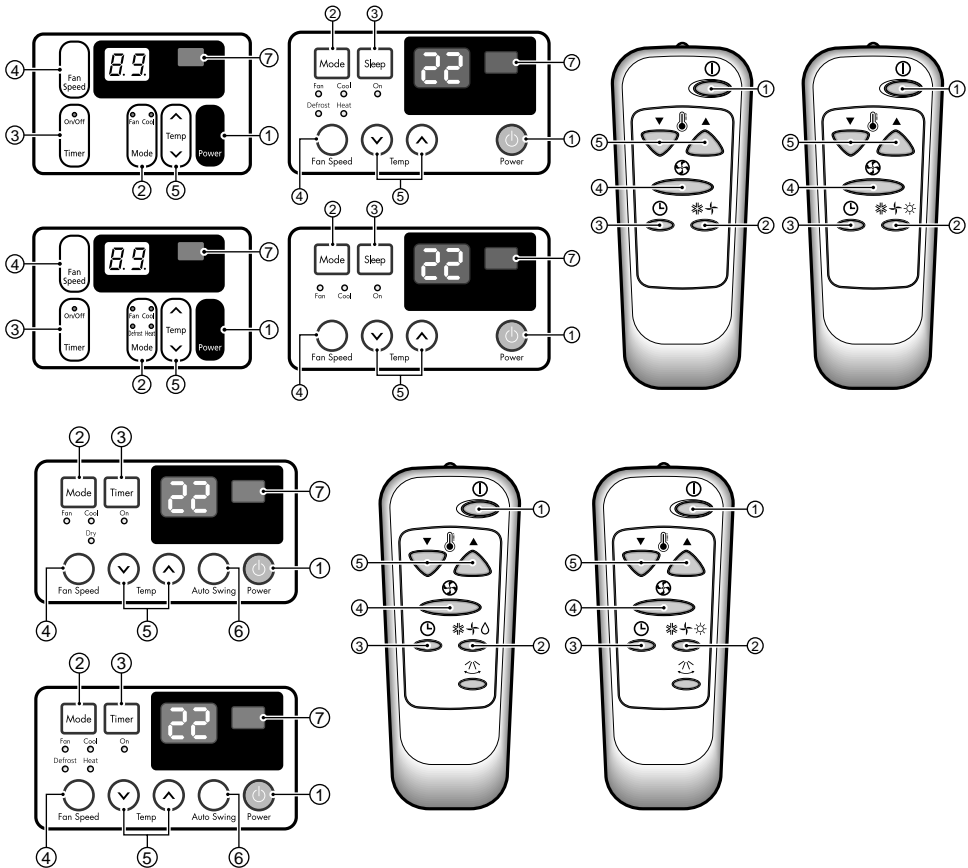

1 POWER

Operation starts when this button is pressed and stops when you press the button again.

2 OPERATION MODE SELECTOR

Heating function is only available in some models.
 Select cooling mode to cool the room.
 Select heating mode to heat the room.
 Select fan mode for basic ventilating fan operation.

3 ON/OFF TIMER

The timer can be set to start and stop the unit in hourly increments (up to 12 hours).
 Temperature increases only by 2°C and no longer increase thereafter.

4 FAN SPEED SELECTOR

For increased power while cooling or heating, select a higher fan speed.

Cooling Model: 3 steps(High[F3] → Low[F1] → Med[F2])

Heating Model: 2 steps(High[F2] → Low[F1])

5 TEMPERATURE CONTROL

The thermostat monitors room temperature to maintain the desired temperature.

The thermostat can be set between 16°C~30°C (61°F~81°F).

The unit takes an average of 30 minutes to adjust the room temperature by 1°C (1.8°F).

6 AUTO SWING BUTTON (available in some models)

Allows the unit to automatically swing its louvers left and right during operation. If the option is de-selected, the louvers will stop in their last position and orient the airflow in the corresponding direction.

7 REMOTE SENSOR

Auto Restart

In case the power comes on again after a power failure, Auto Restarting Operation is the function to operate procedures automatically to the previous operating conditions.

Inserting the Remote Control Batteries

- 1 Push out the cover on the back of the remote control with your thumb
- 2 Pay attention to polarity and insert two new AAA 1.5V batteries.
- 3 Reattach the cover.

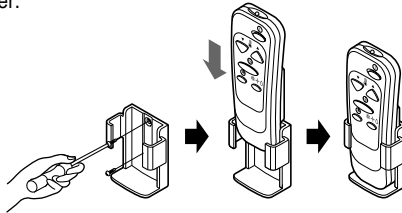

NOTE: Do not use rechargeable batteries. Make sure that both batteries are new.

- In order to prevent discharge, remove the batteries from the remote control if the air conditioner is not going to be used for an extended period of time. Keep the remote control away from extremely hot or humid places. To maintain optimal operation of the remote control, the remote sensor should not be exposed to direct sunlight.
- The remote control can be mounted on a wall using the mountable holder.



Vent Control

The vent control is located above the control knobs.

For maximum cooling efficiency, **CLOSE** the vent. This will allow internal air circulation.

OPEN the vent to discharge stale air.

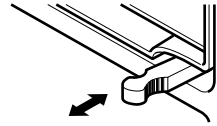

CLOSE  **VENT**  **OPEN**

To open the vent, pull the lever toward you.

To close it, push it in.

Adjusting the air flow Direction

Airflow can be adjusted by changing the direction of the air conditioner's louvers. This can also increase the cooling efficiency of the air conditioner.

Adjusting Horizontal Air Flow Direction

Adjusting the vertical louvers left and right will change horizontal airflow.

Adjusting Vertical Air flow Direction

Adjusting the horizontal louvers up and down will change vertical airflow. The louvers can be adjusted by nudging the back or up and down of the vertical louvers.

Recommended Orientation of louvers

Adjust louvers to face upwards when cooling to maximize cooling efficiency.

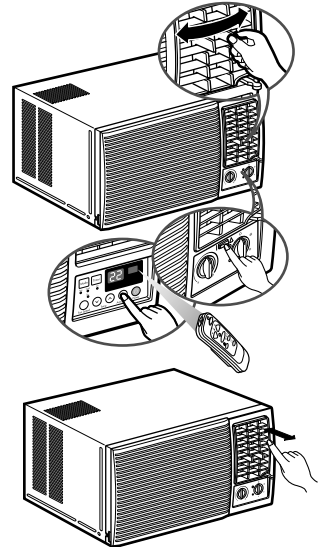

Turn the power off and unplug the power plug before cleaning the air conditioner.

Grille and Case

Use water and mild detergent when cleaning. Do not use bleach or harsh abrasives.

Rear Coils

Check the rear coils on a regular basis. It should be professionally steam-cleaned if it is clogged with dirt or soot. Professional cleaning service is available at your local dealer or service center.

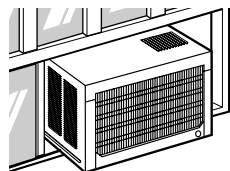

Air Filter

The air filter behind the inlet grille should be checked and cleaned at least once every 2 weeks (or as necessary) to maintain optimal performance of the air conditioner.

How to remove the air filter

- 1 The grille may be opened from the top or bottom for easy maintenance after installation.
- 2 Open the inlet grille by pulling off the exposed door on the bottom or top of the unit (based on installation). Refer to the **Using the reversible inlet grille** in the Hardware Installation Guide section if you want to change the opening side.
- 3 Pull the tab slightly to release the filter. Pull the filter in the same direction as the opening.
- 4 Clean the filter with warm, soapy water. The water should be below 40°C (104°F).
- 5 Rinse off and gently shake off excess water from the filter. Let it dry before replacing it.

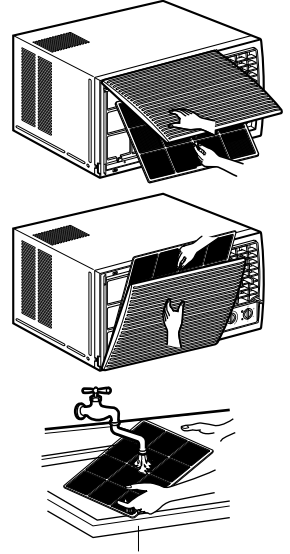

Drainage (Optional)

The base pan may overflow due to high humidity. To drain the excess water, remove the drain cap from the back of the unit and secure the drainpipe.

- 1 Take the drain pan which is shipped in the air discharge or on the barrier.
- 2 Remove the rubber plug from the bottom of the base pan.
- 3 Install the drain pan over the corner of the cabinet where you removed the plug with 4 (or 2) screws.
- 4 Connect the drain hose to the outlet located at the bottom of the drain pan. You can purchase the drain hose or tubing locally to satisfy your particular needs. (Drain hose is not supplied).
- 5 Select the most appropriate connection from among the following figures (by considering the hole of the unit) to fit drain pan to your own unit.

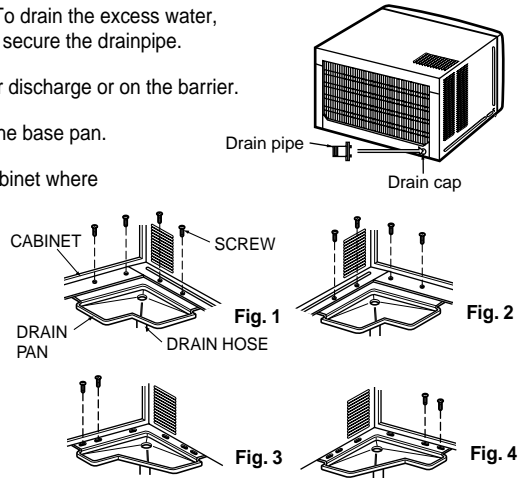

Product Features



CAUTION

This appliance should be installed in accordance with national wiring regulations. This guide acts as a guide to help to explain product features.

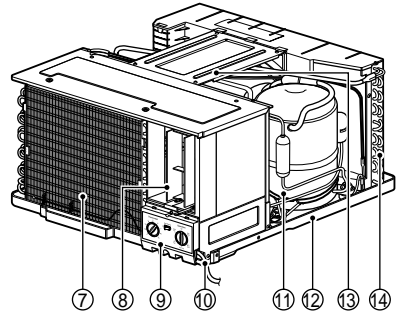
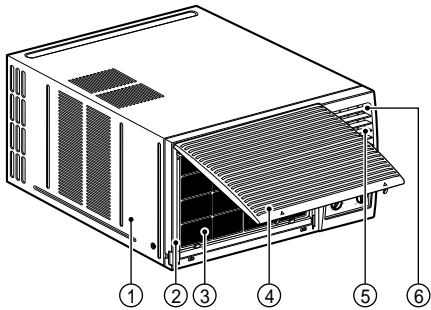
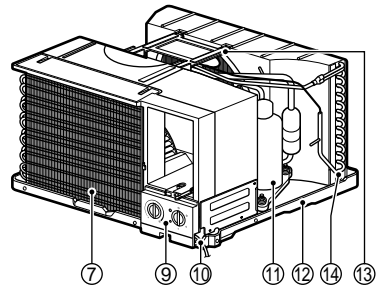
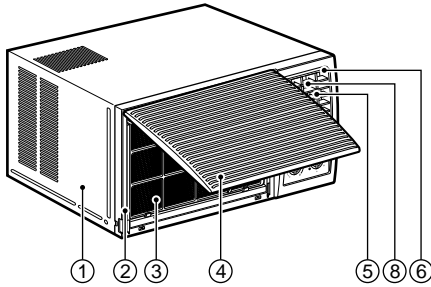

1. CABINET
2. FRONT GRILLE
3. AIR FILTER
4. AIR INTAKE (INLET GRILLE)
5. AIR DISCHARGE
6. VERTICAL AIR DEFLECTOR (HORIZONTAL LOUVER)
7. EVAPORATOR

8. HORIZONTAL AIR DEFLECTOR (VERTICAL LOUVER)
9. CONTROL PANEL
10. POWER CORD
11. COMPRESSOR
12. BASE PAN
13. BRACE
14. CONDENSER

Circuit Breaker Installation and Parts for Installation

Read thoroughly and follow all directions provided.

A circuit breaker must be installed between the power source and the unit if the plug is not used (see illustration below).

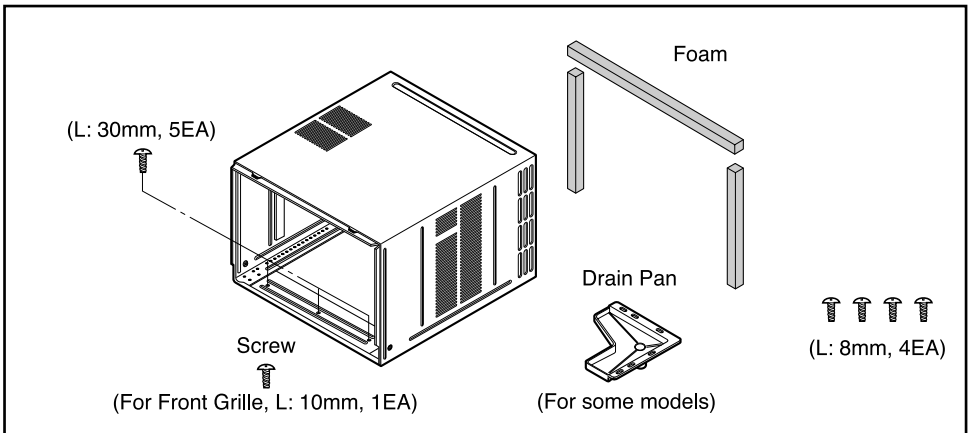
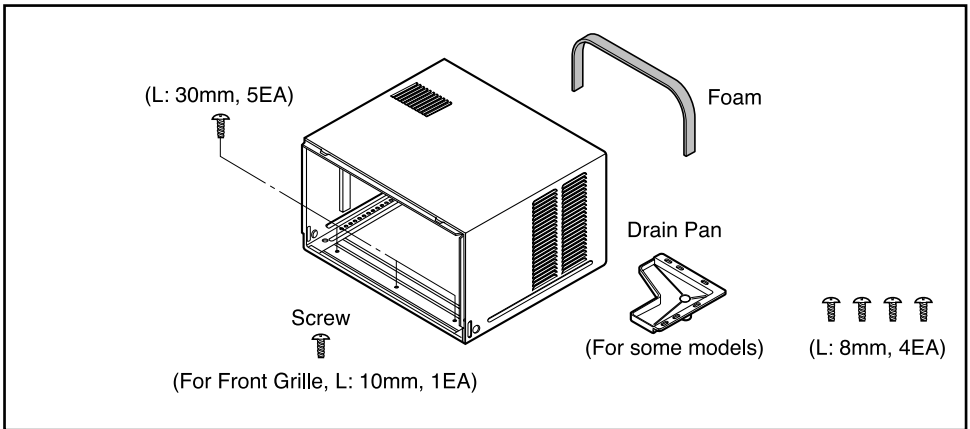
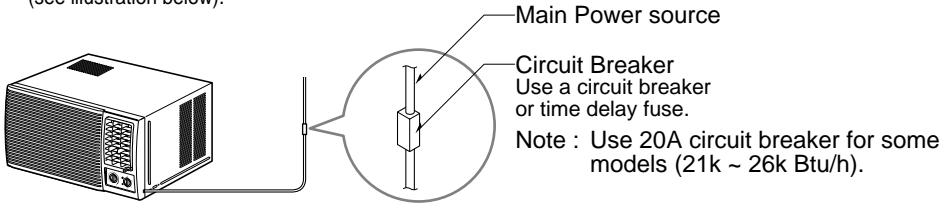

Select the Best Location

- 1 Measure the space for installation to assure a good fit. The air conditioner must be installed firmly into place to prevent vibration and noise.
- 2 Avoid exposure to direct sunlight.
- 3 Remove all obstacles from the rear of the unit. There must be at least 50cm (20in.) of cleared space around the rear of the unit. Obstacles restricting the airflow may reduce the cooling efficiency of the unit.
- 4 The unit should be installed with a slight tilt towards the outside (approx. 3°) to allow condensed water to drain. (About 10-15mm or 1/4 bubble with level)

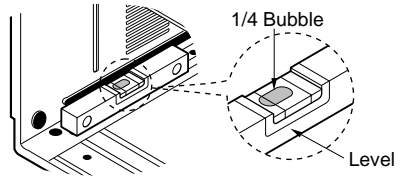
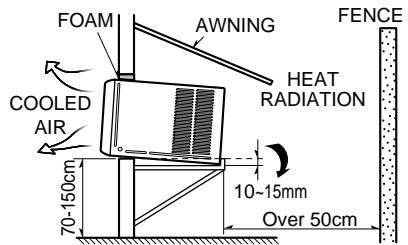

NOTE: The external grille must be exposed outside for air discharge.

Remove the Air Conditioner From the Case

- 1 Remove 2 shipping screws from the back of the case.
- 2 Remove the 2 screws on each side of the case. Keep these for later use.
- 3 Slide out the air conditioner from the case by pulling the base-pan handle while bracing the case.
- 4 Remove the white Styrofoam shipping block from the compressor. (Applicable for some models)

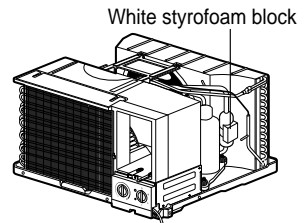
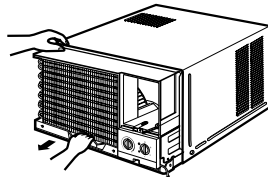
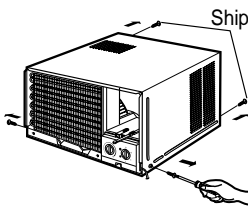

Attaching the Drain Pan (Optional)

The drain pan is used to collect condensed water.

The base-pan may overflow due to high humidity. The base-pan may also collect excess water when in reverse mode (in Reverse Cycle models only). To drain the excess water, remove the drain cap from the back of the unit and secure the drainpipe as follows:

1. Remove the drain pan located in the air discharge or on the barrier.
2. Remove the rubber cap from the hole on the base-pan. (Not applicable to all models)
3. Install the drain pan to the left corner of the cabinet with 2-4 screws.
4. Connect the drain hose to the hole located on the bottom of the drain pan.

You can purchase the drain hose or tubing locally to satisfy your particular needs. (Drain hose not included)

Installation of the Housing

Step 1

Remove the air conditioner from its packaging and slide the air conditioner out of its housing.

Step 2

Prepare the hole in the wall so that the bottom of the housing is well supported, the top has minimum clearance and the air inlet louvers have clearance as shown. Holes from the outside through to the cavity should be sealed. The housing should slope down towards the rear by about 5mm to allow water formed during operation to drain.

Step 3

Install the housing into the wall and secure. Ensure the foam seals are not damaged. Flash, seal or fill gaps around the inside and outside to provide satisfactory appearance and protection against the weather, insects and rodents.

NOTE: UNIT MAY BE SUPPORTED BY A SOLID FRAME FROM BELOW OR BY A HANGER FROM A SOLID OVERHEAD SUPPORT.

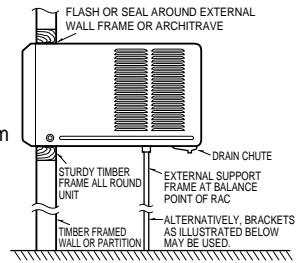

Preferred method of installation into a timber framed wall, partition or window.

Installations of the unit into the Housing

- 1 Slide the unit into the housing until it is firmly against the rear of the housing. Care is required to ensure the foam sealing strips on the housing remain in position.
- 2 Connect the air conditioner to the power and coil excess cord length beneath the air conditioner base or control box.
- 3 Engage the Chassis Lock into the bottom housing rail and secure to the base with the screw provided.
- 4 Remove the front panel from its carton and plastic bag and fit as per the Operating Instruction.
- 5 Switch unit on. Check for operation of the unit and check for vibration in the installation.
- 6 Fit the drain chute to the housing and run a drain line to a suitable location if required.

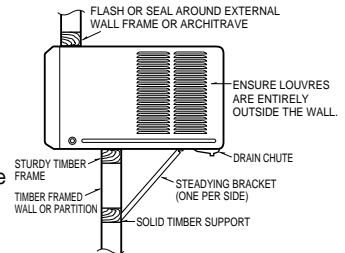

Alternative method of installation if external support cannot be provided.

Installations of the unit into the wall

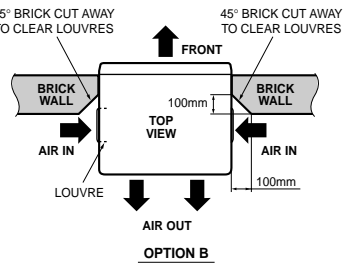
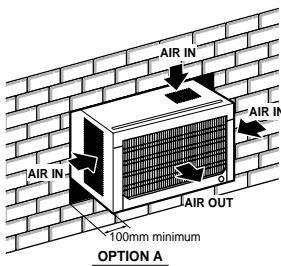

Install the Air Conditioner in the Case

- Slide the air conditioner into the case. Reinstall the 2 screws removed earlier on each side of the case.

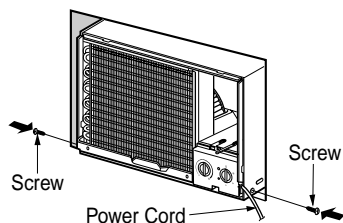

CAUTION: The power cord must be connected to an independent circuit. The green wire must be grounded.

- Stuff the foam between the top of the unit and the wall to prevent air and insects from getting into the room.

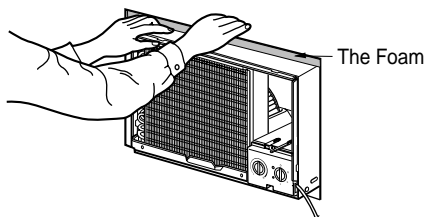

- Before installing the front grille, pull out the vent control lever located above the unit control knobs, as shown. (for some models)

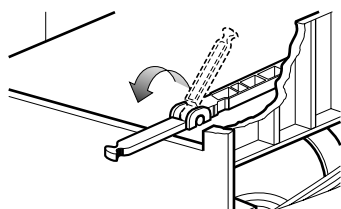

- Attach the front grille to the case by inserting the tabs on the grille into the slots on the front of the case. Push the grille in until it snaps into place. When you detach the front grille from the case, push the grille to your right side and pull it toward you.

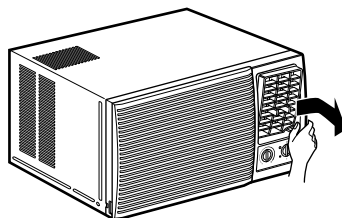
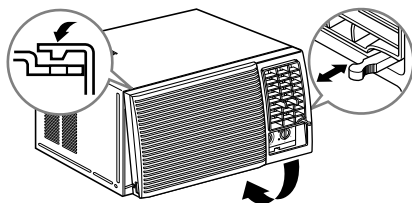

- Lift the inlet grille and secure the front grille with a screw (L:10mm). Lower the inlet grille into place.

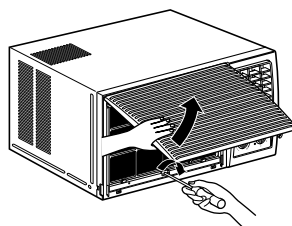
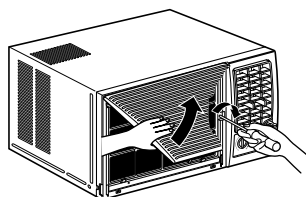

Using the Reversible Inlet Grille (on some models)

Opening the front grille from the top of the unit:

- 1 Disassemble the inlet grille from the front grille. Separate the hinged part by removing the screws using a flat-head screwdriver.
- 2 Turn the inlet grille upside down and insert the hooks into the lower holes of the front grille.
- 3 Insert the filter.

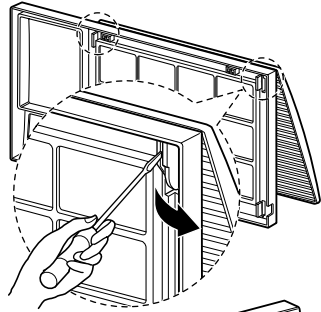

Opening the front grille from the bottom of the unit:

No change is required if you want to remove the filter from the bottom side. (Factory configured)

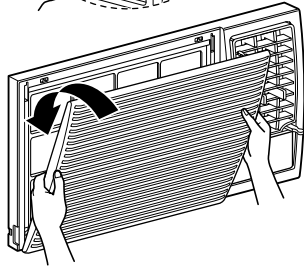

Before calling for service, please review the following list of common problems and solutions.

The air conditioner is operating normally when:

- You hear a pinging noise. This is caused by water being picked up by the condenser on rainy days or in highly humid conditions. This feature is designed to help remove moisture in the air and improve cooling efficiency.
- You hear the thermostat click. This is caused by the compressor cycle starting and stopping.
- You see water dripping from the rear of the unit. Water may be collected in the base pan in highly humid conditions or on rainy days. This water overflows and drips from the rear of the unit.
- You hear the fan running while the compressor is silent. This is a normal operational feature.

The air conditioner may be operating abnormally when:

Problem	Possible Causes	What To Do
The air conditioner does not operate at all	■ The air conditioner is unplugged or not plugged in completely	• Make sure the plug is completely plugged into the outlet
	■ The fuse is blown/circuit breaker is triggered	• Check the fuse/circuit breaker box and replace the fuse or reset the breaker
	■ Power failure.	• In the event of a power failure, set the power control to OFF. When the power is restored, wait 3 minutes to restart the air conditioner to prevent the compressor from overloading
Air conditioner does not cool	■ Air flow is restricted	• Make sure there are no curtains, blinds, furniture or other obstacles in front of the air conditioner
	■ The THERMOSTAT may not be set cool enough	• Turn the knob to a higher setting. The highest setting provides maximum cooling
	■ The air filter is dirty.	• Clean the filter at least every 2 weeks. Refer to the Care and Maintenance section (p.11) of the manual.
	■ The air conditioner was just turned on.	• After the air conditioner is turned on, you need to give the air conditioner some time to cool the room.
	■ Cold air is escaping.	• Check for open furnace floor registers and cold air returns. • CLOSE the air conditioner vent
	■ Cooling coils are iced up	• See “Ice appears on the air conditioner” below
Ice appears on the air conditioner.	■ The cooling coils are iced over.	• Ice may block the air flow and obstruct the air conditioner from properly cooling the room. Set the fan at MED or HIGH while setting the thermostat at 1 or 2 until the ice melts.

