

Installing the Drive

Before installing the drive, turn off the system power.

1 Disconnect the power cord, and remove the cover.

- Remove a vacant 5.25" drive bay panel from the computer. Slide the drive into the drive bay.

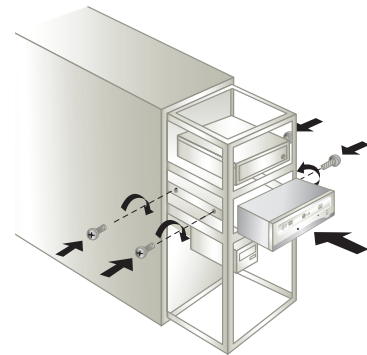
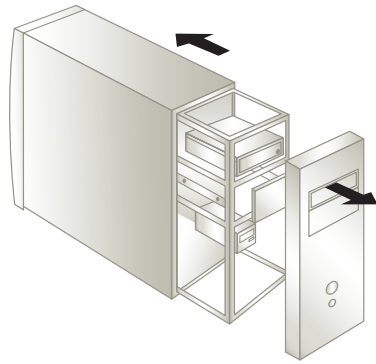
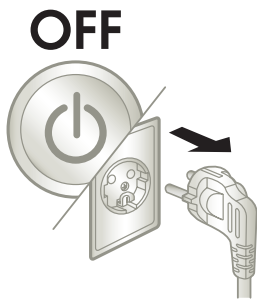

2 Connecting the SATA Power Cable

- Connect the power cable so the projection of the cable connector side to come to the left side. Be careful not to connect upside down.

NOTE:

Improper connection may damage the drive and void the warranty. Generally, the power connector can only fit one way.



- Connect to the power connector of the PC.

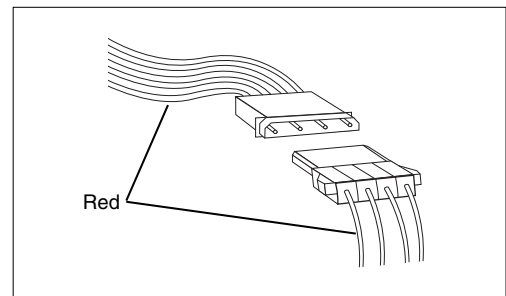

3 Connecting the SATA Data Cable

- Connect the data cable. Be careful not to connect upside down.

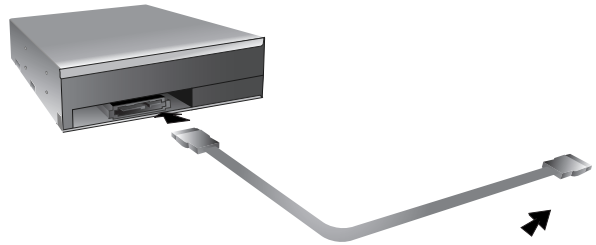

- Connect to the SATA connector on the PC's Motherboard.

4 Replace the cover, connect the power cord and restart your computer.

- Your computer configuration may differ from the illustrations.

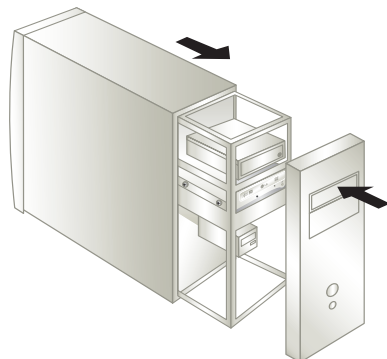
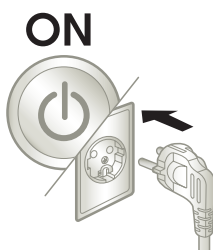
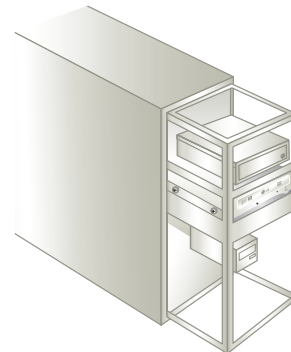



Quick Set-up Guide

Super Multi DVD Rewriter

GSA-H62N
GSA-H62L

To install of your product, please read this guide manual carefully and completely.

Features

- Serial ATA interface.
- Power tray loading and ejection of disc. (The disc can also be ejected manually.)
- Combination CD-R/RW, DVD-R/RW, DVD-R DL, DVD+R/RW, DVD+R DL, DVD-RAM Drive functions into one drive.
- Supports Region playback control Phase II.
- Automatic buffer underrun error prevention technology.
- Supports LightScribe Direct Label Printing Technology - *Optional.
- * You can use a variety of Drive

	GSA-H62L	GSA-H62N
LightScribe	Supported	Not Supported

Package Items

Item	Quantity
- Internal Super Multi DVD Rewriter	1
- Recording & Authoring Software [Nero, InCD, Power Producer, PowerDVD]	1
- SATA Power cable	1
- SATA Data cable	1
- Quick Set-up Guide for Super Multi DVD Rewriter	1

You may experience lower write quality in case if you use disc products by some disc makers which those are not registered with the product's firmware. Therefore, it is recommended that you use only discs by recommended companies. And even if the write session is completed successfully, check the write quality before you put the disc in storage, especially in case of an important data backup. (Manufacturer is not responsible for any loss resulting from data backup failure.)

System Environment

Computer

This unit can be operated in the system environment explained here.

System requirements	CPU: Motherboard that supports Serial ATA. (Recommended Pentium IV 2.4GHz or higher.) RAM:512MB or higher.
VGA Card Memory	128MB or higher.
Hard disk	20GB or more free space. (The free space needed for writing depends on the quantity of data.)
Interface	Serial ATA
Drive bay	5.25-inch half-height bay required
Power	+5V/+12V power socket required
Software Required OS	Windows Vista/Windows 2000 Professional/XP[Home Edition/ Professional/Media Center Edition(SP2)], Direct X 9.0 or Higher is required
CD-R, CD-RW, DVD-R, DVD-RW, DVD+R, DVD+RW, DVD-RAM, DVD±R DL discs	CD-R : LG, Mitsubishi Kagaku Media, Verbatim, Taiyo Yuden or TDK discs are recommended. CD-RW : LG, Ricoh, Mitsubishi Kagaku Media, Verbatim discs are recommended. DVD-R : Maxell, Mitsubishi Kagaku Media, Taiyo Yuden are recommended. DVD-RW : JVC, Mitsubishi Kagaku Media are recommended. DVD+R : Mitsubishi Kagaku Media, Verbatim are recommended. DVD+RW : Mitsubishi Kagaku Media, Verbatim are recommended. DVD-RAM : Maxell, Panasonic are recommended. DVD±R DL : Mitsubishi Kagaku Media, Verbatim are recommended.

* Compatibility problem in write/read function may occur with media depending on the media manufacturing quality.

* For DVD±R 18x support media: Mitsubishi Kagaku Media, That's, Maxell (MID: MAXELL 003, MXL RG04) are recommended.

* Upon the media condition or some of user's environment the maximum speed sometimes could not be guaranteed.

Specifications

Items	
General	
Host Interface	Serial ATA
Supported Discs	DVD-ROM(Single/Dual), DVD-RW, DVD-R, DVD-R Dual layer, DVD+RW, DVD+R, DVD+R Double layer, DVD- RAM, CD-Digital Audio & CD-Extra, CD-Plus, CD-ROM, CD-ROM XA-Ready, CD-I FMV, CD-TEXT, CD-Bridge, CD-R, CD-RW, Photo-CD (Single & Multi-Session), Video CD, DVD-VIDEO
Disc Diameter	12cm/ 8cm (8cm disc can be used only with drive placed horizontally.)
Mounting direction	Horizontal/Vertical
Read/Write Speed	
Write	(CD-R) : 4X, 8X, 16X, 24X, 32X, 40X, 48X (CD-RW) : 4X, 10X, 16X, 24X, 32X (DVD-R) : 2X, 4X, 8X, 16X, 18X (DVD-RW) : 1X, 2X, 4X, 6X (DVD+R) : 2.4X, 4X, 8X, 12X, 16X, 18X (DVD+RW) : 2.4X, 4X, 6X, 8X (DVD-RAM) : 2X, 3X, 3X-5X(Ver.2.2), 6x, 6x-8x, 6x-12x (DVD+R DL) : 2.4x, 4x, 6x, 8x, 10x (DVD-R DL) : 2x, 4x, 6x, 8x, 10x
Read	(CD-ROM/R) : 48X max (CD-RW) : 40X max (CD-DA(DAE)) : 40X max (8cm CD) : 10X max (DVD-ROM)(Single/Dual) : 16X/12X max (DVD±-RW) : 13X max (DVD±-R) : 16X max (DVD-VIDEO) : 4.8X max (DVD-RAM) : 12X max (DVD+R DL) : 12X max (DVD-R DL) : 12X max

* The drive's appearance and specifications may change without prior notice.

Items	
Performance	
Data transfer rate	
*Sustained	CD-ROM : 7200 Kbytes/s (48X max) DVD-ROM : 22160 Kbytes/s (16X max)
*Burst(ATAPI)	SATA Gen.1 1.5Gbps
Average Access Time (1/3 Stroke)	CD-ROM : 135msec (Typical) DVD-ROM : 145msec (Typical) DVD-RAM : 270msec (Typical)
Buffer capacity	2 Mbytes
MTBF	100000 Power On Hours (Duty Cycle 10%)
Environmental Level	
When operating	Temperature : 5 °C to 45 °C Humidity : 15% to 80% R.H. (non condensing)
When not operating	Temperature : -30 °C to 60 °C Humidity : 10% to 90% R.H. (non condensing)
Electrical	
Power	DC 5V, DC 12V

Software

Install the appropriate CD Recording Authoring Software before using this unit.
* Please uninstall any previous CD burning software you may have loaded on your PC in order to prevent possible compatibility issues. Once you have installed the application software, you may (if you wish) begin to reinstall previous software, taking note for errors. We recommend using the drive with the latest software as some problems encountered when using the drive can be solved by updating the software.

Please visit www.lgservice.com and install the program, "LG ODD Online F/W update." By using the program, you can automatically check the latest information about FirmWares and update the FirmWare.

Worldwide support : <http://www.LGservice.com>
Worldwide corporate site : <http://www.LGE.com>

Safety Instructions

CAUTION: The laser used in the Super Multi DVD Rewriter can damage your eyes. Do not attempt to open the cover. To reduce the risk of electric shock, do not remove the cover (or back). There are no user-serviceable parts inside. Refer servicing to qualified service personnel. Use of controls or performance of procedures other than those specified herein may result in hazardous radiation exposure.

WARNING: To reduce the risk of fire or electric shock, do not expose this appliance to rain or moisture.

VORSICHT: Der in diesem Super Multi DVD-Laufwerk benutzte Laser kann Ihre Augen schädigen. Versuchen Sie keinesfalls, die Abdeckung zu öffnen. Um die Gefahr eines elektrischen Schocks zu reduzieren, sollten Sie die Abdeckung (oder Rückseite) keinesfalls entfernen. Im Inneren des Geräts befinden sich keine Teile, die vom Benutzer selbst gewartet werden können. Überlassen Sie die Wartung qualifizierten Kundendiensttechnikern. Beachten Sie bei der Benutzung von Bedienelementen und der Durchführung von Prozeduren unbedingt die Anweisungen dieses Handbuchs, da andernfalls gefährliche Strahlung freigesetzt werden kann.

WARNUNG: Setzen Sie das Laufwerk keinesfalls Regen oder Feuchtigkeit aus, um die Gefahr eines Brandes oder elektrischen Schocks zu reduzieren.

ATTENTION: Le faisceau laser utilisé dans ce lecteur/graveur de Super Multi DVD est dangereux pour les yeux. Ne pas tenter d'ouvrir le couvercle. Ne déposer ni la façade, ni le panneau arrière (risque d'électrocution). Aucun élément interne n'est réparable par l'utilisateur. L'utilisation de commandes ainsi que l'exécution de procédures autres que celles spécifiées dans le présent guide risque de provoquer une dangereuse exposition aux radiations.

AVERTISSEMENT: Ne pas exposer ce matériel à la pluie ou à l'humidité (risques d'incendie et d'électrocution).

PERICOLO: Il dispositivo di lettura e scrittura utilizzato in questo masterizzatore utilizza un raggio laser che, se osservato da vicino, può danneggiare la vista. Evitare di smontare il coperchio dell'apparecchio. Al fine di prevenire eventuali folgorazioni, evitare di smontare l'apparecchio. All'interno dell'apparecchio non sono presenti parti che richiedono manutenzione da parte dell'utente. In caso di difetti o guasti, rivolgersi ad un Centro di Assistenza Tecnica. L'esecuzione di procedure diverse da quella espressamente indicate in questo manuale può provocare pericolose esposizioni alle radiazioni laser.

ATTENZIONE: Al fine di evitare cortocircuiti o principi di incendio, evitare di esporre questo apparecchio alla pioggia o ad una eccessiva umidità ambientale.

PRECAUCION: El láser utilizado en la unidad Super Multi DVD puede dañar sus ojos. No intente abrir la tapa. Para reducir el riesgo de descarga eléctrica, no quite la tapa (ni la parte posterior). No hay piezas internas que deba mantener el usuario. El servicio de mantenimiento debe efectuarlo personal técnico cualificado. El uso de controles o la ejecución de procedimientos distintos de los especificados en este manual pueden ser causa de exposición a radiación peligrosa.

ADVERTENCIA: Para reducir el riesgo de fuego o descarga eléctrica, no exponga este aparato a la lluvia ni a la humedad.

CUIDADO: O laser usado no drive Super Multi DVD pode danificar seus olhos. Não tente levantar a tampa. Para reduzir o risco de choque elétrico, não retire a tampa ou a parte traseira. No seu interior, não há partes a serem manuseadas pelo usuário. Consertos ou manutenção devem ser feitos somente pelo Serviço Autorizado LG. O uso dos controles ou a execução de procedimentos diferentes que não sejam os especificados neste manual podem resultar em exposição perigosa à radiação.

AVISO: Para reduzir o risco de incêndio ou choque elétrico não exponha este aparelho à chuva ou humidade.

This product is manufactured to comply with the radio interference requirements of EEC DIRECTIVE 89/336/EEC, 93/68/EEC and 2006/95/EC.

Dieses Produkt erfüllt die Funkstörungsanforderungen folgender Normen: 89/336/EEC, 93/68/EEC und 2006/95/EC.

Ce produit a été fabriqué conformément aux prescriptions EEC DIRECTIVE 89/336/EEC, 93/68/EEC et 2006/95/EC.

Questo prodotto risponde alle direttive CEE 89/336, 93/68 e 2006/95/EC, relative alla compatibilità elettromagnetica.

Este producto ha sido fabricado cumpliendo los requisitos sobre interferencias de radio de la DIRECTIVAS CEE 89/336/CEE, 93/68/CEE y 2006/95/EC.

CLASS 1	LASER PRODUCT
KLASSE 1	LASER PRODUKT
LUOKAN 1	LASER LAITE
KLASS 1	LASER APPARAT
CLASE 1	PRODUCTO LÁSER
CLASSE 1	PRODOTTO LASER

CAUTION: CLASS 3B VISIBLE AND INVISIBLE LASER RADIATION WHEN OPEN. AVOID EXPOSURE TO THE BEAM.

ADVARSEL: KLASSE 3B SYNLIG OG USYNLIG LASERSTRÅLING VED ÅBNING. UNDGA UDSÆTTELSE FOR STRÅLING.

ADVARSEL: KLASSE 3B SYNLING OG USYNLIG LASERSTRÅLING NÅR DEKSEL ÅPENS. UNNGÅ EKSPONERING FOR STRÅLEN.

WARNING: KLASSE 3B SYNLING OCH OSYNLIG LASERSTRÅLNING NÅR DENNALL DEL ÄR ÖPPNAD. STRÅLEN ÄR FARLIG.

VARO! KURSSI 3B NÄKYVÄ JA NÄKYMÄTÖN AVATTAESSA OLET ALTTIINA LASERSÄTEILYLLE. ÄLÄ KATSO SÄTEESEN.

The appliance is not intended for use by young children or infirm persons without supervision.

Industry Canada requirement

This class B digital apparatus complies with Canadian ICES-003.

Cet appareil numérique de la classe B est conforme à la norme NMB-003 du Canada.

FCC COMPLIANCE STATEMENT

Note: This equipment has been tested and found to comply with the limits for a Class B digital device, pursuant to Part 15 of the FCC Rules. These limits are designed to provide reasonable protection against harmful interference in a residential installation. This equipment generates, uses, and can radiate radio frequency energy and, if not installed and used in accordance with the instructions, may cause harmful interference to radio communications. However, there is no guarantee that interference will not occur in a particular installation. If this equipment does cause harmful interference to radio or television reception, which can be determined by turning the equipment off and on, the user is encouraged to try to correct the interference by one or more of the following measures:

- Reorient or relocate the receiving antenna.
- Increase the separation between the equipment and receiver.
- Connect the equipment into an outlet on a circuit different from that to which the receiver is connected.
- Consult the dealer or an Authorized Service Center for help.

- **FCC WARNING**
Changes or modifications not expressly approved by the party responsible for compliance could void the user's authority to operate the equipment.
- This Super Multi DVD Rewriter is for use only with UL listed personal computers that have installation instructions detailing user-installation of card cage accessory.

■ Microsoft® and Windows® are trademarks registered in the United States and other countries by the Microsoft Corporation.

■ The company names and product names written in this manual are trademarks or registered trademarks of the respective companies.