



LCD TV | PLASMA TV OWNER'S MANUAL

LCD TV MODELS

26LC2R*
27LC2R*
32LC2R*
32LC25R*
26LC3R*
32LC3R*
32LX2R*
32LE2R*
37LE2R*
42LE2R*

PLASMA TV MODELS

42PC1RV*
42PC3RV*
42PC3RA*

Please read Information Manual included together before reading this manual and operating your set.

Retain it for future reference.

Record model number and serial number of the set.

See the label attached on the back cover and quote this information to your dealer when you require service.

ENGLISH

DEUTSCH

FRANÇAIS

ITALIANO

ESPAÑOL

PORTUGUÊS

NEDERLANDS

Ελληνικά

ACCESSORIES

Ensure that the following accessories are included with your TV. If an accessory is missing, please contact the dealer where you purchased the product.

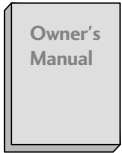

Owner's Manual



Batteries

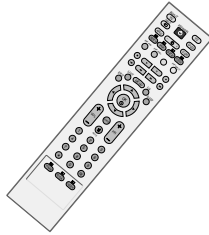

Remote Control

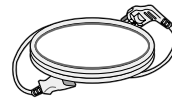

Power Cord

For 42PC1RV*, 42PC3RV*, 42PC3RA*



2-Wall brackets



2-eye-bolts



2-bolts for stand assembly
Refer to p.12
This feature is not available for all models.

For 26LC2R*, 27LC2R*, 32LC2R*, 32LC25R*, 26LC3R*, 32LC3R*, 32LX2R*, 32LE2R*, 37LE2R*, 42LE2R*



2-TV brackets
2-Wall brackets



Twister Holder
Arrange the wires
with the twister holder.

26LC3R*, 32LC2R*,
32LC25R* only



4-bolts for stand assembly

26LC2R*, 27LC2R*, 32LC2R*,
32LC25R*, 32LE2R*, 37LE2R*,
42LE2R*



Cable
Management



2-bolts

26LC3R*, 32LC3R*



Cable
Management

CONTENTS

ACCESSORIES 1

INTRODUCTION

Controls / Connection Options	4-9
Remote Control Key Functions	11-12
Installing Batteries	12

INSTALLATION

Stand Installation	13-14
Basic Connection / How to Remove the Cable Management	15-17
How to join the product assembly to the wall to protect the set tumbling	19

CONNECTIONS & SETUP

Antenna Connection	20
VCR Setup	21-22
External Equipment Connections	23
DVD Setup	24-25
HDSTB Setup	26-27
PC Setup	28-29
Turning the TV On	30-31

SPECIAL FUNCTIONS

PIP (Picture-In-Picture)

Watching PIP	32
Programme Selection for Sub Picture	32
Input Source Selection for Sub Picture	32
Sub Picture Size Adjustment (PIP mode only) ..	32
Moving the Sub Picture (PIP mode only) ..	32

Teletext

Teletext Language Selection	33
Switch on/off	33
SIMPLE Text	33
TOP Text	34
FASTEXT	34
Special Teletext Functions	35

TV MENU

On Screen Menus Selection and Adjustment . . .	36
--	----

Setting up TV stations

Auto programme tuning	37
Manual programme tuning	38
Fine tuning	39
Assigning a station name	40
Programme edit	41
Favourite programme	42
Calling the programme table	43

Picture Menu Options

PSM (Picture Status Memory)	44
Picture Adjustment (PSM-User option)	45
CSM (Colour Status Memory)	46
Manual Colour Temperature Control (CSM - User option)	47
XD Function	48
ADVANCED-CINEMA	49
ADVANCED-BLACK LEVEL	50
Reset	51

Sound Menu Options

SSM (Sound Status Memory)	52
Sound Frequency Adjustment (SSM - User option)	53
AVL (Auto Volume Leveler)	54
Balance Adjustment	55
Speaker	56
Stereo/Dual Reception	57
NICAM Reception	58
Speaker Sound Output Selection	58

Time Menu Options

Clock Setup	59
On/Off Time	60
Auto Sleep	61
Sleep Timer	61

Special Menu Options

Child Lock	62
ISM (Image Sticking Minimization) Method ..	63
Low Power	64
XD Demo	65

TV MENU

Screen Menu Options

Auto Configure (RGB [PC] mode only)	66
Manual Configure	67
Setting the Picture Format	68-69
Selecting Wide VGA/XGA mode	69
Initializing (Reset to original factory settings)	70

APPENDIX

Programming the Remote	71
Programming code	71-72
Troubleshooting Checklist	73-74
Maintenance	75
Product Specifications	76-77

INTRODUCTION

CONTROLS

This is the front panel of models 42PC1RV* TVs.

- This is a simplified representation of the front panel. Here shown may be somewhat different from your TV.

Front Panel Controls

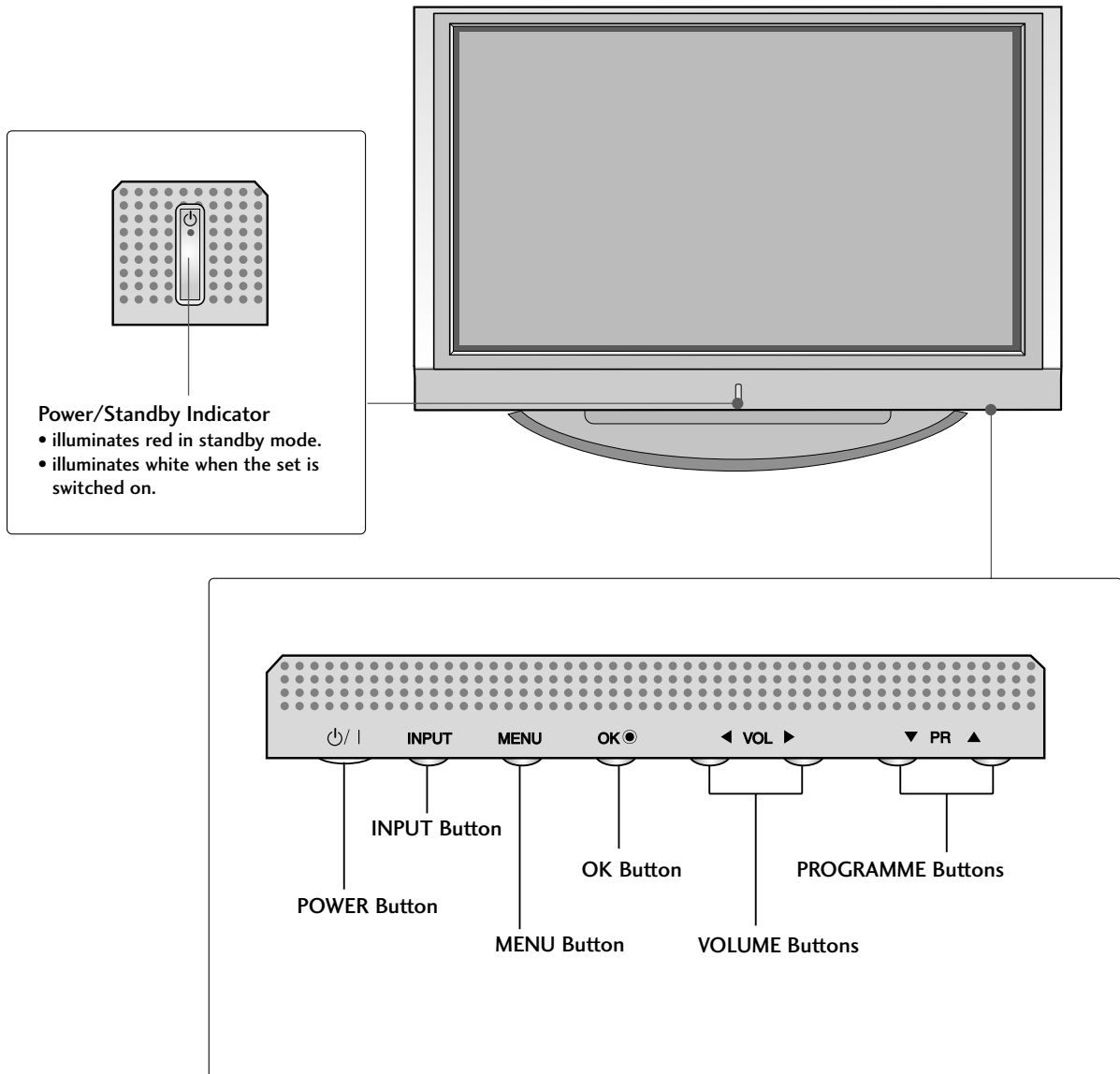

This is the front panel of models 42PC3RV*, 42PC3RA* TVs.

- This is a simplified representation of the front panel. Here shown may be somewhat different from your TV.

Front Panel Controls

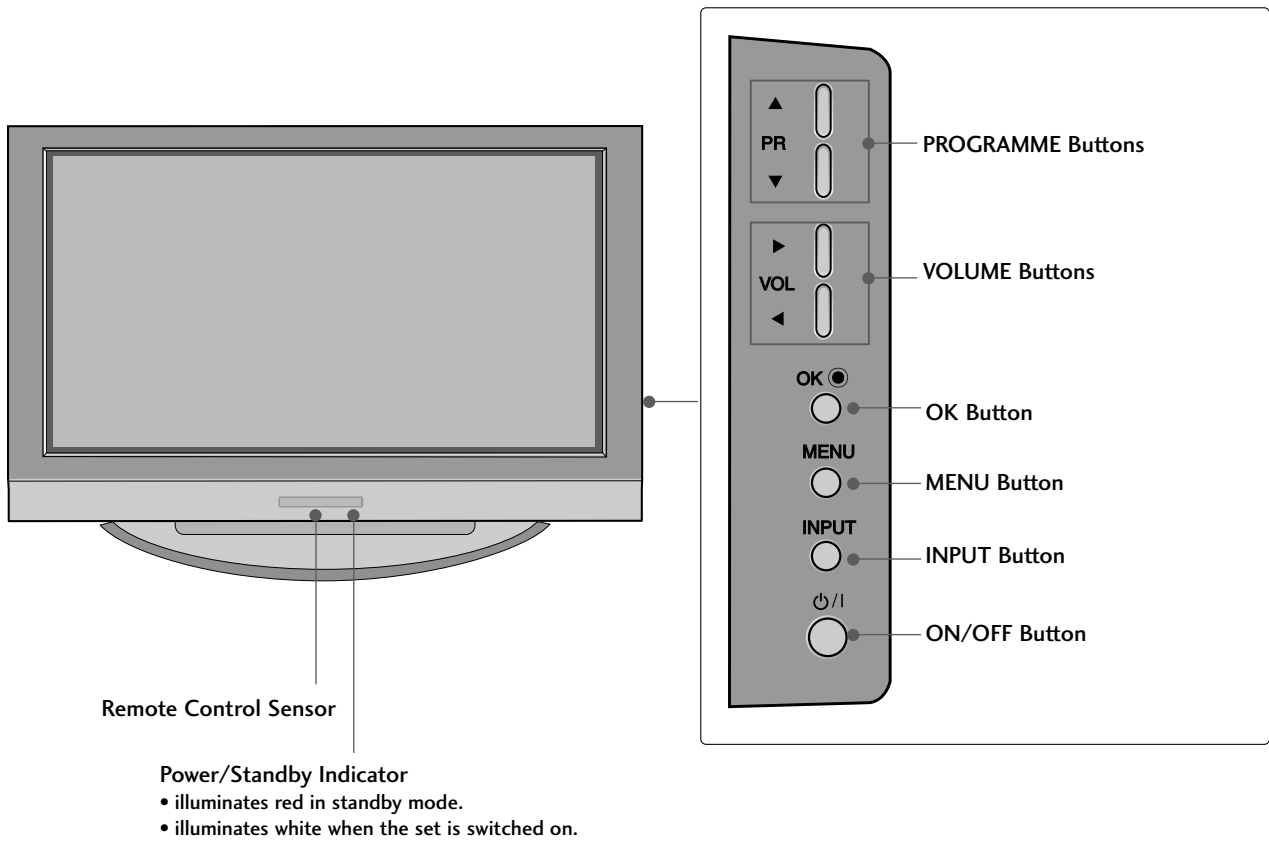

INTRODUCTION

CONNECTION OPTION

This is the back panel of models 42PC1RV*, 42PC3RV*, 42PC3RA* TVs.

Back Connection Panel

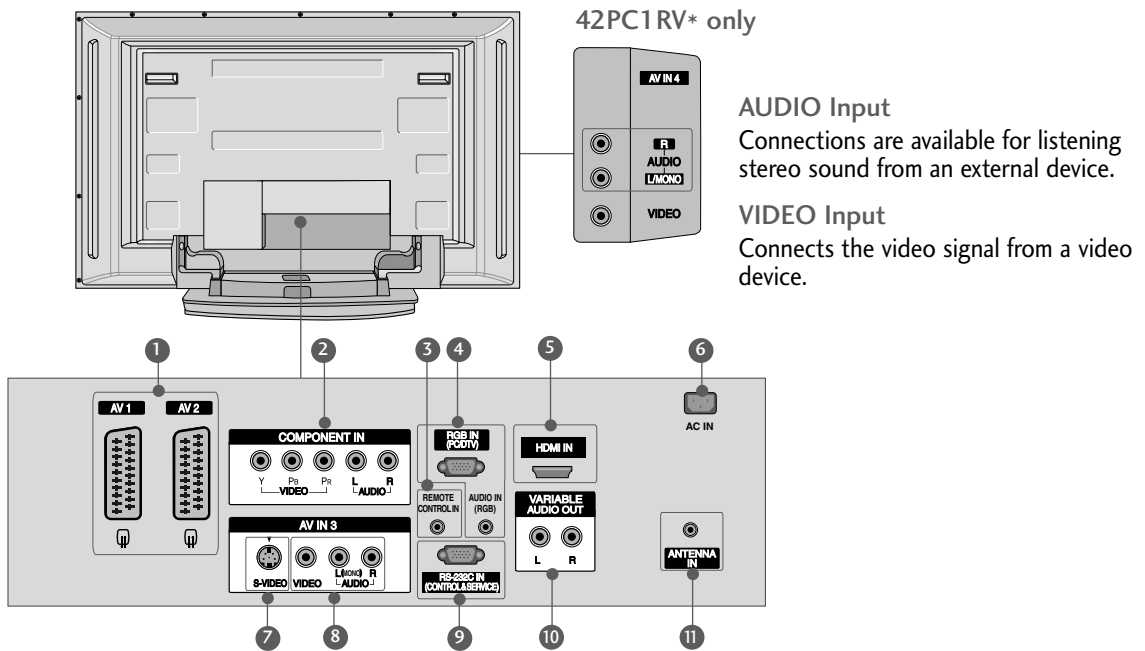

- 1 Euro Scart Socket (AV1/AV2)**
Connect scart socket input or output from an external device to these jacks.
- 2 Component Input**
Connect a component video/audio device to these jacks.
- 3 Remote Control Port**
Connect your wired remote control here.
- 4 RGB/Audio Input**
Connect the monitor output from a PC to the appropriate input port.
- 5 HDMI Input**
Connect a HDMI signal to HDMI port with HDMI cable.
- 6 Power Cord Socket**
This TV operates on an AC power. The voltage is indicated on the Specifications page. Never attempt to operate the TV on DC power.
- 7 S-Video Input**
Connect S-Video out from an S-VIDEO device.
- 8 Audio/Video Input**
Connect audio/video output from an external device to these jacks.
- 9 RS-232C Input (CONTROL&SERVICE) Port**
Connect the serial port of the control devices to the RS-232C jack.
- 10 Variable Audio Output**
Connect an external amplifier or add a subwoofer to your surround sound system.
- 11 Antenna Input**
Connect over-the-air signals to this jack.

This is the front panel of models 26LC2R*, 26LC3R*, 27LC2R*, 32LC2R*, 32LC25R*, 32LC3R*, 32LE2R*, 37LE2R*, 42LE2R* TVs.

■ This is a simplified representation of the front panel. Here shown may be somewhat different from your TV.

Front Panel Controls

26LC2R*, 27LC2R*, 32LC2R*, 32LC25R*, 32LE2R*,
37LE2R*, 42LE2R*

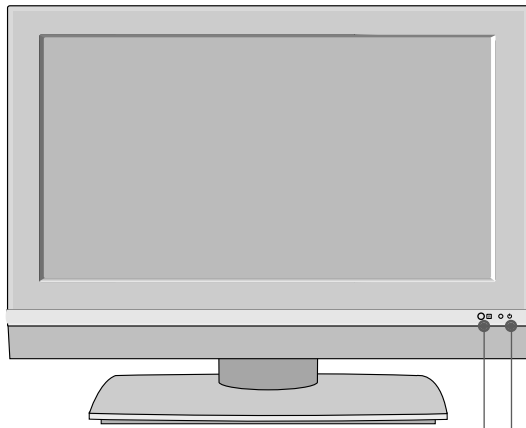

Remote Control Sensor

Power/Standby Indicator

- illuminates red in standby mode.
- illuminates white when the set is switched on.

26LC3R*, 32LC3R*

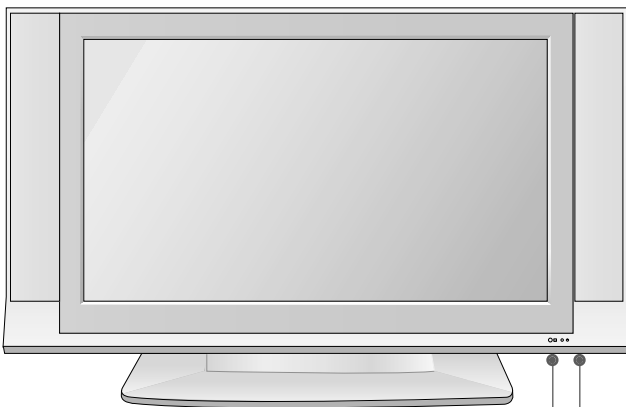

Remote Control Sensor

Power/Standby Indicator

- illuminates red in standby mode.
- illuminates white when the set is switched on.

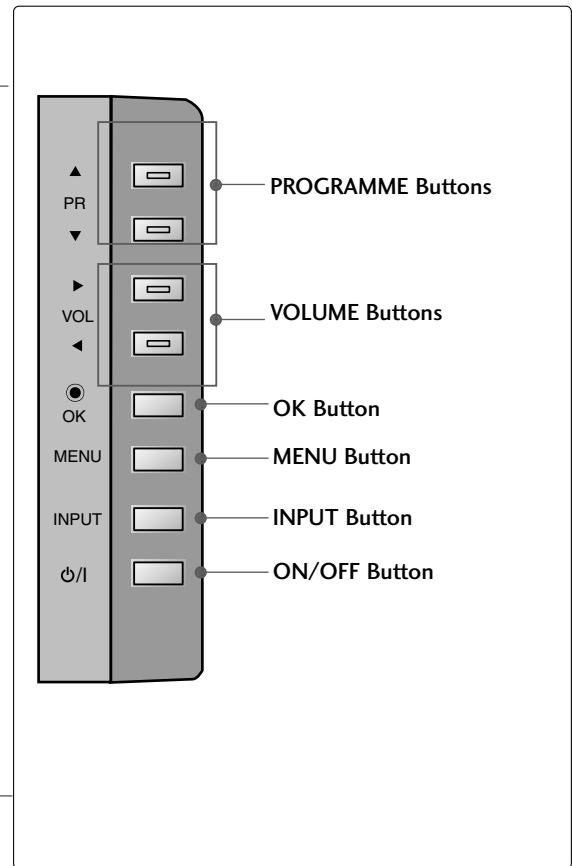

PROGRAMME Buttons

VOLUME Buttons

OK Button

MENU Button

INPUT Button

ON/OFF Button

INTRODUCTION

CONTROLS

This is the front panel of models 32LX2R* TV.

- This is a simplified representation of the front panel. Here shown may be somewhat different from your TV.

Front Panel Controls

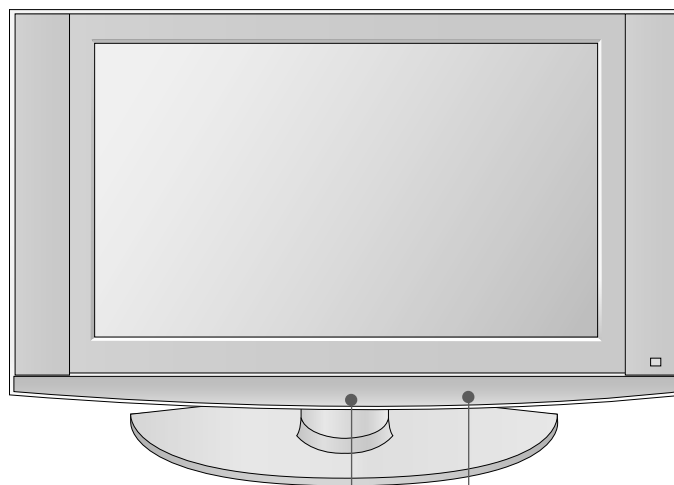

Remote Control Sensor

Power/Standby Indicator

- illuminates red in standby mode.
- illuminates white when the set is switched on.

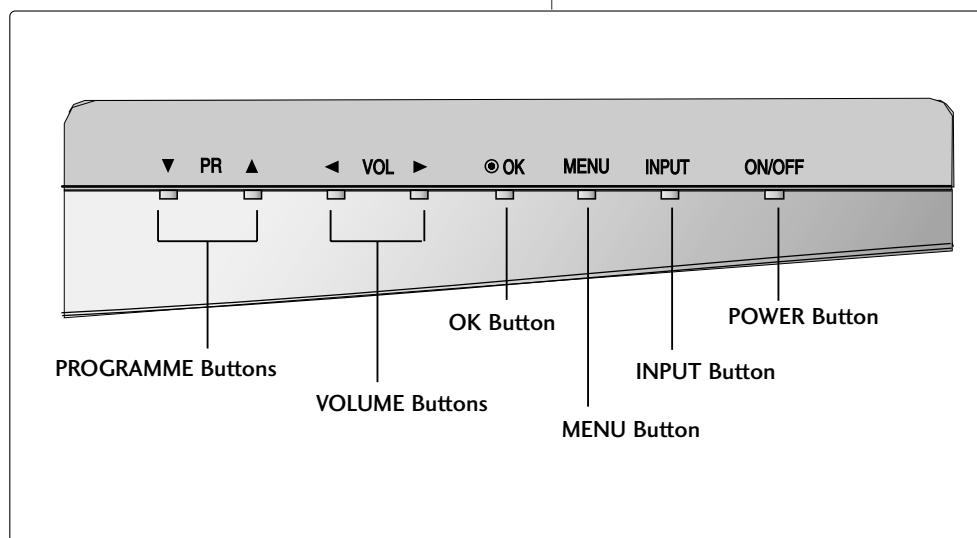

PROGRAMME Buttons

VOLUME Buttons

OK Button

MENU Button

INPUT Button

POWER Button

CONTROLS

This is the back panel of models 26LC2R*, 26LC3R*, 27LC2R* TVs.

Back Connection Panel

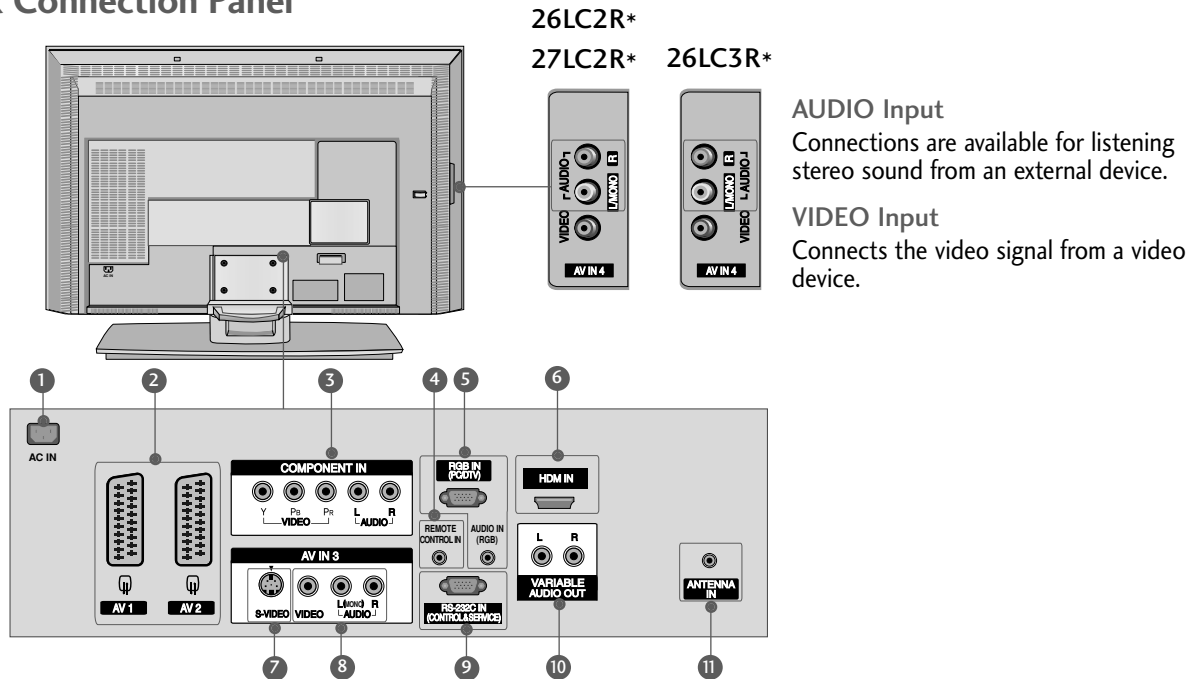

1 Power Cord Socket

This TV operates on an AC power. The voltage is indicated on the Specifications page. Never attempt to operate the TV on DC power.

2 Euro Scart Socket (AV1/AV2)

Connect scart socket input or output from an external device to these jacks.

3 Component Input

Connect a component video/audio device to these jacks.

4 Remote Control Port

Connect your wired remote control here.

5 RGB/Audio Input

Connect the monitor output from a PC to the appropriate input port.

6 HDMI Input

Connect a HDMI signal to HDMI port with HDMI cable.

7 S-Video Input

Connect S-Video out from an S-VIDEO device.

8 Audio/Video Input

Connect audio/video output from an external device to these jacks.

9 RS-232C Input (CONTROL&SERVICE) Port

Connect the serial port of the control devices to the RS-232C jack.

10 Variable Audio Output

Connect an external amplifier or add a subwoofer to your surround sound system.

11 Antenna Input

Connect over-the-air signals to this jack.

AUDIO Input

Connections are available for listening stereo sound from an external device.

VIDEO Input

Connects the video signal from a video device.

INTRODUCTION

CONTROLS

This is the back panel of models 32LC2R*, 32LC25R*, 32LC3R*, 32LX2R*, 32LE2R*, 37LE2R*, 42LE2R* TVs.

Back Connection Panel

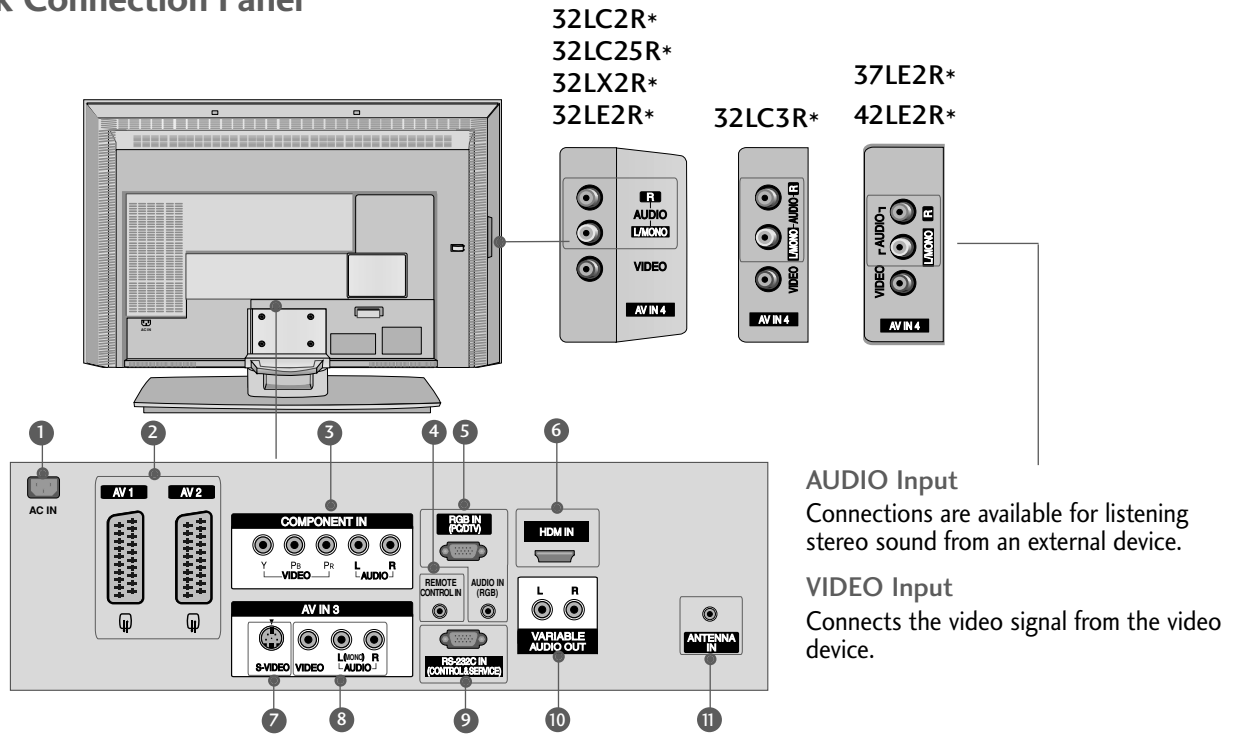

AUDIO Input

Connections are available for listening stereo sound from an external device.

VIDEO Input

Connects the video signal from the video device.

- 1 Power Cord Socket**
This TV operates on an AC power. The voltage is indicated on the Specifications page. Never attempt to operate the TV on DC power.
- 2 Euro Scart Socket (AV1/AV2)**
Connect scart socket input or output from an external device to these jacks.
- 3 Component Input**
Connect a component video/audio device to these jacks.
- 4 Remote Control Port**
Connect your wired remote control here.
- 5 RGB/Audio Input**
Connect the monitor output from a PC to the appropriate input port.
- 6 HDMI Input**
Connect a HDMI signal to HDMI port with HDMI cable.
- 7 S-Video Input**
Connect S-Video out from an S-VIDEO device.
- 8 Audio/Video Input**
Connect audio/video output from an external device to these jacks.
- 9 RS-232C Input (CONTROL&SERVICE) Port**
Connect the serial port of the control devices to the RS-232C jack.
- 10 Variable Audio Output**
Connect an external amplifier or add a subwoofer to your surround sound system.
- 11 Antenna Input**
Connect over-the-air signals to this jack.

REMOTE CONTROL KEY FUNCTIONS

When using the remote control, aim it at the remote control sensor on the TV.

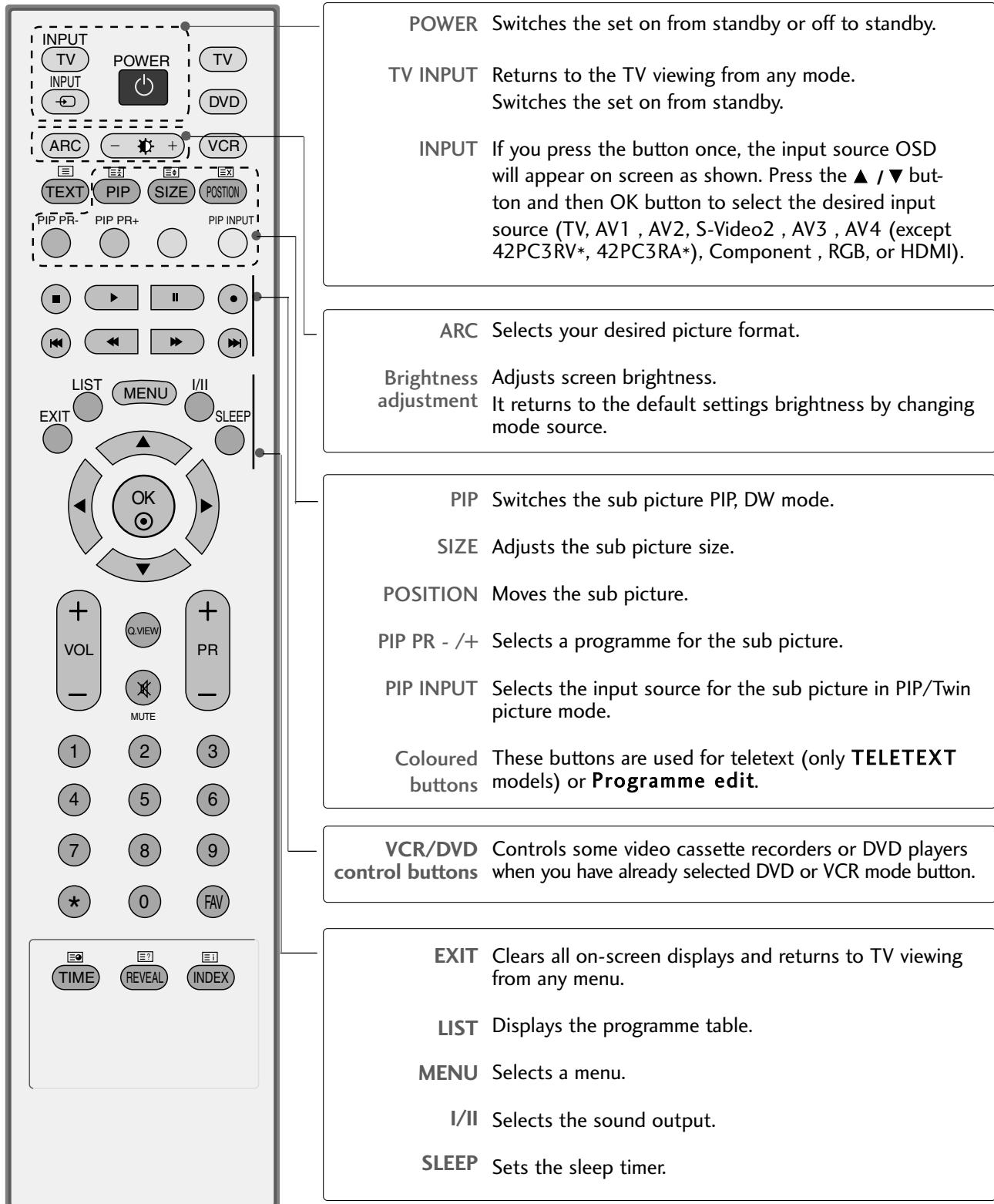

INTRODUCTION

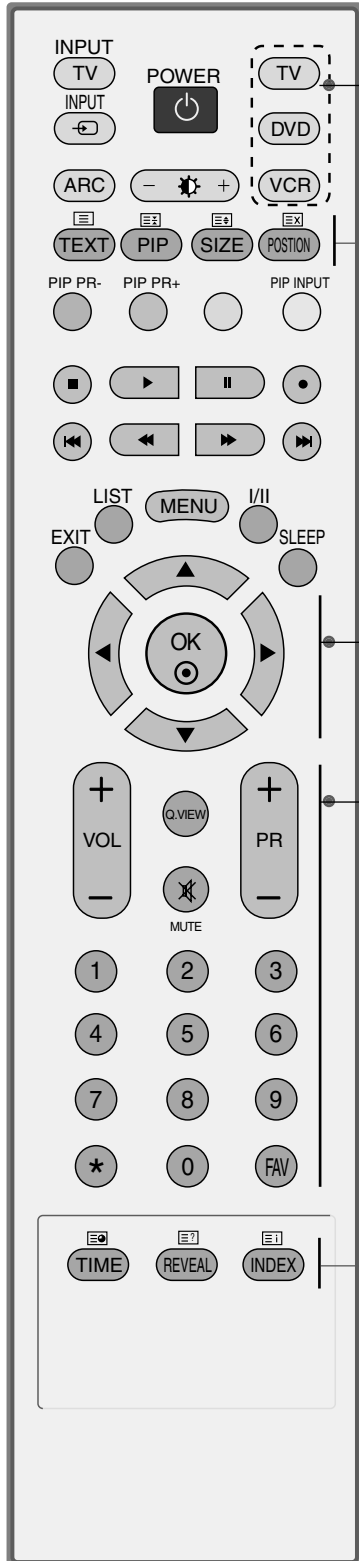

MODE Selects the remote operating modes.

1 TELETEXT BUTTONS These buttons are used for teletext. For further details, see the 'Teletext' section.

1 THUMBSTICK (Up/Down/Left/Right) Allows you to navigate the on-screen menus and adjust the system settings to your preference.
OK Accepts your selection or displays the current mode.

VOLUME UP /DOWN Adjusts the volume.
Q.VIEW Returns to the previously viewed programme.
MUTE Switches the sound on or off.
Programme UP/DOWN Selects a programme.
0~9 number button Selects a programme. Selects numbered items in a menu.
FAV Displays the selected favourite programme.
* No function

1 TIME REVEAL INDEX

INSTALLING BATTERIES

- Open the battery compartment cover on the back side and install the batteries matching correct polarity (+ with +, - with -).
- Install two 1.5V AA batteries. Don't mix old or used batteries with new ones.
- Close cover.

INSTALLATION

STAND INSTALLATION

- This feature is not available for all models.

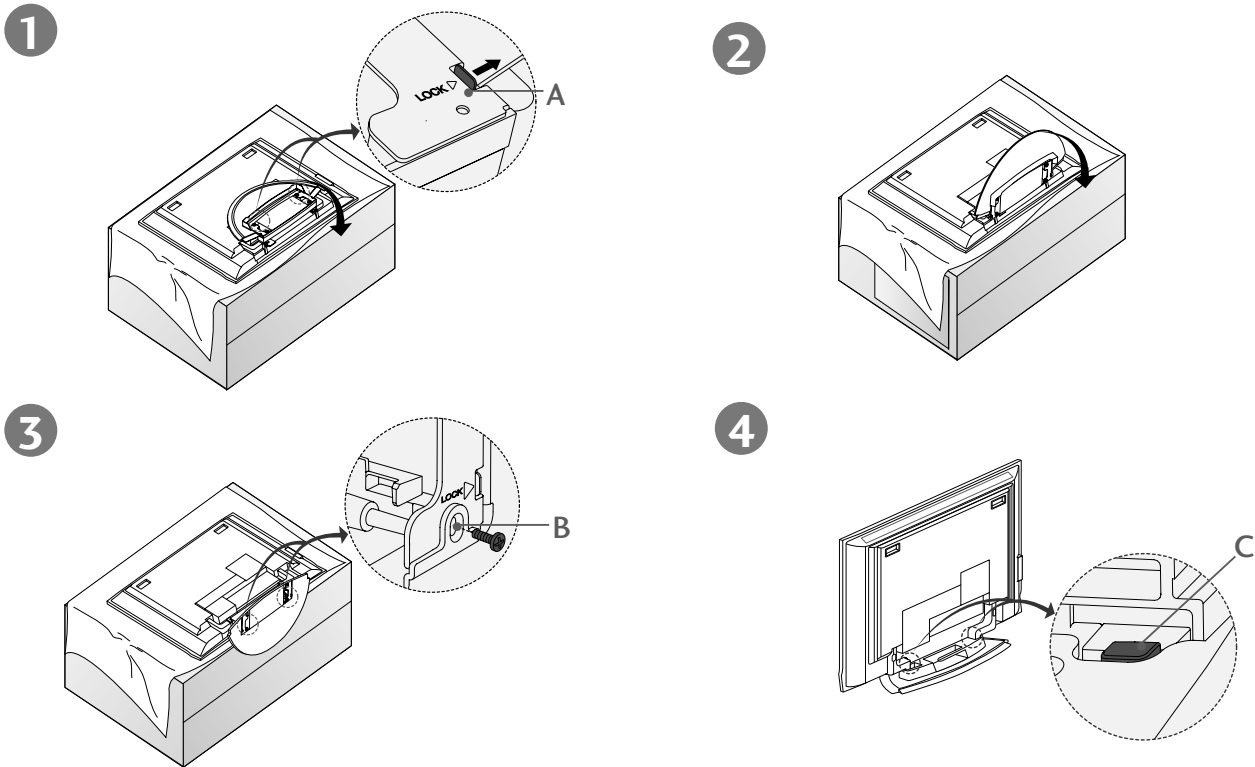

- Place the set with the screen facing down on a cushion or soft cloth as shown in Figures 1. Before unfolding the stand, please make sure two locks (A) on the bottom of the stand push outward.
- Pull the stand out as shown above in Figures 2 ~ 3. After unfolding the stand, please insert and tighten the screws in the holes (B) on the bottom of the stand.
- When connecting cables to the set, Do not disengage the lock (C). This may cause the set to fall, causing serious bodily injury and serious damage to the set.

NOTE

Figures shown here may be slightly different from your set.

When closing the stand for storage

First remove the screws in the holes (B) on the bottom of the stand. And then pull two Hooks (D) of the stand bottom and fold the stand into the back of the set.

After folding, push two Locks (A) of the stand bottom outward.

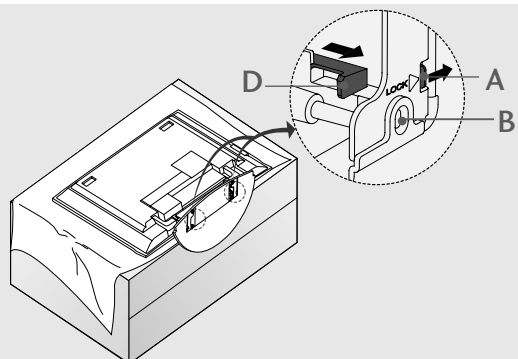

INSTALLATION

STAND INSTALLATION (Only 26LC3R*, 32LC2R*, 32LC25R*)

- 1 Carefully place the product screen side down on a cushioned surface that will protect product and screen from damage.

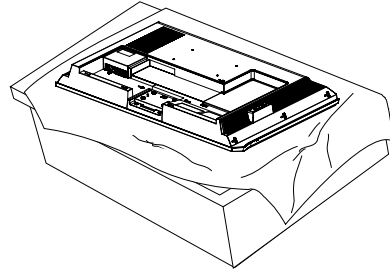

- 2 Place the product stand on the product as shown.

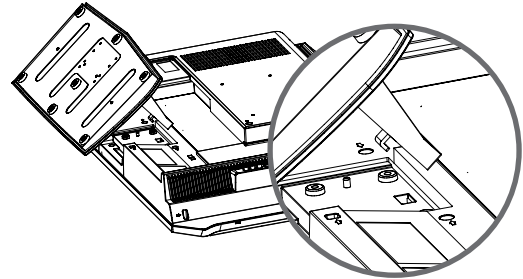

- 3 Install the 4 bolts securely, in the back of the product in the holes provided.

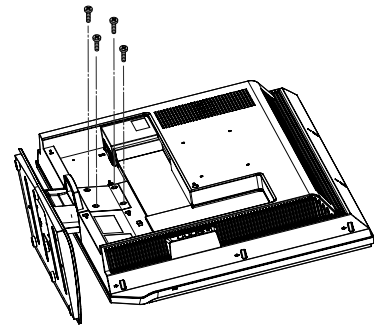

BASIC CONNECTION (42PC1RV*, 42PC3RV*, 42PC3RA*)

- These models have two cable arrangement methods according to the stand type.

Stand type 1

Arrange the cables as shown picture.

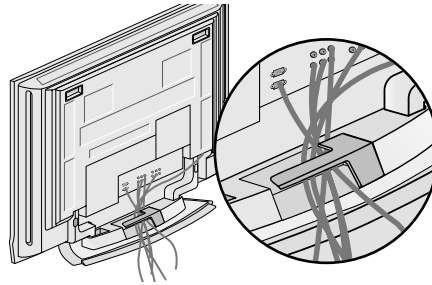

Stand type 2

- 1 Hold the **CABLE MANAGEMENT** with both hands and push it as shown.

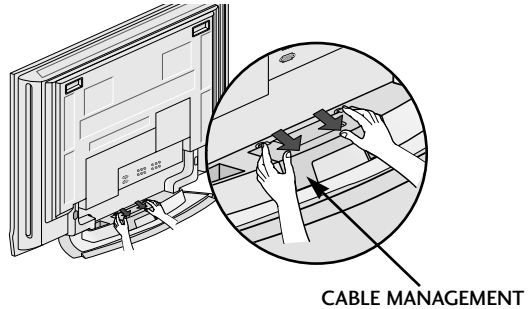

- 2 Connect the cables as necessary.
To connect an additional equipment, see the **External equipment Connections** section.

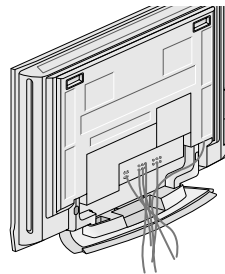

- 3 Reinstall the **CABLE MANAGEMENT** as shown.

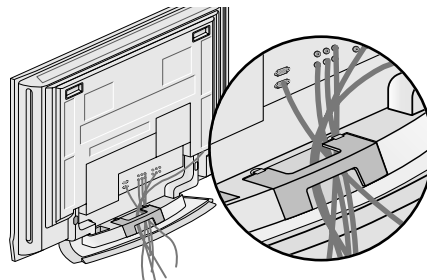

INSTALLATION

BASIC CONNECTION

(Only 26LC2R*, 27LC2R*, 32LC2R*, 32LC25R*, 26LC3R*, 32LC3R*, 32LE2R*, 37LE2R*, 42LE2R*)

- 1 Connect the cables as necessary. After connecting the cables neatly, arrange the cables to the Cable Holder.

To connect an additional equipment, see the **External equipment Connections** section.

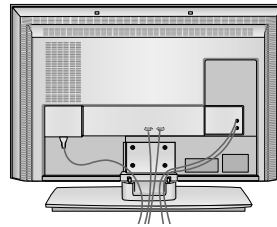

- 2 Install the **CABLE MANAGEMENT** as shown.

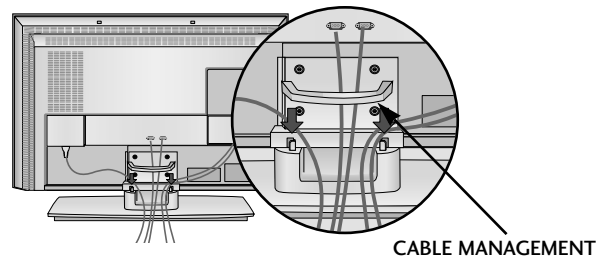

- 3 Bundle the cables using the supplied twister holder.

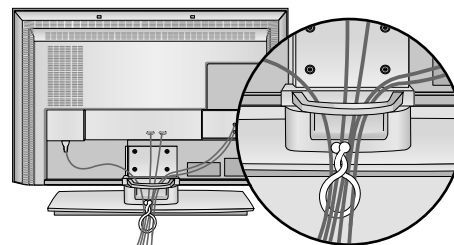

HOW TO REMOVE THE CABLE MANAGEMENT

- Hold the **CABLE MANAGEMENT** with both hands and pull it upward.
- Hold the **CABLE MANAGEMENT** with both hands and pull it downward. (Only 32LC3R*)

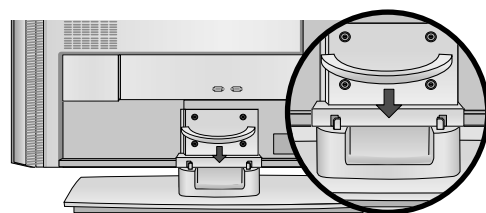
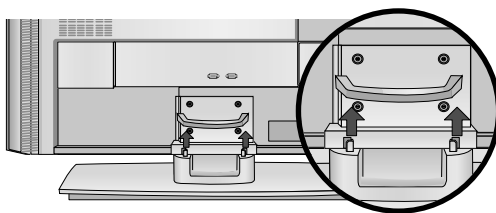

! NOTE

- ▶ Do not hold the **CABLE MANAGEMENT** when moving the product.
- If the product is dropped, you may be injured or the product may be broken.

BASIC CONNECTION (32LX2R*)

- 1 Hold the cover with both hands and pull it backward.

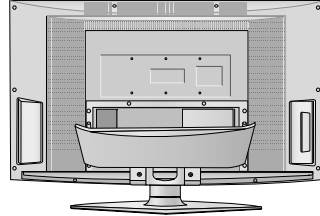

- 2 Connect the cables as necessary.
To connect an additional equipment, see the **External equipment Connections** section.

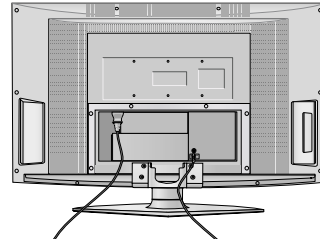

- 3 Bundle the cables using the supplied twister holder.

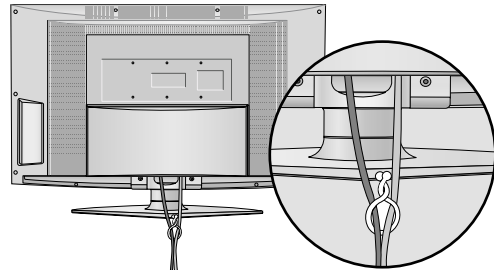

SWIVEL STAND (32LX2R*)

The TV can be conveniently swiveled on its stand 30° to the left or right to provide the optimum viewing angle.

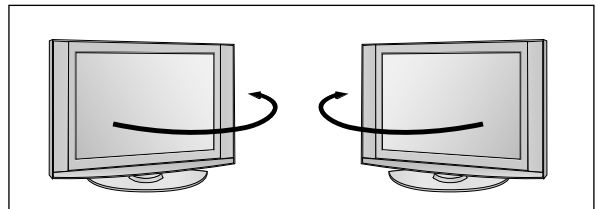

INSTALLATION

- The TV can be installed in various ways such as on a wall, or on a desktop etc.
- The TV is designed to be mounted horizontally.

GROUNDING

Ensure that you connect the earth ground wire to prevent possible electric shock. If grounding methods are not possible, have a qualified electrician install a separate circuit breaker. Do not try to ground the unit by connecting it to telephone wires, lightning rods, or gas pipes.

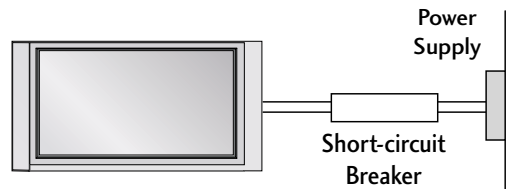

Desktop Pedestal Installation

For proper ventilation, allow a clearance of 4" on each side and from the wall.

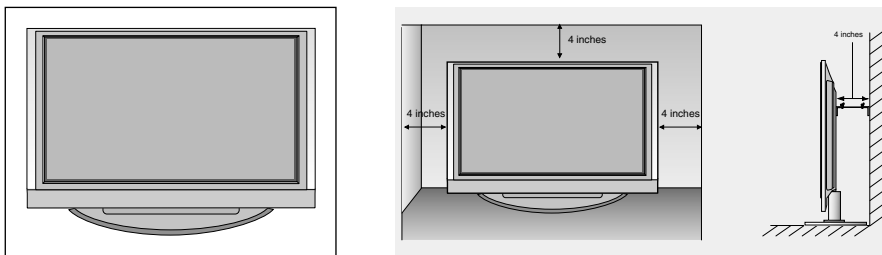

Wall Mount: Horizontal installation

For proper ventilation, allow a clearance of 4" on each side and from the wall. Detailed installation instructions are available from your dealer, see the optional Tilt Wall Mounting Bracket Installation and Setup Guide.

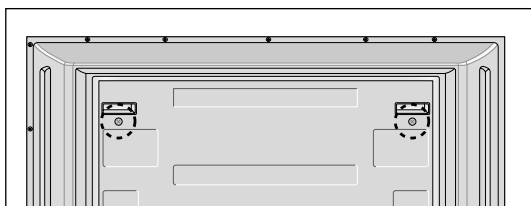
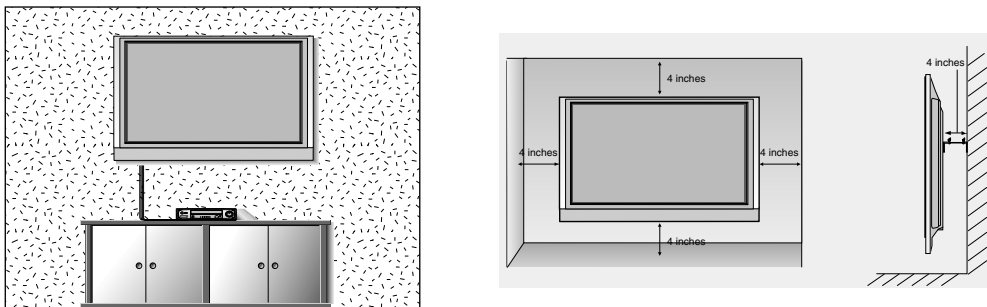

<Only 42PC1RV*, 42PC3RV*, 42PC3RA* series>
Remove two screws of the backside of the set before installing the wall mounting bracket.

HOW TO JOIN THE PRODUCT ASSEMBLY TO THE WALL TO PROTECT THE SET TUMBLING

- Set it up close to the wall so the product doesn't fall over when it is pushed backwards.
- The instructions shown below is a safer way to set up the product, which is to fix it on the wall so the product doesn't fall over when it is pulled in the forward direction. It will prevent the product from falling forward and hurting people. It will also prevent the product from damage caused by fall. Please make sure that children don't climb on or hang from the product.

Plasma TV models

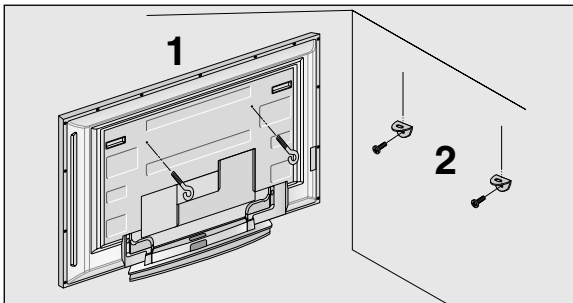

LCD TV models

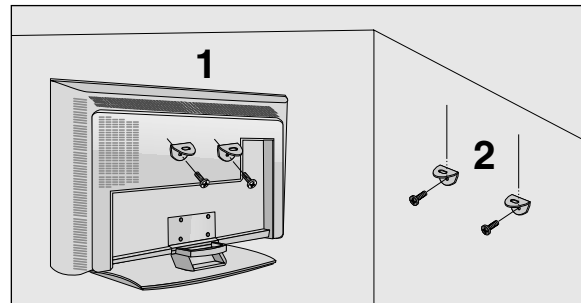

- 1 Use the eye-bolts or TV brackets/bolts to fix the product to the wall as shown in the picture. (If your product has the bolts in the eye-bolts position before inserting the eye-bolts, loosen the bolts.)
* Insert the eye-bolts or TV brackets/bolts and tighten them securely in the upper holes.
- 2 Secure the wall brackets with the bolts (not provided as parts of the product, must purchase separately) on the wall. Match the height of the bracket that is mounted on the wall.

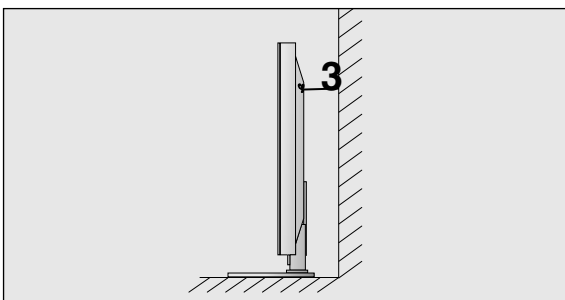

- 3 Use a sturdy rope (not provided as parts of the product, must purchase separately) to tie the product. It is safer to tie the rope so it becomes horizontal between the wall and the product.

! NOTE

- ▶ When moving the product to another place undo the ropes first.
- ▶ Use a product holder or a cabinet that is big and strong enough for the size and weight of the product.
- ▶ To use the product safely make sure that the height of the bracket that is mounted on the wall is same as that of the product.

CONNECTIONS & SETUP

- To prevent the equipment damage, never plug in any power cords until you have finished connecting all equipment.

ANTENNA CONNECTION

- For optimum picture quality, adjust antenna direction.
- An antenna cable and converter are not supplied.

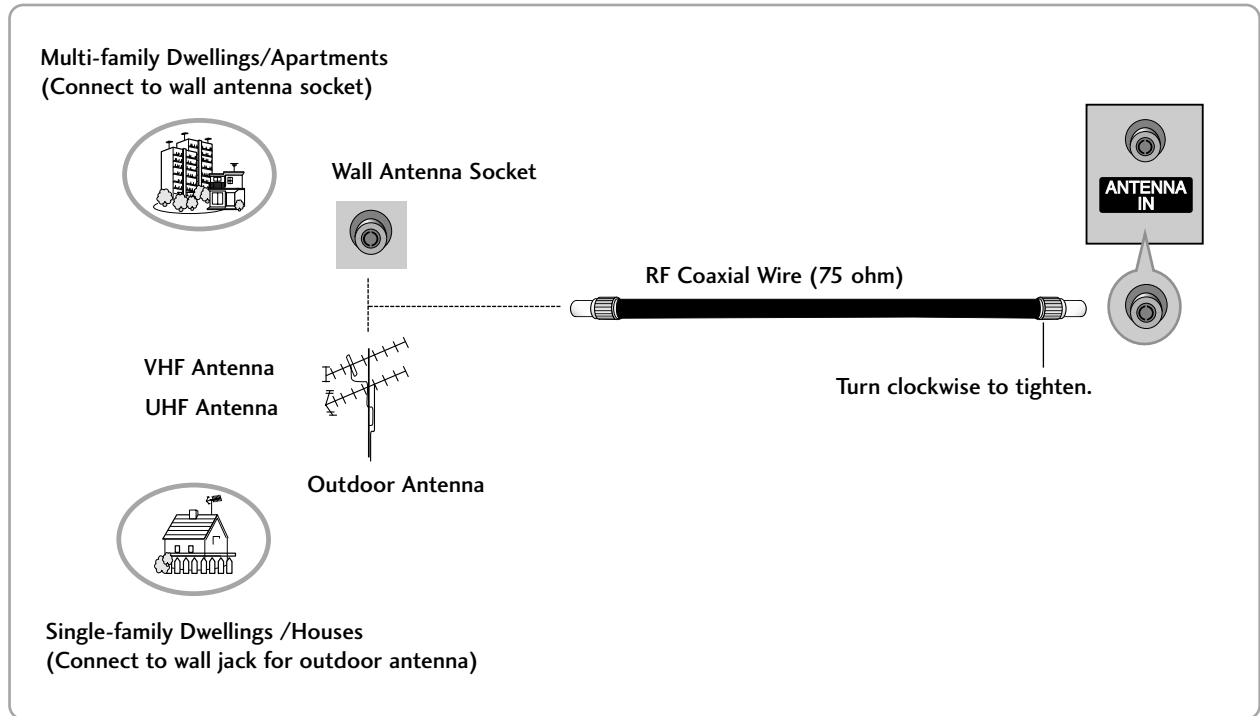

- In poor signal areas, to get better picture quality, install a signal amplifier to the antenna as shown to the right.
- If signal needs to be split for two TVs, use an antenna signal splitter for connection.

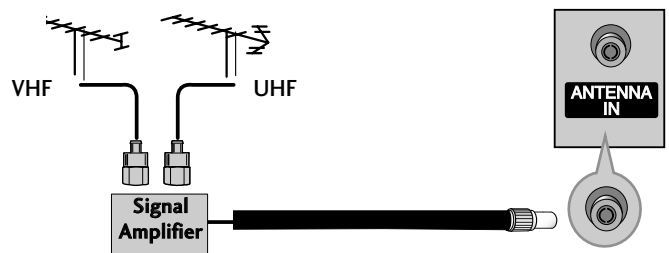

VCR SETUP

- To avoid picture noise (interference), leave an adequate distance between the VCR and TV.
- Typically a frozen still picture from a VCR. If the 4:3 picture format is used; the fixed images on the sides of the screen may remain visible on the screen.

When connecting with an antenna

- 1 Connect the **ANT OUT** socket of the VCR to the **ANTENNA IN** socket on the set.
- 2 Connect the antenna cable to the **ANT IN** socket of the VCR.
- 3 Press the **PLAY** button on the VCR and match the appropriate programme between the TV and VCR for viewing.

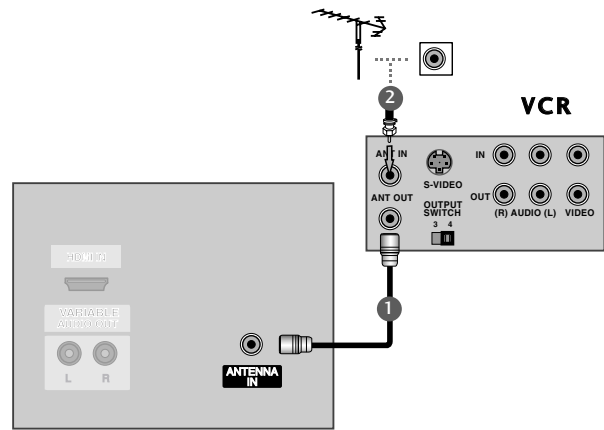

When connecting with a RCA cable

- 1 Connect the **AUDIO/VIDEO** jacks between TV and VCR. Match the jack colors (Video = yellow, Audio Left = white, and Audio Right = red).
- 2 Insert a video tape into the VCR and press **PLAY** on the VCR. (Refer to the VCR owner's manual.)
- 3 Select **AV3** input source using the **INPUT** button on the remote control.
 - If connected to **AV IN 4**, select **AV4** input source. (except 42PC3RV*, 42PC3RA*)

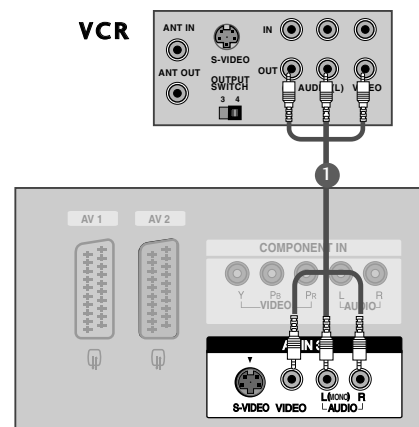

! NOTE

- ▶ If you have a mono VCR, connect the audio cable from the VCR to the **AUDIO L/MONO** jack of the set.

CONNECTIONS & SETUP

VCR SETUP

When connecting with a Euro Scart

- 1 Connect the Euro scart socket of the VCR to the **AV1** Euro scart socket on the set.
- 2 Insert a video tape into the VCR and press **PLAY** on the VCR. (Refer to the VCR owner's manual.)
- 3 Select **AV1** input source with using the **INPUT** button on the remote control.
- If connected to **AV2** Euro scart socket, select **AV2** input source.

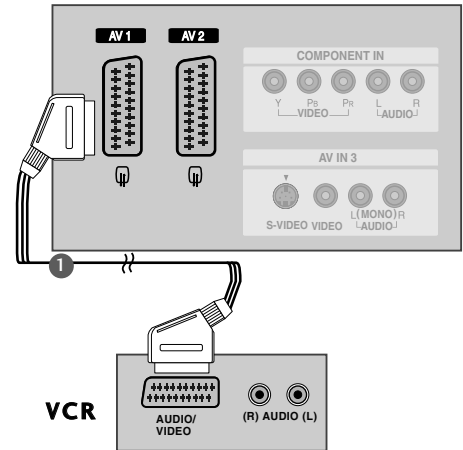

! NOTE

- ▶ If the S-VIDEO(Y/C) signal is received through the Euro scart socket 2 (AV2), you must change to the S-Video2 mode.
- ▶ If you want to use the EURO scart cable, you have to use the signal shielded Euro scart cable.

When connecting with an S-Video cable

- 1 Connect the S-VIDEO output of the VCR to the **S-VIDEO** input on the set. The picture quality is improved; compared to normal composite (RCA cable) input.
- 2 Connect the audio outputs of the VCR to the **AUDIO** input jacks on the set.
- 3 Insert a video tape into the VCR and press **PLAY** on the VCR. (Refer to the VCR owner's manual.)
- 4 Select **AV3** input source with using the **INPUT** button on the remote control.

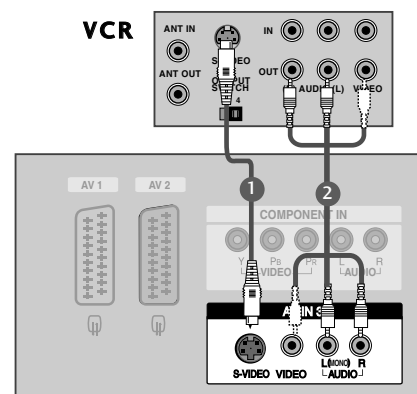

! NOTE

- ▶ If both S-VIDEO and VIDEO sockets have been connected to the S-VHS VCR simultaneously, only the S-VIDEO can be received.

EXTERNAL EQUIPMENT CONNECTIONS

- 1 Connect the **AUDIO/VIDEO** jacks between TV and external equipment. Match the jack colors (Video = yellow, Audio Left = white, and Audio Right = red)
- 2 Select **AV4** input source with using the **INPUT** button on the remote control. (except 42PC3RV*, 42PC3RA*)
- If connected to **AV IN3** input, select **AV3** input source.
- 3 Operate the corresponding external equipment. Refer to external equipment operating guide.

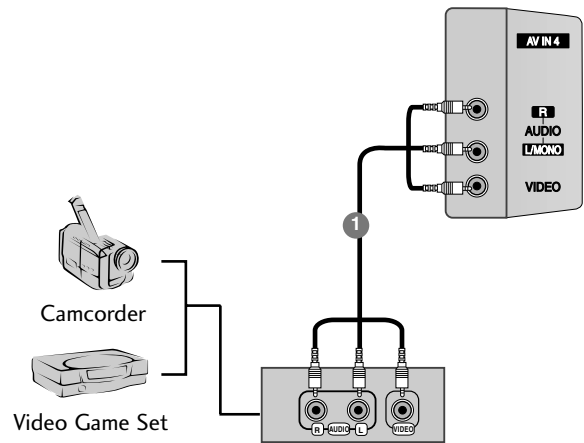

CONNECTIONS & SETUP

DVD SETUP

When connecting with a component cable

- 1 Connect the video outputs (Y, Pb, Pr) of the DVD to the **COMPONENT IN VIDEO** jacks on the set.
- 2 Connect the audio outputs of the DVD to the **COMPONENT IN AUDIO** jacks on the set.
- 3 Turn on the DVD player, insert a DVD.
- 4 Select **Component** input source with using the **INPUT** button on the remote control.
- 5 Refer to the DVD player's manual for operating instructions.

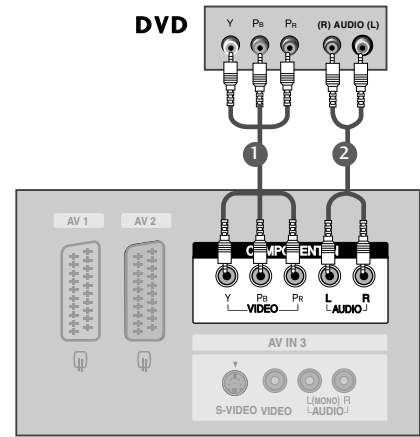

! NOTE

► Component Input ports

To get better picture quality, connect a DVD player to the component input ports as shown below.

Component ports on the TV	Y	Pb	Pr
Video output ports on DVD player	Y	Pb	Pr
	Y	B-Y	R-Y
	Y	Cb	Cr
	Y	Pb	Pr

When connecting with a Euro Scart

- 1 Connect the Euro scart socket of the DVD to the **AV1** Euro scart socket on the set.
- 2 Turn on the DVD player, insert a DVD.
- 3 Select **AV1** input source with using the **INPUT** button on the remote control.
- If connected to **AV2** Euro scart socket, select **AV2** input source.

! NOTE

► Please use the shield scart cable.

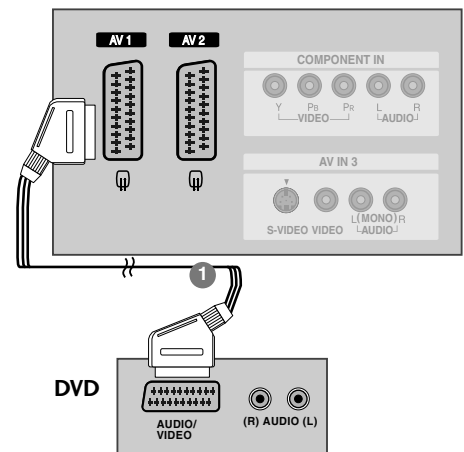

When connecting with a S-Video cable

- 1 Connect the S-VIDEO output of the DVD to the **S-VIDEO** input on the set.
- 2 Connect the audio outputs of the DVD to the **AUDIO** input jacks on the set.
- 3 Turn on the DVD player, insert a DVD.
- 4 Select **AV3** input source with using the **INPUT** button on the remote control.
- 5 Refer to the DVD player's manual for operating instructions.

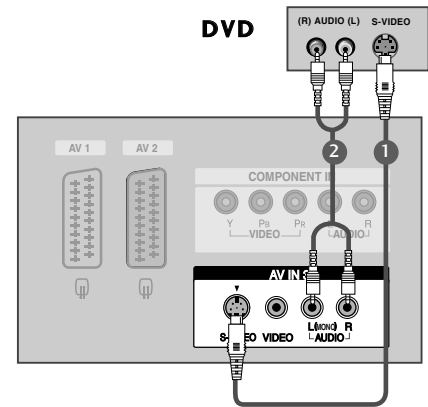

When connecting with a HDMI cable

- 1 Connect the HDMI output of the DVD to the **HDMI IN** jack on the set.
- 2 Select **HDMI** input source with using the **INPUT** button on the remote control.
- 3 Refer to the DVD player's manual for operating instructions.

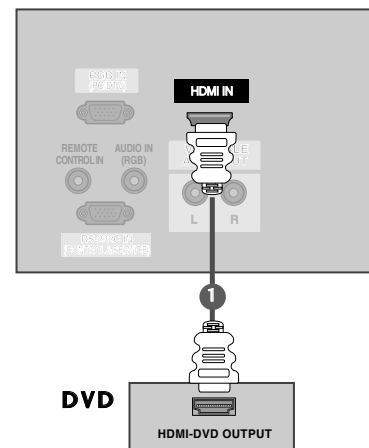

NOTE

- ▶ TV can receive the video and audio signal simultaneously with using a HDMI cable.
- ▶ If the DVD supports Auto HDMI function, the DVD output resolution will be automatically set to 1280x720p.
- ▶ If the DVD does not support Auto HDMI, you need to set the output resolution appropriately. To get the best picture quality, adjust the output resolution of the DVD to 1280x720p.

CONNECTIONS & SETUP

STB (SET-TOP BOX) SETUP

When connecting with a component cable

- 1 Connect the video outputs (Y, PB, PR) of the digital set-top box to the **COMPONENT IN VIDEO** jacks on the set.
- 2 Connect the audio output of the digital set-top box to the **COMPONENT IN AUDIO** jacks on the set.
- 3 Turn on the digital set-top box. (Refer to the owner's manual for the digital set-top box.)
- 4 Select **Component** input source with using the **INPUT** button on the remote control.

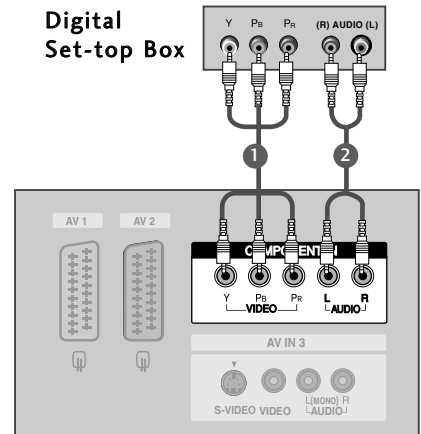

! NOTE

Signal	Component	RGB-DTV	HDMI
480i/576i	Yes	No	No
480p/576p/720p/1080i	Yes	Yes	Yes

When connecting with a HDMI to DVI cable

- 1 Connect the DVI output of the digital set-top box to the **HDMI IN** jack on the set.
- 2 Connect the audio outputs of the set-top box to the **AUDIO IN (RGB)** jack on the set.
- 3 Turn on the digital set-top box. (Refer to the owner's manual for the digital set-top box.)
- 4 Select **HDMI** input source with using the **INPUT** button on the remote control.

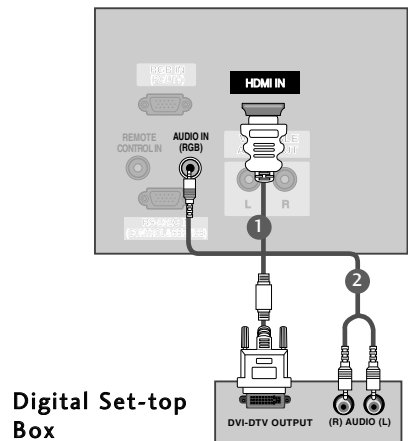

! NOTE

- ▶ If the digital set-top box has a DVI output and no HDMI output, a separated audio connection is necessary.
- ▶ If the digital set-top box supports Auto DVI function, the output resolution of the digital set-top box will be automatically set to 1280x720p.
- ▶ If the digital set-top box does not support Auto DVI, you need to set the output resolution appropriately. To get the best picture quality, adjust the output resolution of the digital set-top box to 1280x720p.

When connecting with a D-sub 15 pin cable

- 1 Connect the RGB output of the digital set-top box to the **RGB IN (PC/DTV)** jack on the set.
- 2 Connect the audio outputs of the set-top box to the **AUDIO IN (RGB)** jack on the set.
- 3 Turn on the digital set-top box. (Refer to the owner's manual for the digital set-top box.)
- 4 Select **RGB-DTV** input source with using the **INPUT** button on the remote control.

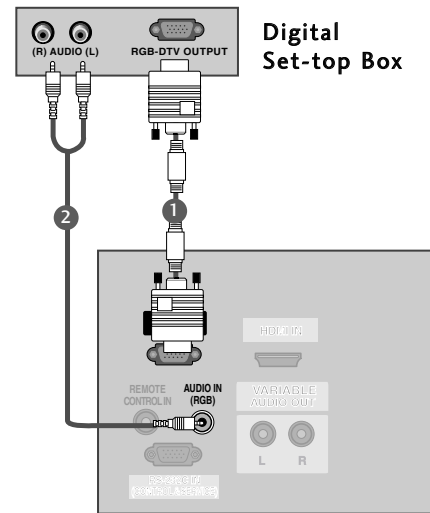

When connecting with a HDMI cable

- 1 Connect the HDMI output of the digital set-top box to the **HDMI IN** jack on the set.
- 2 Select **HDMI** input source with using the **INPUT** button on the remote control.
- 3 Turn on the digital set-top box. (Refer to the owner's manual for the digital set-top box.)

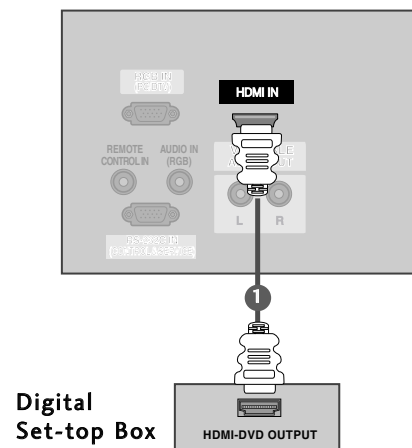

! NOTE

- ▶ TV can receive the video and audio signal simultaneously with using a HDMI cable.
- ▶ If the digital set-top box supports Auto HDMI function, output resolution of the digital set-top box will be automatically set to 1280x720p.
- ▶ If the digital set-top box does not support Auto HDMI, you need to set the output resolution appropriately. To get the best picture quality, adjust the output resolution of the digital set-top box to 1280x720p.

CONNECTIONS & SETUP

PC SETUP

- This TV provides Plug and Play capability, meaning that the PC adjusts automatically to the TV's settings.

When connecting with a D-sub 15 pin cable

- 1 Connect the TV to the PC with the PC cable.
- 2 Connect the PC audio output to the TV's **AUDIO IN (RGB)** input.
- 3 Turn on the PC.
- 4 Select **RGB [PC]** input source with using the **INPUT** button on the remote control.

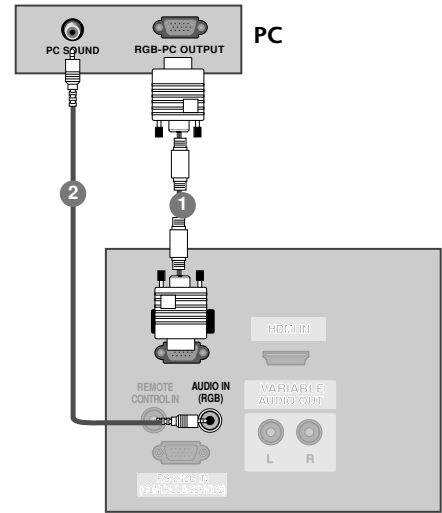

! NOTE

- 1 To enjoy vivid picture and sound, connect a PC to the set.
- 2 Avoid keeping a fixed image on the set's screen for a long period of time. The fixed image may become permanently imprinted on the screen; use a screen saver when possible.
- 3 Connect PC to the RGB INPUT(PC INPUT) port of the set; change the resolution output of PC accordingly.
- 4 There might be a noise according to some resolution, vertical pattern, contrast or brightness in PC mode. Then change the PC mode into other resolution or change the refresh rate into other rate or adjust the brightness and contrast on the menu until the picture is clean. If the refresh rate of the PC graphic card can not be changed, change the PC graphic card or consult it to the manufacturer of the PC graphic card.
- 5 The synchronization input form for Horizontal and Vertical frequencies is separate.
- 6 We recommend using 640x480, 60Hz (42PC1RV*, 42PC3RV*) /1360x768, 60Hz (26LC2R*, 27LC2R*, 32LC2R*, 32LC25R*, 26LC3R*, 32LC3R*, 32LX2R*, 32LE2R*, 37LE2R*, 42LE2R*) /1024x768, 60Hz (42PC3RA*) for the PC mode, they provide the best picture quality.
- 7 If the resolution of PC is over SXGA, there will be no picture on the set.
- 8 Connect the audio cable from the PC to the Audio input on the set. (Audio cables are not included with the set).
- 9 When you use too long RGB-PC cable, there might be a noise on the screen. We recommend using under 5m of the cable. It provides the best picture quality.

Supported Display Resolution (RGB[PC] mode)
 (26LC2R*/ 27LC2R*/ 32LC2R*/ 32LC25R*/
 26LC3R*/ 32LC3R*/ 32LX2R*/ 32LE2R*/ 37LE2R*/
 42LE2R*/ 42PC3RA*)

Resolution	Horizontal Frequency(KHz)	Vertical Frequency(Hz)
640x350	31.5	70.8
720x400	31.5	70.8
640x480	31.5	59.9
800x600	37.9	60.3
1024x768	48.4	60.0
1280x768	47.8	59.9
1360x768	47.7	59.8
1366x768	47.7	59.8

Supported Display Resolution (RGB[PC] mode)
 (42PC1RV*/ 42PC3RV*)

Resolution	Horizontal Frequency(KHz)	Vertical Frequency(Hz)
640x350	31.5	70.8
720x400	31.5	70.8
640x480	31.5	59.9
848x480	31.5	60.0
852x480	31.5	60.0
800x600	37.9	60.3
1024x768	48.4	60.0

CONNECTIONS & SETUP

TURNING THE TV ON

If your TV will be turned on, you will be able to use its features.

Turing on the TV

- 1 First, connect power cord correctly.
At this moment, the TV switches to standby mode.
 - In standby mode to turn TV on, press the $\phi/|$, INPUT, PR \blacktriangle / \blacktriangledown button on the TV or press the POWER, TV, INPUT, PR +/-, Number(0~9) button on the remote control and then the TV will switch on.

Volume Adjustment

- 1 Press the VOL +/- button to adjust the volume.
- 2 If you want to switch the sound off, press the MUTE button.
You can cancel this function by pressing the MUTE, VOL +/- or I/II button.

Programme selection

- 1 Press the PR +/- or NUMBER button to select a programme number.



! NOTE

- ▶ If you intend to be away on vacation, disconnect the power plug from wall power outlet.

On-Screen Menu Language / Country Selection

Installation guide menu appears on TV screen when it is turned on for the first time.

1 Press the ▲ / ▼ / ◀ / ▶ button and then, **OK** button to select your desired language.

2 Press the ▲ / ▼ / ◀ / ▶ button and then, **OK** button to select your country.

* If you want to change Language/ Country selection

1 Press the **MENU** button and then use ▲ / ▼ button to select the **Special** menu.

2 Press the ▶ button and then use ▲ / ▼ button to select **Language**. The menus can be shown on the screen in the selected language.
Or, Press the ▶ button and then use ▲ / ▼ button to select **Country**.

3 Press the ▶ button and then use ▲ / ▼ button to select your desired language or country.

4 Press the **OK** button

5 Press the **EXIT** button to return to normal TV viewing.

! NOTE

- ▶ If you don't finish set up **Installation Guide** by pressing **EXIT** button or time out of OSD (On Screen Display) display, it will continuously appear until completing set up whenever the set is turned on.
- ▶ If you select wrong local country, the teletext may not appear correctly on the screen and some problem may happen during teletext operation.
- ▶ Arab and Hebrew are added to **Country of Installation Guide** according to the countries which using Arab and Hebrew languages.

SPECIAL FUNCTIONS

PIP (Picture-In-Picture)

PIP lets you view 2 different inputs (sources) on your TV screen at the same time. One source will be large, and the other source will show a smaller inset image.

PIP function is available in the Component, RGB, HDMI mode. (But, it can't adjust 480i/576i resolution of Component, RGB, HDMI mode.)

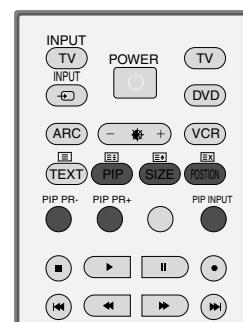

Watching PIP

Press the **PIP** button to access the sub picture. Each press of PIP changes the PIP options.

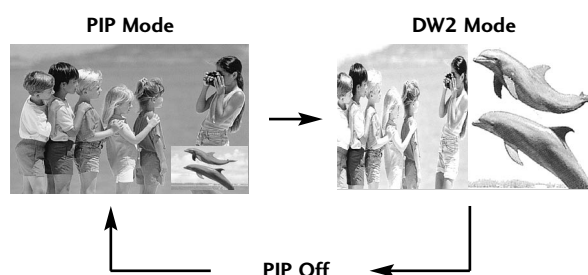

Programme Selection for Sub Picture

Press the **PIP PR +/-** button to select a programme for the sub picture.

The selected programme number is displayed just below the programme number of main picture.

Input Source Selection for Sub Picture

Press the **PIP INPUT** button to select the input source for the sub picture.

Each press of **PIP INPUT** button is pressed, each input source for the sub picture is displayed.

(Sub picture can be selected only TV, AV1 (Video), AV2, S-Video2, AV3, AV4.)

Sub Picture Size Adjustment (PIP mode only)

Press the **SIZE** button to adjust the sub picture size.

With **SIZE** button in PIP mode, sub picture is adjusted.

Moving the Sub Picture (PIP mode only)

Press the **POSITION** button.

Repeatedly press the **POSITION** button then sub picture moves left.

TELETEXT

This feature is not available in all countries.

Teletext is a free service broadcast by most TV stations which gives up-to-the-minute information on news, weather, television programmes, share prices and many other topics.

The teletext decoder of this TV can support the SIMPLE, TOP and FASTEXT systems. SIMPLE (standard teletext) consists of a number of pages which are selected by directly entering the corresponding page number. TOP and FASTEXT are more modern methods allowing quick and easy selection of teletext information.

Switch on/off

Press the **TEXT** button to switch to teletext. The initial page or last page appears on the screen. Two page numbers, TV station name, date and time are displayed on the screen headline. The first page number indicates your selection, while the second shows the current page displayed. Press the **TEXT** or **EXIT** button to switch off teletext. The previous mode reappears.

SIMPLE Text

■ Page selection

- 1 Enter the desired page number as a three digit number with the **NUMBER** buttons. If during selection you press a wrong number, you must complete the three digit number and then re-enter the correct page number.
- 2 The **PR+/-** button can be used to select the preceding or following page.

SPECIAL FUNCTIONS

TELETEXT

TOP Text

The user guide displays four fields-red, green, yellow and blue at the bottom of the screen. The yellow field denotes the next group and the blue field indicates the next block.

■ Block / group / page selection

- 1 With the blue button you can progress from block to block.
- 2 Use the yellow button to proceed to the next group with automatic overflow to the next block.
- 3 With the green button you can proceed to the next existing page with automatic overflow to the next group. Alternatively the **PR+** button can be used.
- 4 The red button permits to return to previous selection. Alternatively the **PR-** button can be used.

■ Direct page selection

Corresponding to the SIMPLE teletext mode, you can select a page by entering it as a three digit number using the NUMBER buttons in TOP mode.

FASTTEXT

The teletext pages are colour coded along the bottom of the screen and are selected by pressing the corresponding coloured button.

■ Page selection

- 1 Press the  button to select the index page.
- 2 You can select the pages which are colour coded along the bottom line with the same coloured buttons.
- 3 Corresponding to the SIMPLE teletext mode, you can select a page by entering its three digit page number with the NUMBER buttons in FASTTEXT mode.
- 4 The **PR+/-** button can be used to select the preceding or following page.

Special Teletext Functions



■ REVEAL

Press this button to display concealed information, such as solutions of riddles or puzzles.
Press this button again to remove the information from the display.



■ SIZE

Selects double height text.
Press this button to enlarge the top half of the page.
Press this button again to enlarge the bottom half of the page.
Press this button again to return to the normal display.



■ UPDATE

Displays the TV picture on the screen while waiting for the new teletext page. The display will appear at the top left hand corner of the screen. When the updated page is available then display will change to the page number.
Press this button to view the updated teletext page.



■ TIME

When viewing a TV programme, press this button to display the time at the top right hand corner of the screen.
Press this button again to remove the display. In the teletext mode, press this button to select a sub page number. The sub page number is displayed at the bottom of the screen. To hold or change the sub page, press the RED/GREEN, **PR+/-** or NUMBER buttons.
Press again to exit this function.



■ HOLD

Stops the automatic page change which will occur if a teletext page consists of 2 or more sub pages. The number of sub pages and the sub page displayed is, usually, shown on the screen below the time. When this button is pressed the stop symbol is displayed at the top left-hand corner of the screen and the automatic page change is inhibited. To continue press this button again.

TV MENU

ON SCREEN MENUS SELECTION AND ADJUSTMENT

Your TV's OSD (On Screen Display) may differ slightly from what is shown in this manual.

The OSD mainly use pictures for the 42PC1RV*, 42PC3RV*, 42PC3RA*.

- 1 Press the **MENU** button and then **▲ / ▼** button to display each menu.
- 2 Press the **▶** button and then **▲ / ▼** button to select a menu item.
- 3 Change the setting of an item in the sub or pull-down menu with **◀ / ▶** button. You can move to the higher level menu by pressing the **OK** or **MENU** button.

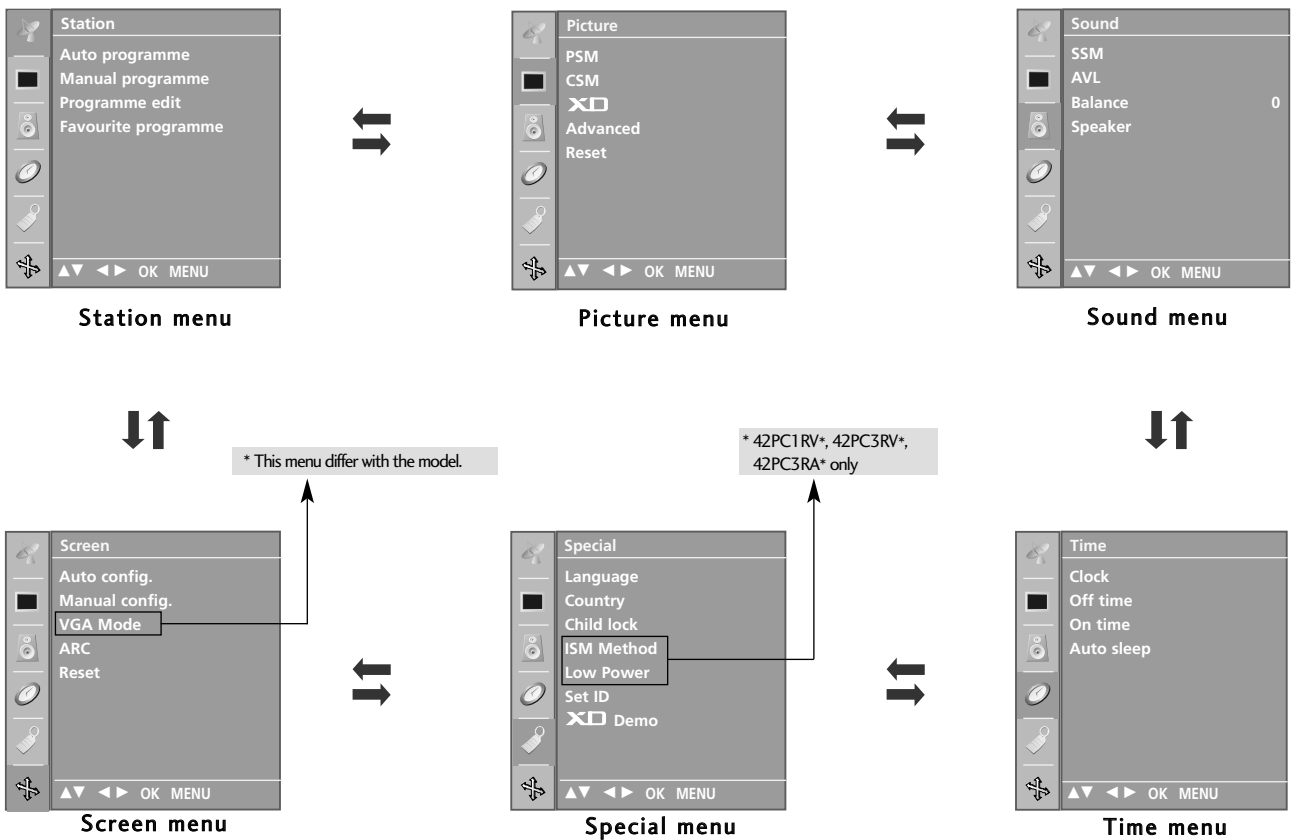

NOTE

- a. The OSD (On Screen Display) function enables you to adjust the screen status conveniently since it provides graphical presentation.
- b. In this manual, the OSD (On Screen Display) may be different from your TV's because it is just example to help the TV operation.
- c. In the teletext mode, menus are not displayed

Setting up TV stations

AUTO PROGRAMME TUNING

Up to 100 TV stations can be stored by programme numbers (0 to 99). Once you have preset the stations, you will be able to use the PR +/- or NUMBER buttons to scan the stations you have programmed. Stations can be tuned using automatic or manual modes.

All stations that can be received are stored by this method. It is recommended that you use auto programme during installation of this set.

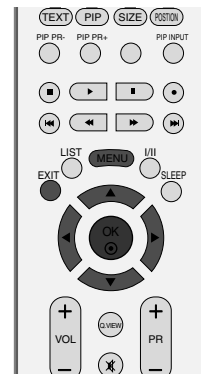

- 1 Press the **MENU** button and then ▲ / ▼ button to select the **Station** menu.
- 2 Press the ► button and then ▲ / ▼ button to select **Auto programme**.
- 3 Press the ► button and then ▲ / ▼ button to select **System**.
- 4 Press the ▲ / ▼ button to select a TV system menu;
 - BG** : PAL B/G, SECAM B/G (Europe / East Europe / Asia / New Zealand / M.East / Africa / Australia)
 - I** : PAL I/II (U.K. / Ireland / Hong Kong / South Africa)
 - DK** : PAL D/K, SECAM D/K (East Europe / China / Africa / CIS)
 - L** : SECAM L/L' (France)
 - M** : (USA / Korea / Philippines) (option)
- 5 Press the ▲ / ▼ button to select **Storage from**.
- 6 Press the ◀ / ▶ button or NUMBER buttons to select the beginning programme number. If you use NUMBER buttons, any number under 10 is entered with a numeric '0' in front of it, i.e. '05' for 5.
- 7 Press the ▲ / ▼ button to select **Search**.
- 8 Press the ► button to begin auto programming. All receivable stations are stored. The station name is stored for stations which broadcast VPS (Video Programme Service), PDC (Programme Delivery Control) or TELETEXT data. If no station name can be assigned to a station, the channel number is assigned and stored as C (V/UHF 01-69) or S (Cable 01-47), followed by a number.
To stop auto programming, press the **MENU** button. When auto programming is completed, the Programme edit menu appears on the screen. See the Programme edit section to edit the stored programme.
- 9 Press the **EXIT** button to return to normal TV viewing.



1

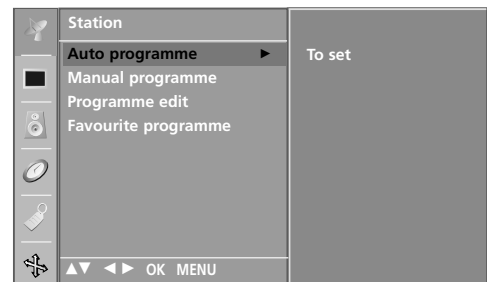

2

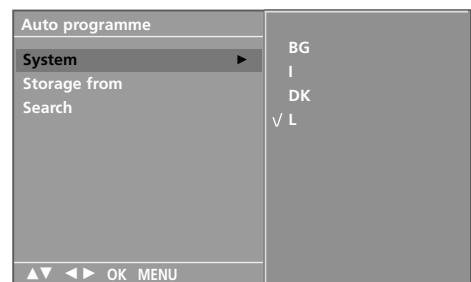

3 4 5 6 7

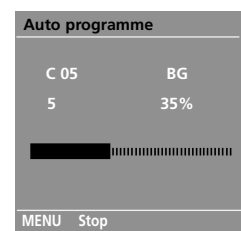

8

MANUAL PROGRAMME TUNING

Manual programme lets you manually tune and arrange the stations in whatever order you desire.



- 1 Press the **MENU** button and then **▲ / ▼** button to select the **Station** menu.
- 2 Press the **▶** button and then **▲ / ▼** button to select **Manual programme**.
- 3 Press the **▶** button and then **▲ / ▼** button to select **Storage**.
- 4 Press the **◀ / ▶** button or **NUMBER** buttons to select the desired programme number (0 to 99). If you use **NUMBER** buttons, any number under 10 is entered with a numeric '0' in front of it, i.e. '05' for 5.
- 5 Press the **▲ / ▼** button to select **System**.
- 6 Press the **▲ / ▼** button to select a TV system menu;
 - BG** : PAL B/G, SECAM B/G (Europe / East Europe / Asia / New Zealand / M.East / Africa / Australia)
 - I** : PAL I/II (U.K. / Ireland / Hong Kong / South Africa)
 - DK** : PAL D/K, SECAM D/K (East Europe / China / Africa / CIS)
 - L** : SECAM L/L' (France)
 - M** : (USA / Korea / Philippines) (option)
- 7 Press the **▲ / ▼** button to select **Band**.
- 8 Press the **▲ / ▼** button to select **V/UHF** or **Cable**.
- 9 Press the **▲ / ▼** button to select **Channel**.
- 10 You can select the desired programme number with the **◀ / ▶** button or number buttons. If possible, select the programme number directly with the number buttons. Any number under 10 is entered with a numeric '0' in front of it, i.e. '05' for 5.
- 11 Press the **▲ / ▼** button to select **Search**.
- 12 Press the **◀ / ▶** button to commence searching. If a station is found the search will stop.
- 13 Press the **OK** button to store it.
- 14 To store another station, repeat steps 3 to 13.
- 15 Press the **EXIT** button to return to normal TV viewing.



1



2

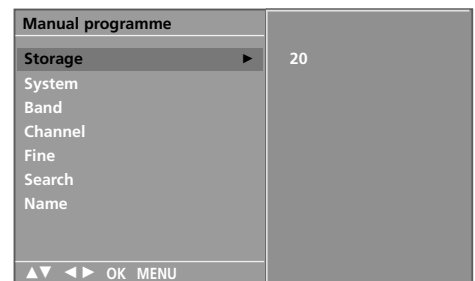

3 4 5 6 7
8 9 10 11 12

FINE TUNING

Normally fine tuning is only necessary if reception is poor.

- 1 Press the **MENU** button and then **▲ / ▼** button to select the **Station** menu.
- 2 Press the **▶** button and then **▲ / ▼** button to select **Manual programme**.
- 3 Press the **▶** button and then **▲ / ▼** button to select **Fine**.
- 4 Press the **◀ / ▶** button to to fine tune for the best picture and sound.
- 5 Press the **OK** button to store it.
- 6 Press the **EXIT** button to return to normal TV viewing.

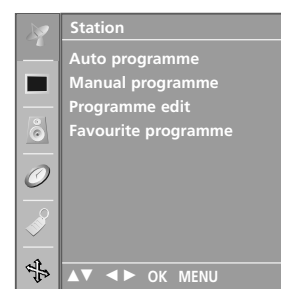
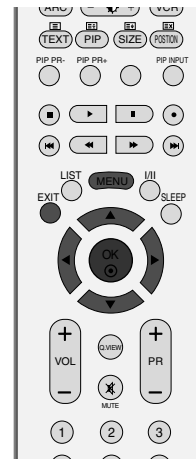

1



2



3 4 5

ASSIGNING A STATION NAME

You can assign a station name with five characters to each programme number.

- 1 Press the **MENU** button and then **▲ / ▼** button to select the **Station** menu.
- 2 Press the **▶** button and then **▲ / ▼** button to select **Manual programme**.
- 3 Press the **▶** button and then **▲ / ▼** button to select **Name**.
- 4 Press the **▶** button and then **▲ / ▼** button. You can use a blank, **+**, **-**, the number **0** to **9** and the alphabet **A** to **Z**.
- 5 Press the **◀ / ▶** button to select the position and make your choice of the second character, and so on.
- 6 Press the **OK** button to store it.
- 7 Press the **EXIT** button to return to normal TV viewing.

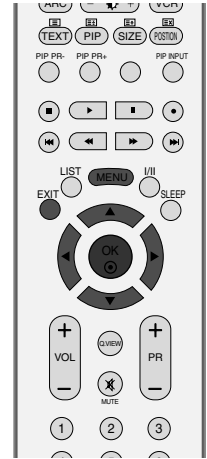

1

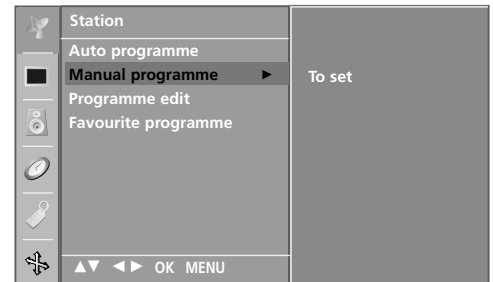

2

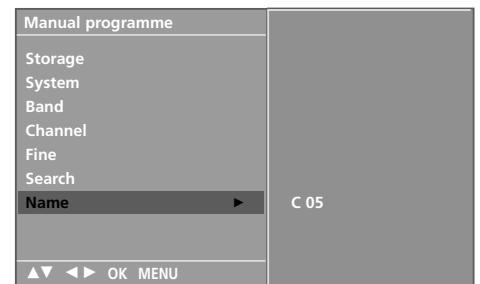

3 4 5 6

PROGRAMME EDIT

This function enables you to delete or skip the stored programmes. Also you can move some stations to other programme numbers or copy a blank station data into the selected programme number.

1 Press the **MENU** button and then **▲ / ▼** button to select the **Station** menu.

2 Press the **▶** button and then **▲ / ▼** button to select **Programme edit**.

3 Press the **▶** button to display the Programme edit menu.

■ Deleting a programme

1. Select a programme to be deleted with the **▲ / ▼ / ◀ / ▶** button.
2. Press the **RED** button twice.
The selected programme is deleted, all the following programmes are shifted up one position.

■ Copying a programme

1. Select a programme to be copied with the **▲ / ▼ / ◀ / ▶** button.
2. Press the **GREEN** button.
All the following programmes are shifted down one position.

■ Moving a programme

1. Select a programme to be moved with the **▲ / ▼ / ◀ / ▶** button.
2. Press the **YELLOW** button.
3. Move the programme to the desired programme number with the **▲ / ▼ / ◀ / ▶** button.
4. Press the **YELLOW** button again to release this function.

■ Skipping a programme number

1. Select a programme number to be skipped with the **▲ / ▼ / ◀ / ▶** button.
2. Press the **BLUE** button. The skipped programme turns to blue.
3. Press the **BLUE** button again to release the skipped programme.
When a programme number is skipped it means that you will be unable to select it using the **▲ / ▼** button during normal TV viewing. If you want to select the skipped programme, directly enter the programme number with the **NUMBER** buttons or select it in the programme edit or table menu.

4 Press the **EXIT** button to return to normal TV viewing.

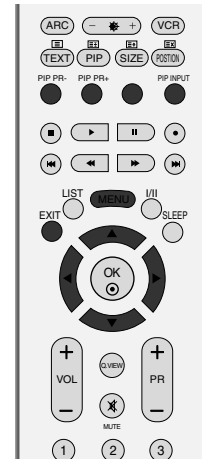

1



2

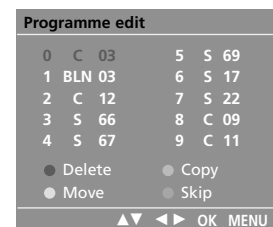

3

FAVOURITE PROGRAMME

This function lets you select your favourite programmes directly.
Repeatedly press the **FAV** button to select stored favourite programmes.

- 1 Press the **MENU** button and then ▲ / ▼ button to select the **Station** menu.
- 2 Press the ► button and then ▲ / ▼ button to select **Favourite programme**.
- 3 Press the ► button.
- 4 Press the ▲ / ▼ button to select - - - - -.
- 5 Select a desired programme with the ◀ / ▶ button or NUMBER buttons. Any number under 10 is entered with a numeric '0' in front of it, i.e. '05' for 5.
- 6 To store another programme, repeat steps 4 to 5. You can store up to 8 programmes.
- 7 Press the **EXIT** button to return to normal TV viewing.



1

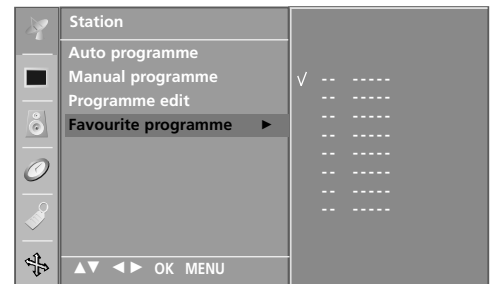

2 3 4 5

CALLING THE PROGRAMME TABLE

You can check the programmes stored in the memory by displaying the programme table.

■ Displaying programme table

Press the **LIST** button to display the Programme table menu.

The programme table appears on the screen.

One programme table contains ten programmes as shown.

! NOTE

- You may find some blue programmes. They have been set up to be skipped by auto programming or in the programme edit mode.
- Some programmes with the channel number shown in the programme table indicate there is no station name assigned.

■ Selecting a programme in the programme table

Select a programme with the **▲ / ▼ / ◀ / ▶** button.

Then press the **OK** button. The set switches to the chosen programme number.

■ Paging through a programme table

There are 10 programme table pages in which contain 100 programmes. Pressing the **▲ / ▼ / ◀ / ▶** button repeatedly turns the pages.

Press the **LIST** button to return to normal TV viewing.

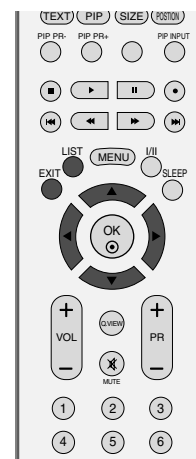

0	C	03	5	S	69
1	BLN	03	6	S	17
2	C	12	7	S	22
3	S	66	8	C	09
4	S	67	9	C	11

PSM (Picture Status Memory)

- Dynamic** Select this option to display with a sharp image.
- Standard** The most general and natural screen display status.
- Mild** Select this option to display with a mild image.
- User 1/2** Select this option to use the user-defined setting.

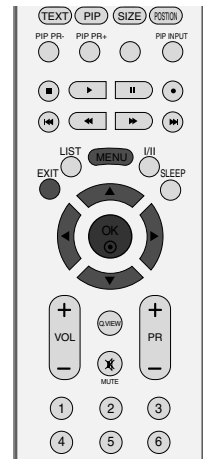

- 1 Press the **MENU** button and then **▲ / ▼** button to select the **Picture** menu.

- 2 Press the **▶** button and then **▲ / ▼** button to select **PSM**.

- 3 Press the **▶** button and then **▲ / ▼** button to select **Dynamic, Standard, Mild, User 1, or User 2**.

- 4 Press the **EXIT** button to return to normal TV viewing.

- PSM adjusts the TV for the best picture appearance. Select the preset value in the PSM menu based on the programme category.
- **Dynamic, Standard and Mild**, are programmed for optimum picture reproduction at the factory and cannot be changed.

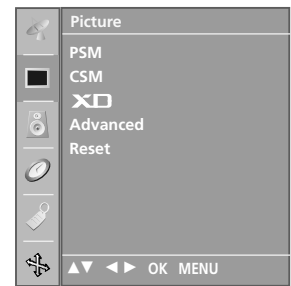

1

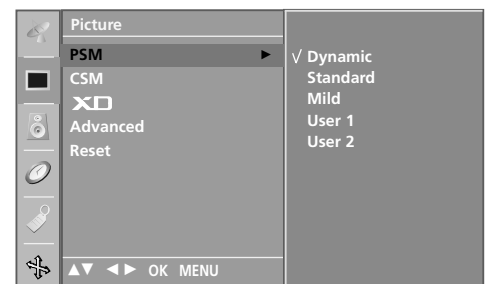

2 3

Picture Adjustment (PSM-User option)

- Contrast** Adjusts the difference between the light and dark levels in the picture.
- Brightness** Increases or decreases amount of white in the your picture.
- Colour** Adjusts intensity of all colours.
- Sharpness** Adjusts the level of crispness in the edges between the light and dark areas of the picture. The lower the level, the softer the image.
- Tint** Adjusts the balance between red and green levels.

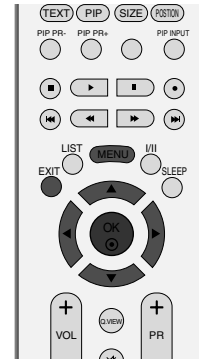

- 1 Press the **MENU** button and then **▲ / ▼** button to select the **Picture** menu.
- 2 Press the **▶** button and then **▲ / ▼** button to select **PSM**.
- 3 Press the **▶** button and then **▲ / ▼** button to select **User 1**, or **User 2**.
- 4 Press the **▶** button and then **▲ / ▼** button to select the desired picture option (**Contrast**, **Brightness**, **Colour**, **Sharpness**, and **Tint**).
- 5 Press the **◀ / ▶** button to make appropriate adjustments.
- 6 Press the **EXIT** button to return to normal TV viewing.

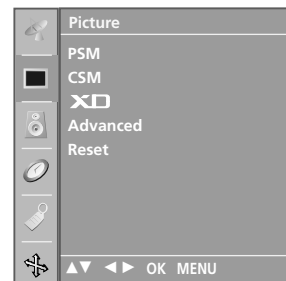

1

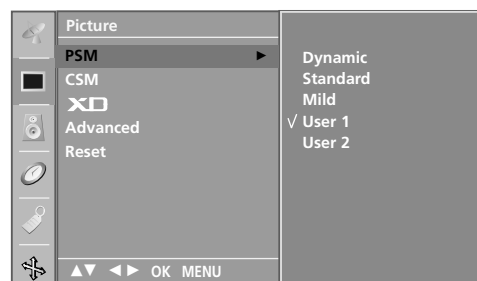

2 3

! NOTE

▶ You can't adjust colour, sharpness and tint in the RGB-PC mode to the levels you prefer.

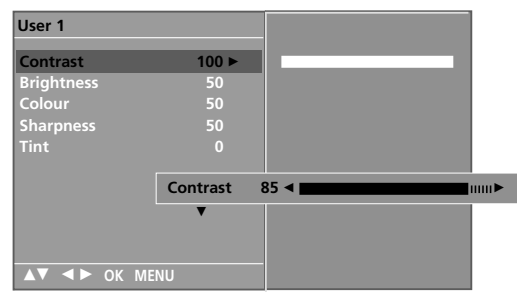

4 5

CSM (Colour Status Memory)

To initialize values (reset to default settings), select the **Normal** option.

Choose one of three automatic colour adjustments. Set to warm to enhance hotter colours such as red, or set to cool to see less intense colours with more blue.

- 1 Press the **MENU** button and then **▲ / ▼** button to select the **Picture** menu.
- 2 Press the **▶** button and then **▲ / ▼** button to select **CSM**.
- 3 Press the **▶** button and then **▲ / ▼** button to select either **Cool**, **Normal**, **Warm**, or **User**.
- 4 Press the **EXIT** button to return to normal TV viewing.

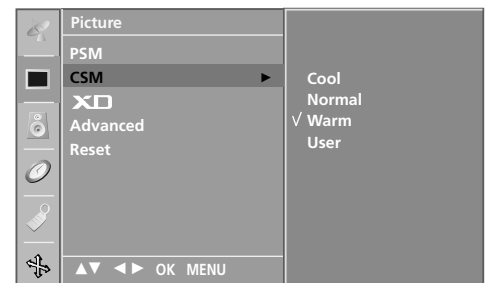
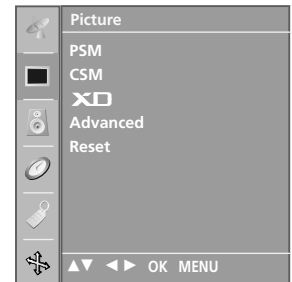
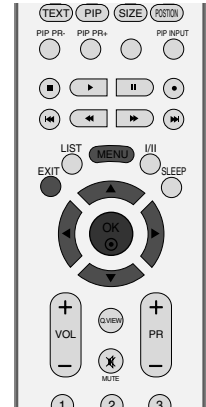

Manual Colour Temperature Control (CSM - User option)

To adjust red, green, blue to any colour temperature you prefer.

- 1 Press the **MENU** button and then **▲ / ▼** button to select the **Picture** menu.
- 2 Press the **▶** button and then **▲ / ▼** button to select **CSM**.
- 3 Press the **▶** button and then **▲ / ▼** button to select **User**.
- 4 Press the **▶** button and then **▲ / ▼** button to select **Red, Green, or Blue**.
- 5 Press the **◀ / ▶** button to make appropriate adjustments.
- 6 Press the **EXIT** button to return to normal TV viewing.

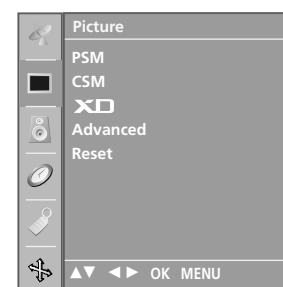
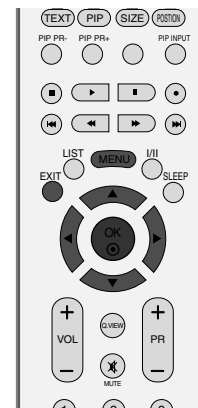

1

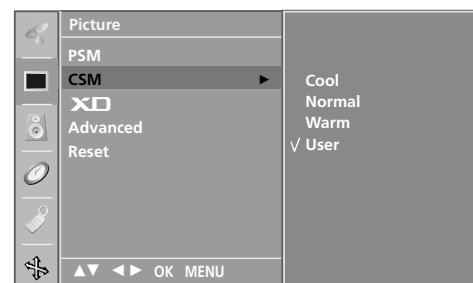

2 3



4 5

XD FUNCTION

XD is LG electronic's unique picture improving technology to display a real HD source through an advanced digital signal processing algorithm.

It's not available to use this function in RGB-PC mode.

- 1 Press the **MENU** button and then **▲ / ▼** button to select the **Picture** menu.
- 2 Press the **▶** button and then **▲ / ▼** button to select **XD**.
- 3 Press the **▶** button and then **▲ / ▼** button to select **Auto** or **Manual**.
- 4 Press the **EXIT** button to return to TV viewing.

* Selecting the Manual

This menu is activated after selecting the **User1** or **User2** of **PSM**.

- 1 Press the **▶** button and then **▲ / ▼** button to select **XD Contrast**, **XD Colour** or **XD NR**.
- 2 Press the **▶** button and then **▲ / ▼** button to select **On** or **Off**.
- 3 Press the **EXIT** button to return to normal TV viewing.

- **XD Contrast** : Optimizing the contrast automatically according to the brightness of the reflection.
- **XD Colour** : Adjusting the colors of the reflection automatically to reproduce as closely as possible to the natural colors.
- **XD NR** : Removing the noise up to the point where it does not damage the original picture. (It's not available to use this function in HDMI, Component (except 480i/576i), RGB-PC mode.)

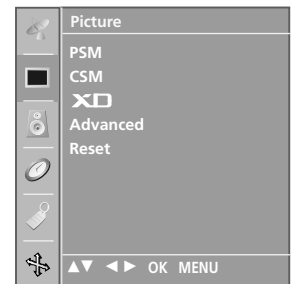
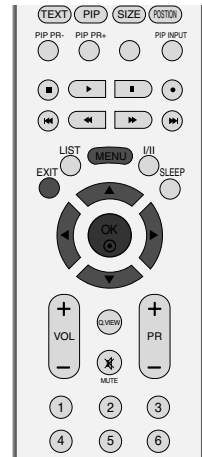

1

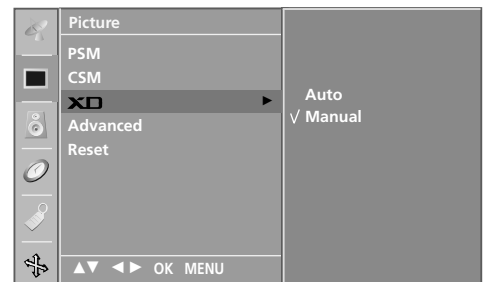

2 3



1 2

ADVANCED-CINEMA

Set up the TV for the best picture appearance for viewing movies.

This feature operates only in Analog TV, AV, S-Video and Component 480i/576i mode.

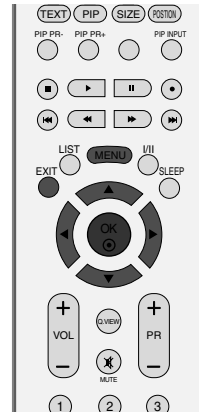

- 1 Press the **MENU** button and then **▲ / ▼** button to select the **Picture** menu.
- 2 Press the **▶** button and then **▲ / ▼** button to select **Advanced**.
- 3 Press the **▶** button and then **▲ / ▼** button to select **Cinema**.
- 4 Press the **▶** button and then **▲ / ▼** button to select **On** or **Off**.
- 5 Press the **EXIT** button to return to normal TV viewing.

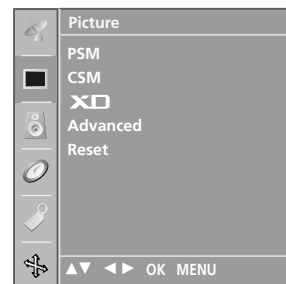

1



2 3

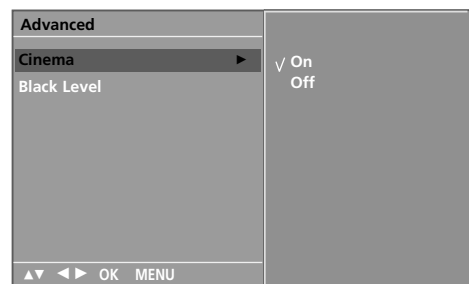

4

ADVANCED-BLACK LEVEL

When you watch the movie, this function adjusts the set to the best picture appearance. Adjusting the contrast and the brightness of the screen using the black level of the screen.

This function works in the following mode: AV (NTSC-M), S-Video (NTSC-M) or HDMI.

- 1 Press the **MENU** button and then **▲ / ▼** button to select the **Picture** menu.
- 2 Press the **▶** button and then **▲ / ▼** button to select **Advanced**.
- 3 Press the **▶** button and then **▲ / ▼** button to select **Black Level**.
- 4 Press the **▶** button and then **▲ / ▼** button to select **Low** or **High**.
 - **Low** : The reflection of the screen gets darker.
 - **High** : The reflection of the screen gets brighter.
- 5 Press the **EXIT** button to return to normal TV viewing.

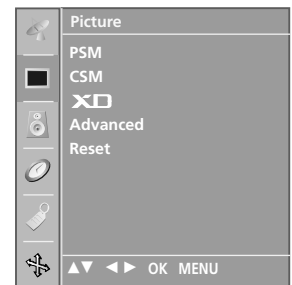
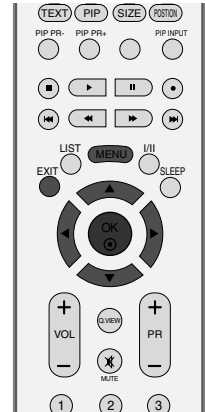

1

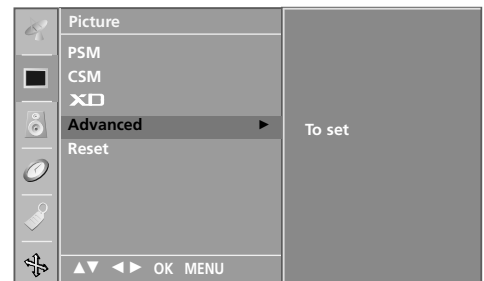

2 3

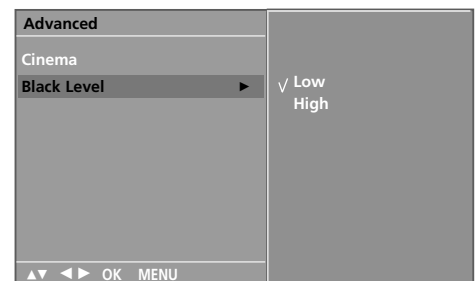

2 3

RESET

- 1 Press the **MENU** button and then ▲ / ▼ button to select the **Picture** menu.
- 2 Press the ► button and then ▲ / ▼ button to select **Reset**.
- 3 Press the ► button to initialize the adjusted value.
 - Returns to the default settings PSM, CSM, XD, Advanced at the factory.

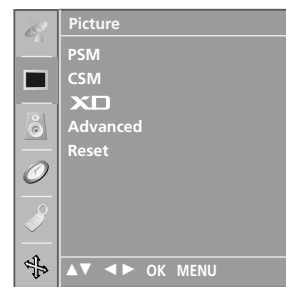
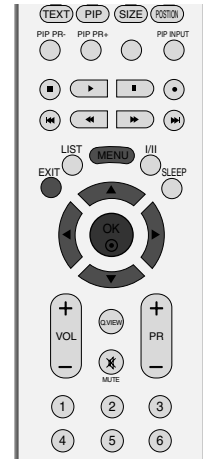

SSM (Sound Status Memory)

You can select your preferred sound setting; Surround MAX, Flat, Music, Movie or Sports and you can also adjust the sound frequency of the equalizer.

SSM lets you enjoy the best sound without any special adjustment because the TV sets the appropriate sound options based on the programme content.

Surround Max, Flat, Music, Movie, and Sports are preset for good sound quality at the factory and are not adjustable.

Surround Max Select this option to sound realistic.

Flat The most commanding and natural audio.

Music Select this option to enjoy the original sound when listening to the music.

Movie Select this option to enjoy sublime sound.

Sports Select this option to watch sports broadcasting.

User Select this option to use the user-defined audio settings.

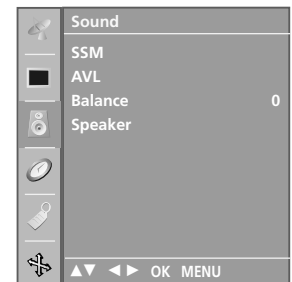

1

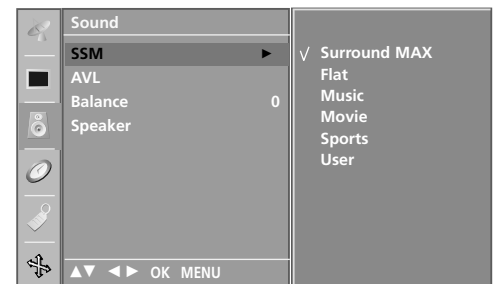

2 3

1 Press the **MENU** button and then ▲ / ▼ button to select the **Sound** menu.

2 Press the ► button and then ▲ / ▼ button to select **SSM**.

3 Press the ► button and then ▲ / ▼ button to select **Surround Max, Flat, Music, Movie, Sports** or **User**.

4 Press the **EXIT** button to return to normal TV viewing.

Sound Frequency Adjustment (SSM - User option)

Adjust the sound equalizer.

- 1 Press the **MENU** button and then **▲ / ▼** button to select the **Sound** menu.
- 2 Press the **▶** button and then **▲ / ▼** button to select **SSM**.
- 3 Press the **▶** button and then **▲ / ▼** button to select **User**.
- 4 Press the **▶** button.
- 5 Select a sound band by pressing the **◀ / ▶** button.
Make appropriate sound level with the **▲ / ▼** button.
- 6 Press the **EXIT** button to return to normal TV viewing.

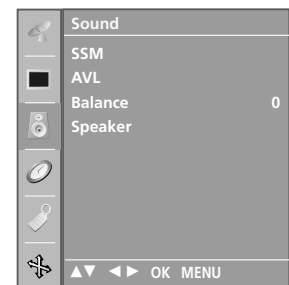
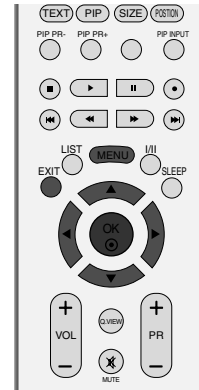

1



2 3 4

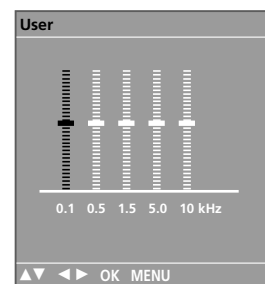

5

AVL (Auto Volume Leveler)

AVL automatically keeps on an equal volume level even if you change programmes.

- 1 Press the **MENU** button and then ▲ / ▼ button to select the **Sound** menu.
- 2 Press the ► button and then ▲ / ▼ button to select **AVL**.
- 3 Press the ► button and then ▲ / ▼ button to select **On** or **Off**.
- 4 Press the **EXIT** button to return to normal TV viewing.

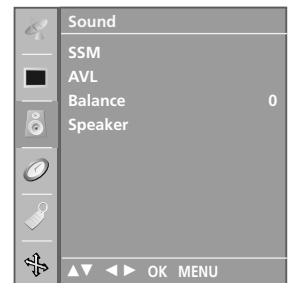
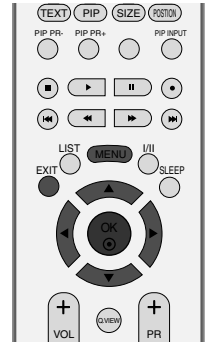

1

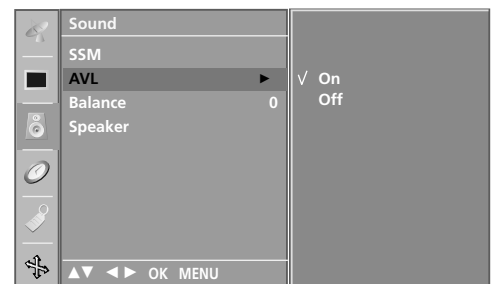

2 3

BALANCE ADJUSTMENT

You can adjust the sound balance of speaker to the levels you prefer.

- 1 Press the **MENU** button and then **▲ / ▼** button to select the **Sound** menu.
- 2 Press the **▶** button and then **▲ / ▼** button to select **Balance**.
- 3 Press the **▶** button and then **◀ / ▶** button to make desired adjustment.
- 4 Press the **EXIT** button to return to normal TV viewing.

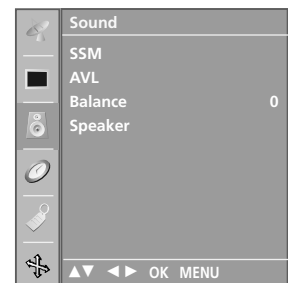
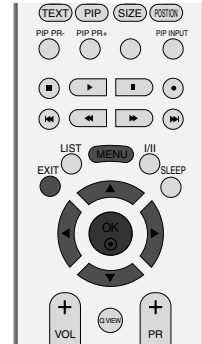

1

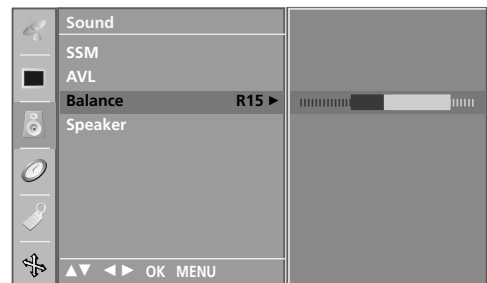

2 3

SPEAKER

You can adjust the internal speaker status.

In AV, COMPONENT, RGB[PC], RGB[DTV] and HDMI mode, internal speaker audio can be outputted even though there is no video signal.

If you want to use your external hi-fi stereo system, turn off the internal speakers of the set.

- 1 Press the **MENU** button and then ▲ / ▼ button to select the **Sound** menu.
- 2 Press the ► button and then ▲ / ▼ button to select **Speaker**.
- 3 Press the ► button and then ▲ / ▼ button to select **On** or **Off**.
- 4 Press the **EXIT** button to return to normal TV viewing.

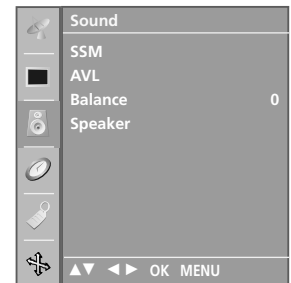
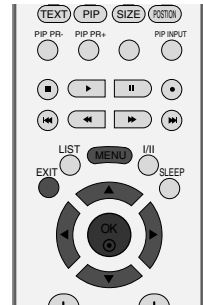

STEREO/DUAL RECEPTION

When a programme is selected, the sound information for the station appears after the programme number and station name disappear.

- DUAL I** Sends the primary broadcast language to the loudspeakers.
- DUAL II** Sends the secondary broadcast language to the loudspeakers.
- DUAL I+II** Sends a separate language to each loudspeaker.

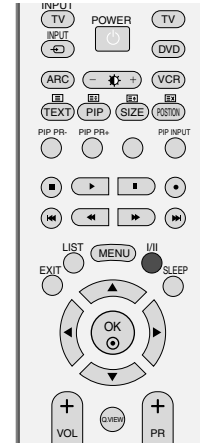

Broadcast	On Screen Display
Mono	MONO
Stereo	STEREO
Dual	DUAL I

- **Mono sound selection**
 If the stereo signal is weak in stereo reception, you can switch to mono by pressing the I/II button twice. In mono reception, the depth of sound is improved. To switch back to stereo, press the I/II button twice again.
- **Language selection for dual language broadcast**
 If a programme received two languages (dual language), you can switch to **DUAL I**, **DUAL II** or **DUAL I+II** by pressing the I/II button repeatedly.

NICAM RECEPTION

If the set is equipped with the receiver for NICAM reception, the high quality NICAM (Near Instantaneous Companding Audio Multiplex) digital sound can be received.

Sound output can be selected according to the type of received broadcast as follows by pressing the I/II button repeatedly.

-
- 1 When NICAM mono is received, you can select **NICAM MONO** or **FM MONO**.

 - 2 When NICAM stereo is received, you can select **NICAM STEREO** or **FM MONO**.
If the stereo signal is weak, switch to FM mono.

 - 3 When NICAM dual is received, you can select **NICAM DUAL I**, **NICAM DUAL II** or **NICAM DUAL I+II** or **MONO**.
-

SPEAKER SOUND OUTPUT SELECTION

In AV, S-Video, Component, RGB and HDMI mode, you can select output sound for the left and right loudspeakers.

Repeatedly press the I/II button to select the sound output.

L+R: Audio signal from audio L input is sent to the left loud speaker and audio signal from audio R input is sent to the right loud speaker.

L+L: Audio signal from audio L input is sent to left and right loud speakers.

R+R: Audio signal from audio R input is sent to left and right loud speakers.

TV MENU Time Menu Options

CLOCK SETUP

You must set the time correctly before using on/off time function.

If current time setting is erased by a power failure or the set is unplugged, reset the clock.

- 1 Press the **MENU** button and then **▲ / ▼** button to select the **Time** menu.
- 2 Press the **▶** button and then **▲ / ▼** button to select **Clock**.
- 3 Press the **▶** button and then **▲ / ▼** button to set the hour.
- 4 Press the **▶** button and then **▲ / ▼** button to set the minutes.
- 5 Press the **EXIT** button to return to normal TV viewing.

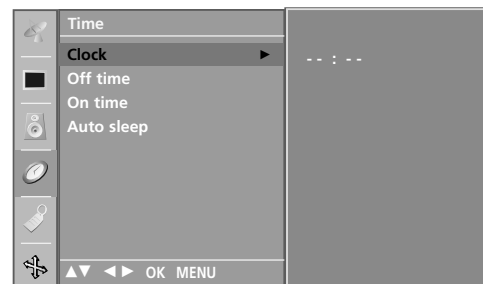
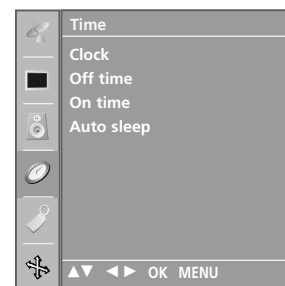
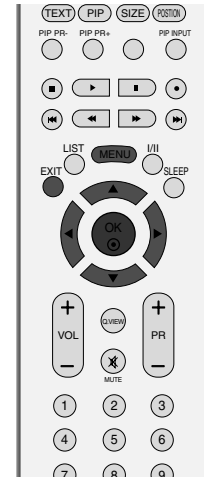

ON/OFF TIME

The Off time automatically switches the set to standby at the preset time.

Two hours after the set is switched on by the on time function it will automatically switch back to standby mode unless a button has been pressed.

Once the on time/off time is set, these functions operate daily at the preset time.

Off time function overrides On timer function if they are set both to the same time.

The set must be in standby mode for the On timer to work.

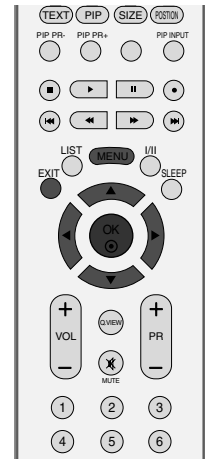

- 1 Press the **MENU** button and then **▲ / ▼** button to select the **Time** menu.
- 2 Press the **▶** button and then **▲ / ▼** button to select **Off time/On time**.
- 3 Press the **▶** button and then **▲ / ▼** button to select **On**.
 - To cancel **On/Off timer** function, select **Off**.
- 4 Press the **▶** button and then **▲ / ▼** button to set the hour.
- 5 Press the **▶** button and then **▲ / ▼** button to set the minutes.
- 6 **For only On timer function**
 - **Programme:** Press the **▶** button and then **▲ / ▼** button to select the programme.
 - **Volume:** Press the **▶** button and then **▲ / ▼** button to adjust volume level at turn-on.
- 7 Press the **EXIT** button to return to normal TV viewing.

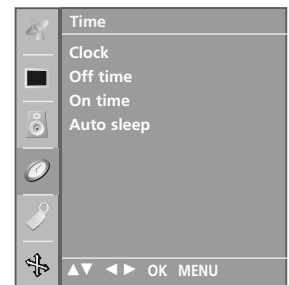

1

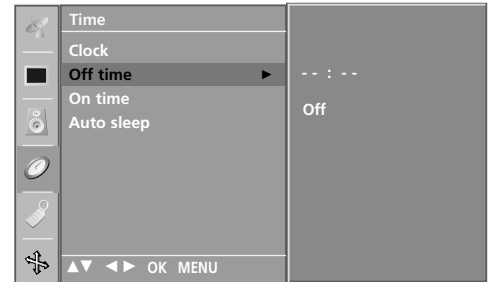

2 3

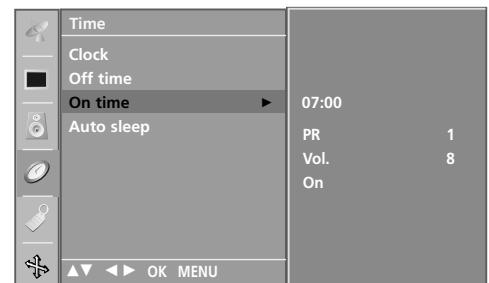

4 5 6

AUTO SLEEP

If set to on and there is no input signal, the TV turns off automatically after 10 minutes.

- 1 Press the **MENU** button and then **▲ / ▼** button to select the **Time** menu.
- 2 Press the **▶** button and then **▲ / ▼** button to select **Auto sleep**.
- 3 Press the **▶** button and then **▲ / ▼** button to select **On** or **Off**.
- 4 Press the **EXIT** button to return to normal TV viewing.

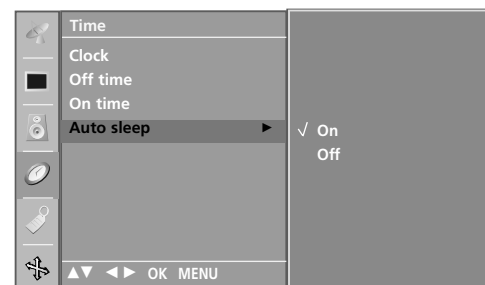
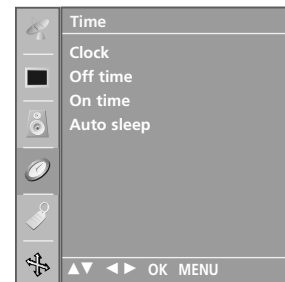

SLEEP TIMER

You don't have to remember to switch the set off before you go to sleep. The sleep timer automatically switches the set to stand-by after the preset time has elapsed.

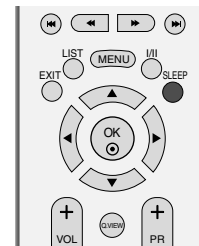

- 1 Press the **SLEEP** button repeatedly to select the number of minutes. The display 'Ⓢzz - - -' will appear on the screen, followed by 10, 20, 30, 60, 90, 120, 180 and 240.
- 2 When the number of minutes you want is displayed on the screen, the timer begins to count down from the number of minutes selected.

! NOTE

- ▶ To view the remaining sleep time, press the **SLEEP** button once.
- ▶ To cancel the sleep time, repeatedly press the **SLEEP** button until the display 'Ⓢzz - - -' appears.
- ▶ When you switch the set off, the set releases the preset sleep time.

CHILD LOCK

The TV can be set so that the remote control is needed to control it.

This feature can be used to prevent unauthorized viewing.

This set is programmed to remember which option it was last set to even if you turn the set off.

- 1 Press the **MENU** button and then **▲ / ▼** button to select the **Special** menu.
- 2 Press the **▶** button and then **▲ / ▼** button to select **Child lock**.
- 3 Press the **▶** button and then **▲ / ▼** button to select **On** or **Off**.
- 4 Press the **EXIT** button to return to normal TV viewing.

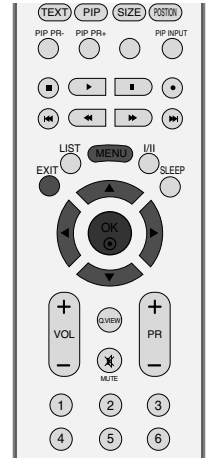

1

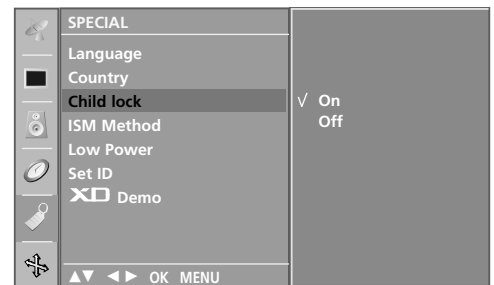

2 3

! NOTE

- ▶ In **Child lock 'On'**, if the set is turned off, press the **⏻ / I, INPUT, PR ▲ / ▼** button on the set or **POWER, INPUT, TV, PR +/-** or **NUMBER** buttons on the remote control.
- ▶ With the **Child lock On**, the display **'Child lock on'** appears on the screen if any button on the front panel is pressed while viewing the set.

ISM (Image Sticking Minimization) METHOD

A frozen or still picture from a PC/video game displayed on the screen for prolonged periods will result in a ghost image remaining even when you change the image. Avoid allowing a fixed image to remain on the set's screen for a long period of time.

It's not available to use this function in LCD models.

White wash

White wash removes permanent images from the screen.

Note: An excessive permanent image may be impossible to clear entirely with White Wash.

Orbiter

Orbiter may help prevent ghost images. However, it is best not to allow any fixed image to remain on the screen. To avoid a permanent image on the screen, the screen will move every 2 minutes.

Inversion

This is the function to invert the panel color of the screen. The panel color is automatically inverted every 30 minutes.

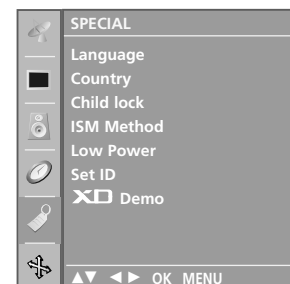
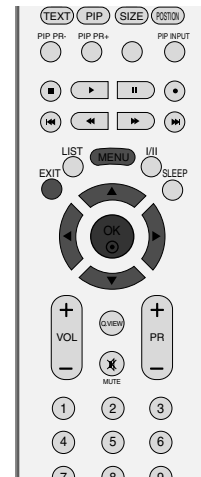

1

1 Press the **MENU** button and then **▲ / ▼** button to select the **Special** menu.

2 Press the **▶** button and then **▲ / ▼** button to select **ISM Method**.

3 Press the **▶** button and then **▲ / ▼** button to select either **Normal**, **White wash**, **Orbiter** or **Inversion**. If you unnecessary to set this function, set **Normal**.

4 Press the **EXIT** button to return to TV viewing.

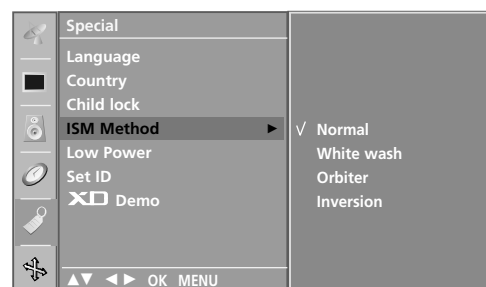

2 3

LOW POWER

This is the function to reduce the power consumption of the set.

It's not available to use this function in LCD models.

- 1 Press the **MENU** button and then **▲ / ▼** button to select the **Special** menu.
- 2 Press the **▶** button and then **▲ / ▼** button to select **Low power**.
- 3 Press the **▶** button and then **▲ / ▼** button to select **On** or **Off**.
- 4 Press the **EXIT** button to return to TV viewing.

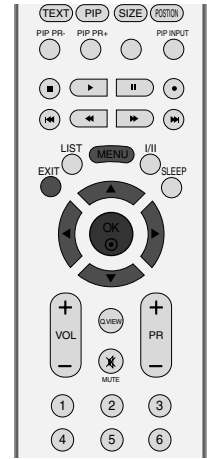

1

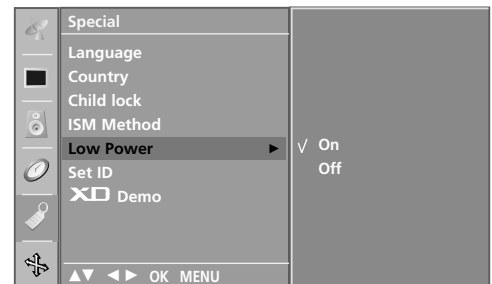

2 3

XD DEMO

Use it to see the difference between XD Demo on and XD Demo off.

It's not available to use this function in RGB[PC] mode.

- 1 Press the **MENU** button and then use ▲ / ▼ button to select the **Special** menu.
- 2 Press the ► button and then use ▲ / ▼ button to select **XD Demo**.
- 3 Press the ► button to begin **XD Demo**.
- 4 To stop **XD Demo**, press the **MENU** button.

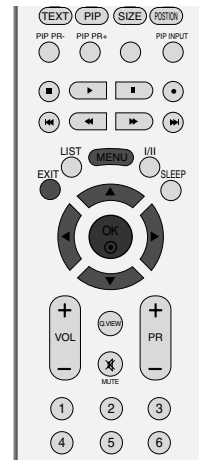

1



2 3

• **XD Demo**



AUTO CONFIGURE (RGB [PC] mode only)

Automatically adjusts picture position and minimizes image shaking.

After adjustment, if the image is still not correct, your set is functioning properly but needs further adjustment.

Auto configure

This function is for the automatic adjustment of the screen position, clock, and phase. The displayed image will unstable for a few seconds while the auto configuration is in progress.

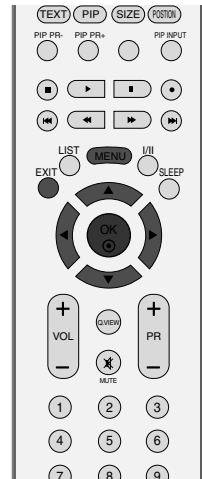

1 Press the **MENU** button and then use **▲ / ▼** button to select the **Screen** menu.

2 Press the **▶** button and then use **▲ / ▼** button to select **Auto config.**

3 Press the **▶** button to start **Auto config.**

- When **Auto config.** has finished, **OK** will be shown on screen.
- If the position of the image is still not correct, try Auto adjustment again.

- If picture needs to be adjusted more after Auto adjustment in RGB (PC), you can adjust the **Manual config.**

4 Press the **EXIT** button to return to TV viewing.

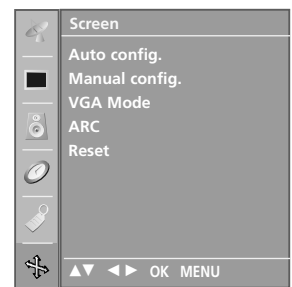

1

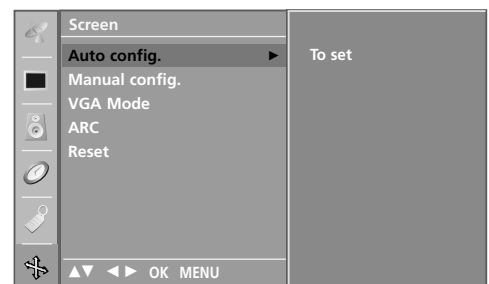

2 3

MANUAL CONFIGURE

If the picture isn't clear after auto adjustment and especially if characters are still trembling, adjust the picture phase manually.

To correct the screen size, adjust **Clock**.

This function works in the following mode : RGB[PC], RGB[DTV], COMPONENT (480p/576p/720p/1080i), HDMI (480p/576p/720p/1080i).

It's not available to use Phase, Clock function in RGB[DTV], COMPONENT (480p/576p/720p/1080i), HDMI (480p/576p/720p/1080i).

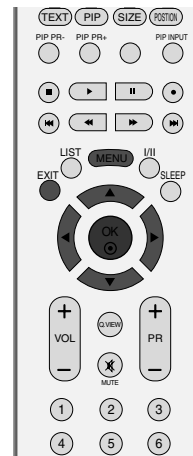

Clock This function is to minimize any vertical bars or stripes visible on the screen background. And the horizontal screen size will also change.

Phase This function allows you to remove any horizontal noise and clear or sharpen the image of characters.

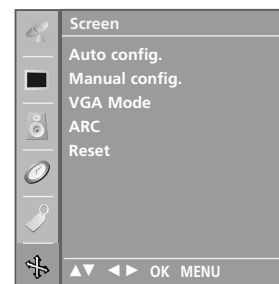

1 Press the **MENU** button and then use ▲ / ▼ button to select the **Screen** menu.

2 Press the ► button and then ▲ / ▼ button to select **Manual config.**

3 Press the ► button and then ▲ / ▼ button to select **Phase, Clock, H-Position** or **V-Position**.

4 Press the ◀ / ▶ button to make appropriate adjustments.

5 Press the **EXIT** button to return to TV viewing.

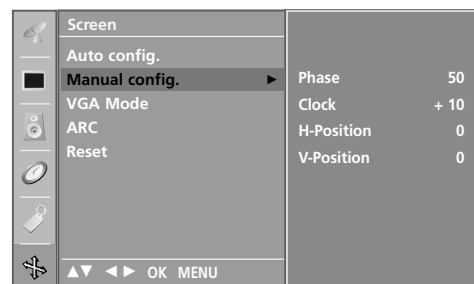

SETTING THE PICTURE FORMAT

You can watch the screen in various picture formats; **Spectacle, Full, Original, 4:3, 16:9, 14:9** and **Zoom**.

If a fixed image is displayed on the screen for a long time, that fixed image may become imprinted on the screen and remain visible.

There might be uncomfortable in full mode. Then change into other mode.

You can adjust the enlarge proportion using **▲ / ▼** button.

This function works in the following signal.

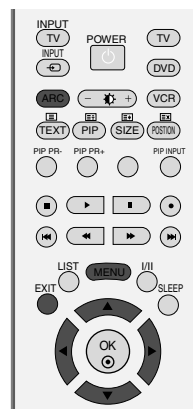

- 1 Press the **MENU** button and then use **▲ / ▼** button to select the **Screen** menu.
- 2 Press the **▶** button and then use **▲ / ▼** button to select **ARC**.
- 3 Press the **▶** button and then use **▲ / ▼** button to select **Spectacle, Full, Original, 4:3, 16:9, 14:9, Zoom1** or **Zoom2**.

- **Spectacle**

When your TV receives the wide screen signal, when selected it will adjust the picture horizontally, in non-linear proportion, to fill the entire screen.

- **Full**

When your TV receives the wide screen signal, when selected it will adjust the picture horizontally or vertically, in a linear proportion, to fill the entire screen fully. (This feature is not available in NTSC signal.)

- **Original**

When your TV receives the wide screen signal, it will be automatically changed to the picture format to be sent.

- **4:3**

Following selection will lead you to view a picture with an original 4:3 aspect ratio, with gray bars appearing at both the left and right sides.

- **16:9**

Following selection will lead you to adjust the picture horizontally, in a linear proportion, to fill the entire screen (useful for viewing 4:3 formatted DVDs).

- **14:9**

You can enjoy the picture format of 14:9 or general TV programme through the 14:9 mode. The screen 14:9 is viewed just like that the screen 4:3 is magnified to the left / right.

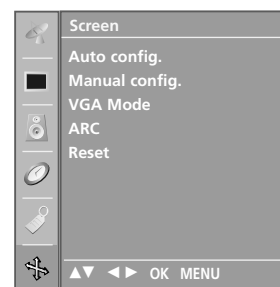

1

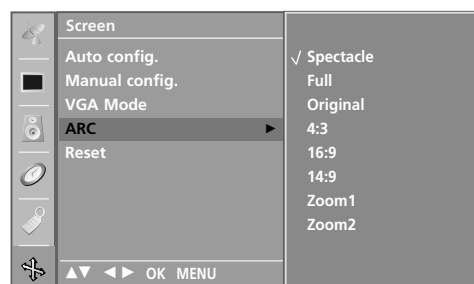

2 3

- **Zoom1**

Following selection will lead you to view the picture without any alternation, while filling the entire screen. However, the top and bottom portions of the picture will be cropped.

- **Zoom2**

Choose **Zoom2** when you want the picture to be altered, both horizontally extended and vertically cropped. The picture taking a halfway trade off between alteration and screen coverage.

-
- 4 Press the **EXIT** button to return to TV viewing.
-

! NOTE

- ▶ You can only select **4:3, 16:9 (Wide)** in Component, RGB, HDMI mode only.

SELECTING WIDE VGA/XGA MODE

To see a normal picture, match the resolution of RGB mode and selection of VGA/XGA mode.

This function works in the following mode: RGB[PC] mode.

VGA Mode: 42PC1RV, 42PC3RV*

XGA Mode: 26C2R*, 27LC2R*, 32LC2R*, 32LC25R*, 26LC3R*, 32LC3R*, 32LX2R*, 32LE2R*, 37LE2R*, 42LE2R*, 42PC3RA*

-
- 1 Press the **MENU** button and then use **▲ / ▼** button to select the **Screen** menu.
 - 2 Press the **▶** button and then use **▲ / ▼** button to select **VGA Mode** (or **XGA Mode**).
 - 3 Press the **▶** button and then use **▲ / ▼** button to select the desired VGA/XGA resolution.
 - 4 Press the **EXIT** button to return to TV viewing.
-

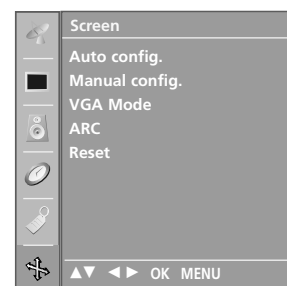
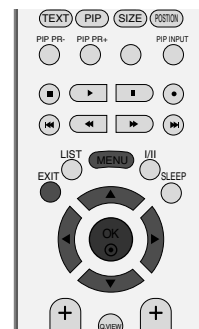

1

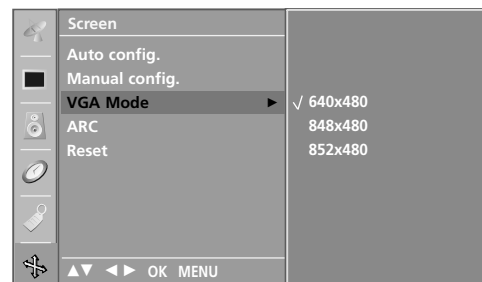

2 3

INITIALIZING (RESET TO ORIGINAL FACTORY SETTINGS)

This function operates in current mode.
To initialize the adjusted value

- 1 Press the **MENU** button and then ▲ / ▼ button to select the **Screen** menu.
- 2 Press the ► button and then ▲ / ▼ button to select **Reset**.
- 3 Press the ► button.
 - You can initialize Position, PIP size, PIP position.

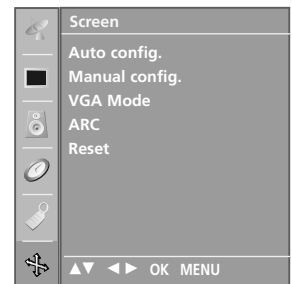
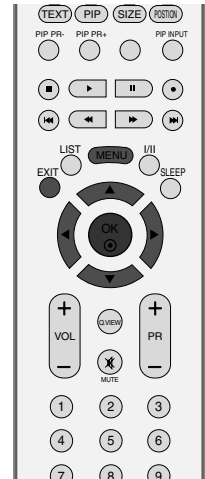

1

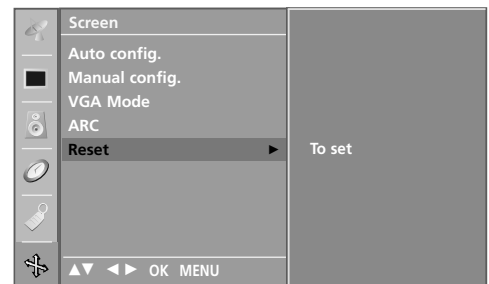

2 3

APPENDIX

PROGRAMMING THE REMOTE

The remote is a multi-brand or a universal remote. It can be programmed to operate most remote-controllable devices of other manufacturers.

Note that the remote may not control all models of other brands.

Programming a code into a remote mode

- 1 Test your remote control.
To find out whether your remote control can operate the component without programming, turn on the component such as a VCR and press the corresponding mode button (such as a **DVD** or **VCR**) on the remote control, while pointing at the component. Test the **POWER** and **PR + / -** buttons to see if the component responds properly. If not, the remote requires programming to operate the device.
- 2 Turn on the component to be programmed, then press the corresponding mode button (such as a **DVD** or **VCR**) on the remote control. The remote control button of desired device is lighted.
- 3 Press the **MENU** and **MUTE** buttons simultaneously, the remote control is ready to be programmed for the code.
- 4 Enter a code number using the number buttons on the remote control. Programming code numbers for the corresponding component can be found on the following pages. Again, if the code is correct, the device will turn off.
- 5 Press the **MENU** button to store the code.
- 6 Test the remote control functions to see if the component responds properly. If not, repeat from step 2.

Programming code

DVD

Brand	Codes	Brand	Codes	Brand	Codes
APEX DIGITAL	022	mitsubishi	002	RCA	005 006
DENON	020 014	NAD	023	SAMSUNG	011 015
GE	005 006	ONKYO	008 017	SONY	007
HARMAN KARDON	027	PANASONIC	003 009	THOMPSON	005 006
JVC	012	PHILIPS	013	TOSHIBA	019 008
LG	001 010 016 025	PIONEER	004 026	YAMAHA	009 018
MAGNAVOX	013	PROCEED	021	ZENITH	010 016 025
MARANTZ	024	PROSCAN	005 006		

APPENDIX

VCRs

Brand	Codes	Brand	Codes	Brand	Codes
AIWA	034	MAGNAVOX	031 033 034 041	SAMSUNG	032 040 102 104
AKAI	016 043 046 124		067 068		105 107 109 112
	125 146	MARANTZ	012 031 033 067		113 115 120 122
AMPRO	072		069		125
ANAM	031 033 103	MARTA	101	SANSUI	022 043 048 135
AUDIO DYNAMICS	012 023 039 043	MATSUI	027 030	SANYO	003 007 010 014
BROKSONIC	035 037 129	MEI	031 033		102 134
CANON	028 031 033	MEMOREX	003 010 014 031	SCOTT	017 037 112 129
CAPEHART	108		033 034 053 072		131
CRAIG	003 040 135		101 102 134 139	SEARS	003 008 009 010
CURTIS MATHES	031 033 041	MGA	045 046 059		013 014 017 020
DAEWOO	005 007 010 064	MINOLTA	013 020		031 042 073 081
	065 108 110 111	MITSUBISHI	013 020 045 046		101
	112 116 117 119		049 051 059 061	SHARP	031 054 149
DAYTRON	108		151	SHINTOM	024
DBX	012 023 039 043	MTC	034 040	SONY	003 009 031 052
DYNATECH	034 053	MULTITECH	024 034		056 057 058 076
ELECTROHOME	059	NEC	012 023 039 043		077 078 149
EMERSON	006 017 025 027		048	SOUNDESIGN	034
	029 031 034 035	NORDMENDE	043	STS	013
	036 037 046 101	OPTONICA	053 054	SYLVANIA	031 033 034 059
	129 131 138 153	PANASONIC	066 070 074 083		067
FISHER	003 008 009 010		133 140 145	SYMPHONIC	034
FUNAI	034			TANDY	010 034
GE	031 033 063 072	PENTAX	013 020 031 033	TATUNG	039 043
	107 109 144 147		063	TEAC	034 039 043
GO VIDEO	132 136	PHILCO	031 034 067	TECHNICS	031 033 070
HARMAN KARDON	012 045	PHILIPS	031 033 034 054	TEKNIKA	019 031 033 034
HITACHI	004 018 026 034		067 071 101		101
	043 063 137 150	PILOT	101	THOMAS	034
INSTANTREPLAY	031 033	PIONEER	013 021 048	TMK	006
JCL	031 033	PORTLAND	108	TOSHIBA	008 013 042 047
JCPENNY	012 013 015 033	PULSAR	072		059 082 112 131
	040 066 101	QUARTZ	011 014	TOTEVISION	040 101
JENSEN	043	QUASAR	033 066 075 145	UNITECH	040
JVC	012 031 033 043	RCA	013 020 033 034	VECTOR RESEARCH	012
	048 050 055 060		040 041 062 063	VICTOR	048
	130 150 152		107 109 140 144	VIDEO CONCEPTS	012 034 046
KENWOOD	014 034 039 043		145 147	VIDEOSONIC	040
	047 048	REALISTIC	003 008 010 014	WARDS	003 013 017 024
LG (GOLDSTAR)	001 012 013 020		031 033 034 040		031 033 034 040
	101 106 114 123		053 054 101		053 054 131
LLOYD	034	RICO	058	YAMAHA	012 034 039 043
LXI	003 009 013 014	RUNCO	148	ZENITH	034 048 056
	017 034 101 106	SALORA	014		058 072 080 101
MAGIN	040				

TROUBLESHOOTING CHECKLIST

The operation does not work normally.	
The remote control doesn't work	<ul style="list-style-type: none"> ■ Check to see if there is any object between the product and the remote control causing obstruction. ■ Are batteries installed with correct polarity (+ to +, - to -)? ■ Correct remote operating mode set: TV, VCR etc.? ■ Install new batteries.
Power is suddenly turned off	<ul style="list-style-type: none"> ■ Is the sleep timer set? ■ Check the power control settings. Power interrupted ■ No broadcast on station tuned with Auto off activated.

The video function does not work.	
No picture & No sound	<ul style="list-style-type: none"> ■ Check whether the product is turned on. ■ Try another channel. The problem may be with the broadcast. ■ Is the power cord inserted into wall power outlet? ■ Check your antenna direction and/or location. ■ Test the wall power outlet, plug another product's power cord into the outlet where the product's power cord was plugged in.
Picture appears slowly after switching on	<ul style="list-style-type: none"> ■ This is normal, the image is muted during the product startup process. Please contact your service center, if the picture has not appeared after five minutes.
No or poor color or poor picture	<ul style="list-style-type: none"> ■ Adjust Color in menu option. ■ Keep a sufficient distance between the product and the VCR. ■ Try another channel. The problem may be with the broadcast. ■ Are the video cables installed properly? ■ Activate any function to restore the brightness of the picture.
Horizontal/vertical bars or picture shaking	<ul style="list-style-type: none"> ■ Check for local interference such as an electrical appliance or power tool.
Poor reception on some channels	<ul style="list-style-type: none"> ■ Station or cable product experiencing problems, tune to another station. ■ Station signal is weak, reorient antenna to receive weaker station. ■ Check for sources of possible interference.
Lines or streaks in pictures	<ul style="list-style-type: none"> ■ Check antenna (Change the direction of the antenna).

APPENDIX

TROUBLESHOOTING CHECKLIST

The audio function does not work.	
Picture OK & No sound	<ul style="list-style-type: none">■ Press the VOL+/- (or Volume) button.■ Sound muted? Press MUTE button.■ Try another channel. The problem may be with the broadcast.■ Are the audio cables installed properly?
No output from one of the speakers	<ul style="list-style-type: none">■ Adjust Balance in menu option.
Unusual sound from inside the product	<ul style="list-style-type: none">■ A change in ambient humidity or temperature may result in an unusual noise when the product is turned on or off and does not indicate a fault with the product.

There is a problem in PC mode. (Only PC mode applied)	
The signal is out of range.	<ul style="list-style-type: none">■ Adjust resolution, horizontal frequency, or vertical frequency.■ Check the input source.
Vertical bar or stripe on background & Horizontal Noise & Incorrect position	<ul style="list-style-type: none">■ Work the Auto configure or adjust clock, phase, or H/V position.
Screen colour is unstable or single colour	<ul style="list-style-type: none">■ Check the signal cable.■ Reinstall the PC video card.

MAINTENANCE

Early malfunctions can be prevented. Careful and regular cleaning can extend the amount of time you will have your new TV. Be sure to turn the power off and unplug the power cord before you begin any cleaning.

Cleaning the Screen

- 1 Here's a great way to keep the dust off your screen for a while. Wet a soft cloth in a mixture of lukewarm water and a little fabric softener or dish washing detergent. Wring the cloth until it's almost dry, and then use it to wipe the screen.
- 2 Make sure the excess water is off the screen, and then let it air-dry before you turn on your TV.

Cleaning the Cabinet

- To remove dirt or dust, wipe the cabinet with a soft, dry, lint-free cloth.
- Please be sure not to use a wet cloth.

Extended Absence

CAUTION

- ▶ If you expect to leave your TV dormant for a long time (such as a vacation), it's a good idea to unplug the power cord to protect against possible damage from lightning or power surges.

APPENDIX

PRODUCT SPECIFICATIONS

MODELS		26LC2R*	26LC3R*	27LC2R*
		26LC2R-ZJ 26LC2RB-ZJ 26LC2RA-ZJ	26LC3R-ZJ	27LC2R-ZJ
Dimensions (Width x Height x Depth)	with stand	681.0 x 542.0 x 172.0 mm 26.8 x 21.3 x 6.8 inches	680.0 x 550.0 x 235.0 mm 26.8 x 21.7 x 9.3 inches	686.0 x 550.0 x 235.0 mm 27.0 x 21.7 x 9.3 inches
	without stand	681.0 x 490.8 x 119.0 mm 26.8 x 19.3 x 4.6 inches	680.0 x 436.6 x 119.4 mm 26.8 x 17.2 x 4.7 inches	686.0 x 493.5 x 119.4 mm 27.0 x 19.4 x 4.7 inches
Weight	with stand	18.5 kg / 40.8 lbs	12.4 kg / 27.3 lbs	14.5 kg / 32.0 lbs
	without stand	15.2 kg / 33.5 lbs	11.5 kg / 25.3 lbs	11.4 kg / 25.1 lbs
Power requirement Power Consumption Television System Program Coverage External Antenna Impedance		AC100-240V~ 50/60Hz 1.3A 130W	AC100-240V~ 50/60Hz 1.3A 130W	AC100-240V~ 50/60Hz 1.3A 130W
		PAL/SECAM B/G/D/K, PAL I/II, SECAM L/L' VHF: E2 ~ E12, UHF: E21 ~ E69, CATV: S1 ~ S20, HYPER: S21 ~ S47 75 Ω		
Environment condition	Operating Temperature Operating Humidity	0 ~ 40°C / 32 ~ 104°F Less than 80%		
	Storage Temperature Storage Humidity	-20 ~ 60°C / -4 ~ 140°F Less than 85%		

- The specifications shown above may be changed without prior notice for quality improvement.

PRODUCT SPECIFICATIONS

MODELS		32LC2R*	32LC25R*	32LC3R*	32LX2R*
		32LC2R-ZJ 32LC2RB-ZJ 32LC2RA-ZJ	32LC25R-ZJ	32LC3R-ZJ	32LX2R-ZJ
Dimensions (Width x Height x Depth)	with stand	811.0 x 630.0 x 235.0 mm 31.9 x 24.8 x 9.3 inches	935.0 x 570.0 x 244.0 mm 36.8 x 22.4 x 9.6 inches	917.5 x 614.3 x 287.5 mm 36.1 x 24.2 x 11.3 inches	
	without stand	811.0 x 566.8 x 123.5 mm 31.9 x 22.3 x 4.9 inches	923.0 x 522.0 x 124.0 mm 36.4 x 20.6 x 4.9 inches	917.5 x 522.0 x 124.0 mm 36.1 x 20.6 x 4.9 inches	
Weight	with stand	21.9 kg / 48.2 lbs	19.8 kg / 43.7 lbs	25.2 kg / 55.6 lbs	
	without stand	18.5 kg / 40.8 lbs	17.9 kg / 39.5 lbs	17.9 kg / 39.5 lbs	
Power requirement		AC100-240V~ 50/60Hz 1.5A	AC100-240V~ 50/60Hz 1.5A	AC100-240V~ 50/60Hz 2.0A	
Power Consumption		150W	150W	140W	
Television System		PAL/SECAM B/G/D/K, PAL I/II, SECAM L/L'			
Program Coverage		VHF: E2 ~ E12, UHF: E21 ~ E69, CATV: S1 ~ S20, HYPER: S21 ~ S47			
External Antenna Impedance		75 Ω			
Environment condition	Operating Temperature	0 ~ 40°C / 32 ~ 104°F			
	Operating Humidity	Less than 80%			
Environment condition	Storage Temperature	-20 ~ 60°C / -4 ~ 140°F			
	Storage Humidity	Less than 85%			

- The specifications shown above may be changed without prior notice for quality improvement.

APPENDIX

PRODUCT SPECIFICATIONS

MODELS		32LE2R*	37LE2R*	42LE2R*
		32LE2R-ZJ	37LE2R-ZJ	42LE2R-ZJ
Dimensions (Width x Height x Depth)	with stand	811.0 x 630.0 x 235.0 mm 31.9 x 24.8 x 9.3 inches	943.9 x 286.0 x 734.6 mm 372 x 11.3 x 28.9 inches	1054.0 x 813.5 x 286.0 mm 41.5 x 32.0 x 11.2 inches
	without stand	811.0 x 566.8 x 123.5 mm 31.9 x 22.3 x 4.9 inches	943.9 x 152.2 x 695.5 mm 372 x 6.0 x 27.4 inches	1054.0 x 746.0 x 136.8 mm 41.5 x 29.3 x 5.3 inches
Weight	with stand	21.9 kg / 48.2 lbs	28.6 kg / 63.0 lbs	36.9 kg / 81.3 lbs
	without stand	18.5 kg / 40.8 lbs	24.0 kg / 52.9 lbs	31.3 kg / 69.0 lbs
Power requirement		AC100-240V~ 50/60Hz 1.5A	AC100-240V~ 50/60Hz 2.0A	AC100-240V~ 50/60Hz 2.5A
Power Consumption		150W	190W	240W
Television System		PAL/SECAM B/G/D/K, PAL I/II, SECAM L/L'		
Program Coverage		VHF: E2 ~ E12, UHF: E21 ~ E69, CATV: S1 ~ S20, HYPER: S21 ~ S47		
External Antenna Impedance		75 Ω		
Environment condition	Operating Temperature	0 ~ 40°C / 32 ~ 104°F		
	Operating Humidity	Less than 80%		
	Storage Temperature	-20 ~ 60°C / -4 ~ 140°F		
	Storage Humidity	Less than 85%		

- The specifications shown above may be changed without prior notice for quality improvement.

PRODUCT SPECIFICATIONS

MODELS		42PC1RV*	42PC3RV*	42PC3RA*
		42PC1RV-ZJ 42PC1RVA-ZJ	42PC3RV-ZJ	42PC3RA-ZJ
Dimensions (Width x Height x Depth)	with stand	1129.0 x 748.5 x 380.0 mm 44.4 x 29.5 x 15.0 inches	1129.0 x 748.5 x 333.6 mm 44.4 x 29.5 x 13.1 inches	1129.0 x 748.5 x 333.6 mm 44.4 x 29.5 x 13.1 inches
	without stand	1129.0 x 695.0 x 103.7 mm 44.4 x 27.4 x 4.1 inches	1129.0 x 695.0 x 103.7 mm 44.4 x 27.4 x 4.1 inches	1129.0 x 695.0 x 103.7 mm 44.4 x 27.4 x 4.1 inches
Weight	with stand	27.7 kg / 61.1 lbs	31.5 kg / 69.4 lbs	31.5 kg / 69.4 lbs
	without stand	24.2 kg / 53.4 lbs	24.2 kg / 53.3 lbs	24.2 kg / 53.3 lbs
Power requirement		AC100-240V~ 50/60Hz 3.0A	AC100-240V~ 50/60Hz 3.0A	AC100-240V~ 50/60Hz 3.5A
Power Consumption		260W	260W	310W
Television System		PAL/SECAM B/G/D/K, PAL I/II, SECAM L/L'		
Program Coverage		VHF: E2 ~ E12, UHF: E21 ~ E69, CATV: S1 ~ S20, HYPER: S21 ~ S47		
External Antenna Impedance		75 Ω		
Environment condition	Operating Temperature	0 ~ 40°C / 32 ~ 104°F		
	Operating Humidity	Less than 80%		
	Storage Temperature	-20 ~ 60°C / -4 ~ 140°F		
	Storage Humidity	Less than 85%		

■ The specifications shown above may be changed without prior notice for quality improvement.

LG Electronics Inc.