

Installation / Operating Guide | Warranty

Model Numbers | H24F39DT | H25F39DT | H27F39DT | Concierge™ TVs



table of contents

page 5

For Customer Support/Service please call:

1-888-865-3026

www.zenith.com

RECORD THE MODEL NUMBER

The model and serial number of the Concierge™ TV are located on the back of the cabinet. For future reference, we suggest that those numbers be recorded here:

MODEL NO. _____

SERIAL NO. _____

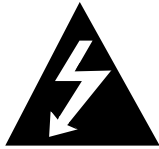

WARNING
RISK OF ELECTRIC SHOCK
DO NOT OPEN



WARNING:

TO REDUCE THE RISK OF ELECTRIC SHOCK DO NOT REMOVE COVER (OR BACK). NO USER SERVICEABLE PARTS INSIDE. REFER TO QUALIFIED SERVICE PERSONNEL.



The lightning flash with arrowhead symbol, within an equilateral triangle, is intended to alert the user to the presence of uninsulated "dangerous voltage" within the product's enclosure that may be of sufficient magnitude to constitute a risk of electric shock to persons.



The exclamation point within an equilateral triangle is intended to alert the user to the presence of important operating and maintenance (servicing) instructions in the literature accompanying the appliance.

WARNING:

TO PREVENT FIRE OR SHOCK HAZARDS, DO NOT EXPOSE THIS PRODUCT TO RAIN OR MOISTURE.

POWER CORD POLARIZATION:

CAUTION: TO PREVENT ELECTRIC SHOCK, MATCH WIDE BLADE OF PLUG TO WIDE SLOT, FULLY INSERT.

ATTENTION: POUR ÉVITER LES CHOCS ÉLECTRIQUES, INTRODUIRE LA LAME LA PLUS LARGE DE LA FICHE DANS LA BORNE CORRESPONDANTE DE LA PRISE ET POUSSER JUSQU'AU FOND.

NOTE TO CABLE/TV INSTALLER:

This reminder is provided to call the cable TV system installer's attention to Article 820-40 of the National Electric Code (U.S.A.). The code provides guidelines for proper grounding and, in particular, specifies that the cable ground shall be connected to the grounding system of the building, as close to the point of the cable entry as practical.

REGULATORY INFORMATION:

This equipment has been tested and found to comply with the limits for a Class B digital device, pursuant to Part 15 of the FCC Rules. These limits are designed to provide reasonable protection against harmful interference when the equipment is operated in a residential installation. This equipment generates, uses and can radiate radio frequency energy and, if not installed and used in accordance with the instruction manual, may cause harmful interference to radio communications. However, there is no guarantee that interference will not occur in a particular installation. If this equipment does cause harmful interference to radio or television reception, which can be determined by turning the equipment off and on, the user is encouraged to try to correct the interference by one or more of the following measures:

- Reorient or relocate the receiving antenna.
- Increase the separation between the equipment and receiver.
- Connect the equipment into an outlet on a circuit different from that to which the receiver is connected.
- Consult the dealer or an experienced radio/TV technician for help.

CAUTION:

Do not attempt to modify this product in any way without written authorization from Zenith Electronics Corporation. Unauthorized modification could void the user's authority to operate this product.

COMPLIANCE:

The responsible party for this product's compliance is:
Zenith Electronics Corporation, 2000 Millbrook Drive, Lincolnshire, IL 60069, USA. Phone: 1-847-941-8000.

IMPORTANT SAFETY INSTRUCTIONS

This product has been manufactured and tested with your safety in mind. However, improper use can result in potential electrical shock or fire hazards. To avoid defeating the safeguards that have been built into the new product, please read and observe the following safety points when installing and using the new product, and save them for future reference.

Observing the simple precautions discussed in this operating guide can help the user get many years of enjoyment and safe operation that are built into the new product.

This product complies with all applicable U.S. Federal safety requirements, and those of the Canadian Standards Association.

1. Read Instructions

All the safety and operating instructions should be read before the product is operated.

2. Follow Instructions

All operating and use instructions should be followed.

3. Retain Instructions

The safety and operating instructions should be retained for future reference.

4. Heed Warnings

All warnings on the product and in the operating instructions should be adhered to.

5. Cleaning

Unplug this product from the wall outlet before cleaning. Do not use liquid cleaners or aerosol cleaners. Use a damp cloth for cleaning.

6. Water and Moisture

Do not use this product near water for example, near a bath tub, wash bowl, kitchen sink, or laundry tub, in a wet basement, or near a swimming pool.

7. Accessories

Do not place this product on a slippery or tilted surface, or on an unstable cart, stand, tripod, bracket, or table. The product may fall, causing serious injury to a child or adult, and serious damage to the product. Use only with a cart, stand, tripod, bracket, or table recommended by the manufacturer, or sold with the product. Any mounting of the product should follow the manufacturer's instructions, and should use a mounting accessory recommended by the manufacturer.

8. Transporting Product

A product and cart combination should be moved with care. Quick stops, excessive force, and uneven surfaces may cause the product and cart combination to overturn.

9. Attachments

Do not use attachments not recommended by the product manufacturer as they may cause hazards.

10. Ventilation

Slots and openings in the cabinet are provided for ventilation and to ensure reliable operation of the product and to protect it from overheating, and these openings must not be blocked or covered. The openings should never be blocked by placing the product on a bed, sofa, rug, or other similar surface. This product should not be placed in a built-in installation such as a bookcase or rack unless proper ventilation is provided or the manufacturer's instructions have been adhered to.

11. Power Sources

This product should be operated only from the type of power source indicated on the marking label. If you are not sure of the type of power supply to your home, consult your product dealer or local power company. For products intended to operate from battery power, or other sources, refer to the operating instructions.

12. Power Cord Polarization

This product is equipped with a polarized alternating-current power plug (a plug having one blade wider than the other). This plug will fit into the power outlet only one way. This is a safety feature. If you are unable to insert the plug fully into the outlet, try reversing the plug. If the plug should still fail to fit, contact your electrician to replace your obsolete outlet. Do not defeat the safety purpose of the polarized plug.

13. Power-Cord Protection

Power-supply cords should be routed so that they are not likely to be walked on or pinched by items placed upon or against them, paying particular attention to cords at plugs, convenience receptacles, and the point where they exit from the product.

14. Outdoor Antenna Grounding

If an outside antenna or cable system is connected to the product, be sure the antenna or cable system is grounded so as to provide some protection against voltage surges and built-up static charges. Article 810 of the National Electrical Code (U.S.A.), ANSI/ NFPA 70 provides information with regard to proper grounding of the mast and supporting structure, grounding of the lead-in wire to an antenna discharge unit, size of grounding conductors, location of antenna-discharge unit, connection to grounding electrodes, and requirements for the grounding electrode.



PORTABLE CART WARNING

(Continued on next page)

IMPORTANT SAFETY INSTRUCTIONS

(Continued from previous page)

Example of Grounding According to National Electrical Code Instructions

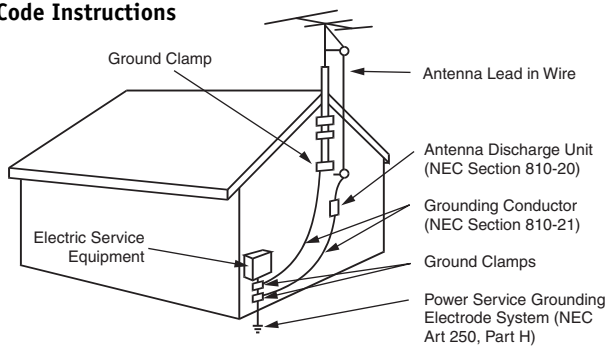

NEC- National Electrical Code

15. Lightning

For added protection for this product (receiver) during a lightning storm, or when it is left unattended and unused for long periods of time, unplug it from the wall outlet and disconnect the antenna or cable system. This will prevent damage to the product due to lightning and power-line surges.

16. Power Lines

An outside antenna system should not be located in the vicinity of overhead power lines or other electric light or power circuits, or where it can fall into such power lines or circuits. When installing an outside antenna system, extreme care should be taken to keep from touching such power lines or circuits as contact with them might be fatal.

17. Overloading

Do not overload wall outlets and extension cords as this can result in a risk of fire or electric shock.

18. Object and Liquid Entry

Never push objects of any kind into this product through openings as they may touch dangerous voltage points or short-out parts that could result in a fire or electric shock. Never spill liquid of any kind on the product.

19. Servicing

Do not attempt to service this product yourself as opening or removing covers may expose you to dangerous voltage or other hazards. Refer all servicing to qualified service personnel.

20. Damage Requiring Service

Unplug this product from the wall outlet and refer servicing to qualified service personnel under the following conditions:

- If the power-supply cord or plug is damaged.
- If liquid has been spilled, or objects have fallen into the product.
- If the product has been exposed to rain or water.
- If the product does not operate normally by following the operating instructions. Adjust only those controls that are covered by the operating instructions as an improper adjustment of other controls may

result in damage and will often require extensive work by a qualified technician to restore the product to its normal operation.

- If the product has been dropped or the cabinet has been damaged.
- If the product exhibits a distinct change in performance.

21. Replacement Parts

When replacement parts are required, be sure the service technician has used replacement parts specified by the manufacturer or have the same characteristics as the original part. Unauthorized substitutions may result in fire, electric shock, or other hazards.

22. Safety Check

Upon completion of any service or repairs to this product, ask the service technician to perform safety checks to determine that the product is in proper operating condition.

23. Wall or Ceiling Mounting

The product should be mounted to a wall or ceiling only as recommended by the manufacturer.

24. Heat

The product should be situated away from heat sources such as radiators, heat registers, stoves, or other products (including amplifiers) that produce heat.

25. CAUTION concerning the Power Cord:

Most appliances recommend they be placed upon a dedicated circuit; that is, a single outlet circuit which powers only that appliance and has not additional outlets or branch circuits. Check the specification page of this owner's manual to be certain.

Do not overload wall outlets. Overloaded wall outlets, loose or damaged wall outlets, extension cords, frayed power cords, or damaged or cracked wire insulation are dangerous. Any of these conditions could result in electric shock or fire. Periodically examine the cord of your appliance, and if its appearance indicates damage or deterioration, unplug it, discontinue use of the appliance, and have the cord replaced with an exact replacement part by an authorized servicer.

Protect the power cord from physical or mechanical abuse, such as being twisted, kinked, pinched, closed in a door, or walked upon. Pay particular attention to plugs, wall outlets, and the point where the cord exits the appliance.

26. Outdoor Use Marking :

WARNING - To reduce the risk of fire or electric shock, do not expose this appliance to rain or moisture.

27. Wet Location Marking :

Apparatus shall not be exposed to dripping or splashing and no objects filled with liquids, such as vases, shall be placed on the apparatus.

Table of Contents

Use the steps outlined below as a setup guide and to determine the TV features that will require adjustment for the needs of the end user

Safety Warnings	2	Add/Del/Blank	16
Important Safety Instructions	3	Channel Labels	17
Table of Contents	5	Clock Set	18
		Timer (On/Off Timer)	19
		Captions (Caption/Text)	20
		Language	21
Step 1. Hook Up TV		Video Menu	22
TV and other Equipment Hookups		Installer Parental Control Menu	23 - 24
Antenna	6	Other Menus and On-Screen Displays	25
Cable service	7	Managing the Channel Banks	26 - 27 - 28
Antenna with VCR	8	Installers Menus	29 - 30 - 31 - 32 - 33 - 34 - 35
Cable service with VCR	9		
External Speaker	10		
		Guest Operation Section (Copy for guest usage)	
Step 2. Channel Search and Reception Setup		Guest Remote Control Key Functions	13
Auto Program	11	Guest Parental Control Menu	36 - 37 - 38
(Select Antenna, or cable service and perform channel search)		Guest Menus and On-Screen Displays	39
Front Panel Controls	12		
Guest Remote Key Functions	13	Maintenance	40
Optional Installer's Remote Key Functions	14	Troubleshooting	41
On-Screen Menus Overview	15	Glossary	42
		Notes	43
		Warranty for Concierge™ Series TVs	Back Cover
Step 3. Customize the Concierge™ TV's Features			
Setup Menu (Start with page 11, Auto Program)			

Installer/Hotel Note:

Pages 13, 36, 37, 38, and 39 contain information and menus which the guest can use to operate the TV. It is recommended that these five pages be copied and included with the literature packet that the hotel provides to the guest.

Purchase the Optional Installer's Remote

To perform a normal installation set up, you need an installer's remote like the LP702. The LP702 is shown and described in later sections. The installer remote allows access to the Installer's menus, and User menus. The installer remote has Menu, Select, and Adjust Keys (Down/Left/Right arrow) keys. To purchase the LP702 remote, see your Zenith Dealer.

Note: Design and specifications are subject to change without prior notice.

Antenna Hook Up

Connect an over-the-air antenna to the Concierge TV

- 1** Locate the Antenna/Cable jack on the back of the Concierge TV.
- 2** Connect the antenna wire that runs from the wall, according to one of the diagrams to the right.
- 3** Remove the back of the remote and put in two AA batteries.

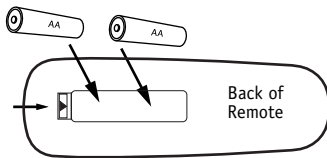

- 4** Plug in the TV. The TV is designed to operate on standard current, 120-volt 60 Hertz AC. Do not attempt to operate it on DC power.

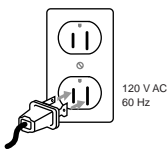

- 5** Go to page 11 to Auto Program the TV.



If you have a 75 ohm RF cable, then you don't need any adapters!



A 300 to 75 ohm adapter is not included with the Zenith Concierge TV.

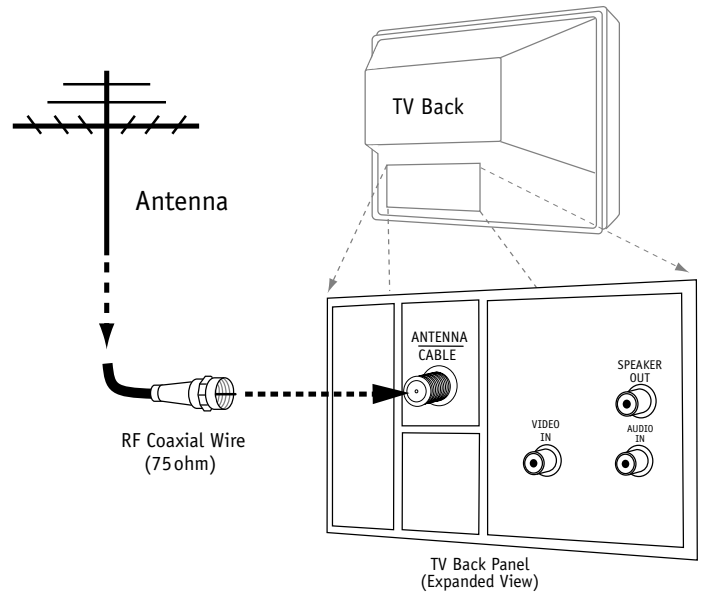
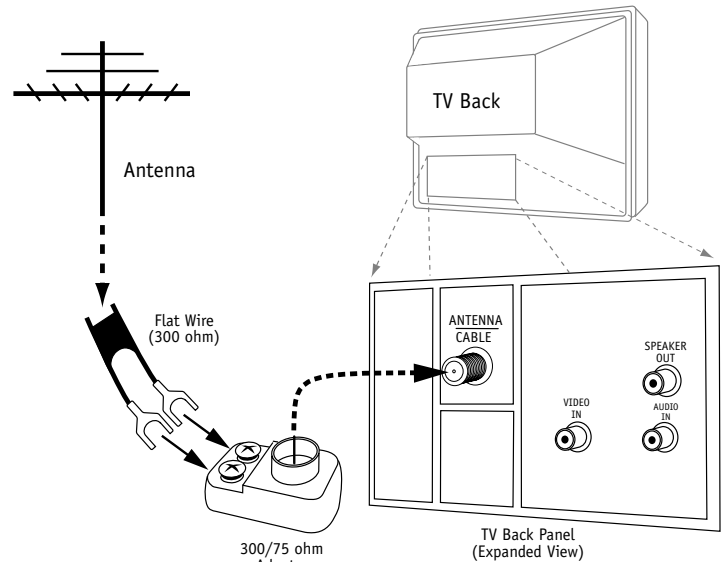

Mini glossary

- | | |
|-----------------------|---|
| 75 OHM RF CABLE | The wire that comes from an off-air antenna or cable service provider. Each end looks like a hex shaped nut with a wire sticking through the middle, and it screws onto the threaded jack on the back of your TV. |
| 300 TO 75 OHM ADAPTER | A small device that connects a two-wire 300 ohm antenna to a 75 ohm RF jack. They are usually about an inch long with two screws on one end and a round opening with a wire sticking out on the other end. |

Cable Service Hook Up (CATV)

Connect cable service to the Concierge TV

- 1** Locate the Antenna/Cable jack on the back of the Concierge TV.
- 2** Connect the cable service wire that runs from the wall, according to one of the diagrams to the right.
- 3** Remove the back of the remote and put in two AA batteries.

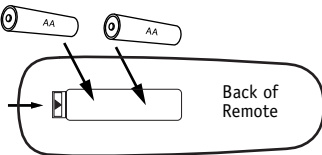

- 4** Plug in the TV. The Concierge TV is designed to operate on standard current, 120-volt 60 Hertz AC. Do not attempt to operate it on DC power.

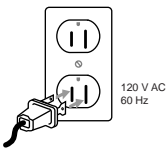

- 5** Go to page 11 to Auto Program the Concierge TV.



If you're using a cable box, leave the TV tuned to channel 3 or 4 and use the cable box to change channels.



If you're using a cable box, Auto Program might only find the channel your cable service is on (usually channel 3 or 4).

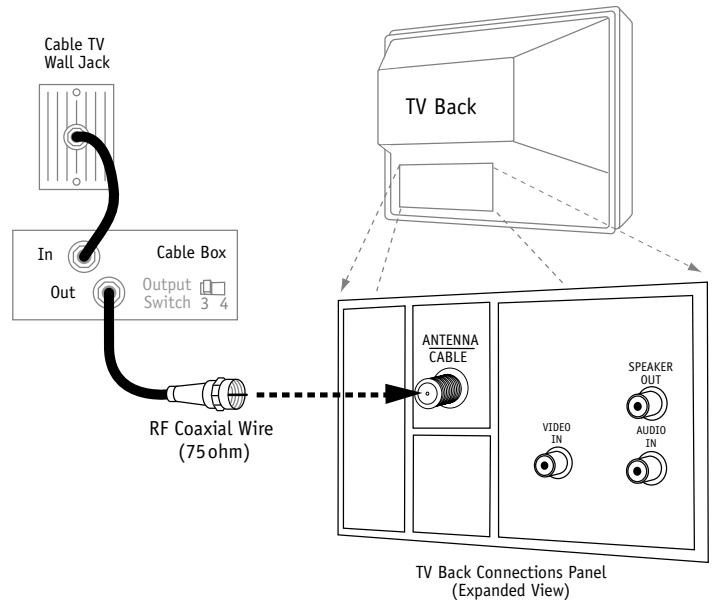
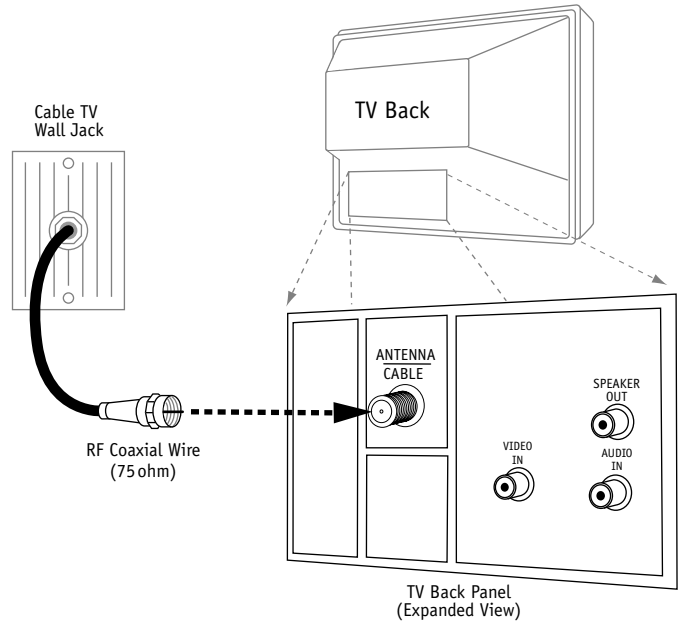

Antenna With VCR Hook Up

Connect an off-air antenna and VCR to the Concierge TV

1 Locate the Antenna/Cable jack on the back of the VCR.

2 Connect the antenna wire that runs from the antenna, according to one of the diagrams to the right. Make other connections as needed.

3 Remove the back of the remote and put in two AA batteries.

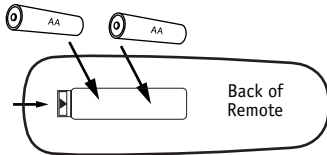

4 Plug in the TV. The Concierge TV is designed to operate on standard current, 120-volt 60 Hertz AC. Do not attempt to operate it on DC power.

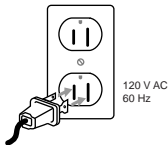

5 Go to page 11 to Auto Program the TV.



No A/V cables are included with the TV.

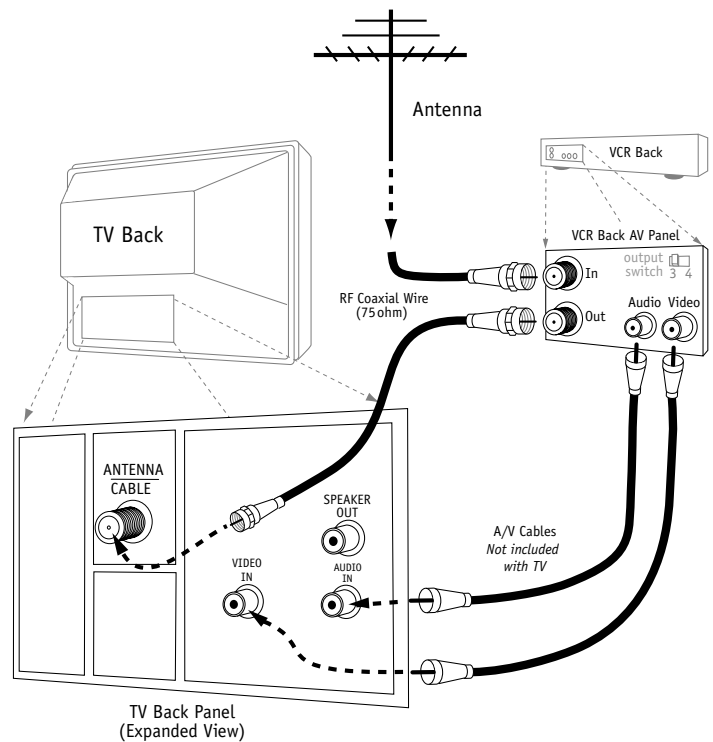
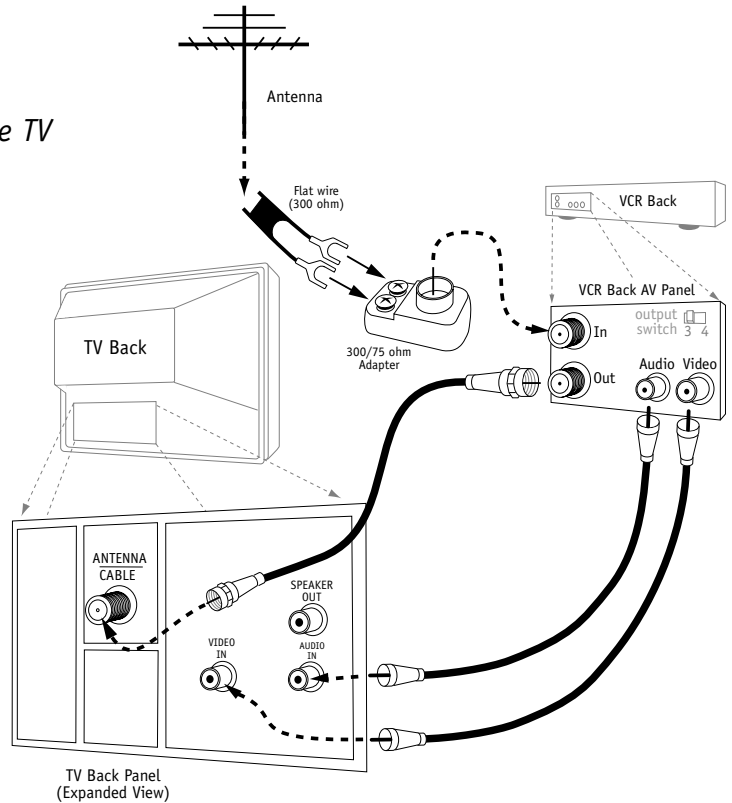

Cable Service (CATV) with VCR Hook Up

Connect a VCR and Cable service to the Concierge TV

- 1** Locate the Antenna/Cable jack on the back of the VCR.
- 2** Connect the cable service wire that runs from the wall, according to one of the diagrams to the right. Make other connections as needed.
- 3** Remove the back of the remote and put in two AA batteries.

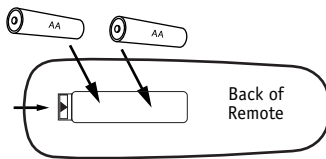

- 4** Plug in the TV. The Concierge TV is designed to operate on standard current, 120-volt 60 Hertz AC. Do not attempt to operate it on DC power.

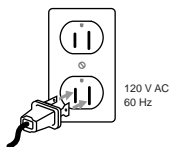

- 5** Go to page 11 to Auto Program the TV.



Leave the VCR and the television tuned to channel three and use the cable box to change channels.



No A/V cables are included with the TV.

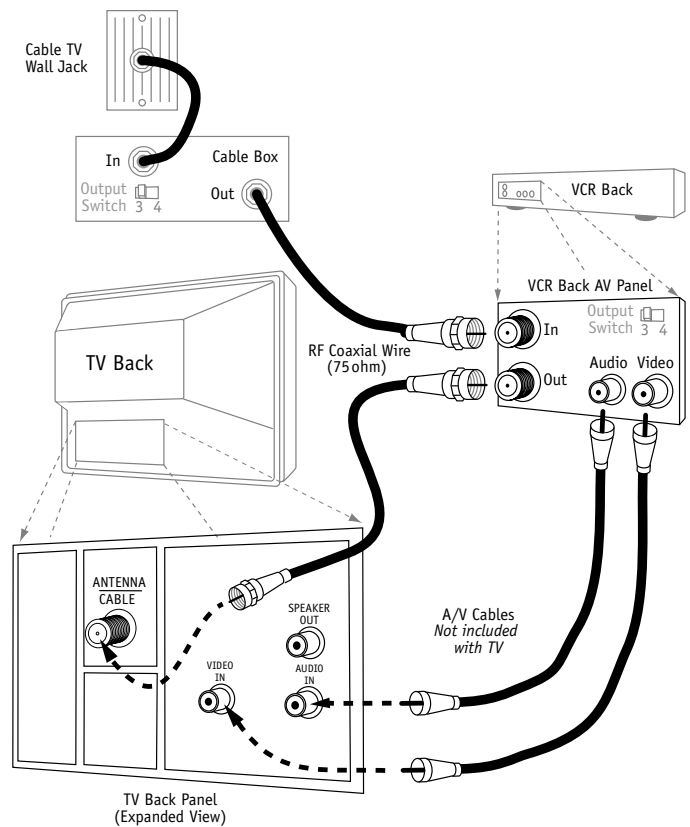
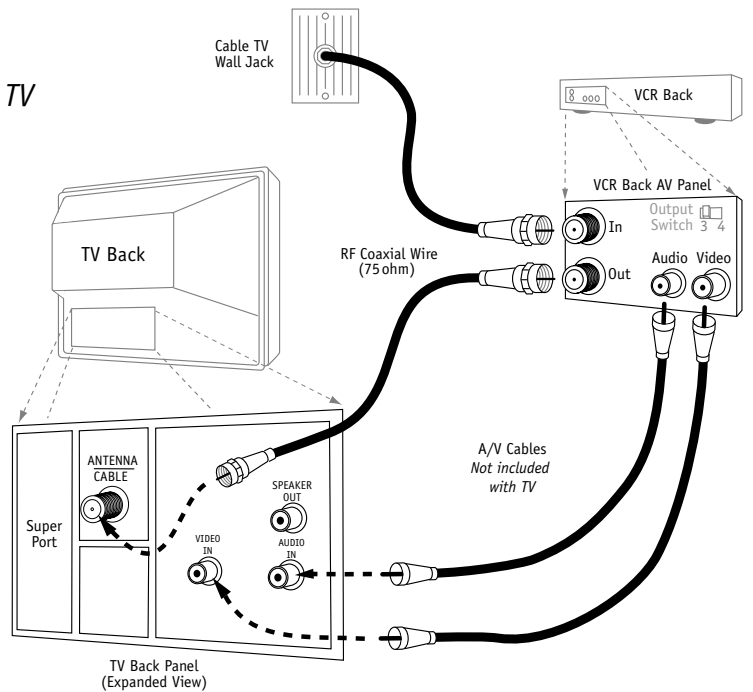

External Speaker Hook Up

Connect an external speaker to the TV

- 1** Locate the Audio In jack on the back of the external speaker.
- 2** Connect a standard audio cable from the Speaker Out jack on the TV, to the Audio In jack on the external speaker.

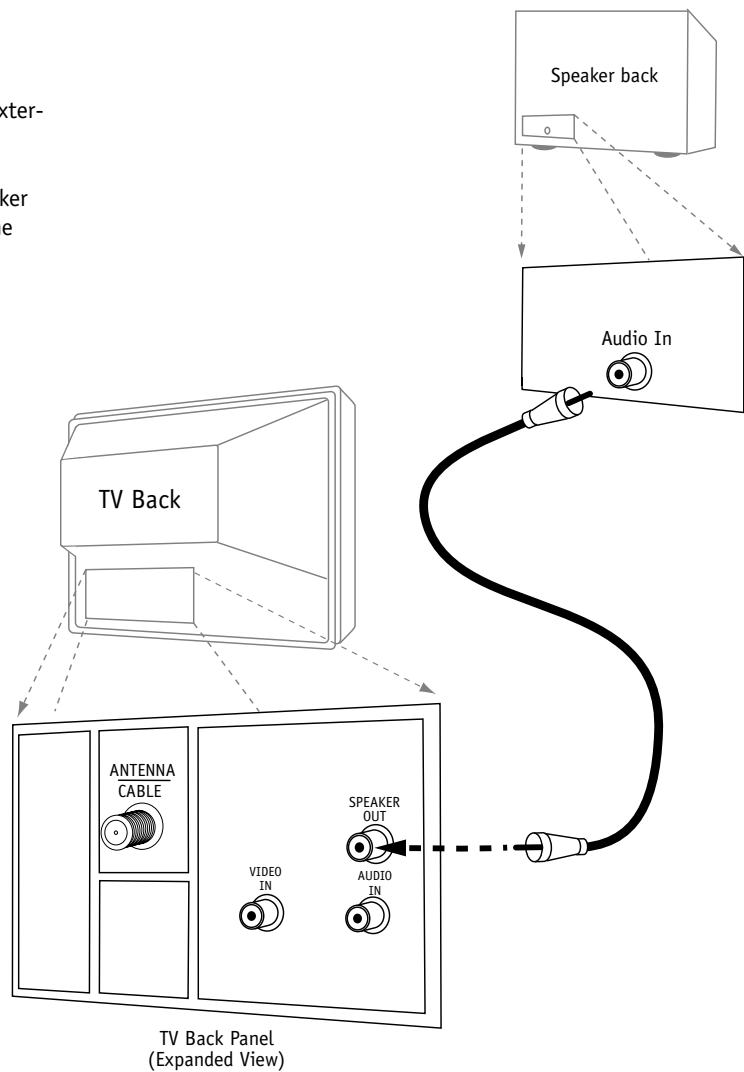

Auto Program (Channel Search)

Use Auto Program to specify Antenna or cable service incoming signal source and automatically store all of the channels that are found by channel search

SETUP MENU

▶ AUTO PROGRAM ◀ ◀◀ TO PROGRAM ▶▶
ADD/DEL/BLNK
CH. LABELS
CLOCK SET
TIMER
CAPTIONS
LANGUAGE

- 1 Using an Installer remote control, press the POWER key to turn on the Concierge TV.
- 2 Press the MENU key to show the SETUP MENU.
- 3 Using SELECT on the remote control, highlight AUTO PROGRAM on the screen.
- 4 Use the Right or Left ADJ (Adjust) arrow to go to the Auto Program menu.
- 5 Using SELECT, choose either CABLE TV or OFF AIR ANTENNA on your screen.
- 6 Press the Right or Left ADJ arrow key to begin the Channel Search.
- 7 Press ENTER when the channel search is complete.



Note: Auto Program finds channels being received by the TV tuner.



Cable will not work unless the lodge provides a cable service.

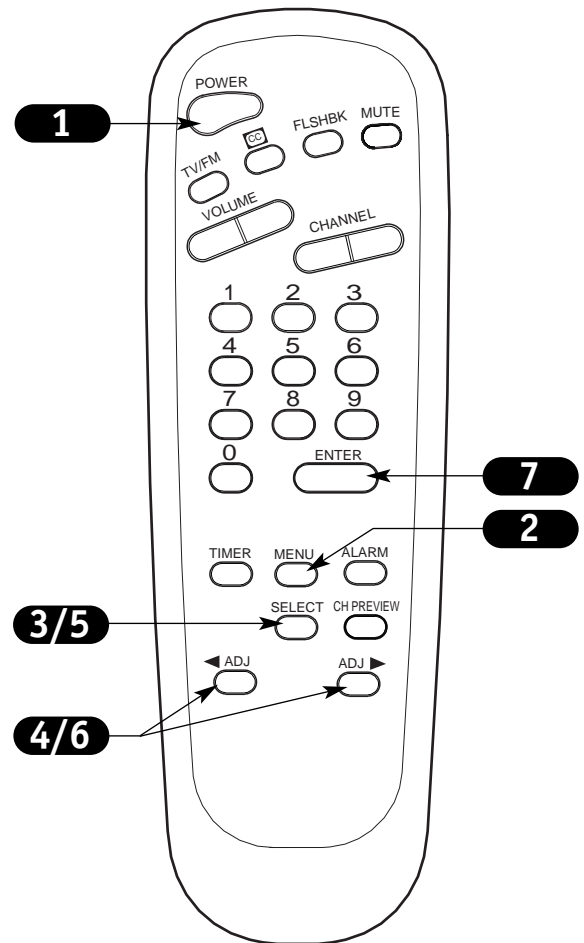

Mini glossary

OFF AIR ANTENNA If the guest can only view over-the-air broadcasts, select Antenna.
CABLE If you provide cable service to your guests, select Cable.

Front Panel Controls

Use the front control panel to access the menus or just operate the TV

*Note: Item 11 Key Defeat, in the installer's menu allows the installer to:
Set Menu Option 11, Key defeat to "0" - Front panel controls give access to menus.
Set Menu Option 11, Key defeat to "1" - Menus not available with front panel controls.*

- 1** Press POWER to turn on your TV.
- 2** To access the menus, press the MENU button on the control panel. Cycle through the various menus by pressing MENU repeatedly.
- 3** Use the SELECT button to highlight the option you want to modify.
- 4** Use either the Right or Left ADJUST button to modify the option you have chosen.
- 5** Press CAPTIONS to turn captions on and off.
The menu will disappear after a few seconds.

TV Operation

- A** Power turns the TV on and off.
- B** Channel Up/Down tunes to next channel.
- C** Volume Up/Down adjusts sound level.
- D** Captions turns selected Caption/Text option on and off.

Camport: Front Audio/Video Inputs

- E** Video Input
- F** L-Audio-R Inputs
Note: TV sound is always monaural. Left/Right Audio input is processed into monaural sound by the TV.



Front panel control menu operation buttons are not labeled and are not usually available to the guest.



You can use Channel to tune to available channels and Volume to set the sound level, regardless of the key defeat setting.

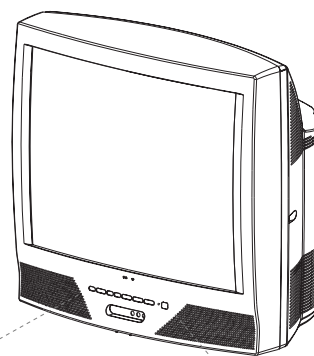

Typical Front Panel Controls

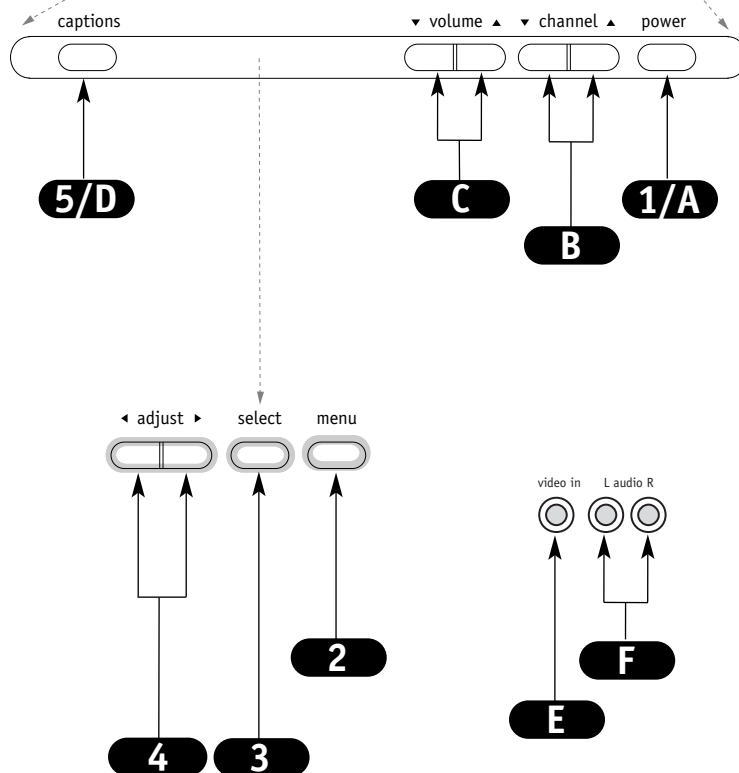

Guest Remote Key Functions

A brief overview of the keys on the guest remote and what they do

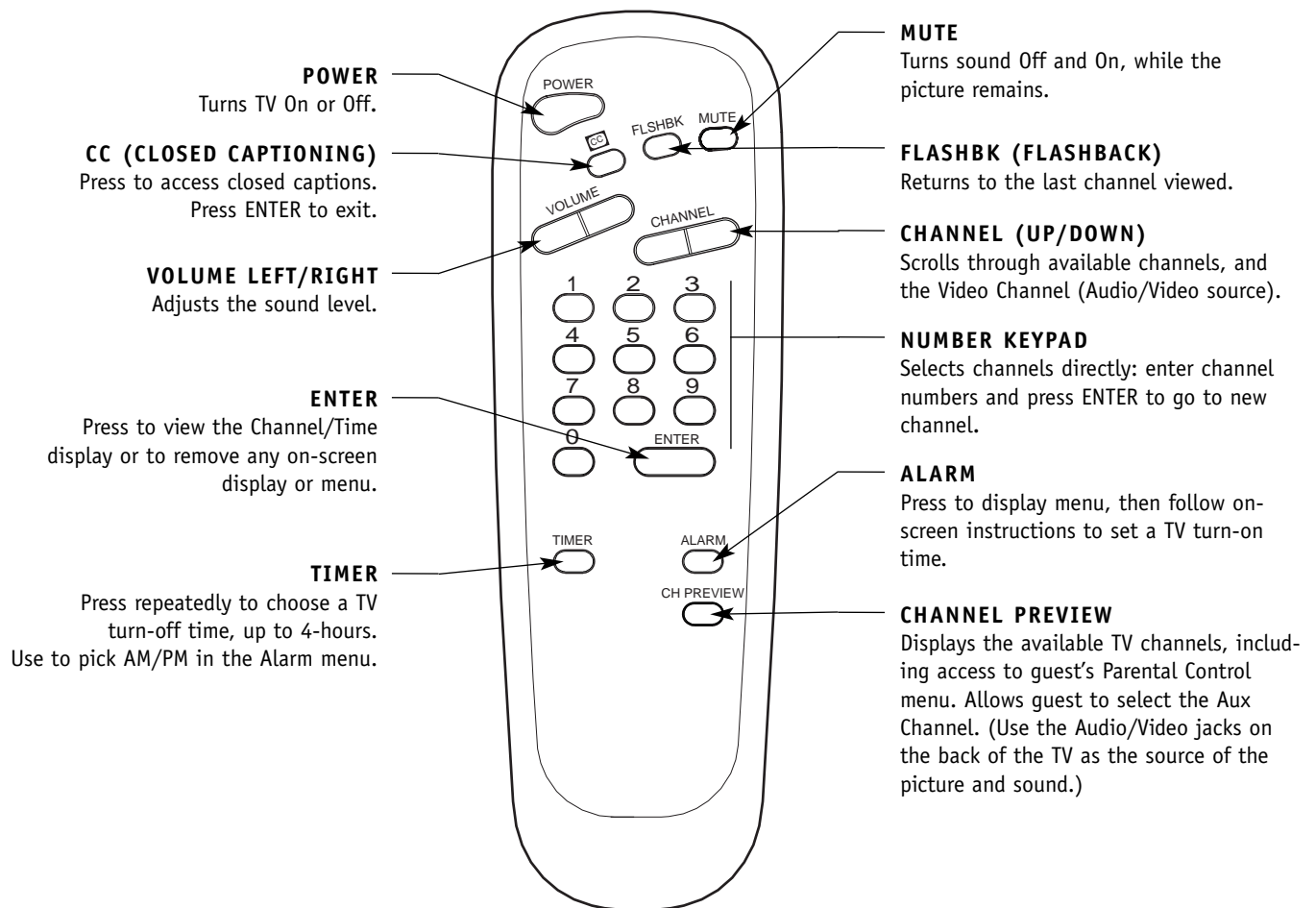

remote control part number

SC652Z

124-213-18

6710V00108A

Installer Remote Key Functions

An overview of the keys on the LP702 installer's remote and what they do

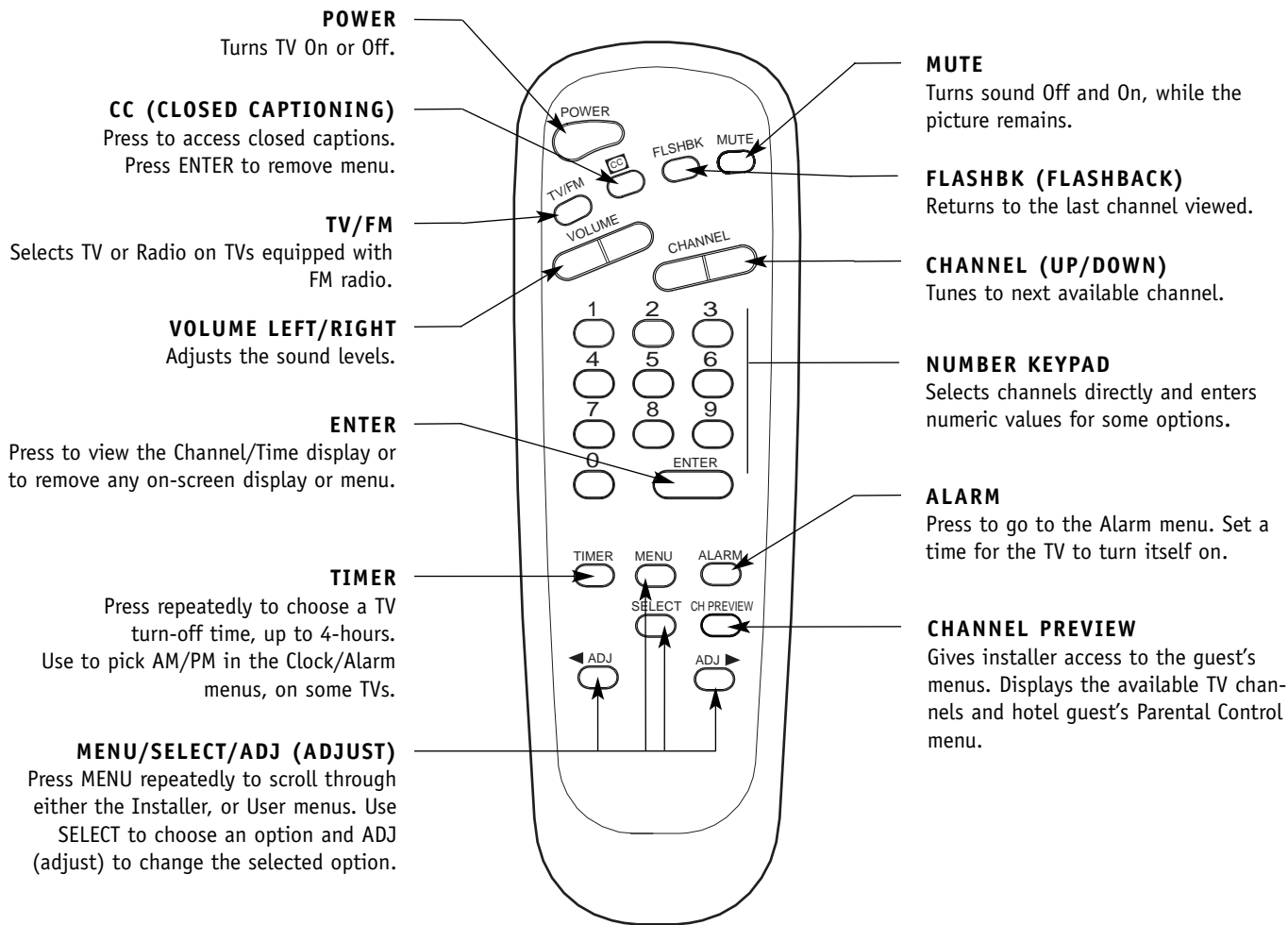

remote control part number
LP702
 124-213-04

On-Screen Menus Overview

Descriptions of the menus and on-screen displays on the TV available to the installer

Using the Menu button on the installer's remote, the installer can access all the menus below.

Menu Name	Page	Description
ON-SCREEN MENUS		
SETUP MENU		Adjusts the basic characteristics of the TV
Auto Program	11	Automatically finds and stores active channels in memory to scroll through using Channel Up/Down.
Add/Del/Blk	16	Picks and chooses which active channels will appear when using Channel Up/Down
Channel Labels	17	Labels available channels with their network names (ABC, CBS, HBO, etc.).
Clock Set	18	Sets the time.
Timer	19	Sets times for the TV to turn itself on and off each day.
Captions	20	Chooses the captioning or text option.
Language	21	Select the language the on-screen menus will appear in.
VIDEO MENU	22	Adjusts the picture settings. The options are: Contrast, Brightness, Color, Tint, Sharpness, Picture Pref.
PARENTAL	23	Allows installer to block any channel or A/V source for up to 99 hours, with the use of a password.
CONTROL MENU		
	25	OTHER MENUS AND ON-SCREEN DISPLAYS
Channel/Time		Shows the current time, channel, video, type of incoming audio signal, and XDS* data if available.
Alarm		Sets a time for the TV to automatically turn itself on.
Sleep Timer		Sets the time the TV will turn itself off.
Volume		Shows current sound level.
Captions		Selects Caption/Text options.
Ch Preview		Displays the available channels list, access to Parental Control, and Aux source selection.
Channel Bank		Shows currently selected channel bank.
		INSTALLER MENUS
INSTALLER MENUS	29	Make adjustment to the TV's operational features.
		*XDS (Extended Data Service) Additional program information provided at the discretion of the broadcaster. May include: title of broadcast, elapsed time, and time remaining on program.

Channel Add/Delete/Blank

Fine-tuning the guest's channel selection list

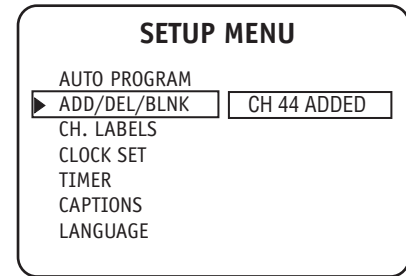

- 1** Press the MENU key on an Installer's remote so the SETUP MENU appears.
- 2** Press SELECT repeatedly to go to the Add/Del/Blnk option.
- 3** Using either the NUMBER keypad and ENTER or the Channel Up/Down arrows on the remote, select a channel. (If adding a deleted channel, you will need to use the number keypad and ENTER.)
- 4** Using the Right/Left ADJ arrows, pick whether the channel is Added, Deleted, or Blank.
- 5** To continue, select another channel and repeat from Step 3. When you are finished, press ENTER to remove menu.

Adding Aux, VCR 3, or VCR 4 to the Channel Preview List

Go to the Setup menu, select the Add/Del/Blnk option. Use Channel Up/Down to select the option and choose Added.
Note: If the option was turned off in the Service menu, you will have to reinstate it before it can appear as an option in the Channel Preview list.

Notes: You can choose to Add, Delete, or Blank **VCR 3**, **VCR 4**, and **Aux**. Caution: If you delete CH3, VCR3 is also deleted, if you delete CH4, VCR4 is also deleted.



If you delete a channel, it isn't gone for good. Just select it using the NUMBER keypad on the remote, or add it later.

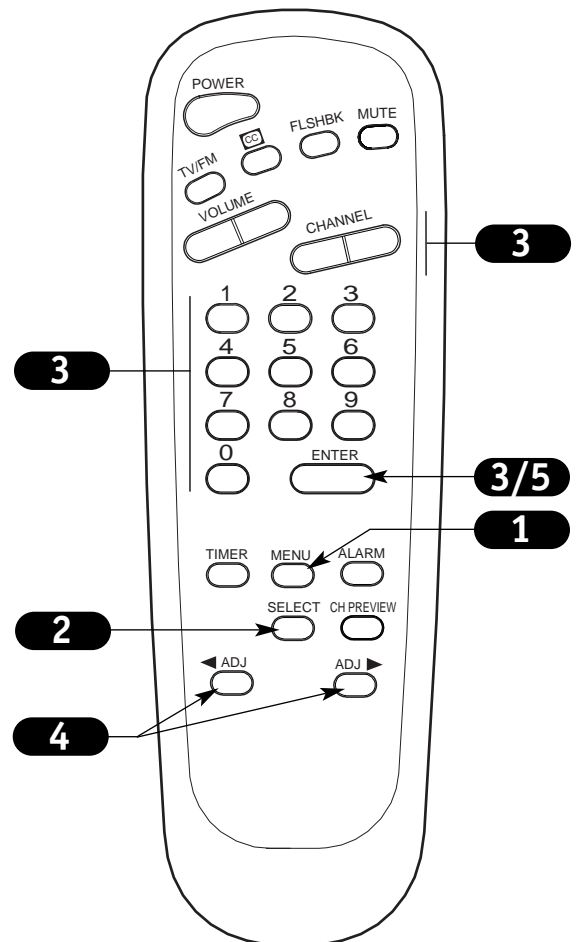

Mini glossary

- ADD** Adds new channels to the list that the guest can scroll through when using the remote.
- DELETE** Removes channels for one reason or another from the list that the guest can scroll through.
- BLANK** Removes the video signal from a channel so the guest will only receive the audio signal.

Setting Up Channel Labels

Customizing the channel selection names

Overview

Channel Labels help the user identify the channel or network being viewed. In the Setup menu with the CH. LABELS option highlighted, use the Adjust Left/Right arrows to scroll through the available channel labels, such as, A & E, AMC, ESPN, HBO, etc. These are a series of alphabetically organized preset labels from which you can choose the more common networks. Use any of these or create custom labels.

- - - -, The 4 dashes will allow a channel label to appear; if one is provided by XDS. (Extended data service)

NONE, prevents any channel label from appearing.

LAB 1, thru **LAB 20**, are the 20 programmable labels.

The 20 programmable labels can be customized for your needs.

Each programmable label has 5 characters spaces available.

Creating Custom Channel Labels

First select a channel using the NUMBER keypad and ENTER or the Channel Up/Down arrows, on an Installer's remote control. (To select a deleted channel, use the NUMBER keypad and ENTER.)

To create a channel label, go to the SETUP MENU and select CH. LABELS.

Press the Right/Left ADJ key to scroll the available preset labels. Scroll past - - - -, scroll past NONE, to go to the first programmable label slot, LAB 1. (Label 1) Notice that the label appears with the title LAB 1, and is also on a dark background; which will distinguish it from the preset labels.

Operating the Menu to Create Custom Labels

Use Volume Up/Down to select the first letter; when it blinks it is selected.

Press MUTE to clear the label if necessary.

Use Channel Up/Down to change the character to one of the 255 characters available. (A blank letter space is available if required, after the "!" symbol.)

Adjust Left/Right	Switches to the next label. - - moves to the next or previous label.
Volume Up/Down	Selects character spaces - - moves to the next or previous character space.
Channel Up/Down	Scrolls through the available characters.
ENTER	Accept the channel label and removes the menu.
MUTE	Removes current label, inserts NONE - - if any custom character space is selected.

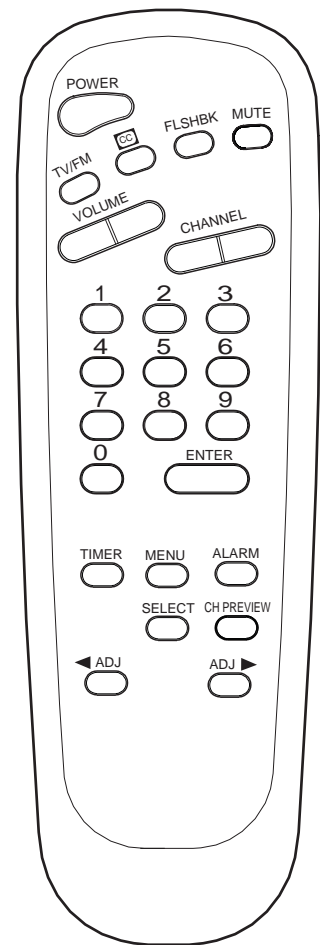
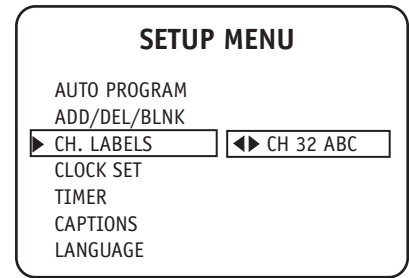

You can press and hold down Channel Up/Down to scroll through the available characters rapidly.

Set the Clock

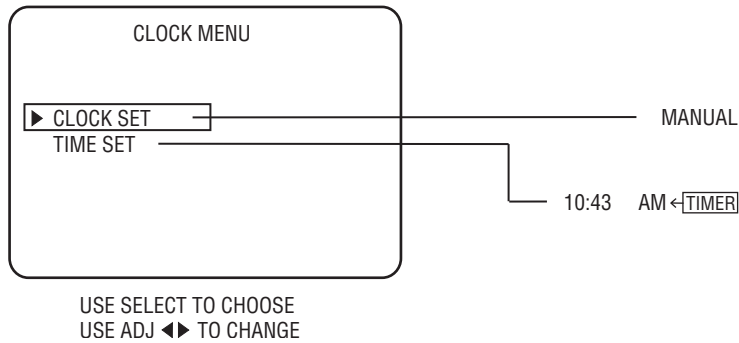
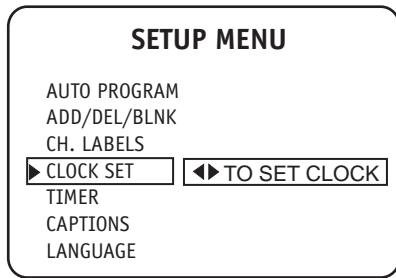
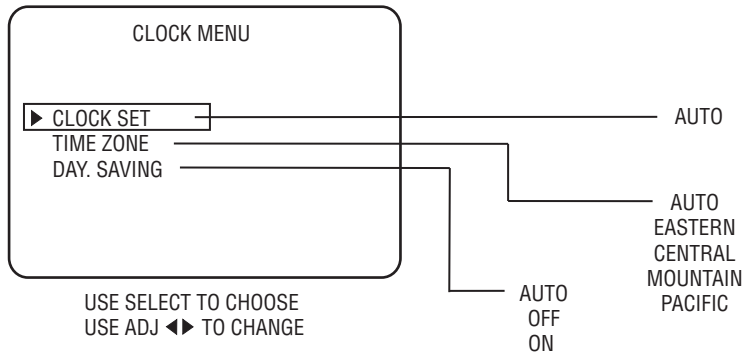
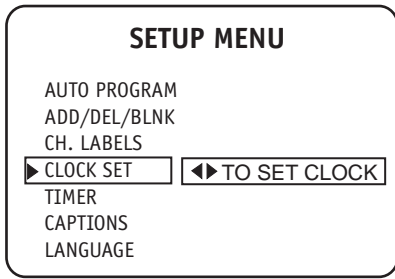

Clock Auto/Manual Operating Modes Setup

Use MENU, SELECT, and ADJ Left/Right to choose the Clock menu and to set up the clock menu options.

Clock Mode **Auto:** TV automatically sets the time.
Time Zone: User can choose the time zone or have the TV set it automatically.
Day. Savings: User can choose to have daylight savings adjust the clock time one hour, or have the TV adjust it automatically.

Manual: User sets the time on the clock.

Press ENTER repeatedly to remove menus.

 The clock can also be set using 24 hour "military time." For p.m. settings add 1200. For example, to set 6:30 p.m., add 1200 to 630, = enter 1830.

 For Auto Clock Set to work, TV must be tuned to a channel that has XDS data available. Auto Clock Set, sets the time only once while the TV is on. To set the clock with XDS data, turn TV off, then back on again, or set the clock time manually.

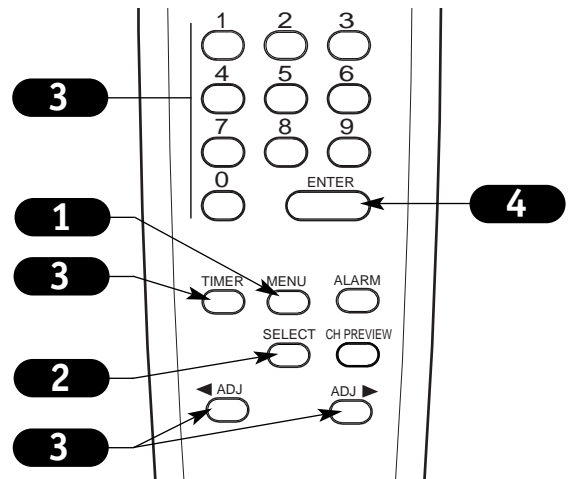

Mini glossary

TIME	A four-digit figure broken down into hours and minutes, used to enter the current time when setting the clock or wake-up alarm.
HOURS	First two digits that are entered when setting the clock or the wake-up alarm.
MINUTES	The last two digits that are entered when setting the clock, or the wake-up alarm.
TIMER	Chooses AM or PM when setting the clock.

On/Off Timer Setup

Set up On/Off Timers

Note: On/Off Timers operate independently of each other.

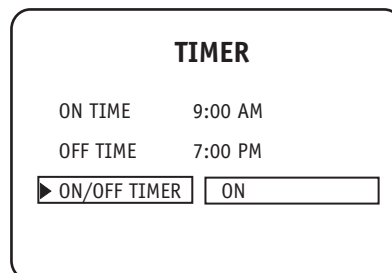
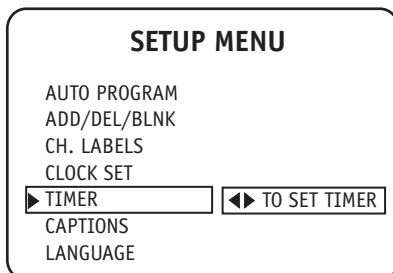

- 1** On the optional HP602 Installer's remote, press MENU repeatedly until the Setup menu appears.
- 2** Press SELECT repeatedly to highlight the Timer option, press the Right arrow.
- 3** Use SELECT to choose an option. Use the number keypad and/or the Left/Right ADJ arrows to enter the times. Use the TIMER key to set AM/PM.

Your options are:

- **On Time**
Sets a time that the TV will turn itself On each day.
- **Off Time**
Sets a time that the TV will turn itself Off each day.
- **On/Off Timer**
Enables or disables the On/Off Timer functions. (The On/Off Timer can be disabled but the settings will be retained.)

- 4** Press ENTER to remove menu and return to TV viewing.



The clock must be set before the Timers will function.



The Off Timer can be used to turn the TV off at the preset time.
 Note: No On Timer setting is required to use the Off Timer feature.

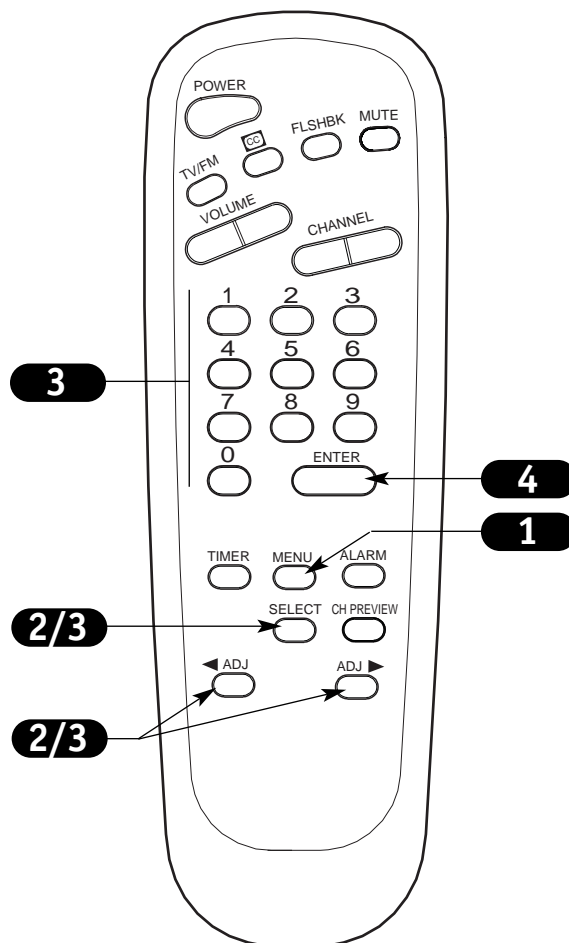

Mini glossary

TIME	A four-digit figure broken down into hours and minutes, used to enter the time when setting the clock or programming timers.
HOURS	First two digits that are entered when setting the clock or programming timers.
MINUTES	The last two digits that are entered when setting the clock, or programming timers.
TIMER	Choose AM or PM with the TIMER button when setting the clock.

Captions (Caption/Text Set Up)

Set up Closed Caption/Text options for the user

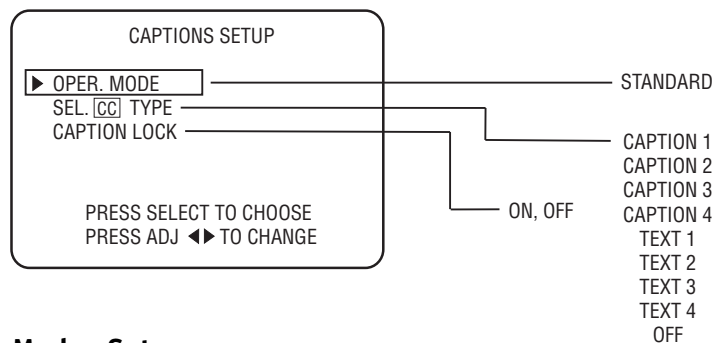
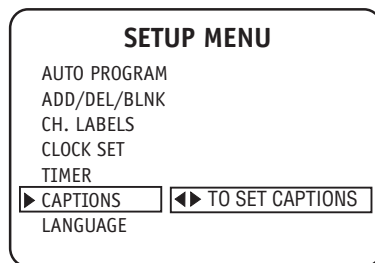
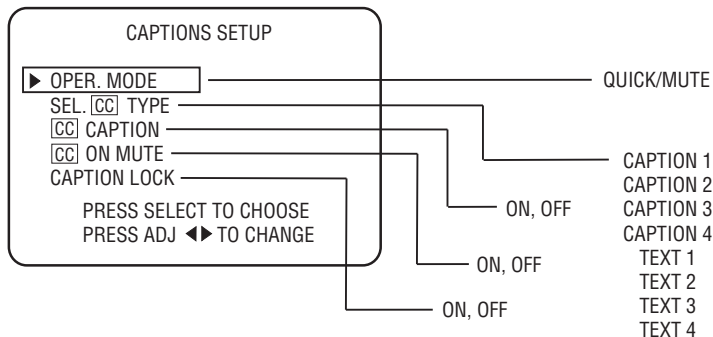
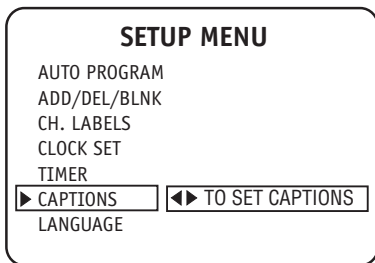

Closed Captions/Text Operating Modes Setup

Use MENU, SELECT, and ADJ Left/Right to choose the Closed Captions/Text mode and to set up the other menu options for the user.

Quick/Mute When CC is pressed: User can only turn Captions on/off.
(If CC on Mute is on, shows captions option on mute.)
(If locked, type is retained with Power on/off.)

Standard When CC is pressed: User can choose a captions type.
(If locked, type is retained with Power on/off.)

Press ENTER repeatedly to remove menus.



Standard closed captioning is available using the Caption 1 option.

Caption/Text are features which allow the Concierge TV to receive the closed caption and/or text options if made available by the broadcaster.

Availability and functionality of Caption/Text options are determined only by each broadcaster and may not be available in your area.

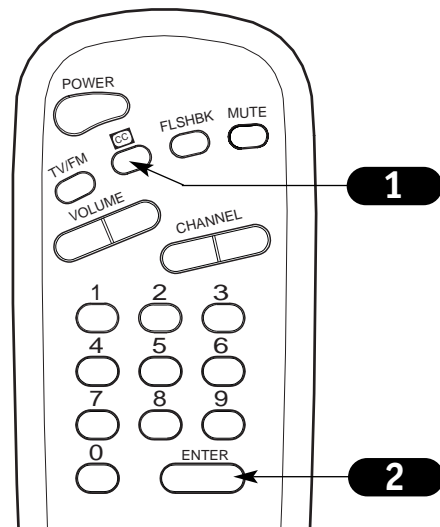

Mini glossary

CAPTIONS	The term for the words that scroll across the bottom of your TV screen; usually the audio portion of the program provided for the hearing impaired.
TEXT	The term for the words that appear in a large black frame and almost cover the entire screen; usually messages provided by the broadcaster.

Language

Choose the language for the on-screen menus

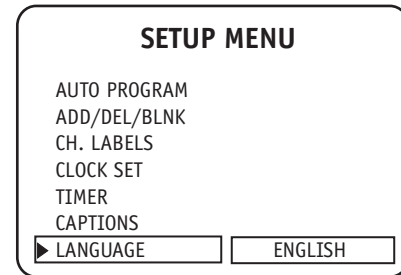

- 1** Press the MENU key on the remote control so the Setup menu appears.
- 2** Use the SELECT key on the remote control, to highlight Language on your screen.
- 3** Use the Right/Left ADJ arrow to choose one of the following options: English, Spanish or French.
- 4** Press ENTER to return to TV viewing.

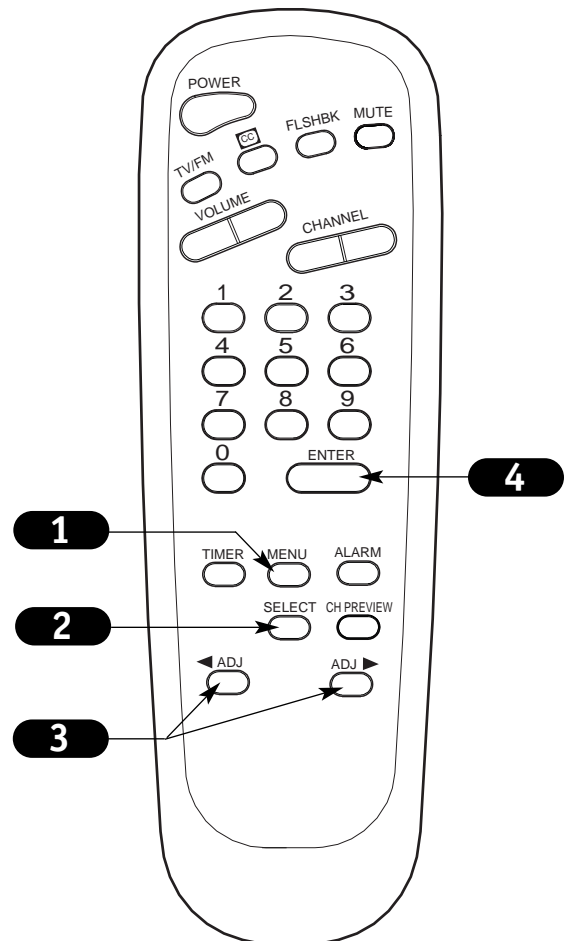

Video Menu

Use the Video menu to customize the picture appearance

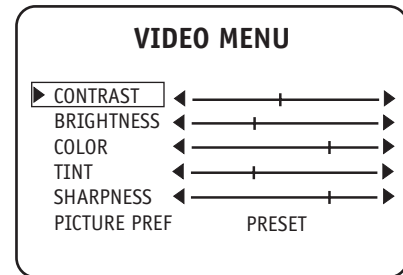

1 Press the MENU key repeatedly until the Video menu appears. Your options are:

- **Contrast:** Adjusts the level of difference between white and black in the TV picture. The more contrast, the brighter the picture appears.
- **Brightness:** Increases or decreases amount of white in the TV picture.
- **Color:** Adjusts levels of all colors in the TV picture.
- **Tint:** Balances between amounts of red and green in the TV picture.
- **Sharpness:** Raises or lowers the definition of the TV picture. The lower the level, the softer the images will appear.
- **Picture Preference:** Choose either Custom or Preset. Custom allows you to set the picture the way you want. Preset moves all the above options back to their original, factory-set levels.

2 Using SELECT on the installer's remote control, choose Contrast on your screen.

3 Using the Right/Left ADJ arrow, change the contrast level to your preference.

4 Press ENTER, or MENU one more time to return to TV viewing, or repeat from step two to set the other menu options.

Picture Preference

A Use SELECT to choose Picture Preference on your screen.

B Use the Right/Left ADJ arrows, to choose either the original settings with Preset, or use your own settings with Custom.



Choose the Preset option in Picture Preference to quickly reset the Video menu settings to their original values.

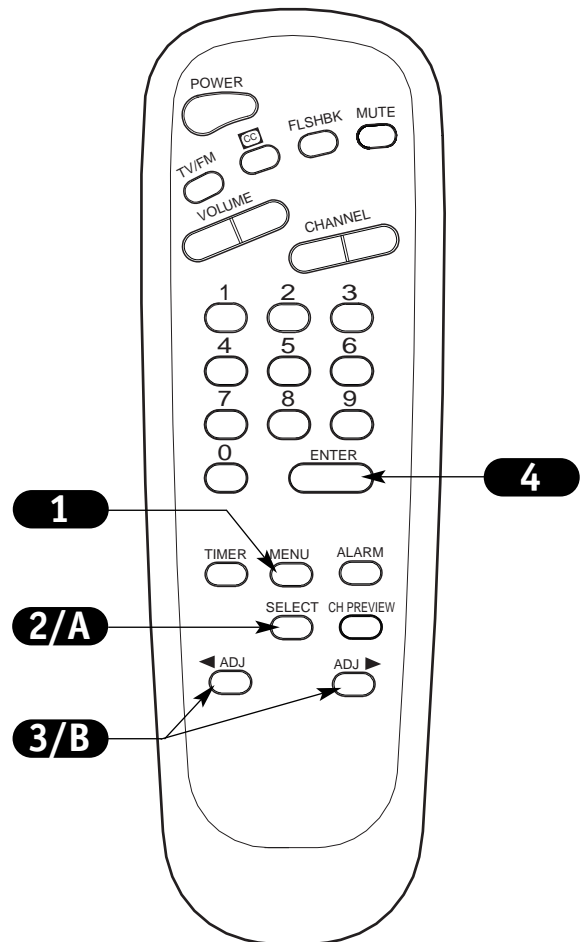

If used, this optional feature can “block” undesirable programming from appearing on the TV

Parental Control offers the user a wide variety of options and settings that restrict or “block” the programming that can appear on the TV. Parental control allows the user the capability of defining which program rating they consider acceptable, to the younger or more sensitive viewer. It can be preset and turned either on or off by the user who specifies the secret 4-number code, the password. The number of hours blocked are specified. General audience and children viewer blocks can both be programmed into the TV’s memory. Viewer ratings are specified for both TV and the motion picture industry; both rating systems can be used. The ratings are based mainly on the ages of children.

Overview

To insure complete coverage for all TV programs, (movies and regular TV shows) choose a rating for MPAA, from the selections AND choose ratings from the TV Parental Guidelines Rating System on pages 36-37, using the Age Block option for General Audiences and for Children. In addition to those, you may wish to add additional restrictions from the Content Block menu. See the Parental Control menu, and submenus example on the next page.

Things to Consider before Setting Up Parental Control

Determine which rating you consider acceptable to the viewer. (For example, if you choose TV-PG, all more restrictive ratings will be automatically blocked; the viewer will not be able to see: TV-PG, TV-14, or TV-MA rated programming.)

Do you want to block the auxiliary video source entirely? (Blocks the signal sent by the equipment, such as a VCR, connected to the TV Audio/Video input jacks; in the Aux. Block option.) Or leave unblocked, then choose allowable ratings.

Block program “Content” based on individual parameters such as: Strong Dialog, Mature Language, Sex Scenes, Violence Scenes, or Fantasy Violence Scenes; in the Content Blk option.

How many hours do you want Parental Control to be active? You can set the Hours option for up to 99 hours.

Select a secret password; in the Set Password option. Use the number keys on the remote. Don’t forget the password, it is the only way you can access the Parental Control menu and change rating selections, or turn Parental Control off.

Do you want Parental Control to be active all the time? If not, you can turn it on or off; with the Lock On/Off option.



You can set different Parental Control viewing restrictions for general audiences and for children - - both can be active at the same time.



You cannot disable Parental Control by disconnecting the TV from power. Block hours remaining will be retained if power is lost or power cord is disconnected.



Simply specifying one content block such as Sex Scenes, will not automatically block another content in the programs from appearing.



The AUX input source can also be blocked.

Reset Parental Control Block Hours to Zero and Cancel Password

This provides the lodge staff and the installer a means to reset the TV to normal operation, if a guest has either forgotten the password or has left Parental Control Block active after checking out.

On the installer’s remote control, press and hold down MENU until the menu disappears (about 6 seconds). Immediately press 9, 8, 7, 6 and then CC. (Based on 0-I INST. SEQ. ‘0’ setting.) This will reset the Block Hours to Zero and cancel the current 4-number password.

Installer Parental Control Menu

After you have read the preceding page, follow instructions below to set up and activate Parental Control.

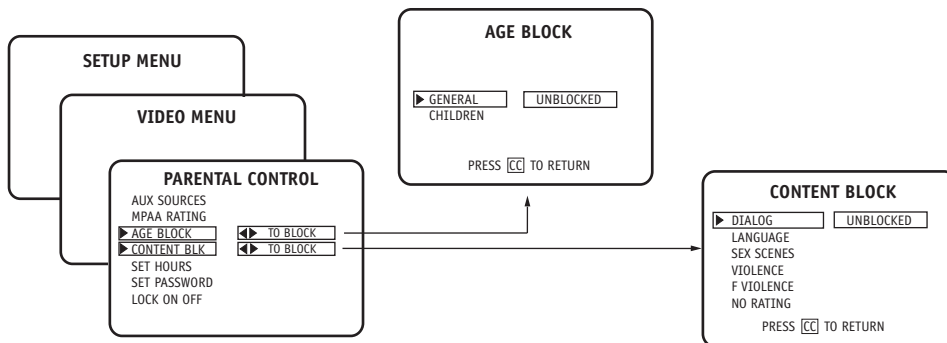

Note: Use the installer's remote control to specify Parental Control settings.

- 1** Press MENU repeatedly until the Parental Control Menu appears.
- 2** With the Parental Control menu on-screen, use the SELECT button to access the MPAA menu and customize the level of restriction.
- 3** Use the Left/Right ADJ arrow to adjust or set the rating for an option, for example, use the "PG" setting. (See the Mini Glossary, Ratings Charts on pages 36 and 37 for rating descriptions.)
- 4** After you have selected and adjusted the Parental Control menu options to your preferences:
 - Set the number of hours Parental Control will be on.
 - Set a 4-number password, using the number keypad.
 - Set the Lock On/Off option to either On or Off.
 - On= Programs will be restricted.
 - Off= Programs will not be restricted; although restriction settings will be retained.

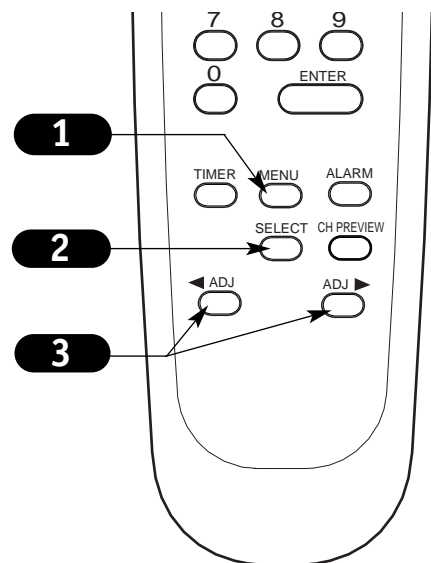

Note: Some broadcasts do not include rating information.

Make Parental Control restrictions permanent, with no preset or fixed hours time limit

In the Installer's Menu, Item 84: PERMANENT BLK, 0 or 1.
 0 Blocking restrictions always active, no time limit.
 1 Restrictions limited to specified hours, 12 - 99.

Reset the Maximum Number of Parental Control Default Block Hours

You can change the Block hours from the 12-hour default setting to up to 99 hours.
 In the Installer's Menu, item: 22-I MAX BLK HRS 12,

use the ADJ Left/Right adjust arrow to set a different default number of hours.

To Turn the Parental Control Feature Off/On

In the Installer's Menu,
 Items: 21-I V-CHIP, 0 or 1, 51-I DIS. VCHIP M., 0 or 1

Options Setups for V-Chip Menu and Block Functions		
21-I V-CHIP	51-I DIS. VCHIP M.	
0	0	No menu, no blocking.
0	1	No menu, no blocking.
1	0	Shows menu, Block functions.
1	1	No menu, Block functions.

Other Menus & On-Screen Displays

Use the remote keys indicated below to access these menus and displays

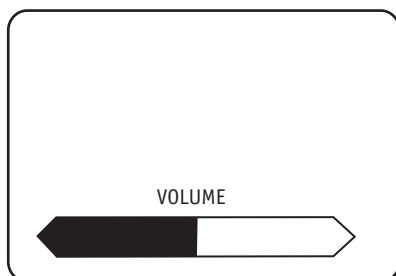

Volume Display

Press VOLUME. Shows currently selected sound setting.

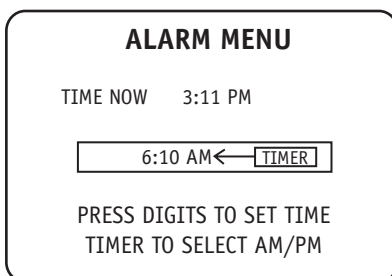

Alarm Menu

Press ALARM. Sets a time the TV will turn itself on.

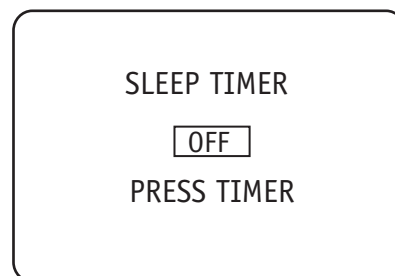

Sleep Timer Menu

Press TIMER. Shows remaining time before TV shutoff. Choose a preset time for TV turn-off.

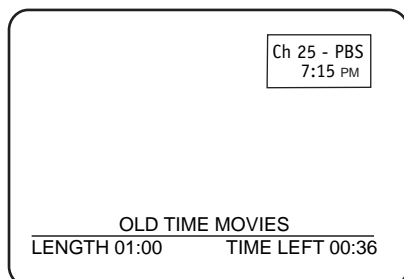

Channel/Time/XDS Display

Press ENTER. Shows currently selected channel or source, current time if the clock has been set, incoming audio signal, and XDS data (if available).



Closed Captions Menu

Press CC. Turns selected option on or off. See Caption/Text page to select options.

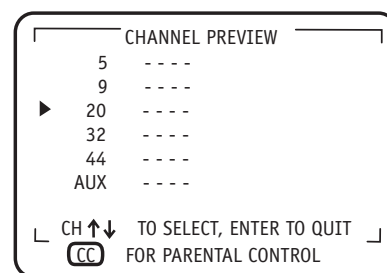

Ch Preview Menu

Press CH PREV. Displays list of the available TV Channels, Guest Parental Control menu, and used to select Auxiliary input source.



Channel Banks Menu

Press SOURCE/BANK on an Installer remote equipped with those keys. Accesses the Channel Banks menus: Bank 1, Bank 2, Bank 3, Bank 4.

The TV has four channel banks, where the administrator or installer can store groups of TV channels

Note: Channel banks set up requires an installer's remote with "Source" or "Bank" keys like the Zenith MBR3447, or a similar remote.

PLANNING THE CHANNEL BANKS

Generally, TV channels are grouped into "program packages" with terms that are proposed to the end user. The user then opts for a package. Below is an example of how TV channels may be grouped.

You may plan your package by using a chart like the one after the following page.

Remember, you can "blank" a channel for accommodating audio-only, such as an FM radio station or in-house communication.

Sometimes, only one or two channel banks may be needed. You may leave any unused bank with the channels entered during Auto Program; or, you may delete the channels. However, you may want to leave at least one channel in any unused bank. Then, if someone selects an "unused" bank, that channel will assure them that the TV is functional.

Note: Some channels from factory testing may be in the channel banks if you have not yet run Auto Program.

Channel Bank	Program package
1	Basic cable channels
2	Extended cable channels
3	Extended with premium channels
4	Other cable service options

(Grouping is provided as an example only.)

ADDING / DELETING CHANNELS

A previously prepared programming chart is helpful.

1. Run Auto Program (in the Setup menu). All channels found on your cable/antenna will be entered in Channel Banks 1, 2, 3, and 4.

Note: Be advised that running Auto Program overwrites any custom channel setups; removes Blanked, Deleted.

2. Select a channel bank with an installer remote - -press SOURCE/BANK (and repeat). CHANNEL BANK and BANK number will be displayed.

3. Use the ADD/DEL/BLNK item (also in the Setup menu) to customize your program package. You may delete channels or add some that have not been entered. You can also "Blank" a channel for accommodating an audio-only program source or in-house communication. See the "ADD/DEL/BLNK" menu page for more details.

Note: The Blank Channel feature is global. A channel will be blanked in all channel banks.

4. Repeat steps 2, and 3 to program another channel bank.

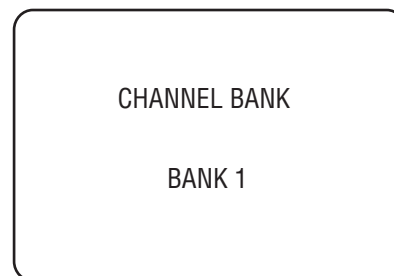

Channel Bank Number Display



The BLNK (blank) channel function is "global" -- the same channel number is blanked in channel banks 1, 2, 3, and 4.

Managing the Channel Banks

Examples of typical channel banks charts

Figure 1. Typical channel banks after running Auto Program

BANK	Purpose	Channel Number																								
		1	2	3	4	5	6	7	8	9	10	11	12	13	14	15	16	17	18	19	20	21	22	23	24	25
1			A			A		A		A					A	A	A	A	A	A	A		A	A	A	A
2			A			A		A		A					A	A	A	A	A	A	A		A	A	A	A
3			A			A		A		A					A	A	A	A	A	A	A		A	A	A	A
4			A			A		A		A					A	A	A	A	A	A	A		A	A	A	A

A = Active - - Channel was found during AUTO PROGRAM

Figure 2. Typical channel banks after running Auto Program, and customizing with Add/Del/Blnk

BANK	Purpose	Channel Number																								
		1	2	3	4	5	6	7	8	9	10	11	12	13	14	15	16	17	18	19	20	21	22	23	24	25
1	Basic	BC	A			A		A		A				D	D	D	D	D	D	D	D		D	D	D	D
2	Extend	BC	A			A		A		A				A	D	A	A	D	A	A	A		D	D	D	D
3	All CTV	BC	A			A		A		A				A	D	A	A	D	A	A	A		A	D	A	A
4	Other	BC	A			A		A		A				A	A	A	A	A	A	A	A		A	A	A	A

A = Active Channel was found during AUTO PROGRAM
 D = Deleted Channel was deleted using Add/ Del option.
 BC = Blanked Channel Channel was blanked using BLANK channel option (ADD/DEL/BLNK).

ADDING / DELETING CHANNELS

It is best to do ADD / DEL customizing before doing "BLNK."

AUTO PROGRAM enters the same channels in banks 1, 2, 3, and 4.

AUTO PROGRAM removes any channels previously customized with ADD / DEL / BLNK. The channels available on your antenna / cable will be entered, and any channels previously entered but not currently available will be deleted.

ADD and DEL (not BLNK) can be used independently for channel banks 1, 2, 3, and 4.

A channel blanked, is blanked in all channel banks.

Channel allocations in tuning bands:

BROADCAST: 2 – 69
 CABLE – CATV, HRC or ICC: 1 – 125

Managing the Channel Banks

PLAN YOUR CHANNEL BANKS BY FILLING IN THESE CHARTS (or use photocopies).

B A N K	Purpose	Channel Number																								
		1	2	3	4	5	6	7	8	9	10	11	12	13	14	15	16	17	18	19	20	21	22	23	24	25
1																										
2																										
3																										
4																										

B A N K	Purpose	Channel Number																								
		26	27	28	29	30	31	32	33	34	35	36	37	38	39	40	41	42	43	44	45	46	47	48	49	50
1																										
2																										
3																										
4																										

B A N K	Purpose	Channel Number																								
		51	52	53	54	55	56	57	58	59	60	61	62	63	64	65	66	67	68	69	70	71	72	73	74	75
1																										
2																										
3																										
4																										

B A N K	Purpose	Channel Number																								
		76	77	78	79	80	81	82	83	84	85	86	87	88	89	90	91	92	93	94	95	96	97	98	99	100
1																										
2																										
3																										
4																										

B A N K	Purpose	Channel Number																									
		101	102	103	104	105	106	107	108	109	110	111	112	113	114	115	116	117	118	119	120	121	122	123	124	125	FM
1																											
2																											
3																											
4																											

Installer's Menu

Use the Installer Menu to set up or change operational settings
See descriptions of the Installer items on the following pages...

Accessing the Installer's Menu

Installer's menu items can be accessed by using the optional LP702 installer's remote control. Just press and hold MENU (about 8 seconds) until the display changes, then press 9, 8, 7, 6, then ENTER. To exit the Installer's Menu, press ENTER again. *Any changes you make will be stored in nonvolatile memory.*

The Installer's menu opens with item 0-I, INST. SEQ. Use the SELECT key to sequence through the available menu items. Or, access an item directly by entering the line number, then pressing MENU. For example, to access the Sleep Timer option which is on line 15-I, press 15, then MENU. To change a setting use the Left/Right ADJ keys.

Using the Installer's Menu

Items 0-I - 86-I are immediately accessible only upon entering the Installer's Menu. Their numbers, descriptions, ranges, factory default settings, and a place for listing any changes made on-site are given below and on the following pages. A Factory Menu that is intended for qualified service technicians only, is not shown. Normally Factory menu items do not require adjustment.

Installer Menu Items 0-I through 25-I

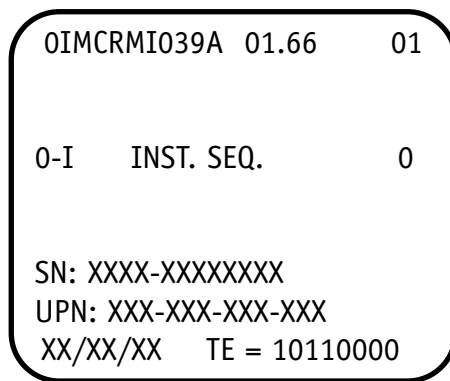

Typical Installer Menu



XX-F Menu Items (Not shown here) are service-type adjustments and only qualified technicians having specialized test equipment should access them.

Menu Item	Function	Value Range	Default Value	Brief Description of Function and Comments
0-I.	INSTALLER. SEQ	0 - 3	0	Leave default set 0.
1-I.	POWER MANAGE	0 - 7	0	Sets number of hours of no activity before auto shutdown.
2-I.	AC ON	0 / 1	0	Set to 1 to enable auto turn on at power up.
3-I.	BAND/AFC	0 - 7	0	Tuning band, see detailed descriptions.
4-I.	STRT CHANNEL	0 - 255	255	Channel at turn on (255 tune to last channel before turn off).
5-I.	CHAN LOCK	0 / 1	0	When set to 1, cannot tune from current channel.
6-I.	GHOST CH	0 / 1	0	Set to 1 to enable Ghost Channel display.
7-I.	START VOLUME	0 - 63, 255	255	Volume level at TV turn-on (Set 255 to retain last volume level).
8-I.	MIN VOLUME	0 - 63	0	Minimum volume setting.
9-I.	MAX VOLUME	0 - 63	63	Maximum volume setting.
10-I.	MUTE DISABLE	0 / 1	0	Set to 1 to disable mute function.
11-I.	KEY DEFEAT	0 / 1	0	Set to 1 to disable Menu, Select, and Adj keys on front panel.
12-I.	IR BANKS EN.	0 / 1	0	Set to 1: enables TV to respond to IR codes to change Channel Bank directly.
13-I.	SCAN MODE	0 / 1	0	Puts On-Off in Ch Up/Down sequence.
14-I.	STRT CH IN SM	0 / 1	0	Set to 1 to put TV on/off below start channel number.
15-I.	SLEEP TIMER	0 / 1	1	Set to 1 to enable Sleep Timer.
16-I.	EN. TIMER	0 / 1	1	Set to 1 to enable Timer.
17-I.	ALARM	0 / 1	1	Set to 1 to enable Alarm.
18-I.	NOT USED			
19-I.	NOT USED			
20-I.	FEATURE LEVEL	0 / 1	1 Zen 1	Leave default set 1 (1 Zen 1).
21-I.	V-CHIP	0 / 1	1	Set to 1 to enable V-Chip
22-I.	MAX BLK HRS	0 - 99	12	Select number of Parental Control blocking hours.
23-I.	CAPTION LOCK	0 / 1	0	Set to 1 to retain Caption setting at turn off.
24-I.	TEXT MODE	0 / 1	1	Set to 1 to add Text option to closed caption menu.
25-I.	NOT USED			

Installer Menus

Installer Menu Items 26-I through 63-I

Menu Item	Function	Value Range	Default Value	Brief Description of Function and Comments
26-I.	NOT USED			
27-I.	NOT USED			
28-I.	CH. OVER RIDE	0 / 1	1	When set to 0, limits direct access to favorite channels.
29-I.	NOT USED			
30-I.	NOT USED			
31-I.	NOT USED			
32-I.	NOT USED			
33-I.	NOT USED			
34-I.	NOT USED			
35-I.	NOT USED			
36-I.	NOT USED			
37-I.	NOT USED			
38-I.	NOT USED			
39-I.	NOT USED			
40-I.	AUTO CAMPORT	0 / 1	1	Set to 1 to automatically switch to Camport.
41-I.	NOT USED			
42-I.	NOT USED			
43-I.	NOT USED			
44-I.	NOT USED			
45-I.	NOT USED			
46-I.	NOT USED			
47-I.	NOT USED			
48-I.	DIS. SETUP M.	0 / 1	0	Set to 1 to disable Setup menu.
49-I.	NOT USED			
50-I.	DIS. VIDEO M.	0 / 1	0	Set to 1 to disable Video menu.
51-I.	DIS. VCHIP M.	0 / 1	0	Set to 1 to disable V-Chip (Parental Control) menu.
52-I.	NOT USED			
53-I.	DIS. CH-TIME M.	0 / 1	0	Set to 1 to disable Channel-Time display.
54-I.	EN. SET. COL.	0 / 1	0	Set to 1 to enable custom color for Setup menu.
55-I.	FOR. SETUP M.	0 - 7	6	Custom foreground color for the Setup menu.
56-I.	BCK. SETUP M.	0 - 7	4	Custom background color for the Setup menu.
57-I.	NOT USED			
58-I.	NOT USED			
59-I.	NOT USED			
60-I.	EN. VIDEO COL.	0 / 1	0	Set to 1 to enable custom color for the Video menu.
61-I.	FOR. VIDEO M.	0 - 7	4	Custom foreground color for the Video menu.
62-I.	BCK VIDEO M.	0 - 7	7	Custom background color for the Video menu.
63-I.	EN. PTL. COL.	0 / 1	0	Set to 1 to enable custom color for the V-Chip (Parental Control) menu.

Installer Menu Items 64-I through 86-I

Menu Item	Function	Value Range	Default Value	Brief Description of Function and Comments
64-I.	FOR. PTL. M.	0 - 7	6	Custom foreground color for the V-Chip (Parental Control) menu.
65-I.	BCK. PTL. M.	0 - 7	4	Custom background color for the V-Chip (Parental Control) menu.
66-I.	NOT USED			
67-I.	NOT USED			
68-I.	NOT USED			
69-I.	EN. CH-T COL.	0 / 1	1	Set to 1 to enable custom color for the Channel-Time display.
70-I.	FOR. CH-T COL	0 - 7	1	Custom foreground color for the Channel-Time display.
71-I.	BCK. CH-T COL	0 - 7	1	Custom background color for the Channel-Time display.
72-I.	NOT USED			
73-I.	CH NOT AVBLE	0 / 1	0	When set to 1 and channel override is 0, "NOT AVAILABLE" message is displayed when direct accessing a channel not in the favorite channel list.
74-I.	CH-TIME SIZE	0 / 1	0	When set to 1 and transparent background is selected for Channel-Time display, (foreground color = background color and custom color enabled) a large channel number is displayed instead of the normal Channel-Time display.
75-I.	NOT USED			
76-I.	DEFEAT XDS	0 / 1	0	When set to 1, XDS display program information will not appear.
77-I.	NOT USED			
78-I.	UPN MSB	0 - 255	255	User programmable number, most significant byte. (Line-Day
79-I.	UPN MSB-1	0 - 255	255	User programmable number, most significant byte - 1. (Week)
80-I.	UPN MSB-2	0 - 255	255	User programmable number, most significant byte - 2. (SN-HIGH)
81-I.	UPN LSB	0 - 255	255	User programmable number, least significant byte. (SN-LOW)
82-I.	NOT USED			
83-I.	NOT USED			
84-I.	PERMANENT BLK	0 / 1	0	Remove block hours setting for Parental Control and make blocks permanent.
85-I.	A. MUTE TIME	0 - 254	50	Controls muting audio delay time when switching between AUX sources.
86-I.	V. MUTE TIME	0 - 254	50	Controls muting video delay time when switching between AUX sources.

Detailed Descriptions of Installer Menu Items

0-I. INSTALLER SEQUENCE

Gives access to Installer Menu depending on the code selected.

0 = 9876 1 = 4321
2 = 1478 3 = 3698

1-I. POWER MANAGE (Power Management)

Determines hours of no activity before automatic shutdown. The POWER MANAGE function is for saving energy. When set to 0, Power Manage is OFF. Settings range from 0 - 7, with 1 - 7 repre-

senting the hours that the TV will remain on, unless there has been activity from either the control panel or remote control.

2-I. AC ON (AC Power Switchable)

Allows the TV to turn ON just by applying AC power. Pressing the ON button is not necessary. This is desirable when the TV is plugged into a cable box or a power outlet controlled by a wall switch. Use ADJUST to select 0 or 1, where 0 is the default is OFF, and 1 is ON.

NOTE: When set to 1 (ON), the TV does not respond to ON/OFF commands from either the remote or the control panel, and the SLEEP TIMER is also nonfunctional.

Installer Menu Items 3-I through 13-I: Detailed Descriptions

3-I. BAND/AFC (Band/Automatic Frequency Control)

There are 8 possible settings for this option:

0 = Broadcast Fixed	4 = Broadcast AFC
5 = CATV Fixed	1 = CATV AFC
6 = HRC Fixed	2 = HRC AFC
7 = ICC Fixed	3 = ICC AFC

Channels are accessed faster when fixed modes are used. The AFC (search modes) should only be used when some channels are not on nominal frequencies.

NOTE: BAND is automatically set by AUTO PROGRAM.

If some channels were not found by AUTO PROGRAM, select the appropriate AFC setting here and add the channels using the ADD/DEL option in the Setup Menu.

4-I. STRT CHANNEL (Start Channel)

When active, this function allows you to determine the initial channel number when the TV is turned ON. This feature is useful for an in-house information channel, since the TV would always select that channel when it is turned on. Setting this to 255, causes the last channel viewed when TV was turned off to be the tuned to channel when the TV is turned on again.

The range of values is 0 - 255. Use (adjust) keys to choose numbers that determine the start channel.

5-I. CHAN LOCK (Channel Lock)

CHAN LOCK is ideal if a cable box (or similar) is the sole source for programming—and the TV must always be on the same channel. Changing channels with Channel Up/Down or keypad numbers is impossible. Channel Lock is inactive when set to 0 (default).

Generally, this feature is used in conjunction with START CHANNEL (item 4-I.) where the start channel may, for example, be set to 3 or 4. If the start channel is 3, then the TV will remain on channel 3. NOTE: When CHANNEL LOCK is active and CHANNEL OVERRIDE is disabled, AUTO PROGRAM is not active.

6-I. GHOST CH (Ghost Channel)

When set to 1, the current channel number is displayed in the upper right corner of the CRT. The number moves slightly to prevent damage to the screen. The default is "0" or OFF. NOTE: When captions are on, the "ghost channel" is not displayed.

7-I. START VOLUME

This function allows the Installer to determine the initial volume level setting when the TV is turned ON. This feature is useful for an in-house information channel, since the TV would always select that volume level when it is turned on. The range of values are 0 - 63, 255. If 255 is selected, the current volume level will be retained in memory when the TV is turned off; at TV turn on, volume level is automatically set to the previous or last level.

8-I. MIN VOLUME (Minimum Volume)

This function determines the minimum volume level allowable with the VOLUME (VOL) Up/Down control. In this way, for example, someone cannot set the volume too low to hear. The range is from 0 to 63—change values with ADJ (Adjust). The factory default is 0, which provides full range of volume control. It may be best to set the same value on every TV.

NOTE: The minimum volume level cannot have a value setting higher than in the MAX VOLUME level (described below).

9-I. MAX VOLUME (Maximum Volume)

This function determines the maximum volume level allowable with the VOLUME VOL Up/Down control. In this way, for example, someone cannot set the volume level high enough to disturb others. The range is 0 to 63, with 63 as the default which gives the user the full range of volume control. Change values with ADJUST keys. It may be best to set the same value on every TV.

NOTE: The maximum volume level cannot have a value setting lower than the MIN VOLUME level (described above).

10-I. MUTE DISABLE

Enables or disables sound mute function. Set to 1, sound cannot be muted. Set to 0, sound can be Muted.

11-I. KEY DEFEAT (Keyboard Defeat)

When set to 1, it prevents the end user from accessing screen menus on the front panel—MENU, SELECT, and ADJUST do not function. When set to 0, those keys are functional. The menus can always be accessed with MENU on the remote.

12-I. IR BANKS EN.

For direct access to a particular Channel Bank. When enabled, installer can access a channel bank by inputting the IR code for the bank.

13-I. SCAN MODE

Allows variation in setting the On/Off with Channel UP/DOWN. You may opt for TV channels only, or TV channels + Off/ON with these settings for Scan Mode:

Installer Menu Items 14-I through 40-I: Detailed Descriptions

Scan mode	Characteristics
0	Channel up/down keys change channels only.
1	Channel down below the lowest channel (or channel up higher than the highest) and TV turns off.

14-I. STRT CH IN SM

When set to 1, installs TV on/off event below the start channel at TV turn on.

15-I. SLEEP TIMER

When set to 1, the Sleep Timer feature may be used (but no message is displayed prior to turn-off). When set to 0, the Sleep Timer is not available.

16-I. EN. TIMER

Set to 1, Timer functions are available to user. Set to 0 to disable Timer functions. (Clock must be set in order to use Timers.)

17-I. ALARM

Gives you the option of making the alarm function available to the user. Set to 1, Alarm function is available to user. Set to 0 to disable the Alarm function.

Note: Clock must be set in order to set the Alarm.

18-I. NOT USED

19-I. NOT USED

20-I. FEATURE LEVEL

Default set to ZEN 1 for Zenith IR remote control operation. Set 0, P LBL for Zenith Private Label IR remote control operation.

Warning: Do not set to "0" or remote will not control TV.



Note: Installer should leave Item 20-I set to 1.

21-I. V-CHIP

Set to 1 to activate V-Chip (Parental Control); have it available to user to filter or control or restrict programming content. Set to 0 to turn V-Chip feature off, not available to user; no programming restrictions can be set.

22-I. MAX BLK HRS

Set to 0 to 99 for the maximum V-Chip (Parental Control) block hours. Default is 12 blocking hours.

23-I. CAPTION LOCK

Set to 1 to restore previous caption On/Off state after TV turns off. When set to 0, captions are always off, when TV is initially turned on.

24-I. TEXT MODE

Determines whether TEXT 1, TEXT 2, TEXT 3, or TEXT 4 decoding is enabled when TEXT is turned on (either from the Setup Menu or directly with CC on the remote).

TIP: Set Text Mode to 1 only if text is offered in your video system.

25-I. NOT USED

26-I. NOT USED

27-I. NOT USED

28-I. CH. OVERRIDE (Channel Override)

When set to 1, the user can select channels with either Channel up/down or by direct number keypad entry. When set to 0, only those channels that are entered for scanning may be selected by keypad entry. Note: If set to 0, Auto Program is locked; (as shown on Setup menu) channel search is not available.

29-I. NOT USED

30-I. NOT USED

31-I. NOT USED

32-I. NOT USED

33-I. NOT USED

34-I. NOT USED

35-I. NOT USED

36-I. NOT USED

37-I. NOT USED

38-I. NOT USED

39-I. NOT USED

40-I. AUTO CAMPORT

Set to 1 to automatically switch to Camport when equipment is connected to front Video input.

Set to 0 to disable front Video automatic source selection.

Installer Menu Items 41-I through 69-I: Detailed Descriptions

41-I. NOT USED

42-I. NOT USED

43-I. NOT USED

44-I. NOT USED

45-I. NOT USED

46-I. NOT USED

47-I. NOT USED

48-I. DIS. SETUP M.

Set to 1 to disable the Setup menu. Setup menu will not appear.
Set to 0 to enable the Setup menu.

49-I. NOT USED

50-I. DIS. VIDEO M.

Set to 1 to disable the Video menu. Video menu will not appear.
Set to 0 to enable the Video menu.

51-I. DIS. VCHIP M.

Set to 1 to disable the Source menu. Source menu will not appear.
Set to 0 to enable the Source menu.

52-I. NOT USED

53-I. DIS. CH-TIME

Set to 1 to disable the Channel-Time display. Channel-Time display will not appear.
Set to 0 to enable the Channel-Time display.

54-I. EN. SET. COL.

Set to 1 to enable custom color settings for the Setup menu.
Set to 0 to disable custom color settings for the Setup menu.

55-I. FOR. SETUP M. (Setup Menu Foreground Color)

Set according to Color Chart.

0 = Black	3 = Yellow	6 = Cyan
1 = Red	4 = Blue	7 = White
2 = Green	5 = Violet	

56-I. BCK. SETUP M. (Setup Menu Background Color)

0 = Black	3 = Yellow	6 = Cyan
1 = Red	4 = Blue	7 = White
2 = Green	5 = Violet	

57-I. NOT USED

58-I. NOT USED

59-I. NOT USED

60-I. EN. VIDEO. COL.

Set to 1 to enable custom color settings for the Video menu.
Set to 0 to disable custom color settings for the Video menu.

61-I. FOR. VIDEO M. (Video Menu Foreground Color)

0 = Black	3 = Yellow	6 = Cyan
1 = Red	4 = Blue	7 = White
2 = Green	5 = Violet	

62-I. BCK. VIDEO. COL. (Video Menu Background Color)

0 = Black	3 = Yellow	6 = Cyan
1 = Red	4 = Blue	7 = White
2 = Green	5 = Violet	

63-I. EN. PTL. COL.

Set to 1 to enable custom color settings for the V-Chip menu.
Set to 0 to disable custom color settings for the V-Chip menu.

64-I. FOR. PTL. M. (V-Chip Menu Foreground Color)

0 = Black	3 = Yellow	6 = Cyan
1 = Red	4 = Blue	7 = White
2 = Green	5 = Violet	

65-I. BCK. PTL. M. (V-Chip Menu Background Color)

0 = Black	3 = Yellow	6 = Cyan
1 = Red	4 = Blue	7 = White
2 = Green	5 = Violet	

66-I. NOT USED

67-I. NOT USED

68-I. NOT USED

69-I. EN. CH-T COL.

Set to 1 to enable custom color for the Channel-Time display.
Set to 0 to disable custom color for the Channel-Time display.

Installer Menu Items 70-I through 86-I: Detailed Descriptions

70-I. FOR. CH-TIME (Channel-Time Display Foreground Color)

0 = Black 3 = Yellow 6 = Cyan
1 = Red 4 = Blue 7 = White
2 = Green 5 = Violet

Note: If foreground and background color are the same, menu background is transparent.

71-I. BCK. CH-TIME (Channel-Time Display Background Color)

0 = Black 3 = Yellow 6 = Cyan
1 = Red 4 = Blue 7 = White
2 = Green 5 = Violet

Note: If foreground and background color are the same, menu background is transparent.

72-I. NOT USED

73-I. CH NOT AVBLE

When set to 1 and channel override is set to 0, "NOT AVAILABLE" message is displayed when direct accessing a channel not in the favorite channel list.

74-I. CH-TIME SIZE

When set to 1 and transparent background is selected for Channel-Time display, (foreground color = background color and custom color enabled) a large channel number is displayed instead of the normal Channel-Time display.

75-I. NOT USED

76-I. DEFEAT XDS

Set to 1 to disable XDS display. Set to 0 to enable XDS display.

77-I. NOT USED

78-I. UPN MSB

User programmable number, most significant byte readable by M.P.I. command. (Line - Day)

NOTE: M.P.I. interface is not available on this TV.

79-I. UPN MSB-1

User programmable number, most significant byte-1 readable by M.P.I. command. (Week)

NOTE: M.P.I. interface is not available on this TV.

80-I. UPN MSB-2

User programmable number, most significant byte-2 readable by M.P.I. command.

NOTE: M.P.I. interface is not available on this TV. (SN-HIGH)

81-I. UPN LSB

User programmable number, least significant byte readable by M.P.I. command. (SN-LOW)

NOTE: M.P.I. interface is not available on this TV.

82-I. NOT USED

83-I. NOT USED

84-I. PERMANENT BLK

Allows Parental Control blocking schemes to be permanent by removing the blocking hours function.

Set to 1 to install Parental Control blocking restrictions permanently.

Set to 0 for user-specified hours control of blocking schemes.

85-I. A. MUTE TIME

Controls audio muting delay time when switching between AUX sources. Range is 0 to 254 msec.

86-I. V. MUTE TIME

Controls video muting delay time when switching between AUX sources. Range is 0 to 254 msec.

Parental Control Menu

This optional feature can be used to “block” undesirable programming from appearing on your TV.

This TV offers the user a wide variety of options and settings that restrict or “block” the programming that can appear on the TV. Parental control allows the user the capability of defining which program rating they consider acceptable, to the younger or more sensitive viewer. It can be preset and turned either on or off by the user who specifies the secret 4-number code, the password. The number of hours blocked are specified. General audience and children viewer blocks can both be programmed into the TV’s memory. Viewer ratings are specified for both TV and the motion picture industry; both rating systems can be used. The ratings are based mainly on the ages of children.

Overview

To insure complete coverage for all TV programs, (movies and regular TV shows) choose a rating for MPAA, from the selections below AND choose ratings from the TV Parental Guidelines Rating System on the next page, using the Age Block option for General Audiences, and for Children. In addition to those, you may wish to add additional restrictions from the Content Block menu. See the Parental Control menu, and submenus example on the next page.

Things to Consider before Setting Up Parental Control

Determine which rating you consider acceptable to the viewer. (For example, if you choose TV-PG, all more restrictive ratings will be automatically blocked; the viewer will not be able to see: TV-PG, TV-14, or TV-MA rated programming.)

Do you want to block the auxiliary video source entirely? (Blocks the signal sent by the equipment, such as a VCR, connected to the TV Audio/Video input jacks; in the Aux. Block option.) Or leave unblocked, then choose allowable ratings.

Block program “Content” based on individual parameters such as: Strong Dialog, Mature Language, Sex Scenes, Violence Scenes, or Fantasy Violence Scenes; in the Content Blk option.

How many hours do you want Parental Control to be active? You can set the Hours option for up to 99 hours.

Select a secret password; in the Set Password option. Use the number keys on the remote. Don’t forget the password, it is the only way you can access the Parental Control menu and change rating selections, or turn Parental Control off.

Do you want Parental Control to be active all the time? If not, you can turn it on or off; with the Lock On/Off option.



You can set different Parental Control viewing restrictions for general audiences and for children - - both can be active at the same time.



You cannot disable Parental Control by disconnecting the TV from power. Block hours remaining will be retained if power is lost or power cord is disconnected.



Simply specifying one content block such as Sex Scenes, will not automatically block another content in the programs from appearing.



The AUX input source can also be blocked.

Mini glossary

MOTION PICTURE ASSOCIATION OF AMERICA (MPAA) RATING SYSTEM

G	General Audiences	Content not offensive to most viewers.
PG	Parental Guidance Suggested	Content is such that parents may not want their children to view the program.
PG-13	Parental Guidance Suggested	Program is inappropriate for preteens, with a greater degree of offensive material than a PG rated program.
R	Restricted viewing	Not for children under age 17. Strong elements of sex and/or violence.
NC-17	Restricted Viewing	Not for children under age 17 under any circumstances. Strong sexual content.
X	Hard Core Films	Same as NC-17 rating.

Note: Zenith Electronics Corporation is not liable for any program content that appears when using this rating system; as always, user discretion is advised.

Parental Control Menu

After you have read the preceding page, follow instructions below to set up and activate Parental Control

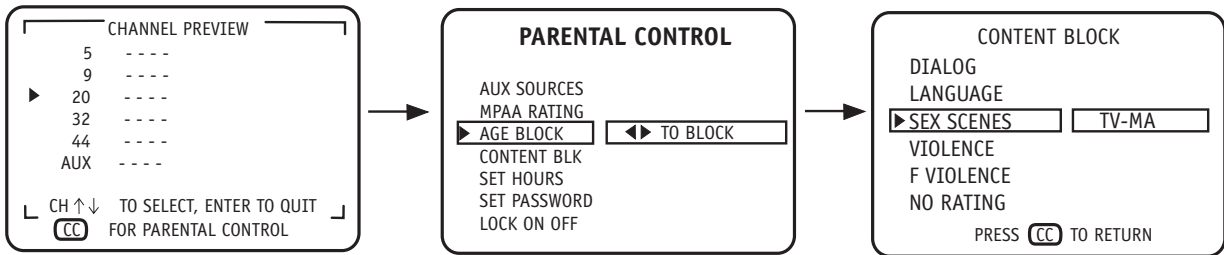

- 1** Press CH PREVIEW.
- 2** Use CHANNEL Up/Down to highlight PARENTAL CONTROL.
- 3** Press ADJ Right arrow to go to Parental Control menu.
- 4** Use SELECT to highlight an option like CONTENT BLOCK.
- 5** Press ADJ Right arrow to go to the CONTENT BLOCK menu.
- 6** Use SELECT to highlight an option like SEX SCENES.
- 7** Press ADJ Right arrow to choose: Unblocked, TV-PG AND ABOVE, TV-14 AND ABOVE, or TV-MA. (AND ABOVE means more restrictive headings are automatically included when you choose a low restriction setting like TV-PG.) See the Mini Glossary, Ratings Charts on this and the previous page for rating meanings.
- 8** After you have selected and adjusted the parental control menu options to your preferences:
 - Set the number of hours Parental Control will be on.
 - Set a 4-number password, using the number keypad.
 - Set the Lock On/Off option to either On or Off.
 Note: some broadcasts do not contain rating information.

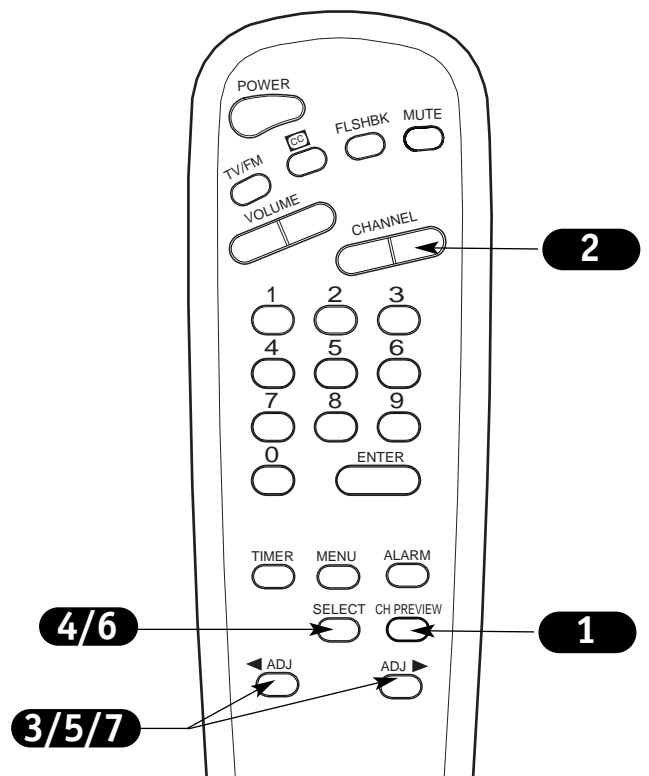

Mini glossary

TV PARENTAL GUIDELINE RATING SYSTEM

TV-G	General Audience	Considered suitable for all audiences; children may watch unattended.
TV-PG	Parental Guidance Suggested	Unsuitable for younger children, may contain: Suggestive Dialog, Mature Language, Sex, and Violence Scenes.
TV-14	Parents Strongly Cautioned	Unsuitable for children under 14, may contain: Strong Dialog, Mature Language, Sex, and Violence Scenes.
TV-MA	Mature Audience Only	Adults only, may contain: Strong Dialog, Mature Language, Sex, and Violence Scenes.

CHILDREN'S CLASSIFICATIONS

TV-Y	Children	Considered suitable for all children under 7 years old.
TV-Y7	Children 7 and over	Considered suitable for children over 7, may contain Fantasy Violence Scenes.

Parental Control Menu

Typical Parental Control Menu Structure

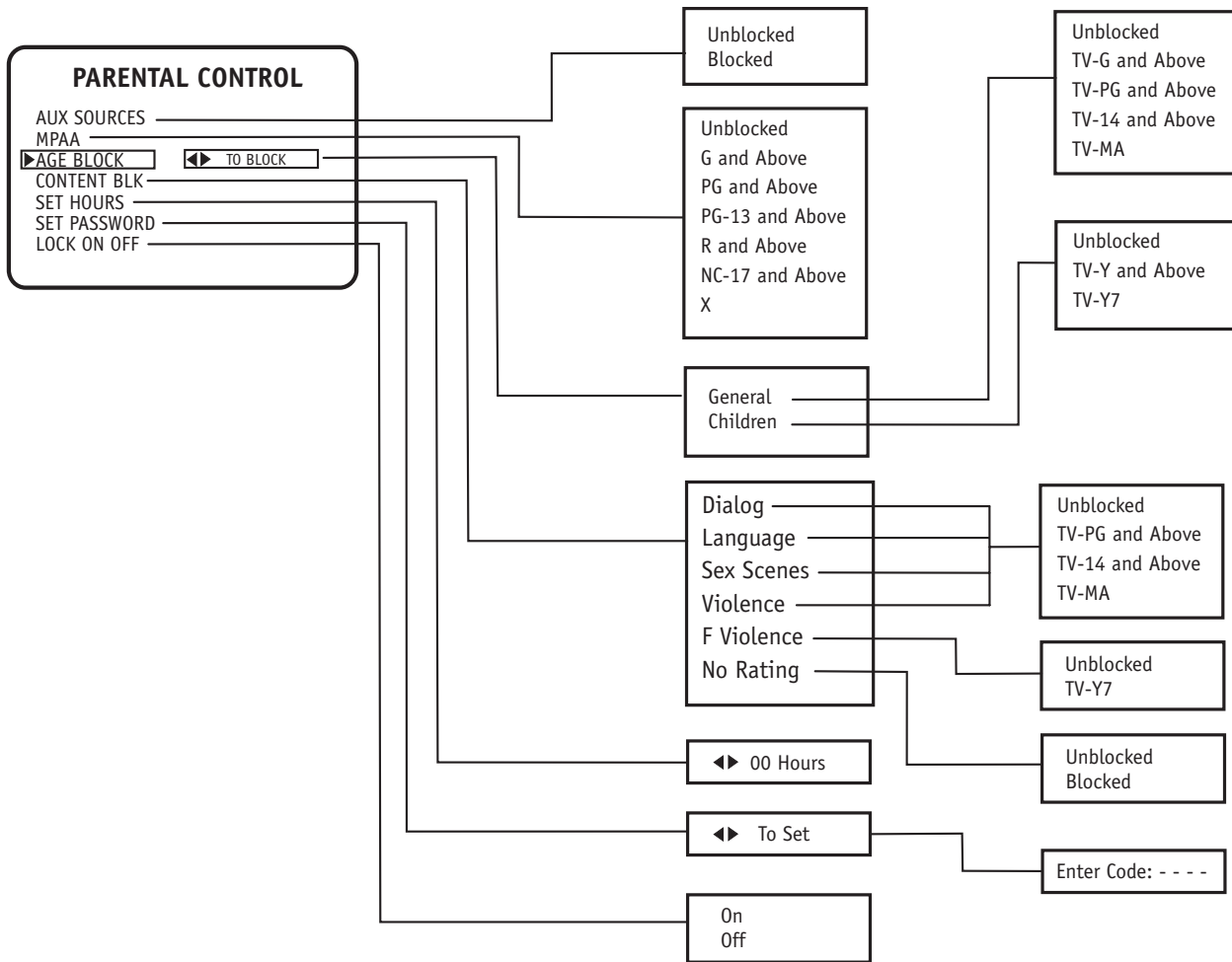
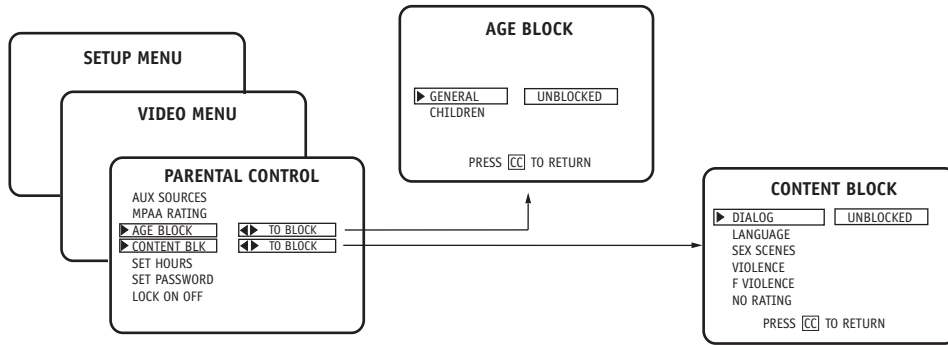

Menus & On-Screen Displays

Press the remote keys indicated below to access these menus and displays.

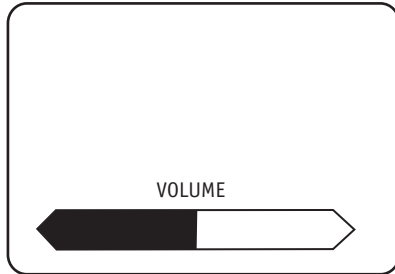

Volume Display

Press VOLUME. Shows currently selected sound setting.

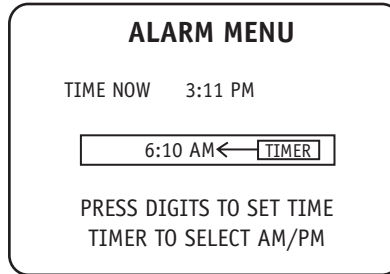

Alarm Menu

Press ALARM. Sets the time the TV will automatically turn itself on.



Sleep Timer Menu

Press TIMER. Shows remaining time before TV shutoff. Choose a preset time for TV turn-off.

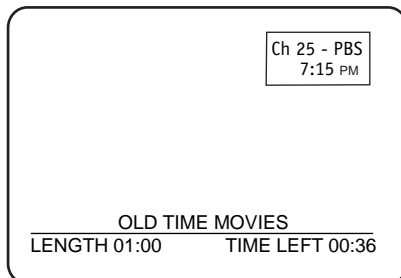

Channel/Time Display

Press ENTER. Shows currently selected channel or source, current time if the clock has been set, incoming audio signal, and XDS data if provided by broadcaster.



Closed Captions Menu

Press CC. Turns Caption/Text option On and Off.

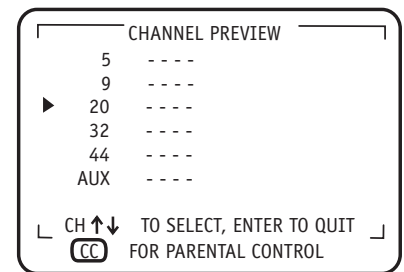

Ch Preview Menu

Press CH PREV. Displays list of the available TV Channels, Guest Parental Control menu, also used to select Auxiliary input source.

Maintenance

Routine TV cabinet and screen cleaning

Careful and regular cleaning can extend the the useful service life of the TV. Be sure to turn the power off and pull out the plug before you begin any cleaning.

Screen Cleaning

1. Here's a great way to keep the dust off the screen for a while. Wet a soft cloth in a mixture of lukewarm water and a little fabric softener or dish washing detergent. Wring the cloth until it's almost dry, and then use it to wipe the screen.
2. Make sure the excess water is off the screen, and then let it air-dry before turning it on.

Cabinet Cleaning

1. Use a soft cloth with a mild soap solution to wipe the cabinet. (Avoid using any harsh, industrial strength variety of cleaner.)
2. Rinse the cloth and wipe the cabinet again.
3. Let the cabinet air-dry before turning the Concierge TV on.

Wood Cabinet

Use a quality wood cleaner and polish. This will protect the TV from dirt and dust, as well as keep the cabinet looking new.

Extended Absence

If the TV is to be left dormant for a long time, it's a good idea to unplug the power cord to protect against possible damage from lightning or power surges. If you use an off-air antenna, you may also want to disconnect it from the back of the TV.



If you unplug the TV, you may have to reset the clock using the Clock Set menu described earlier. See page 18.

Troubleshooting

SYMPTOM

POSSIBLE SOLUTIONS

Snowy picture and unclear sound.

- Check antenna connection or location.
- Check cable input.
- Check to see if the TV/VCR button on VCR has the TV selected.

Multiple images or 'ghost shadows.'

- Check antenna direction and/or location.
- Check cable input
- Make sure the wire from the antenna to the TV is properly connected.

Interference: Sharp lines across the screen and poor sound.

The following may cause image problems or distortion: Electrical appliances, powerful lights, cars, trucks; computers or portable phones; medical equipment.

- If possible increase the distance between the The TV and the offending appliance. Or shut one of them off.

Normal picture but no sound.

- Check volume levels.
- Make sure the TV sound is not muted.
- Try another channel. The problem may be with the broadcast, not the TV.
- Are the Audio A/V cables properly installed?
- Are the wires for external speakers (if you have external speakers) properly installed?
- If the audio mode is set to SAP, the channel may not have a SAP program.

No picture and unclear sound.

- Are you in TV or cable tuning mode, and should be in the other?
- Make sure output channels on all A/V equipment are on the same channel (3 or 4).
- Check that all connections are tight.

No picture and no sound.

- Is the AC power cord plugged in?
- Check that your AC power outlet works. (Test it by plugging in another device or try another power outlet.)
- Make sure your brightness and audio controls are set properly.
- Try another channel. The problem may be with the broadcast.

No color, but the sound is O.K.

- Check the settings in the Video menu.
- Try another channel. The problem may be with the broadcast. Weak signal?
- Broadcast may be in black and white.

Picture has a big black box on it, but the sound is O.K.

- The CC (closed caption) option may be in Text mode. Select Caption 1, or OFF in the Captions/(Text) menu.

Remote control doesn't work.

- Make sure the batteries are fresh and installed properly. Obstruction to IR path?

Menu options can't be changed or selected.

- Make sure the batteries are fresh and installed properly.
- Try using front panel controls. Remote control problem?

No picture or sound when any non-cable source is selected.

- Try unplugging the TV for a few minutes, then plug it back in.
- Check to see if the source equipment has been turned on.
- Make sure that the connections are secure on the TV and source equipment.

No XDS Information.

- XDS data is provided at the discretion of the broadcasting station. Not all programs will have this information.

A list of definitions for words found in this guide.

75 OHM RF CABLE	The wire that comes from an off-air antenna or cable service provider. The end looks like a hex-shaped nut with a wire sticking through the middle. It screws onto the threaded jack on the back of the TV.
300 TO 75 OHM ADAPTER	A small device that connects a two-wire 300 ohm antenna to a 75 ohm RF jack. They are usually about an inch long with two screws on one end and a round opening with a wire sticking out on the other end.
A/V DEVICE	Any device that produces video or sound (VCR, DVD, cable box, or television).
ADD	This function lets you add new channels to list that the guest will scroll through using the guest remote.
AMPLIFIER	An electronic device that amplifies sound from a television, CD player, VCR, DVD or other A/V device.
ANTENNA	The physical receiver of television signals sent over the air. A large metal piece of equipment does not always have to be visible for your home to be using an antenna.
AUTO PROGRAM	Auto Program has the Concierge TV automatically find all the channels available in your area.
DELETE	Lets you remove channels from the list that the guest will scroll through using the guest remote.
INPUT	Refers to the jack that receives a signal from a TV, VCR, DVD, or other A/V device.
JACK	A connection on the back of a TV, VCR, or any other A/V device.
MONO SOUND	Mono (monaural) sound is one channel of sound. On more than one speaker, all the speakers play the same audio.
OUTPUT	Refers to the jack that sends a signal out of a VCR, DVD, or other A/V device.
2ND AUDIO PROGRAMMING/SAP	Second Audio Programming (SAP) is another, separate, audio channel Available with some programming. Choosing SAP often refers to listening to audio in another language, such as Spanish or French.
SIGNAL	Picture and sound traveling through a cable, or over the air, to your television screen.
TUNER	Device that receives the audio/video signals and turns them into picture and sound.
XDS	Extended Data Service: Additional program information provided at the discretion of the broadcaster.

Your Zenith TV Warranty

Direct-View Color TV Welcome to the Zenith family! We believe that you will be pleased with your new Zenith TV. Please read this warranty carefully, it is a "LIMITED WARRANTY" as defined under Federal Law. This warranty gives you specific legal rights, and you may also have other rights that vary from state to state within the U.S.A.

ZENITH'S RESPONSIBILITY

- Service Labor** During a period of one year from effective warranty date, Zenith will provide service labor by a Zenith authorized service center when needed, as determined by the Zenith service center, as a result of manufacturing defects.
- Parts** New or remanufactured replacements for factory-defective parts will be supplied by a Zenith authorized service center for one year from effective warranty date (color picture tube — two years). Such replacement parts are warranted for the remaining portion of the original warranty period.
- Warranty Service** Warranty service is provided in the institution in most cases. (Some repairs may require the unit to be taken by the servicer to the repair facility and returned, at no additional charge.) Call **1-888-865-3026** for further information.
- Not Covered** This warranty covers manufacturing defects and does not cover installation, adjustment of customer controls, installation or repair of antenna systems, cable converters or cable company-supplied equipment; it also does not cover damage due to misuse, abuse, negligence, acts of God or other causes beyond the control of Zenith. Any alteration of the product after manufacture voids this warranty in its entirety.

THIS WARRANTY IS IN LIEU OF ANY OTHER WARRANTY, EXPRESS OR IMPLIED, INCLUDING WITHOUT LIMITATION, ANY WARRANTY OF MERCHANTABILITY OR FITNESS FOR A PARTICULAR PURPOSE, AND ZENITH SHALL NOT BE LIABLE FOR ANY CONSEQUENTIAL, INDIRECT, OR INCIDENTAL DAMAGES OF ANY KIND, INCLUDING LOST REVENUES OR PROFITS IN CONNECTION WITH THIS PRODUCT. SOME STATES DO NOT ALLOW LIMITATIONS ON HOW LONG AN IMPLIED WARRANTY LASTS OR THE EXCLUSION OR LIMITATION OF INCIDENTAL OR CONSEQUENTIAL DAMAGES, SO THE ABOVE LIMITATIONS OR EXCLUSIONS MAY NOT APPLY TO YOU.

OWNER'S RESPONSIBILITY

- Effective Warranty Date** Warranty begins on the date of installation of the Commercial Products Direct-View Television Receiver.
For your convenience, keep the dealer's dated bill of sale or delivery ticket as evidence of the purchase date.
- Operating Guide** Read your Operating Guide carefully so that you will understand the operation of the TV and how to adjust the controls.
- Antenna** Reception problems caused by inadequate antenna or faulty antenna connections are the owner's responsibility.
- Warranty Service** **For warranty service information, call 1-888-865-3026.** Parts and service labor that are Zenith's responsibility (see above) will be provided without charge. Other service is at the owner's expense. If you have any problem in obtaining satisfactory warranty service, call **1-888-865-3026**. You must provide the model number, serial number and date of purchase or date of original installation. Before you ask for warranty service, read "Maintenance and Troubleshooting" in the operating guide. You might avoid a service call.

For Customer Support/Service
Please call:

1-888-865-3026

www.zenith.com