



LCD TV OWNER'S MANUAL

LCD TV MODELS

15LS1RA
20LS1RA

Please read this manual carefully before operating your set.

Retain it for future reference.

Record model number and serial number of the set.

See the label attached on the back cover and quote this information to your dealer when you require service.

P/NO : MFL34797015 (0705-REV00)
Printed in Korea

IMPORTANT SAFETY INSTRUCTIONS

Important safety instructions shall be provided with each apparatus. This information shall be given in a separate booklet or sheet, or be located before any operating instructions in an instruction for installation for use and supplied with the apparatus.

This information shall be given in a language acceptable to the country where the apparatus is intended to be used.

The important safety instructions shall be entitled “Important Safety Instructions”. The following safety instructions shall be included where applicable, and, when used, shall be verbatim as follows. Additional safety information may be included by adding statements after the end of the following safety instruction list. At the manufacturer’s option, a picture or drawing that illustrates the intent of a specific safety instruction may be placed immediately adjacent to that safety instruction :

WARNING

Read these instructions.

Keep these instructions.

Heed all warnings.

Follow all instructions.



- 1 Do not place the product in direct sunlight or near heat sources such as heat registers, stove and so on.

This may cause a fire.



- 2 Do not use the product in damp place such as a bathroom or any place where it is likely to get wet.

This may cause a fire or could give an electric shock.



- 3 Bend antenna cable between inside and outside building to prevent rain from flowing in.

This may cause water damaged inside the product and could give an electric shock.

- 4 Earth wire should be connected.

If the earth wire is not connected, there is possible a danger of electric shock caused by the current leakage.

If grounding methods are not possible, a separate circuit breaker should be employed and installed by a qualified electrician.

Do not connect ground to telephone wires, lightning rods or gas pipe.

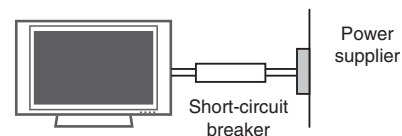

- 5 Do not placing anything containing liquid on top of the product.

This may cause a fire or could give an electric shock.



- 6 Wet Location Marking :

Apparatus shall not be exposed to dripping or splashing and no objects filled with liquids, such as vases, shall be placed on the apparatus.

- 7 Do not insert any object into the exhaust vent.

This may cause a fire or could give an electric shock.

- 8 Do not place heavy objects on the product.

This may cause serious injury to a child or adult.

WARNING

IMPORTANT SAFETY INSTRUCTIONS

WARNING

- 9** Do not use water the product while cleaning.
This may cause damaged the product or could give an electric shock.



- 10** In case of smoke or strange smell from the product, switch it off ,unplug it from the wall outlet and contact your dealer or service center.
This may cause a fire or could give an electric shock.

- 11** Do not attempt to service the product yourself. Contact your dealer or service center.
This may cause damaged the product or could give an electric shock.



- 12** Never touch this apparatus or antenna during a thunder or lighting storm.
This may cause an electric shock.

NOTE

- 1** Never touch the power plug with a wet hand.
This may cause an electric shock.

- 2** Disconnect from the mains and remove all connections before moving.

- 3** Do not place the product in a built-in installation such as a bookcase or rack.
Ventilation required.

- 4** When installing the product on a table, be careful not to place the edge of its stand.
This may cause the product to fall, causing serious injury to a child or adult, and serious damage to the product.

- 5** Do not place an outside antenna in the vicinity of overhead power lines or other electric light or power circuits.
This may cause an electric shock.

- 6** There should be enough distance between an outside antenna and power lines to keep the former from touching the latter even when the antenna falls.
This may cause an electric shock.

- 7** Do not pull the cord but the plug when unplugging.
This may cause a fire.

 **NOTE**

- 8** Ensure the power cord doesn't trail across any hot objects like a heater.

This may cause a fire or an electric shock.

- 9** Do not plug when the power cord or the plug is damaged or the connecting part of the power outlet is loose.

This may cause a fire or an electric shock.

- 10** Dispose of used batteries carefully to protect a child from eating them.

In case that it eats them, take it to see a doctor immediately.

- 11** When moving the product assembled with speakers do not carry holding the speakers.

This may cause the product to fall, causing serious injury to a child or adult, and serious damage to the product.

- 12** Unplug this product from the wall outlet before cleaning. Do not use liquid cleaners or aerosol cleaners.

This may cause damaged the product or could give an electric shock.

- 13** Contact the service center once a year to clean the internal part of the product.

Accumulated dust can cause mechanical failure.

- 14** The distance between eyes and the screen should be about 5 - 7 times as long as diagonal length of the screen.

If not, eyes will strain.

- 15** Unplug the product from the wall outlet when it is left unattended and unused for long periods of time.

Accumulated dust may cause a fire or an electric shock from deterioration or electric leakage.

- 16** Only use the specified batteries.

This may cause damaged the product or could give an electric shock.

- 17** Do not allow a impact shock or any objects to fall into the product, and do not drop onto the screen with something.

You may be injured or the product can be damaged.

 **NOTE**

- If the TV feels cold to the touch, there may be a small "flicker" when it is turned on. This is normal, there is nothing wrong with TV.

Some minute dot defects may be visible on the screen, appearing as tiny red, green, or blue spots. However, they have no adverse effect on the monitor's performance.

Avoid touching the LCD screen or holding your finger(s) against it for long periods of time. Doing so may produce some temporary distortion effects on the screen.

On Disposal

- a. The fluorescent lamp used in this product contains a small amount of mercury.
- b. Do not dispose of this product with general household waste.
- c. Disposal of this product must be carried out in accordance to the regulations of your local authority.

CONTENTS

WARNING	1
Important Safety Instructions	1

PREPARATION

Accessories	5
Front Panel Information	6
Back Panel Information	7
Stand Installation	8
Detaching Stand	9
Back Cover for Wire Arrangement	10
Positioning Your Display	11
Desktop Pedestal Installation	11
Kensington Security System	12
Antenna or Cable Connection	13

EXTERNAL EQUIPMENT SETUP

HD Receiver Setup	14
DVD Setup	16
Headphone Setup	17
VCR Setup	18
PC Setup	20
Screen Setup	21
- Auto Configure	21
- Manual Configure	22
- Initializing	23

WATCHING TV / CHANNEL CONTROL

Remote Control Functions	24
Turning On TV	26
Channel Selection	26
Volume Adjustment	26
On-Screen Menus Selection	27
Channel Search	28
- Auto Program: Channel Search	28
- Manual Program: Adding/Deleting Channels	29
Fine Tuning Adjustment	30
Favorite Channels Setup	31
Key Lock	32

PICTURE CONTROL

Preset Picture Settings	33
- Auto Picture Control (APC) - Preset	33
- Color Tone - Preset	34
Manual Picture Adjustment	35
- Auto Picture Control (APC) - User Mode	35
- Color Tone - User Mode	36
Picture Reset	37

SOUND & LANGUAGE CONTROL

Digital Auto Sound Processing (DASP)	38
Sound Setting Adjustment - User Mode	39
Auto Volume Leveler (AVL)	40
Balance	41
Stereo/SAP Broadcasts Setup	42
On-Screen Menus Language Selection	43
Caption/Text	44

TIME SETTING

Clock Setting	45
Auto On/Off Timer Setting	46
Sleep Timer Setting	47
Auto Shut-off Setting	48

APPENDIX

Troubleshooting	49
Maintenance	51
Product Specifications	52

PREPARATION

ACCESSORIES

Ensure that the following accessories are included with your product. If an accessory is missing, please contact the dealer where you purchased the product.

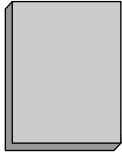

Owner's Manual



Remote Control

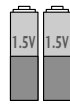

Batteries



Power Cord



Cable Management

PREPARATION

PREPARATION

FRONT PANEL INFORMATION

■ Here shown may be somewhat different from your TV.

Front Panel Controls

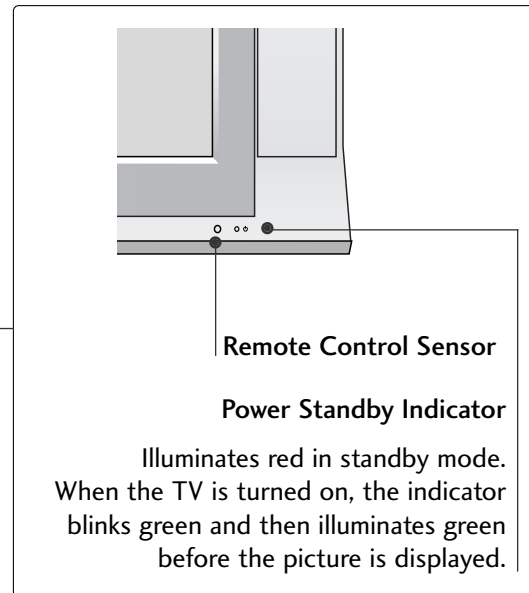
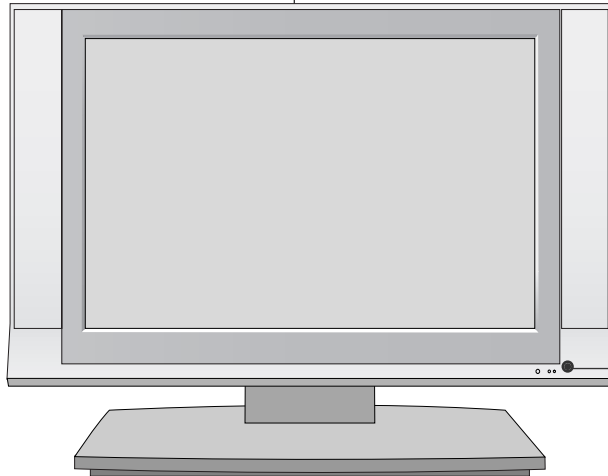
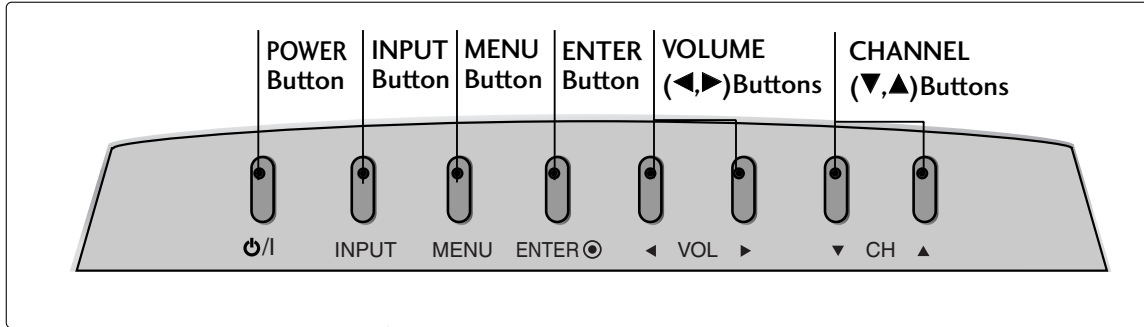

BACK PANEL INFORMATION

▪ Here shown may be somewhat different from your TV.

Back Connection Panel

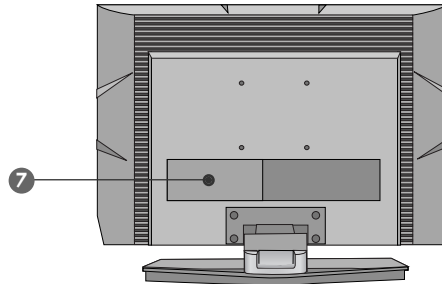

15 inches model

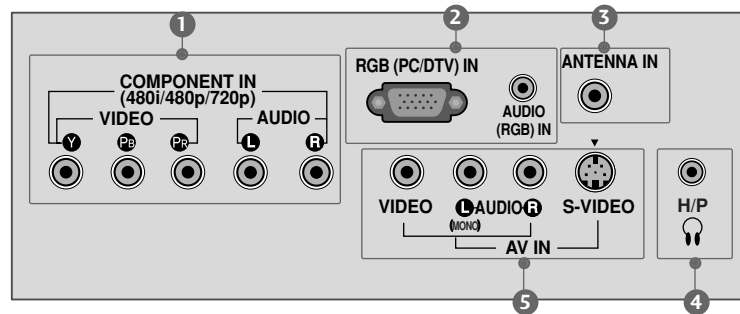

20 inches model

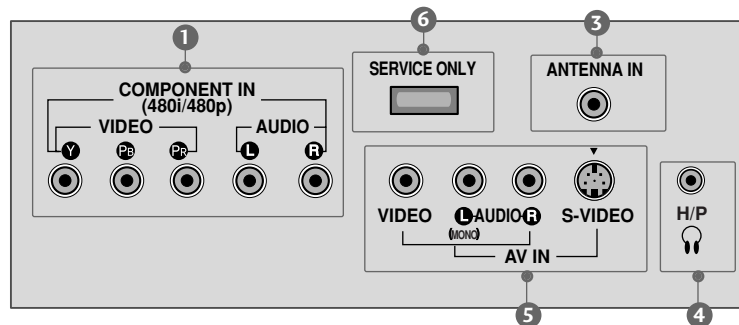

1 COMPONENT IN

Connect a component video/audio device to these jacks.

2 RGB (PC/DTV) IN

Connect the output from a PC or DTV.

AUDIO (RGB) IN

Connect the audio from a PC or DTV.

3 ANTENNA IN

Connect over-the air signals to this jack.

4 HEADPHONE INPUT

Plug the headphone into the headphone socket.

5 AV (Audio/Video) IN

Connect audio/video output from an external device to these jacks.

S-VIDEO

Connect S-Video out from an S-VIDEO device.

6 SERVICE ONLY

7 Power Cord Socket

For operation with AC power.

Caution: Never attempt to operate the TV on DC power.

PREPARATION

STAND INSTALLATION

▪ Here shown may be somewhat different from your TV.

PREPARATION

- 1 Assemble parts of the stand body with cover base of the stand. Insert the stand body into a cover base until clicking sound.

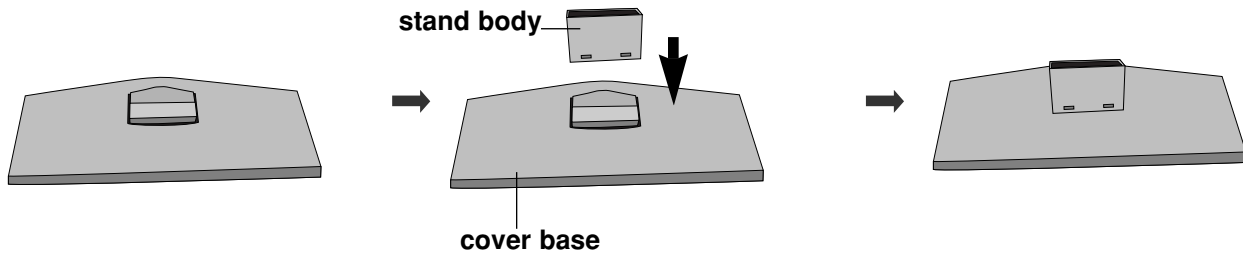

- 2 Carefully place the product screen side down on a cushioned surface that will protect product and screen from damage.

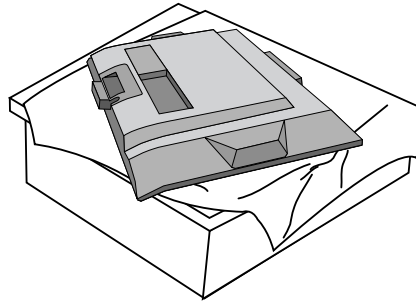

- 3 Place the product stand on the product as shown.

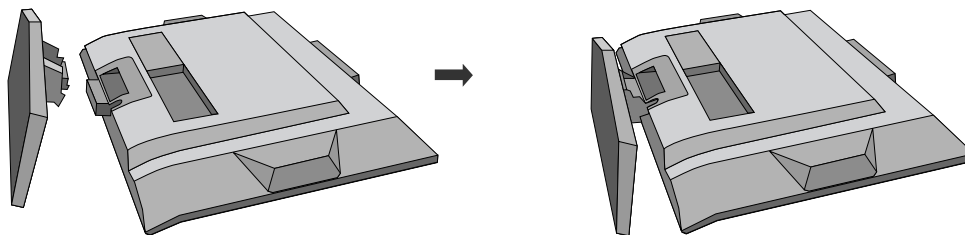

Make sure that the stand body is bent upward.

DETACHING STAND

▪ Here shown may be somewhat different from your TV.

- 1 Carefully place the product screen side down on a cushioned surface that will protect product and screen from damage.

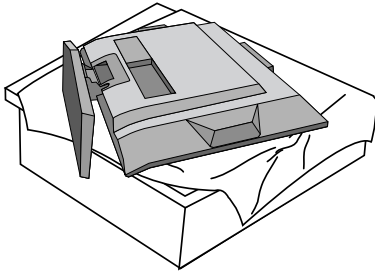

- 2 Hold the stand with both hands and bend it upward.

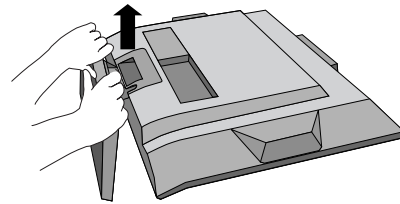

- 3 Pull each side of cover base backward during pressing latch upward.

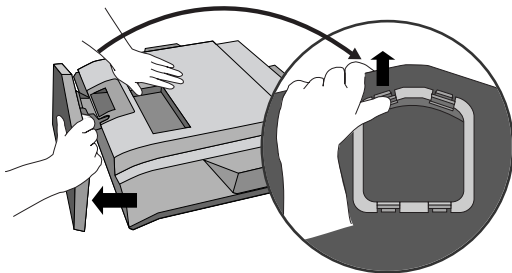

- 4 Hold cover base and pull with shake it backward to separate from stand body.

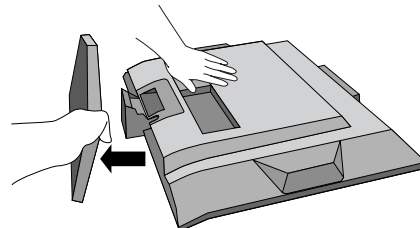

- 5 Pull stand body to separate from set while pressing the 2 latches.

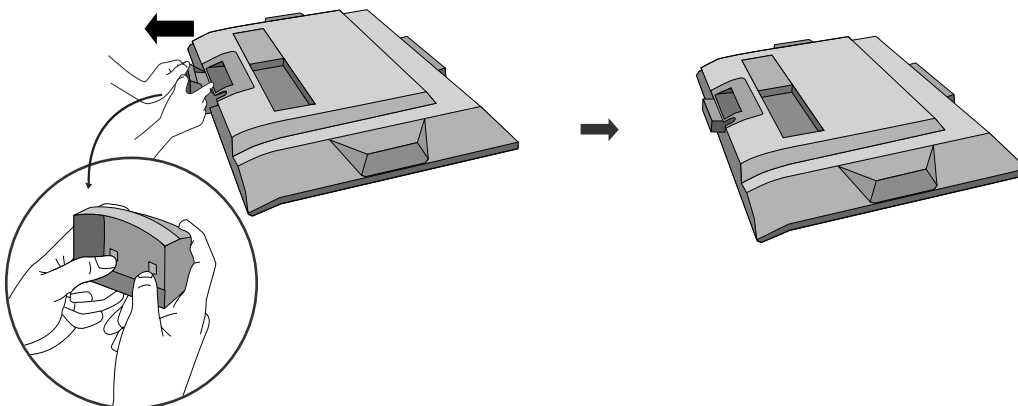

PREPARATION

BACK COVER FOR WIRE ARRANGEMENT

■ Here shown may be somewhat different from your TV.

- 1 Connect the cables as necessary.
To connect an additional equipment, see the **EXTERNAL EQUIPMENT SETUP** section.

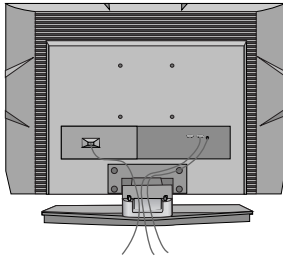

- 2 Install the **CABLE MANAGEMENT** as shown.

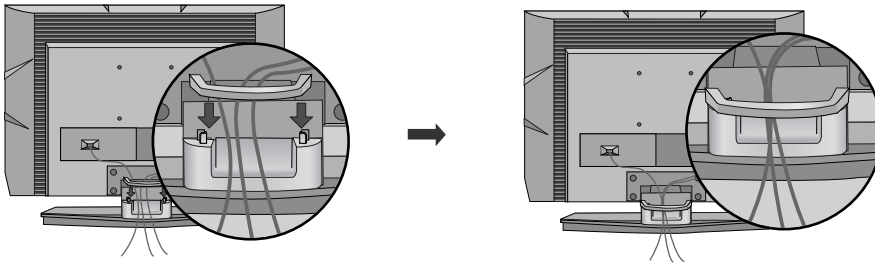

How to remove the **CABLE MANAGEMENT**

First, press the cable management. Hold the **CABLE MANAGEMENT** with both hands and pull it upward.

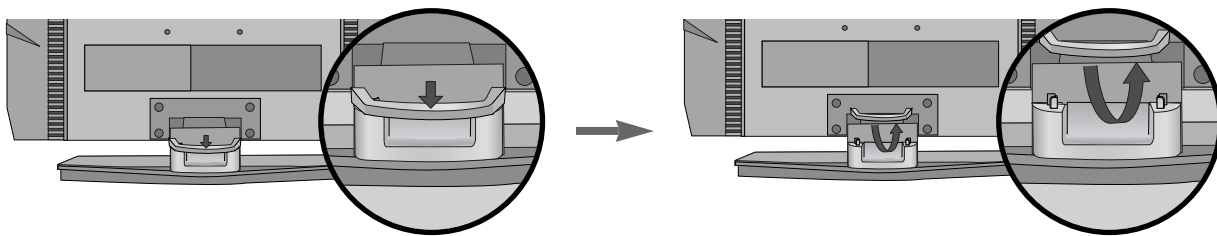

! NOTE

- ▶ Do not hold the **CABLE MANAGEMENT** when moving the product.
- If the product is dropped, you may be injured or the product may be broken.

POSITIONING YOUR DISPLAY

- Here shown may be somewhat different from your TV.
- Adjust the position of the panel in various ways for maximum comfort.

- **Tilt range**

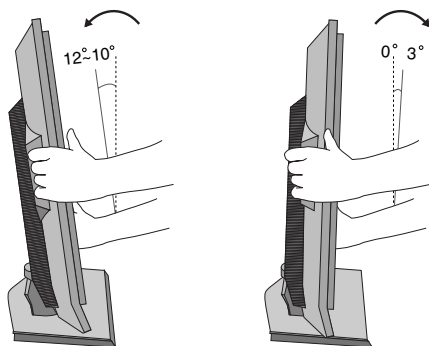

DESKTOP PEDESTAL INSTALLATION

For proper ventilation, allow a clearance of 4 inches on all four sides from the wall.

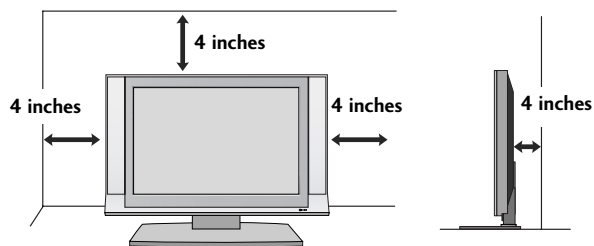

⚠ CAUTION ▶ Ensure adequate ventilation by following the clearance recommendations.

PREPARATION

KENSINGTON SECURITY SYSTEM

- The TV is equipped with a Kensington Security System connector on the back panel. Connect the Kensington Security System cable as shown below.
- For the detailed installation and use of the Kensington Security System, refer to the user's guide provided with the Kensington Security System.

For further information, contact <http://www.kensington.com>, the internet homepage of the Kensington company. Kensington sells security systems for expensive electronic equipment such as notebook PCs and LCD projectors.

NOTE

- The Kensington Security System is an optional accessory.

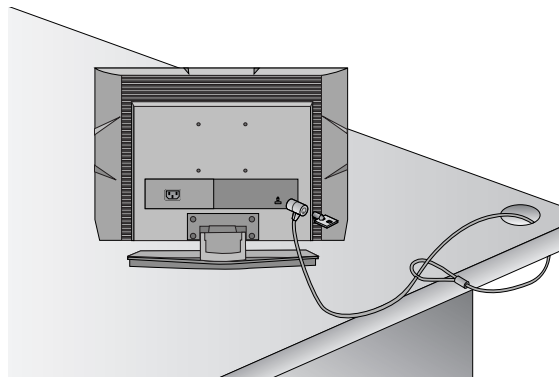

ANTENNA OR CABLE CONNECTION

1. Antenna (Analog or Digital)

Wall Antenna Socket or Outdoor Antenna without a Cable Box Connections.

For optimum picture quality, adjust antenna direction if needed.

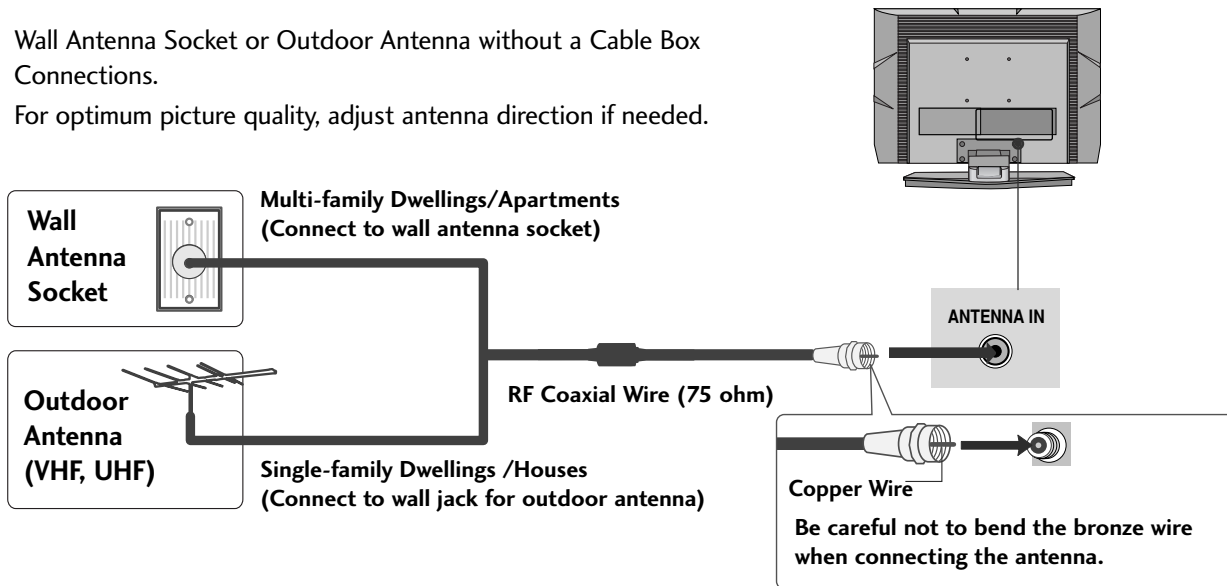

2. Cable

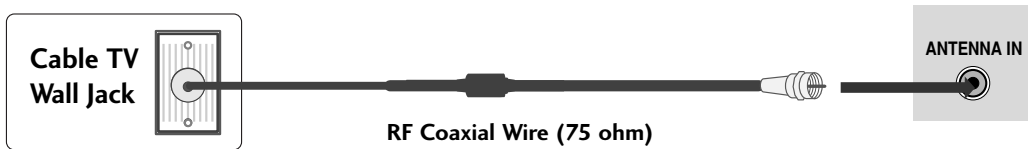

3. Using both cable and antenna

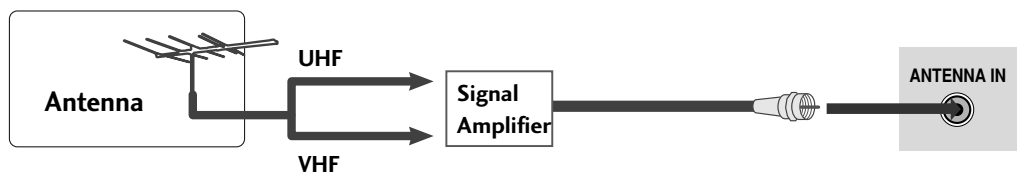
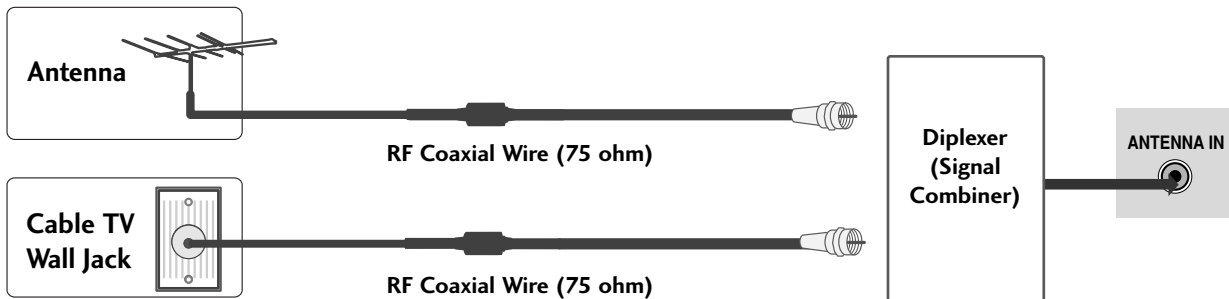

- To improve the picture quality in a poor signal area, please purchase a signal amplifier and install properly.
- If the antenna needs to be split for two TV's, install a 2-Way Signal Splitter.
- If the antenna is not installed properly, contact your dealer for assistance.

NOTE ▶ The TV will let you know when the analog, cable, and digital channel scans are complete.

EXTERNAL EQUIPMENT SETUP

- To prevent the equipment damage, never plug in any power cords until you have finished connecting all equipment.
- This part of EXTERNAL EQUIPMENT SETUP mainly use picture for the 15 inches model.

HD RECEIVER SETUP

To watch digitally broadcast programs, purchase and connect a digital set-top box.

When connecting Component cable

1. How to connect

- 1 Connect the video outputs (Y, PB, PR) of the digital set top box to the **COMPONENT IN VIDEO** jacks on the set. Match the jack colors (Y = green, PB = blue, and PR = red).
- 2 Connect the audio output of the digital set-top box to the **COMPONENT IN AUDIO** jacks on the set.

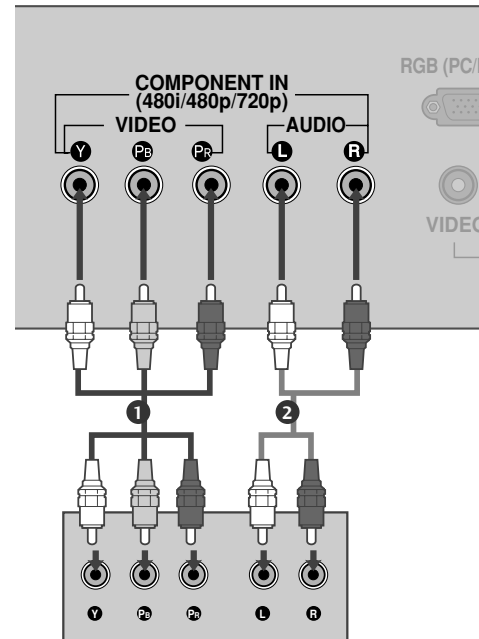

2. How to use

- Turn on the digital set-top box.
(Refer to the owner's manual for the digital set-top box. operation)
- Select **Component** input source by using the **INPUT** button on the remote control.

15 inches model

Signal	Component	RGB-DTV
480i, 480p	Yes	Yes
576i, 576p	Yes	Yes
720p	Yes	Yes

20 inches model

Signal	Component
480i	Yes
480p	Yes

When connecting with a D-sub 15 pin cable

(15 inches only)

1. How to connect

- 1 Connect the RGB output of the digital set-top box to the **RGB (PC/DTV) IN** jack on the set.
- 2 Connect the audio outputs of the set-top box to the **AUDIO (RGB) IN** jack on the set.

2. How to use

- Turn on the digital set-top box.
(Refer to the owner's manual for the digital set-top box.)
- Select **RGB** input source with using the **INPUT** button on the remote control.

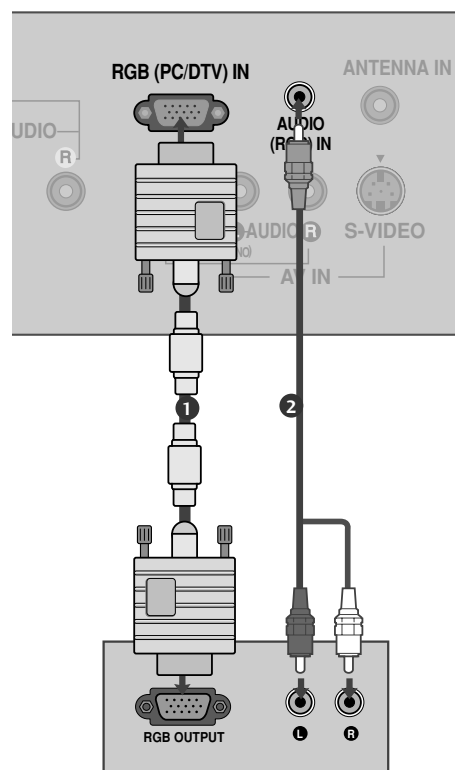

EXTERNAL EQUIPMENT SETUP

DVD SETUP

When connecting Component cable

1. How to connect

- 1 Connect the video outputs (Y, PB, PR) of the DVD to the **COMPONENT IN VIDEO** jacks on the set.
Match the jack colors
(Y = green, PB = blue, and PR = red).
- 2 Connect the audio outputs of the DVD to the **COMPONENT IN AUDIO** jacks on the set.

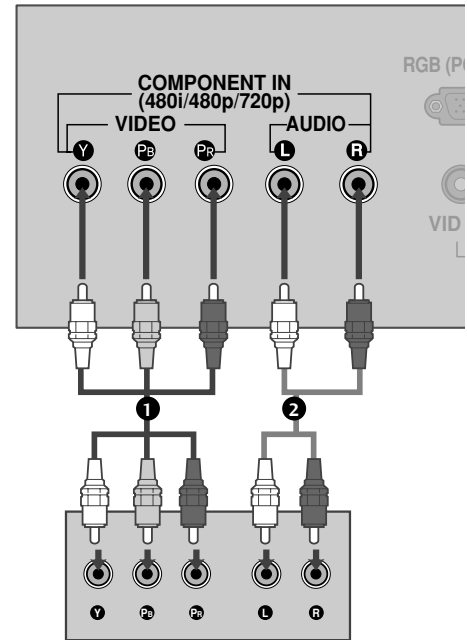

2. How to use

- Turn on the DVD player, insert a DVD.
- Select **Component** input source by using the **INPUT** button on the remote control.
- Refer to the DVD player's manual for operating instructions.

Component Input ports

To get better picture quality, connect a DVD player to the component input ports as shown below.

Component ports on the TV	Y	P _B	P _R
Video output ports on DVD player	Y	P _B	P _R
	Y	B-Y	R-Y
	Y	C _b	C _r
	Y	P _b	P _r

When connecting with an S-Video cable

1. How to connect

- 1 Connect the S-VIDEO output of the DVD to the S-VIDEO input on the set.
- 2 Connect the audio outputs of the DVD to the AUDIO input jacks on the set.

2. How to use

- Turn on the DVD player, insert a DVD.
- Select **AV** input source by using the **INPUT** button on the remote control.
- Refer to the DVD player's manual for operating instructions.

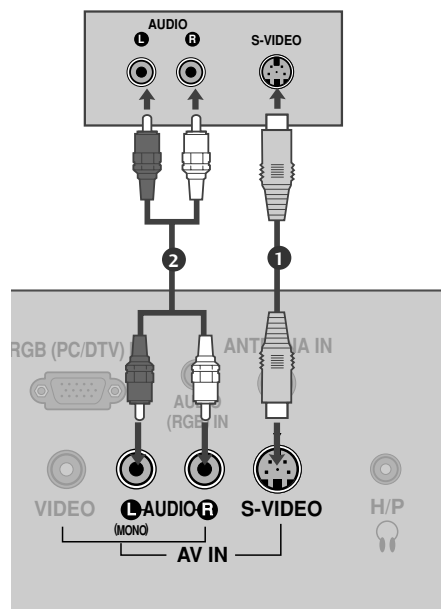

HEADPHONE SETUP

You can listen to the sound through the headphone.

1. How to connect

- 1 Plug the headphone into the headphone socket.
- 2 To adjust the headphone volume, press the **VOL** ◀ or ▶ button. If you press the **MUTE** button, the sound from the headphone is switched off.

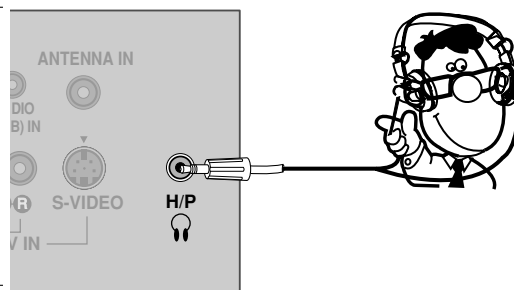

EXTERNAL EQUIPMENT SETUP

VCR SETUP

- To avoid picture noise (interference), leave an adequate distance between the VCR and TV.
- If the 4:3 picture format is used; the fixed images on the sides of the screen may remain visible on the screen. This phenomenon is common to all manufactures and in consequence the manufactures warranty does not cover the product bearing this phenomenon.

When connecting with an antenna

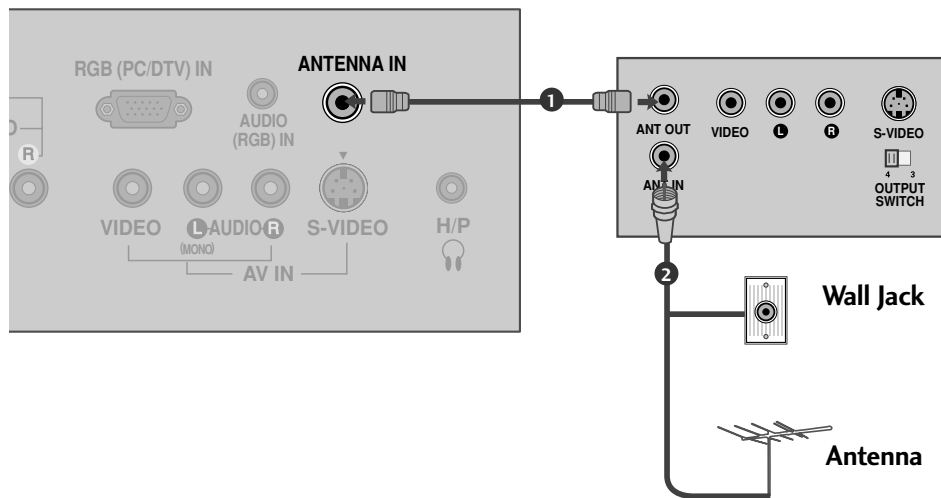

1. How to connect

- 1 Connect the RF antenna out socket of the VCR to the **ANTENNA IN** socket on the set.
- 2 Connect the antenna cable to the RF antenna in socket of the VCR.

2. How to use

- Set VCR output switch to 3 or 4 and then tune TV to the same channel number.
- Insert a video tape into the VCR and press PLAY on the VCR. (Refer to the VCR owner's manual.)

When connecting with a RCA cable

1. How to connect

- 1 Connect the **AUDIO/VIDEO** jacks between TV and VCR. Match the jack colors (Video = yellow, Audio Left = white, and Audio Right = red)

2. How to use

- Insert a video tape into the VCR and press PLAY on the VCR. (Refer to the VCR owner's manual.)
- Select **AV** input source by using the **INPUT** button on the remote control.

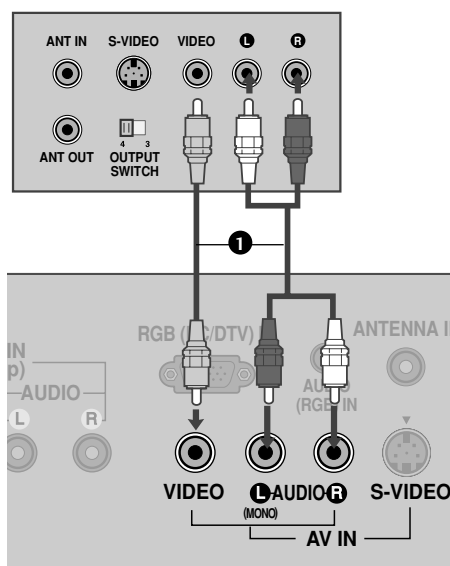

NOTE

- ▶ If you have a mono VCR, connect the audio cable from the VCR to the **AUDIO L/MONO** jack of the set.

When connecting with an S-Video cable

1. How to connect

- 1 Connect the S-VIDEO output of the VCR to the **S-VIDEO** input on the set.
- 2 Connect the audio outputs of the VCR to the **AUDIO** input jacks on the set.

2. How to use

- Insert a video tape into the VCR and press PLAY on the VCR. (Refer to the VCR owner's manual.)
- Select **AV** input source by using the **INPUT** button on the remote control.

NOTE

- ▶ The picture quality is improved: compared to normal composite (RCA cable) input.

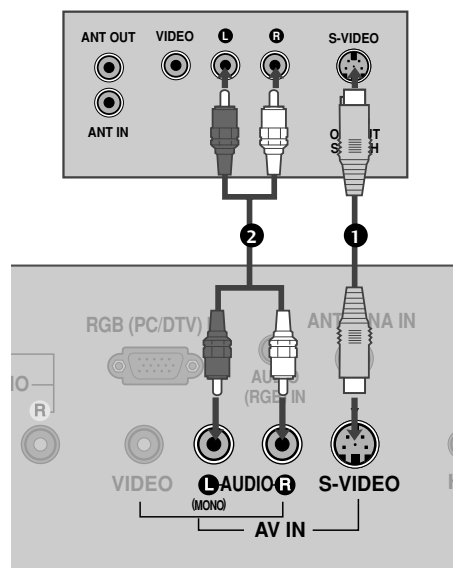

CAUTION

- ▶ Do not connect to both Video and S-Video at the same time. In the event that you connect both Video and the S-Video cables, only the S-Video will work.

EXTERNAL EQUIPMENT SETUP

PC SETUP (15 inches only)

This TV provides Plug and Play capability, meaning that the PC adjusts automatically to the TV's settings.

When connecting D-sub 15pin cable

1. How to connect

- 1 Connect the RGB output of the PC to the **RGB (PC/DTV) IN** jack on the set.
- 2 Connect the PC audio output to the **AUDIO (RGB) IN** jack on the set.

2. How to use

- Turn on the PC and the TV.
- Select **RGB** input source by using the **INPUT** button on the remote control.

Supported Display Specifications

RGB-PC mode

Resolution	Horizontal Frequency(KHz)	Vertical Frequency(Hz)
640x480	31.469	59.94
800x600	37.879 35.156	60.31 56.25
1024x768	48.363	60.00

RGB-DTV mode

Resolution	Horizontal Frequency(KHz)	Vertical Frequency(Hz)
720x480i	15.734	59.939
720x480p	31.469	59.94
720x576i	15.625	50.00
720x576p	31.25	50.00
1280x720p	37.50 44.955 45.00	50.00 59.94 60.00

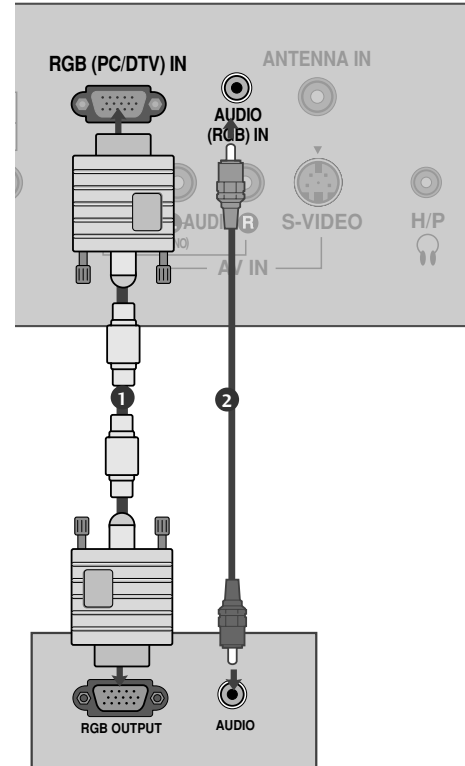

! NOTES

- ▶ To get the the best picture quality, adjust the PC graphics card to 1024x768, 60Hz.
- ▶ Using other formats (VGA, SVGA, etc.) or refresh rates may result in reduced picture quality. (To change the computer video output format, please refer to the operating manual for the computer you are using).
- ▶ Avoid keeping a fixed image on the screen for a long period of time. The fixed image may become permanently imprinted on the screen.
- ▶ If the message “No signal” appears on the screen, adjust the PC output to a format listed in the ‘Supported Display Specifications’.
- ▶ The synchronization input form for Horizontal and Vertical frequencies is separate.

SCREEN SETUP (15 inches only)

Auto Configure

Automatically adjusts picture position and minimizes image shaking. Although the image is still not correct, your set is functioning properly but needs further adjustment.

This function works in the following mode: RGB-PC mode.



- 1 Press the **A.PROG** button to start **Auto config.**
 - When **Auto config.** has finished, **Ok** will be shown on screen.
 - If the position of the image is still not correct, try Auto adjustment again.

- 2 If the picture needs to be adjusted more after Auto adjustment, you can adjust the **Manual config.**

- You can also use the **Screen** menu to adjust **Auto config.**

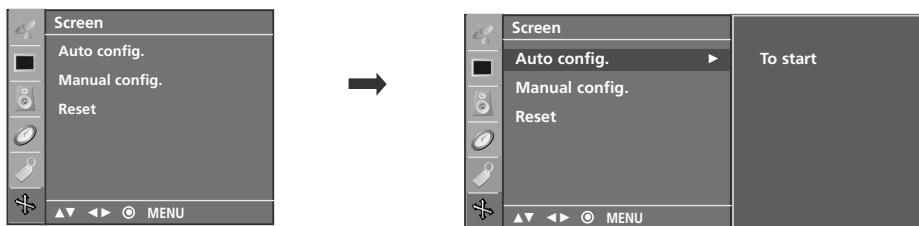

EXTERNAL EQUIPMENT SETUP

Manual Configure

If the picture isn't clear after auto adjustment and especially if characters are still trembling, adjust the picture phase manually.

This function works in the following mode: RGB-PC mode.

1 Press the **MENU** button and then use ▲ or ▼ button to select the **Screen** menu.

2 Press the ► button and then use ▲ or ▼ button to select **Manual config.**.

3 Press the ► button and then use ▲ or ▼ button to select **H-position, V-position, Phase, or Clock.**

■ **Phase**

This function allows you to remove any horizontal noise and clear or sharpen the image of characters.

■ **Clock**

This function is to minimize any vertical bars or stripes visible on the screen background. And the horizontal screen size will also change.

■ **H-position / V-position**

This function is to adjust picture to left/right and up/down as you prefer.

4 Press the ◀ or ▶ button to make appropriate adjustments.

5 Press the **ENTER** button to save.

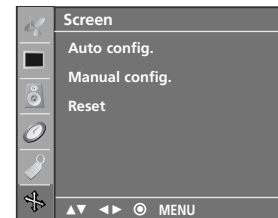

1

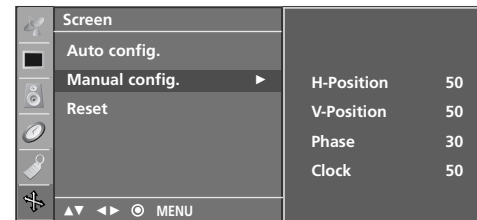

2 3 4

Initializing (Reset to original factory settings)

This function operates in current mode.

To initialize the adjusted value.

This function works in the following mode: RGB-PC mode.

1 Press the **MENU** button and then use ▲ or ▼ button to select the **Screen** menu.

2 Press the ► button and then use ▲ or ▼ button to select **Reset**.

3 Press the ► button.

- You can initialize H-Position, V-Position, Phase, Clock.
-

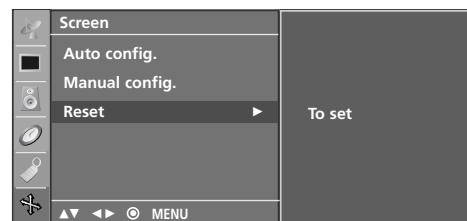
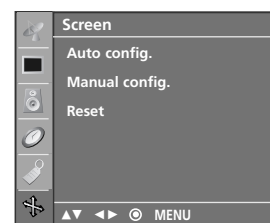

3 4

WATCHING TV / CHANNEL CONTROL

REMOTE CONTROL FUNCTIONS

When using the remote control, aim it at the remote control sensor on the TV.

- MTS** Selects the MTS sound: Mono, Stereo, or SAP. ▶ **p.42**
- A.PROG (AUTO PROGRAM)**

 - TV Mode: Searches for available channels. ▶ **p.28**
 - PC Mode: Adjust the screen automatically. ▶ **p.21**
- MEMORY/ERASE** Memorizes or erases selected channel. ▶ **p.29**
- CAPTION** Selects CAPTION mode. ▶ **p.44**
- CHANNEL UP/DOWN** Select available channels.
- VOLUME UP /DOWN** Increase/decrease the sound level.
- THUMBSTICK (Up/Down/Left Right/ENTER)** Navigate the on-screen menus and adjust the system settings to your preference.
- MENU** Displays the main menu.
- REVIEW** Tune to the last channel viewed.
- SLEEP** Select the amount of time before your TV turns off automatically. ▶ **p.47**
- APC** Selects the factory preset picture depend on the viewing environment. ▶ **p.33**
- DASP** Selects the factory preset sound for type of program. ▶ **p.38**
- ARC/ *** Not functional

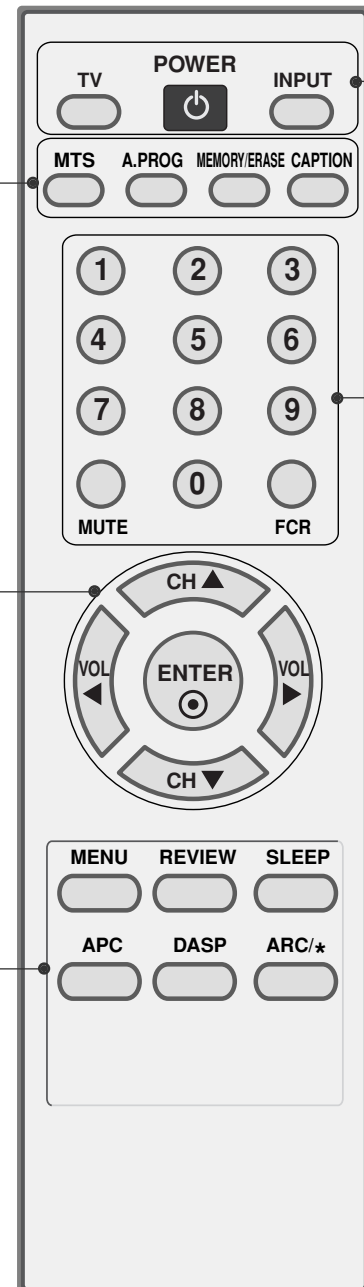

POWER Turns your TV or any other programmed equipment on or off, depending on the mode.

TV In AV, Component, and RGB input sources, screen returns to the last TV channel.

INPUT Select the desired input source: TV, AV, Component, and RGB.

NUMBER button

MUTE Switch the sound on or off. ► **p.26**

FCR Scroll through the programmed Favorite channels. ► **p.31**

Installing Batteries

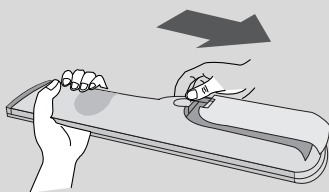

- Open the battery compartment cover on the back side and install the batteries matching correct polarity (+ with +, - with -).
- Install two 1.5V AAA batteries. Don't mix old or used batteries with new ones.
- Close cover.

Remote control effective range

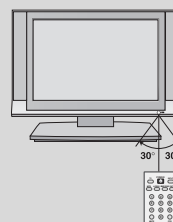

- Use a remote control up to 7 meters distance and 30 degree (left/right) within the receiving unit scope.
- Dispose of used batteries in a recycle bin to preserve environment.

WATCHING TV / CHANNEL CONTROL

TURNING ON TV

- 1 First, connect power cord correctly.
At this moment, the TV switches to standby mode.
 - In standby mode to turn TV on, press the $\phi/|$, **INPUT**, **CH** (\blacktriangle or \blacktriangledown) button on the TV or press the **POWER**, **TV**, **INPUT**, **CH** (\blacktriangle or \blacktriangledown), **Number** (0~9) button on the remote control.
- 2 Select the viewing source by using the **TV**, **INPUT** button on the remote control.
 - This TV is programmed to remember which power state it was last set to, even if the power cord is out.
- 3 When finished using the TV, press the **POWER** button on the remote control. The TV reverts to standby mode.



! NOTE

- ▶ If you intend to be away on vacation, disconnect the power plug from the wall power outlet.

CHANNEL SELECTION

- 1 Press the **CH** (\blacktriangle or \blacktriangledown) or **NUMBER** buttons to select a channel number.



VOLUME ADJUSTMENT

Adjust the volume to suit your personal preference.

- 1 Press the **VOL** (\blacktriangleleft or \blacktriangleright) button to adjust the volume.
- 2 If you want to switch the sound off, press the **MUTE** button.
- 3 You can cancel the Mute function by pressing the **MUTE** or **VOL** (\blacktriangleleft or \blacktriangleright) button.

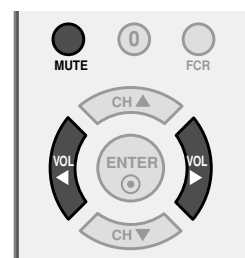

ON-SCREEN MENUS SELECTION

Your TV's OSD (On Screen Display) may differ slightly from what is shown in this manual.

- 1 Press the **MENU** button and then use **▲** or **▼** button to select the each menu.
- 2 Press the **▶** button and then use **▲ ▼ ◀ ▶** button to display the available menus.

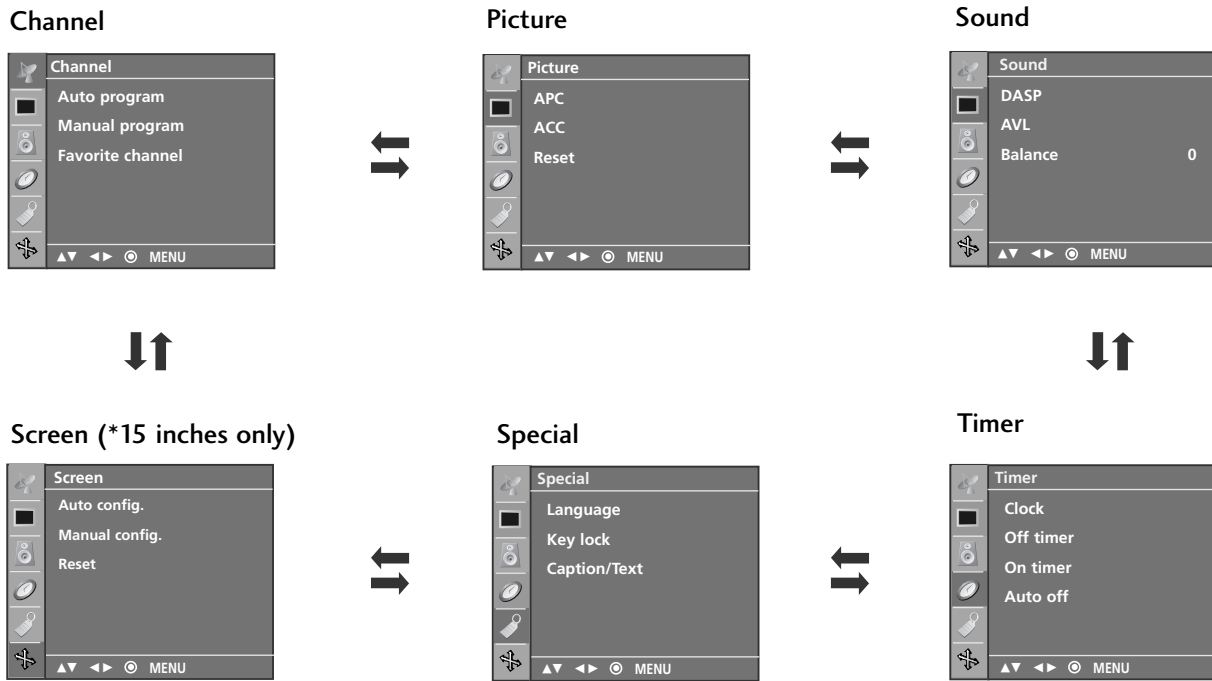

WATCHING TV / CHANNEL CONTROL

CHANNEL SEARCH

Auto Program: Channel Search

Auto Program should be used to memorize all the active channels in your area before you are able to use the TV.

There are two ways of storing channels in the TV's memory. You can use either.

One is called AUTO PROGRAM and the other is called MANUAL PROGRAM.

In AUTO PROGRAM mode, the TV will memorize the channels in ascending numerical order. If there are additional channels you want to add or delete, you can manually add or delete those channels with Manual Program.

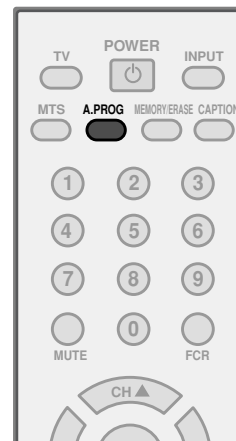

- Redo Auto Program if the TV is ever moved to another location.
- Auto Program will search for channels only through the Antenna jack.
- If channels numbers for broadcast over-the air TV and cable TV are duplicated where different channels have the same number, press the same number buttons again to toggle between:



(For example, press 17 to go to the channel, press 17 again to go to the duplicated channel.)

- 1 Press the **A.PROG** button. AUTO PROGRAM starts the channel search. If you want to stop auto programming, press the **MENU** button. Only the channels found up to at that time are memorized.

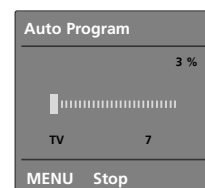

- You can also use the **Channel** menu to adjust **Auto program**.

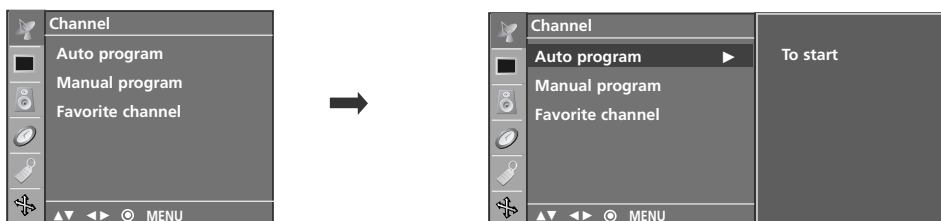

Manual Program: Adding/Deleting Channels

You can add or delete channels from the channel scan manually.

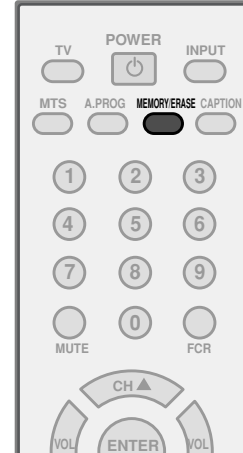

- 1 Use the **CH ▲ ▼** or **NUMBER** buttons to select the channel number you want to add or delete.
- 2 Press the **MEMORY/ERASE** button.
- 3 Press the **MEMORY/ERASE** button to select **Memory** or **Erase**.
- 4 Press the **ENTER** button.

- You can also use the **Channel** menu to adjust **Manual program**.

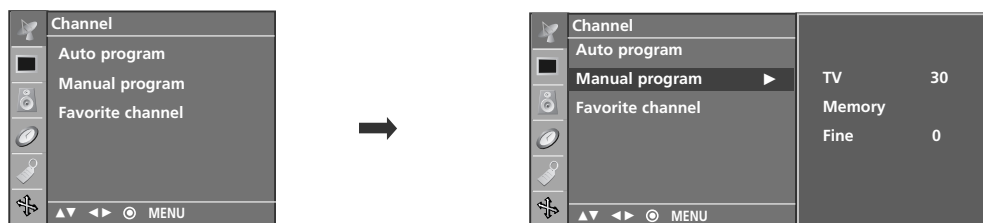

WATCHING TV / CHANNEL CONTROL

FINE TUNING ADJUSTMENT

Normally fine tuning is only necessary if reception is poor. To remove fine tuning from a channel, reprogram the finely-tuned channel with Auto program or Manual Program. If a finely-tuned channel is memorized, the color of the channel number changes to yellow.

WATCHING TV / CHANNEL CONTROL

- 1 Press the **MENU** button and then **▲** or **▼** button to select the **Channel** menu.
- 2 Press the **▶** button and then **▲** or **▼** button to select **Manual program**.
- 3 Press the **▶** button and then **▲** or **▼** button to select **Fine**.
- 4 Press the **◀** or **▶** button to adjust the picture to your preference.
- 5 Press the **ENTER** button to store it.

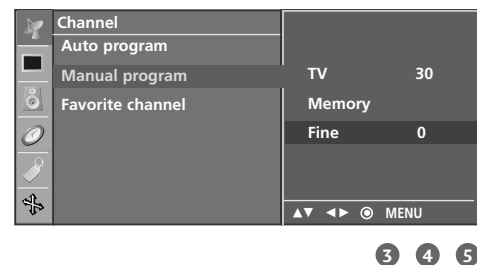
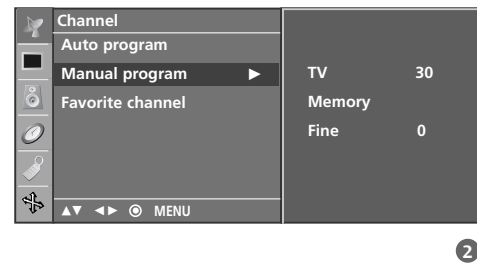

FAVORITE CHANNELS SETUP

Favorite Channels is a convenient feature that lets you quickly scan up to 8 channels of your choice without having to wait for the TV to scan through all the in-between channels.

To tune to a favorite channel, press the **FCR** (Favorite Channel Review) button repeatedly. The 8 favorite channels appear on the screen in numerical order.

- 1 Press the **MENU** button and then **▲** or **▼** button to select the **Channel** menu.

- 2 Press the **▶** button and then **▲** or **▼** button to select **Favorite Channel**.

- 3 Press the **▶** button and then **▲** or **▼** button to select the first favorite channel position.

- 4 Use the **◀** or **▶** button to set the desired channel number for first favorite channel.

- 5 Press the **ENTER** button to save.

- 6 Repeat steps 3 to 5 to memorize other favorite channels.

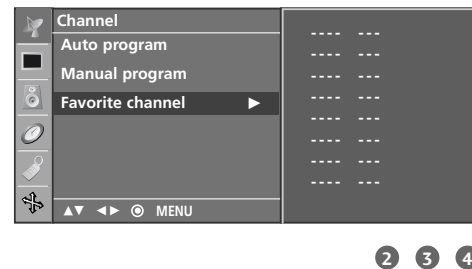

WATCHING TV /CHANNEL CONTROL

KEY LOCK

The TV can be set so that the remote control is needed to control it.

This feature can be used to prevent unauthorized viewing by locking out the front panel controls.

This TV is programmed to remember which option it was last set to even if you turn the set off.

1 Press the **MENU** button and then use **▲** or **▼** button to select the **Special** menu.

2 Press the **▶** button and then use **▲** or **▼** button to select **Key lock**.

3 Press the **▶** button and then use **▲** or **▼** button to select **On** or **Off**.

4 Press the **ENTER** button to save.



1

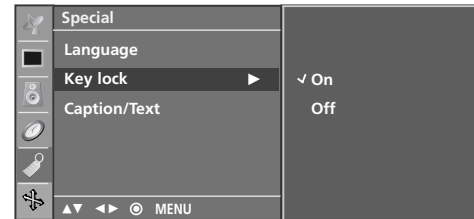

2 3

PICTURE CONTROL

PRESET PICTURE SETTINGS

Auto Picture Control (APC) - Preset

APC adjusts the TV for the best picture appearance.

Select the preset value in the APC menu based on the program category.

Clear, Optimum, Soft Settings are preset for optimum picture quality at the factory and are not adjustable.

In the **User** mode only, you can directly adjust the contrast, brightness, color, sharpness, tint.



- 1 Press the **APC** button repeatedly to select the picture appearance setup option as below :
Clear, Optimum, Soft, and User (your own settings).

- 2 Press the **ENTER** button to save.

- You can also use the **Picture** menu to adjust **APC**.

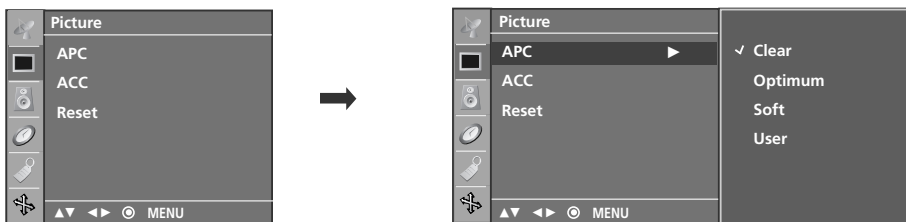

PICTURE CONTROL

Color Tone - Preset

Choose one of three automatic color adjustments. Set to warm to enhance hotter colors such as red, or set to cool to see less intense colors with more blue.



PICTURE CONTROL

1 Press the **MENU** button and then ▲ or ▼ button to select the **Picture** menu.

2 Press the ► button and then ▲ or ▼ button to select **ACC**.

3 Press the ► button and then ▲ or ▼ button to select either **Cool**, **Normal**, **Warm**, or **User**.

4 Press the **ENTER** button to save.

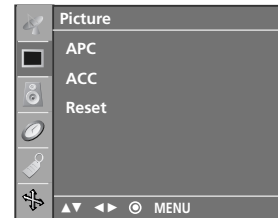

1

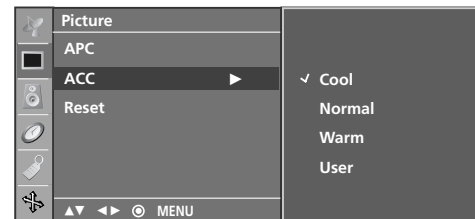

2 3

MANUAL PICTURE ADJUSTMENT

Auto Picture Control (APC) - User Mode

Adjust the picture appearance to suit your preference and viewing situations.

1 Press the **MENU** button and then ▲ or ▼ button to select the **Picture** menu.

2 Press the ► button and then ▲ or ▼ button to select **APC**.

3 Press the ► button and then ▲ or ▼ button to select **User**.

4 Press the ► button and then ▲ or ▼ button to select the desired picture option (**Contrast, Brightness, Color, Sharpness, and Tint**).

5 Press the ► button and then ◀ or ▶ button to make appropriate adjustments.

6 Press the **ENTER** button to save.

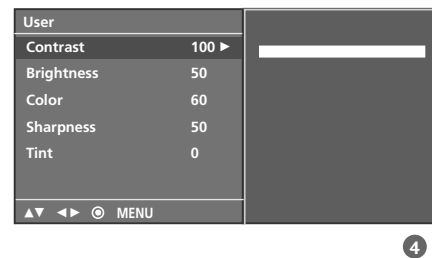
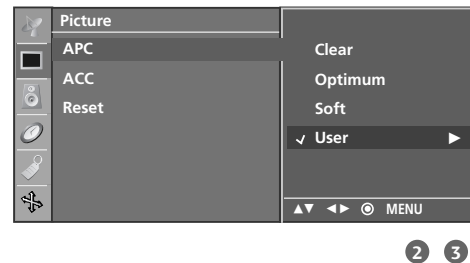
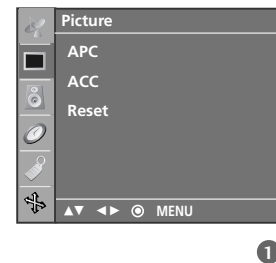

PICTURE CONTROL

Color Tone - User Mode

You can also adjust the detailed settings (Red, Green, Blue) by selecting the **User** menu.



1 Press the **MENU** button and then **▲** or **▼** button to select the **Picture** menu.

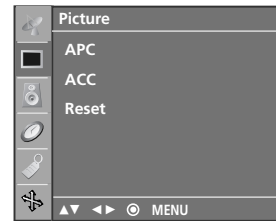

2 Press the **▶** button and then **▲** or **▼** button to select **ACC**.

3 Press the **▶** button and then **▲** or **▼** button to select **User**.

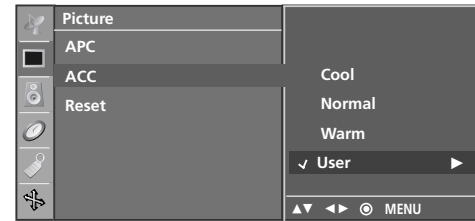

4 Press the **▶** button and then **▲** or **▼** button to select **Red, Green, or Blue**.

5 Press the **▶** button and then **◀** or **▶** button to make appropriate adjustments.

- The adjustment range of **Red, Green, or Blue** is -30 ~ +30.



6 Press the **ENTER** button to save.



PICTURE RESET

Use to quickly reset all the Picture menu options to their original factory preset values.

1 Press the **MENU** button and then ▲ or ▼ button to select the **Picture** menu.

2 Press the ► button and then ▲ or ▼ button to select **Reset**.

3 Press the ► button to initialize the adjusted value.

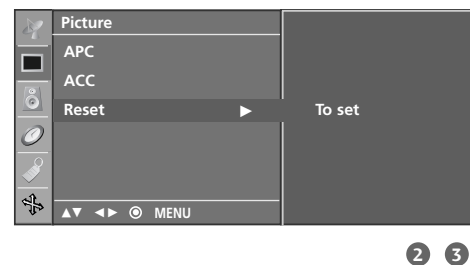
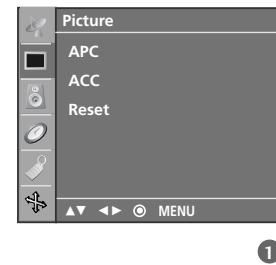

SOUND & LANGUAGE CONTROL

DIGITAL AUTO SOUND PROCESSING (DASP)

DASP lets you enjoy the best sound without any special adjustment because the TV sets the appropriate sound options based on the program content.

Flat, Music, Movie, and Sports are preset for good sound quality at the factory and are not adjustable.



1 Press the **DASP** button repeatedly to select the appropriate sound setup as below :
Flat, Music, Movie, Sports, and User (your own settings).

2 Press the **ENTER** button to save.

■ You can also adjust **DASP** in the **Sound** menu.

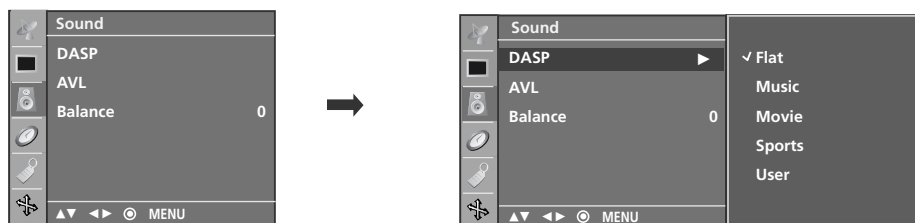

SOUND SETTING ADJUSTMENT - USER MODE

Adjust the sound equalizer.

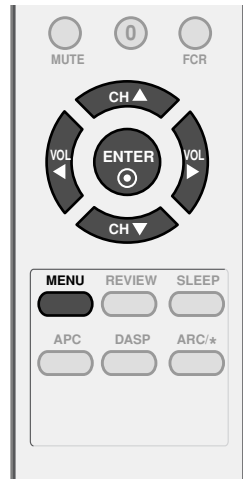

1 Press the **MENU** button and then use ▲ or ▼ button to select the **Sound** menu.

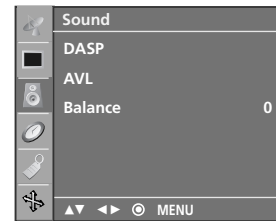

1

2 Press the ► button and then use ▲ or ▼ button to select **DASP**.

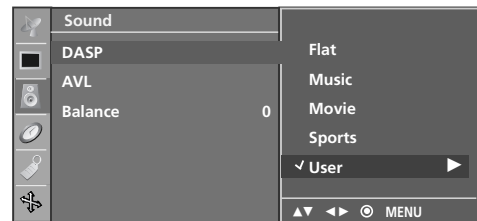

2 3

3 Press the ► button and then use ▲ or ▼ button to select **User**.

4 Press the ► button.

5 Press the ◀ or ▶ button to select the band you want to adjust.
Press the ▲ or ▼ button to adjust the band level.

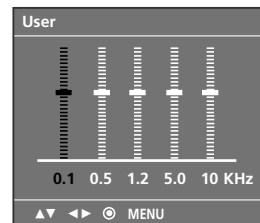

4 5

6 Press the **ENTER** button to save.

SOUND & LANGUAGE CONTROL

AUTO VOLUME LEVELER (AVL)

AVL automatically keeps on an equal volume level even if you change program.

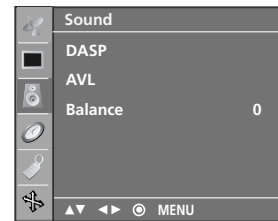

1 Press the **MENU** button and then use ▲ or ▼ button to select the **Sound** menu.

2 Press the ► button and then use ▲ or ▼ button to select **AVL**.

3 Press the ► button and then use ▲ or ▼ button to select **On** or **Off**.

4 Press the **ENTER** button to save.

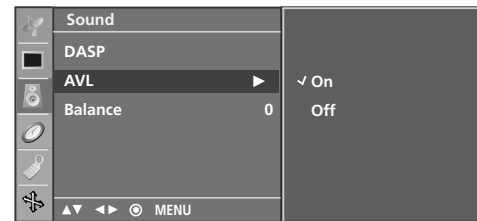

3

BALANCE

Adjust the left/right sound of speaker to suit your taste and room situations.

1 Press the **MENU** button and then use ▲ or ▼ button to select the **Sound** menu.

2 Press the ► button and then use ▲ or ▼ button to select **Balance**.

3 Press the ► button and then use ◀ or ▶ button to make appropriate adjustments.

4 Press the **ENTER** button to save.

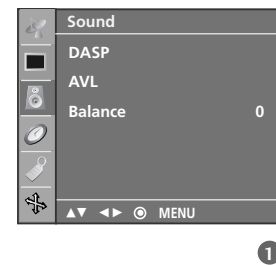

SOUND & LANGUAGE CONTROL

STEREO/SAP BROADCASTS SETUP

The TV can receive MTS stereo programs and any SAP (Secondary Audio Program) that accompanies the stereo program; if the broadcaster transmits one additional sound signal in addition to the original one.

Mono: The primary language is heard from left and right speakers. Signal mode is mono.

Stereo: The primary language is heard from left and right speakers. Signal mode is stereo.

SAP: The secondary language is heard from left and right speakers in mono sound.

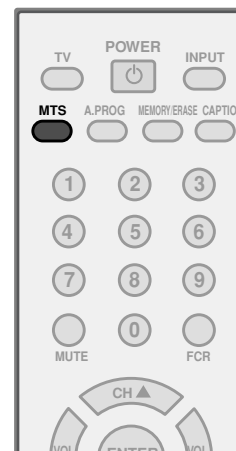

1 Use the **MTS** button to select your desired MTS mode in analog signal. Each time you press the **MTS** button, **Mono**, **Stereo**, or **SAP** appear in turn.

2 Press the **ENTER** button to save.

! NOTE

- ▶ Select mono sound mode if the signal is not clear or in poor signal reception areas.
- ▶ **Stereo**, **SAP** modes are available only if included on the broadcast signal.

ON-SCREEN MENUS LANGUAGE SELECTION

The menus can be shown on the screen in the selected language. First select your language.



1 Press the **MENU** button and then use ▲ or ▼ button to select the **Special** menu.

2 Press the ► button and then use ▲ or ▼ button to select **Language**.

3 Press the ► button and then use ▲ or ▼ button to select your desired language.
From this point on, the on-screen menus will be shown in the selected language.

4 Press the **ENTER** button to save.

SOUND & LANGUAGE CONTROL

CAPTION / TEXT

Closed captioning is a process which converts the audio portion of a television program into written words which then appear as subtitles on the television screen. Closed captions allow viewers to read the dialogue and narration of television programs.

Using Closed Captions

Captions are the subtitles of the dialogue and narration of television programs. For prerecorded programs, program dialogue can be arranged into captions in advance. Its possible to caption a live program by using a process called real-time captioning, which creates captions instantly. Real-time captioning is normally done by professional reporters using a machine shorthand system

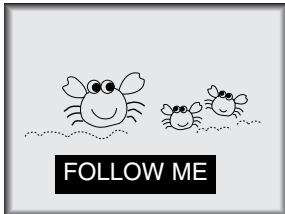

and computer for translation into English. Captioning is an effective system for the hearing-impaired, and it can also aid in teaching language skills.

- The picture at left shows a typical caption.

Caption Tips

- Not all TV broadcasts include closed caption signals.
- Sometimes TV stations broadcast four different caption signals on the same channel. By selecting Mode1 to Mode2, you can choose which signal you view. Mode1 is usually the signal with the captions, while another mode might show demonstration or programming information.
- Your TV might not receive caption signals normally in the following situations.

1. Poor reception conditions are encountered:



- **IGNITION:**

Picture may flutter, drift, suffer from black spots, or horizontal streaking. Usually caused by interference from automobile ignition systems, neon lamps, electrical drills, and other electrical appliances.



- **GHOSTS:**

Ghosts are caused when the TV signal splits and follows two paths. One is the direct path and the other is reflected off tall buildings, hills or other objects. Changing the direction or position of the antenna may improve reception.



- **SNOW:**

If your receiver is located at the weak, fringe area of a TV signal, your picture may be marred by small dots. It may be necessary to install a special antenna to improve the picture.

2. An old, bad, or illegally recorded tape is being played.
3. Strong, random signals from a car or airplane interfere with the TV signal.
4. The signal from the antenna is weak.
5. The program wasn't captioned when it was produced, transmitted, or taped.

- 1 Use the **CAPTION** button repeatedly to select your caption Mode 1, Mode 2, Text1, Text2, or Off.

- 2 Press the **ENTER** button to save.

- You can also adjust **Caption/Text** in the **Special** menu.

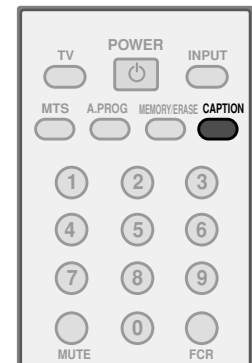

TIME SETTING

CLOCK SETTING

If the current time setting is wrong, reset the clock manually.

- 1 Press the **MENU** button and then ▲ or ▼ button to select the **Timer** menu.
- 2 Press the ► button and then ▲ or ▼ button to select **Clock**.
- 3 Press the ► button and then use ▲ or ▼ button to set the Hour.
- 4 Press the ► button and then use ▲ or ▼ button to set the minutes.
- 5 Press the **ENTER** button to save.

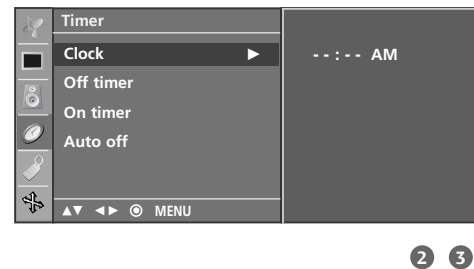
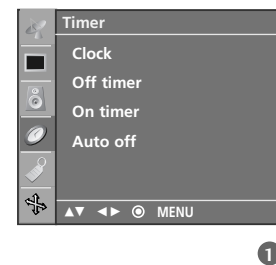

TIME SETTING

AUTO ON/OFF TIMER SETTING

The timer function operates only if the current time has been set.

The Off-Timer function overrides the On-Timer function if they are both set to the same time.

The TV must be in standby mode for the On-Timer to work. If you do not press any button within 2 hours after the TV turns on with the On Timer function, the TV will automatically revert to standby mode.



1 Press the **MENU** button and then **▲** or **▼** button to select the **Timer** menu.

2 Press the **▶** button and then use **▲** or **▼** button to select **Off timer** or **On timer**.

3 Press the **▶** button and then use **▲** or **▼** button to set the hour.

4 Press the **▶** button and then use **▲** or **▼** button to set the minutes.

5 **Only On timer**
Press the **▶** button and then use **▲** or **▼** to select the channel at turn-on.
Press the **▶** button and then use **▲** or **▼** to set the sound level at turn-on.

6 Press the **▶** button and then use **▲** or **▼** button to select **On**.
■ To cancel the **On/Off timer** function, select **Off**.

7 Press the **ENTER** button to save.

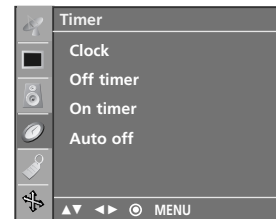

1



2 3 4 5 6

SLEEP TIMER SETTING

The Sleep Timer turns the TV off at the preset time.

Note that this setting is cleared when the TV is turned off.



1 Press the **SLEEP** button repeatedly to select the number of minutes. First the '⌚ - - -' option appears on the screen, followed by the following sleep timer options : 10, 20, 30, 60, 90, 120, 180, and 240 minutes.

2 When the number of minutes you want is displayed on the screen, press the **ENTER** button. The timer begins to count down from the number of minutes selected.

3 To check the remaining minutes before the TV turns off, press the **SLEEP** button once.

4 To cancel the Sleep Timer, press the **SLEEP** button repeatedly to select '⌚ - - -'.

TIME SETTING

AUTO SHUT-OFF SETTING

If set to on and there is no input signal, the TV turns off automatically after 10 minutes.



1 Press the **MENU** button and then use ▲ or ▼ button to select the **Timer** menu.

2 Press the ► button and then use ▲ or ▼ button to select **Auto off**.

3 Press the ► button and then use ▲ or ▼ button to select **On** or **Off**.

4 Press the **ENTER** button to save.



1



2 3

APPENDIX

TROUBLESHOOTING

The operation does not work normally.	
The remote control doesn't work	<ul style="list-style-type: none">■ Check to see if there is any object between the product and the remote control causing obstruction. Ensure you are pointing the remote control directly at the TV.■ Ensure that the batteries are installed with correct polarity (+ to +, - to -).■ Ensure that the correct remote operating mode is set: TV, VCR etc.■ Install new batteries.
Power is suddenly turned off	<ul style="list-style-type: none">■ Is the sleep timer set?■ Check the power control settings. Power interrupted.■ No broadcast on station tuned with Auto off activated.

The video function does not work.	
No picture & No sound	<ul style="list-style-type: none">■ Check whether the product is turned on.■ Try another channel. The problem may be with the broadcast.■ Is the power cord inserted into wall power outlet?■ Check your antenna direction and/or location.■ Test the wall power outlet, plug another product's power cord into the outlet where the product's power cord was plugged in.
Picture appears slowly after switching on	<ul style="list-style-type: none">■ This is normal, the image is muted during the product startup process. Please contact your service center, if the picture has not appeared after five minutes.
No or poor color or poor picture	<ul style="list-style-type: none">■ Adjust Color in menu option.■ Keep a sufficient distance between the product and the VCR.■ Try another channel. The problem may be with the broadcast.■ Are the video cables installed properly?■ Activate any function to restore the brightness of the picture.
Horizontal/vertical bars or picture shaking	<ul style="list-style-type: none">■ Check for local interference such as an electrical appliance or power tool.
Poor reception on some channels	<ul style="list-style-type: none">■ Station or cable product experiencing problems, tune to another station.■ Station signal is weak, reorient antenna to receive weaker station.■ Check for sources of possible interference.
Lines or streaks in pictures	<ul style="list-style-type: none">■ Check antenna (Change the direction of the antenna).

APPENDIX

The audio function does not work.

Picture OK & No sound	<ul style="list-style-type: none">■ Press the VOL or VOLUME button.■ Sound muted? Press MUTE button.■ Try another channel. The problem may be with the broadcast.■ Are the audio cables installed properly?
No output from one of the speakers	<ul style="list-style-type: none">■ Adjust Balance in menu option.
Unusual sound from inside the product	<ul style="list-style-type: none">■ A change in ambient humidity or temperature may result in an unusual noise when the product is turned on or off and does not indicate a fault with the product.

There is a problem in PC mode. (Only PC mode applied)

The signal is out of range	<ul style="list-style-type: none">■ Adjust resolution, horizontal frequency, or vertical frequency.■ Check the input source.
Vertical bar or stripe on background & Horizontal Noise & Incorrect position	<ul style="list-style-type: none">■ Work the Auto configure or adjust clock, phase, or H/V position. (Option)
Screen color is unstable or single color	<ul style="list-style-type: none">■ Check the signal cable.■ Reinstall the PC video card.

MAINTENANCE

Early malfunctions can be prevented. Careful and regular cleaning can extend the amount of time you can enjoy your new TV.

Caution: Be sure to turn the power off and unplug the power cord before you begin any cleaning.

Cleaning the Screen

- 1 Here's a great way to keep the dust off your screen for a while. Wet a soft cloth in a mixture of lukewarm water and a little fabric softener or dish washing detergent. Wring the cloth until it's almost dry, and then use it to wipe the screen.
- 2 Make sure the excess water is off the screen, and then let it air-dry before you turn on your TV.

Cleaning the Cabinet

- To remove dirt or dust, wipe the cabinet with a soft, dry, lint-free cloth.
- Please be sure not to use a wet cloth.

Extended Absence

CAUTION

- ▶ If you expect to leave your TV dormant for a long time (such as a vacation), it's a good idea to unplug the power cord to protect against possible damage from lightning or power surges.

APPENDIX

PRODUCT SPECIFICATIONS

- The specifications shown above may be changed without prior notice for quality improvement.

MODELS		15LS1RA (15LS1RA-MK)	20LS1RA (20LS1RA-MK)
Dimensions (Width x Height x Depth)	Including stand	18.2 x 13.9 x 6.5 inches 463.3 x 353.5 x 166.3mm	22.6 x 17.1 x 7.5 inches 573.2 x 435.5 x 189.7 mm
	Excluding stand	18.2 x 12.6 x 2.7 inches 463.3 x 320.6 x 69.3mm	22.6 x 16.1 x 2.9 inches 573.2 x 408.2 x 73.7 mm
Weight	including stand	8.7 pounds / 3.94 kg	15.2 pounds / 6.9 kg
	excluding stand	7.9 pounds / 3.58 kg	14.3 pounds / 6.48 kg
Power Consumption		40 W	60 W
Power Requirement		AC100-240V ~ 50/60Hz	
Television System		NTSC, PAL-M/N	
Program Coverage		VHF 2-13, UHF 14-69, CATV 1-125	
External Antenna Impedance		75 ohm	
Environment condition	Operating Temperature	32 ~ 104°F (0 ~ 40°C)	
	Operating Humidity	Less than 80%	
	Storage Temperature	-4 ~ 140°F (-20 ~ 60°C)	
	Storage Humidity	Less than 85%	

LG Electronics Inc.