



LCD TV OWNER'S MANUAL

LCD TV MODELS

19LS4R*

22LS4R*

17LS5R*

20LS5R*

Please read this manual carefully before operating your set.
Retain it for future reference.

Record model number and serial number of the set.
See the label attached on the back cover and quote
this information to your dealer when you require service.

ACCESSORIES

Ensure that the following accessories are included with your TV. If any accessory is missing, please contact the dealer where you purchased the product.

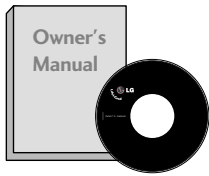

Owner's Manual



Batteries

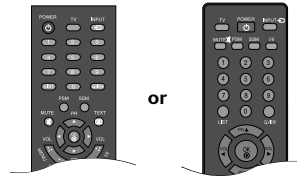

Remote Control



Power Cord



Cable Management

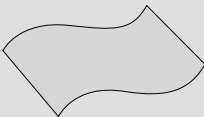

Polishing Cloth
Polish the screen with the cloth
This feature is not available
for all models.

*Slightly wipe stained spot on the exterior only with the cleansing cloths for the product exterior if there is stain or fingerprint on surface of the exterior.

Do not wipe roughly when removing stain. Please be cautious of that excessive power may cause scratch or discoloration.

CONTENTS

ACCESSORIES 1

PREPARATION

Front Panel Controls 4
Back Panel Information 6
Stand Installation 9
Detaching stand 10
Back Cover for Wire Arrangement 11
Wall Mount: Horizontal installation 12
Desktop Pedestal Installation 12
Positioning your display 13
Location 13
Kensington Security System 14
Antenna Connection 15

EXTERNAL EQUIPMENT SETUP

HD Receiver Setup 16
DVD Setup 18
VCR Setup 20
Headphone SETUP 23
PC Setup 24
Screen Setup for PC Mode 27

WATCHING TV / PROGRAMME CONTROL

Remote Control Key Functions 28
Turning on the TV 30
Programme Selection 30
Volume Adjustment 30
On Screen Menus Selection and Adjustment 31
Auto Programme Tuning 32
Manual Programme Tuning 33
Fine Tuning 34
Assigning a Station Name 35
Programme Edit 36
Favourite Programme 37
Calling the Programme Table 38
Child lock 39

PICTURE CONTROL

Picture Size (Aspect Ratio) Control 40
Preset Picture Settings
- Picture Mode-Preset 42
- Auto Color Tone Control(Warm/Normal/Cool) 43
Manual Picture Adjustment
- Picture Mode-User Option 44
- Color Tone - User Option 45
XD - Picture Improvement Technology 46
XD Demo 47
Cinema 48
Picture Reset 49

SOUND & LANGUAGE CONTROL

Auto Volume Leveler 50
Preset Sound Settings - Sound Mode 51
Sound Setting Adjustment - User Mode 52
Balance 53
I/II
- Stereo/Dual Reception 54
- NICAM Reception 55
- Speaker Sound Output Selection 55
ON-SCREEN MENU LANGUAGE SELECTION 56

TIME SETTING

| | |
|--------------------------------|----|
| Clock Setup..... | 57 |
| Auto On/Off Timer Setting..... | 58 |
| Sleep Timer Setting..... | 59 |
| Auto Shut-off Setting..... | 60 |

TELETEXT

| | |
|---------------------------------|----|
| Switch On/Off | 61 |
| SIMPLE Text | 61 |
| TOP Text | 62 |
| FASTEXT | 62 |
| Special Teletext Functions..... | 63 |

APPENDIX

| | |
|------------------------------|----|
| Troubleshooting..... | 64 |
| Maintenance | 66 |
| Product Specifications | 67 |

PREPARATION

FRONT PANEL CONTROLS

- This is a simplified representation of the front panel. Here shown may be somewhat different from your TV.
- If your product has a protection film attached, remove the film and then wipe the product with a polishing cloth.

17LS5R* / 20LS5R*

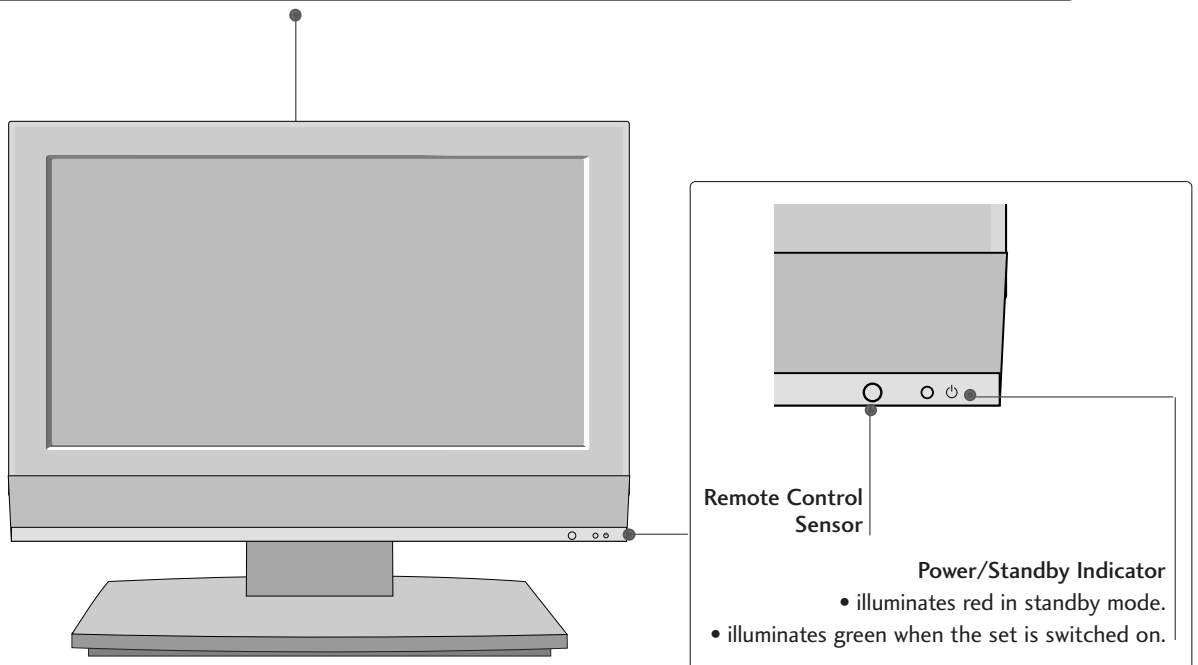
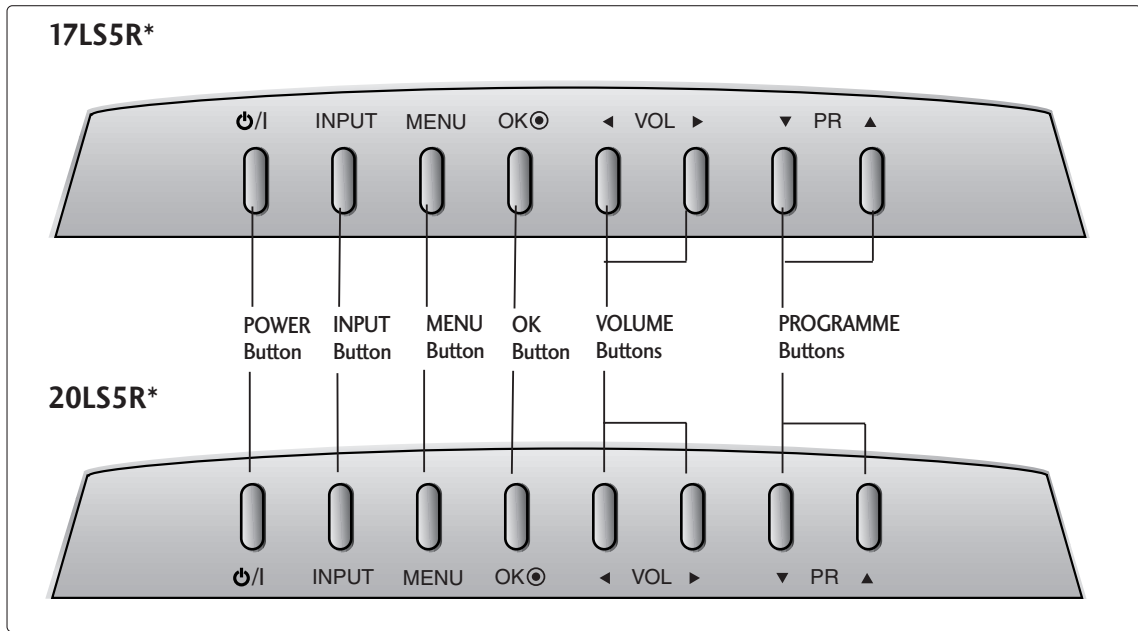

19LS4R*/ 22LS4R*

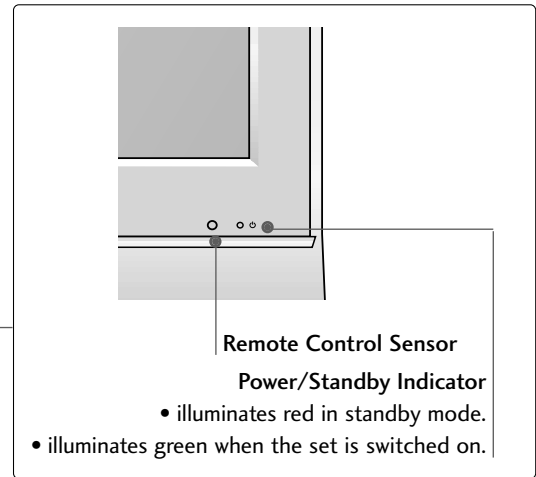
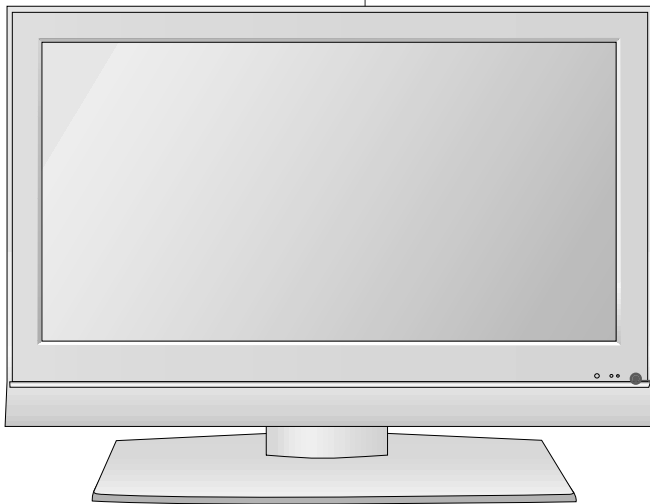
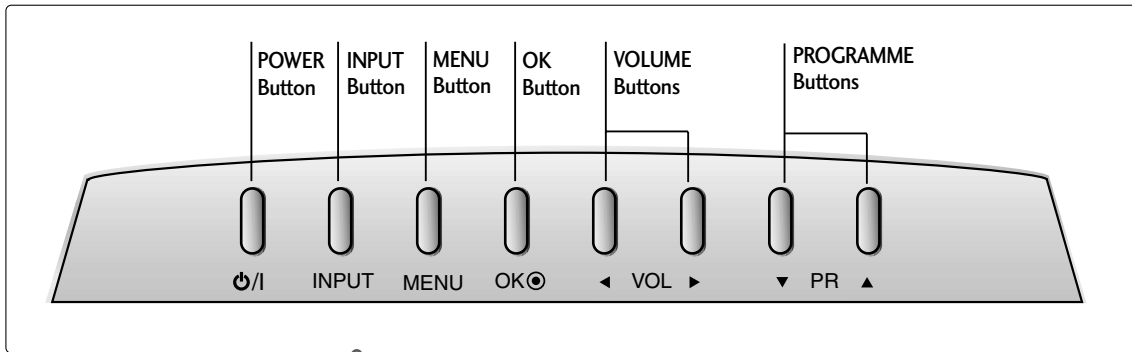

PREPARATION

BACK PANEL INFORMATION

- This is a simplified representation of the back panel. Here shown may be somewhat different from your TV.

17LS5R*

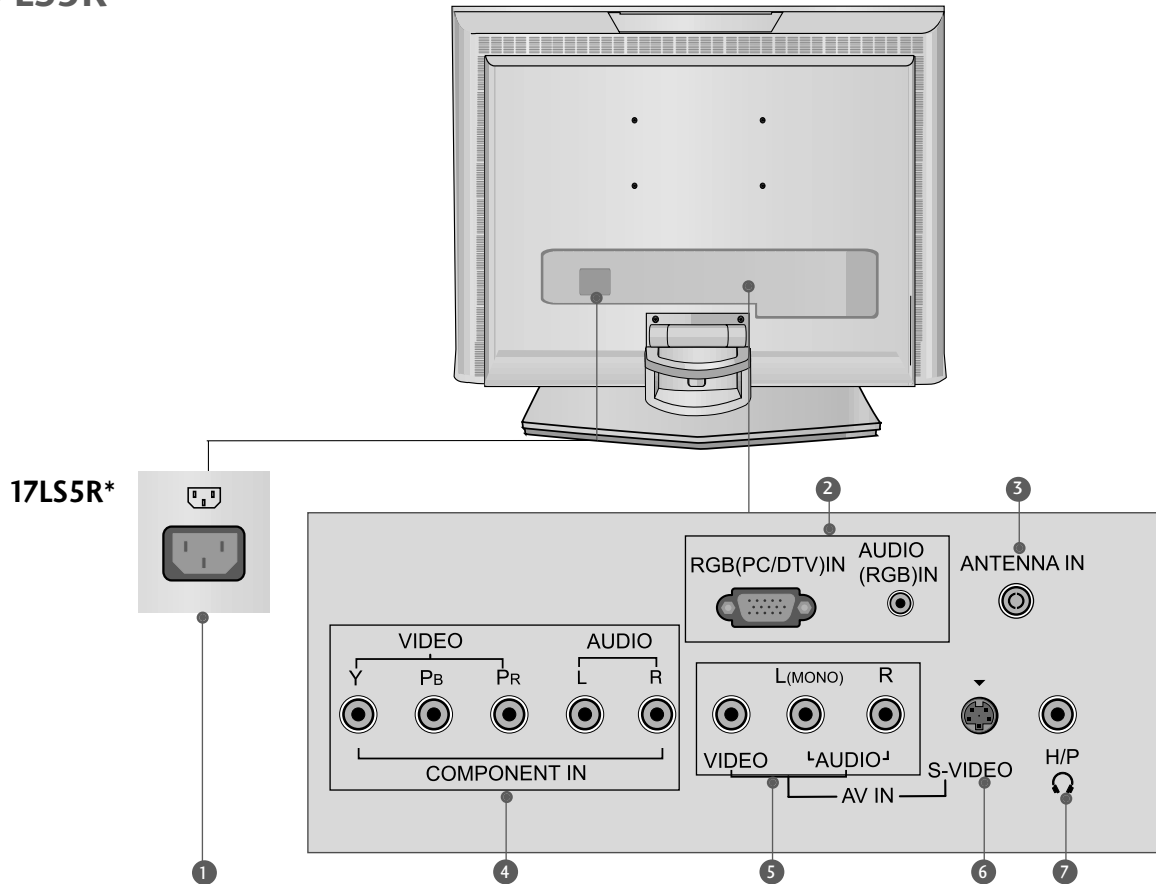

- 1 Power Cord Socket**
This TV operates on an AC power. The voltage is indicated on the Specifications page. Never attempt to operate the TV on DC power.
- 2 RGB/Audio Input**
Connect the monitor output from a PC/DTV to the appropriate input port.
- 3 Antenna Input**
Connect over-the-air signals to this jack.
- 4 Component Input**
Connect a component video/audio device to these jacks.
- 5 Audio/Video Input**
Connect audio/video output from an external device to these jacks.
- 6 S-Video Input**
Connect S-Video out from an S-VIDEO device.
- 7 Headphone Input**

20LS5R*

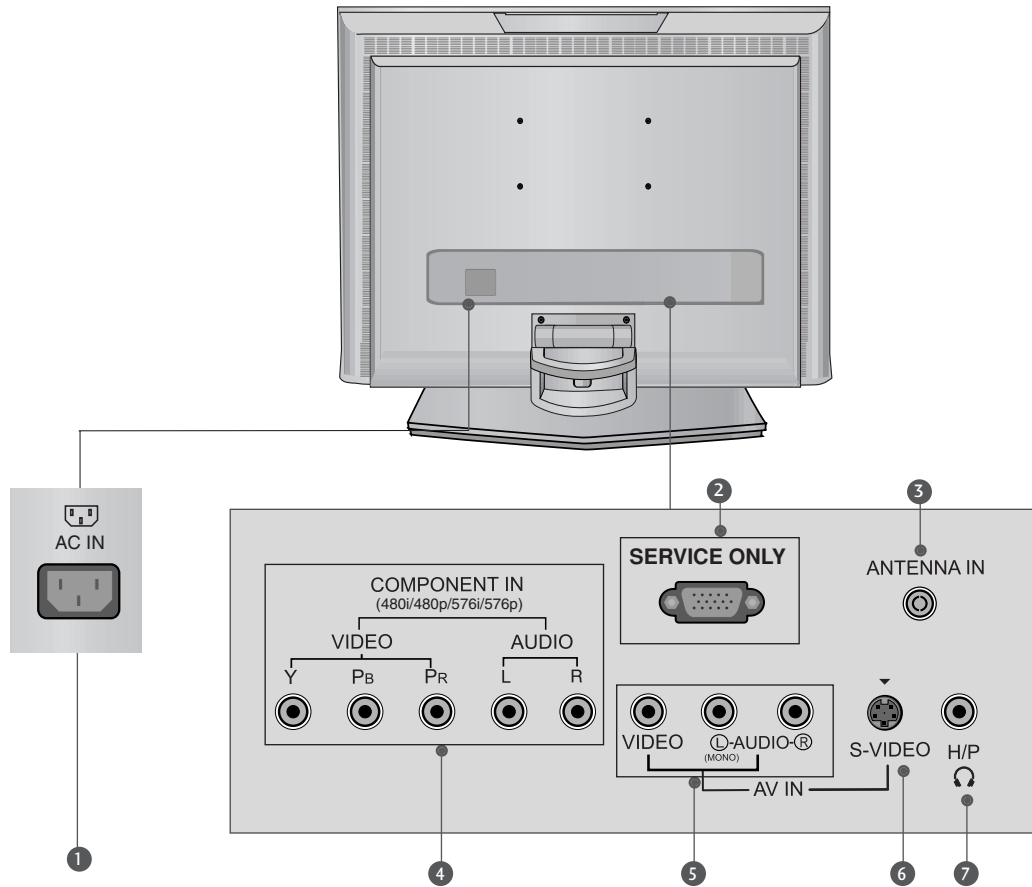

1 Power Cord Socket

This TV operates on an AC power. The voltage is indicated on the Specifications page. Never attempt to operate the TV on DC power.

2 SERVICE ONLY

3 Antenna Input

Connect over-the-air signals to this jack.

4 Component Input

Connect a component video/audio device to these jacks.

5 Audio/Video Input

Connect audio/video output from an external device to these jacks.

6 S-Video Input

Connect S-Video out from an S-VIDEO device.

7 Headphone Input

PREPARATION

BACK PANEL INFORMATION

19LS4R* / 22LS4R*

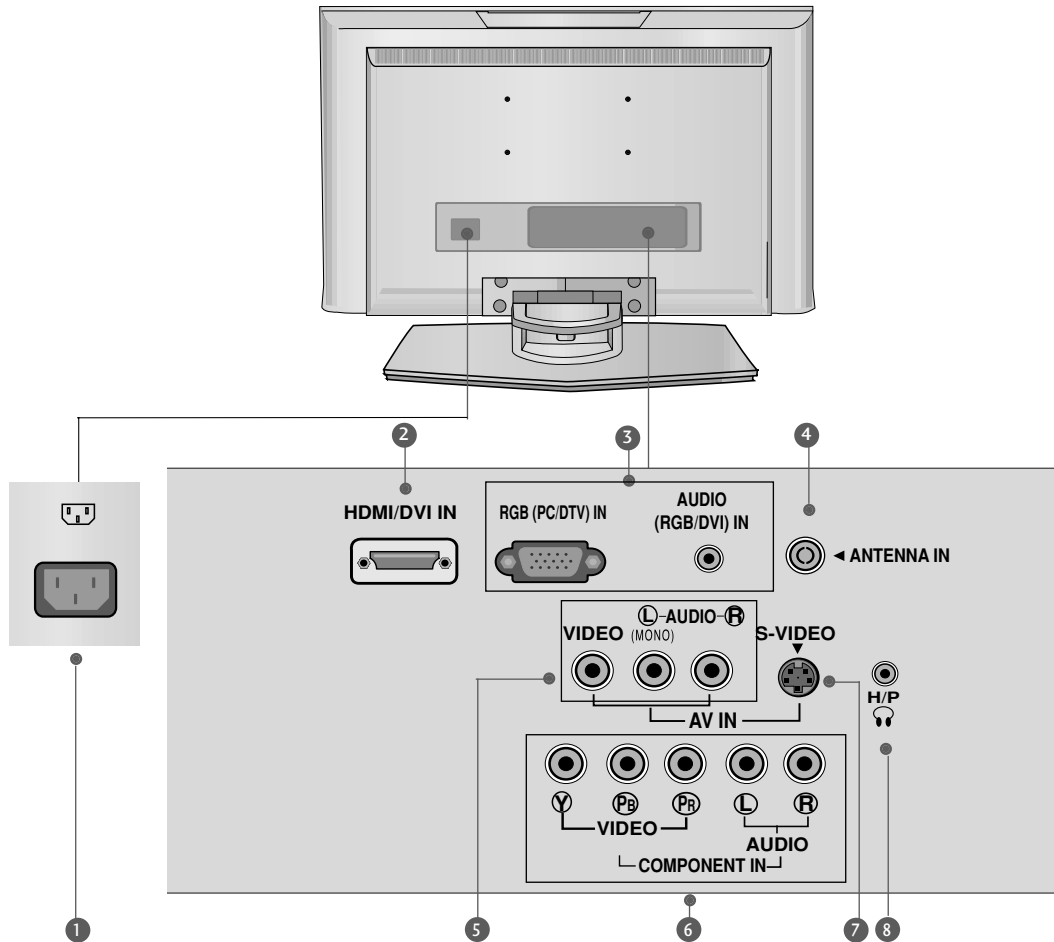

1 Power Cord Socket

This TV operates on an AC power. The voltage is indicated on the Specifications page. Never attempt to operate the TV on DC power.

2 HDMI/DVI IN Input

Connect a HDMI signal to HDMI IN.
Or DVI(VIDEO) signal to HDMI/DVI port with DVI to HDMI cable.

3 RGB/Audio Input

Connect the monitor output from a PC/DTV to the appropriate input port.

4 Antenna Input

Connect over-the-air signals to this jack.

5 Audio/Video Input

Connect audio/video output from an external device to these jacks.

6 Component Input

Connect a component video/audio device to these jacks.

7 S-Video Input

Connect S-Video out from an S-VIDEO device.

8 Headphone Input

STAND INSTALLATION

■ Here shown may be somewhat different from your TV.

17/20LS5R*

- 1 Carefully place the product screen side down on a cushioned surface that will protect product and screen from damage.

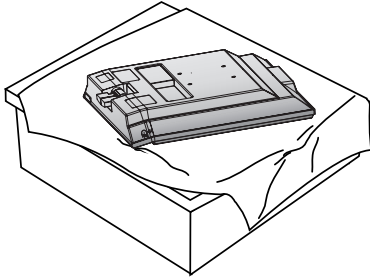

- 2 Assemble parts of stand body with the product of the stand. Insert stand body into the product until clicking sound.

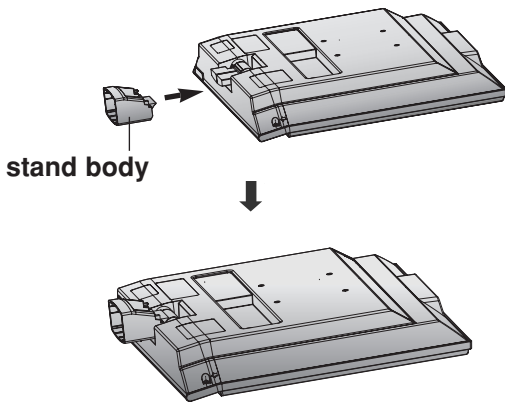

- 3 Place the product stand on the product as shown.

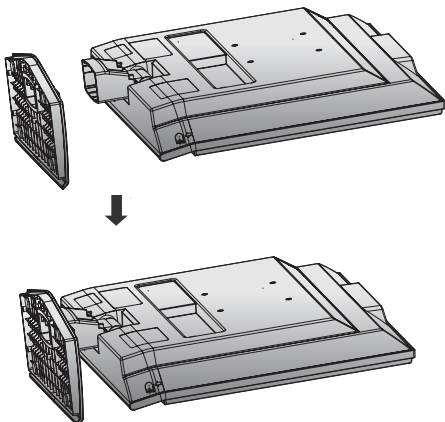

19/22LS4R*

- 1 Carefully place the product screen side down on a cushioned surface that will protect product and screen from damage.

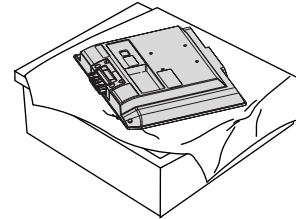

- 2 Hold the **hinge body** and bend it upward.

Hinge Body

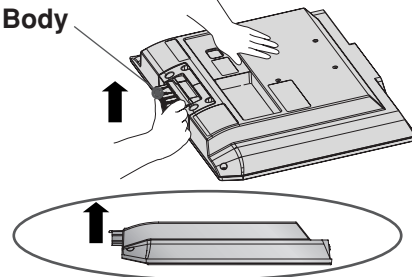

- 3 Insert the **stand body** into the product until clicking sound.

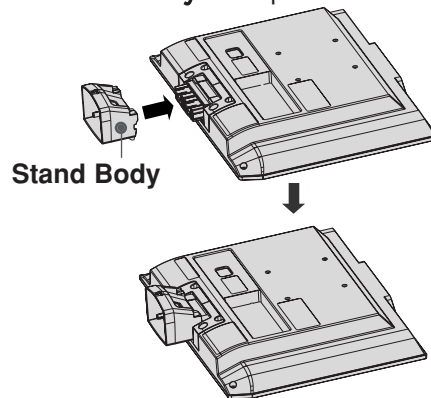

- 4 Assemble the parts of the **stand body** with **cover base** of the product.

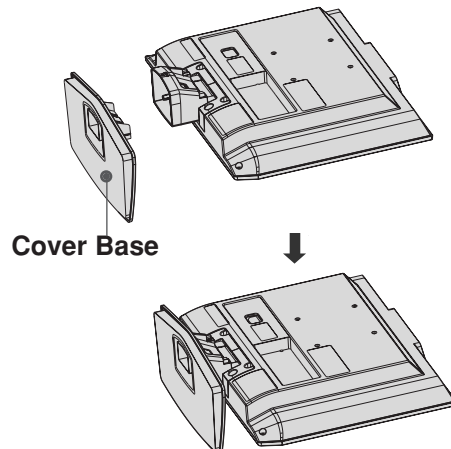

PREPARATION

DETACHING STAND

▪ Here shown may be somewhat different from your TV.

1 Place the set with its front facing downward on a cushion or soft cloth.

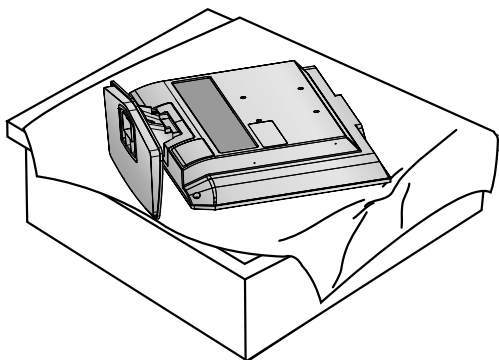

2 Pull cover base backward during pressing button on stand body.

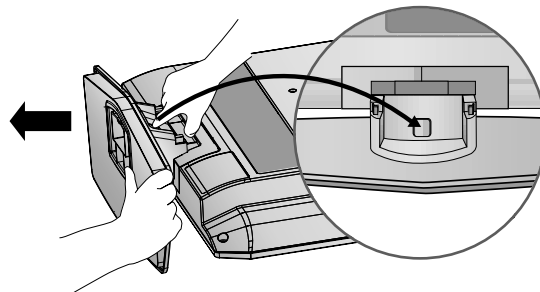

3 Hold cover base and pull with shake it backward to separate from stand body.

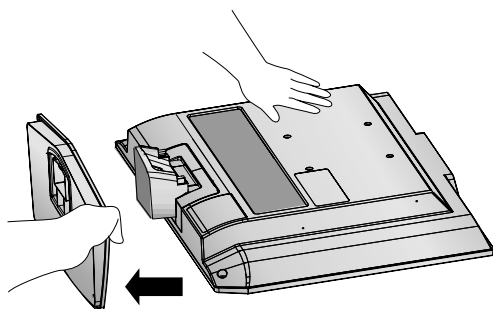

4 Hold the stand and bend it upward.

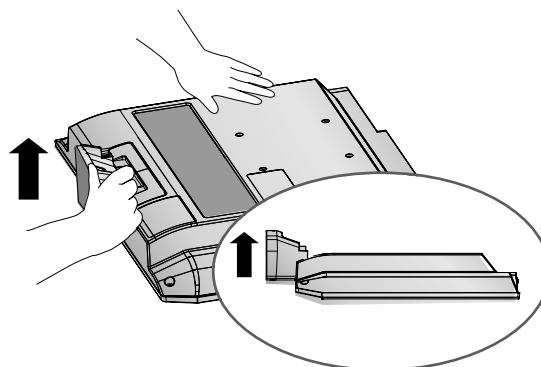

5 Pull stand body to separate from set during pressing 2 latches.

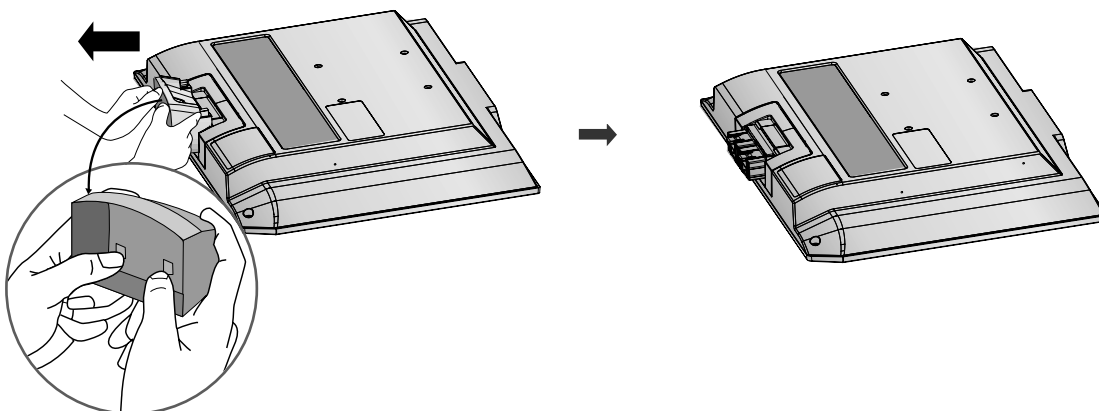

BACK COVER FOR WIRE ARRANGEMENT

▪ Here shown may be somewhat different from your TV.

1 Connect the cables as necessary.

To connect an additional equipment, see the **External equipment Setup** section.

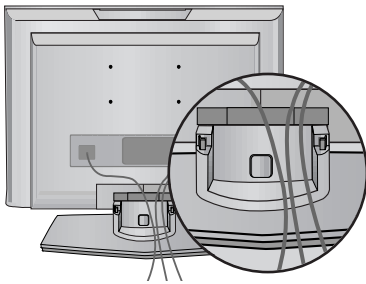

2 Install the **CABLE MANAGEMENT** as shown.

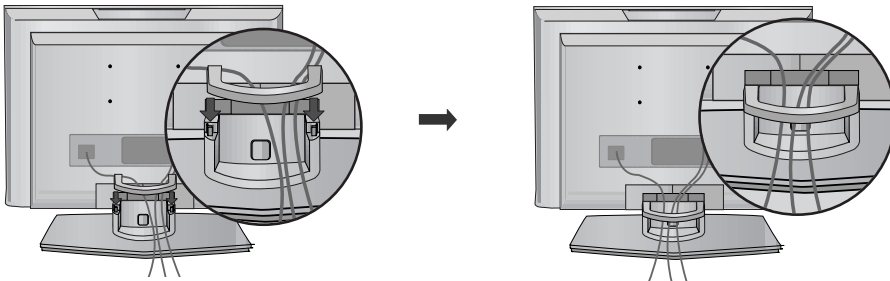

How to remove the cable management

First, press the cable management. Hold the **CABLE MANAGEMENT** with both hands and pull it upward.

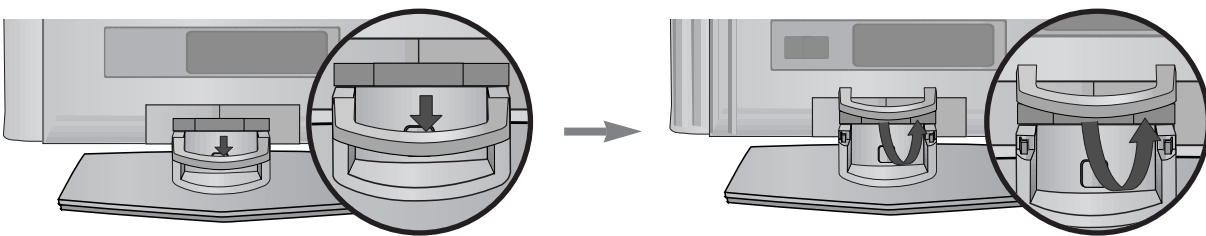

! NOTE

- ▶ Do not hold the **CABLE MANAGEMENT** when moving the product.
- If the product is dropped, you may be injured or the product may be broken.

PREPARATION

PREPARATION

WALL MOUNT: HORIZONTAL INSTALLATION

For proper ventilation, allow a clearance of 4" on each side and from the wall. Detailed installation instructions are available from your dealer, see the optional Tilt Wall Mounting Bracket Installation and Setup Guide.

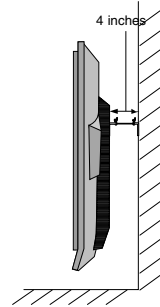
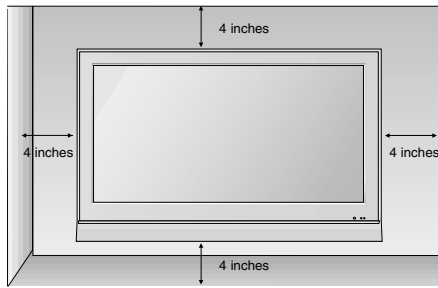
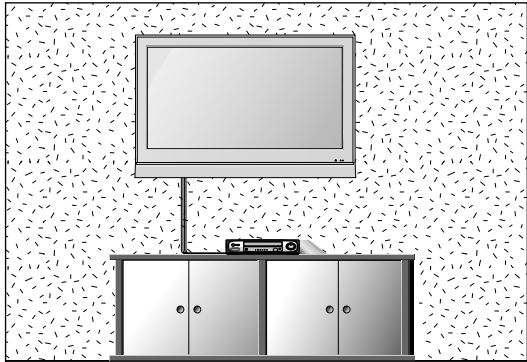

DESKTOP PEDESTAL INSTALLATION

For proper ventilation, allow a clearance of 4 inches on each side from the wall.

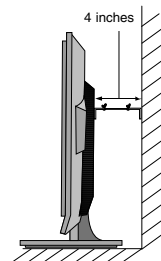
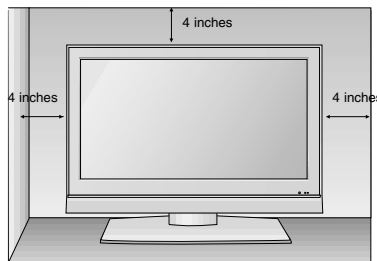
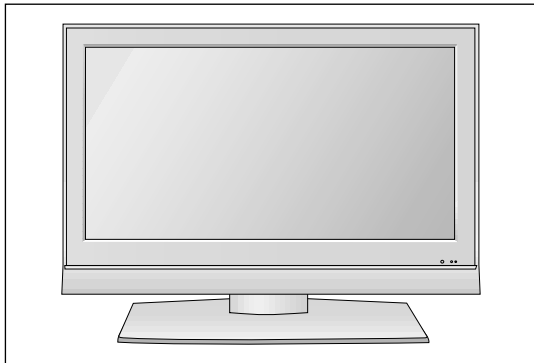

POSITIONING YOUR DISPLAY

- Here shown may be somewhat different from your TV.

Adjust the position of the panel in various ways for maximum comfort.

- **Tilt range**

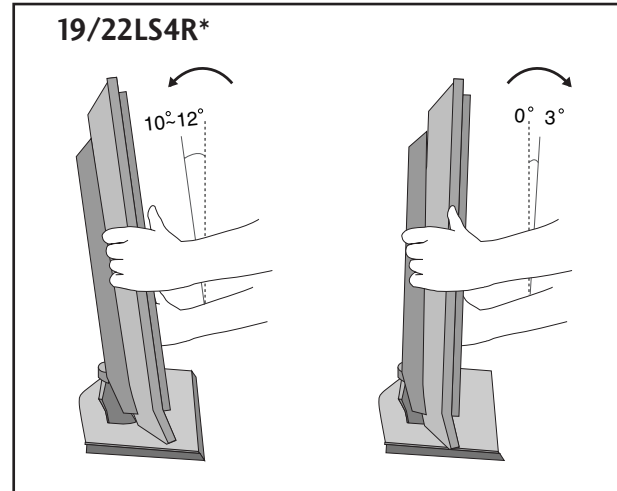
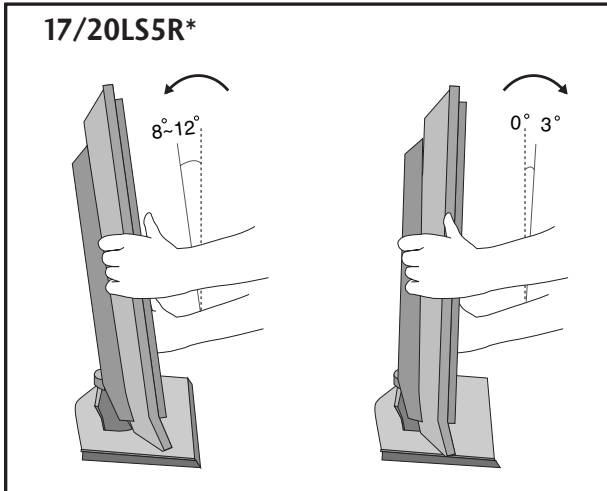

LOCATION

Position your set so that no bright light or sunlight falls directly onto the screen. Care should be taken not to expose the set to any unnecessary vibration, moisture, dust or heat. Also ensure that the set is placed in a position to allow a free flow of air. Do not cover the ventilation openings on the back cover. If you intend to mount the TV to a wall, attach VESA standard mounting interface (optional parts) to the back of the TV.

When you install the set to use the wall mounting bracket (optional parts), fix it carefully so as not to drop.

PREPARATION

KENSINGTON SECURITY SYSTEM

- The TV is equipped with a Kensington Security System connector on the back panel. Connect the Kensington Security System cable as shown below.
- For the detailed installation and use of the Kensington Security System, refer to the user's guide provided with the Kensington Security System.

For further information, contact <http://www.kensington.com>, the internet homepage of the Kensington company. Kensington sells security systems for expensive electronic equipment such as notebook PCs and LCD projectors.

NOTE

- The Kensington Security System is an optional accessory.

NOTES

- If the TV feels cold to the touch, there may be a small "flicker" when when it is turned on. This is normal, there is nothing wrong with TV.
- Some minute dot defects may be visible on the screen, appearing as tiny red, green, or blue spots. However, they have no adverse effect on the monitor's performance.
- Avoid touching the LCD screen or holding your finger(s) against it for long periods of time. Doing so may produce some temporary distortion effects on the screen.

17LS5R*

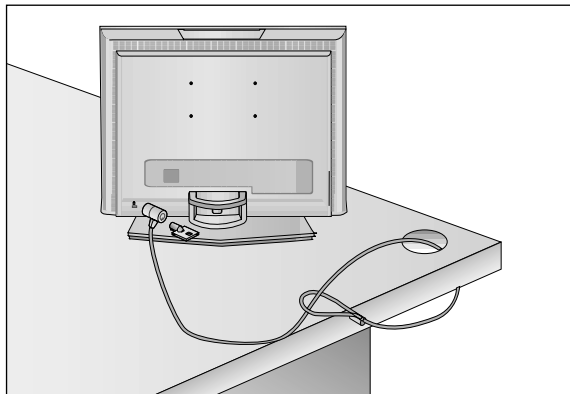

19/22LS4R*

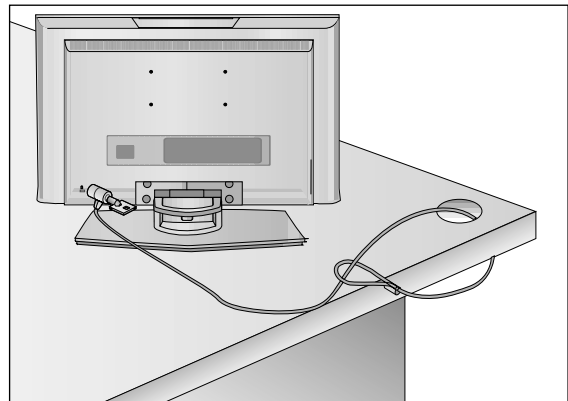

20LS5R*

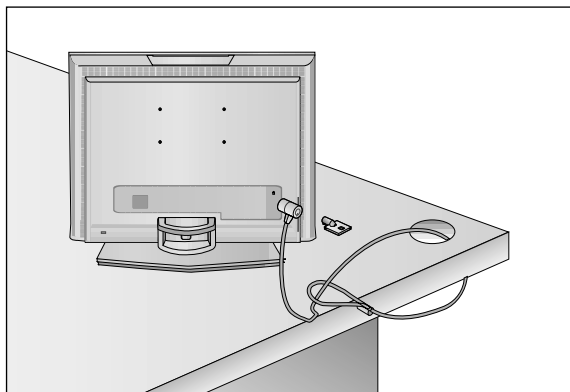

- To prevent the equipment damage, never plug in any power cords until you have finished connecting all equipment.

ANTENNA CONNECTION

- For optimum picture quality, adjust antenna direction.
- An antenna cable and converter are not supplied.

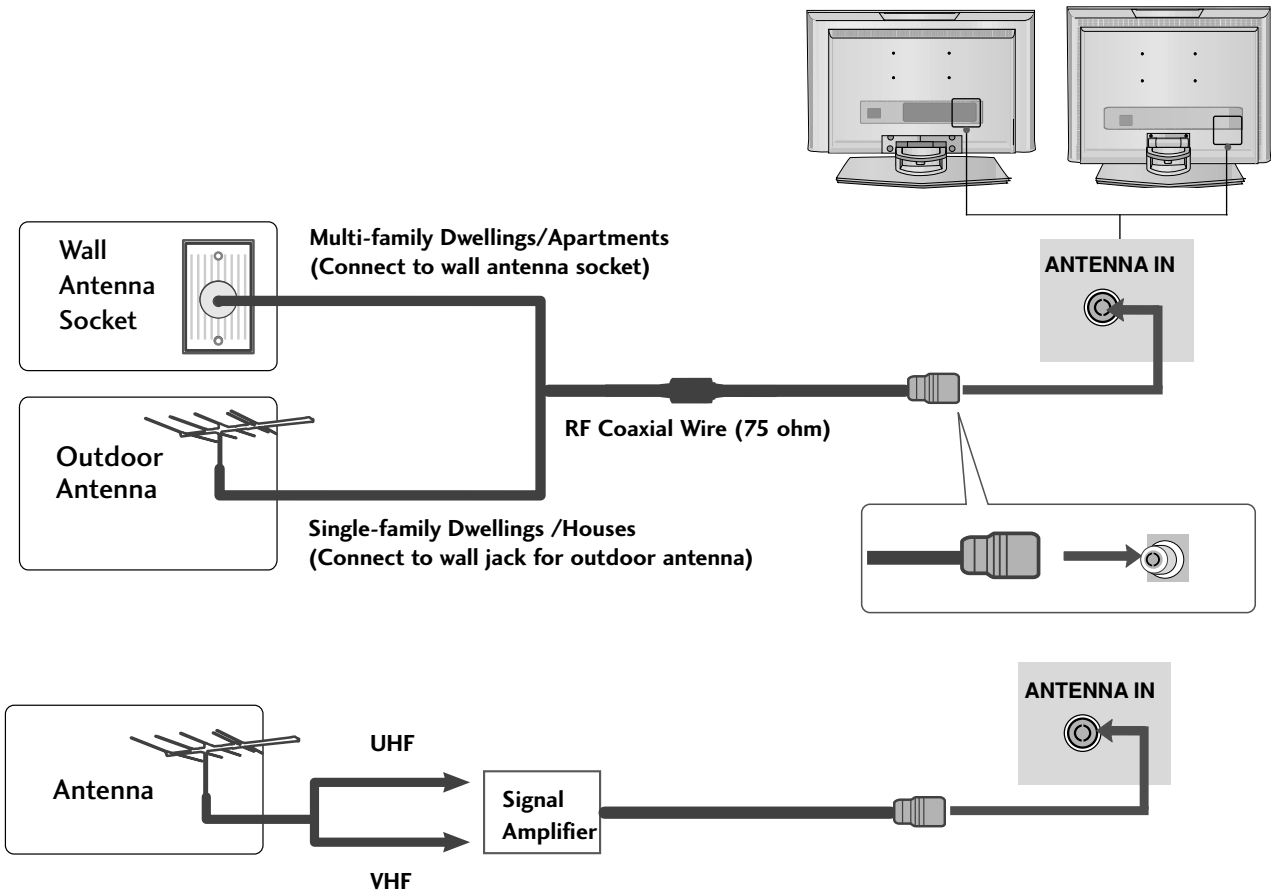

- In poor signal areas, to get better picture quality, install a signal amplifier to the antenna as shown above.
- If signal needs to be split for two TVs, use an antenna signal splitter for connection.

EXTERNAL EQUIPMENT SETUP

- To prevent the equipment damage, never plug in any power cords until you have finished connecting all equipment.
- Here shown may be somewhat different from your TV.

HD RECEIVER SETUP

When connecting with a component cable

- 1 Connect the SET TOP outputs to the **COMPONENT IN VIDEO** sockets (Y Pb Pr) on the set.
- 2 Connect the audio cable from the SET TOP to **COMPONENT IN AUDIO** sockets of the set.
- 3 Press the **INPUT** button to select **Component**.
(19/22LS4R* /17LS5R* :480i/576i/480p/576p/720p/1080i)
(20LS5R*:480i/480p/576i/576p)

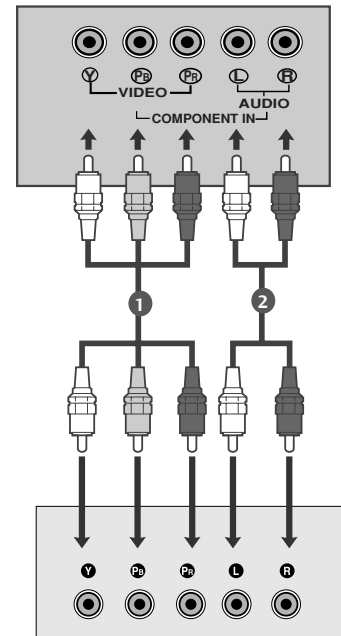

When connecting with a D-sub 15 pin cable

17LS5R*

- 1 Connect the SET TOP with the D-Sub output socket to **RGB (PC/DTV) IN** socket on the set and audio cable of the SET TOP to the **AUDIO (RGB) IN**.
- 2 Press the **INPUT** button to select **RGB (DTV)**.

19/22LS4R*

- 1 Connect the SET TOP with the D-Sub output socket to **RGB (PC/DTV) IN** socket on the set and audio cable of the SET TOP to the **AUDIO (RGB/DVI) IN**.
- 2 Press the **INPUT** button to select **RGB (DTV)**.

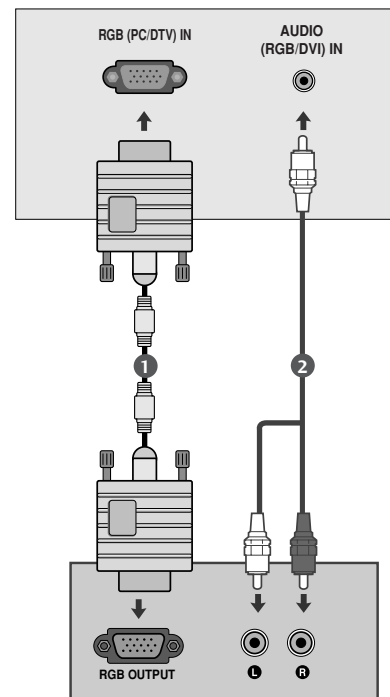

When connecting with a HDMI(Only 19/22LS4R*)

- 1 Connect the HDMI output of the digital set-top box to the **HDMI/DVI IN** jack on the set.
.....
- 2 Select **HDMI/DVI** (DTV) input source with using the **INPUT** button on the remote control.

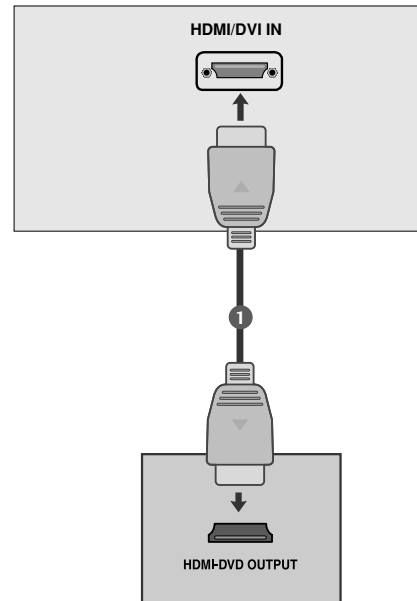

EXTERNAL EQUIPMENT SETUP

DVD SETUP

When connecting with a component cable

- 1 Connect the video output sockets (Y Cb Cr, Y Pb Pr, Y B-Y R-Y or Y Pb Pr) of the DVD to the **COMPONENT IN VIDEO** sockets (Y Pb Pr) of the set.
- 2 Connect the audio cable from the DVD to **COMPONENT IN AUDIO** sockets of the set.
- 3 Press the **INPUT** button to select **Component**.
(19/22LS4R* /17LS5R* :480i/576i/480p/576p/720p/1080i)
(20LS5R*:480i/480p)
- 4 Press the **PLAY** button on the DVD.
The DVD playback picture appears on the screen.

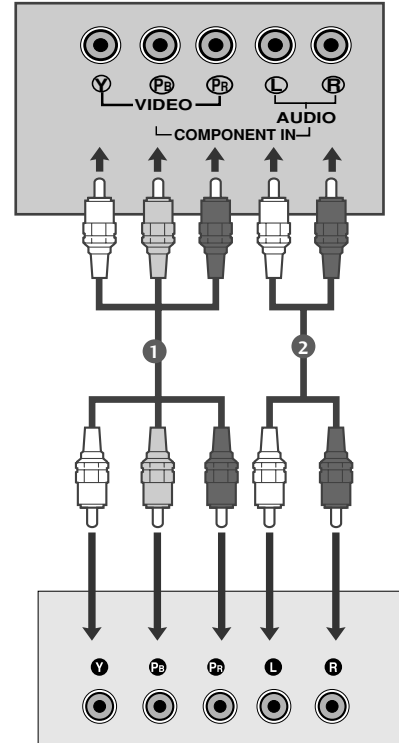

Component Input ports

To get better picture quality, connect a DVD player to the component input ports as shown below.

| Component ports on the TV | Y | P _B | P _R |
|-------------------------------------|---|----------------|----------------|
| Video output ports on DVD player | Y | P _B | P _R |
| | Y | B-Y | R-Y |
| | Y | C _b | C _r |
| | Y | P _b | P _r |

When connecting HDMI cable(Only 19/22LS4R*)

- 1 Connect the HDMI output of the DVD to the **HDMI/DVI IN** jack on the set.
- 2 Select **HDMI/DVI (DTV)** input source with using the **INPUT** button on the remote control.

! NOTE

- ▶ TV can receive the video and audio signal simultaneously with using a HDMI cable.
- ▶ If the DVD supports Auto HDMI function, the output resolution of the source device will be automatically set to 1280x720p.
- ▶ If the DVD player does not support Auto HDMI, you need to set the DVD output resolution appropriately.
To get the best picture quality, adjust the output resolution of the source device to 1280x720p.

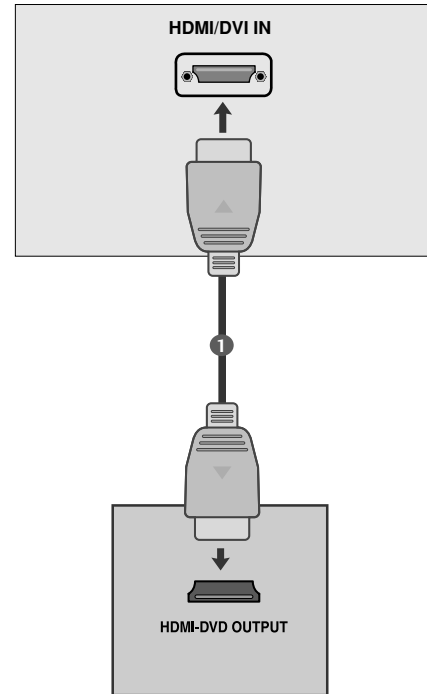

EXTERNAL EQUIPMENT SETUP

VCR SETUP

- To avoid picture noise (interference), leave an adequate distance between the VCR and TV.
- Typically a frozen still picture from a VCR. If the 4:3 picture format is used; the fixed images on the sides of the screen may remain visible on the screen.

When connecting with an antenna

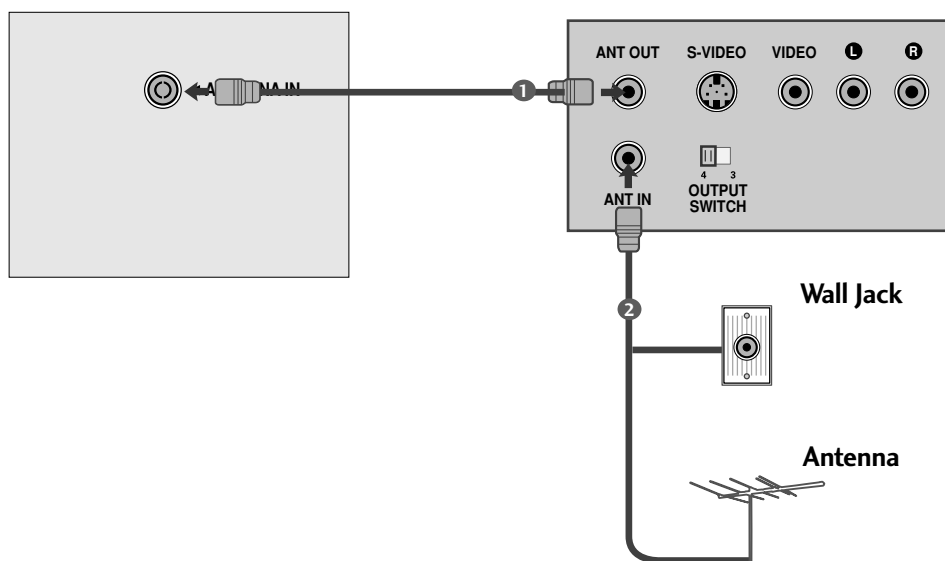

- 1 Connect the RF out socket of the VCR to the aerial socket of the set.
- 2 Connect the aerial cable to the RF aerial in socket of the VCR.
- 3 Store the VCR channel on a desired programme number using the 'Manual programme tuning' section.
- 4 Select the programme number where the VCR channel is stored.
- 5 Press the **PLAY** button on the VCR.

VCR SETUP

When connecting with a RCA cable

- 1 Connect the audio/video out sockets of the VCR to AUDIO/VIDEO in sockets of the set.
.....
- 2 Press the INPUT button to select **AV**.
.....
- 3 Press the PLAY button on the VCR.
The VCR playback picture appears on the screen.

! NOTE

- ▶ If you have a mono VCR, connect the audio cable from the VCR to the **AUDIO L/MONO** jack of the set.

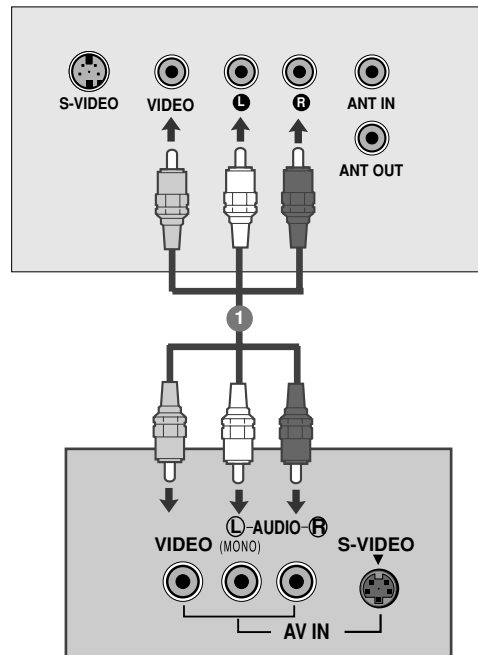

EXTERNAL EQUIPMENT SETUP

VCR SETUP

When connecting with an S-Video cable

- 1 Connect the S-Video socket of the VCR to the S-VIDEO socket of the set.
- 2 Connect the audio cable from the S-VIDEO VCR to the AUDIO sockets of the set.
- 3 Press the INPUT button to select **AV**.
- 4 Press the PLAY button on the VCR.
The VCR playback picture appears on the screen.

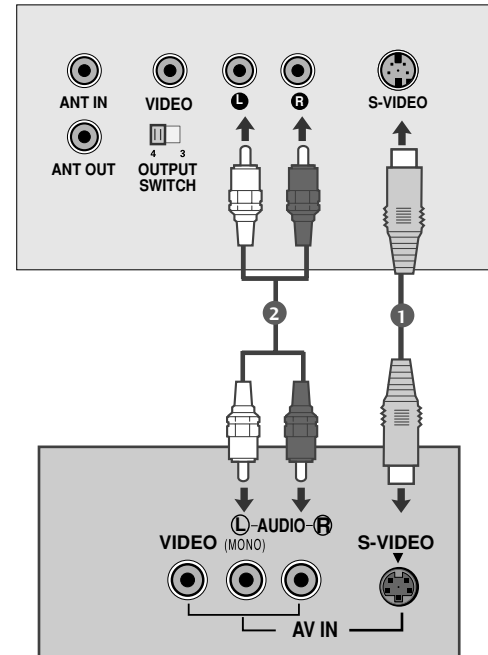

HEADPHONE SETUP

When connecting with a Headphone cable

-
- 1 Insert the headphone plug to the headphone socket of the set. You can listen to the sound through the headphone. To adjust the head-phone volume, press the ◀ / ▶ button. If you press the MUTE button, the sound from the head-phone is switched off.
-

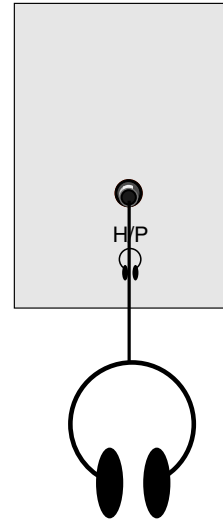

EXTERNAL EQUIPMENT SETUP

PC SETUP

This TV provides Plug and Play capability, meaning that the PC adjusts automatically to the TV's settings.

When connecting with a D-sub 15 pin cable

17LS5R*

- 1 Connect the signal cable from the monitor output socket of the PERSONAL COMPUTER to the PC input socket of the set.
- 2 Connect the audio cable from the PC to the **AUDIO (RGB) IN** sock-ets of the set.
- 3 Press the INPUT button to select **RGB (PC)**.
- 4 Switch on the PC, and the PC screen appears on the set. The set can be operated as the PC monitor.

19/22LS4R*

- 1 Connect the signal cable from the monitor output socket of the PERSONAL COMPUTER to the PC input socket of the set.
- 2 Connect the audio cable from the PC to the **AUDIO (RGB/DVI) IN** sock-ets of the set.
- 3 Press the INPUT button to select **RGB (PC)**.
- 4 Switch on the PC, and the PC screen appears on the set. The set can be operated as the PC monitor.

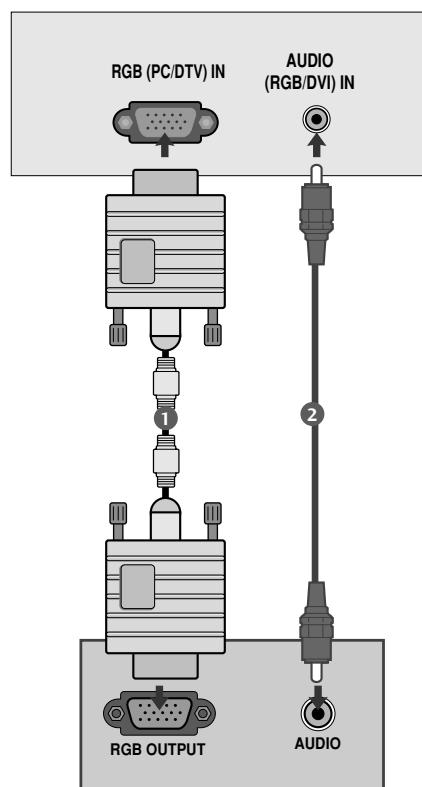

When connecting with a HDMI to DVI cable(Only 19/22LS4R*)

- 1 Connect the DVI output of the PC to the **HDMI/DVI IN** jack on the set.
- 2 Connect the audio cable from the PC to the **AUDIO (RGB/DVI) IN** sockets of the set.
- 3 Select **HDMI/DVI (PC)** input source with using the **INPUT** button on the remote control.

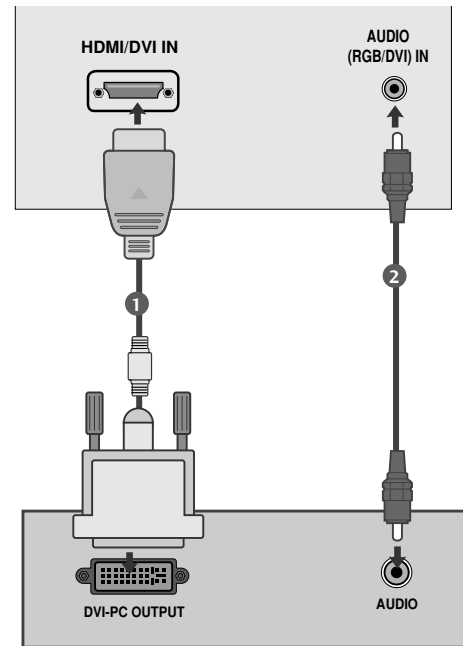

! NOTE

- ▶ If the set is cold, there may be a small “flicker” when the set is switched on. This is normal, there is nothing wrong with the set.
- ▶ If possible, use the VESA 1280x1024@60Hz (17LS5R *), 1440x900@60Hz (19LS4R *), 1680x1050@60Hz (22LS4R *) video mode to obtain the best image quality for your LCD monitor. If used under the other resolutions, some scaled or processed pictures may appear on the screen. The set has been preadjusted to the mode VESA 1280x1024@60Hz (17LS5R *), 1440x900@60Hz (19LS4R *), 1680x1050@60Hz (22LS4R *).
- ▶ Some dot defects may appear on the screen, like Red, Green or Blue spots. However, this will have no impact or effect on the monitor performance.
- ▶ Do not press the LCD screen with your finger for a long time as this may produce some temporary distortion effects on the screen.
- ▶ When the PC screen appears on the set, a message may appear on the screen, and the message will differ according to the Window system version. If a message appears click “Next” until the message finishes.
- ▶ If the message “No signal” appears on the screen, adjust the PC as in the ‘Displayable Monitor Specification’ section.

EXTERNAL EQUIPMENT SETUP

Supported Display Resolution

<17LS5R*>

RGB-PC mode

| Resolution | Horizontal Frequency(kHz) | Vertical Frequency(Hz) |
|------------|---------------------------|------------------------|
| 640x480 | 31.469 | 59.94 |
| 800x600 | 37.879 | 60.31 |
| 1024x768 | 48.363 | 60.00 |
| 1280x1024 | 63.981 | 60.02 |

RGB-DTV mode

| Resolution | Horizontal Frequency(kHz) | Vertical Frequency(Hz) |
|------------|---------------------------|------------------------|
| 720x480p | 31.47 | 59.94 |
| | 31.50 | 60.00 |
| 720x576p | 31.25 | 50.00 |
| 1280x720p | 37.50 | 50.00 |
| | 44.96 | 59.94 |
| | 45.00 | 60.00 |
| 1920x1080i | 33.72 | 59.94 |
| | 33.75 | 60.00 |
| | 28.125 | 50.00 |

<19LS4R*, 22LS4R*>

RGB-PC, HDMI/DVI-PC mode

| Resolution | Horizontal Frequency(kHz) | Vertical Frequency(Hz) |
|------------|---------------------------|------------------------|
| 640x480 | 31.469 | 59.94 |
| 800x600 | 37.879 | 60.31 |
| 1024x768 | 48.363 | 60.00 |
| 1280x1024 | 63.981 | 60.02 |
| 1440x900 | 55.50 | 59.90 |
| 1680x1050 | 65.290 | 59.954 |

▶ Only 19LS4R* (for 1440x900)

▶ Only 22LS4R* (for 1680x1050)

RGB-DTV, HDMI/DVI-DTV mode

| Resolution | Horizontal Frequency(kHz) | Vertical Frequency(Hz) |
|------------|---------------------------|------------------------|
| 720x480p | 31.47 | 59.94 |
| | 31.50 | 60.00 |
| 720x576p | 31.25 | 50.00 |
| 1280x720p | 37.50 | 50.00 |
| | 44.96 | 59.94 |
| | 45.00 | 60.00 |
| 1920x1080i | 33.72 | 59.94 |
| | 33.75 | 60.00 |
| | 28.125 | 50.00 |

SCREEN SETUP FOR PC MODE

PC Setup (RGB [PC] mode only) (only 17LS5R*/19LS4R*/22LS4R*)

You can adjust auto configure, manual configure and reset as you prefer.

Auto configure

This function is for the automatic adjustment of the screen position, clock, and phase. The displayed image will unstable for a few seconds while the auto configuration is in progress.

Manual configure

This function is for the manual adjustment of the screen position, clock and phase. Press the ◀ / ▶ button to make appropriate adjustments.

• H-Position / V-Position

This function is to adjust picture to left/right and up/down as you prefer.

• Clock

This function is to minimize any vertical bars or stripes visible on the screen background. And the horizontal screen size will also change.

• Phase

This function allows you to remove any horizontal noise and clear or sharpen the image of characters.

Reset

This function allows you to return to the good picture reproduction programmed at the factory and cannot be changed.

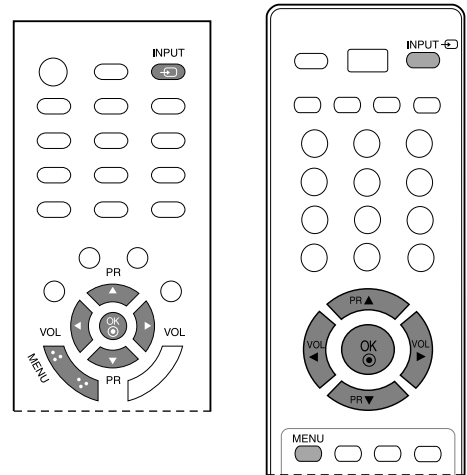

2

- 1 Press the **INPUT** button and then ▲ / ▼ button to select the **RGB**.
- 2 Press the **MENU** button and then ▲ / ▼ button to select the **Screen** menu.
- 3 Press the ▶ button and then ▲ / ▼ button to select the desired screen function.
- 4 Make appropriate adjustments.



3 4

! NOTE

- ▶ Some signal from some graphics boards may not function properly. If the results are unsatisfactory, adjust your monitor's position, clock and phase manually.

WATCHING TV / PROGRAMME CONTROL

REMOTE CONTROL KEY FUNCTIONS

When using the remote control, aim it at the remote control sensor on the TV.

WATCHING TV / PROGRAMME CONTROL

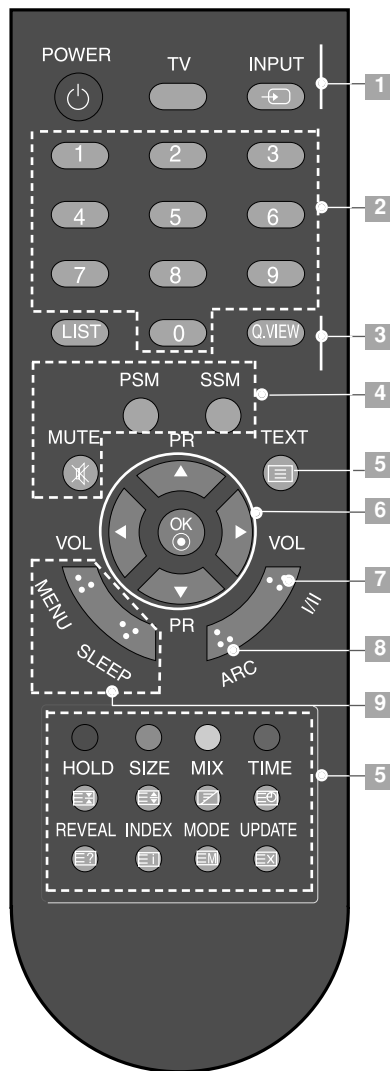

[with ARC]

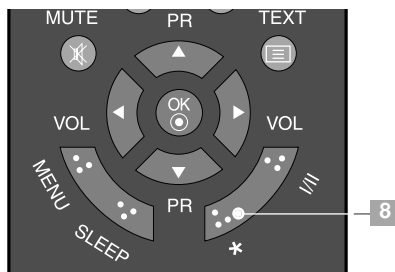

[without ARC]

- 1** **POWER** Switches the set on from standby or off to standby.

TV Returns to the TV viewing from any mode. Switches the set on from standby.

INPUT If you press the button once, the input source OSD will appear on screen as shown. Press the ▲ / ▼ button and then OK button to select the desired input source. (19/22LS4R*:TV, AV, Component, RGB, HDMI/DVI) (17LS5R*:TV, AV, Component, RGB)(20LS5R*:TV, AV, Component)
- 2** **0~9 number button** Selects a programme.
Selects numbered items in a menu.
Switches the set on from standby.
- 3** **LIST** Displays the programme table.

Q.VIEW Returns to the previously viewed programme.
- 4** **MUTE** Switches the sound on or off.

PSM Recalls your preferred picture setting.

SSM Recalls your preferred sound setting.
- 5** **Coloured buttons** These buttons are used for teletext (only **TELETEXT** models) or **Programme edit**.

TELETEXT BUTTONS These buttons are used for teletext. For further details, see the 'Teletext' section.
- 6** **THUMBSTICK** (Up/Down/Left/Right) Allows you to navigate the on-screen menus and adjust the system settings to your preference.
Adjusts the volume.
Selects a programme.
Switches the set on from standby. (Up/Down)

OK Accepts your selection or displays the current mode.

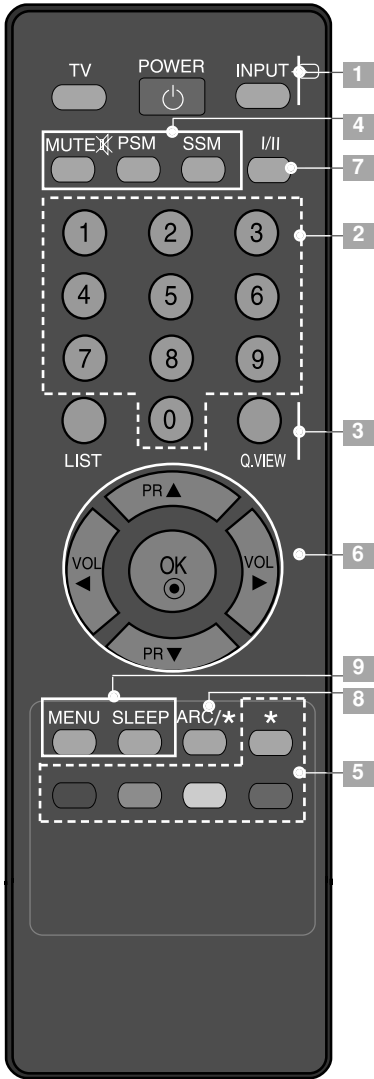

[Without TELETEXT]

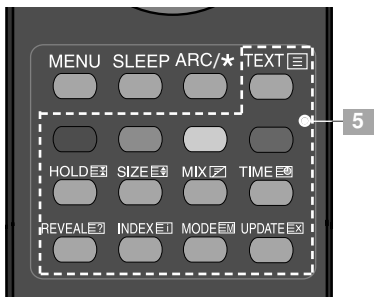

[With TELETEXT]

7 I/II Selects the sound output.

8 ARC Select your desired picture format.
* No function

9 MENU Selects a menu.
SLEEP Sets the sleep timer.

Installing Batteries

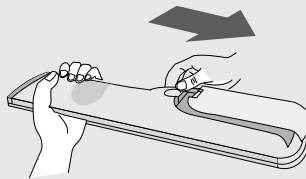

- Open the battery compartment cover on the back side and install the batteries matching correct polarity (+with +,-with -).
- Install two 1.5V AAA batteries. Don't mix old or used batteries with new ones.
- Close cover.

WATCHING TV / PROGRAMME CONTROL

TURNING ON THE TV

If your TV will be turned on, you will be able to use its features.

- 1 First, connect power cord correctly.
At this moment, the TV switches to standby mode.
 - In standby mode to turn TV on, press the $\phi/1$, INPUT, PR \blacktriangle / \blacktriangledown button on the TV or press the POWER, TV, INPUT, PR \blacktriangle / \blacktriangledown , Number(0~9) button on the remote control and then the TV will switch on.

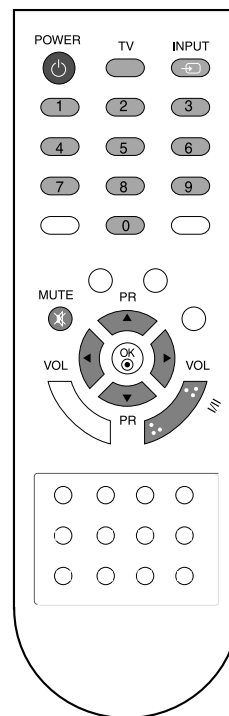

PROGRAMME SELECTION

- 1 Press the PR \blacktriangle / \blacktriangledown or NUMBER buttons to select a programme number.

VOLUME ADJUSTMENT

- 1 Press the VOL \blacktriangle / \blacktriangleright button to adjust the volume.
- 2 If you want to switch the sound off, press the MUTE button.
- 3 You can cancel the Mute function by pressing the MUTE, VOL \blacktriangle / \blacktriangleright or I/II button.

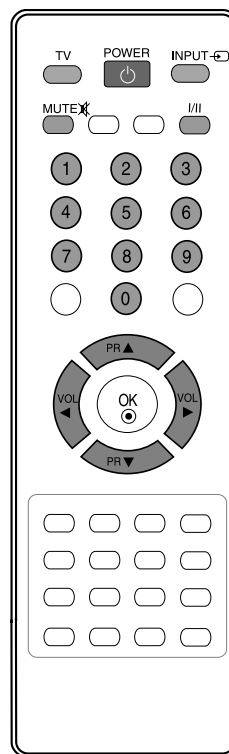

ON SCREEN MENUS SELECTION AND ADJUSTMENT

Your TV's OSD (On Screen Display) may differ slightly from what is shown in this manual.

- 1 Press the **MENU** button and then ▲ / ▼ button to display each menu.
- 2 Press the ► button and then ▲ / ▼ button to select a menu item.
- 3 Change the setting of an item in the sub or pull-down menu with ◀ / ▶ button.
You can move to the higher level menu by pressing the **OK** or **MENU** button.

* : 19LS4R*, 22LS4R*



Station menu

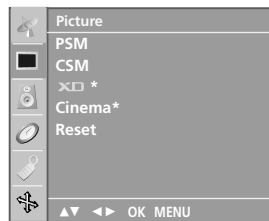

Picture menu

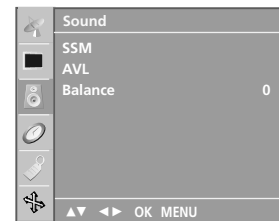

Sound menu

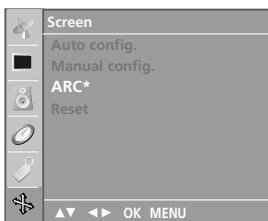

Screen menu



Special menu



Time menu

! NOTE

- a. The OSD (On Screen Display) function enables you to adjust the screen status conveniently since it provides graphical presentation.
- b. In this manual, the OSD (On Screen Display) may be different from your TV's because it is just example to help the TV operation.
- c. In the teletext mode, menus are not displayed

WATCHING TV / PROGRAMME CONTROL

AUTO PROGRAMME TUNING

Up to 100 TV stations can be stored by programme numbers (0 to 99). Once you have preset the stations, you will be able to use the PR ▲ / ▼ or NUMBER buttons to scan the stations you have programmed. Stations can be tuned using automatic or manual modes.

All stations that can be received are stored by this method. It is recommended that you use auto programme during installation of this set.

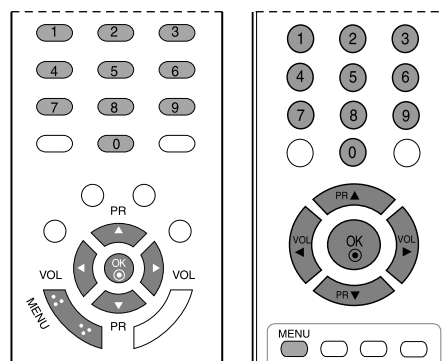

1 Press the **MENU** button and then ▲ / ▼ button to select the **Station** menu.

2 Press the ► button and then ▲ / ▼ button to select **Auto programme**.

3 Press the ► button. Select a TV system with the ► button and then ▲ / ▼ button on the **System** menu;

BG: PAL B/G, SECAM B/G (Europe/East Europe)

I : PAL I/II (U.K./Ireland)

DK: PAL D/K, SECAM D/K (East Europe)

M : (USA / Korea / Philippines) (option)

4 Press the **OK** button.

5 Press the ▲ / ▼ button to select **Storage from**.

6 Select the beginning programme number with the ◀ / ▶ button or NUMBER buttons on the **Storage from** pull-down menu. Any number under 10 is entered with a numeric '0' in front of it, i.e. '05' for 5.

7 Press the **OK** button.

8 Press the ▲ / ▼ button to select **Search**.

9 Press the ► button to begin auto tuning.

All receivable stations are stored.

To stop auto programming, press the **MENU** button.

When auto programming is completed, the Programme edit menu appears on the screen. See the Programme edit section to edit the stored programme.

10 Repeatedly press the **MENU** button to return to normal TV viewing.



1



2



3 4 5 6 7

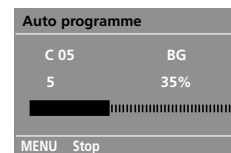

8

MANUAL PROGRAMME TUNING

Manual programme lets you manually tune and arrange the stations in whatever order you desire. Also you can assign a station name with five characters to each programme number.

- 1 Press the **MENU** button and then **▲ / ▼** button to select the **Station** menu.
- 2 Press the **▶** button and then **▲ / ▼** button to select **Manual programme**.
- 3 Press the **▶** button and then **▲ / ▼** button to select **Storage**.
- 4 Select the desired programme number (0 to 99) with the **◀ / ▶** button or **NUMBER** buttons on the Storage menu. Any number under 10 is entered with a numeric '0' in front of it, i.e. '05' for 5.
- 5 Press the **OK** button.
- 6 Press the **▲ / ▼** button to select **System**.
- 7 Select a TV system with the **▶** button and then **▲ / ▼** button on the System menu;
 - BG**: PAL B/G, SECAM B/G (Europe/East Europe)
 - I** : PAL I/II (U.K./Ireland)
 - DK**: PAL D/K, SECAM D/K (East Europe)
 - M** : (USA / Korea / Philippines) (option)
- 8 Press the **OK** button.
- 9 Press the **▲ / ▼** button to select **Band**.
- 10 Press the **▶** button and then **▲ / ▼** button to select VHF/UHF or Cable on the Band menu.
- 11 Press the **OK** button.
- 12 Press the **▲ / ▼** button to select **Channel**.
- 13 Select the desired programme with **◀ / ▶** button or **NUMBER** buttons.
- 14 Press the **OK** button.
- 15 Press the **▲ / ▼** button to select **Search**.
- 16 Press the **▶** button and then **◀ / ▶** button to commence search-ing on the Search pull-down menu. If a station is found the search will stop.
- 17 Press the **OK** button to store it.
- 18 To store another station, repeat steps 3 to 17.
- 19 Repeatedly press the **MENU** button to return to normal TV viewing.

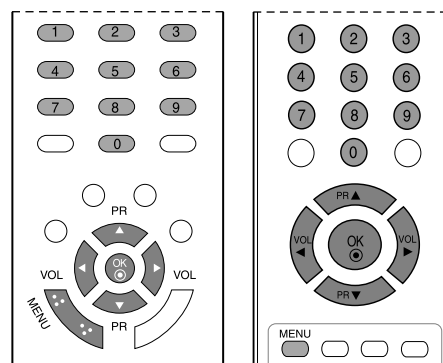

1



2

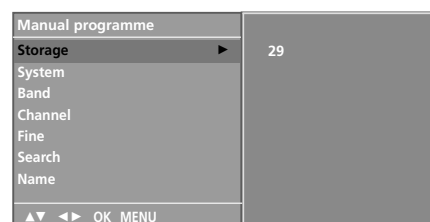

WATCHING TV / PROGRAMME CONTROL

FINE TUNING

Normally fine tuning is only necessary if reception is poor.
The finely tuned programme will be indicated by orange number-
during programme selection.

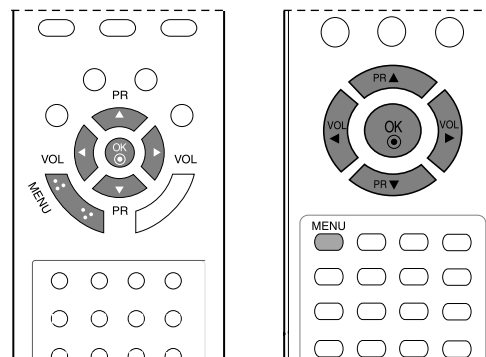

- 1 Press the **MENU** button and then **▲ / ▼** button to select the **Station** menu.
- 2 Press the **▶** button and then **▲ / ▼** button to select **Manual programme**.
- 3 Press the **▶** button.
- 4 Press the **◀ / ▶** button to fine tune for the best picture and sound on the **Fine** pull-down menu.
- 5 Press the **OK** button.
- 6 Repeatedly press the **MENU** button to return to normal TV viewing.



1



2

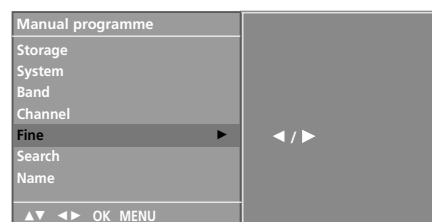

3 4 5

ASSIGNING A STATION NAME

You can assign a station name with five characters to each programme number.

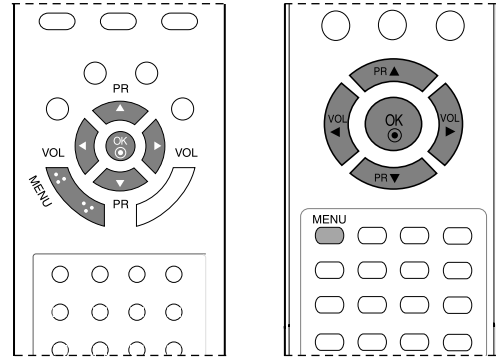

- 1 Press the **MENU** button and then **▲ / ▼** button to select the **Station** menu.

- 2 Press the **▶** button and then **▲ / ▼** button to select **Manual programme**.

- 3 Press the **▶** button and then **▲ / ▼** button to select **Name**.

- 4 Press the **▶** button and then **▲ / ▼** button. You can use a blank, **+**, **-**, the number **0** to **9** and the alphabet **A** to **Z**. It can be saved 5 digits for name. With the **◀** button you can select in the opposite direction.

- 5 Press the **◀ / ▶** button to select the position and make your choice of the second character, and so on.

- 6 Press the **OK** button to store it.

- 7 Repeatedly press the **MENU** button to return to normal TV viewing.

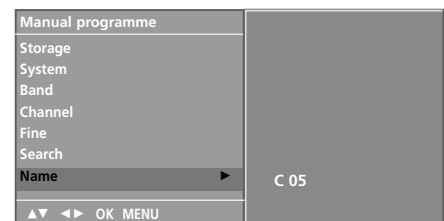

3 4 5 6

PROGRAMME EDIT

This function enables you to delete or skip the stored programmes. Also you can move some stations to other programme numbers or copy a blank station data into the selected programme number.

1 Press the **MENU** button and then **▲ / ▼** button to select the **Station** menu.

2 Press the **▶** button and then **▲ / ▼** button to select **Programme edit**.

3 Press the **▶** button to display the Programme edit menu.

■ Deleting a programme

1. Select a programme to be deleted with the **▲ / ▼ / ◀ / ▶** button.
2. Press the **RED** button twice.
The selected programme is deleted, all the following programmes are shifted up one position.

■ Copying a programme

1. Select a programme to be copied with the **▲ / ▼ / ◀ / ▶** button.
2. Press the **GREEN** button.
All the following programmes are shifted down one position.

■ Moving a programme

1. Select a programme to be moved with the **▲ / ▼ / ◀ / ▶** button.
2. Press the **YELLOW** button.
3. Move the programme to the desired programme number with the **▲ / ▼ / ◀ / ▶** button.
4. Press the **YELLOW** button again to release this function.

■ Skipping a programme number

1. Select a programme number to be skipped with the **▲ / ▼ / ◀ / ▶** button.
2. Press the **BLUE** button. The skipped programme turns to blue.
3. Press the **BLUE** button again to release the skipped programme.

When a programme number is skipped it means that you will be unable to select it using the **▲ / ▼** button during normal TV viewing. If you want to select the skipped programme, directly enter the programme number with the **NUMBER** buttons or select it in the programme edit or table menu.

4 Repeatedly press the **MENU** button to return to normal TV viewing.

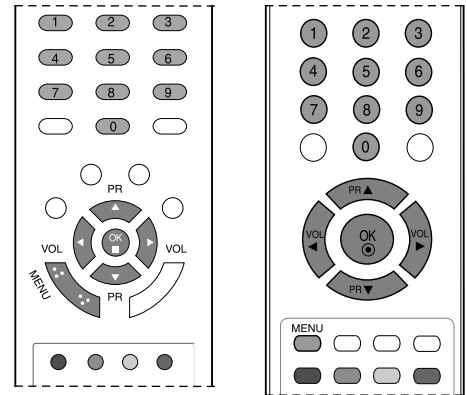

1



2

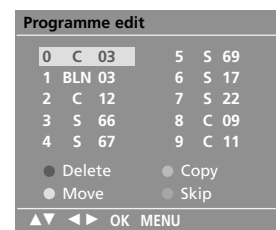

3

FAVOURITE PROGRAMME

This function lets you select your favourite programmes directly.

Repeatedly press the **YELLOW** button to select stored favourite programmes while it is selected **On**. Repeatedly press the **YELLOW** button to select previous programmes while it is selected **Off**.

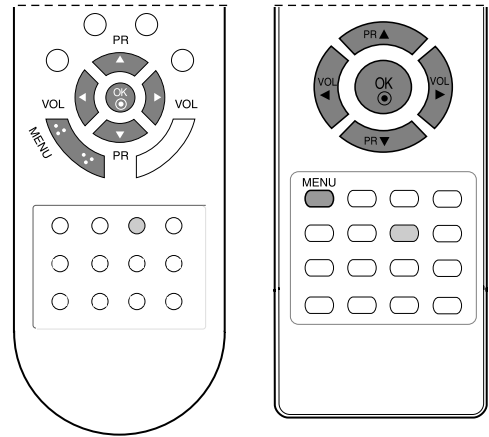

1 Press the **MENU** button and then **▲ / ▼** button to select the **Station** menu.

2 Press the **▶** button and then **▲ / ▼** button to select **Favourite Programme**.

3 Press the **▶** button and then **◀ / ▶** button to select **On** or **Off**.

4 Press the **▲ / ▼** button to select - - - - -.

5 Select a desired programme with the **◀ / ▶** button.

6 To store another programme, repeat steps **4** to **5**. You can store up to 8 programmes.

7 Repeatedly press the **MENU** button to return to normal TV viewing.

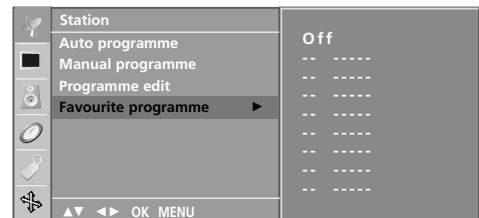

2 3 4 5

WATCHING TV / PROGRAMME CONTROL

CALLING THE PROGRAMME TABLE

You can check the programmes stored in the memory by displaying the programme table.

■ Displaying programme table

Press the **LIST** button to display the Programme table menu.

The programme table appears on the screen.

One programme table contains ten programmes as shown.

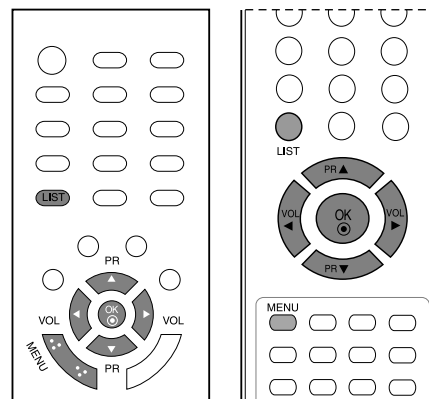

! NOTE

- You may find some blue programmes. They have been set up to be skipped by auto programming or in the programme edit mode.
- Some programmes with the channel number shown in the programme table indicate there is no station name assigned.

■ Selecting a programme in the programme table

Select a programme with the **▲ / ▼ / ◀ / ▶** button.

Then press the **OK** button. The set switches to the chosen programme number.

■ Paging through a programme table

There are 10 programme table pages in which contain 100 programmes. Pressing the **▲ / ▼ / ◀ / ▶** button repeatedly turns the pages.

Press the **LIST** button to return to normal TV viewing.

| | | | | | |
|---|-----|----|---|---|----|
| 0 | C | 03 | 5 | S | 69 |
| 1 | BLN | 03 | 6 | S | 17 |
| 2 | C | 12 | 7 | S | 22 |
| 3 | S | 66 | 8 | C | 09 |
| 4 | S | 67 | 9 | C | 11 |

▲▼ ◀▶ OK MENU

CHILD LOCK

The TV can be set so that the remote control is needed to control it. This feature can be used to prevent unauthorized viewing.

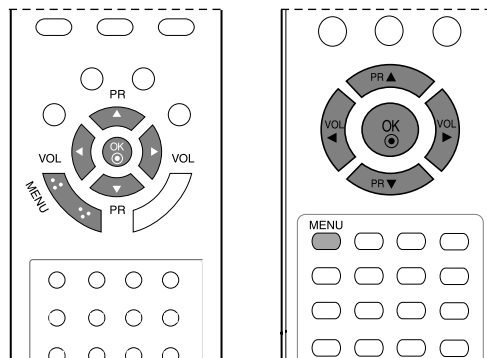

- 1 Press the **MENU** button and then **▲ / ▼** button to select the **Special** menu.
- 2 Press the **▶** button and then **▲ / ▼** button to select **Child lock**.
- 3 Press the **▶** button and then **▲ / ▼** button to select **On** or **Off**.
- 4 Repeatedly press the **MENU** button to return to normal TV viewing.



1

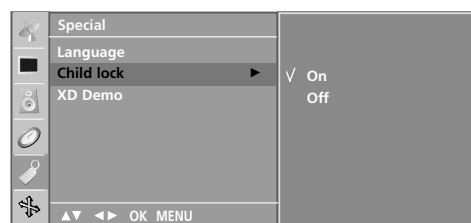

2 3

! NOTE

- ▶ With the **Child lock on**, the display **Child lock on** appears on the screen if any button on the front panel is pressed while viewing the set.

PICTURE CONTROL

PICTURE SIZE (ASPECT RATIO)CONTROL(ONLY 19/22LS4R*)

You can watch the screen in various picture formats; **Spectacle**, **Original**, **4:3**, **16:9**, **Zoom1**, **Zoom2**.

You can adjust the enlarge proportion using ▲ / ▼ button.

This function works in the following signal.

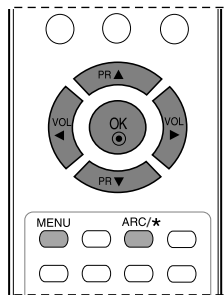
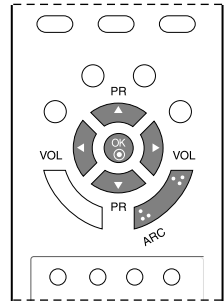

- 1 Repeatedly press the **ARC** button to select your desired picture format.

You can also adjust **ARC** in the **Screen** menu.

• Spectacle

When your TV receives the wide screen signal, when selected it will adjust the picture horizontally, in non-linear proportion, to fill the entire screen.

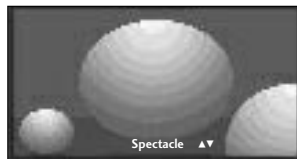

• Original

When your TV receives the wide screen signal, it will be automatically changed to the picture format to be sent.

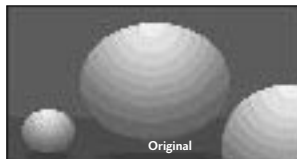

• 4:3

Following selection will lead you to view a picture with an original 4:3 aspect ratio, with gray bars appearing at both the left and right sides.



• 16:9

Following selection will lead you to adjust the picture horizontally, in a linear proportion, to fill the entire screen (useful for viewing 4:3 formatted DVDs).screen coverage.

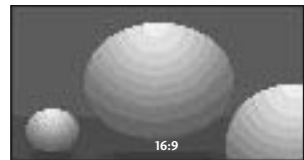

- **14:9**

You can enjoy the picture format of 14:9 or general TV programme through the 14:9 mode. The screen 14:9 is viewed just like that the screen 4:3 is magnified to the left / right.

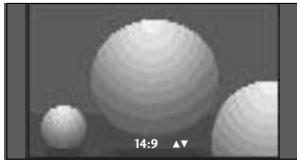

- **Zoom1**

Following selection will lead you to view the picture without any alternation, while filling the entire screen. However, the top and bottom portions of the picture will be cropped.

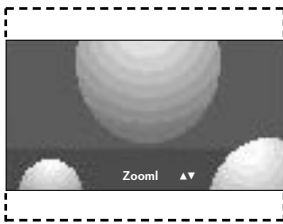

- **Zoom2**

Choose Zoom2 when you want the picture to be altered, both horizontally extended and vertically cropped. The picture taking a halfway trade off between alteration and screen coverage.

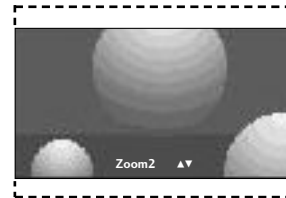

! NOTE

▶ ARC menu is not available in RGB, HDMI, Component mode except 4:3, 16:9.

PICTURE CONTROL

PRESET PICTURE SETTINGS

Picture Mode-Preset

- Dynamic** Select this option to display with a sharp image.
Standard The most general and natural screen display status.
Mild Select this option to display with a mild image.
Game Select this option to display with a game image.
User Select this option to use the user-defined setting.

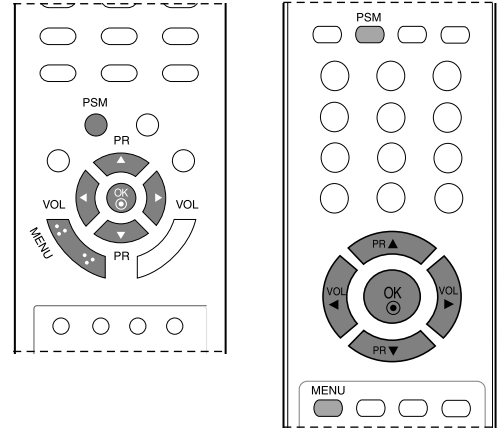

- 1 Press the **MENU** button and then **▲ / ▼** button to select the **Picture** menu.
- 2 Press the **▶** button and then **▲ / ▼** button to select **PSM**.
- 3 Press the **▶** button and then **▲ / ▼** button to select a picture setting on the **PSM** menu.

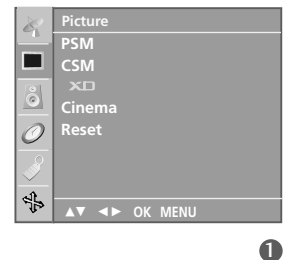

- 4 Repeatedly press the **MENU** button to return to normal TV viewing.
 - You can also recall a desired picture (Dynamic, Standard, Mild, Game or User) with PSM button on the remote control. The picture Dynamic, Standard, Mild and Game are programmed for optimum picture reproduction at the factory and cannot be changed.

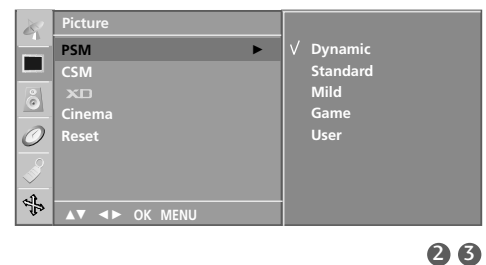

Auto Color Tone Control (Warm/Normal/Cool)

Selecting a factory setting colour set.

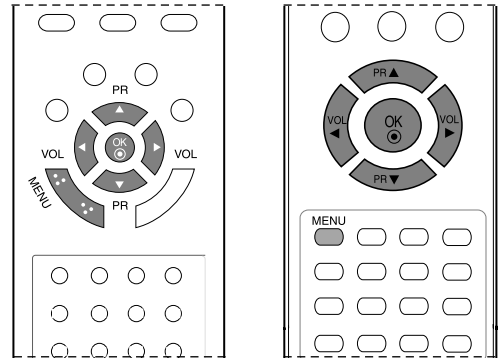

- 1 Press the **MENU** button and then **▲ / ▼** button to select the **Picture** menu.
- 2 Press the **▶** button and then **▲ / ▼** button to select **CSM**.
- 3 Press the **▶** button and then **▲ / ▼** button to select a color setting on the **CSM** menu: **Cool**, **Normal**, **Warm** or **User**.
- 4 Repeatedly press the **MENU** button to return to normal TV viewing.

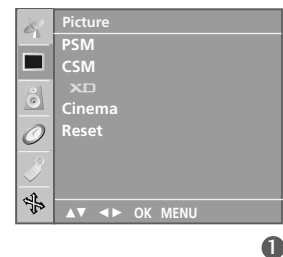

1

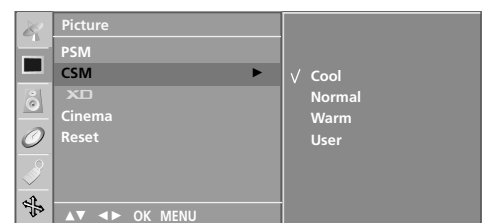

2 3

PICTURE CONTROL

MANUAL PICTURE ADJUSTMENT

Picture Mode-User Option

- Contrast** Adjusts the difference between the light and dark levels in the picture.
- Brightness** Increases or decreases amount of white in the your picture.
- Colour** Adjusts intensity of all colours.
- Sharpness** Adjusts the level of crispness in the edges between the light and dark areas of the picture. The lower the level, the softer the image.
- Tint** Adjusts the balance between red and green levels.

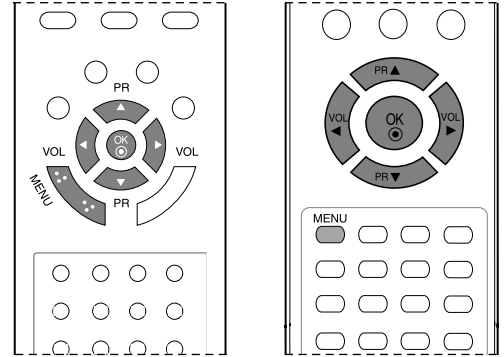

- 1 Press the **MENU** button and then **▲ / ▼** button to select the **Picture** menu.
- 2 Press the **▶** button and then **▲ / ▼** button to select **PSM**.
- 3 Press the **▶** button and then **▲ / ▼** button to select **User**.
- 4 Press the **▶** button and then **▲ / ▼** button to select the desired picture item.
- 5 Press the **◀ / ▶** button to make appropriate adjustments.
- 6 Repeatedly press the **MENU** button to return to normal TV viewing.

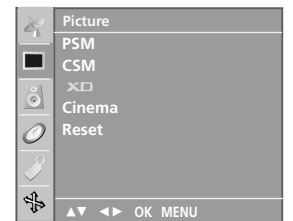

1

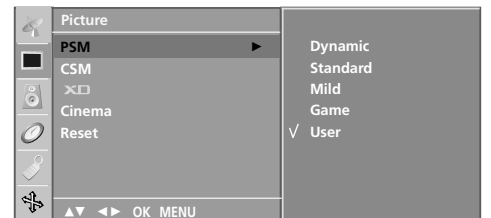

2 3

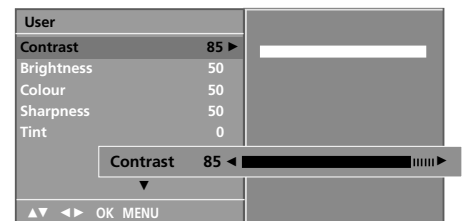

4 5

Color Tone - User Option

Selecting a factory setting colour set.

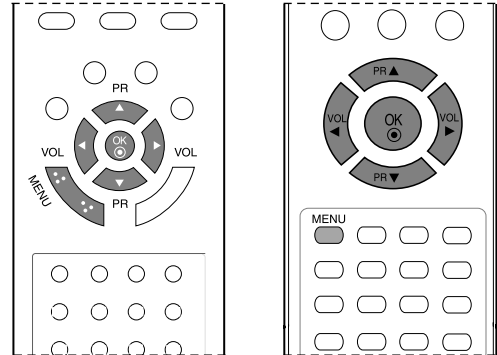

- 1 Press the **MENU** button and then **▲ / ▼** button to select the **Picture** menu.

- 2 Press the **▶** button and then **▲ / ▼** button to select **CSM**.

- 3 Press the **▶** button and then **▲ / ▼** button to select **User**.

- 4 Press the **▶** button and then **▲ / ▼** button to select **Red**, **Green** or **Blue**.

- 5 Press the **◀ / ▶** button to make appropriate adjustments.

- 6 Repeatedly press the **MENU** button to return to normal TV viewing.

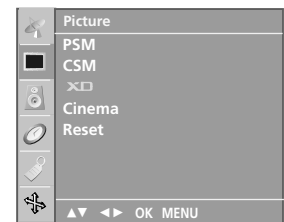

1

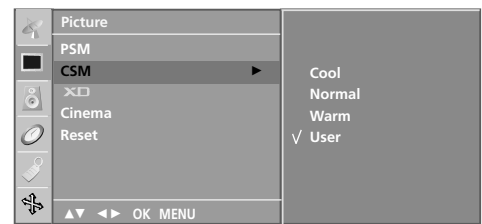

2 3

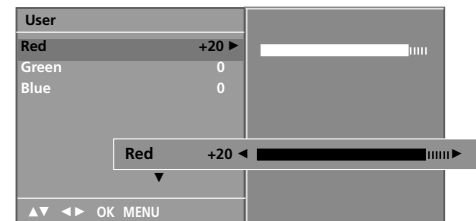

4 5

PICTURE CONTROL

XD - PICTURE IMPROVEMENT TECHNOLOGY(ONLY 19/22LS4R*)

XD is LG electronic's unique picture improving technology to display a real HD source through an advanced digital signal processing algorithm.

It's not available to use this function in RGB-PC mode.
This feature is not available for all models.

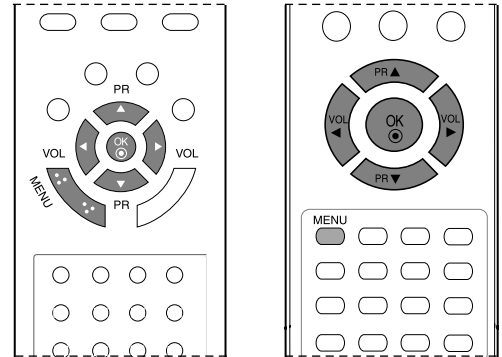

- 1 Press the MENU button and then ▲ / ▼ button to select the **Picture** menu.
- 2 Press the ► button and then ▲ / ▼ button to select **XD**.
- 3 Press the ► button and then ▲ / ▼ button to select **Auto** or **Manual**.
- 4 Repeatedly press the MENU button to return to normal TV viewing.

* Selecting the Manual

This menu is activated after selecting the **User** of PSM.

- 1 Press the ► button and then ▲ / ▼ button to select **XD Contrast**, **XD Colour** or **XD NR**.
- 2 Press the ► button and then ▲ / ▼ button to select **On** or **Off**.
- 3 Repeatedly press the MENU button to return to normal TV viewing.

- **XD Contrast** : Optimizing the contrast automatically according to the brightness of the reflection.
- **XD Colour** : Adjusting the colors of the reflection automatically to reproduce as closely as possible to the natural colors.
- **XD NR** : Removing the noise up to the point where it does not damage the original picture. (It's not available to use this function in RGB[PC], HDMI[PC].)

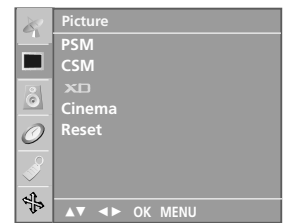

1

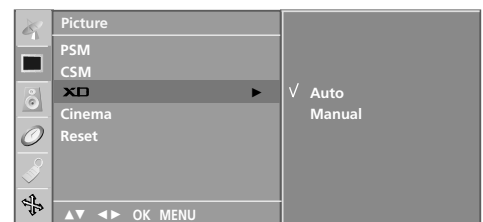

2 3

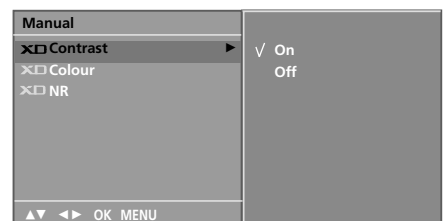

1 2

XD DEMO(ONLY 19/22LS4R*)

Use it to see the difference between XD Demo on and XD Demo off.

It's not available to use this function in RGB[PC], HDMI[PC] mode.

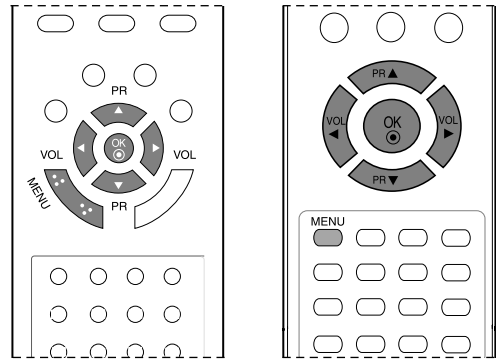

- 1 Press the MENU button and then ▲ / ▼ button to select the **Special** menu.
- 2 Press the ► button and then ▲ / ▼ button to select **XD Demo**.
- 3 Press the ► button to begin **XD Demo**.
- 4 To stop **XD Demo**, press the MENU button.



1



2 3

• XD Demo



PICTURE CONTROL

CINEMA (ONLY 19/22LS4R*)

Set up the TV for the best picture appearance for viewing movies.

This feature is not available for all models.

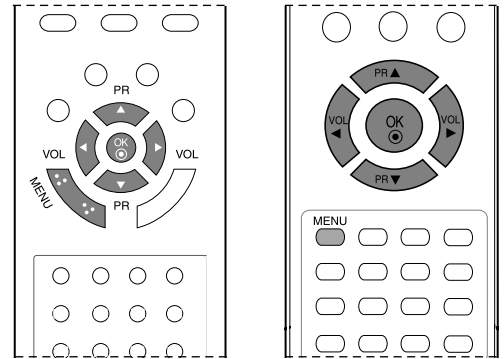

1 Press the **MENU** button and then ▲ / ▼ button to select the **Picture** menu.

2 Press the ► button and then ▲ / ▼ button to select **Cinema**.

3 Press the ► button and then ▲ / ▼ button to select **On** or **Off**.

4 Repeatedly press the **MENU** button to return to normal TV viewing.

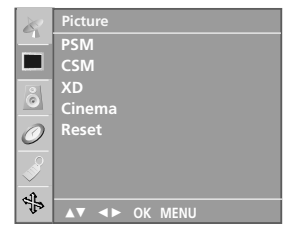

1

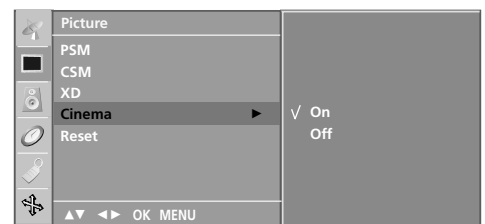

2 3

PICTURE RESET

Returns to the default settings PSM, CSM, XD, Cinema at the factory.

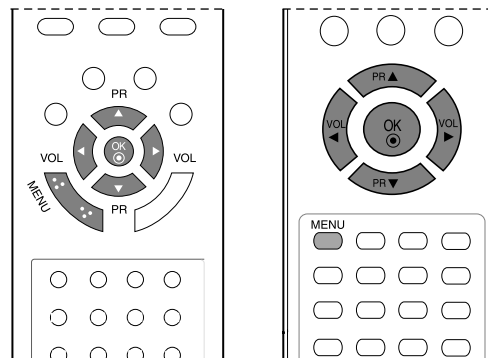

1 Press the **MENU** button and then ▲ / ▼ button to select the **Picture** menu.

2 Press the ► button and then ▲ / ▼ button to select **Reset**.

3 Press the ► button to initialize the adjusted value.

4 Repeatedly press the **MENU** button to return to normal TV viewing.

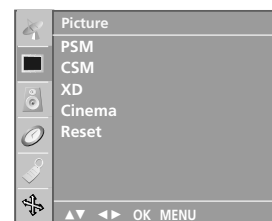

SOUND & LANGUAGE CONTROL

AUTO VOLUME LEVELER

Auto Volume automatically keeps on an equal volume level even if you change programmes.

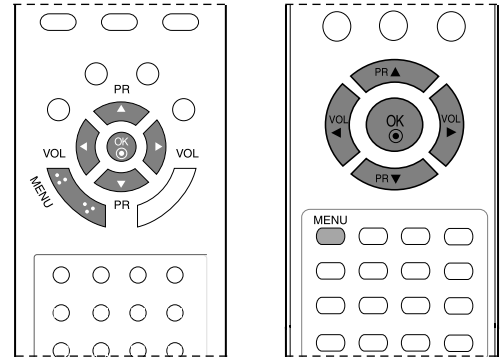

- 1 Press the **MENU** button and then **▲ / ▼** button to select the **Sound** menu.
- 2 Press the **▶** button and then **▲ / ▼** button to select **AVL**.
- 3 Press the **▶** button and then **▲ / ▼** button to select **On** or **Off**.
- 4 Repeatedly press the **MENU** button to return to normal TV viewing.



1

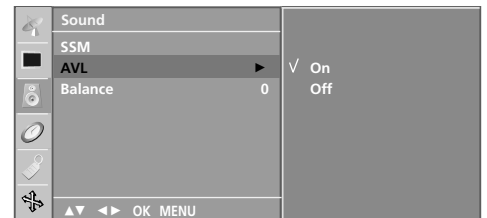

2 3

PRESET SOUND SETTINGS-SOUND MODE

You can select your preferred sound setting; Flat, Music, Movie or Sports and you can also adjust the sound frequency of the equalizer.

Flat, Music, Movie, and Sports are preset for good sound quality at the factory and are not adjustable.

- Flat** The most commanding and natural audio.
- Music** Select this option to enjoy the original sound when listening to the music.
- Movie** Select this option to enjoy sublime sound.
- Sports** Select this option to watch sports broadcasting.
- User** Select this option to use the user-defined audio settings.

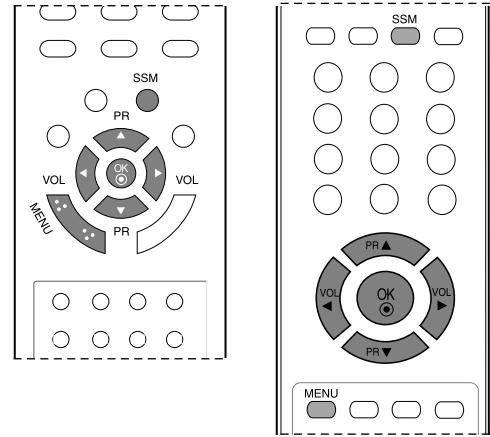

- 1 Press the **MENU** button and then **▲ / ▼** button to select the **Sound** menu.
- 2 Press the **▶** button and then **▲ / ▼** button to select **SSM**.
- 3 Press the **▶** button and then **▲ / ▼** button to select **Flat, Music, Movie, Sports** or **User**.
- 4 Repeatedly press the **MENU** button to return to normal TV viewing.

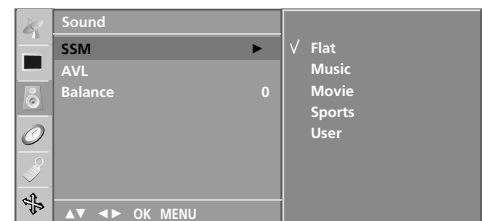
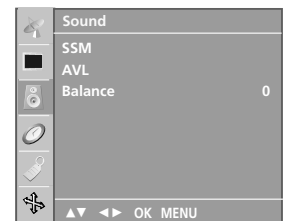

SOUND & LANGUAGE CONTROL

SOUND SETTING ADJUSTMENT -USER MODE

Adjust the sound equalizer.

- 1 Press the **MENU** button and then ▲ / ▼ button to select the **Sound** menu.
- 2 Press the ► button and then ▲ / ▼ button to select **SSM**.
- 3 Press the ► button and then ▲ / ▼ button to select **User**.
- 4 Press the ► button.
- 5 Select a sound band by pressing the ◀ / ▶ button. Make appropriate sound level with the ▲ / ▼ button.
- 6 Press the **OK** button to store it for the sound **User**.
- 7 Repeatedly press the **MENU** button to return to normal TV viewing.

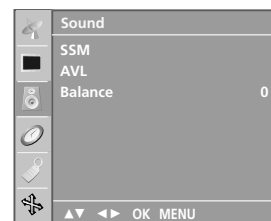
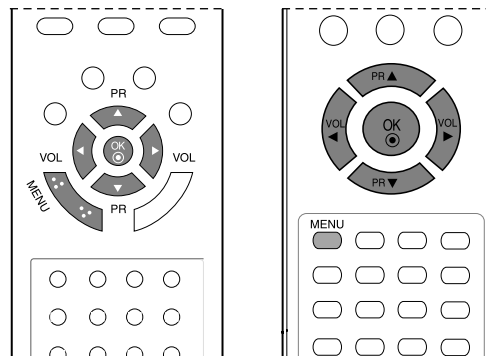

1

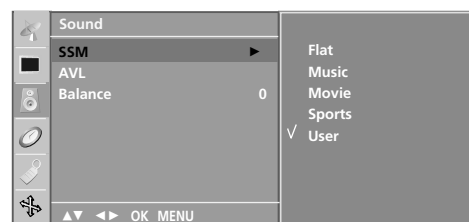

2 3 4

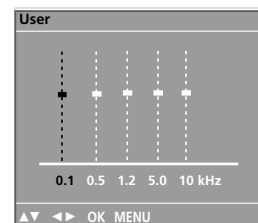

5

BALANCE

You can adjust the sound balance of speaker to the levels you prefer.

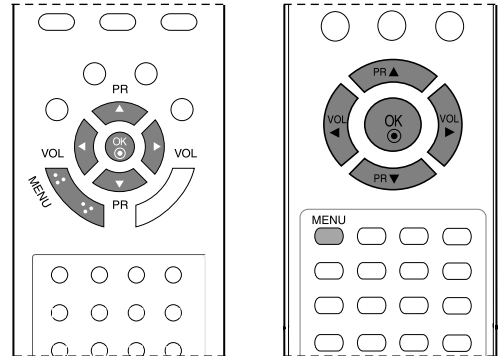

- 1 Press the **MENU** button and then **▲ / ▼** button to select the **Sound** menu.
- 2 Press the **▶** button and then **▲ / ▼** button to select **Balance**.
- 3 Press the **▶** button and then **◀ / ▶** button to make desired adjustment.
- 4 Repeatedly press the **MENU** button to return to normal TV viewing.

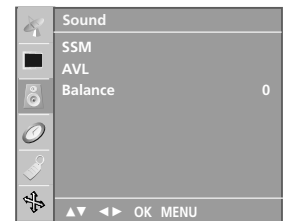

1



2 3

SOUND & LANGUAGE CONTROL

I/II

Stereo/Dual Reception

When a programme is selected, the sound information for the station appears after the programme number and station name disappear.

| Broadcast | On Screen Display |
|-----------|-------------------|
| Mono | MONO |
| Stereo | STEREO |
| Dual | DUAL I |

■ Mono sound selection

If the stereo signal is weak in stereo reception, you can switch to mono by pressing the I/II button twice. In mono reception, the depth of sound is improved. To switch back to stereo, press the I/II button twice again.

■ Language selection for dual language broadcast

If a programme received two languages (dual language), you can switch to **DUAL I**, **DUAL II** or **DUAL I+II** by pressing the I/II button repeatedly.

DUAL I Sends the primary broadcast language to the loudspeakers.

DUAL II Sends the secondary broadcast language to the loudspeakers.

DUAL I+II Sends a separate language to each loudspeaker.

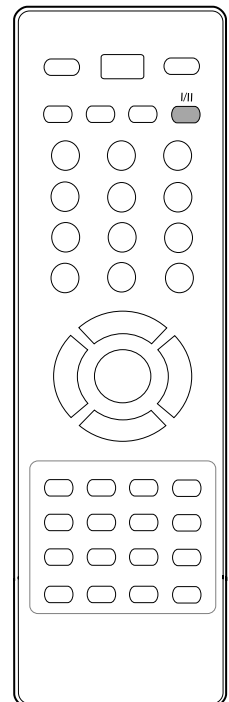
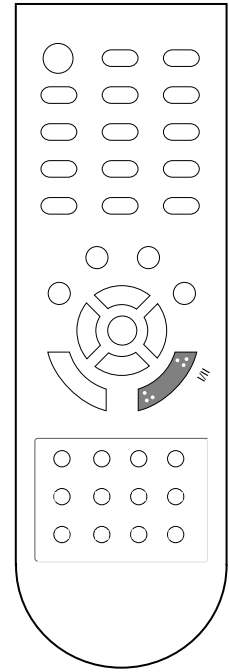

NICAM Reception

If the set is equipped with the receiver for NICAM reception, the high quality NICAM (Near Instantaneous Companding Audio Multiplex) digital sound can be received.

Sound output can be selected according to the type of received broadcast as follows by pressing the I/II button repeatedly.

-
- 1 When **NICAM mono** is received, you can select **NICAM MONO** or **FM MONO**.
-
- 2 When **NICAM stereo** is received, you can select **NICAM STEREO** or **FM MONO**.
If the stereo signal is weak, switch to **FM mono**.
-
- 3 When NICAM dual is received, you can select **NICAM DUAL I**, **NICAM DUAL II** or **NICAM DUAL I+II** or **MONO**.
-

Speaker Sound Output Selection

In AV, S-Video, Component, RGB(except 20LS5R*) and HDMI(19/22LS4R*only) mode, you can select output sound for the left and right loudspeakers.

Repeatedly press the I/II button to select the sound output.

L+R: Audio signal from audio L input is sent to the left loud speaker and audio signal from audio R input is sent to the right loud speaker.

L+L: Audio signal from audio L input is sent to left and right loud speakers.

R+R: Audio signal from audio R input is sent to left and right loud speakers.

SOUND & LANGUAGE CONTROL

ON-SCREEN MENU LANGUAGE SELECTION

The menus can be shown on the screen in the selected language. First select your language.

- 1 Press the **MENU** button and then use ▲ / ▼ button to select the **Special** menu.
- 2 Press the ► button and then use ▲ / ▼ button to select **Language**.
- 3 Press the ► button and then use ▲ / ▼ button to select your desired language.
- 4 Press the **OK** button
- 5 Press the **MENU** button to return to normal TV viewing.

! NOTE

- If you intend to be away on vacation, disconnect the power plug from wall power outlet.

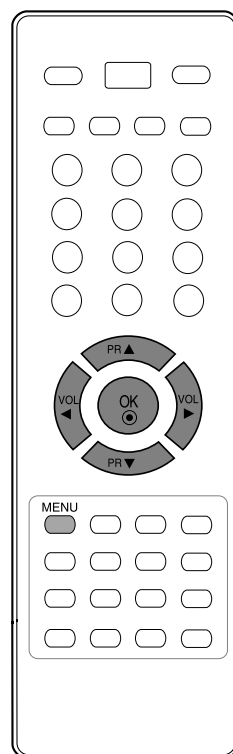
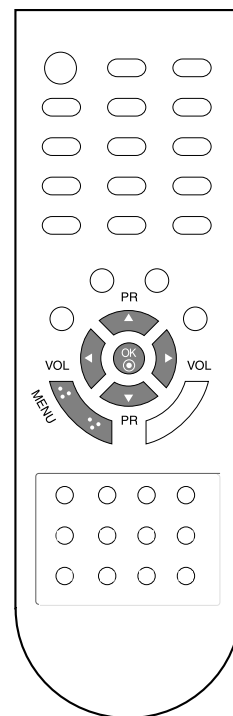

TIME SETTING

CLOCK SETUP

You must set the time correctly before using on/off time function.

In the event of power interruption (disconnection or power failure), the clock must be reset.

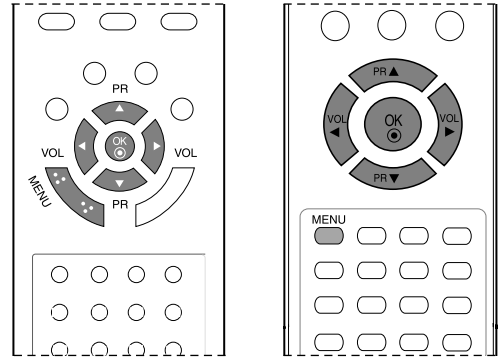

1 Press the **MENU** button and then ▲ / ▼ button to select the **Time** menu.

2 Press the ► button and then ▲ / ▼ button to select **Clock**.

3 Press the ► button and then ▲ / ▼ button to set the hour.

4 Press the ► button and then ▲ / ▼ button to set the minutes.

5 Repeatedly press the **MENU** button to return to normal TV viewing.

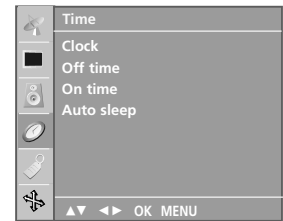

1



2 3 4

TIME SETTING

AUTO ON/OFF TIMER SETTING

The Off time automatically switches the set to standby at the preset time.

Two hours after the set is switched on by the on time function it will automatically switch back to standby mode unless a button has been pressed.

Once the on time/off time is set, these functions operate daily at the preset time.

Off time function overrides On timer function if they are set both to the same time.

The set must be in standby mode for the On timer to work.

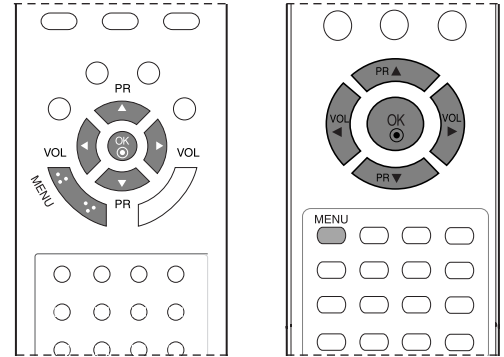

1 Press the **MENU** button and then **▲ / ▼** button to select the **Time** menu.

2 Press the **▶** button and then **▲ / ▼** button to select **On time/Off time**.

3 Press the **▶** button and then **▲ / ▼** button to select **On**.
 • To cancel **On time/Off time** function, select **Off**.

4 Press the **▶** button and then **▲ / ▼** button to set the hour.

5 Press the **▶** button and then **▲ / ▼** button to set the minutes.

6 For only On timer function
 • **Programme:** Press the **▶** button and then **▲ / ▼** button to select the programme.
 • **Volume:** Press the **▶** button and then **▲ / ▼** button to adjust volume level at turn-on.

7 Press the **MENU** button to save.

8 Repeatedly press the **MENU** button to return to normal TV viewing.

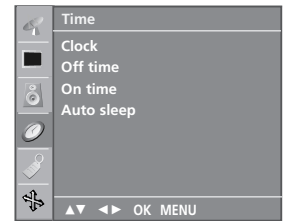

1

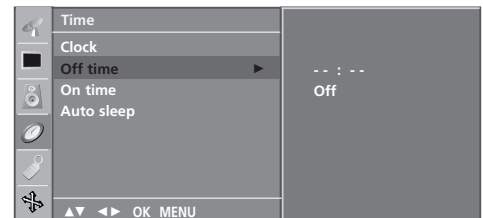

2 3

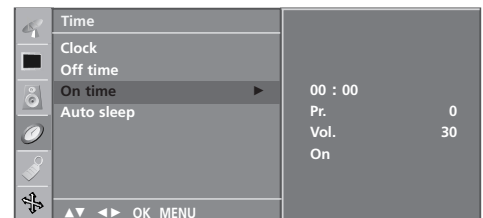

4 5 6

SLEEP TIMER SETTING

You don't have to remember to switch the set off before you go to sleep. The sleep timer automatically switches the set to standby after the preset time has elapsed.

- 1 Press the **SLEEP** button repeatedly to select the number of minutes. The display '  - - - ' will appear on the screen, followed by 10, 20, 30, 60, 90, 120, 180 and 240.
- 2 When the number of minutes you want is displayed on the screen, the timer begins to count down from the number of minutes selected.

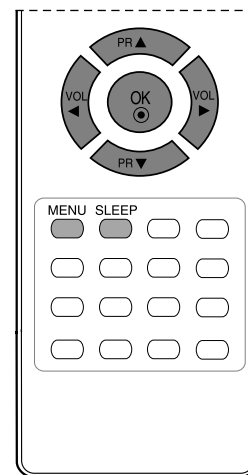
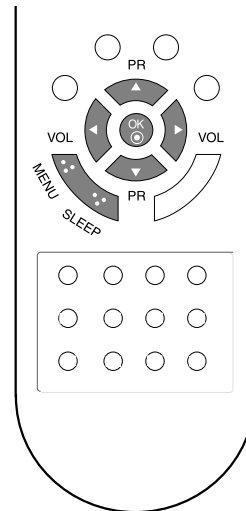

NOTE

- ▶ To view the remaining sleep time, press the **SLEEP** button once.
- ▶ To cancel the sleep time, repeatedly press the **SLEEP** button until the display '  - - - ' appears.
- ▶ When you switch the set off, the set releases the preset sleep time.

TIME SETTING

AUTO SHUT-OFF SETTING

If you select **On** on the Auto sleep menu, the set will automatically switch itself to standby mode approximately ten minutes after a TV station stops broadcasting.

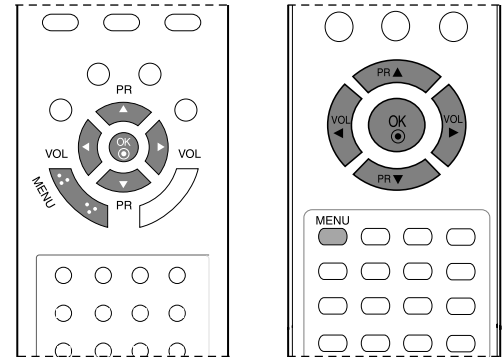

1 Press the **MENU** button and then ▲ / ▼ button to select the **Time** menu.

2 Press the ► button and then ▲ / ▼ button to select **Auto Sleep**.

3 Press the ► button and then ▲ / ▼ button to select **On** or **Off**.

4 Repeatedly press the **MENU** button to return to normal TV viewing.

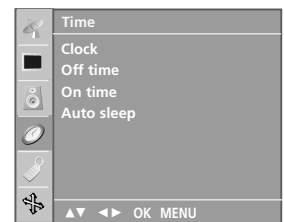

1

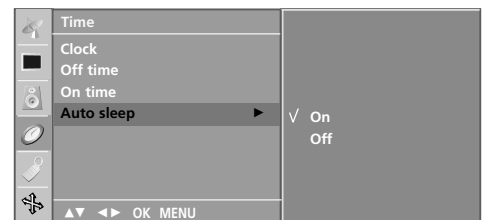

2 3

TELETEXT

This feature is not available in all countries.

Teletext (or TOP text) is an optional function, therefore only a set with the teletext system can receive the teletext broadcast.

Teletext is a free service broadcast by most TV stations which gives up-to-the-minute information on news, weather, television programmes, share prices and many other topics.

The teletext decoder of this TV can support the SIMPLE, TOP and FASTEXT systems. SIMPLE (standard teletext) consists of a number of pages which are selected by directly entering the corresponding page number. TOP and FASTEXT are more modern methods allowing quick and easy selection of teletext information.

SWITCH ON/OFF

Press the **TEXT** button to switch to teletext. The initial page or last page appears on the screen.

Two page numbers, TV station name, date and time are displayed on the screen headline. The first page number indicates your selection, while the second shows the current page displayed.

Press the **TEXT** button to switch off teletext. The previous mode reappears.

SIMPLE TEXT

■ Page selection

- 1 Enter the desired page number as a three digit number with the NUMBER buttons. If during selection you press a wrong number, you must complete the three digit number and then re-enter the correct page number.
- 2 The ▲ / ▼ button can be used to select the preceding or following page.

■ Programming a colour button in LIST mode

If the TV is in SIMPLE text, TOP text or FASTEXT mode, press the  button to switch to LIST mode.

Four teletext page numbers of your choice can be colour coded and easily selected by pressing the corresponding coloured button on the remote control handset.

- 1 Press a coloured button.
- 2 Using the NUMBER buttons, select the page you wish to programme.
- 3 Press the **OK** button. Then the selected page is stored as the selected page number by blinking once. From now on, you can select this page with the same coloured button.
- 4 The three other coloured buttons are programmed in this way.

TOP TEXT

The user guide displays four fields-red, green, yellow and blue at the bottom of the screen. The yellow field denotes the next group and the blue field indicates the next block.

■ Block / group / page selection

- ① With the blue button you can progress from block to block.
- ② Use the yellow button to proceed to the next group with automatic overflow to the next block.
- ③ With the green button you can proceed to the next existing page with automatic overflow to the next group. Alternatively the ▲ button can be used.
- ④ The red button permits to return to previous selection. Alternatively the ▼ button can be used.

■ Direct page selection

Corresponding to the SIMPLE teletext mode, you can select a page by entering it as a three digit number using the NUMBER buttons in TOP mode.

FASTEXT

The teletext pages are colour coded along the bottom of the screen and are selected by pressing the corresponding coloured button.

■ Page selection

- ① Press the  button to select the index page.
- ② You can select the pages which are colour coded along the bottom line with the same coloured buttons.
- ③ Corresponding to the SIMPLE teletext mode, you can select a page by entering its three digit page number with the NUMBER buttons in FASTEXT mode.
- ④ The ▲ / ▼ button can be used to select the preceding or following page.

SPECIAL TELETEXT FUNCTIONS



■ REVEAL

Press this button to display concealed information, such as solutions of riddles or puzzles.

Press this button again to remove the information from the display.



■ SIZE

Selects double height text.

Press this button to enlarge the top half of the page.



Press this button again to enlarge the bottom half of the page.

Press this button again to return to the normal display.



■ UPDATE

Displays the TV picture on the screen while waiting for the new teletext page.

The display  will appear at the top left hand corner of the screen. When the updated page is available then display  will change to the page number. Press this button to view the updated teletext page.



■ HOLD

Stops the automatic page change which will occur if a teletext page consists of 2 or more sub pages. The number of sub pages and the sub page displayed is, usually, shown on the screen below the time. When this button is pressed the stop symbol is displayed at the top left-hand corner of the screen and the automatic page change is inhibited. To continue press this button again.



■ MIX

Displays the teletext pages superimposed on the TV picture.

To switch the TV picture off press this button again.



■ TIME

When viewing a TV programme, press this button to display the time at the top right hand corner of the screen. Press this button again to remove the display. In the teletext mode, press this button to select a sub page number. The sub page number is displayed at the bottom of the screen. To hold or change the sub page, press the NUMBER buttons.

Press again to exit this function.

APPENDIX

TROUBLESHOOTING

| The operation does not work normally. | |
|--|---|
| The remote control doesn't work | <ul style="list-style-type: none">■ Check to see if there is any object between the product and the remote control causing obstruction.■ Are batteries installed with correct polarity (+ to +, - to -)?■ Correct remote operating mode set: TV, VCR etc.?■ Install new batteries. |
| Power is suddenly turned off | <ul style="list-style-type: none">■ Is the sleep timer set?■ Check the power control settings. Power interrupted■ No broadcast on station tuned with Auto off activated. |

| The video function does not work. | |
|--|---|
| No picture & No sound | <ul style="list-style-type: none">■ Check whether the product is turned on.■ Try another channel. The problem may be with the broadcast.■ Is the power cord inserted into wall power outlet?■ Check your antenna direction and/or location.■ Test the wall power outlet, plug another product's power cord into the outlet where the product's power cord was plugged in. |
| Picture appears slowly after switching on | <ul style="list-style-type: none">■ This is normal, the image is muted during the product startup process. Please contact your service center, if the picture has not appeared after five minutes. |
| No or poor color or poor picture | <ul style="list-style-type: none">■ Adjust Color in menu option.■ Keep a sufficient distance between the product and the VCR.■ Try another channel. The problem may be with the broadcast.■ Are the video cables installed properly?■ Activate any function to restore the brightness of the picture. |
| Horizontal/vertical bars or picture shaking | <ul style="list-style-type: none">■ Check for local interference such as an electrical appliance or power tool. |
| Poor reception on some channels | <ul style="list-style-type: none">■ Station or cable product experiencing problems, tune to another station.■ Station signal is weak, reorient antenna to receive weaker station.■ Check for sources of possible interference. |
| Lines or streaks in pictures | <ul style="list-style-type: none">■ Check antenna (Change the direction of the antenna). |

The audio function does not work.

| | |
|--|--|
| Picture OK & No sound | <ul style="list-style-type: none">■ Press the VOL (or Volume) button.■ Sound muted? Press MUTE button.■ Try another channel. The problem may be with the broadcast.■ Are the audio cables installed properly? |
| No output from one of the speakers | <ul style="list-style-type: none">■ Adjust Balance in menu option. |
| Unusual sound from inside the product | <ul style="list-style-type: none">■ A change in ambient humidity or temperature may result in an unusual noise when the product is turned on or off and does not indicate a fault with the product. |

There is a problem in PC mode. (Only PC mode applied)

| | |
|---|---|
| The signal is out of range. | <ul style="list-style-type: none">■ Adjust resolution, horizontal frequency, or vertical frequency.■ Check the input source. |
| Vertical bar or stripe on background & Horizontal Noise & Incorrect position | <ul style="list-style-type: none">■ Work the Auto configure or adjust clock, phase, or H/V position. |
| Screen colour is unstable or single colour | <ul style="list-style-type: none">■ Check the signal cable.■ Reinstall the PC video card. |

APPENDIX

MAINTENANCE

Early malfunctions can be prevented. Careful and regular cleaning can extend the amount of time you will have your new TV. Be sure to turn the power off and unplug the power cord before you begin any cleaning.

Cleaning the Screen

- 1 Here's a great way to keep the dust off your screen for a while. Wet a soft cloth in a mixture of lukewarm water and a little fabric softener or dish washing detergent. Wring the cloth until it's almost dry, and then use it to wipe the screen.
- 2 Make sure the excess water is off the screen, and then let it air-dry before you turn on your TV.

Cleaning the Cabinet

- To remove dirt or dust, wipe the cabinet with a soft, dry, lint-free cloth.
- Please be sure not to use a wet cloth.

Extended Absence

CAUTION

- ▶ If you expect to leave your TV dormant for a long time (such as a vacation), it's a good idea to unplug the power cord to protect against possible damage from lightning or power surges.

PRODUCT SPECIFICATIONS

| MODELS | | 17LS5R* | 20LS5R* | 19LS4R* | 22LS4R* |
|--|-----------------------|--|--|--|--|
| | | 17LS5R-TA | 20LS5R-TA | 19LS4R-TA | 22LS4R-TA |
| Dimensions (Width x Height x Depth) | with stand | 394.5 x 394.0 x 169.4 mm 15.5 x 15.5 x 6.7 inches | 474.1 x 464.6 x 184.3 mm 18.7 x 18.3 x 7.3 inches | 456.8 x 396.6 x 172.0 mm 18.0 x 15.6 x 6.8 inches | 525.4 x 441.7 x 187.4 mm 20.7 x 17.4 x 7.3 inches |
| | without stand | 394.5 x 352.0 x 66.0 mm 15.5 x 13.9 x 2.6 inches | 474.1 x 419.5 x 72.8 mm 18.7 x 16.5 x 2.9 inches | 456.8 x 368.5 x 70.5 mm 18.0 x 14.5 x 2.8 inches | 525.4 x 413 x 68.6 mm 20.7 x 16.3 x 2.7 inches |
| Weight | with stand | 4.4kg / 9.7 lbs | 6.8 kg / 15.0 lbs | 5.1 kg / 11.3 lbs | 5.8kg / 12.8 lbs |
| | without stand | 4.1kg / 9.1 lbs | 6.4kg / 14.1 lbs | 4.6 kg / 10.2 lbs | 5.2 kg / 11.5 lbs |
| Power requirement | | AC100-240V~ 50/60Hz 0.8A | AC100-240V~ 50/60Hz 1.0A | AC100-240V~ 50/60Hz 0.8A | AC100-240V~ 50/60Hz 1.0A |
| Television System | | PAL/SECAM B/G/D/K, PAL I/II, NTSC-M | | | |
| Program Coverage | | VHF: NZ1 ~ E21, UHF: E21 ~ E69, CATV: S1 ~ S20, HYPER: S21 ~ S47 | | | |
| External Antenna Impedance | | 75 Ω | | | |
| Environment condition | Operating Temperature | 0 ~ 40°C / 32 ~ 104°F | | | |
| | Operating Humidity | Less than 80% | | | |
| | Storage Temperature | -20 ~ 60°C / -4 ~ 140°F | | | |
| | Storage Humidity | Less than 85% | | | |

■ The specifications shown above may be changed without prior notice for quality improvement.

LG Electronics Inc.