



## **FRIDGE-FREEZER**

### **User's Guide**

Please read this User's Guide carefully before operating and keep it handy for reference at all times.

## **FRIGORÍFICO CONGELADOR**

### **Guía del usuario**

Lea esta guía del usuario con atención antes de utilizar la unidad y manténgala a mano para consultas posteriores.

## **FRIGORÍFICO - CONGELADOR**

### **Manual do Utilizador**

Por favor leia cuidadosamente este Manual do Utilizador antes da primeira utilização e mantenha-o à mão para poder consultá-lo sempre que necessário.

Lea detenidamente el contenido de esta tarjeta de Garantía

# Table of Contents

Introduction	Registration	4
	Important Safety Instruction	4
	Identification of Parts	16
Installation	Installation	17
	Starting	17
Operation	Temperature Control	18
	Miracle Zone	20
	Express Frz.	21
	Vacation	22
	Self Test	23
	Lock	23
	On/Off	23
	Vita Light	23
	Door Alarm	24
	Ice Making	24
	Ice Homebar	25
	Defrosting	25
	Water Dispenser	26
Wine Rack	28	
Suggestion On	Storing Food	29
Food storage		
Care and	General Information	31
Maintenance	Lamp Replacement	32
	To Reverse the Doors	32
	Cleaning	33
Trouble Shooting	Trouble Shooting	35

## Introduction

## Registration

The model and serial number are found on the rear of this unit. This number is unique to this unit and not available to others. You should record requested information here and retain this guide as a permanent record of your purchase. Staple your receipt here.

Date of Purchase : \_\_\_\_\_

Dealer Purchased From : \_\_\_\_\_

Dealer Address : \_\_\_\_\_

Dealer Phone No. : \_\_\_\_\_

Model No. : \_\_\_\_\_

Serial No. : \_\_\_\_\_

## Important Safety Instruction

### BASIC SAFETY PRECAUTIONS

This guide contains many important safety messages. Always read and obey all safety messages.

 This is the safety alert symbol. It alerts you to safety messages that inform you of hazards that can kill or hurt you or others or cause damage to the product. All safety messages will be preceded by the safety alert symbol and the hazard signal word DANGER, WARNING, or CAUTION. These words mean:

 **DANGER** You will be killed or seriously injured if you don't follow instructions.

 **WARNING** You can be killed or seriously injured if you don't follow instructions.

 **CAUTION** Indicates an imminently hazardous situation which, if not avoided, may result in minor or moderate injury, or product damage only.

All safety messages will identify the hazard, tell you how to reduce the chance of injury, and tell you what can happen if the instructions are not followed.

## Important Safety Instruction

### **⚠ WARNING**

To reduce the risk of fire, electric shock, or injury to persons when using your product, basic safety precautions should be followed, including the following. Read all instructions before using this appliance.

#### **1. When connecting the power**

##### **The dedicated outlet should be used.**

- Using several devices at one outlet may cause fire.
- The electric leakage breaker may damage food and the dispenser may be leaked.



##### **Do not allow the power plug to face upward or to be squeezed at the back of the fridge-freezer.**

Water may be flown into or the plug may be damaged, which causes fire or electric shock.

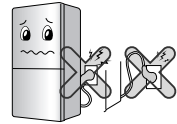

##### **Do not allow the power cord bent or pressed by the heavy object to be damaged.**

It may damage the power cord to cause fire or electric shock.



##### **Do not extend or modify the length of the power plug.**

It causes electric shock or fire by the electric damage of the power cord or others.



##### **Unplug the power plug when cleaning, handling or replacing the interior lamp of the fridge-freezer.**

- It may cause electric shock or injury.
- When replacing the interior lamp of the fridge-freezer, make sure that the rubber ring for preventing the electric spark within the socket is not taken off.



## Important Safety Instruction

**Do not pull out the cord or touch the power plug with wet hands.**

It may cause electric shock or injury.



**Remove water or dust from the power plug and insert it with the ends of the pins securely connected.**

Dust, water or unstable connection may cause fire or electric shock.

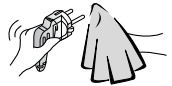

**Make sure of grounding.**

The incorrect grounding may cause breakdown and electric shock.

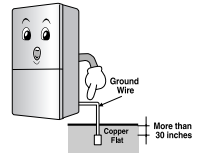

**When the power cord or the power plug is damaged or the holes of the outlet are loosed, do not use them.**

It may cause electric shock or short circuit to make fire.

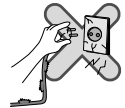

## 2. When using the fridge-freezer

**Do not place the heavy object or the dangerous object (container with liquid) on the fridge-freezer.**

It may be dropped to cause injury, fire or electric shock when opening or closing the door.



**Do not cling to the door or the shelves of the door or the home bar of the freezer or the cool chamber.**

It may make the fridge-freezer fallen down or damage the hands. Especially, do not allow the children to do the above.



## Important Safety Instruction

**Do not install the fridge-freezer in the wet place or the place which water or rain splashes.**

Deterioration of insulation of electric parts may cause electric leakage.



**Do not use or store inflammable materials ether, benzene, alcohol, medicine, LP gas, spray or cosmetics near or in the fridge-freezer.**

It may cause explosion or fire.

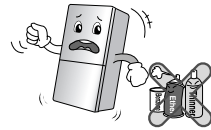

**Do not place the lit candle within the fridge-freezer to deodorize.**

It may cause explosion or fire.



**Do not store the medicine or the academic materials at the fridge-freezer.**

When the material with the strict temperature control is stored, it may be deteriorated or it may make an unexpected reaction to cause any risk.

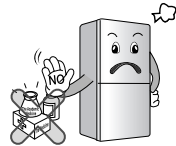

**Do not use the combustible spray near the fridge-freezer.**

It may cause fire.



## Important Safety Instruction

### Avoid the heating devices.

It may cause fire.

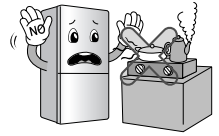

### Do not place flower vase, cup, cosmetics, medicine or any container with water on the fridge-freezer.

It may cause fire, electric shock or injury by dropping down.

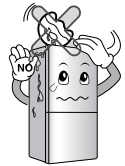

### Use the submerged fridge-freezer after checking it.

It may cause electric shock or fire.

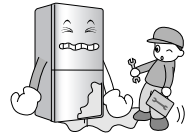

### When gas is leaked, do not touch the fridge-freezer or the outlet and ventilate the room immediately.

- The explosion by spark may cause fire or burn.
- Because this fridge-freezer uses natural gas (isobutene, R600a) as the environment-friendly refrigerant, even a small amount (80~90g) is combustible. When the gas is leaked by the severe damage during delivering, installing or using the fridge-freezer, any spark may cause fire or burn.

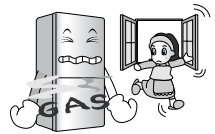

### Do not spray water at the outside or the inside of the fridge-freezer or do not clean it with benzene or thinner.

Deterioration of insulation of electric parts may cause electric shock or fire.



## Important Safety Instruction

**When any strange smell or smoke is detected from the fridge-freezer, disconnect the power plug immediately and contact to the service center.**

It may cause fire.

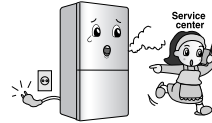

**Do not allow any person except the qualified engineer to disassemble, repair or alter the fridge-freezer.**

It may cause injury, electric shock or fire.

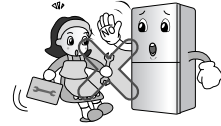

**Do not use the fridge-freezer for non-domestic purpose (storing medicine or testing material, using at the ship, etc.).**

It may cause an unexpected risk such as fire, electric shock, deterioration of stored material or chemical reaction.

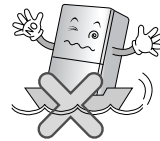

**When disposing the fridge-freezer, remove the packing materials from the door.**

It may cause to lock out the child.



**Install the fridge-freezer on the solid and level floor.**

Installing it on the unstable place may cause death by falling down the fridge-freezer when opening or closing the door.





## Important Safety Instruction

**Do not insert the hands or the metal stick into the exit of cool air, the cover, the bottom of the fridge-freezer, the heatproof grill (exhaust hole) at the backside.**

It may cause electric shock or injury.



**When you want to dispose the fridge-freezer, contact to the down-block office.**

When you want to dispose the large living waste such as electric home appliance and furniture, you'd better contact the local down-block office.



### **⚠ CAUTION**

Violating this direction may cause injury or damage house or furniture. Always be careful, please.

**Do not touch food or containers at the freezer with wet hands.**

It may cause frostbite.

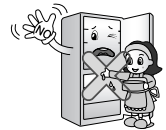

**Wait for 5 minutes or longer when reconnecting the plug.**

It may cause the operation of the freezer to fail.



**Do not put bottle in the freezer.**

It may freeze the contents to break the bottle to cause injury.



**Pull out the power plug not by grasping the cord but the plug of its end.**

It may cause electric shock or short circuit to fire.



## Important Safety Instruction

**Do not install the fridge-freezer in the wet place or the place which water or rain splashes.**

Deterioration of insulation of electric parts may cause electric leakage.



**Do not insert the hands into the bottom of the fridge-freezer.**

The iron plate of the bottom may cause injury.



**Carry the fridge-freezer with the handle bar at the bottom of the front and the top of the rear.**

Otherwise, your hands may be slipped to cause injury.

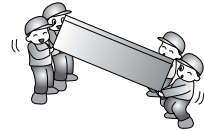

**Because opening or closing the door of the fridge-freezer may cause injury to the person around it, be careful, please.**

Opening or closing the door may cause feet or hands to be caught in the chink in door or the child to be get hurt by the corner.

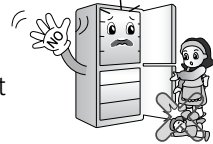

**Do not put any living animal in the fridge-freezer.**



### Precaution

## Important Safety Instruction

### ⚠ Warning

- This fridge-freezer must be properly installed and located in accordance with the installation instruction before it is used.
- Never unplug your fridge-freezer by pulling on the power cord. Always grip plug firmly and pull straight out from the outlet.
- When moving your appliance away from the wall, be careful not to roll over or damage the power cord.
- After your fridge-freezer is in operation, do not touch the cold surfaces in the freezer compartment, particularly when hands are damp or wet. Skin may adhere to these extremely cold surfaces.

## Important Safety Instruction

**Accessibility of  
Supply Plug**

The supply plug of the refrigerator-freezer should be placed in easy accessible position for quick disconnection in emergency.

**Supply Cord  
Replacement**

If the supply cord is damaged, it must be replaced by the manufacturer or its service agent or a similarly qualified person in order to avoid a hazard.

**Danger**

Risk of child entrapment.  
Before you throw away your old refrigerator or freezer:  
Take off the doors.  
Leave the shelves in place so that children may not easily climb inside.

**Don't store**

Don't store or use gasoline or other flammable vapors and liquids in the vicinity of this or any other appliance.

**Grounding  
(Earthing)**

In the event of an electric short circuit, grounding (earthing) reduces the risk of electric shock by providing an escape wire for the electric current. In order to prevent possible electric shock, this appliance must be grounded. Improper use of the grounding plug can result in an electric shock. Consult a qualified electrician or service person if the grounding instructions are not completely understood, or if you have doubts on whether the appliance is properly grounded.

### ⚠ Warning

## Important Safety Instruction

- ⚠ Keep ventilation openings, in the appliance enclosure or in the built-in structure, clear of obstruction.
- ⚠ Do not use mechanical devices or other means to accelerate the defrosting process, other than those recommended by the manufacturer.
- ⚠ Do not damage the refrigerant circuit.
- ⚠ Do not use electrical appliances inside the food storage compartments of the appliance, unless they are of the type recommended by the manufacturer.
- ⚠ The refrigerant and insulation blowing gas used in the appliance require special disposal procedures. When disposal, please consult with service agent or a similarly qualified person.



This appliance contains a small amount of isobutane refrigerant (R600a), natural gas with high environmental compatibility, but it is also combustible. When transporting and installing the appliance, care should be taken to ensure that no parts of the refrigerating circuit are damaged. Refrigerant squirting out of the pipes could ignite or cause an eye injury. If a leak is detected, avoid any naked flames or potential sources of ignition and air the room in which the appliance is standing for several minutes.

In order to avoid the creation of a flammable gas air mixture if a leak in the refrigerating circuit occurs, the size of the room in which the appliance may be sited depends on the amount of refrigerant used. The room must be 1m<sup>2</sup> in size for every 8g of R600a refrigerant inside the appliance. The amount of refrigerant in your particular appliance is shown on the identification plate inside the appliance.

Never start up an appliance showing any signs of damage. If in doubt, consult your dealer.

## Important Safety Instruction

### ⚠ Caution

- If the wall socket is loose, do not insert the power plug.  
It may cause electric shock or fire.
- Never unplug your refrigerator by pulling on the power cord. Always grip plug firmly and pull it straight out from the outlet.  
You may disconnect a wire and cause a short circuit.
- Do not use a wet or damp cloth when cleaning the plug. Remove any foreign matter from the power plug pins.  
Otherwise, there is a risk of fire.
- After unplugging the appliance, wait for at least five minutes before plugging it again to the wall socket.  
Abnormal operation of the freezer may cause material damage.
- If the appliance is not to be used for a long time, pull out the power plug.  
Any deterioration in the insulation may cause fire.
- Do not let children touch or play with the control panel on the front of the appliance.
- The refrigerant used in fridge/freezer and the gases in the insulation material require special disposal procedures. Ensure that none of the pipes on the back of the appliances are damaged prior to disposal.

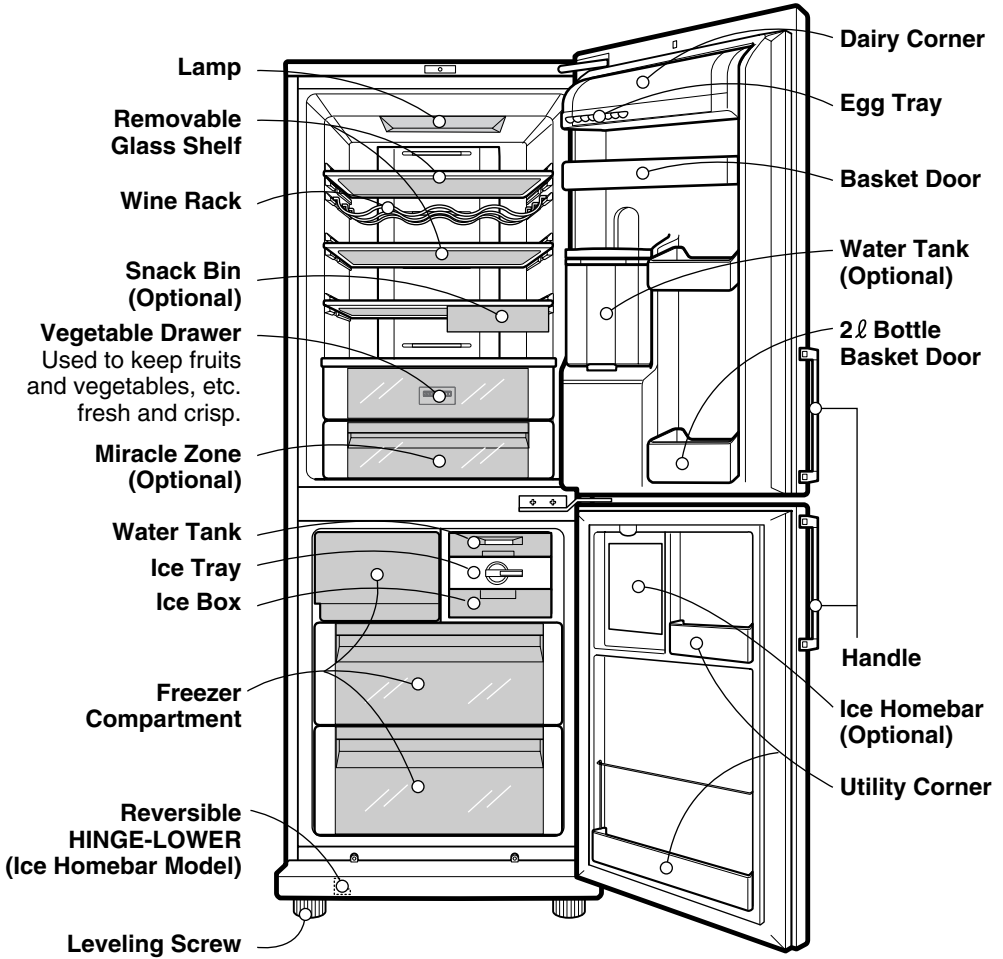

# Identification of Parts



**Note**

If you find some parts missing from your unit, they may be parts only used in other models. (i.e. the "Miracle Zone" is not included in all models)

## Installation

1. Select a good location.  
Place your fridge-freezer where it is easy to use.
2. Avoid placing the unit near heat sources, direct sunlight or moisture.
3. To ensure proper air circulation around the fridge - freezer, please maintain sufficient space on both the sides as well as top and maintain at least 2 inches (5 cm) from the rear wall.
4. To avoid vibration, the unit must be leveled.  
If required, adjust the leveling screws to compensate for the uneven floor.  
The front should be slightly higher than the rear to aid in door closing.  
Leveling screws can be turned easily by tipping the cabinet slightly.  
Turn the leveling screws counterclockwise(  ) to raise the unit, clockwise(  ) to lower it.
5. Clean your fridge-freezer thoroughly and wipe off all dust accumulated during shipping.
6. Install accessories such as ice cube box, etc., in their proper places. They are packed together to prevent possible damage during shipment.
7. Connect the power supply cord (or plug) to the outlet.  
Don't double up with other appliances on the same outlet.

## Starting

When your fridge-freezer is installed, allow it 2-3 hours to stabilize at normal operating temperature prior to filling it with fresh or frozen foods.

If power plug is disconnected, allow 5 minutes delay before restarting.

Your fridge-freezer is now ready for use.



## Temperature Control

Your fridge-freezer has controls that let you regulate the temperature in the fridge and freezer compartments.

## Display Panel For Temperature Control

Adjusting the temperatures and functions

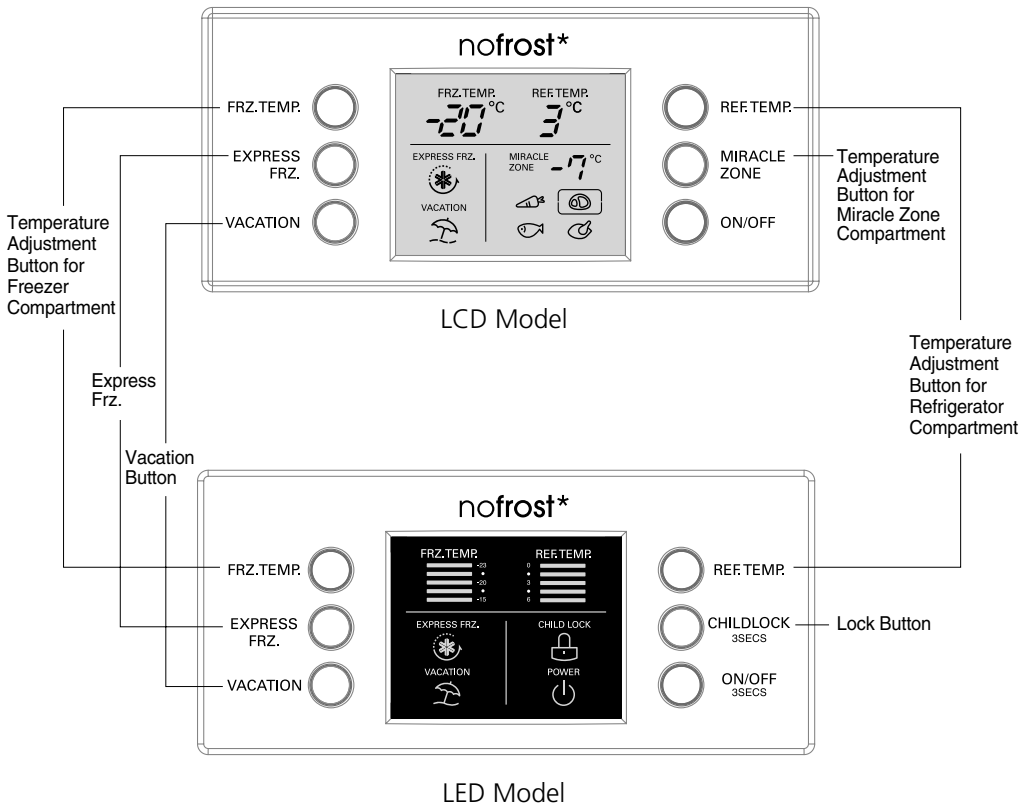

## Note

All adjust function of LCD Model is operated after pressing any button.

## How to adjust the temperature in the refrigerator and freezer compartment

- The initial Temperature of the Freezer and Refrigerator Compartment is -20°C and 3°C respectively. You can now adjust the temperature of the compartments as you want.

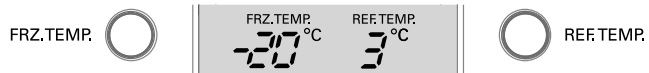

LCD Model

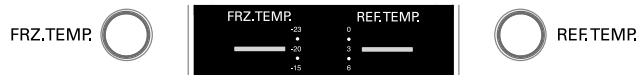

LED Model

## Note

The actual inner temperature varies depending on the food status, as the indicated setting temperature is a target temperature, not actual temperature within refrigerator.

Refrigeration function is weak in the initial time. Please adjust temperature as above after using refrigerator for minimum 2~3 days.

## Miracle Zone Temperature Transition Corner (Optional)

- By pressing the button, store vegetables, fruits (at relatively low conservation temperature) or other types of food such as meat to be defrosted, raw fish, etc.

### Method to Use

- You can select optimum temperature range depending on types of food stored.

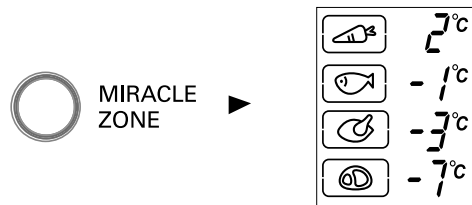

- 4 step of temperature selection including 2°C, -1°C, -3°C, and -7°C is available.  
Vegetables/fruits and cold storage foods requiring humidity maintenance and meats/fishes can be more freshly stored depending on type of foods stored.

## Express Frz.

- Please select this function for prompt freezer.
- This function is used when you want to freeze the foods quickly. Press the EXPRESS FRZ. button once, and then the quick freeze operation starts with the lamp lit.
- The EXPRESS FRZ. operation takes about 3 hours. When its operation ends, it automatically returns to the previous temperature setting. If you want to stop the quick freeze operation, press the EXPRESS FRZ. button once more, the lamp goes out, and the EXPRESS FRZ. operation stops and the refrigerator returns to the previous temperature setting.



LCD Model



LED Model

- The arrow mark graphic remains at the On status after flickering for 4times when selecting EXPRESS FRZ. is turned "On".

## Vacation

- This function makes the fridge-freezer work in a power saving mode which is useful for when you are away on holiday, by reducing energy consumption as much as possible. Pressing 'VACATION' starts operation with lamp ON and pressing it again stops the operation.



LCD Model



LED Model

### Note

When the Vacation mode is "ON", the other buttons will not operate. When you come back from vacations, press the vacation mode off so that other buttons work and the refrigerator returns to previous temperature setting.

## Self Test

- This function automatically detects failure when failure is found in product during the use of refrigerator.
- If the failure occurs at product and it does not operate by pressing any button and normal indication is not done, do not turn the power off and immediately contact with the local service center.
- A lot of time is needed for service engineer to detect the failed part by turning it off.

## Lock

### For LED Model

- Pressing this button stops operation of other buttons.
- "Locking" or "Un-Locking" is repeated whenever pressing the LOCK button.  
(For "Locking" press the "LOCK" button for 3 secs.  
For "Un-Locking" press the "LOCK" button for 1 secs.)
- When 'LOCK' is activated, pressing the other buttons would not work.



## On/Off

- Pressing this button refrigerator power is ON or OFF.
- ON or OFF is repeated whenever pressing the ON/OFF button.  
(For "OFF" press the "ON/OFF" button for 3 secs.  
For "ON" press the "ON/OFF" button for 1 secs.)

## Vita Light (Optional)

- LED lamp is operated automatically for all day. It may makes vegetable to photosynthesize.

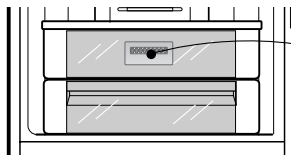

Vita Light  
(LEDs are located at the rear of the vegetable drawer)

- Viewing the laser out put with certain optical instruments (e.g. telescopes, binoculars, glasses, magnifyier) may pose an eye hazard.
- The LEDs will operate automatically. Do not uncover the LEDs. Contact qualified service technician if there is any failure in LEDs.

## ⚠ Caution

- Use of controls or adjustments or performance of procedures other than those specified herein may result in hazardous radiation exposure.

## Door Alarm

- When the door of the fridge is left opened for a while, the alarm sounds.  
Please contact with the local service center if warning continue to sound even after closing the door.

## Ice Making

- Take out the water container, fill it up and put it back to it's original location.

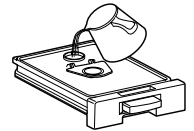
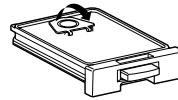
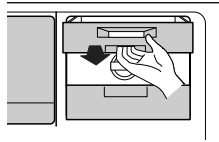

- If you close Freezer Door or push Water tank button, Water falls to the ice making compartment.
- Ice will be dropped into the ice storage bin by rotating Ice separation handle of ice making compartment.

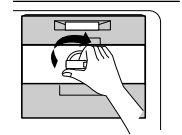
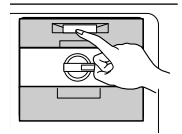

## Note

- Rotating the ice separation handle before ice is fully frozen may cause the remaining water drop into the ice storage bin to lump the ice together.
- Take the ice out of the ice storage bin for use but do not pour water into the ice storage bin to freeze the water to ice. The ice storage bin can freeze to break.
- When the ice is full, it is designed for the ice to fall to the bottom in case the ice storage bin can not pulled out. Be careful not to store the ice too full.

## Ice Homebar (Optional)

- Push the upper point of Homebar until 'click' Sound is produced.
- After opening Ice Homebar, It is possible to use ice, making compartment and ice storage bin.

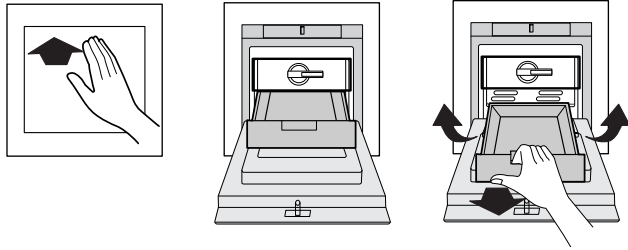

## ⚠ Caution

- Never place heavy items on the ice homebar door or allow children to hang on. (Not only can the ice homebar door may be damaged, but also children may be hurt.)

## Defrosting

- Defrosting takes place automatically.
- The defrosting water flows down to the evaporating tray and is evaporated automatically.



## Water Dispenser (Optional)

### Features

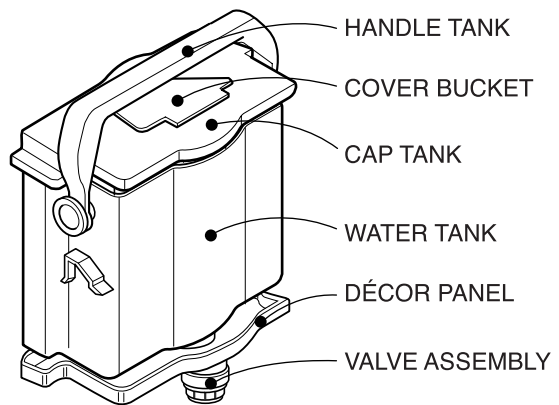
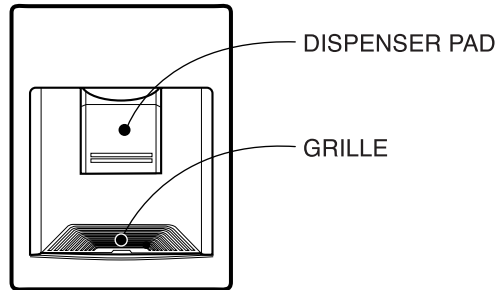

### Install

- Please assemble the VALVE ASSEMBLY after correctly adjusting it with a DOOR HOLE.

## Filling of WATER TANK

1. After turning the HANDLE Tank backward with the WATER TANK installed at the DOOR, Open the COVER BUCKET and then fill water using a kettle etc.
  - \* Fill water while watching a sight glass on the front of the WATER TANK.
  - \* Water up to 3ℓ can be filled.
2. Press and fix the COVER BUCKET.
3. After filling spring water, fix the HANDLE TANK at a proper position.

## Filling of PET Bottle

1. Insert the valve assembly into the cover of a PET bottle. (Height of PET ; Below 310MM)
2. Assemble the PET bottle on the door.
3. Make a hole for air-inflow on the top of the PET bottle.

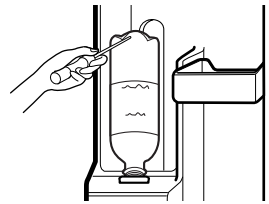

## ⚠ Caution

When integrating the valve assembly, please proceed it after checking if the rubber packing inside is correctly assembled or not.

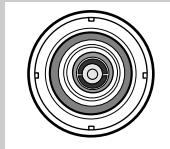

O

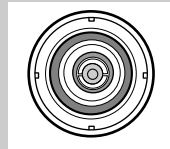

X

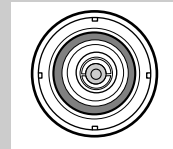

X

## Drinking

1. Press the Dispenser Pad with a cup.
2. If pressing the Pad, water inside of the Dispenser is supplied.
3. If slowly removing a cup from the Pad, water will not fall down.

## ⚠ Caution

Do not use other beverage (milk, juice, carbonated beverage etc) than spring water. Especially beverage including grain must not be used (may result in failure).

## Wine Rack (Optional)

- Bottles can be stored laterally with this wine corner. Then you can invert the wine rack and place it on the shelf. This will enable more shelf-place.

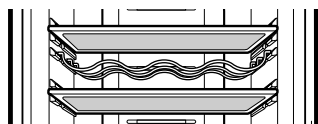

ex) in using

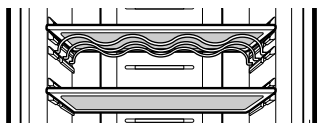

ex) in not using

### Storing Food

#### ⚠ Caution

- Do not store food which goes bad easily at low temperature, such as banana, and melon.
- Allow hot food to cool prior to storing. Placing hot food in the fridge-freezer could spoil other food, and lead to higher electric bills.
- When storing the food, use a container with a lid. This prevents moisture from evaporating, and helps food to keep its taste and nutrients.
- Do not block air vents with food. Smooth circulation of cold air keeps fridge-freezer temperature even.
- Do not open the door frequently. Opening the door lets warm air enter the fridge-freezer, and cause temperature to rise.
- Never keep too many foods in door rack, as this may stop the door from fully closing.
- Do not store bottles in the freezer compartment - they may break when frozen.
- Do not refreeze food that has been thawed. This causes loss of taste and nutrition.
- Do not store pharmaceutical products, scientific materials or other temperature sensitive products in the refrigerator.  
Products that require strict temperature controls must not be stored in the refrigerator.

- If you want to quick freeze new food, you put it middle drawer of freezer compartment, and then press the EXPRESS FRZ. button.

### Note

If you keep the fridge-freezer in a hot, and humid place, frequently open its door or put a lot of vegetables in it, dew may form in it, which has no effect on its performance.

Remove the dew with dust cloth free from care.

## General Information

### Power Failure

- 1~2 hour power failure does no harm to the foods stores. Try to avoid opening and closing the door too frequently.

### If You Move

- Take out foods from the fridge-freezer and firmly fix the loose items with tape.
- Turn the leveling screws until they stop before moving the fridge-freezer. Otherwise the screw may scratch the floor or the fridge-freezer cannot move.

### Anti Condensation Pipe

- The Anti-Condensation pipe is installed around the front side of fridge-freezer as well as on the partition between fridge compartment and freezer compartment to prevent dewing.

### Anti-Condensation Pipe

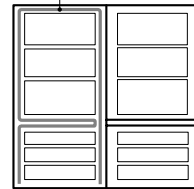

- Especially after installation or when ambient temperature is high, the fridge-freezer may feel hot, which is quite normal.

## Lamp Replacement

1. Unplug the power cord from the outlet.
2. Remove the room lamp lid by taking down while pulling its back projection.
3. Remove the lamp by turning it counterclockwise and replace new one.
4. Assemble in reverse order of disassembly. Replacement bulb must be the same specification as original.

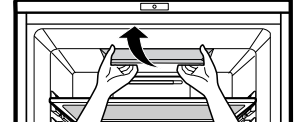

### ⚠ Caution

- You must check the O-RING, which is made by rubber and prevent electric spark.
- Don't touch the lamp, in case of light on the long time. Because it can be very hot.

### Note

- Lamp capacity is MAX 30W.
- The lamp will remain "ON" for 7minutes if the door is left open and then it is "OFF" for safety. (If you reopen the door, the lamp is "On".)

## To Reverse the Doors

### ⚠ Caution

- Your fridge-freezer is designed with reversible doors, do that they may open from either the left of right hand side to suit your kitchen design.

However, When you want to reverse the doors, you must be calling to service agent.

### Cleaning

#### Before Cleaning

Be sure to unplug the power.

#### Exterior

Clean the outside of the fridge-freezer with a soft cloth soaked with hot water or liquid detergent. If you use a detergent, be sure to wipe it with a clean wet cloth.

#### Interior

As above.

#### After Cleaning

Check that the power cord is not damaged, power plug has not overheated, and that the power plug is tightly inserted into the outlet.

#### Warning

Be sure to dry the appliance with a cloth after washing it with water.

Do not use abrasive, petroleum, benzene, thinner, hydrochloride acid, boiling water, rough brush, etc, as they may damage parts of the fridge-freezer.



## **GRILLE and DRIP TRAY**

1. Remove the HOLE part of the GRILLE with the finger.
2. Wipe moisture out around the DOOR part and the DRIP TRAY using a clean cloth.

## **Exterior Dispenser**

Wipe moisture etc out outside of Dispenser and on the Dispenser Pad using a cloth.

## **Water Tank**

1. Lift the WATER TANK up by pressing the fixing LEVER on the bottom of WATER TANK and then remove it.
2. After removing the CAP TANK, clean and fully rinse the inside/outside part of the WATER TANK by using neutral cleansing agent.

## **Cap Tank & Cover Bucket**

Clean and fully rinse the CAP TANK & COVER BUCKET by using neutral cleansing agent.

Especially for the groove part of the CAP TANK, it is convenient to cleanse it by using a small brush.

## **Valve Assembly**

Clean and fully rinse the VALVE ASSEMBLY by using a small brush. Rinse it while operating the bottom part of the valve assembly. Always fix the Sealing Rubber separated for cleansing at the existing position (may result in water leakage).

**Before calling for service, check this list. It may save you both time and expense. This list includes common occurrences that are not the result of defective workmanship or materials in this appliance.**

<b>Problem</b>	<b>Possible Causes</b>
<b>Fridge-Freezer does not operate</b>	<ul style="list-style-type: none"><li>• Power plug may be unplugged from the electric outlet. Plug it in securely.</li><li>• House fuse has blown or circuit breaker has tripped. Check and/or replace fuse and reset circuit breaker.</li><li>• Power cut. Check house lights.</li></ul>
<b>Fridge or Freezer Compartment Temperature too warm</b>	<ul style="list-style-type: none"><li>• Temperature control not set on proper position. Refer to Temperature Control section.</li><li>• Appliance is placed close to heat source.</li><li>• Warm weather-frequent door openings.</li><li>• Door left open for a long time.</li><li>• Package holding door open or blocking air duct in freezer compartment.</li></ul>
<b>Vibration or Rattling or Abnormal Noise</b>	<ul style="list-style-type: none"><li>• The floor on which the fridge-freezer is installed may be uneven or the fridge-freezer may be unstable. Make it even by rotating the leveling screw.</li><li>• Unnecessary objects placed in the back side of the fridge-freezer.</li></ul>
<b>Frost or Ice Crystals on frozen Food</b>	<ul style="list-style-type: none"><li>• Door may have been left ajar or package holding door open.</li><li>• Too frequent or too long door openings.</li><li>• Frost within package is normal.</li></ul>
<b>Moisture forms on Cabinet Surface</b>	<ul style="list-style-type: none"><li>• This phenomenon is likely to occur in a wet space. Wipe it with a dry towel.</li></ul>

## Problem

## Possible Causes

### Moisture collects inside

- Too frequent or too long door openings.
- In humid weather, air carries moisture into fridge when doors are opened.

### Fridge has odor

- Foods with strong odors should be tightly covered or wrapped.
- Check for spoiled food.
- Interior needs cleaning.  
Refer to CLEANING section

### Door not closing properly

- Food package is keeping door open.  
Move packages that keep door from closing.
- Fridge-freezer is not level.  
Adjust the leveling screws.
- The floor on which the fridge-freezer is installed may be uneven or the fridge-freezer may be unstable.  
Slightly raise the front side with the leveling screw.

### Interior light does not work

- No power at outlet.
- Light lamp needs replacing.  
Refer to the Lamp Replacement section



## DISPOSAL OF YOUR OLD APPLIANCE

1. When this crossed-out wheeled bin symbol is attached to a product it means the product is covered by the European Directive 2002/96/EC.
2. All electrical and electronic products should be disposed of separately from the municipal waste stream via designated collection facilities appointed by the government or the local authorities.
3. The correct disposal of your old appliance will help prevent potential negative consequences for the environment and human health.
4. For more detailed information about disposal of your old appliance, please contact your city office, waste disposal service or the shop where you purchased the product.



---

LG Twin Tower, 20, Yoido-Dong, Youngdungpo-Gu, Seoul, 150-721, Korea.  
<http://www.lge.co.kr>