



LAC7700R/7710R

ENGLISH	CAR CD/MP3/WMA Receiver Read the manual carefully before using the unit
GERMAN	Auto-CD-/MP3-/WMA-Receiver Lesen Sie diese Bedienungsanleitung vor Gebrauch des Gerätes sorgfältig durch
FRENCH	Récepteur CD/MP3/WMA pour voiture Veuillez lire attentivement le présent manuel avant d'utiliser l'appareil.
SPANISH	Receptor de CD/MP3/WMA para coche Lea atentamente este manual antes de iniciar el uso de la unidad.
ITALIAN	Lettore CD/MP3/WMA per auto Leggere attentamente questo manuale prima di usare l'unità.



P/NO : MFL36538207

Safety note



CAUTION
RISK OF ELECTRIC SHOCK
DO NOT OPEN



CAUTION : TO REDUCE THE RISK OF ELECTRIC SHOCK DO NOT SPLIT COVER(OR BACK) NO USER SERVICEABLE PARTS INSIDE. REFER SERVICING TO QUALIFIED SERVICE PERSONNEL.



The lightning flash with the arrowhead symbol, within an equilateral triangle is intended to alert the user about the presence of uninsulated dangerous voltage within the product's enclosure that may be of sufficient magnitude to constitute a risk of electric shock.



The exclamation point within an equilateral triangle is intended to alert the user to the presence of important operating and maintenance (servicing) instructions in the literature accompanying the appliance.



Always operate the vehicle in a safe manner. Do not become distracted by the vehicle while driving, and always be fully aware of all driving condition. Do not change settings, or any functions. Pull over in a safe and legal manner before attempting such operations.



Do not use for many hours at extremely low or high temperature. (-10~60°C)



To reduce the risk of electric shock, do not remove the cover or back of this product. There are no user-serviceable parts inside. Refer servicing to qualified service personnel.



To reduce the risk of fire or electric shock, do not expose this product to dripping or splashing water, rain, or moisture.



The temperature of unit's outside can be extremely high, please use the unit after proper installation in your vehicle.

CAUTION : This product uses a Laser System.

To ensure proper use of this product, please read this owner's manual carefully and retain it for future reference.

Should the unit require maintenance, contact an authorized service center.

Performing controls, adjustments, or carrying out procedures other than those specified herein may result in hazardous radiation exposure.

To prevent direct exposure to laser beam, do not try to open the enclosure. Visible laser radiation when open. **DO NOT STARE INTO BEAM.**

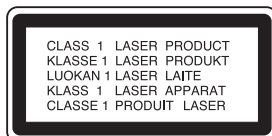



- A defective or soiled disc inserted into unit can cause sound to drop out during playback.
- Handle the disc by holding its inner and outer edges.
- Do not touch the surface of the unlabeled side of the disc.



Do not stick paper or tape etc. on the surface.



Do not expose the disc to direct sunlight or excessive heat.



This unit cannot play 8cm disc (use 12cm disc only).



- Clean the disc before playback. Wipe the disc from the center outward with a cleaning cloth.
- Never use solvents such as benzene or alcohol to clean the disc.

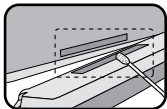

Periodically wipe the contacts on the back of the control panel with a cotton swab moistened with alcohol.

Bluetooth®

Bluetooth® wireless technology is a system which allows radio contact between electronic devices within a max. range of 10 meters.

Connecting individual devices under *Bluetooth*® wireless technology does not incur any charges. A mobile phone with *Bluetooth*® wireless technology can be operated via the Cascade if the connection was made via *Bluetooth*® wireless technology.

The *Bluetooth*® word mark and logos are owned by the *Bluetooth*® SIG, Inc. and any use of such marks by LG Electronics is under license.

Other trademarks and trade names are those of their respective owners.

Operating condition for using a Bluetooth function

- Close windscreen.
- Turn off the air conditioner/ heater.
- Stop the vehicle or drive at low speed.
- Make the call in a quiet location.
- There may be differences in call quality depending on phone type, road conditions weather, etc.
- Using the phone while driving may cause unexpected accidents.
- The Bluetooth function may not operate properly with certain types of Bluetooth phones.

A section whose title has one of the following symbols is applicable only to the disc represented by the symbol.

 Audio CDs  MP3 files  WMA files

MP3/WMA Disc compatibility with this unit is limited as follows:

1. Sampling Frequency / 8 - 48kHz (MP3) 22.05 - 48kHz (WMA)
2. Bit rate / within 8 - 320kbps (include VBR) (MP3) 32 -320kbps (WMA)
3. CD-R/CD-RW file system should be "ISO 9660"
4. If you record MP3/WMA files using software which cannot create a FILE SYSTEM, for example "Direct-CD" etc., it will not be possible to playback MP3/WMA files. We recommend that you use "Easy-CD Creator" which creates an ISO9660 file system.

Customers should also note that permission is required in order to download MP3/WMA files and music from the Internet. Our company has no right to grant such permission. Permission should always be sought from the copyright owner.



Disposal of your old appliance

1. When this crossed-out wheeled bin symbol is attached to a product, it means the product is covered by the European Directive 2002/96/EC.
2. All electrical and electronic products should be disposed of separately from the municipal waste stream via designated collection facilities appointed by the government or the local authorities.
3. The correct disposal of your old appliance will help prevent potential negative consequences for the environment and human health.
4. For more detailed information about disposal of your old appliance, please contact your city office, waste disposal service or the shop where you purchased the product.



This product is manufactured to comply with Directive 2005/83/EEC(ANNEX I , 3.2.9), 72/245/EEC, and 2006/95/EC.

Table of contents

Safety note	.2-4
Table of contents	.4
Before use	.5
Control panel	.6
Remote control	.6-7
Installation	.7
Connection diagram	.8-9
Basic operation	.10-13
Bluetooth operation	.14-18
Radio operation	.18-19
RDS operation	.19-20
CD/MP3/WMA operation	.20-22
Aux operation	.22
Troubleshooting	.23
Specifications	.23-24
Bluetooth phone compatibility list	.24

Before use

Detaching the control panel

You can detach the control panel when leaving the car.

When detaching or attaching the control panel, be careful not to damage the connectors on the back of the control panel and on the panel holder.

1. Press the “” button to unlock the control panel.
2. Push the control panel to right.
3. Pull the control panel out of the unit.
4. Put the detached control panel into the protective case.

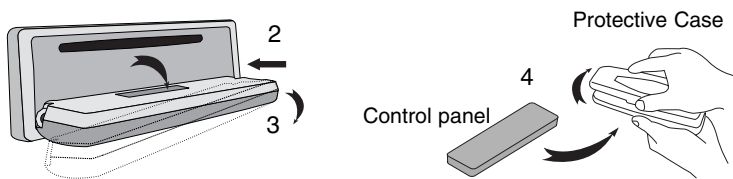

Attachable control panel

1. Attach part **A** of the control panel to part **B** of the unit.
2. Attach part **C** of the control panel to part **D** of the unit while pushing the control panel to right.
3. Close the control panel.

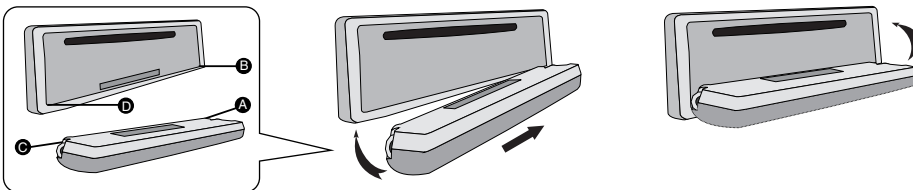

Caution

- When detaching or attaching the control panel, do not press the display or control buttons.
- The control buttons may not work properly if the control panel is not attached properly. If this occurs, gently press the control panel.
- Do not leave the control panel in any area exposed to high temperatures or direct sunlight.
- Do not drop the control panel or otherwise subject it to strong impact.
- Do not allow such volatile agents as benzine, thinner, or insecticides to come into contact with the surface of the control panel.
- Do not try to disassemble the control panel.

Control panel

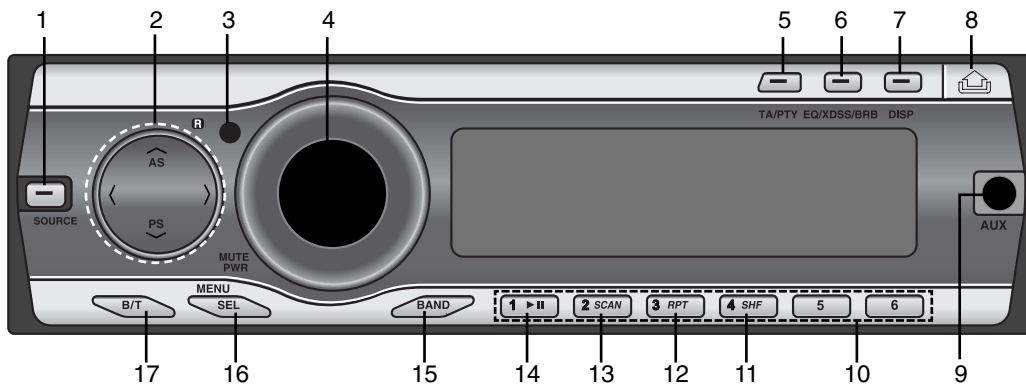

- | | | |
|---|---|---|
| <p>1 [SOURCE]</p> <p>2 • Skip / Search </></p> <ul style="list-style-type: none"> • Seek/ Tune • Auto Store [AS] • Preset Scan [PS] • MP3 Track +10/-10 ▲▼ MP3 WMA • Folder Up/Down ▲▼ MP3 WMA <p>3 Remote Sensor</p> <p>4 • Volume</p> <ul style="list-style-type: none"> • [MUTE] • Power [PWR] | <p>5 • Traffic Announcement [TA]</p> <ul style="list-style-type: none"> • Programme Type [PTY] <p>6 • Equalizer [EQ]</p> <ul style="list-style-type: none"> • Extreme Dynamic Sound System [XDSS] • Bass Reverb Blaster [BRB] <p>7 Display [DISP]</p> <p>8 Release/Eject </p> <p>9 AUX In [AUX]</p> <p>10 Preset Station [1~6]</p> <p>11 Shuffle [SHF]</p> | <p>12 Repeat [RPT]</p> <p>13 Intro Scan [SCAN]</p> <p>14 Play/Pause >/II</p> <p>15 [BAND]</p> <p>16 • [MENU]</p> <ul style="list-style-type: none"> • Select [SEL] <p>17 Bluetooth [B/T]</p> |
|---|---|---|

Remote control

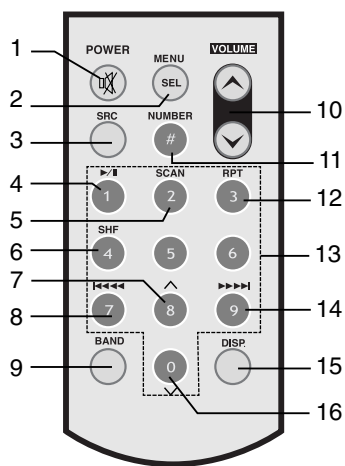

- | | |
|---|---|
| <p>1 Power [POWER] / Mute </p> <p>2 Select [MENU/SEL]</p> <p>3 Source [SRC]</p> <p>4 Play / Pause >/II</p> <p>5 Intro Scan [SCAN]</p> <p>6 Shuffle [SHF]</p> <p>7 • MP3 Track +10</p> MP3 WMA <p>8 • CD Skip / Search</p> <ul style="list-style-type: none"> • Seek / Tune I<<<< • Seek / Tune I<<<< <p>9 [BAND]</p> <p>10 Volume Up ^ / Down v</p> <p>11 Number [#]</p> <p>12 Repeat [RPT]</p> | <p>13 Number [0-9]</p> <p>14 • CD Skip / Search</p> <ul style="list-style-type: none"> >>>> • Seek / Tune >>>> <p>15 Display [DISP.]</p> <p>16 • MP3 Track -10</p> MP3 WMA <ul style="list-style-type: none"> • Folder Down v MP3 WMA |
|---|---|

Battery Installation

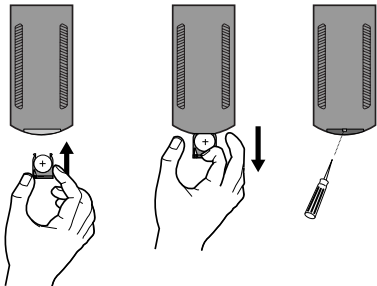

- 1 Remove the battery holder with a sharp product like a ball point pen.
- 2 Install the battery on the battery holder.
- 3 Install the battery holder back into its original position.

Note

- Use only one CR2025 (3V) lithium battery.
- Remove the battery if the remote control is not used for a long period of time.
- Do not leave the product in a hot or humid place.
- Do not handle the battery with metallic tools.
- Do not store the battery with metallic materials.

Installation

Basic Installation

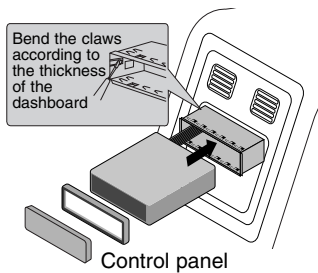

Before installing, make sure that the ignition-switch is set to OFF and remove the terminal of the car battery to avoid short-circuiting.

- 1 Remove the existing receiver unit.
- 2 Make the necessary connections.
- 3 Install the installation sleeve.
- 4 Install the unit into the installation sleeve.

Removing the existing receiver unit

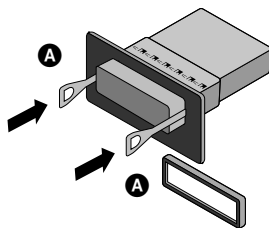

If there is already an installation sleeve for the receiver unit in the dashboard, it must be removed.

- 1 Remove the rear support from the unit.
- 2 Remove the control panel and trim ring from the unit.
- 3 Insert the lever **A** into the hole on one side of the unit. Perform the same operation on the other side and pull the unit out from the mounting sleeve.

ISO-DIN Installation

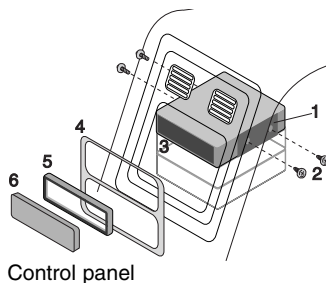

- 1 Slide the unit into the ISO-DIN frame.
- 2 Fit screws removed from the old unit.
- 3 Slide the unit and frame into the dash opening.
- 4 Install the dash panel or adapter plate.
- 5 Install the trim ring to the unit.
- 6 Install the control panel to the unit.

Connection diagram

Before connecting, make sure that the ignition switch is set to OFF, and remove the battery ⊖ terminal to avoid short circuits.

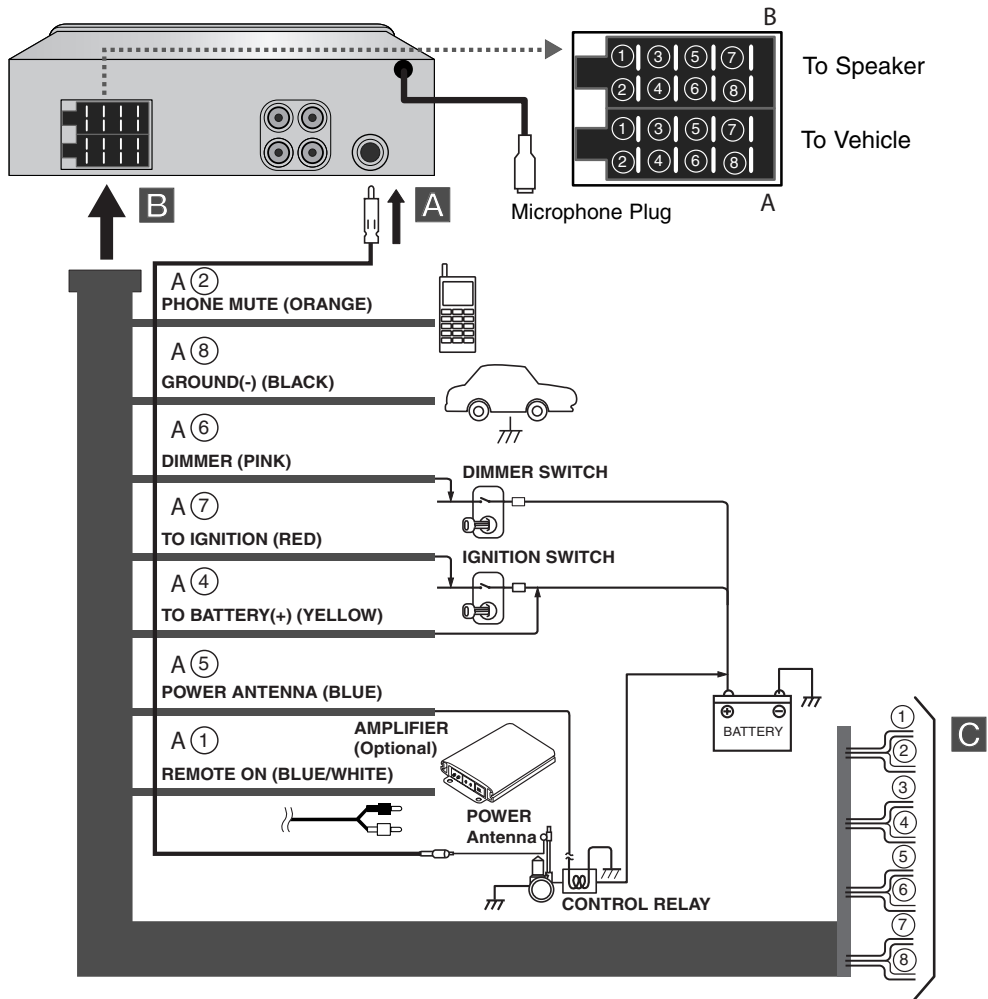

- B ①. Violet : Rear Right +
- B ②. Violet/ Black Stripe : Rear Right -
- B ③. Gray : Front Right +
- B ④. Gray / Black Stripe : Front Right -
- B ⑤. White : Front Left +
- B ⑥. White/Black Stripe : Front Left -
- B ⑦. Green : Rear Left +
- B ⑧. Green/ Black Stripe : Rear Left -

A From antenna

B To the wiring of the vehicle colors of leads.

- **BLACK:** This lead is for the ground connection.
- **ORANGE:** This lead is for the phone line connection.
- **PINK:** This lead is for the dimmer line connection.
- **RED:** This lead is for connection to the power supply terminal when the ignition switch is set to ACC.
- **YELLOW:** This lead is for connection to the battery (back-up) terminal from which power is always supplied.
- **BLUE:** This lead is for the power antenna connection.
- **BLUE/WHITE:** This lead is for the remote amplifier on connection.

C Speaker Connections

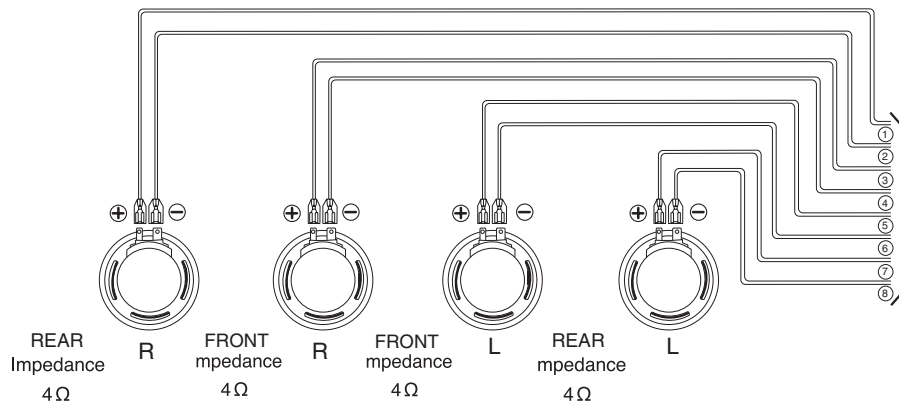

Connecting to Auxiliary Equipment (Optional)

Connect the **AUDIO OUTPUT** jack of this unit to the **AUDIO INPUT** jack of the Auxiliary Equipment.

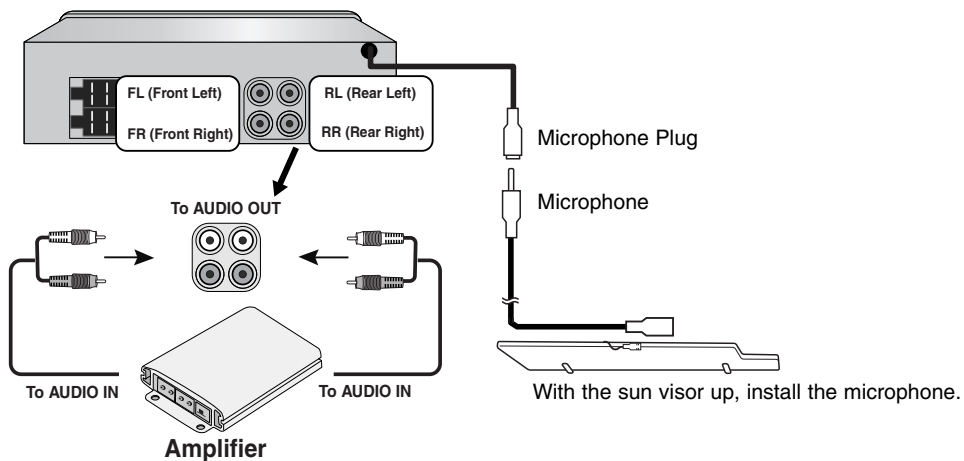

Basic operation

Turning the unit on

Press **MUTE/PWR** (**POWER**/  on the remote control) or any other button.

 **Note**

When you insert the CD in the CD slot, the unit turns on.

Turning the unit off

Press and hold **MUTE/PWR** (**POWER**/  on the remote control).

Insert a disc

- 1 Press  to open the control panel.
- 2 Draws the disc, and starts playback automatically.

Eject a disc

Press  to open the control panel. The disc automatically ejects from the loading slot.

When the disc is ejected by pressing  during playback, it will be loaded automatically after 10 seconds unless you pull out disc from the unit.

Selecting a source



Press **SOURCE** repeatedly to select a source.

The indicator lights up in the following order. TUNER → CD → AUX → TUNER...

 **Note**

You cannot select a source if it is not ready.

Adjusting the volume

Rotate **MUTE/PWR** (Press **VOLUME**   on the remote control) to adjust the sound level.

 **Note**

When you turn the unit off, the current volume level is automatically memorized. Whenever you turn the unit back on, it will operate at the memorized volume level.

Mute

- 1 Press **MUTE/PWR** (**POWER**/  on the remote control) to cut the sound.
- 2 To cancel it, press again.

Checking the clock

You can see the clock pressing **DISP** (**DISP.** on the remote control).

Changing the general settings

- 1 Press and hold **MENU/SEL** (**MENU/SEL** on remote control) so that one of menu items appears.
- 2 Press **MENU/SEL** (**MENU/SEL** on remote control) to scroll between menus.
AF ON → REG ON → TA ALARM → PI SOUND → AUX ON → AUX 00dB → DEMO ON → BEEP 2ND
- 3 Rotate **MUTE/PWR** clockwise or unclockwise to select one of the settings specified belows.
(Press **VOLUME** ^ v on the remote control.)
- 4 Press and hold **MENU/SEL** (**MENU/SEL** on remote control) to finish the setting.

● **AF(Alternative frequency) ON / OFF**

When the reception quality drops, the tuner automatically changes to another station in the network, broadcasting a better reception quality, using the PI and AF codes.

AF ON :

wherever you drive, you can continue to listen to the same program without interruptions.

AF OFF :

Only station name will be displayed. In case of poor reception no alternative station can be used.

● **REG (Region) ON / OFF**

REG ON :

The unit switches to another station, within the same network, broadcasting the same program when the receiving signals from the current station become weak.

REG OFF :

The unit switches to another station, within the same network when the receiving signals from the current station become weak. (This mode, the program may differ from the one currently received.)

● **TA(Traffic Announcement) ALARM / SEEK**

TA ALARM :

When a newly tuned station has no TP information for 5 seconds, a double beep sound is output.

TA SEEK :

When the newly tuned station does not receive TP information for 5 seconds, the receiver retunes to the next station which has the same PI as the last station, but has the TP information.

● **PI (Programme Identification) SOUND / MUTE**

PI SOUND :

If the sound of a station with different PI is heard intermittently, the receiver mutes the sound after 1 second.

PI MUTE :

If the sound of a station with different PI is heard intermittently, the receiver mutes the sound right now.

- **AUX (Auxiliary) ON / OFF**

It is possible to use auxiliary equipment with this unit. Activate the auxiliary setting when using auxiliary equipment connected to this unit.

- **AUX ON**

- When using a auxiliary equipment.

- **AUX OFF**

- When not using a auxiliary equipment.

- **AUX (Auxiliary) 00dB / +6dB**

You can adjust the volume level of each source to prevent radical changes in volume when switching between sources.

You can set to 0 dB or +6 dB

If the input level of the connected component is not high enough, increase the input level properly. Without adjusting the line input level, you may be surprised at a loud sound when you change the source from the external component to another source.

- **DEMO ON / OFF**

You can change the initial indication on the display to information name (function name, EQ name, etc...) while listen to a source.

- **DEMO ON**

- Displays information name while listening to source.

- **DEMO OFF**

- Cancels the function.

- **BEEP 2ND / ALL**

Sets the beep sound every time a button is pressed.

- **BEEP 2ND**

- The beep is generated when a key is long pressed. (1 sec)

- **BEEP ALL**

- The beep is generated when any key is pressed.

Using the EQ (Equalizer)

Press **EQ/XDSS/BRB** repeatedly. The indicator lights up in the following order.

Pop → Classic → Rock → Jazz → Vocal → Salsa → Samba → User1 → User2 → Off

- Pop : Optimized for R&B, Soul and Country music.
- Classic : Optimized for orchestral music.
- Rock : Optimized for Hard Rock and Heavy Metal music.
- Jazz : Sweet sound with soft feeling.
- Vocal : Powerful realism with strong sound quality.
- Salsa : Reproduces salsa music acoustics.
- Samba : Reproduces samba music acoustics.
- User1 : Use the menu to set the sound level you want.
- User2 : Use the menu to set the sound level you want.

You can adjust each sound level to your preference. Once you select a USER mode and then make an adjustment, it automatically stored for the currently selected USER mode.

Refer to the "Adjusting the sound level" on the page 13.

Adjusting the sound level

- 1 Press **MENU/SEL** (**MENU/SEL** on the remote control) repeatedly to select the mode you want to adjust from volume, bass, middle, treble, balance and fader.
The indicator lights up in the following order.
VOL → BAS → MID → TRB → BAL → FAD
- 2 Rotate the **MUTE/PWR.** (Press **VOLUME** ^ v on the remote control) to adjust the sound quality.

Indication	Turn right	Turn left
VOL	Increase the volume level.	Decrease the volume level.
BAS	Increase the bass level.	Decrease the bass level.
MID	Increase the middle level.	Decrease the middle level.
TRB	Increase the treble level.	Decrease the treble level.
BAL	Decrease the level of the left speaker(s).	Decrease the level of the right speaker(s).
FAD	Decrease the level of the front speaker(s).	Decrease the level of the rear speaker(s).

Note

When EQ, BRB or XDSS+ is set to "Off", you can adjust the sound level (BAS, MID, TRB) settings.

XDSS+ (Extreme Dynamic Sound System)

- 1 Press and hold **EQ/XDSS/BRB**.
- 2 Each time you press and hold the button, the modes change as follows.
XDSS+ → BRB (TBB → 3D → SBB)
XDSS+ : Improve the treble, bass sound.

BRB (Bass Reverb Blaster)

- 1 Press and hold **EQ/XDSS/BRB**.
- 2 Each time you press and hold the button, the modes change.
- 3 Press **EQ/XDSS/BRB** repeatedly to select sub BRB.
 - TBB (Turbo-Bass Blaster) : Improve the bass sound to make it spectacular.
 - 3D (3D-TremD Blaster) : Positions audio effects real time in 3D space.
 - SBB (Sound field Boost Blaster) : Extremely wide stereo imaging and improved low frequency bass.

Bluetooth operation



Using a Bluetooth wireless connection

Your unit supports Bluetooth wireless connections. You can set up a wireless link with Bluetooth phone.

Starting Bluetooth on your phone

Your phone's Bluetooth feature may be set to off by default. To use your car Bluetooth feature, Bluetooth must be turned on in your phone.

Note

Refer to your phone's user guide.

Pairing your unit and Bluetooth phone

Pairing links your unit and Bluetooth phone, and is required only once for the initial setup. Before you start the pairing procedure, make sure the Bluetooth feature is turned on in to your Bluetooth phone. Refer to your Bluetooth phone's user guide.

- 1 Press and hold **B/T** to connect your Bluetooth phone.
If connecting through a Bluetooth phone, the handsfree connection or headset connection may operate depending on the type of phone.
With connection via Bluetooth technology, HFP (Hands Free Profile) is prioritized over HSP (Head Set Profile).
- 2 The unit displays the PIN code enter screen. PIN : 1234
- 3 The unit may request permission to bond with your phone.
The  indicator flashes.
To cancel, press and hold **B/T** again.
- 4 You can set up a wireless link with Bluetooth phone.
Refer to your phone's user guide.
- 5 The Bluetooth phone displays the device name, select the device.
- 6 The Bluetooth phone displays the PIN code enter screen, enter the PIN code 1234.
- 7 If the connection is successful, the Bluetooth phone is registered (Device 1–5).
- 8 When your unit successfully paired with your Bluetooth phone, the flashing of indicator stops.

Note

- Your unit keeps lists of pairing you recently connected. A maximum of 5 pairing numbers can be saved.
- Unlike the Hands-free functionality, Headset connection will allow only two functions "answering calls" and "making a call from the latest call".

Changing the Bluetooth settings

- 1 Press **B/T** so that one of menu items appears.
- 2 Press **▲/AS** or **▼/PS** to scroll between menus.
Connection ↔ BT Setting
- 3 Press **B/T** to enter the "BT Setting" menu.
- 4 Press **▲/AS** or **▼/PS** up or down to scroll between sub menus.
Auto Connection On ↔ Auto Answer On ↔ HF VOL
- 5 Press **<** or **>** left or right to select the settings of your choose.

- **Auto Connection On / Off**

- ON :**

- Bluetooth phone with a previous record showing that it has successfully connected will automatically start the connection process when starting the car.

- OFF :**

- Cancels the function.

- **Auto Answer On / Off**

- ON :**

- If you set the automatic answering function on, hands-free answering call is possible.

- OFF :**

- Cancels the function.

- **HF VOL (Setting range : 0~35)**

- After connected, it is necessary to adjust the volume of Bluetooth's voice.

- It is possible to adjust the volume using the **VOL./MUTE/PWR** button when talking on the phone.

Connecting a Bluetooth phone

After being registered, it is necessary to connect your Bluetooth phone from this unit.

- 1 Press **B/T** to enter the "Connection" menu.
- 2 Press **B/T** to connect a Bluetooth phone to this unit.
The message "Connect?" is displayed.
- 3 Press **B/T** again.
While connecting, the "Connected" is displayed.

 **Note**

- Your unit keeps lists of pairing you recently connected. A maximum of 5 pairing numbers can be saved.

Disconnecting a Bluetooth phone

It is possible to disconnect your Bluetooth phone from this unit.

- 1 Press **B/T** so that one of menu items appears.
- 2 Press **▲/AS** or **▼/PS** up or down to select the message "Discon?".
- 3 Press **B/T** to disconnect a Bluetooth phone from the unit.

Answering and Ending a call

Your unit, Bluetooth phone, or both may ring when you receive a call, press **B/T** to answer a call. To end a call, press and hold **B/T**.

 **Note**

If the Call-ID service is available, the caller's phone number is displayed.

Rejecting a call

When your unit rings, press and hold **B/T**.

 **Note**

If "REJECT" function is unusable, then the phone connected to the device does not support the reject call function.

Missed call notification

When an incoming call is not answered, the missed call message is displayed on the your screen.

- 1 The “ ? ” appears on the screen.
- 2 Press **B/T** to place a call.
- 3 Press **B/T** to place a call to entered phone number.
- 4 To end the call and hang up the phone, press and hold **B/T** button.

Auto transfer

It is possible to select the automatic connection between your Bluetooth phone and this unit.

- 1 Press **B/T** to answer the call.
- 2 Press **B/T** again.

The “Private” is displayed.

If the private mode is selected on the unit, press **B/T** to return to the call to hands-free mode. (This feature is only available on phones with Hands-free profile.)

Or press and hold **B/T** to return to the call to hands-free mode. (This feature is only available on phones with Headset profile.)

Making a call from the latest call : Last call?

Your phone keeps a lists of your recently received and dialed even if the calls did not connected. The lists are sorted from newest to oldest entries.

Your unit keeps recorded of your recently received and dialed on phone.

- 1 Press **B/T** to place a call.
- 2 Press **B/T** to place a call to entered phone number.

The “Calling” appears on the screen.

There is case that sending is done by pressing **B/T** button for a long time depending on type of Bluetooth phone. (For basic setting, press **B/T** button shortly.)

Note

- When you want to make an international call, press **>** to add “+”.
press **<** to delete “+”.
- “+” can only be added when the detail list of Missed call, Dialed call or Received call is selected.

Dial using a number from the last answered :

Your unit keeps a record of your recently received and display.

- 1 Press **B/T** to enter the menu.
- 2 Press **▲/AS** or **▼/PS** up or down to select the call number.
- 3 Press **B/T** to place a call to entered phone number.

The “Calling” appears on the screen.

Note

- When you want to make an international call, press **>** to add “+”.
press **<** to delete “+”.
- “+” can only be added when the detail list of Missed call, Dialed call or Received call is selected.

Storing a call number in last answered.

If you press any of the preset button 1~6, you can easily store up to 6 phone numbers and later recall with the press the button.

- 1 Press **B/T** to enter the menu.
- 2 Press **▲/AS** or **▼/PS** up or down to select the call number.
- 3 Press one of preset buttons 1~6 and hold until the beep sound.
The "Save to.." appears on the screen.
- 4 The selected phone number has been stored in memory.
The next time, you press the same preset button, the phone number is recalled from memory.

Making a call from the preset list

It is possible to make a call from the preset phone number list.

- 1 Press **B/T** to enter the menu.
- 2 Press the preset button 1~6, the phone number is recalled from memory.
- 3 Press **B/T** to place a call.

Pairing your unit and Bluetooth device (MP3 Player, MP3 Phone...)

When you activate your Bluetooth device's linked unit, you can listen to MP3 with wireless connections.

The method of use for a Bluetooth device is the same as when using a Bluetooth phone.

- Refer to the page 14 for details.

Playing MP3 files

When you turn Bluetooth on, your Bluetooth device displays "Bluetooth" on the home screen.

The Bluetooth remains on until you turn the device off.

Press **SOURCE** repeatedly to select Bluetooth.

The indicator lights up in the following order.

TUNER → CD → AUX → BT → TUNER...

To play an MP3 file stored on your Bluetooth device, refer to your Bluetooth device's user guide.

Bluetooth Profiles

In order to use Bluetooth technology, devices must be able to interpret certain profiles.

This unit is compatible with following profiles.

GAP (Generic Access Profile)

HSP (Hands Set Profile)

HFP (Hands Free Profile)

GAVDP (Generic Audio/Video Distribution Profile)

A2DP (Advanced Audio Distribution Profile)

AVDTP (Audio/Video Distribution Transport Profile)

AVRCP (Audio/Video Distribution Remote Control Profile)

GAP

GAP is short for Generic Access Profile. This is a basic profile of Bluetooth wireless technology.

HFP

HFP is short for Hands-Free Profile. This profile is used for hands-free phoning with the devices featuring Bluetooth wireless technology.

HSP

HSP is short for Head Set Profile. This profile is used for connecting a headset and for communicating terminal wireless technology.

GAVDP

This profile uses an Initiator (INT), a device (such as a portable player) that initiates a signalling procedure to send a request to an Acceptor (ACP), - such as headphones etc. Although this profile specifies signalling transaction procedures between two devices to set up, terminate and reconfigure streaming channels, using GAVDP alone, it is required to use GAVDP in combination with profiles that depend on this profile - the AVRCP and the VDP.

A2DP

Mobile phones and devices with A2DP high quality stereo bluetooth profile.

This profile is based on the GAVDP, and allows advanced audio to be transmitted (audio streaming) from a Source (SRK) - such as a CD player, to a Sink (SNK), such as headphones.

AVRCP

Based on the GAP Profile, this uses a Controller (CT) - PDA, computer mobile phone etc., which sends a command to a Target (TG) - TV, discman, headphone etc. The command can be to Play, record, colour control, volume control etc., depending on the nature of the devices involved and the scenario. The commands are transported by a new additional protocol, called the Audio/Video Control Transport Protocol (AVCTP). Some scenarios defined are Remote Control from a Separate Controller, Remote Control and Audio Stream Between Two Devices, and Remote Controller with LCD.

Radio operation

Listening to radio stations

- 1 Press **SOURCE** to select the tuner.
- 2 Press the **BAND** repeatedly to select a band.
The indicator lights up in the following order. FM1 → FM2 → FM3 → MW(AM)
- 3 **Auto Search** : Press </> (I◀◀◀/▶▶▶I on the remote control).
When a station is received, searching stops.
Manual Search : Press and hold </> (I◀◀◀/▶▶▶I on the remote control) until "MANUAL" appears, and then press it repeatedly.
The frequencies move up or down step by step.

Storing and recalling broadcast frequencies

You can easily store up to 6 broadcast frequencies for later recall at the touch of a button.

- 1 Press **BAND** to select desired band you want to store.
- 2 Select the desired frequency.
- 3 Press one of preset buttons 1~6 and hold until the beep sound.
The number you have pressed will flash in the preset number indicator and then remain lit. The selected radio station frequency has been stored in memory.
- 4 Repeat steps 1 ~ 3 to preset other stations.
The next time, you press the same preset button, the radio station frequency is recalled from the memory.

Note

- Up to 18 FM stations, 6 for each of three FM bands and 6 MW(AM) stations can be stored in the memory.
- When a station is stored on the preset numbers on which another station of the same band has already been preset, the previously preset station is automatically erased.

Auto search memory

This function lets you automatically store the 6 strongest broadcast frequencies.

- 1 Press **▲/AS** until "AUTO STORE" appears.
The six strongest broadcast frequencies will be stored under preset button 1~6 in the order of their signal strength.
- 2 To cancel, press **▲/AS**.

To scan the preset stations

Press **▼/PS**. Each preset station appears. To cancel, press **▼/PS**.

To tune in the preset stations

Press **BAND** to select the desired band and press the desired preset button 1~6
The preset station of the preset button 1~6 is displayed and the preset station is received.

RDS operation

RDS Display options

In normal RDS operation the display will indicate the station name. Pressing **DISP** enables you to cycle through the various data types in the following sequence:

CT → FREQUENCY → PTY → RT → PS

- **CT** (Time controlled by the channel)
- **PTY** (Programme type recognition)
- **RT** (Radio text recognition)
- **PS** (Programme Service name)
- **PI** (Programme Identification)
- **AF** (Alternative Frequencies for the actual programme)
- **TP** (Traffic programme Identification)
- **TA** (Traffic Announcement Identification)

PTY (Programme Type) function

To select a certain program type out of the reception band, the following procedure can be used.

- 1 Press and hold **TA/PTY** to select a programme types.
- 2 After, press and hold **TA/PTY** repeatedly for selecting each mode.
Music group → Speech group → Search off
- 3 Press one of preset buttons 1~6
Each time this button is pressed, the display mode changes as follows.

No	Music group	No	Speech group
1.	Pop M, Rock M	1.	News, Affairs, Info
2.	Easy M, Light M.	2.	Sport, Educate, Drama
3.	Classics, Other M	3.	Culture, Science, Varied
4.	Jazz, Country	4.	Weather, Finance, Children
5.	Nation M, Oldies	5.	Social, Religion, Phone In
6.	Folk M	6.	Travel, Leisure, Document

Note

RDS is only available for FM reception.

TA (Traffic Announcement) function

TA reception allows the unit to switch temporarily to a Traffic Announcement from the current source (another FM station, CD, or other connected components).

To switch the TA (Traffic Announcement) function on or off, press **TA/PTY**.

• **TA ON**

Traffic programs and announcements can be automatically received using TP/TA features.

• **TA OFF**

Traffic programs and announcements can not be received using TP/TA features.

CD/MP3/WMA operation

Playing an Audio CD and MP3/WMA Disc

The unit can play MP3/WMA formatted recordings on CD-ROM, CD-R or CD-RW discs.

Before playing MP3/WMA recordings, read the notes on MP3/WMA Recordings on page 4.

If you change the source, CD play also stops (without ejecting the CD). Next time you select "CD" as the source, CD play starts from where playback has been stopped previously.

- To directly play a file, press **NUMBER (#)** on remote control and then press the track number with **0-9** number.

Pause

1 Press **▶/||** during playback.

2 To return to playback, press **▶/||** again.

Skip to next track/file

Press briefly **>** (**▶▶▶▶** on the remote control) to select the next track or file.

Skip to previous track/file

Press briefly **<** (**◀◀◀◀** on the remote control) within 3 seconds of playing time.

Return to the beginning of the current track/file

Press briefly **<** (**◀◀◀◀** on the remote control) after 4 seconds of playing time.

Search

Press and hold **</>** (**◀◀◀◀/▶▶▶▶** on remote control) for about 1 second during playback and then release at the point you want.

Intro scan

The first 10 seconds of each tracks/files (**SCAN**) or each files in the current selected folder (**SCAN**) on the disc are played.

- 1 Press **SCAN**.
 - **SCAN** **MP3** **WMA** (or **SCAN** **CD**) appears on the display window.
Press and hold **SCAN** for about 2 seconds during playback.
 - **SCAN** appears on the display window. **MP3** **WMA**
- 2 Press **SCAN** again.
 - **SCAN** or **SCAN** disappear from the display window and the intro scan is cancelled.

Repeat

The current selected tracks/files (**RPT**) or folder (**RPT**) on the disc is played repeatedly.

- 1 Press **RPT** during playback.
 - **RPT** appears on the display window. **CD** **MP3** **WMA**
- 2 Press and hold **RPT** for about 2 seconds during playback.
 - **RPT** appears on the display window. **MP3** **WMA**
- 3 Press **RPT** again.
 - **RPT** or **RPT** disappear from the display window and the repeat mode is cancelled.

Shuffle

All of the tracks/files (**SHF**) or the current selected folder (**SHF**) on the disc is played randomly.

- 1 Press **SHF** during playback.
 - **SHF** **MP3** **WMA** (or **SHF** **CD**) appears on the display window.
Press and hold **SHF** for about 2 seconds during playback.
 - **SHF** appears on the display window. **MP3** **WMA**
- 2 Press **SHF** again.
 - **SHF** or **SHF** disappear from the display window and the random playback is cancelled.

Note

During random playback, if you press < (**I** **◀** **◀** on remote control), you won't go back to the previous track.

CD TEXT / ID3 TAG **CD** **MP3** **WMA**

When playing a disc containing information, you can see the CD TEXT/ID3 TAG information.

In CD TEXT, information about the disc (disc title, performer and track title) is recorded.

In a ID3 TAG, information about the file (album title, performer name, song title) is recorded.

In a WMA Content, information about the file (song title, performer name) is recorded.

If there is no information, "NO TEXT" will be shown in the display window.

Press **DISP** repeatedly during MP3/WMA/CD TEXT file playback.

To go to a particular quickly (+10/-10 buttons) **MP3 WMA**

(If there is no folder or one folder.)

Press **N/AS** (**Λ** on remote control) to skip to the next 10 track, and press **V/PS** (**V** on remote control) to skip to the previous 10 track.

To skip to the next or previous folder **MP3 WMA**

(If there are more than two folders.)

Press **N/AS** (**Λ** on remote control) to skip to the next folder, and press **V/PS** (**V** on remote control) to skip to the previous folder.

Note

Time display appearing on the display part when playing VBR file may vary and there may be some difference from actual time (both progress time and VBR are displayed at the same time when playing file).

AUX operation

Playing an Auxiliary Equipment

You can connect Auxiliary Equipment to this unit.

Connect one to the external device jack using the line input cable (not supplied), and the other to the AUX input jack on the control panel.

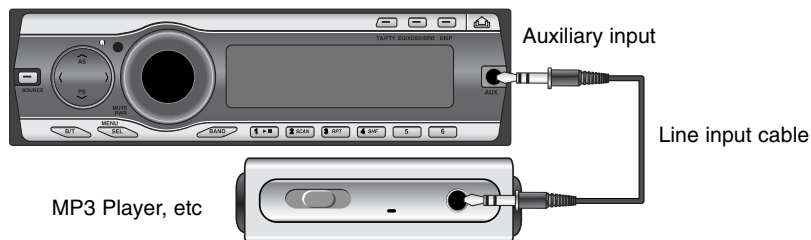

- 1 Press **SOURCE** to select the AUX as source.
AUX IN appears in the display.
- 2 Turn on the connected Auxiliary Equipment and start playing the source.
- 3 Adjust the volume.

Note

- Before operating the Auxiliary Equipment using the following procedure, select the external input correctly. (Refer to the page 12 for details.)
- If the input level of the Auxiliary Equipment connected to the AUX input jack is not high enough, adjust the input level properly. (Refer to the page 12 for details.)

Troubleshooting

Sy : Symptom / **Ca** : Cause
Co : Correction

Sy Power doesn't turn on. / The unit doesn't operate.

Ca Leads and connectors are not properly connected.

Co Confirm once more that all connections are correct.

Ca The fuse is blown.

Co Rectify the problem that caused the fuse to blow, and then replace it. Be very sure to install the correct fuse with the same rate.

Ca Noise and other factors are causing the built-in microprocessor to operate incorrectly.

Co Turn the unit off and then on.

Sy Playback is not possible.

Ca The disc is dirty.

Co Clean disc.

Ca The loaded disc is of a type this unit cannot play.

Co Check what type the disc.

Sy No sound is heard. / The volume level will not rise.

Ca Cables are not connected correctly.

Co Connect the cables correctly.

Sy There's no sound.

Ca The volume level is low.

Co Adjust the volume.

Sy There's audio skipping.

Ca This unit is not firmly secured.

Co Secure this unit firmly.

Sy The unit does not operate correctly even when the appropriate remote control buttons are pressed.

Ca Battery power is low.

Co Load new battery.

Specifications

GENERAL

Output Power	.50W x 4CH (Max.)
Power Source	.DC 12V
Speaker impedance	.4Ω
Ground System	.Negative
Dimensions (W x H x D)	.180 x 51 x 171 mm (Without Control Panel)
Net Weight	.1.5 kg

CD SECTION

Frequency Response	.20 Hz-20 kHz
S/N Ratio	.85 dB
Distortion	.0.05%
Channel Separation (1kHz)	.60 dB

RADIO SECTION

FM

Frequency Range	.87.5-107.9 or 87.5-108 MHz
S/N Ratio	.53 dB
Distortion	.0.7%
Usable Sensitivity	.12 dBμV

AM (MW)

Frequency Range	.520-1720 or 522-1620 kHz
S/N Ratio	.45 dB
Distortion	.1.0%
Usable Sensitivity	.28 dBμV

AUX SECTION

Frequency Response20 Hz-20 kHz
 S/N Ratio80 dB
 Distortion0.05 %
 Channel Separation (1kHz)45 dB
 Max Input Level (1kHz)1.2 V (35 KΩ)

BLUETOOTH SECTION

TX POWER4 dBm
 Frequency Range2400-2483.5 MHz
 VersionBluetooth 2.0 certified

Bluetooth phone compatibility list

Bluetooth list and manufacturing company applicable NR : Not Recommended
 NC : Not Compatible

Company List		Company List		Company List	
Nokia	3230	Motorola	6060	Sony-	K750i (NR)
	3250		A1000	Ericsson	K800i (NR)
	3650		A760 (NR)		P990i (NR)
	5300		A780i (NR)		S700i
	5500		E1000		T610
	6021		E1070 (NR)		T628
	6103		E680 (NR)		V600i
	6131		E680i (NR)		V800
	6230		KRZR K1 (NR)		W550i
	6230i		L6		W710i (NR)
	6233		L7		W810i
	6270		RAZA V3i		W850i (NR)
	6280		ROKR E2 (NR)		Z600
	6600		U6		Z608
	6630		V360	Siemens	EF81
	6650		V3ROHS (NR)		S65
	6670		V3X (NR)		SK65
	6680		V500		SL75
	6681		V525		SX1
	6820a		V600i		SXG75
	7370	Samsung	SGH-D500	Panasonic	X800
	7600		SGH-D600	Sazem	myX6-2
	7610		SGH-D820	Pantech	PG8000 (NR)
	8800		SGH-D900		PG6200
	8910i		SGH-E788	NEC	N850
	9500		SGH-E900		N930
	E50		SGH-X820		N730 (NR)
	E61		SGH-Z540V	Blackberry	7130v (NC)
	E62	LG	KG245		8070v
	E70		KG800	SHARP	GX15
	N71		M4410 (NR)		
	N73		U890		
	N80				
	N90				
	N93				
	N-Gage				
	N-Gage QD				