



# PLASMA MONITOR

---

MODELS: 71PY1M  
71PY1MG  
71PY1MC

## OWNER'S MANUAL



**Please read this manual carefully before operating your set.  
Retain it for future reference.  
Record model number and serial number of the set.  
See the label attached on the back cover and quote  
this information to your dealer  
when you require service.**

P/NO : MFL36274103(0611-REV01)  
Printed in Korea

# Safety Instructions

## **WARNING**

**Do not place the set in direct sunlight or near heat sources such as heat registers, stove and so on.**

- This may cause a fire.

**Do not use the set in damp place such as a bathroom or any place where it is likely to get wet.**

- This may cause a fire or could give an electric shock.

**Bend antenna cable between inside and outside building to prevent rain from flowing in.**

- This may cause water damaged inside the set and could give an electric shock.

**Earth wire should be connected.**

- If the earth wire is not connected, there is possible a danger of electric shock caused by the current leakage.
- If grounding methods are not possible, a separate circuit breaker should be employed and installed by a qualified electrician.
- Do not connect ground to telephone wires, lightning rods or gas pipe.

**Do not place anything containing liquid on top of the set.**

- This may cause a fire or could give an electric shock.

**Do not insert any object into the exhaust vent.**

- This may cause a fire or could give an electric shock.

**Do not place heavy objects on the set.**

- This may cause serious injury to a child or adult.

**Do not use water while cleaning the set.**

- This may cause damaged the set or could give an electric shock.

**In case of smoke or strange smell from the set, switch it off ,unplug it from the wall outlet and contact your dealer or service center.**

- This may cause a fire or could give an electric shock.

**Do not attempt to service the set yourself. Contact your dealer or service center.**

- This may cause damaged the set or could give an electric shock.

**During a lightning thunder, unplug the set from the wall outlet and don't touch an antenna cable.**

- This may cause damaged the set or could give an electric shock.

## **WARNING in U.K. only**

- \* This set is supplied with a BS 1363 approved 13 amp mains plug, fused at 13 amp. When replacing the fuse always use a 13 amp BS 1362, BSI or ASTA approved type. Never use this plug with the fuse cover omitted. To obtain a replacement fuse cover contact your dealer or "LG Electronics U.K. Ltd." If the type of plug supplied is not suitable for the mains sockets in your home, then the plug should be removed and a suitable type fitted. A mains plug removed from the mains lead of this set must be destroyed. A mains plug with bared wires is hazardous if inserted in a mains socket. Do not connect either wire to the earth pin, marked with the letter E or with the earth symbol  or coloured green or green and yellow. If any other plug is fitted, use a 13 amp fuse, either in the plug, or at the distribution board. The wires in this mains lead are coloured in accordance with the following codes: **BLUE: NEUTRAL, BROWN: LIVE** As the colours of the wires in the mains lead of this set may not correspond with the coloured marking identifying the terminals in your plug, proceed as follows: The wire which is coloured blue must be connected to the terminal which is marked with the letter N or coloured black. The wire which is coloured brown must be connected to the terminal which is marked with the letter L or coloured red.

## **WARNING/CAUTION**

TO REDUCE THE RISK OF FIRE AND ELECTRIC SHOCK, DO NOT EXPOSE THIS PRODUCT TO RAIN OR MOISTURE.

\* Safety instructions have two kinds of information, and each meaning of it is as below.



**WARNING** The violation of this instruction may cause serious injuries and even death.



**NOTES** The violation of this instruction may cause light injuries or damage of the product.

 Take care of danger that may happen under specific condition.

## NOTES

**Never touch the power plug with a wet hand.**

- This may cause an electric shock.

**Disconnect from the mains and remove all connections before moving.**

**Do not place the set in a built-in installation such as a bookcase or rack.**

- Ventilation required.

**When installing the set on a table, be careful not to place the edge of its stand.**

- This may cause the set to fall, causing serious injury to a child or adult, and serious damage to the set.

**Do not place an outside antenna in the vicinity of overhead power lines or other electric light or power circuits.**

- This may cause an electric shock.

**There should be enough distance between an outside antenna and power lines to keep the former from touching the latter even when the antenna falls.**

- This may cause an electric shock.

**Do not pull the cord but the plug when unplugging.**

- This may cause a fire.

**Ensure the power cord doesn't trail across any hot objects like a heater.**

- This may cause a fire or an electric shock.

**Do not plug when the power cord or the plug is damaged or the connecting part of the power outlet is loose.**

- This may cause a fire or an electric shock.

**Dispose of used batteries carefully to protect a child from eating them.**

- In case that it eats them, take it to see a doctor immediately.

**When moving the set assembled with speakers do not carry holding the speakers.**

- This may cause the set to fall, causing serious injury to a child or adult, and serious damage to the Monitor.

**Unplug this product from the wall outlet before cleaning. Do not use liquid cleaners or aerosol cleaners.**

- This may cause damaged the set or could give an electric shock.

**Contact the service center once a year to clean the internal part of the set.**

- Accumulated dust can cause mechanical failure.

**The distance between eyes and the screen should be about 5 ~ 7 times as long as diagonal length of the screen.**

- If not, eyes will strain.

**Unplug the set from the wall outlet when it is left unattended and unused for long periods of time.**

- Accumulated dust may cause a fire or an electric shock from deterioration or electric leakage.

## Safety Instructions continued

### CAUTION concerning the Power Cord :

- **Most appliances recommend they be connected to a dedicated circuit; that is, a single outlet circuit which powers only that appliance and has no additional outlets or branch circuits.**

- This may cause a fire or an electric shock.

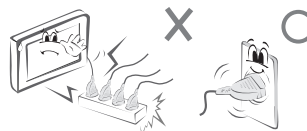

- Do not overload wall outlets. Overloaded wall outlets, loose or damaged wall outlets, extension cords, frayed power cords, or damaged or cracked wire insulation are dangerous. Any of these conditions could result in electric shock or fire. Periodically examine the cord of your appliance, and if its appearance indicates damage or deterioration, unplug it, discontinue use of the appliance, and have the cord replaced with an exact replacement part by an authorized servicer.
- Protect the power cord from physical or mechanical abuse, such as being twisted, kinked, pinched, closed in a door, or walked upon. Pay particular attention to plugs, wall outlets, and the point where the cord exits the appliance.
- Use a dedicated power cord. Do not modify or extend the power cord.
- Do not install, remove, or reinstall the unit by yourself (customer).  
For electrical work, contact the dealer, seller, a qualified electrician, or an Authorized Service Center. For installation, always contact the dealer or an Authorized Service Center.
- Do not use if the power cord or plug is damaged, or socket is loose. Use a dedicated outlet for this appliance.
- Do not over bend the power cord and do not place anything on the power cord. Do not install the monitor near any sharp edge to avoid wire damage.

### Outdoor Use Marking :

- WARNING - To Reduce The Risk Of Fire Or Electric Shock, Do Not Expose This Appliance To Rain Or Moisture.

### Wet Location Marking :

- Apparatus shall not be exposed to dripping or splashing and no objects filled with liquids, such as vases, shall be placed on the apparatus.

### Safety instruction (71PY1MG only)

- When the trim becomes dirty or stained, softly polish the surface.
- When polishing the surface, use gentle pressure. Heavy pressure can damage or discolor the surface.
- When polishing the surface, use a soft cloth with the alcohol. If not, it may cause damage or discolor the surface.
- Clean the surface quickly and use gentle pressure. Heavy pressure can damage or discolor the surface.
- Do not use anything to scrape or scratch at the surface of this unit, this will cause damage to the surface.
- Use soft gloves while installing or removing this unit to prevent damaging the surface.

# Contents

Safety Instructions	2~4	Screen Menu Options	
<b>Introduction</b>		Auto Adjustment	28
Accessories	7	Setting Picture Format	28
Controls and Connection Options	8~9	Cinema Mode Setup	29
Remote Control Key Functions	10~11	Screen Position	29
<b>Installation</b>		Manual Configure	30
Installation Instructions	12	Initializing	30
External Equipment Connections	13~17	Black level adj.	31
VCR Setup	13	PC/DTV Mode	31
Cable TV Setup	14	Screen Adjustments	32
External A/V Source Setup	14	NR(Noise Reduction)	32
DVD Setup	15	PIP (Picture-in-Picture) Feature	
DTV Setup	15	Watching PIP	33
PC Setup	16~17	PIP Size	33
<b>Operation</b>		PIP Transparency	33
Turning on the Monitor	18	Moving the PIP	33
Menu Language Selection	18	Selecting an Input Signal Source for the PIP	33
Picture Menu Options		DW Setup Options	
Auto Picture Control (APC)	19	Watching DW	34
XD	19	Sub Picture Size Adjustment	34
Auto Color Temperature Control	19	Swapping the DW	34
Fleshstone	20	Selecting a Source for the DW	34
sRGB	20	<b>External Control Device Setup</b>	35~40
Manual Picture Control	21	<b>IR Code</b>	41~42
Sound Menu Options		<b>Programming the remote</b>	43
DASP (Digital Auto Sound Processing)	22	<b>Programming Codes</b>	44~45
Manual Sound Control	22	<b>Troubleshooting Checklist</b>	46
BBE	23	<b>Product Specifications</b>	47
AVL (Auto Volume Leveler)	23		
Timer Menu Options			
Clock Setup	24		
On/Off Timer Setup	24		
Auto Off	25		
Sleep Timer	25		
Special Menu Options			
Key Lock	26		
ISM Method	26		
Low power	27		
Index	27		

After reading this manual,  
keep it handy for future  
reference.



## Disposal of your old appliance

1. When this crossed-out wheeled bin symbol is attached to a product it means the product is covered by the European Directive 2002/96/EC.
2. All electrical and electronic products should be disposed of separately from the municipal waste stream via designated collection facilities appointed by the government or the local authorities.
3. The correct disposal of your old appliance will help prevent potential negative consequences for the environment and human health.
4. For more detailed information about disposal of your old appliance, please contact your city office, waste disposal service or the shop where you purchased the product.

# Introduction

## What is a Plasma Display Panel?

If voltage is applied to gas within glass panels, ultraviolet rays are produced and fused with a fluorescent substance. At that instant, light is emitted. A Plasma Display is a next generation flat Display using this phenomenon.

## 160° - Wide angle range of vision

Your flat panel plasma screen offers an exceptionally broad viewing angle -- over 160 degrees. This means that the display is clear and visible to viewers anywhere in the room.

## Wide Screen

The screen of the Plasma Display is 71" so wide that your viewing experience is as if you are in a theater.

## Multimedia

Connect your plasma display to a PC and you can use it for conferencing, games, and internet browsing. The Picture-in-Picture feature allows you to view your PC and video images simultaneously.

## Versatile

The light weight and thin size makes it easy to install your plasma display in a variety of locations where conventional TVs would not fit.

## The Plasma Monitor Manufacturing Process: Why minute colored dots may be present on the Plasma Monitor screen

The Plasma Display Panel which is the display device of this product is composed of 0.9 to 2.2 million cells. A few cell defects will normally occur in the Plasma Monitor manufacturing process. Several minute colored dots visible on the screen should be acceptable. This also occurs in other Plasma Monitor manufacturers' products and the tiny dots appearing does not mean that this Plasma Monitor is defective. Thus a few cell defects are not sufficient cause for the Plasma Monitor to be exchanged or returned. Our production technology is designed to minimize cell defects during the manufacture and operation of this product.

## Cooling Fan Noise

In the same way that a fan is used in a PC computer to keep the CPU (Central Processing Unit) cool, the Plasma Monitor is equipped with cooling fans to cool the Monitor and improve its reliability. Therefore, a certain level of noise could occur while the fans are operating and cooling the Plasma Monitor.

The fan noise doesn't have any negative effect on the Plasma Monitor's efficiency or reliability. The noise from these fans is normal during the operation of this product. We hope you understand that a certain level of noise from the cooling fans is acceptable and is not sufficient cause for the Plasma Monitor to be exchanged or returned.

### **WARNING**

TO REDUCE THE RISK OF FIRE AND ELECTRIC SHOCK, DO NOT EXPOSE THIS PRODUCT TO RAIN OR MOISTURE.

## Accessories

Ensure that the following accessories are included with your plasma display. If an accessory is missing, please contact the dealer where you purchased the product.

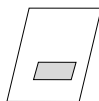

Owner's Manual



Batteries



Remote Control



D-sub 15 pin cable



Power Cord

2- ferrite cores  
(for the speaker cables)Polishing Cloth  
Polish the screen with the  
cloth.  
(71PY1MG only)

Slightly wipe stained spot on the exterior only with the cleansing cloths for the product exterior if there is stain or fingerprint on surface of the exterior.

Do not wipe roughly when removing stain. Please be cautious of that excessive power may cause scratch or discoloration.

### Use the ferrite core with the speaker cables

The ferrite core given as a bundled accessory can be used to reduce the electromagnetic waves in the connection to the speakers. Wind the speaker cable on the ferrite core twice, and then plug the cables into the monitor and the speakers as shown in the following picture:

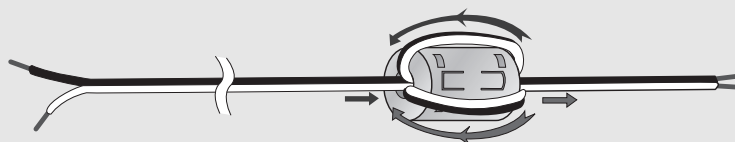

### Option Extras

- Optional extras can be changed or modified for quality improvement without any notification new optional extras can be added.
- Contract your dealer for buying these items.

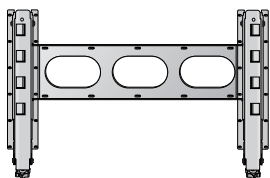

Tilt wall mounting bracket

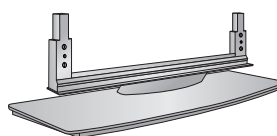

Desktop stand



Video cables



Audio cables

# Controls

- Here shown may be somewhat different from your set.

## Front Panel Controls

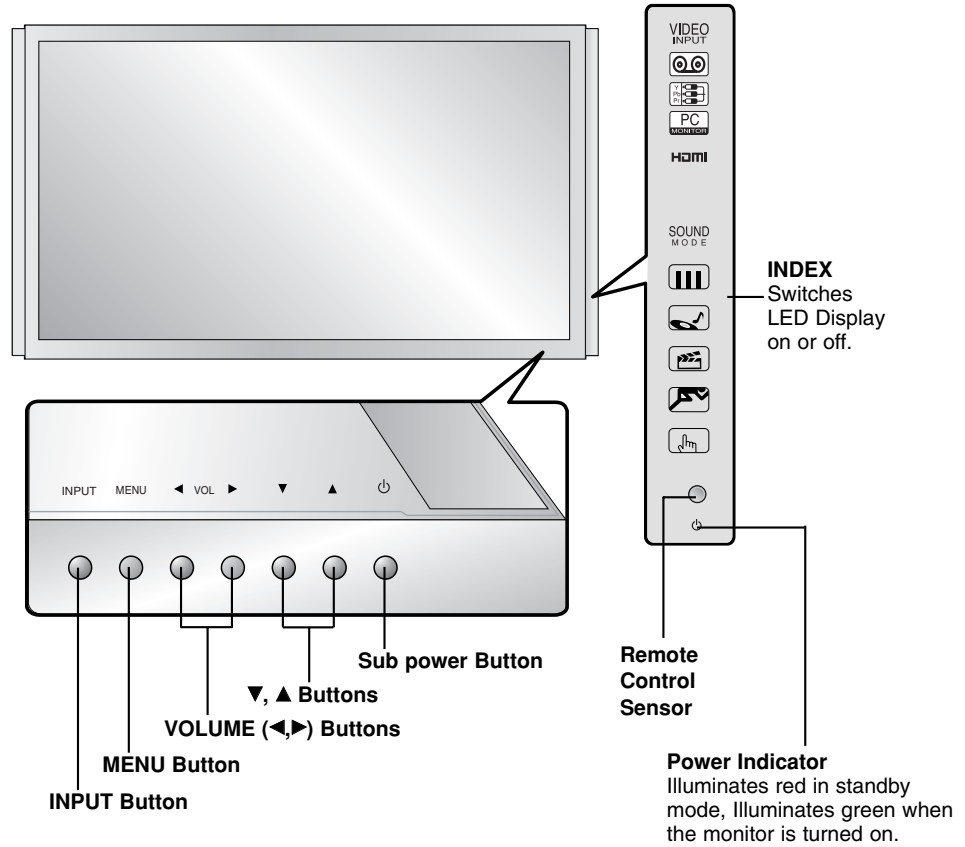

### INDEX

- VIDEO INPUT**
- Video Mode
- Component Mode
- RGB(DTV/PC) Mode
- HDMI1/DVI or HDMI2 Mode

- SOUND MODE**
- Flat ▶ p.22
- Music ▶ p.22
- Movie ▶ p.22
- Sports ▶ p.22
- Off ▶ p.22



# Connection Options

- Here shown may be somewhat different from your set.

Back Connection Panel

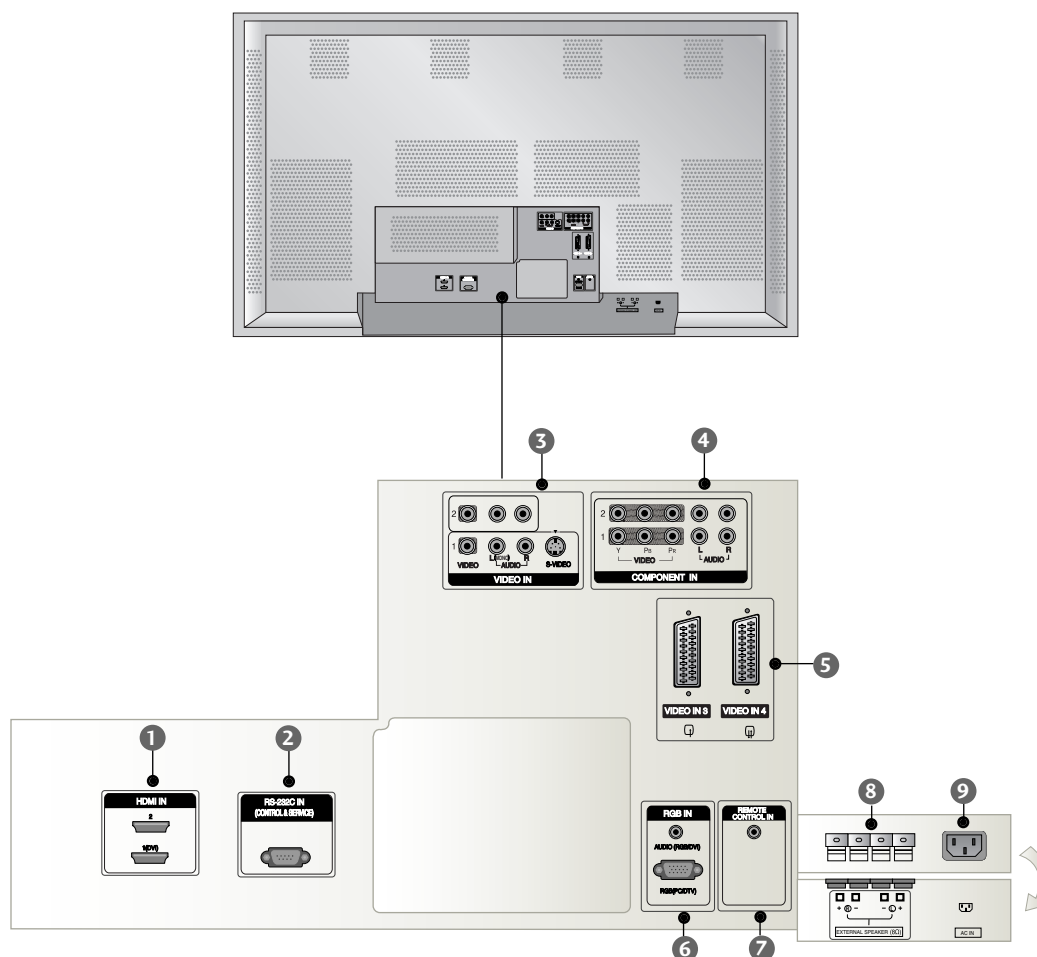

## 1 HDMI IN

Connect a HDMI signal to 1(DVI) or 2.  
Or DVI(VIDEO) signal to the 1(DVI) port with a DVI to HDMI cable.

## 2 RS-232C IN (CONTROL & SERVICE) PORT

Connect to the RS-232C port on a PC.

## 3 VIDEO IN

Connect audio/video output from an external device to these jacks.

### S-VIDEO

Connect S-Video out from an S-VIDEO device.

## 4 COMPONENT IN

Connect a component video/audio device to these jacks.

## 5 EURO SCART SOCKET

Connect the euro scart of the VCR to these sockets.

## 6 RGB IN

### AUDIO (RGB/DVI)

Connect the monitor output from a PC to the appropriate input port.

### RGB(PC/DTV)

Connect the monitor output from a PC to the appropriate input port.

## 7 Remote Control Port

Connect your wired remote control.

## 8 EXTERNAL SPEAKER (8 ohm output)

Connect to optional external speaker(s).

\* For further information, refer to 'Speaker & Speaker Stand' manual.

## 9 POWER CORD SOCKET

This Monitor operates on an AC power. The voltage is indicated on the Specifications page. Never attempt to operate the Monitor on DC power.

## Remote Control Key Functions

- When using the remote control, aim it at the remote control sensor on the monitor.
- Under certain conditions such as if the remote IR signal is interrupted, the remote control may not function. Press the key again as necessary.

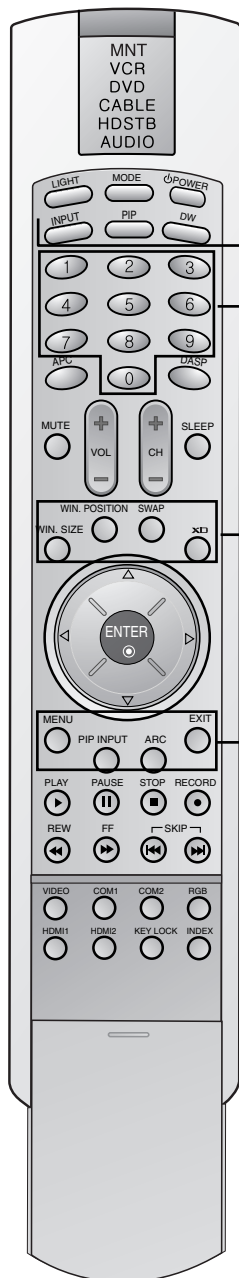

### LIGHT

Illuminates the remote control buttons.

### MODE

Selects the remote operating mode: MNT, VCR, DVD, CABLE, HDSTB or AUDIO.

### POWER

Turns your monitor or any other programmed equipment on or off, depending on mode.

### INPUT

Selects: Video1-2-3-4, Component 1-2, RGB(DTV/PC), HDMI1/DVI, HDMI2 input sources.

### PIP

Selects the PIP mode.

### DW

Selects the DW mode.

### NUMBER buttons

Dosen't work for monitor mode.

### WIN. SIZE

Adjusts the sub picture size.

### WIN.POSITION

Moves the sub picture.

### SWAP

Exchanges the main/sub images.

### XD

Switches the XD on or off. (Refer to p. 19)

### MENU

Brings up the main menu to the screen.

### PIP INPUT

Selects the input source for the sub picture.

### ARC

Changes the picture format. (Refer to p. 28)

### EXIT

Clears all on-screen displays and returns to monitor viewing from any menu.

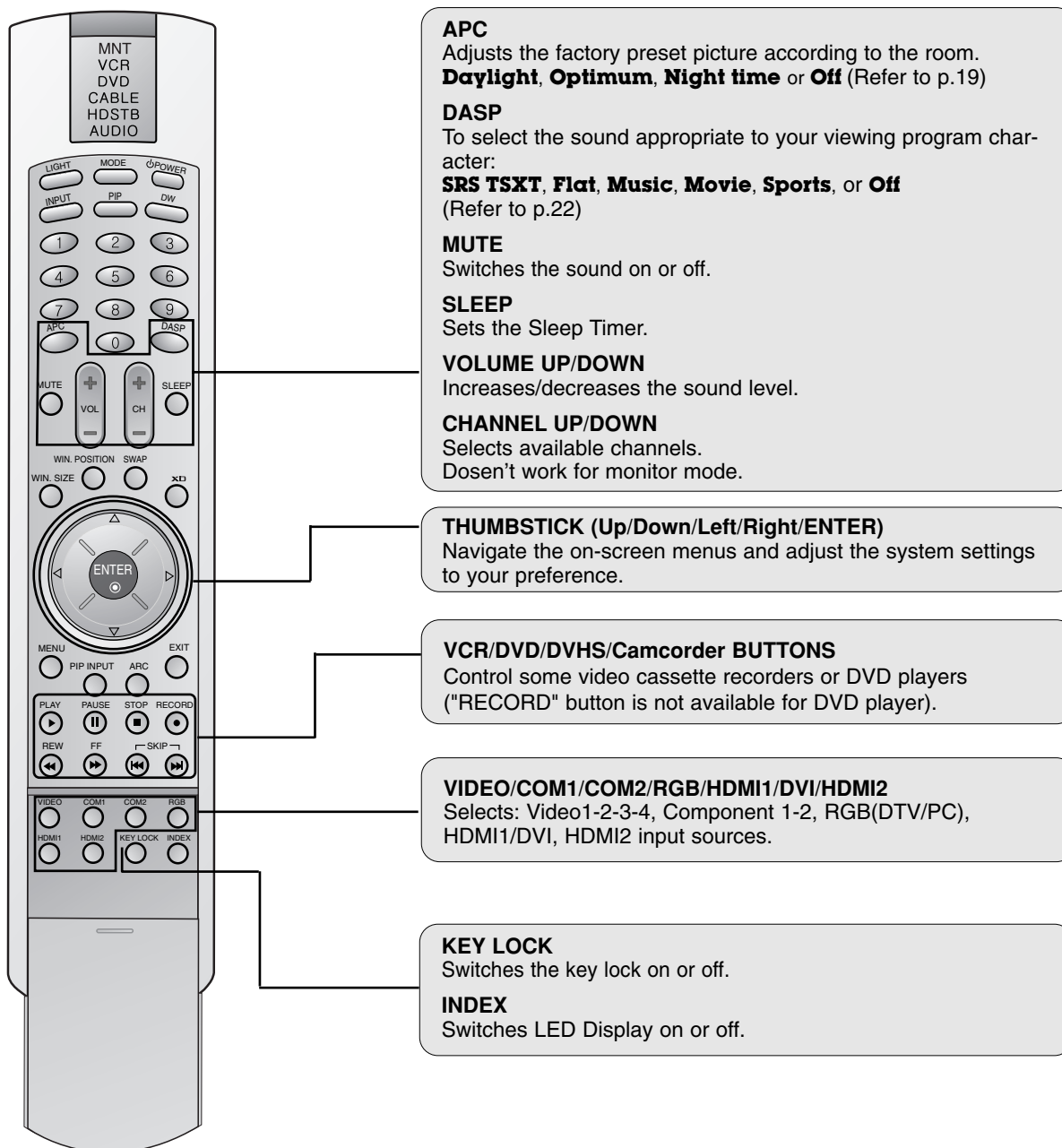

### Installing Batteries

- Open the battery compartment cover on the back side and install the batteries matching correct polarity (+ with +, - with -).
- Install two 1.5V AA batteries. Don't mix old or used batteries with new ones. Replace cover.

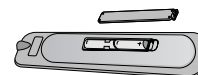

# Installation

## Installation Instructions

- Install this monitor only in a location where adequate ventilation is available.

### GROUNDING

Ensure that you connect the grounding / earth wire to prevent possible electric shock. If grounding methods are not possible, have a qualified electrician install a separate circuit breaker. Do not try to ground the unit by connecting it to telephone wires, lightening rods, or gas pipes.

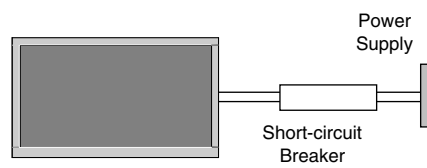

### Wall Mount Installation

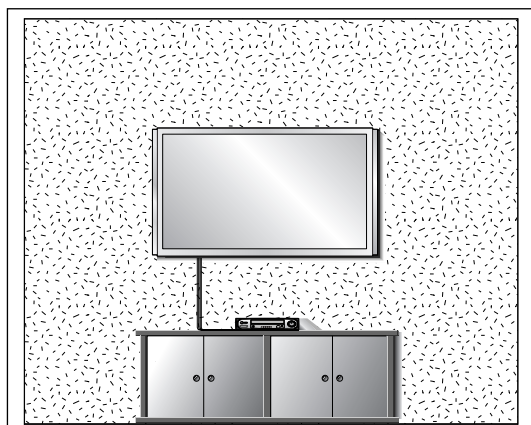

For proper ventilation, allow a clearance of 4" on each side and 4" from the wall. Detailed installation instructions are available from your dealer, see the optional Wall Mounting Bracket Installation and Setup Guide.

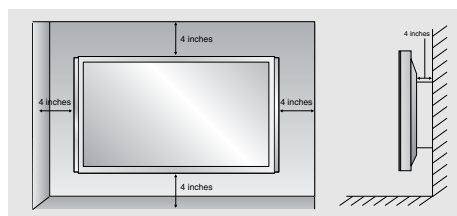

### Desktop Pedestal Installation

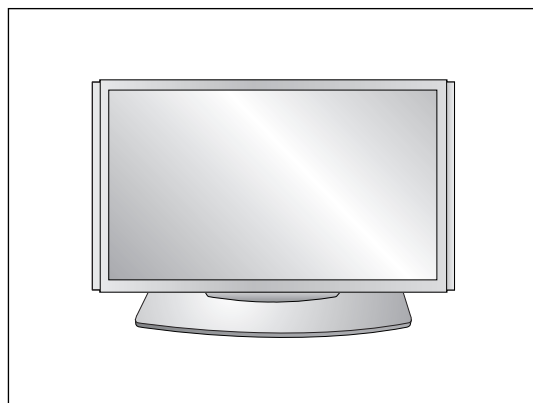

For proper ventilation, allow a clearance of 4" on each side and the top and 4" from the wall. Detailed installation instructions are included in the optional Desktop Stand Installation and Setup Guide available from your dealer.

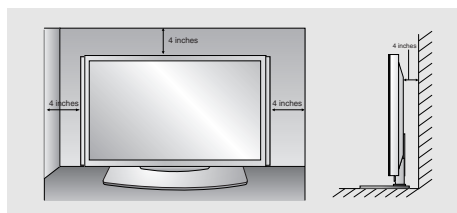

## External Equipment Connections

**NOTE:** Not all cables shown are included with the plasma display.

### VCR Setup

- To avoid picture noise (interference), leave an adequate distance between the VCR and Monitor.
- Use the ISM Method feature to avoid having a fixed image remain on the screen for a long period of time. Typically a frozen still picture from a VCR. If the 4:3 picture format is used; the fixed image may remain visible on the screen.

#### How to connect

1. Connect the audio and video cables from the VCR's output jacks to the monitor input jacks, as shown in the figure.  
When connecting the monitor to VCR, match the jack colors (Video = yellow, Audio Left = white, and Audio Right = red).
2. If you connect an S-VIDEO output from VCR to the S-VIDEO input, the picture quality is improved; compared to connecting a regular VCR to the Video input.
3. If you connect the Euro scart socket of the VCR to the Euro scart socket of the set. No other connection is needed.

**Mono VCR:** Connect the video output cable from the VCR to the VIDEO input on the monitor.

**S-VIDEO VCR:** Connect the S-Video output cable from the VCR to the S-VIDEO input on the monitor. (Note that S-Video offers higher quality).

#### How to use

1. Insert a video tape into the VCR and press PLAY on the VCR.  
(Refer to the VCR owner's manual.)
2. Use the **INPUT** button on the remote control to select **Video 1**.  
(If connected to VIDEO 2, VIDEO 3 or VIDEO 4, select the **Video 2**, **Video 3** or **Video 4** input source.)

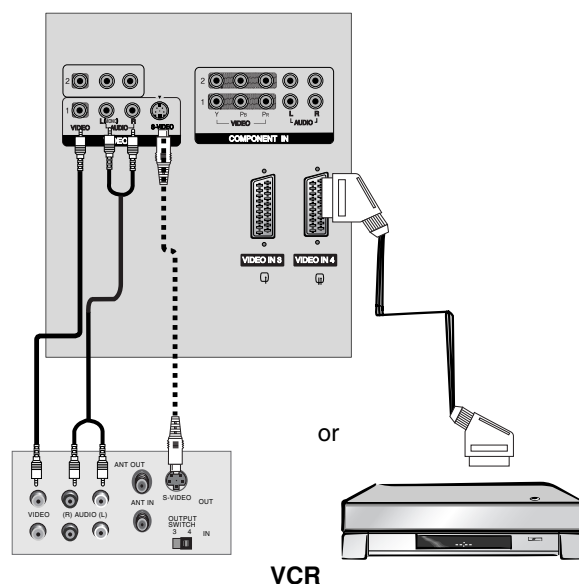

# External Equipment Connections

## Cable TV Setup

- After subscribing to a cable monitor service from a local provider and installing a converter, you can watch cable TV programming. The monitor cannot display monitor programming unless a TV tuner device or cable TV converter box is connected to the Monitor.
- For further information regarding cable monitor service, contact your local cable TV service provider(s).

### How to connect

1. Connect the audio and video cables from the Cable Box's output jacks to the monitor input jacks, as shown in the figure.  
When connecting the monitor to a Cable Box, match the jack colors (Video = yellow, Audio Left = white, and Audio Right = red).  
Or, connect the Euro scart socket of the Cable box to the Euro scart socket of the set.

### How to use

1. Use the **INPUT** button on the remote control to select **Video 1**.  
(If connected to VIDEO 2, VIDEO 3 or VIDEO 4, select the **Video 2**, **Video 3** or **Video 4** input source.)
2. Select your desired channel with the remote control for cable box.

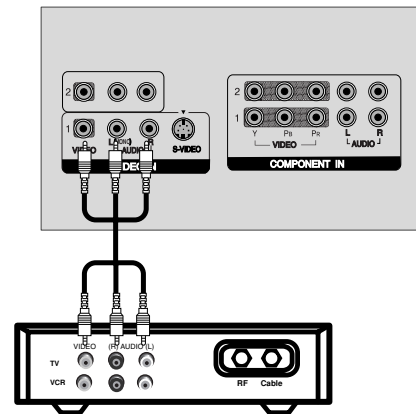

Cable Box

## External A/V Source Setup

### How to connect

1. Connect the audio and video cables from the external equipment's output jacks to the monitor input jacks, as shown in the figure.  
When connecting the monitor to external equipment, match the jack colors (Video = yellow, Audio Left = white, and Audio Right = red).  
Or, connect the Euro scart socket of the External A/V to the Euro scart socket of the set.

### How to use

1. Use the **INPUT** button on the remote control to select **Video 1**. (If connected to VIDEO 2, VIDEO 3 or VIDEO 4, select the **Video 2**, **Video 3** or **Video 4** input source.)
2. Operate the corresponding external equipment. Refer to external equipment operating guide.

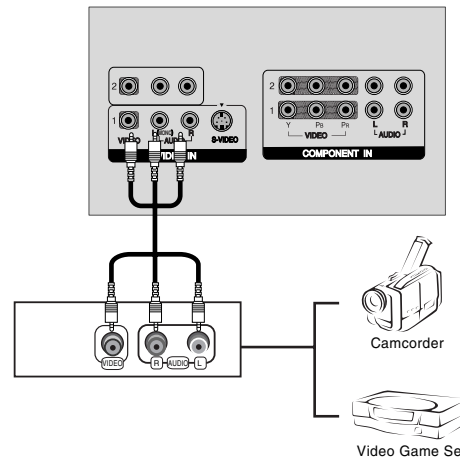

DVD Setup

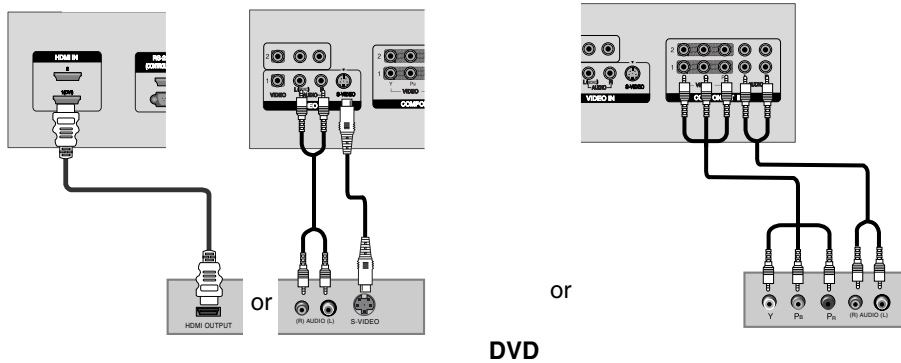

DVD

How to connect

1. Connect the DVD video outputs to the COMPONENT (Y, Pb, Pr) or HDMI IN 1(DVI) jacks and connect the DVD audio outputs to the AUDIO INPUT jacks on the monitor, as shown in the figure.
2. If your DVD only has an S-Video output jack, connect this to the S-VIDEO input on the monitor and connect the DVD audio outputs to the AUDIO INPUT jacks on the monitor, as shown in the figure.

How to use

1. Turn on the DVD player, insert a DVD.
2. Use the **INPUT** button on the remote control to select **Component 1, Component 2, HDMI1/DVI or HDMI2.** (If connected to S-VIDEO, select the **Video 1** external input source.)
3. Refer to the DVD player's manual for operating instructions.

• Component Input ports

To get better picture quality, connect a DVD player to the component input ports as shown.

Component ports of the Monitor	Y	P <sub>B</sub>	P <sub>R</sub>
Video output ports of DVD player	Y	P <sub>b</sub>	P <sub>r</sub>
	Y	B-Y	R-Y
	Y	C <sub>b</sub>	C <sub>r</sub>
	Y	P <sub>B</sub>	P <sub>R</sub>

DTV Setup

- To watch digitally broadcast programs, purchase and connect a digital set-top box.
- This monitor supports HDCP (High-bandwidth Digital Contents Protection) protocol for HDMI/DVI-DTV (480p,576p,720p,1080i, 1080p) mode.

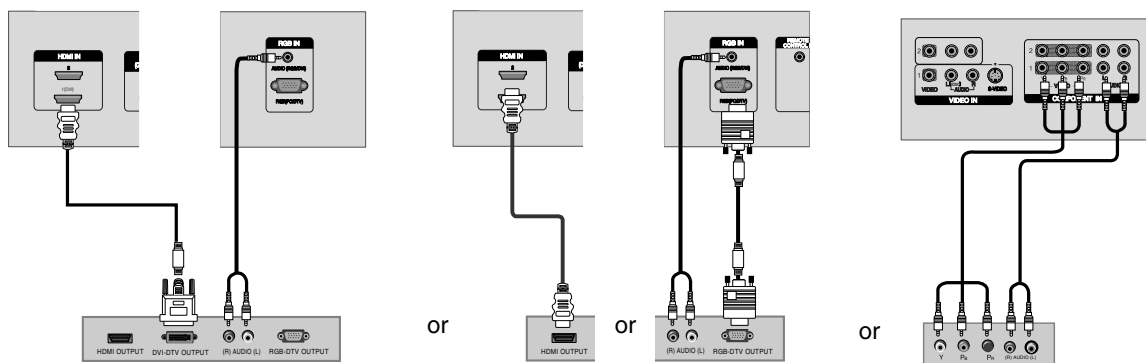

Digital Set-top Box

How to connect

1. Use the monitor's COMPONENT (Y, Pb, Pr) INPUT, RGB or HDMI IN 1(DVI) to HDMI jack for video connections, depending on your set-top box connector. Then, make the corresponding audio connections.

How to use

1. Turn on the digital set-top box. (Refer to the owner's manual for the digital set-top box.)
2. Use **INPUT** on the remote control to select **Component 1, Component 2, RGB, HDMI1/DVI or HDMI2.**

## External Equipment Connections

### PC Setup

- This monitor provides Plug and Play capability, meaning that the PC adjusts automatically to its settings. The monitor sends configuration information (EDID) to the PC using the Video Electronics Standard Association (VESA) Display Data Channel (DDC) protocol.
- The monitor perceives 640x480, 60Hz as DTV 480p based on the PC graphic card. In this case, change the screen scanning rate for the graphic card.

### How to connect

1. To get the best picture quality, adjust the PC graphics card to a 1600x1200, 60Hz.
2. Use the monitor's RGB IN or HDMI IN 1(DVI) port for video connections, depending on your PC connector.

If the graphic card on the PC does not output analog and digital RGB simultaneously, connect only one of either RGB IN or HDMI IN 1(DVI) to display the PC on the monitor.

If the graphic card on the PC does output analog and digital RGB simultaneously, set the monitor to either RGB or HDMI1/DVI; (the other mode is set to Plug and Play automatically by the monitor.)

3. Then, make the corresponding audio connections.  
If using a sound card, adjust the PC sound as required.

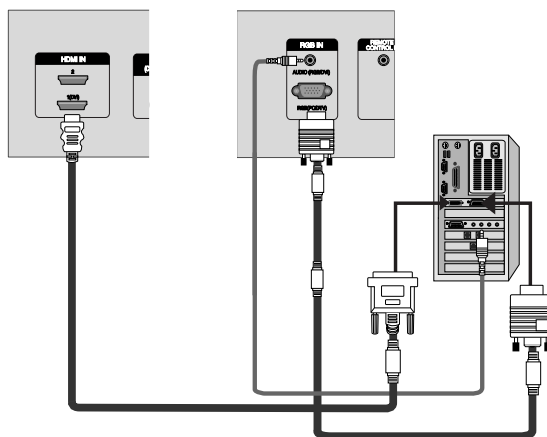

### How to use

1. Turn on the PC and the monitor.
2. Turn on the display by pressing the POWER button on the monitor's remote control.
3. Use the **INPUT** button on the remote control to select **RGB** or **HDMI1/DVI**.
4. Check the image on your monitor. There may be noise associated with the resolution, vertical pattern, contrast or brightness in PC mode. If noise is present, change the PC mode to another resolution, change the refresh rate to another rate or adjust the brightness and contrast on the menu until the picture is clear. If the refresh rate of the PC graphic card can not be changed, change the PC graphic card or consult the manufacturer of the PC graphic card.

- NOTES:**
- Avoid keeping a fixed image on the monitor's screen for a long period of time. The fixed image may become permanently imprinted on the screen. Use the Orbiter screen saver when possible.
  - The synchronization input form for Horizontal and Vertical frequencies is separate.



**Monitor Display Specifications (RGB-PC / HDMI/DVI-PC Mode)**

Resolution	Horizontal Frequency(kHz)	Vertical Frequency(Hz)
720x400	31.469	70.08
640x480	31.469	59.94
	35.000	66.66
	37.861	72.80
	37.500	75.00
	43.269	85.00
800x600	37.879	60.31
	46.875	75.00
	53.674	85.06
832x624	49.725	74.55
1024x768	48.363	60.00
	56.476	70.06
	60.023	75.02
1280x1024	63.981	60.02
	80.000	75.00
1600x1200	75.00	60.00
1920x1080	66.587	59.934



**HDMI™**  
HIGH DEFINITION MULTIMEDIA INTERFACE

- HDMI™, the HDMI logo and High-Definition Multimedia Interface are trademarks or registered trademarks of HDMI Licensing."
- This monitor can receive the High-Definition Multimedia Interface(HDMI).
- This monitor supports HDCP(High-bandwidth Digital Contents Protection) Protocol for 480p,576p,720p,1080i, 1080p modes.
- When you Connect with HDMI Source Devices (DVD Player or Set Top Box) supporting Auto HDMI function, automatically, support Plug & Play and then set the HDMI Source Devices(1920 x 1080i). After reading in HDMI Source Devices using Display Data Channel(DDC) Protocol, EDID stored in monitor is used. If HDMI Source Devices not supported Auto HDMI is been, the Resolution is setted, manually.
- To get the best picture quality, adjust the DVD Player or Set Top Box output resolution to 1920 x 1080i.

**How to connect**

- When Source Devices(DVD Player or Set Top Box) support HDMI.
- If Source Devices have HDMI Output Connector, Source Devices connect to DTV with HDMI Cable.(not supplied with the product).
  - If Source Devices support Auto HDMI, automatically, Source Devices divert output resolution in 1920 x 1080i. But if not, resolution divert Manually Setting for reference Manual of Source Devices.
  - To get the best picture quality, adjust the DVD Player or Set Top Box output resolution to 1920 x 1080i.
  - Because HDMI sends Digital Video and Audio with one cable, need not especial Audio Cable for using HDMI Cable.

# Operation









## Turning on the Monitor

### Turning on the Monitor just after installation

1. Connect power cord correctly. At this moment, the Monitor is switched to standby mode.
2. Press the **INPUT** or  button on the Monitor or press the **POWER, INPUT** button on the remote control and then the Monitor will switch on.

## Menu Language Selection

- The menus can be shown on the screen in the selected language. First select your language.

1. Press the **MENU** button and then use  /  button to select the **SPECIAL** menu.
  2. Press the  button and then use  /  button to select **Language**.
  3. Press the  button and then use  /  button to select your desired language.  
From this point on, the on-screen menus will be shown in the language of your choice.
  4. Press the **ENTER** button to save.
- Press the **MENU** button to return to the previous menu.

# Picture Menu Options

- Readjust Picture menu settings for each following input source as preferred.

## Auto Picture Control (APC)

- APC adjusts the Monitor for the best picture appearance.
- When adjusting Picture menu options (contrast, brightness, color, sharpness, and tint) manually, APC automatically changes to **Off**.

1. Press the **APC** button repeatedly to select the picture appearance setup option as shown below.

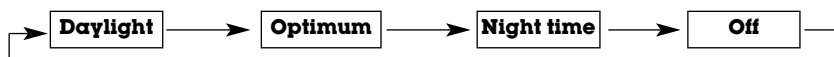

- You can also select **Daylight**, **Optimum**, **Night time** or **Off** in the **PICTURE** menu.
- **Daylight**, **Optimum**, and **Night time** settings are preset for optimum picture quality at the factory and cannot be changed.

## XD

- XD is LG Electronic's unique picture improving technology to display a real HD source through an advanced digital signal processing algorithm.
- When selecting APC options (Daylight, Optimum and Night time), XD is automatically change to On.

1. Press the **XD** button repeatedly as shown below.

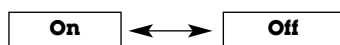

## Auto Color Temperature Control

- To initialize values (reset to default settings), select the **Cool** option.

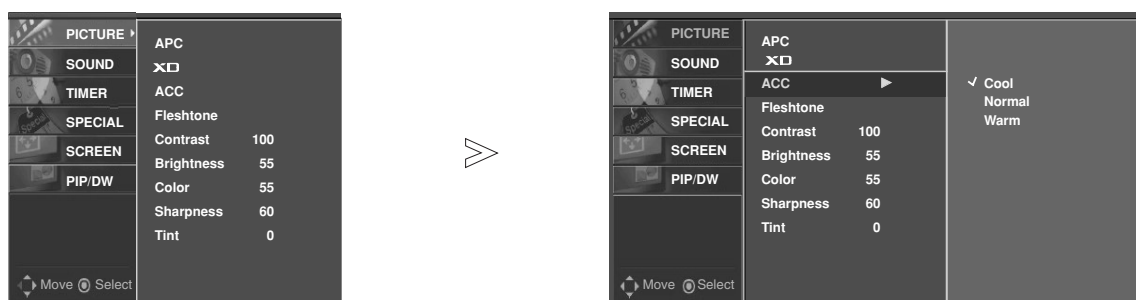

1. Press the **MENU** button and then use **▲** / **▼** button to select the **PICTURE** menu.
2. Press the **▶** button and then use **▲** / **▼** button to select **ACC**.
3. Press the **▶** button and then use **▲** / **▼** button to select either **Cool** (Default), **Normal** (Preset) and **Warm** (Preset).
4. Press the **ENTER** button to save the new settings.

## Picture Menu Options continued

### Fleshtone (Video1-2-3-4, Component 1-2, RGB-DTV, HDMI1/DVI-DTV, HDMI2-DTV Mode only)

- Use Fleshtone to select the desired skin color option.

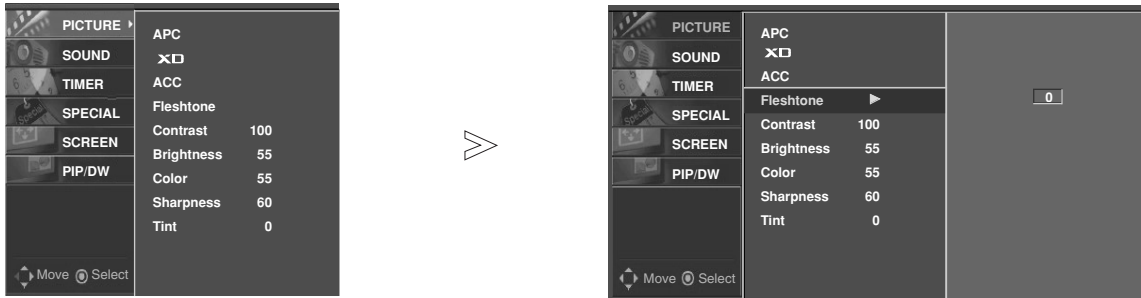

1. Press the **MENU** button and then use ▲ / ▼ button to select the **PICTURE** menu.
2. Press the ▶ button and then use ▲ / ▼ button to select **Fleshtone**.
3. Press the ▶ button and then use ◀ / ▶ button to make appropriate adjustments.
  - The adjustment range is 0 ~ 3.
4. Press the **ENTER** button to save the new settings.

### sRGB (only RGB-PC, HDMI1/DVI-PC Modes)

- If the monitor is connected to external equipment using sRGB, set sRGB to On to adjust for the color difference.

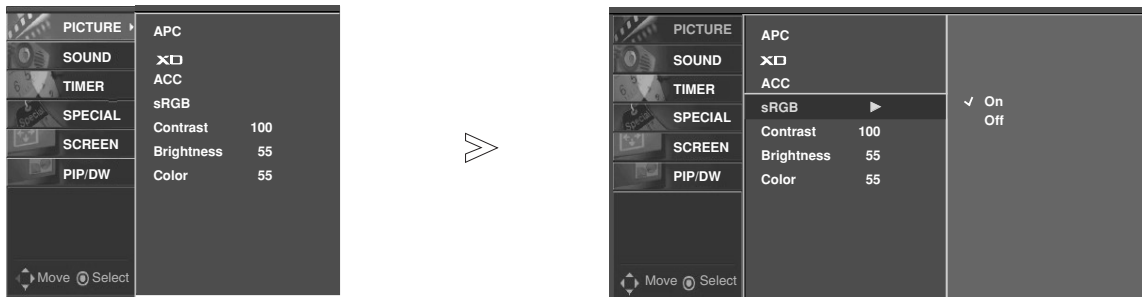

1. Press the **MENU** button and then use ▲ / ▼ button to select the **PICTURE** menu.
2. Press the ▶ button and then use ▲ / ▼ button to select **sRGB**.
3. Press the ▶ button and then use ▲ / ▼ button to select **On** or **Off**.
4. Press the **ENTER** button to save the new settings.

### Manual Picture Control (**Off** option)

- You can adjust picture contrast, brightness, color, sharpness, and tint to the levels you prefer.

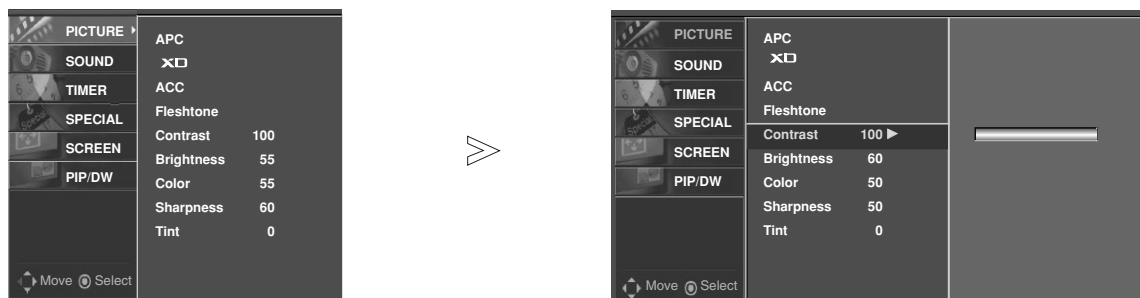

1. Press the **MENU** button and then use **▲ / ▼** button to select the **PICTURE** menu.
2. Press the **▶** button and then use **▲ / ▼** button to select the desired picture option (**Contrast**, **Brightness**, **Color**, **Sharpness** or **Tint**).
3. Press the **▶** button and then use **◀ / ▶** button to make appropriate adjustments.
4. Press the **ENTER** button to save the new settings.

# Sound Menu Options

## DASP (Digital Auto Sound Processing)

- **DASP** lets you enjoy the best sound without any special adjustment because the Monitor has the appropriate sound options based on the program content.
- When adjusting sound options (treble, bass) manually, **DASP** automatically changes to **Off**.

1. Press the **DASP** button repeatedly to select the appropriate sound setup as shown below.

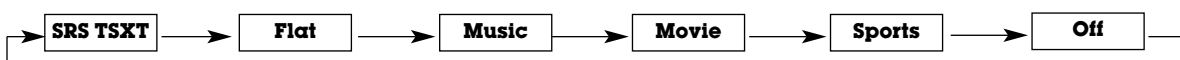

- You can also adjust **DASP** in the **SOUND** menu.
- **SRS TSXT**, **Flat**, **Music**, **Movie**, and **Sports** are preset for good sound quality at the factory and cannot be changed.
- **SRS**  is a trademark of SRS Labs, Inc.
- TruSurround XT technology is incorporated under license from SRS Labs, Inc.

## Manual Sound Control (Dasp **Off** option and balance)

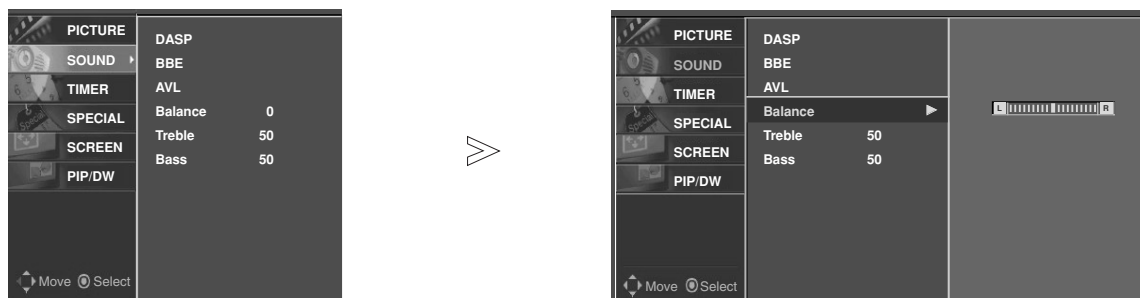

1. Press the **MENU** button and then use **▲ / ▼** button to select the **SOUND** menu.
2. Press the **▶** button and then use **▲ / ▼** button to select the desired sound option (**Balance**, **Treble** or **Bass**).
3. Press the **▶** button and then use **◀ / ▶** button to make appropriate adjustments.
4. Press the **ENTER** button to save the new settings.

## BBE

- BBE High Definition Sound restores clarity and presence for better speech intelligibility and musical realism.

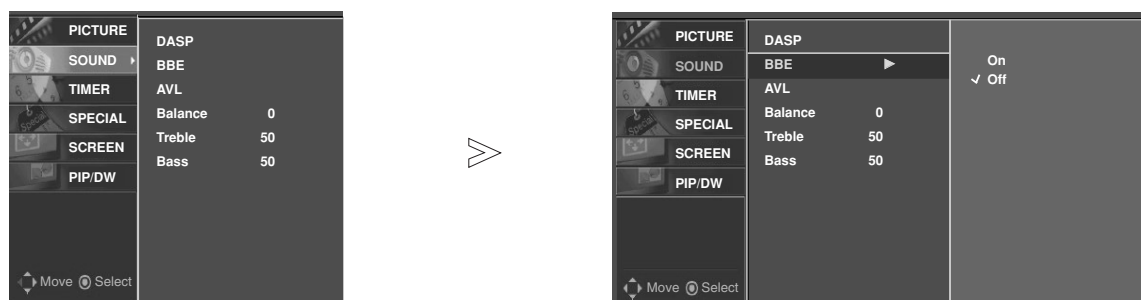

1. Press the **MENU** button and then use **▲ / ▼** button to select the **SOUND** menu.
2. Press the **▶** button and then use **▲ / ▼** button to select **BBE**.
3. Press the **▶** button and then use **▲ / ▼** button to select **On** or **Off**.
4. Press the **ENTER** button to save the new settings.

- **BBE**. Manufactured under license from BBE Sound, Inc.
- Treble, Bass or BBE aren't suitable for **SRS TSXT** mode.

## AVL (Auto Volume Leveler)

- This feature maintains an equal volume level; even if you change channels.

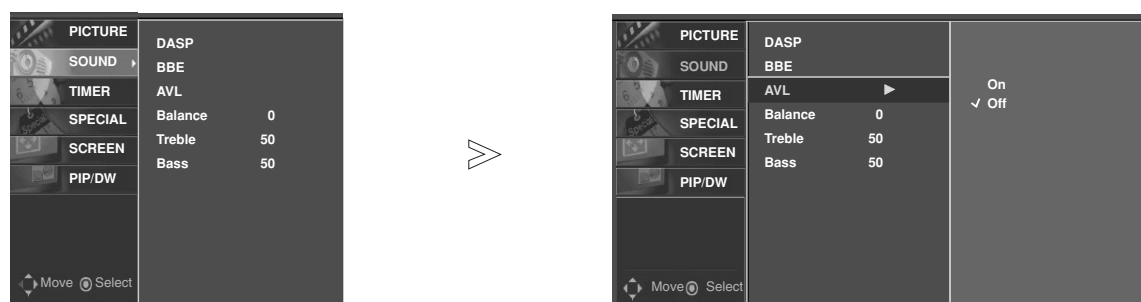

1. Press the **MENU** button and then use **▲ / ▼** button to select the **SOUND** menu.
2. Press the **▶** button and then use **▲ / ▼** button to select **AVL**.
3. Press the **▶** button and then use **▲ / ▼** button to select **On** or **Off**.
4. Press the **ENTER** button to save the new settings.

# Timer Menu Options

## Clock Setup

- If current time setting is wrong, correct the clock setting.

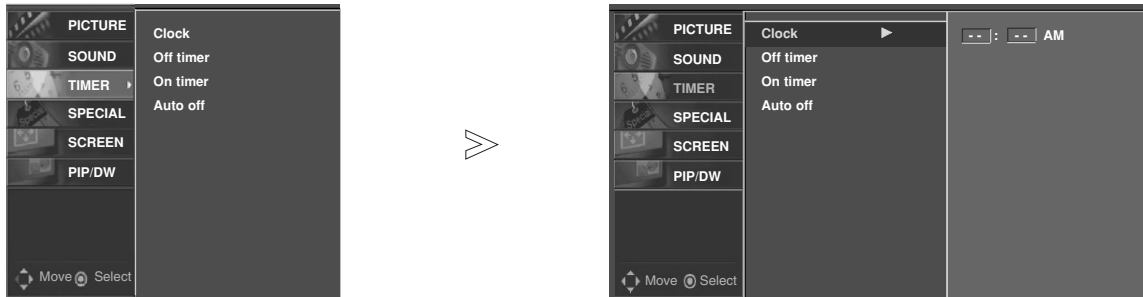

1. Press the **MENU** button and then use **▲ / ▼** button to select the **TIMER** menu.
2. Press the **▶** button and then use **▲ / ▼** button to select **Clock**.
3. Press the **▶** button and then use **▲ / ▼** button to set the hour.
4. Press the **▶** button and then use **▲ / ▼** button to set the minutes.
5. Press the **ENTER** button to save the new settings.

## On/Off Timer Setup

- Timer function operates only if current time has already been set.
- Off-Timer function overrides On-Timer function if they are set to the same time.
- If you do not press any button within 2 hours after the monitor turns on with the On Timer function, the monitor will automatically revert to standby mode.

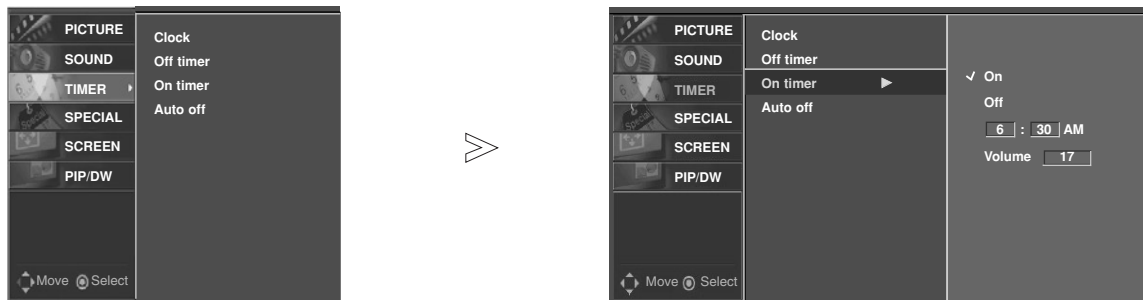

1. Press the **MENU** button and then use **▲ / ▼** button to select the **TIMER** menu.
  2. Press the **▶** button and then use **▲ / ▼** button to select **Off timer** or **On timer**.
  3. Press the **▶** button and then use **▲ / ▼** button to select **On**.
    - To cancel **On/Off timer** function, select **Off**.
  4. Press the **▶** button and then use **▲ / ▼** button to set the hour.
  5. Press the **▶** button and then use **▲ / ▼** button to set the minutes.
  6. Press the **ENTER** button to save the new settings.
- For only On timer function;** Press the **▶** button and then use **▲ / ▼** button to set volume level.



### Auto Off

- If there is no input signal, the Monitor turns off automatically after 10 minutes.

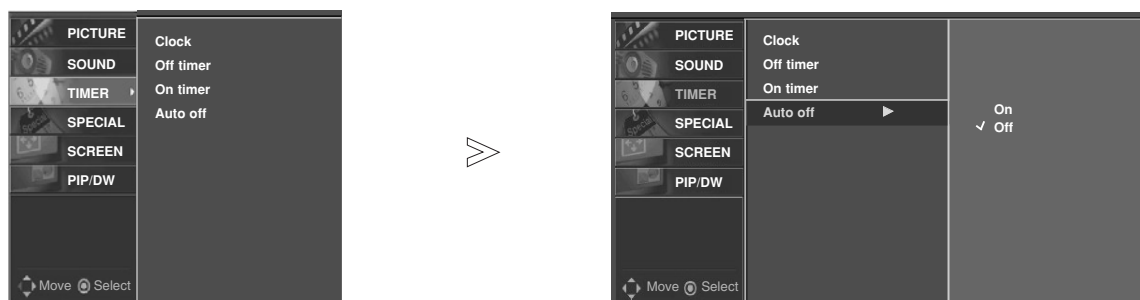

1. Press the **MENU** button and then use ▲ / ▼ button to select the **TIMER** menu.
2. Press the ► button and then use ▲ / ▼ button to select **Auto off**.
3. Press the ► button and then use ▲ / ▼ button to select **On** or **Off**.
4. Press the **ENTER** button to save the new settings.

### Sleep Timer

- The sleep timer turns the Monitor off at a preset time. Note that this setting is cleared when the monitor is turned off.

1. Press the **SLEEP** button repeatedly to select the number of minutes. First the --- **Min** option appears on the screen, followed by the following sleep timer options: 10, 20, 30, 60, 90, 120, 180, and 240 minutes.
2. When the number of minutes you want is displayed on the screen, press the **ENTER** button. The timer begins to count down from the number of minutes selected.
3. To check the remaining minutes before the monitor turns off, press the **SLEEP** or **ENTER** button once.
4. To cancel the Sleep Timer, press the **SLEEP** button repeatedly until --- **Min** appears.

# Special Menu Options

## Key Lock

- The monitor can be set up so that it can only be used with the remote control.
- This feature can be used to prevent unauthorized viewing by disabling the front panel controls.
- This Monitor is programmed to remember which option it was last set to even if you turn the monitor off.

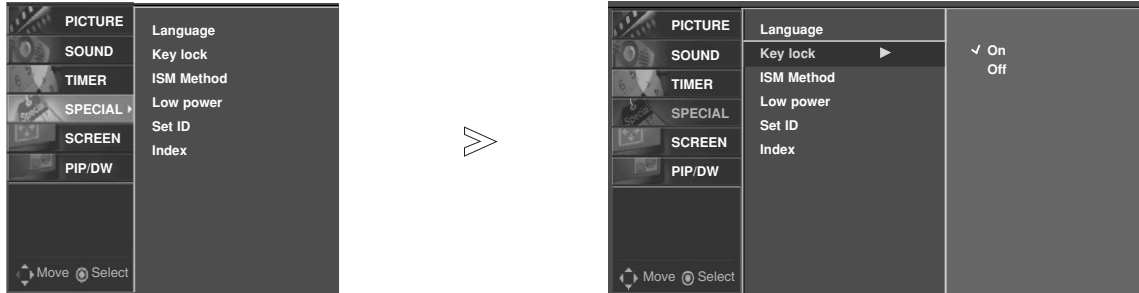

1. Press the **MENU** button and then use **▲ / ▼** button to select the **SPECIAL** menu.
2. Press the **▶** button and then use **▲ / ▼** button to select **Key lock**.
3. Press the **▶** button and then use **▲ / ▼** button to select **On** or **Off**.
  - When you select **On**, the display '▲ **Key lock**' appears on the screen if any button on the front panel is pressed.
4. Press the **ENTER** button to save the new settings.

-In setting **Key lock 'On'**, if the monitor is turned off with the remote control, press the **INPUT** on the monitor or **POWER, INPUT** on the remote control to turn the monitor on.

## ISM (Image Sticking Minimization) Method

- A frozen still picture from a PC/video game displayed on the screen for prolonged periods will result in an ghost image remaining; even when you change the image. Avoid allowing a fixed or still image to remain on the Monitor's screen for a long period of time.

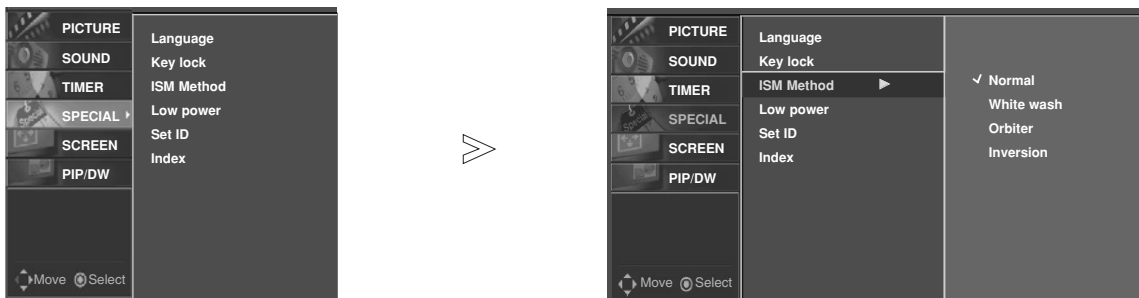

1. Press the **MENU** button and then use **▲ / ▼** button to select the **SPECIAL** menu.
2. Press the **▶** button and then use **▲ / ▼** button to select **ISM Method**.
3. Press the **▶** button and then use **▲ / ▼** button to select either **Normal, White wash, Orbiter,** or **Inversion**.
  - **Normal**  
If image sticking is never a problem, ISM is not necessary - set this to Normal.
  - **White wash**  
White Wash removes permanent images from the screen. Note: An excessive permanent image may be impossible to clear completely using White Wash. To return to normal viewing, press the any button.
  - **Orbiter**  
Orbiter may help prevent ghost images. However, it is best not to allow any fixed image to remain on the screen. To avoid a permanent image on the screen, the image will move every 2 minutes.
  - **Inversion**  
Inversion will automatically invert the plasma display panel color every 30 minutes.
4. Press the **ENTER** button to save the new settings.

## Low Power

- Low power reduces the plasma display's power consumption.

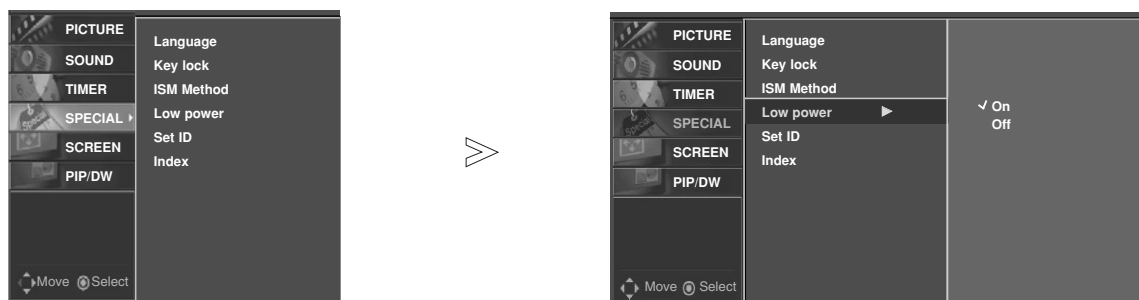

1. Press the **MENU** button and then use ▲ / ▼ button to select the **SPECIAL** menu.
2. Press the ► button and then use ▲ / ▼ button to select **Low power**.
3. Press the ► button and then use ▲ / ▼ button to select **On** or **Off**.
  - When you select **On**, the screen darkens.
4. Press the **ENTER** button to save the new settings.

## INDEX

- Switches LED Display on or off.

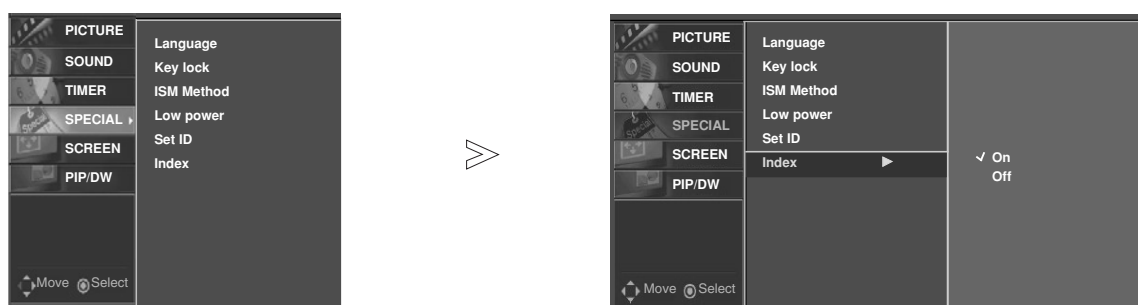

1. Press the **MENU** button and then use ▲ / ▼ button to select the **SPECIAL** menu.
2. Press the ► button and then use ▲ / ▼ button to select **Index**.
3. Press the ► button and then use ▲ / ▼ button to select **On** or **Off**.
4. Press the **ENTER** button to save the new settings.

## Screen Menu Options

### Auto Adjustment

- RGB (PC) mode only; This function doesn't work for RGB(DTV).
- Automatically adjusts picture position and minimizes image shaking.
- After adjustment, if the image is still not correct, your Monitor is functioning properly but needs further adjustment.
- The **Auto config.**, **Position** and **Manual config.** are not active in HDMI/DVI mode.

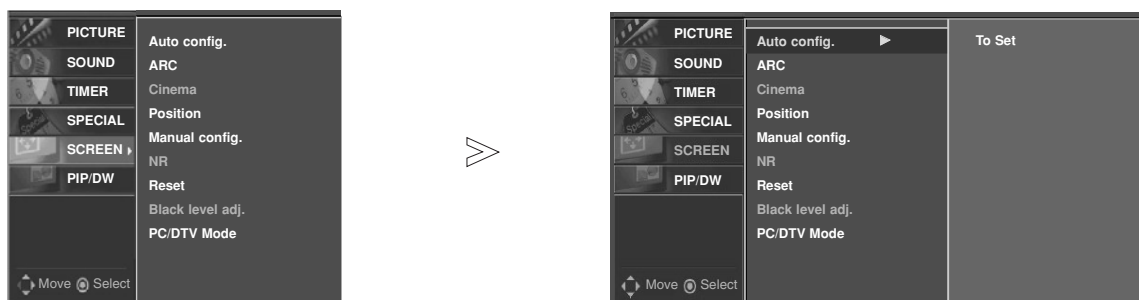

1. Press the **MENU** button and then use **▲ / ▼** button to select the **SCREEN** menu.
2. Press the **▶** button and then use **▲ / ▼** button to select **Auto config.**
3. Press the **▶** button to run Auto configure.
  - When **Auto config.** has finished, **OK** will be shown on screen.
  - If the position of the image is still not correct, try Auto adjustment again.
4. In RGB (PC) mode, if the image needs to be adjusted more after using **Auto config.**, you can make further adjustments with the **Manual config.** option.

### Setting Picture Format

- Caution: If a 4:3 fixed image is on the screen for a long time, it may remain visible.
- RGB-PC, HDMI-PC: 4:3, 16:9
- Component 480i, Video sources : 4:3, 16:9, Horizon and Zoom.
- RGB-DTV, HDMI-DTV/Component 480p,576p,720p,1080i,1080p/HDMI 480p,576p,720p,1080i,1080p : 4:3, 16:9 and Zoom.

1. Press the **ARC** button repeatedly to select the desired picture format. You can also select picture format in the **SCREEN** menu.
  - **4:3**
    - Choose **4:3** when you want to view a picture with an original 4:3 aspect ratio, with black bars appearing at both the left and right sides.
  - **16:9**
    - Choose **16:9** when you want to adjust the picture horizontally, in a linear proportion to fill the entire screen.
  - **Horizon**
    - Choose **Horizon** when you want to adjust the picture in a non-linear proportion, that is, more enlarged at both sides, to create a spectacular view.
  - **Zoom**
    - Choose **Zoom** when you want to view the picture without any alteration. However, the top and bottom portions of the picture will be cropped.

### Cinema Mode Setup (Video1-2 and Component 480i mode only)

- Sets up the monitor for the best picture appearance for viewing movies.

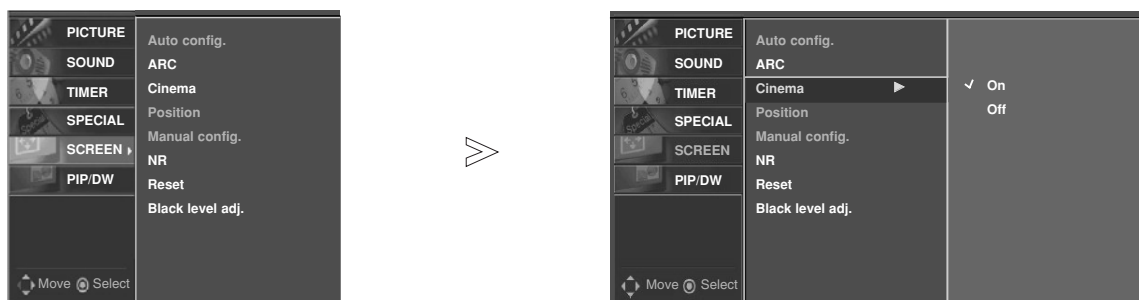

1. Press the **MENU** button and then use **▲ / ▼** button to select the **SCREEN** menu.
2. Press the **▶** button and then use **▲ / ▼** button to select **Cinema**.
3. Press the **▶** button and then use **▲ / ▼** button to select **On** or **Off**.
4. Press the **ENTER** button to save the new settings.

### Screen Position

- This function works in the following mode:  
RGB-PC, RGB-DTV(480p,576p,720p,1080i,1080p), COMPONENT (480p,576p,720p,1080i,1080p).

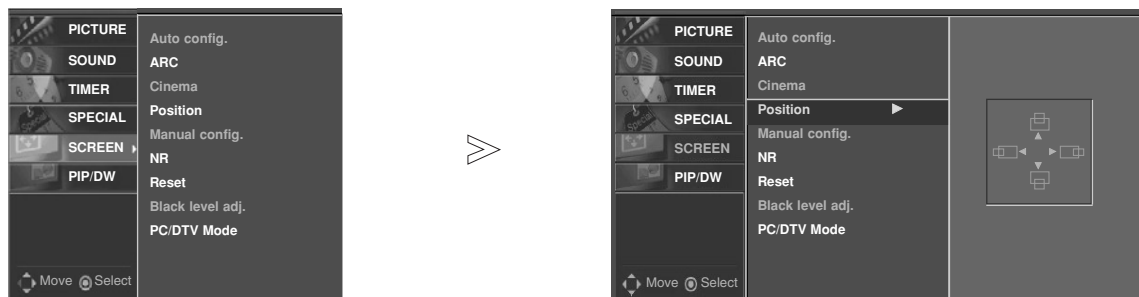

1. Press the **MENU** button and then use **▲ / ▼** button to select the **SCREEN** menu.
2. Press the **▶** button and then use **▲ / ▼** button to select **Position**.
3. Press the **▶** button and then use **▲ / ▼ / ◀ / ▶** button to adjust the position.
4. Press the **ENTER** button to save the new settings.

## Screen Menu Options continued

### Manual Configure (RGB-PC mode only)

- If the image still isn't clear after auto adjustment is completed and especially if characters are still jittery, adjust the picture **Phase** manually.
- To correct the screen size, adjust **Clock**.

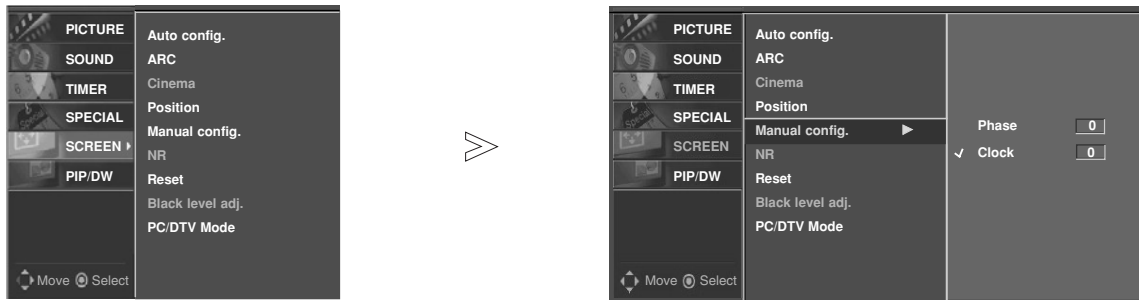

1. Press the **MENU** button and then use **▲ / ▼** button to select the **SCREEN** menu.
2. Press the **▶** button and then use **▲ / ▼** button to select **Manual config.**.
3. Press the **▶** button and then use **▲ / ▼** button to select **Phase** or **Clock**.
4. Use the **◀ / ▶** button to make appropriate adjustments.
  - The **Phase** adjustment range is 0 ~ 31.
  - The **Clock** adjustment range is -127 ~ +128.
5. Press the **ENTER** button to save the new settings.

### Initializing (Reset to original factory value)

- This function operates in every mode.
- To initialize the adjusted value.

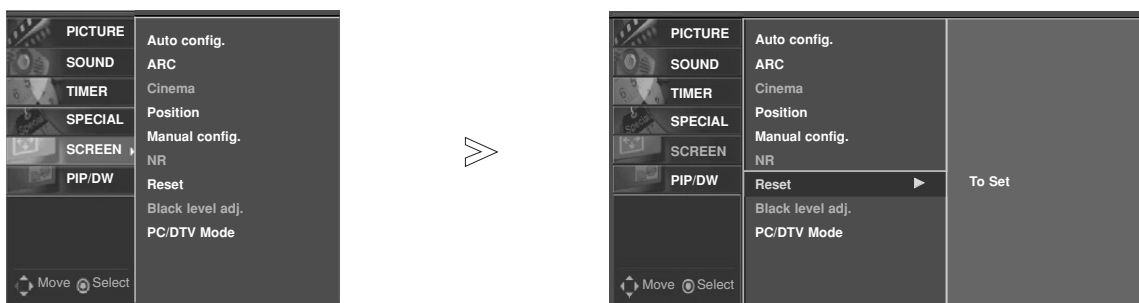

1. Press the **MENU** button and then use **▲ / ▼** button to select the **SCREEN** menu.
2. Press the **▶** button and then use **▲ / ▼** button to select **Reset**.
3. Press the **▶** button.
  - You can initialize Manual config., Position, Split zoom, PIP size, PIP position, PIP transparency and sub picture size for DW.

### Black level adj.

- Adjusting the contrast and the brightness of the screen using the black level of the screen.
- This feature operates only in Video1-2-3-4 or Component 576i mode.

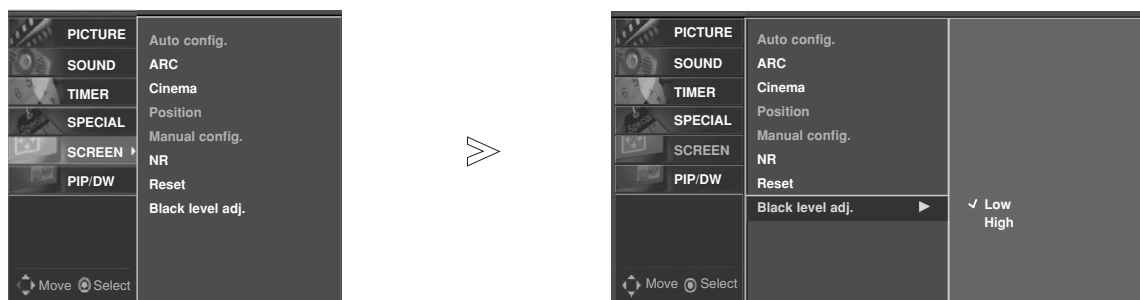

1. Press the **MENU** button and then use **▲ / ▼** button to select the **SCREEN** menu.
2. Press the **▶** button and then use **▲ / ▼** button to select **Black level adj.**
3. Press the **▶** button and then use **▲ / ▼** button to select **Low** or **High**.
  - **Low** - The reflection of the screen gets darker.
  - **High** - The reflection of the screen gets brighter.
4. Press the **ENTER** button to save the new settings.

### PC/DTV Mode

- To see a normal picture, match the resolution of RGB mode (480p/640x480, 1080p/1920x1080) or HDMI1/DVI mode (1080p/1920x1080) in the **SCREEN** menu.
- It can be selected the DTV/PC mode by user.

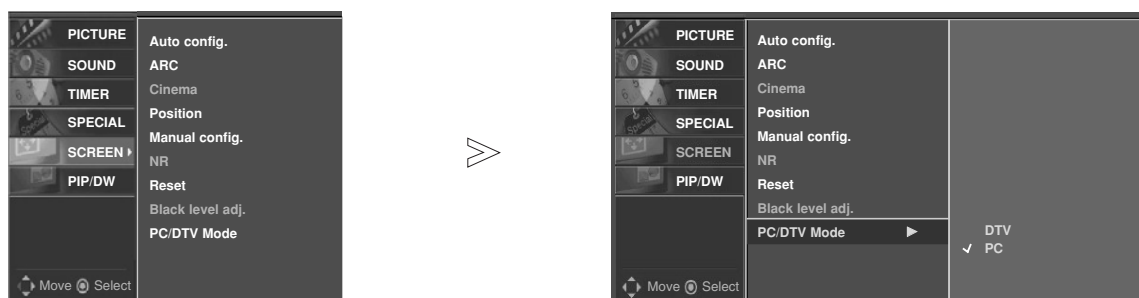

1. Press the **MENU** button and then use **▲ / ▼** button to select the **SCREEN** menu.
2. Press the **▶** button and then use **▲ / ▼** button to select **PC/DTV Mode**.
3. Press the **ENTER** button to save the new settings.

## Screen Menu Options continued

### Screen Adjustments (Video1-2 and Component 480i mode only)

- Use this function to correct jittering or picture instability while viewing a video tape.

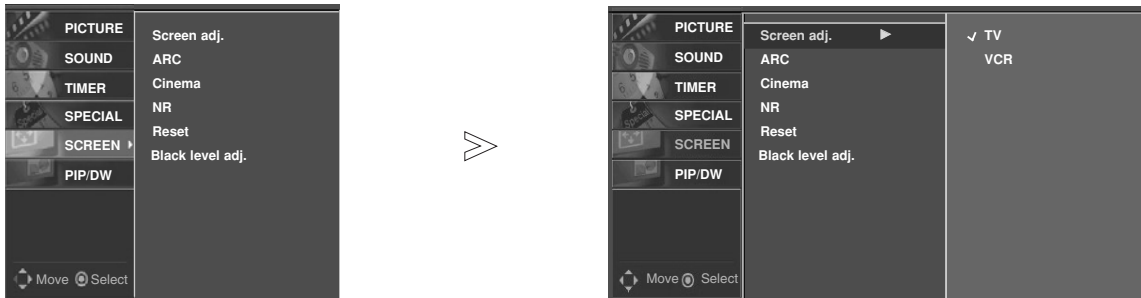

1. Press the **MENU** button and then use **▲ / ▼** button to select the **SCREEN** menu.
2. Press the **▶** button and then use **▲ / ▼** button to select **Screen adj.**.
3. Press the **▶** button and then use **▲ / ▼** button to select **TV** or **VCR**.
  - Select the **VCR** option if watching a VCR.
  - Select the **TV** option for other equipment. (Except VCR)
4. Press the **ENTER** button to save the new settings.

### NR (Noise Reduction)

- You can select **NR** to reduce the picture noise which may appear on the screen during watching the TV.
- This function is not available for use in RGB(PC), HDMI(PC) mode.

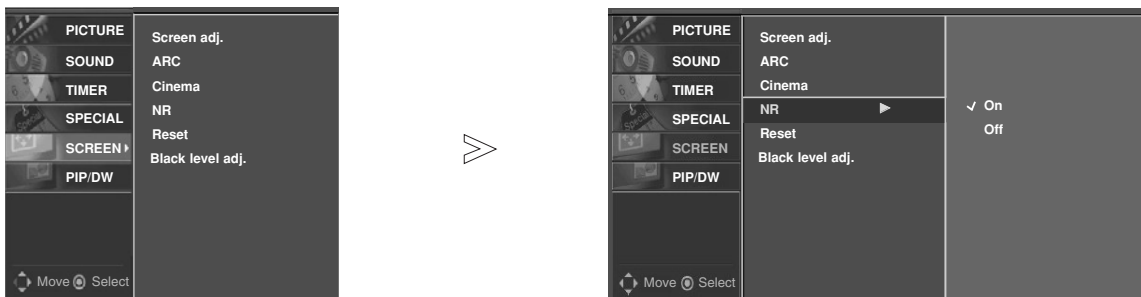

1. Press the **MENU** button and then use **▲ / ▼** button to select the **SCREEN** menu.
2. Press the **▶** button and then use **▲ / ▼** button to select **NR**.
3. Press the **▶** button and then use **▲ / ▼** button to select **On** or **Off**.
4. Press the **ENTER** button to save the new settings.



## PIP (Picture-In-Picture) Feature

- PIP lets you view 2 different inputs (sources) on your monitor screen at the same time. One source will be large, and the other source will show a smaller inset image.
- If input signals(50Hz/60Hz) of the main and sub pictures are different in PIP/DW mode, the screens are unnatural.

### Watching PIP

Press the **PIP** button repeatedly to turn PIP on or off.



### PIP Size

Press the **WIN.SIZE** button and then use ◀ / ▶ button to change the sub picture size.



### PIP Transparency (PIP Mode only)

- To make the PIP clear or opaque.
1. Press the **MENU** button and then use ▲ / ▼ button to select the **PIP/DW** menu.
  2. Press the ▶ button and then use ▲ / ▼ button to select **PIP Transparency**.
  3. Press the ▶ button and then use ◀ / ▶ button to adjust PIP transparency.
  4. Use the ◀ / ▶ button to make appropriate adjustments.
    - The adjustment range of **PIP Transparency** is 0 ~ 16.
  5. Press the **ENTER** button to save.

### Moving the PIP

Press the **WIN.POSITION** button.

Press the ▲ / ▼ / ◀ / ▶ button repeatedly until desired position is achieved. The sub picture moves up/down/left/right.



### Selecting an Input Signal Source for the PIP

Use the **PIP INPUT** button to select the input source for the sub picture.

Main Picture Source	Available Sub Picture Sources
Video1-2-3-4 Component 480i/576i Component 480p/576p/720p/1080i/1080p RGB-DTV(480p/576p/720p/1080i/1080p) RGB-PC	Video1-2-3-4, Component 480i/576i/480p/576p/720p/1080i/1080p, RGB-DTV(480p/576p/720p/1080i/1080p), RGB-PC, HDMI1/DVI, HDMI2
HDMI1/DVI, HDMI2	Video1-2-3-4, Component 480i/576i/480p/576p/720p/1080i/1080p, RGB-DTV(480p/576p/720p/1080i/1080p), RGB-PC

## DW Setup Options

- As the name suggests, this mode splits the screen into 2, allowing 2 picture sources to be shown on the monitor screen at the same time. Each source is given half the screen.

### Watching DW

Press the **DW** button repeatedly to select one of the DW options.



### Sub Picture Size Adjustment

Press the **WIN.SIZE** button.

- Use the ◀ / ▶ button to change the sub picture size.
- Using the WIN.SIZE function in DW mode, main and sub picture sizes are changed simultaneously.
- Using the WIN.SIZE function in PIP mode, sub picture size is changed.
- WIN.POSITION is not functional in DW mode.

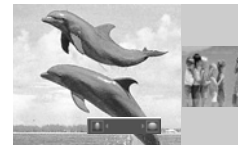

### Swapping the DW

Use the **SWAP** button to switch the main and sub pictures in DW mode.

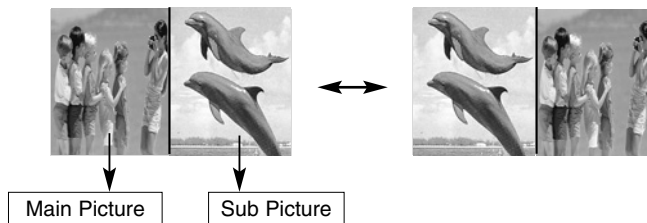

### Selecting a Source for the DW

Use the **PIP INPUT** button to select the input source for the sub picture.

Main Picture Source	Available Sub Picture Sources
Video1-2-3-4	Video1-2-3-4, Component 480i/576i/480p/576p/720p/1080i/1080p, RGB-DTV(480p/576p/720p/1080i/1080p), RGB-PC, HDMI1/DVI, HDMI2
Component 480i/576i	
Component 480p/576p/720p/1080i/1080p	
RGB-DTV(480p/576p/720p/1080i/1080p)	
RGB-PC	Video1-2-3-4, Component 480i/576i/480p/576p/720p/1080i/1080p, RGB-DTV(480p/576p/720p/1080i/1080p), RGB-PC
HDMI1/DVI, HDMI2	

# External Control Device Setup

- Connect the RS-232C input jack to an external control device (such as a computer or an A/V control system) and control the Monitor's functions externally.
- Connect the serial port of the control device to the RS-232C jack on the Monitor back panel.
- RS-232C connection cables are not supplied with the Monitor.

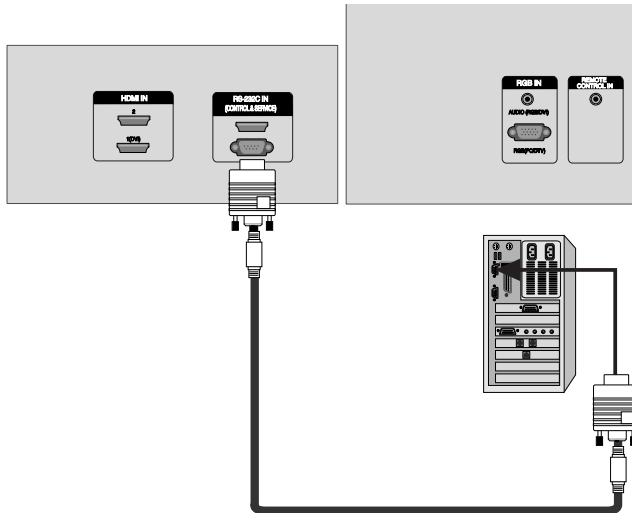

### Type of Connector: D-Sub 9-pin Male

No.	Pin Name
1	No Connection
2	RXD (Receive data)
3	TXD (Transmit data)
4	DTR (DTE side ready)
5	GND
6	DSR (DCE side ready)
7	RTS (Ready to send)
8	CTS (Clear to send)
9	No Connection

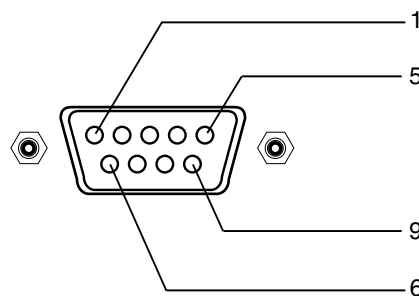

### RS-232C Configurations

#### 7-Wire Configuration (Standard RS-232C cable)

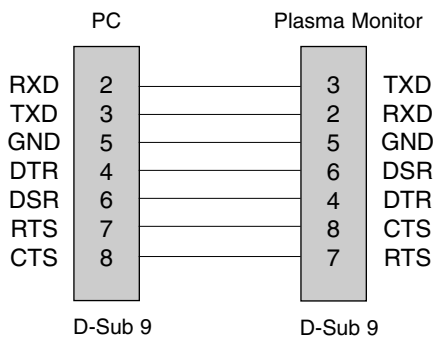

#### 3-Wire Configuration (Not standard)

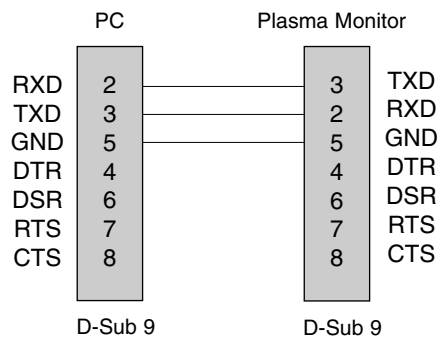

### Set ID

- Use this function to specify a monitor ID number.
- Refer to 'Real Data Mapping 1'. See page 38.

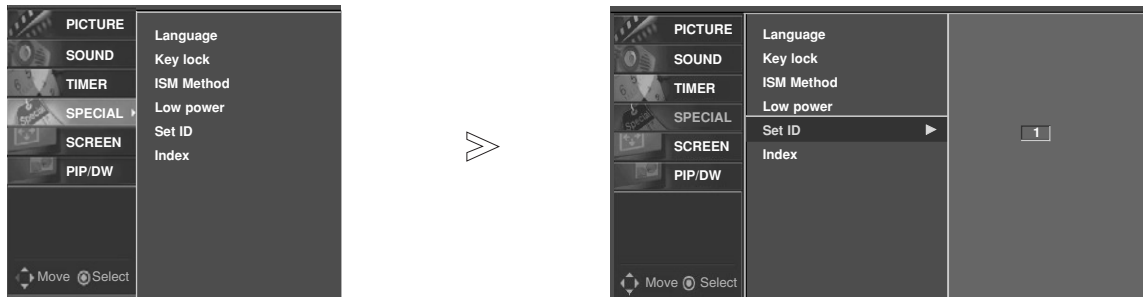

1. Press the **MENU** button and then use the **▲ / ▼** button to select the **SPECIAL** menu.
2. Press the **▶** button and then use **▲ / ▼** button to select **Set ID**.
3. Press the **▶** button and then use **◀ / ▶** button to adjust **Set ID** to choose the desired monitor ID number.
  - The adjustment range of **Set ID** is 1 ~ 99.

### Communication Parameters

- Baud rate : 9600 bps (UART)
- Data length : 8 bits
- Parity : None
- Stop bit : 1 bit
- Communication code : ASCII code

### Transmission / Receiving Protocol

#### Transmission

`[Command1][Command2][ ][Set ID][ ][Data][Cr]`

- \* [Command 1]: k, j, m
- \* [Command 2]: To control Plasma Monitor set.
- \* [Set ID]: You can adjust the set ID to choose desired monitor ID number in Special menu. Adjustment range is 1 ~ 99. When selecting Set ID '0', every connected Plasma Monitor set is controlled. Set ID is indicated as decimal (1~99) on menu and as Hexa decimal (0x0~0x63) on transmission/receiving protocol.
- \* [DATA]: To transmit command data.  
Transmit 'FF' data to read status of command.
- \* [Cr]: Carriage Return  
ASCII code '0x0D'
- \* [ ]: ASCII code 'space (0x20)'

#### OK Acknowledgement

`[Command2][ ][Set ID][ ][OK][Data][x]`

- \* The Monitor transmits ACK (acknowledgement) based on this format when receiving normal data. At this time, if the data is data read mode, it indicates present status data. If the data is data write mode, it returns the data of the PC computer.

#### Error Acknowledgement

`[Command2][ ][Set ID][ ][NG][x]`

- \* The Monitor transmits ACK (acknowledgement) based on this format when receiving abnormal data from non-viable functions or communication errors.

Data 1: Illegal Code  
2: Not supported function

### Command Reference List

	COMMAND 1	COMMAND 2	DATA (Hexadecimal)
01. Power	k	a	0 ~ 1
02. Input Select	k	b	1 ~ 9
03. Aspect Ratio	k	c	0 ~ 3
04. Screen Mute	k	d	0 ~ 1
05. Volume Mute	k	e	0 ~ 1
06. Volume Control	k	f	0 ~ 64
07. Contrast	k	g	0 ~ 64
08. Brightness	k	h	0 ~ 64
09. Color	k	i	0 ~ 64
10. Tint	k	j	0 ~ 64
11. Sharpness	k	k	0 ~ 64
12. OSD Select	k	l	0 ~ 1
13. Remote Control Lock Mode	k	m	0 ~ 1
14. PIP/DW	k	n	0 ~ 3
15. PIP Position	k	q	0 ~ 3
16. Treble	k	r	0 ~ 64
17. Bass	k	s	0 ~ 64
18. Balance	k	t	0 ~ 64
19. Color Temperature	k	u	0 ~ 2
20. PIP Input Select	k	y	1 ~ 9
21. Abnormal State	k	z	0 ~ a
22. ISM Method	j	p	0 ~ 3
23. Low Power	j	q	0 ~ 1
24. Picture Size Setting for DW mode	j	t	0 ~ oa
25. Auto Configure	j	u	1
26. Key	m	c	Key code



### 07. Contrast (Command 2:g)

- ▶ To adjust screen contrast.  
You can also adjust contrast in the picture menu.

Transmission

[k][g][ ][Set ID][ ][Data][Cr]

Data Min : 0 ~ Max : 64

- Refer to 'Real data mapping 1' as shown below.

Acknowledgement

[g][ ][Set ID][ ][OK][Data][x]

Data Min : 0 ~ Max : 64

\* Real data mapping 1

0 : Step 0

A : Step 10 (SET ID 10)

F : Step 15 (SET ID 15)

10 : Step 16 (SET ID 16)

63 : Step 99 (SET ID 99)

64 : Step 100

### 08. Brightness (Command 2:h)

- ▶ To adjust screen brightness.  
You can also adjust brightness in the Picture menu.

Transmission

[k][h][ ][Set ID][ ][Data][Cr]

Data Min : 0 ~ Max : 64

- Refer to 'Real data mapping 1'.

Acknowledgement

[h][ ][Set ID][ ][OK][Data][x]

Data Min : 0 ~ Max : 64

### 09. Color (Command 2:i)

- ▶ To adjust the screen color.  
You can also adjust color in the Picture menu.

Transmission

[k][i][ ][Set ID][ ][Data][Cr]

Data Min : 0 ~ Max : 64

- Refer to 'Real data mapping 1'.

Acknowledgement

[i][ ][Set ID][ ][OK][Data][x]

Data Min : 0 ~ Max : 64

### 10. Tint (Command 2:j)

- ▶ To adjust the screen tint.  
You can also adjust tint in the Picture menu.

Transmission

[k][j][ ][Set ID][ ][Data][Cr]

Data Red : 0 ~ Green : 64

- Refer to 'Real data mapping 1'.

Acknowledgement

[j][ ][Set ID][ ][OK][Data][x]

Data Red : 0 ~ Green : 64

### 11. Sharpness (Command 2:k)

- ▶ To adjust the screen sharpness.  
You can also adjust sharpness in the Picture menu.

Transmission

[k][k][ ][Set ID][ ][Data][Cr]

Data Min: 0 ~ Max: 64

- Refer to 'Real data mapping 1'.

Acknowledgement

[k][ ][Set ID][ ][OK][Data][x]

Data Min : 0 ~ Max : 64

### 12. OSD Select (Command 2:l)

- ▶ To select OSD (On Screen Display) on/off.

Transmission

[k][l][ ][Set ID][ ][Data][Cr]

Data 0: OSD off 1: OSD on

Acknowledgement

[l][ ][Set ID][ ][OK][Data][x]

Data 0: OSD off 1: OSD on

### 13. Remote Control Lock Mode (Command 2:m)

- ▶ To lock the remote control and front panel controls on the monitor

Transmission

[k][m][ ][Set ID][ ][Data][Cr]

Data 0: lock off 1: lock on

Acknowledgement

[m][ ][Set ID][ ][OK][Data][x]

Data 0: lock off 1: lock on

- If you're not using the remote control and front panel controls on the monitor, use this mode. When main power is on/off, remote control lock is released.

**14. PIP / DW (Command2:n)**

- ▶ To control the PIP (Picture-in-Picture) or DW.  
You can also control the PIP/DW using the PIP or DW button on the remote control or in the PIP/DW menu.

Transmission

[k][n][ ][Set ID][ ][Data][Cr]
--------------------------------

Data 0: PIP/DW off	2: DW1
1: PIP	3: DW2

Acknowledgement

[n][ ][Set ID][ ][OK][Data][x]
--------------------------------

Data 0: PIP/DW off	2: DW1
1: PIP	3: DW2

**15. PIP Position (Command2:q)**

- ▶ To select sub picture position for PIP.  
You can also adjust the sub picture position using Win.position on the remote control or in the PIP/DW menu.

Transmission

[k][q][ ][Set ID][ ][Data][Cr]
--------------------------------

Data 0: Right down on screen
1: Left down on screen
2: Left up on screen
3: Right up on screen

Acknowledgement

[q][ ][Set ID][ ][OK][Data][x]
--------------------------------

Data 0: Right down on screen
1: Left down on screen
2: Left up on screen
3: Right up on screen

**16. Treble (Command2:r)**

- ▶ To adjust treble.  
You can also adjust treble in the Sound menu.

Transmission

[k][r][ ][Set ID][ ][Data][Cr]
--------------------------------

Data Min: 0 ~ Max: 64
-----------------------

- Refer to 'Real data mapping 1'. See page 38.

Acknowledgement

[r][ ][Set ID][ ][OK][Data][x]
--------------------------------

Data Min: 0 ~ Max: 64
-----------------------

**17. Bass (Command2:s)**

- ▶ To adjust bass.  
You can also adjust bass in the Sound menu.

Transmission

[k][s][ ][Set ID][ ][Data][Cr]
--------------------------------

Data Min: 0 ~ Max: 64
-----------------------

- Refer to 'Real data mapping 1'. See page 38.

Acknowledgement

[s][ ][Set ID][ ][OK][Data][x]
--------------------------------

Data Min: 0 ~ Max: 64
-----------------------

**18. Balance (Command2:t)**

- ▶ To adjust balance.  
You can also adjust balance in the Sound menu.

Transmission

[k][t][ ][Set ID][ ][Data][Cr]
--------------------------------

Data Min: 0 ~ Max: 64
-----------------------

- Refer to 'Real data mapping 1'. See page 38.

Acknowledgement

[t][ ][Set ID][ ][OK][Data][x]
--------------------------------

Data Min: 0 ~ Max: 64
-----------------------

**19. Color Temperature (Command2:u)**

- ▶ To adjust color temperature.  
You can also adjust ACC in the Picture menu.

Transmission

[k][u][ ][Set ID][ ][Data][Cr]
--------------------------------

Data 0: Cool 1: Normal 2: Warm
--------------------------------

Acknowledgement

[u][ ][Set ID][ ][OK][Data][x]
--------------------------------

Data 0: Cool 1: Normal 2: Warm
--------------------------------

## 20. PIP Input Select (Command2:y)

► To select input source for sub picture in PIP mode.

### Transmission

[k][y][ ][Set ID][ ][Data][Cr]

Data 1 : Video1	6 : HDMI1/DVI
2 : Video2	7 : Video3
3 : Component1	8 : Video4
4 : Component2	9 : HDMI2
5 : RGB	

### Acknowledgement

[y][ ][Set ID][ ][OK][Data][x]

Data 1 : Video1	6 : HDMI1/DVI
2 : Video2	7 : Video3
3 : Component1	8 : Video4
4 : Component2	9 : HDMI2
5 : RGB	

## 21. Abnormal State (Command2:z)

► To recognize an abnormal state.

### Transmission

[k][z][ ][Set ID][ ][FF][Cr]

Data FF:Read

### Acknowledgement

[z][ ][Set ID][ ][OK][Data][x]

Data 0: Power on(signal)	6: AC detect off
1: Power on(No signal)	7: Fan Alarm off
2: Remote control off	8: Off timer off
3: Sleep time off	9: No signal off
4: RS-232C off	a: Connection Detect off
5: 5V monitor off	

\* If you do not press any button within 2 hours after the monitor turns on with the On Timer function, the monitor will automatically revert to standby mode.

## 22. ISM Method (Command2:p)

► To avoid having a fixed image remain on screen.

### Transmission

[j][p][ ][Set ID][ ][Data][Cr]

Data 0: Normal	2: Orbiter
1: White wash	3: Inversion

### Acknowledgement

[p][ ][Set ID][ ][OK][Data][x]

Data 0: Normal	2: Orbiter
1: White wash	3: Inversion

## 23. Low Power (Command2:q)

► To control the low power function on/off.

### Transmission

[i][q][ ][Set ID][ ][Data][Cr]

Data 0: Low power off  
1: Low power on

### Acknowledgement

[q][ ][Set ID][ ][OK][Data][x]

Data 0: Low power off  
1: Low power on

## 24. Picture Size Setting for DW mode (Command2:t)

► To adjust main picture size in DW mode.

### Transmission

[i][t][ ][Set ID][ ][Data][Cr]

Data Min: 0 ~ Max: 0a

• Refer to 'Real data mapping1'. See page 38.

### Acknowledgement

[t][ ][Set ID][ ][OK][Data][x]

Data Min: 0 ~ Max: 0a

## 25. Auto Configure (Command2:u)

► To adjust picture position and minimize image shaking automatically. Auto Configure only works in RGB-PC mode.

### Transmission

[i][u][ ][Set ID][ ][Data][Cr]

Data 1

• Refer to 'Real data mapping1'. See page 38.

### Acknowledgement

[u][ ][Set ID][ ][OK][Data][x]

Data 1

## 26. Key (Command2:c)

► To adjust Key code for IR remote control.

### Transmission

[m][c][ ][Set ID][ ][Data][Cr]

Data Key code : Refer to See page 42.

### Acknowledgement

[c][ ][Set ID][ ][OK][Data][x]



# IR Code

## How to Connect

- ▶ Connect your wired remote control to the Remote Control port on the Monitor.

## Remote Control IR Code

### ▶ Output waveform

Single pulse, modulated with 37.917KHz signal at 455KHz

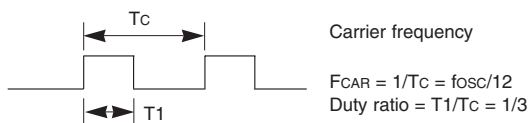

### ▶ Configuration of frame

- 1st frame



- Repeat frame

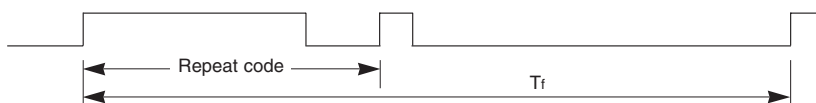

### ▶ Lead code



### ▶ Repeat code

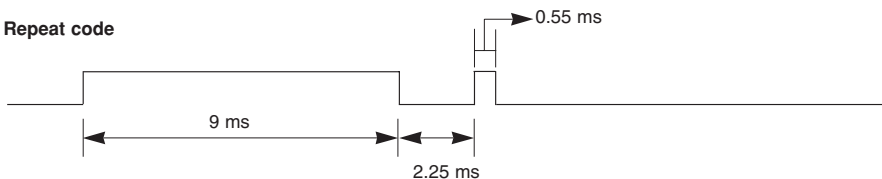

### ▶ Bit description

- Bit "0"

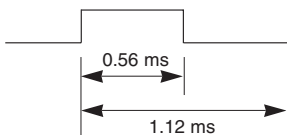

- Bit "1"

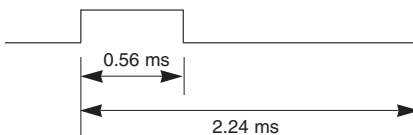

### ▶ Frame interval : Tf

The waveform is transmitted as long as a key is depressed.

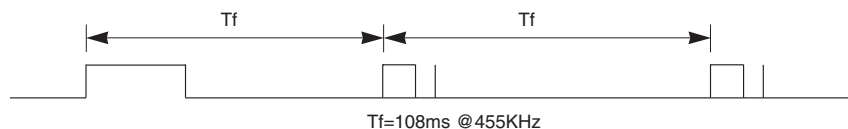

Code (Hexa)	Function	Note
10	Number Key 0	R/C Button
11	Number Key 1	R/C Button
12	Number Key 2	R/C Button
13	Number Key 3	R/C Button
14	Number Key 4	R/C Button
15	Number Key 5	R/C Button
16	Number Key 6	R/C Button
17	Number Key 7	R/C Button
18	Number Key 8	R/C Button
19	Number Key 9	R/C Button
0E	SLEEP	R/C Button
09	MUTE	R/C Button
08	POWER	R/C Button (Power On/Off)
02	VOL+	R/C Button
03	VOL-	R/C Button
00	CH+	R/C Button
01	CH-	R/C Button
4D	APC	R/C Button
52	DASP	R/C Button
44	ENTER (■)	R/C Button
0B	All INPUT SELECT	R/C Button
43	MENU	R/C Button
79	ARC	R/C Button (4:3/16:9/Horizon/Zoom mode Selection)
62	Window Position	R/C Button
64	Window Size	R/C Button
07	◀	R/C Button
06	▶	R/C Button
40	▲	R/C Button
41	▼	R/C Button
5B	EXIT	R/C Button
60	PIP	R/C Button
92	XD	R/C Button
61	PIP Input	R/C Button
6B	DW	R/C Button
CD	Video	R/C Button
CE	HDMI2	R/C Button
3E	Key lock	R/C Button
75	Index	R/C Button
99	Auto config.	Discrete IR Code (Only RGB mode)
5A	Input video1	Discrete IR Code (Input Video 1 Selection)
D0	Input video2	Discrete IR Code (Input Video 2 Selection)
BF	Input Component 1	Discrete IR Code (Input Component 1 Selection)
D4	Input Component 2	Discrete IR Code (Input Component 2 Selection)
D5	Input RGB	Discrete IR Code (Input RGB Selection)
C6	Input HDMI1/DVI	Discrete IR Code (Input HDMI1/DVI Selection)

# Programming the Remote

- The remote control is a multi-brand or universal remote control. It can be programmed to operate most remote-controllable devices of other manufacturers.  
Note that the remote control may not control all models of other brands.

## Programming a code into a remote mode

1. Test your remote control.  
To find out whether your remote control can operate the component without programming, turn on the component such as a VCR and press the corresponding **MODE** button (VCR) on the remote control, while pointing at the component.
2. Turn on the component to be programmed, then press the corresponding **MODE** button on the remote control.
3. Press the **MENU** and **MUTE** buttons simultaneously, the remote control is ready to be programmed for the code.
4. Enter a code number using the number buttons on the remote. Programming code numbers for the corresponding component can be found on the following pages. Again, if the code is correct, the device will turn off.
5. Press the **MENU** button to store the code.
6. Test the remote control functions to see if the component responds properly. If not, repeat from step 1.

# Programming Codes

## VCRs

Brand	Codes	Brand	Codes	Brand	Codes	Brand	Codes
AIWA	034	KENWOOD	014 034 039 043	PORTLAND	108	TATUNG	039 043
AKAI	016 043 046 124		047 048	PULSAR	072	TEAC	034 039 043
	125 146	LG (GOLDSTAR)	001 012 013 020	QUARTZ	011 014	TECHNICS	031 033 070
AMPRO	072		101 106 114 123	QUASAR	033 066 075 145	TEKNIKA	019 031 033 034
ANAM	031 033 103	LLOYD	034	RCA	013 020 033 034		101
AUDIO DYNAMICS	012 023 039 043	LXI	003 009 013 014		040 041 062 063	THOMAS	034
BROKSONIC	035 037 129		017 034 101 106		107 109 140 144	TMK	006
CANON	028 031 033	MAGIN	040		145 147	TOSHIBA	008 013 042 047
CAPEHART	108	MAGNAVOX	031 033 034 041	REALISTIC	003 008 010 014		059 082 112 131
CRAIG	003 040 135		067 068		031 033 034 040	TOTEVISION	040 101
CURTIS MATHES	031 033 041	MARANTZ	012 031 033 067		053 054 101	UNITECH	040
DAEWOO	005 007 010 064		069	RICO	058	VECTOR RESEARCH	012
	065 108 110 111	MARTA	101	RUNCO	148	VICTOR	048
	112 116 117 119	MATSUI	027 030	SALORA	014	VIDEO CONCEPTS	012 034 046
DAYTRON	108	MEI	031 033	SAMSUNG	032 040 102 104	VIDEOSONIC	040
DBX	012 023 039 043	MEMOREX	003 010 014 031		105 107 109 112	WARDS	003 013 017 024
DYNATECH	034 053		033 034 053 072		113 115 120 122		031 033 034 040
ELECTROHOME	059		101 102 134 139		125		053 054 131
EMERSON	006 017 025 027	MGA	045 046 059	SANSUI	022 043 048 135	YAMAHA	012 034 039 043
	029 031 034 035	MINOLTA	013 020	SANYO	003 007 010 014	ZENITH	034 048 056
	036 037 046 101	MITSUBISHI	013 020 045 046		102 134		058 072 080 101
	129 131 138 153		049 051 059 061	SCOTT	017 037 112 129		
FISHER	003 008 009 010		151		131		
FUNAI	034	MTC	034 040	SEARS	003 008 009 010		
GE	031 033 063 072	MULTITECH	024 034		013 014 017 020		
	107 109 144 147	NEC	012 023 039 043		031 042 073 081		
GO VIDEO	132 136		048		101		
HARMAN KARDON	012 045	NORDMENDE	043	SHARP	031 054 149		
HITACHI	004 018 026 034	OPTONICA	053 054	SHINTOM	024		
	043 063 137 150	PANASONIC	066 070 074 083	SONY	003 009 031 052		
INSTANTREPLAY	031 033		133 140 145		056 057 058 076		
JCL	031 033	PENTAX	013 020 031 033		077 078 149		
JCPENNY	012 013 015 033		063	SOUNDESIGN	034		
	040 066 101	PHILCO	031 034 067	STS	013		
JENSEN	043	PHILIPS	031 033 034 054	SYLVANIA	031 033 034 059		
JVC	012 031 033 043		067 071 101		067		
	048 050 055 060	PILOT	101	SYMPHONIC	034		
	130 150 152	PIONEER	013 021 048	TANDY	010 034		

## CATV

Brand	Codes	Brand	Codes	Brand	Codes	Brand	Codes
ABC	003 004 039 042	GOLDEN CHANNEL	030		065 085 090	SL MARX	030
	046 052 053	HAMLIN	049 050 055	PIONEER	034 051 052 063	SPRUCER	047 078
AJIN	112	HITACHI	052 055		076	STARCOM	002 004 008 009
ANTRONIK	014	HOSPITALITY	070 077	POST NEWS WEEK	016	STARGATE	008 030
ARCHER	005 007 014 024	JERROLD	002 003 004 008	PRUCER	059	SYLVANIA	067
CABLE STAR	026		009 010 052 069	PTS	011 048 071 072	TADIRAN	030
CENTURION	092		074		073 074	TAEKWANG	110
CENTURY	007	LG (GOLDSTAR)	001 106 101 005	PULSAR	100	TAIHAN	105
CITIZEN	007	M-NET	037	RCA	047	TANDY	017
COLOUR VOICE	065 090	MACOM	033	REGAL	049 050	TEXSCAN	029 067
COMBANO	080 081	MAGNAVOX	010 012 064 079	REGENCY	057	TOCOM	039 040 056
COMTRONICS	019 030	MEMOREX	100	REMBRANT	025	TOSHIBA	100
DIAMOND	023	MOVIE TIME	028 032	RK	091	UNIKA	007 014 024
EAGLE	020 030 040	NSC	015 028 038 071	SAMSUNG	102 107 030 068	UNITED CABLE	004 053
EASTERN	057 062 066		073	SCIENTIFIC ATLANTA	003 011 041 042	UNIVERSAL	005 007 014 024
ELECTRICORD	032	OAK	016 031 037 053		043 045 046		026 027 032 035
GE	072	PANASONIC	044 047	SHERITECH	022	VIEWSTAR	012 015 018 086
GEMINI	008 022 025 054	PARAGON	100	SIGNAL	030		087 088 089
GI	052 074	PHILIPS	006 012 013 020	SIGNATURE	052	ZENITH	100 114 060 093

HDSTB

Brand	Codes	Brand	Codes	Brand	Codes	Brand	Codes
ALPHASTAR DSR	123	EUROPLUS	114	MEMOREX	057	STARCAST	041
AMPLICA	050	FUJITSU	017 021 022 027	NEXTWAVE	028 124 125	SUPER GUIDE	020 124 125
BIRDVIEW	051 126 129		133 134	NORSAT	069 070	TEECOM	023 026 075 087
BSR	053	GENERAL INSTRUMENT	003 004 016 029	PACE SKY SATELLITE	143		088 090 107 130
CAPETRONICS	053		031 059 101	PANASONIC	060 142		137
CHANNEL MASTER	013 014 015 018	HITACHI	139 140		121	TOSHIBA	002 127
	036 055	HOUSTON TRACKER	033 037 039 051	PERSONAL CABLE	117	UNIDEN	016 025 042 043
CHAPARRAL	008 009 012 077		057 104	PHILIPS	071		044 045 048 049
CITOH	054	HUGHES	068	PICO	105		078 079 080 086
CURTIS MATHES	050 145	HYTEK	053	PRESIDENT	019 102		101 135 136
DRAKE	005 006 007 010	JANIEL	060 147	PRIMESTAR	030 110 111	VIEWSTAR	115
	011 052 112 116	JERROLD	061	PROSAT	072	WINEGARD	128 146
	141	KATHREIN	108	RCA	066 106	ZENITH	081 082 083 084
DX ANTENNA	024 046 056 076	LEGEND	057	REALISTIC	043 074		091 120
ECHOSTAR	038 040 057 058	LG	001	SAMSUNG	123		
	093 094 095 096	LUTRON	132	SATELLITE SERVICE CO	028 035 047 057		
	097 098 099 100	LUXOR	062 144		085		
	122	MACOM	010 059 063 064	SCIENTIFIC ATLANTA	032 138		
ELECTRO HOME	089		065	SONY	103		

Audio

Brand	Codes	Brand	Codes	Brand	Codes	Brand	Codes
AIWA	014 028 070 096	JVC	004 013 141	PHILIPS	026 112 143 253		147 218
	125 129 139 229	KEC	185 186 187	PIONEER	039 042 043 063	TOSHIBA	137
	230	KENWOOD	038 050 067 089		065 091 093 094	THE	061
AKAI	163		170 171 197 206	QUASAR	115 123 127 250	VICTOR	088 131
ANAM	003 014 017 023		215 222	RCA	113	WARDS	089
	059 106 189 216	KOHEL	030	RCX	080	YAMAHA	054 055 066 092
	217 235 236	NAD	045 046		092		199
BURMECTER	252	LOTTE	014 016 036 098	REALISTIC	103 106		
CARVER	086		100 172 173 174	SAMSUNG	124 145 146 182		
CLARION	199		175 176 177 178		193 194 195 203		
DAEWOO	027 053 060 184		179 180 181 183		204 244 245 246		
	102 148 198 221		201 202 208 213	SANSUI	011 135 138 144		
DENON	015 075 130 143		214 219 223 232	SANYO	019 083 234		
FANTASIA	071		238 240	SCOTT	106 186		
FINEARTS	022	LXI	103	SHARP	031 032 051		
FISHER	089 099	MAGNAVOX	111		072 082 117 119		
LG(GOLDSTAR)	001 021 024 029	MARANTZ	002 018 020 025		156 184 199 200		
	087 107 108 110		034 041 081 090	SHERWOOD	206 209		
	190 191 192 210		097 112	SONY	005 006 158		
	211 212 239	MCINTOSH	049		044 045 109 114		
HAITAI	034 035 188 222	MCS	104		118 126 248 249		
HARMAN/KARDON	068	MEMOREX	107	TAEKWANG	012 020 073 074		
INKEL	037 058 062 069	NAD	046		076 077 105 161		
	078 079 095 121	ONKYO	013 040 041 047		162 163 164 165		
	122 149 150 151		048 056 057 132		166 167 168 169		
	152 153 154 155		133 140		205 231 233 242		
	157 158 159 160	OPTIMUS	158	TEAC	254		
	189 207 222 224	PANASONIC	007 033 064 113		010 085 106 136		
	225 226 227 243		142 220 241 251		185 187 237		
	247	PENNEY	104	TECHNICS	101 113 128 134		

DVD

Brand	Codes	Brand	Codes	Brand	Codes	Brand	Codes
APEX DIGITAL	022	MAGNAVOX	013	PHILIPS	013	SONY	007
DENON	020 014	MARANTZ	024	PIONEER	004 026	THOMPSON	005 006
GE	005 006	MITSUBISHI	002	PROCEED	021	TOSHIBA	019 008
HARMAN KARDON	027	NAD	023	PROSCAN	005 006	YAMAHA	009 018
JVC	012	ONKYO	008 017	RCA	005 006	ZENITH	010 016 025
LG	001 010 016 025	PANASONIC	003 009	SAMSUNG	011 015		

## Troubleshooting Checklist

<b>No picture &amp; No sound</b>	<ul style="list-style-type: none"><li>• Check whether the Monitor is turned on.</li><li>• Power cord inserted into wall outlet?</li><li>• Test the wall power outlet, plug other product's power cord into the wall outlet where the Monitor's power cord was plugged in.</li></ul>
<b>Picture OK &amp; No sound</b>	<ul style="list-style-type: none"><li>• Press the <b>VOLUME (+)</b> button.</li><li>• Sound muted? Press <b>MUTE</b> button.</li></ul>
<b>The remote control doesn't work</b>	<ul style="list-style-type: none"><li>• Check to see if there is any object between the Plasma Display and the remote control causing obstruction.</li><li>• Are batteries installed with correct polarity (+ to +, - to -)? (Refer to p.11)</li><li>• Install new batteries. (Refer to p.11)</li></ul>
<b>Picture appears slowly after switching on</b>	<ul style="list-style-type: none"><li>• This is normal, the image is muted during the plasma display startup process. Please contact your service center, if the picture has not appeared after five minutes.</li></ul>
<b>No or Poor color or Poor picture</b>	<ul style="list-style-type: none"><li>• Select <b>Color</b> in the <b>Picture</b> menu and press the ► button. (Refer to p.21)</li><li>• Keep a sufficient distance between the Monitor and the VCR.</li><li>• Activate any function to restore the brightness of the picture. (If still picture is on the screen for more than 5 minutes, the screen gets dark.)</li></ul>
<b>Horizontal/vertical bars or picture shaking</b>	<ul style="list-style-type: none"><li>• Check for local interference such as an electrical appliance or power tool.</li></ul>
<b>No output from one of the speakers</b>	<ul style="list-style-type: none"><li>• Adjust <b>Balance</b> in the <b>Sound</b> menu. (Refer to p.22)</li></ul>
<b>Unusual sound from inside the monitor</b>	<ul style="list-style-type: none"><li>• A change in ambient humidity or temperature may result in an unusual noise when the plasma display is turned on or off and does not indicate a fault with the monitor.</li></ul>

# Product Specifications

MODELS		71PY1M (71PY1M-WA)	71PY1MG (71PY1MG-WA)	71PY1MC (71PY1MC-WA)
Width (inches / mm)		68.9 / 1750	68.9 / 1750	68.9 / 1750
Height (inches / mm)		38.7 / 982	38.7 / 982	38.7 / 982
Depth (inches / mm)		3.9 / 98	3.9 / 98	3.9 / 98
Weight (pounds / kg)		194.9 / 88.4	194.9 / 88.4	194.9 / 88.4
Power requirement		AC100-240V ~ 50/60Hz		
Resolution		1920 x 1080 (Dot)		
Viewing Size (mm)		1512.26		
Environmental condition	Operating Temperature	32 ~ 104°F (0 ~ 40°C)		
	Operating Humidity	Less than 80%		
	Storage Temperature	-4 ~ 140°F (-20 ~ 60°C)		
	Storage Humidity	Less than 85%		

- The specifications shown above may change without notice for quality improvement.

