



LCD TV | PLASMA TV OWNER'S MANUAL

LCD TV MODELS

37LC2RR*
42LC2RR*

PLASMA TV MODELS

42PC1RR*
50PB2RR*

Please read Information Manual included together before reading this manual and operating your set.

Retain it for future reference.
Record model number and serial number of the set.
See the label attached on the back cover and quote this information to your dealer when you require service.

Model number :
Serial number :

ACCESSORIES

Ensure that the following accessories are included with your set. If an accessory is missing, please contact the dealer where you purchased the set.

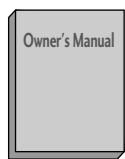

Owner's Manual



Batteries



Remote Control

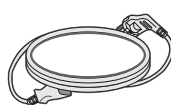

Power Cord

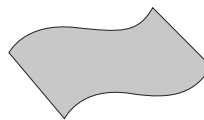

Polishing Cloth
Polish the screen with the cloth
(Option)

Slightly wipe stained spot on the exterior only with the cleansing cloths for the product exterior if there is stain or fingerprint on surface of the exterior.

Do not wipe roughly when removing stain. Please be cautious of that excessive power may cause scratch or discoloration.

For 42PC1RR*



2-Wall brackets



2-eye-bolts



2-bolts for stand assembly
(Refer p.11)

This feature is not available for all models.

For 37LC2RR*, 42LC2RR*



2-TV brackets
2-Wall brackets



Twister Holder
Arrange the wires with the twister holder.



Cable Management



2-bolts

For 50PB2RR*



2-Wall brackets



2-eye-bolts

CONTENTS

Accessories 1

INTRODUCTION

Controls / Connection Options 4-8
Remote Control Key Functions 9-10
Home Menu 11

INSTALLATION

Unfolding The Base Stand 12
Basic connection 13-14
How to join the set assembly to the wall to protect the
set tumbling 15
Stand installation 16

CONNECTIONS & SETUP

Antenna Connection 17
VCR Setup 18-19
External Equipment Connections 20
DVD Setup 21-22
STB(SET-TOP BOX) Setup 23-24
PC Setup 25-27

BASIC OPERATION

Turning the set on 28
Volume Adjustment 28
Programme Selection 28
On-Screen Menu Language Selection (option) ... 28

SPECIAL FUNCTIONS

DVR (Digital Video Recorder)

TimeShift 29
Progressing the Timeshift function 30-31
Recording 32-33
Watching & Record 34
Recorded TV 35
Recorded program Selection and Popup Menu .35-36
Playing recorded programs 36
Using the remote control 37
Manual Recording 38
Scheduled List 39
Video Quality 39
Format hard disk 40

PIP/POP/Twin Picture

PIP (Picture-In-Picture) Feature 41
Watching PIP 41
Adjusting PIP Transparency (PIP mode only) 41
Programme Selection for Sub Picture 42
Adjusting the screen for the PIP 42
Selecting an Input Signal Source for the PIP 42
Sub Picture Size Adjustment (PIP mode only) ... 42
Moving the PIP (PIP mode only) 42
Swapping between main and sub pictures 43
POP (Picture-out-of-Picture: Channel Scan) 43

TELETEXT

Teletext Language Selection (option) 44
Switch on/off 44
SIMPLE Text (option) 45
TOP Text (option) 45
FASTEXT 45
Special Teletext Functions 46

TV MENU

On Screen Menus Selection and Adjustment 47

Setting up TV stations

Auto programme Tuning 48
 Manual programme Tuning 49
 Fine tuning 50
 Assigning a station name 51
 Booster (option) 52
 Programme edit 53
 Favourite programme 54
 Calling the programme table 55

Picture Menu Options

PSM (Picture Status Memory) 56
 CSM (Colour Status Memory) 57
 Manual Colour Temperature Control (CSM - User option) 58
 XD Function 59
 sRGB Function 60
 ACM (Active Colour Management) 61
 Manual Picture Control 62

Sound Menu Options

SSM (Sound Status Memory) 63
 AVL (Auto Volume Leveler) 64
 Adjusting Sound Control 65
 TV Speaker 65
 Stereo/Dual Reception 66
 NICAM Reception (option) 67
 Sound Output Selection 67

Time Menu Options

Setting the Clock 68
 Setting the On/Off Time 69
 Auto Sleep 70
 Sleep Timer 70

Special Menu Options

Child Lock 71
 ISM Method (Image Sticking Minimization) 72
 Low Power 73
 XD Demo 73
 Index (option) 74

Screen Menu Options

Auto Config. 75
 Manual Config. 76
 Selecting Wide XGA/VGA mode 77
 Setting Picture Format 78
 Cinema 79
 NR (Noise Reduction) 80
 Initializing (Reset to original factory settings) ... 80

APPENDIX

External Control Device Setup 81-87
 IR Codes 88-89
 Programming the Remote 90
 Programming Codes 91-94
 Troubleshooting Checklist 95-96
 Maintenance 97
 Product Specifications 98-99

INTRODUCTION

CONTROLS

This manual explains the features available on the 42PC1RR* set.

- This is a simplified representation of a front panel. Here shown may be somewhat different from your set.

Front Panel Controls

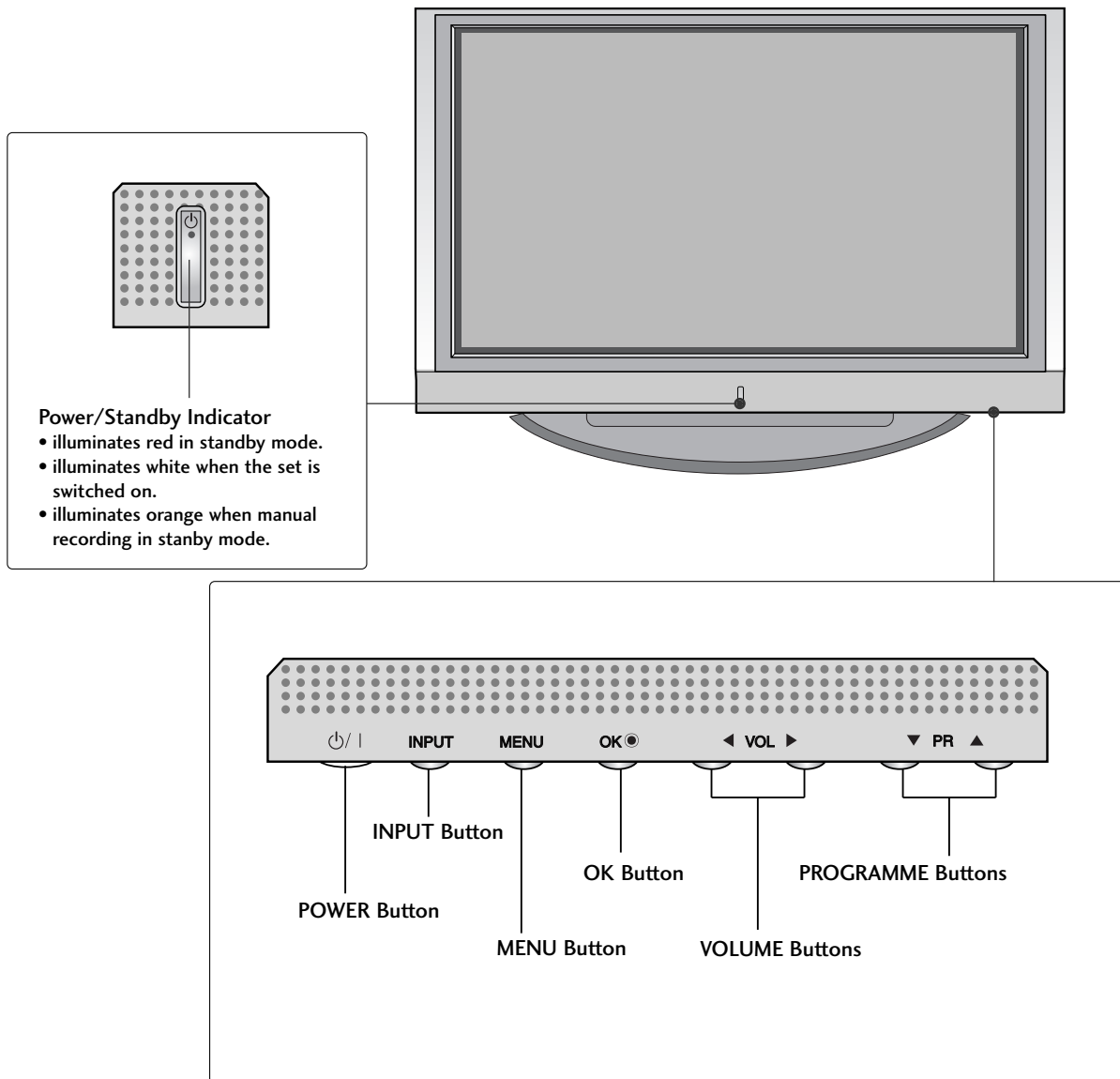

CONNECTION OPTION

This is the back panel of 42PC1RR* sets.

Back Connection Panel

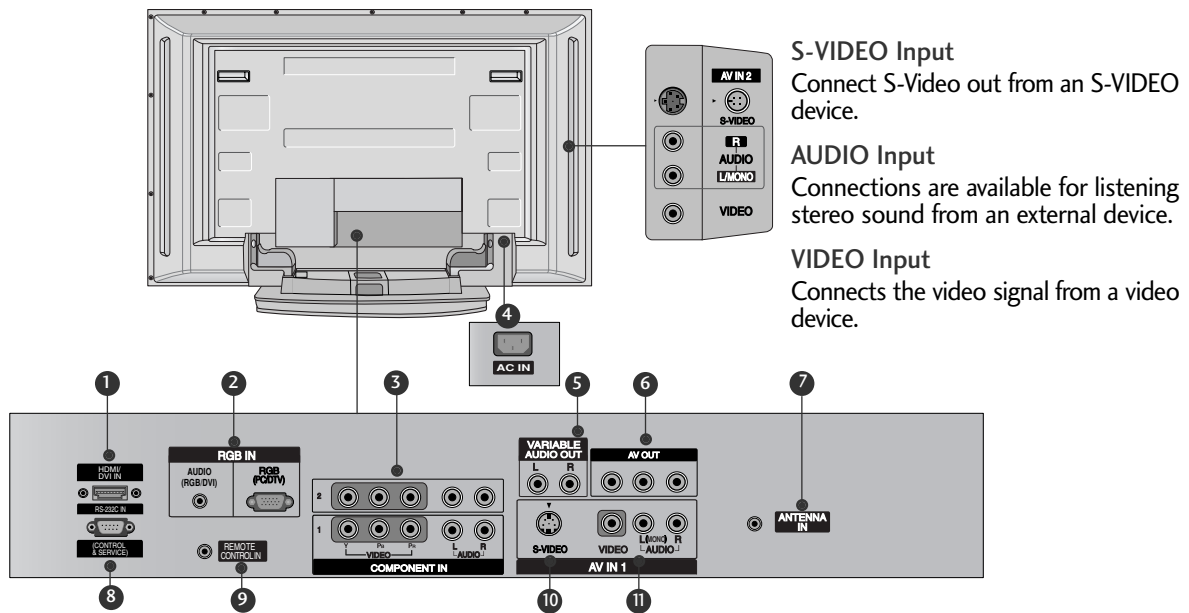

① HDMI/DVI Input

Connect a HDMI signal to HDMI/DVI.

② RGB/Audio Input

Connect the monitor output from a PC/DTV to the appropriate input port.

③ Component Input

Connect a component video/audio device to these jacks.

④ Power Cord Socket

This set operates on an AC power. The voltage is indicated on the Specifications page. Never attempt to operate the set on DC power.

⑤ Variable Audio Output

Connect an external amplifier or add a subwoofer to your surround sound system.

⑥ AV Output

Connect second TV or monitor to the AV OUT socket on the set.

⑦ Antenna Input

⑧ RS-232C Input (CONTROL & SERVICE) Port

Connect the serial port of the control devices to the RS-232C jack.

⑨ Remote Control Port

⑩ S-Video Input

Connect S-Video out from an S-VIDEO device.

⑪ Audio/Video Input

Connect audio/video output from an external device to these jacks.

S-VIDEO Input

Connect S-Video out from an S-VIDEO device.

AUDIO Input

Connections are available for listening stereo sound from an external device.

VIDEO Input

Connects the video signal from a video device.

INTRODUCTION

CONTROLS

This is the front panel of models 37LC2RR*, 42LC2RR*, 50PB2RR* sets.

- This is a simplified representation of a front panel. Here shown may be somewhat different from your set.

<Front Panel 37LC2RR*, 42LC2RR*>



Remote Control Sensor

Power/Standby Indicator

- illuminates red in standby mode.
- illuminates white when the set is switched on.
- illuminates orange when manual recording in standby mode.

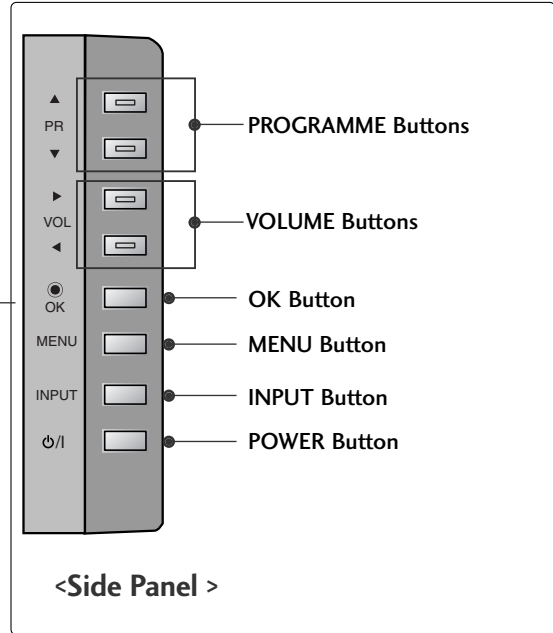

<Side Panel >

<Front Panel 50PB2RR*>

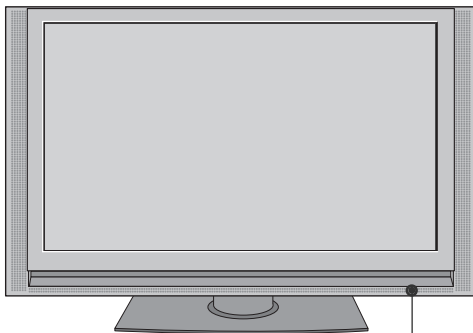

Remote Control Sensor

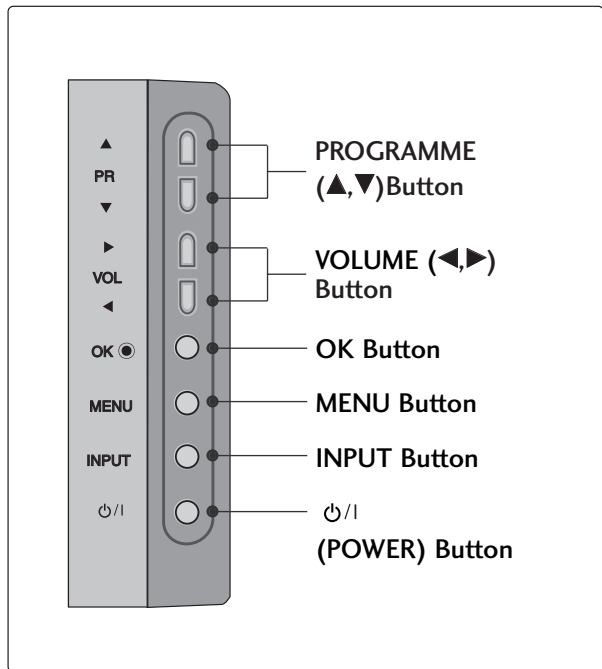

CONNECTION OPTION

This is the back panel of models 37LC2RR*, 42LC2RR* sets.

Back Connection Panel

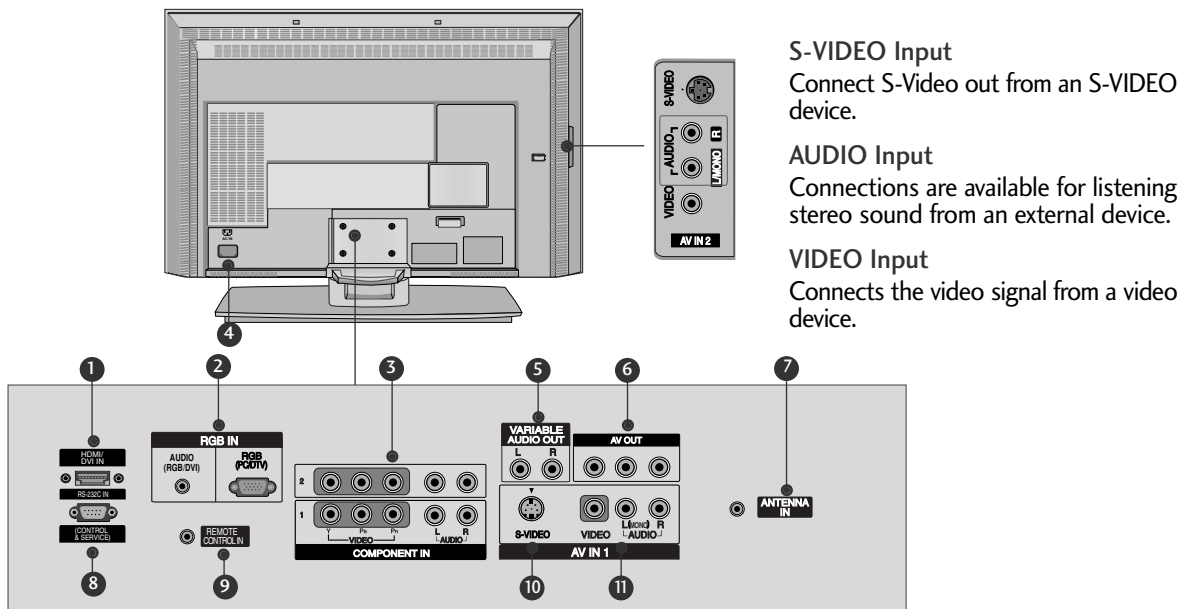

S-VIDEO Input

Connect S-Video out from an S-VIDEO device.

AUDIO Input

Connections are available for listening stereo sound from an external device.

VIDEO Input

Connects the video signal from a video device.

1 HDMI/DVI Input

Connect a HDMI signal to HDMI/DVI.

2 RGB/Audio Input

Connect the monitor output from a PC/DTV to the appropriate input port.

3 Component Input

Connect a component video/audio device to these jacks.

4 Power Cord Socket

This set operates on an AC power. The voltage is indicated on the Specifications page. Never attempt to operate the set on DC power.

5 Variable Audio Output

Connect an external amplifier or add a subwoofer to your surround sound system.

6 AV Output

Connect second TV or monitor to the AV OUT socket on the set.

7 Antenna Input

8 RS-232C Input(CONTROL&SERVICE)Port

Connect the serial port of the control devices to the RS-232C jack.

9 Remote Control Port

10 S-Video Input

Connect S-Video out from an S-VIDEO device.

11 Audio/Video Input

Connect audio/video output from an external device to these jacks.

INTRODUCTION

CONNECTION OPTION

This is the back panel of 50PB2RR+ sets.

Back Connection Panel

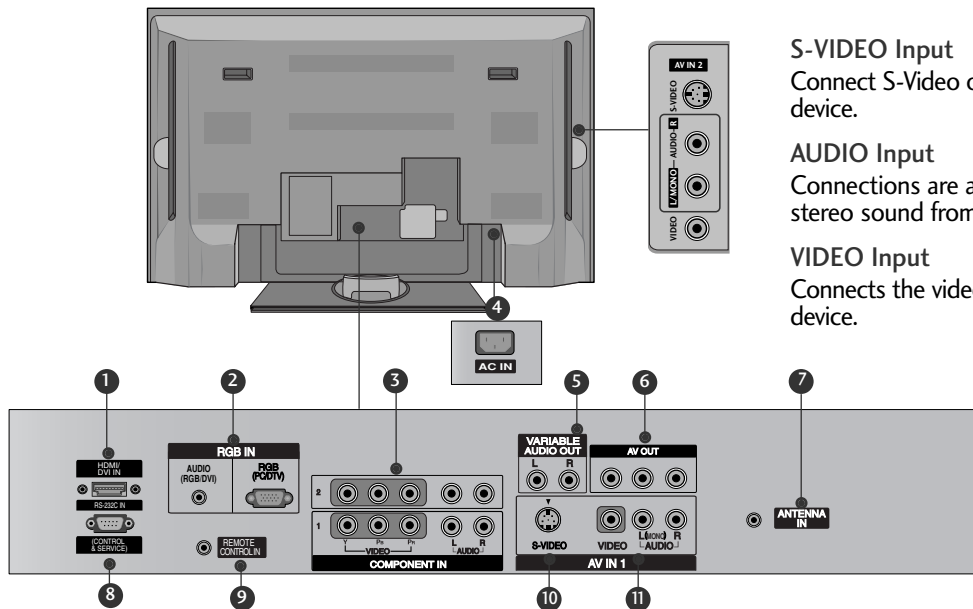

S-VIDEO Input
Connect S-Video out from an S-VIDEO device.

AUDIO Input
Connections are available for listening stereo sound from an external device.

VIDEO Input
Connects the video signal from a video device.

- 1 HDMI/DVI Input**
Connect a HDMI signal to HDMI/DVI.
- 2 RGB/Audio Input**
Connect the monitor output from a PC/DTV to the appropriate input port.
- 3 Component Input**
Connect a component video/audio device to these jacks.
- 4 Power Cord Socket**
This set operates on an AC power. The voltage is indicated on the Specifications page. Never attempt to operate the set on DC power.
- 5 Variable Audio Output**
Connect an external amplifier or add a subwoofer to your surround sound system.
- 6 AV Output**
Connect second TV or monitor to the AV OUT socket on the set.
- 7 Antenna Input**
- 8 RS-232C Input (CONTROL & SERVICE) Port**
Connect the serial port of the control devices to the RS-232C jack.
- 9 Remote Control Port**
- 10 S-Video Input**
Connect S-Video out from an S-VIDEO device.
- 11 Audio/Video Input**
Connect audio/video output from an external device to these jacks.

REMOTE CONTROL KEY FUNCTIONS

When using the remote control, aim it at the remote control sensor on the set.
There may be a defect in consecutive operation of remote control in a specified brightness according to this set.

- POWER** switches the set on from standby or off to standby.
 - INPUT** Selects the TV, AV, Component, RGB or HDMI/DVI modes. switches the set on from standby.
 - MULTIMEDIA** Selects the Component, RGB or HDMI/DVI modes. switches the set on from standby.
-
- MODE** Selects another device.
-
- VCR BUTTONS** Controls a video cassette recorder. These buttons are used for **TIME MACHINE**. For further details, see the 'TIME MACHINE' section.
 - MARK** Selects the wanted functions.
 - LIVE TV** In TV, AV1, AV2, Component modes, screen returns to the live programme. (Refer to p.37)
-
- TIME MACHINE** Brings up the Home menu.
 - MENU** Displays on screen menus one by one. Exits the current menu. Memorizes menu changes.
 - EXIT** Clears all on-screen displays and returns to TV viewing from any menu.
-
- VOL ▲ / ▼ (Volume Up/Down)** Increases/decreases sound level.
 - PR ▲ / ▼ (Programme Up/Down)** Select a programme. Switches the set on from standby.
 - MUTE** Switches the sound on or off.
 - TEXT** These buttons are used for teletext. For further details, see the 'Teletext' section. *Note : In teletext mode, the PIP PR +/-, SWAP and PIP INPUT buttons are used for teletext function.*
-
- ARC** Changes the picture format.
 - I/II** Selects the language during dual language broadcast. Selects the sound output.



INTRODUCTION

REMOTE CONTROL KEY FUNCTIONS

<p>OK accepts your selection or displays the current mode.</p> <p>▲ / ▼ or ◀ / ▶ (TIME SHIFT) Adjusts menu settings. Selects menu item.</p>	
<p>PIP Switches the sub picture on or off. Selects PIP, POP or DW modes.</p> <p>PIP PR +/- Selects a programme for the sub picture.</p> <p>SWAP Alternates between main and sub picture.</p> <p>PIP INPUT Selects the input mode for the sub picture.</p> <p>SIZE Adjusts the sub picture size.</p> <p>POSITION Moves the sub picture to ▲ / ▼ or ◀ / ▶ direction.</p>	
<p>NUMBER buttons Selects a programme. Selects numbered items in a menu. Switches the set on from standby.</p> <p>LIST Displays the programme table.</p> <p>Q.VIEW Returns to the previously viewed programme.</p>	
<p>SLEEP Sets the sleep timer.</p> <p>FAV Selects a favourite programme.</p>	

Installing Batteries

1 Open the battery compartment cover on the back side.



2 Insert two batteries in correct polarity (+ with +, - with -). Don't mix old or used batteries with new ones.

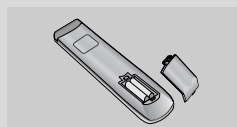

3 Close the cover.

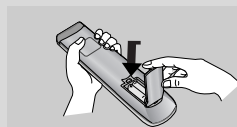

Remote control effective range

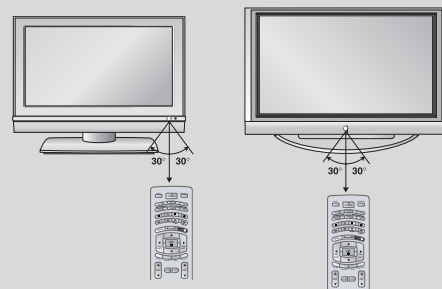

- Use a remote control 7 meter distance and 30 degree (left/right) within the receiving unit scope.
- Dispose of used batteries in a recyclebin to preserve environment.

INTRODUCTION

HOME MENU

This menu is a contents guide.

In Home Menu, you enter the Recorded list of DVR, Manual Rec, Scheduled List or TV Menu.

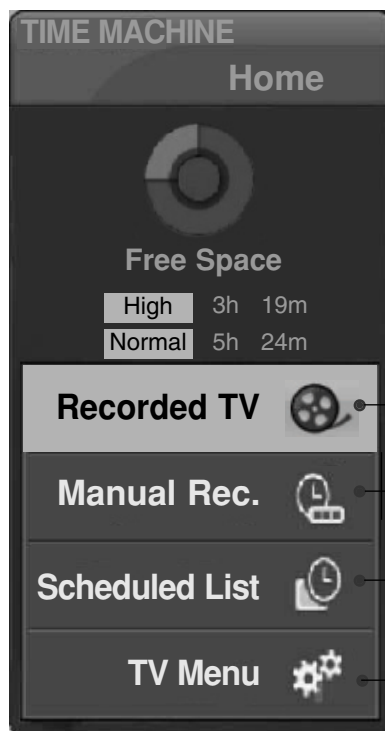
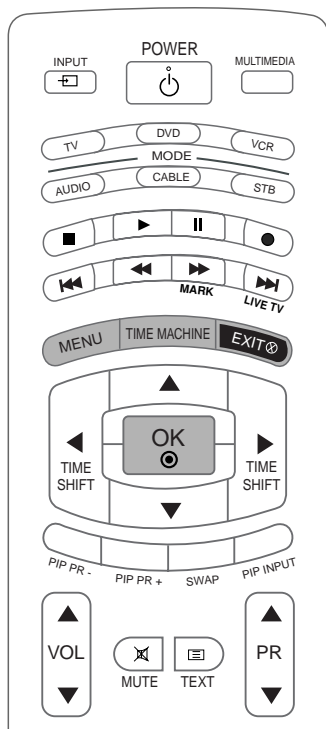

DVR
▶ p.29

TV Menu
▶ p.47

INSTALLATION

UNFOLDING THE BASE STAND (42PC1RR*)

- This feature is not available for all models.

INSTALLATION

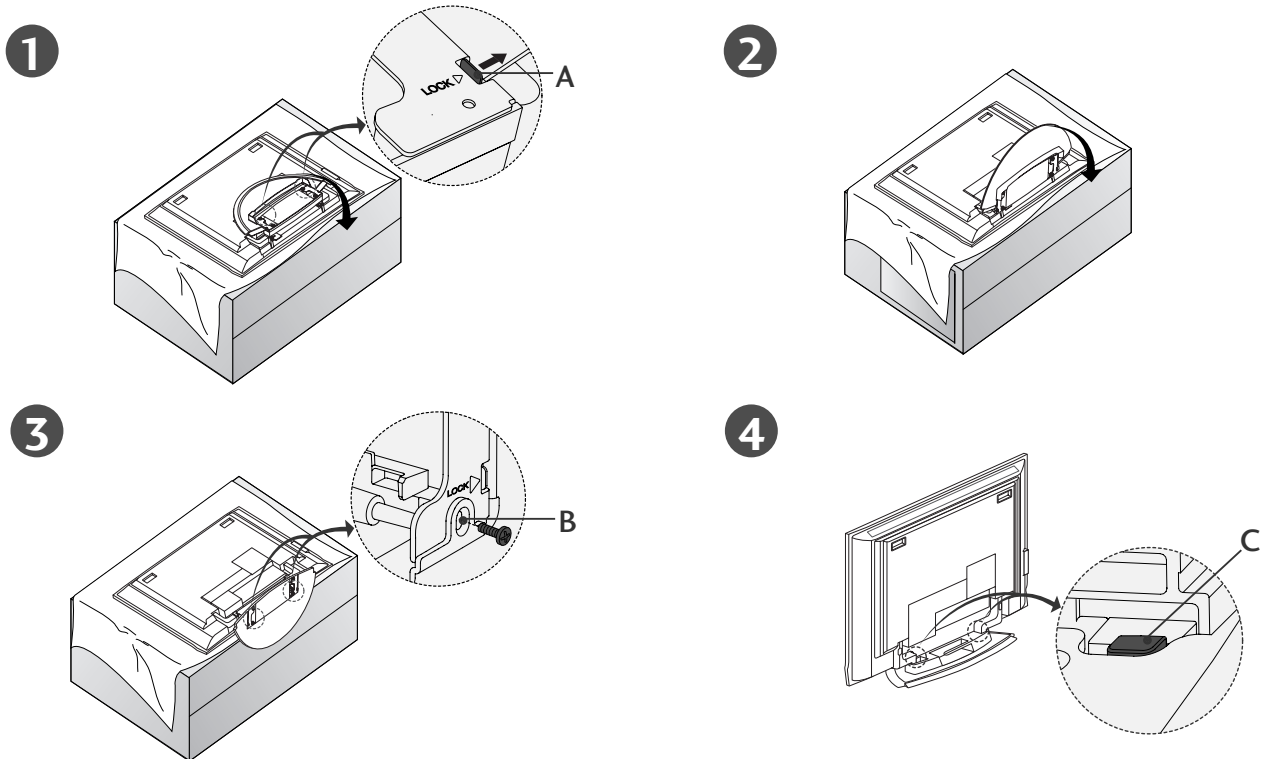

- Place the set with the screen facing down on a cushion or soft cloth as shown in Figures 1. Before unfolding the stand, please make sure two locks (A) on the bottom of the stand push outward.
- Pull the stand out as shown above in Figures 2 ~ 3. After unfolding the stand, please insert and tighten the screws in the holes (B) on the bottom of the stand.
- When connecting cables to the set, Do not disengage the lock (C). This may cause the set to fall, causing serious bodily injury and serious damage to the set.

! NOTE

Figures shown here may be slightly different from your set.

When closing the stand for storage

First remove the screws in the holes (B) on the bottom of the stand. And then pull two Hooks (D) of the stand bottom and fold the stand into the back of the set.

After folding, push two Locks (A) of the stand bottom outward.

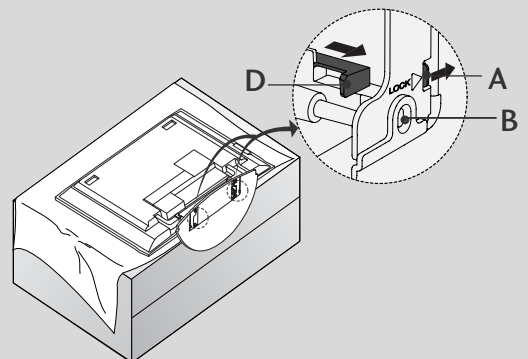

BASIC CONNECTION (42PC1RR *, 50PB2RR *)

- These models have two cable arrangement methods according to the stand type.

Stand type 1

Arrange the cables as shown picture.

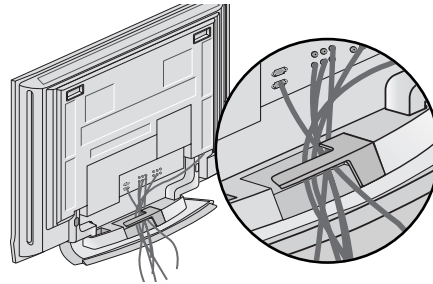

Stand type 2

- 1 Hold the **CABLE MANAGEMENT** with both hands and push it as shown.

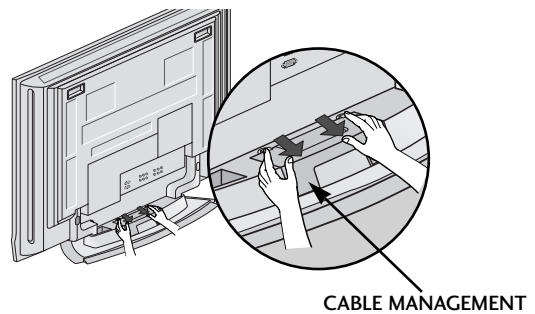

- 2 Connect the cables as necessary.
To connect an additional equipment, see the **External equipment Connections** section.

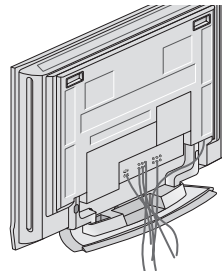

- 3 Reinstall the **CABLE MANAGEMENT** as shown.

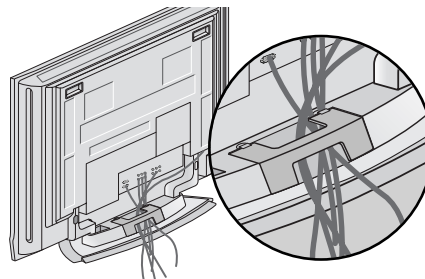

INSTALLATION

BASIC CONNECTION (37LC2RR*, 42LC2RR*)

- 1 Connect the cables as necessary.
After connecting the cables neatly, arrange the cables to the Cable Holder.

To connect an additional equipment, see the **CONNECTIONS & SETUP** section.

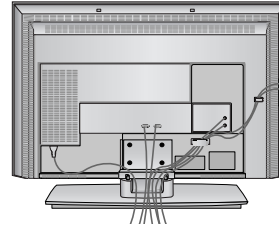

- 2 Install the **CABLE MANAGEMENT** as shown.

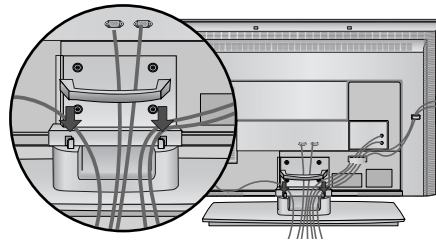

- 3 Bundle the cables using the supplied twister holder.

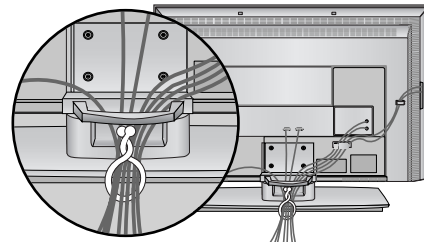

HOW TO REMOVE THE CABLE MANAGEMENT

Hold the **CABLE MANAGEMENT** with both hands and pull it upward.

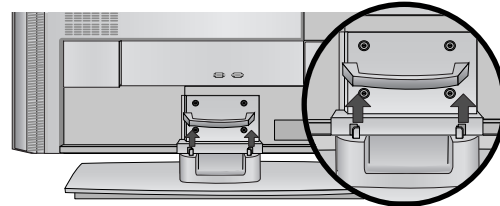

! NOTE

- ▶ Do not hold the **CABLE MANAGEMENT** when moving the product.
If the product is dropped, you may be injured or the product may be broken.

SWIVEL STAND (42LC2RR *, 50PB2RR * only)

- This feature is not available for all models.
- The set can be conveniently swivelled on its stand about 20°~30° to the left or right to provide the optimum viewing angle.

HOW TO JOIN THE SET ASSEMBLY TO THE WALL TO PROTECT THE SET TUMBLING

- Set it up close to the wall so the set doesn't fall over when it is pushed backwards.
- The instructions shown below is a safer way to set up the set, which is to fix it on the wall so the set doesn't fall over when it is pulled in the forward direction. It will prevent the set from falling forward and hurting people. It will also prevent the set from damage caused by fall. Please make sure that children don't climb on or hang from the set.

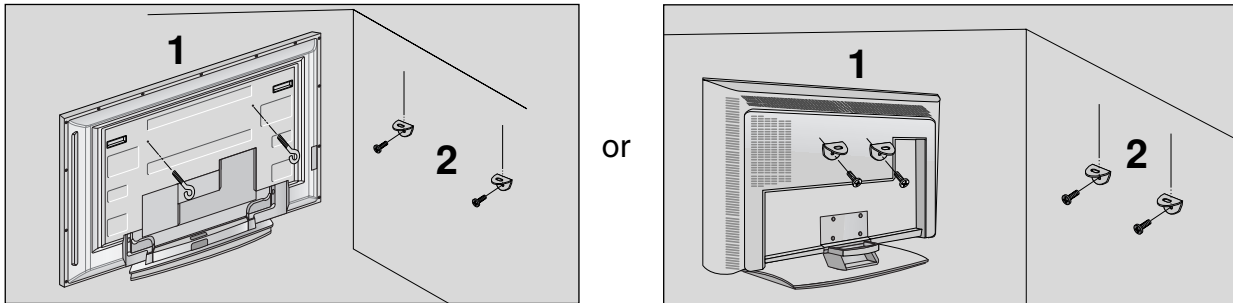

- 1 Use the eye-bolts or set brackets/bolts to fix the set to the wall as shown in the picture.
(If your set has the bolts in the eye-bolts position before inserting the eye-bolts, loosen the bolts.)
* Insert the eye-bolts or set brackets/bolts and tighten them securely in the upper holes.
- 2 Secure the wall brackets with the bolts (not provided as parts of the set, must purchase separately) on the wall. Match the height of the bracket that is mounted on the wall.

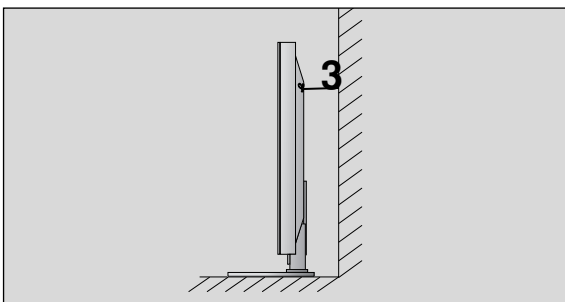

- 3 Use a sturdy rope (not provided as parts of the set, must purchase separately) to tie the set. It is safer to tie the rope so it becomes horizontal between the wall and the set.

! NOTE

- ▶ When moving the set to another place undo the ropes first.
- ▶ Use a set holder or a cabinet that is big and strong enough for the size and weight of the set.
- ▶ To use the set safely make sure that the height of the bracket that is mounted on the wall is same as that of the set.

INSTALLATION

STAND INSTALLATION

- The set can be installed in various ways such as on a wall, or on a desktop etc.
- The set is designed to be mounted horizontally.

GROUNDING

Ensure that you connect the earth ground wire to prevent possible electric shock. If grounding methods are not possible, have a qualified electrician install a separate circuit breaker. Do not try to ground the unit by connecting it to telephone wires, lightning rods, or gas pipes.

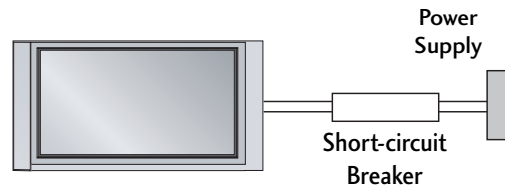

Desktop Pedestal Installation

For proper ventilation, allow a clearance of 4" on each side and from the wall.

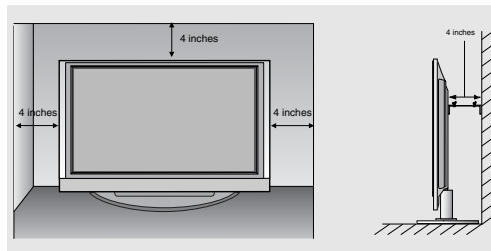
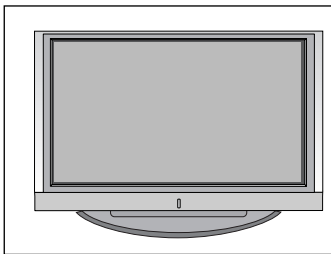

Wall Mount: Horizontal installation

For proper ventilation, allow a clearance of 4" on each side and from the wall. Detailed installation instructions are available from your dealer, see the optional Tilt Wall Mounting Bracket Installation and Setup Guide.

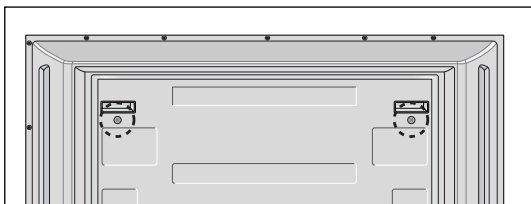
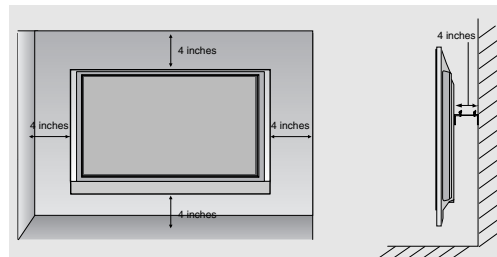
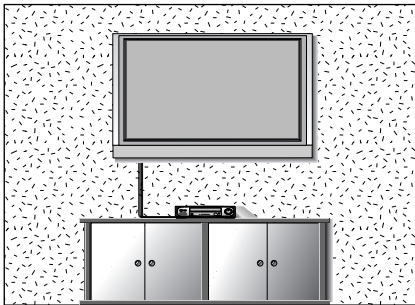

<Only 42PC1RR*>

Remove two screws of the backside of the set before installing the wall mounting bracket.

CONNECTIONS & SETUP

- To prevent the equipment damage, never plug in any power cords until you have finished connecting all equipment.
- This part of CONNECTION & SETUP mainly use pictures for the 42PC1RR*, 50PB2RR*.

ANTENNA CONNECTION

- For optimum picture quality, adjust antenna direction.
- An antenna cable and converter are not supplied.

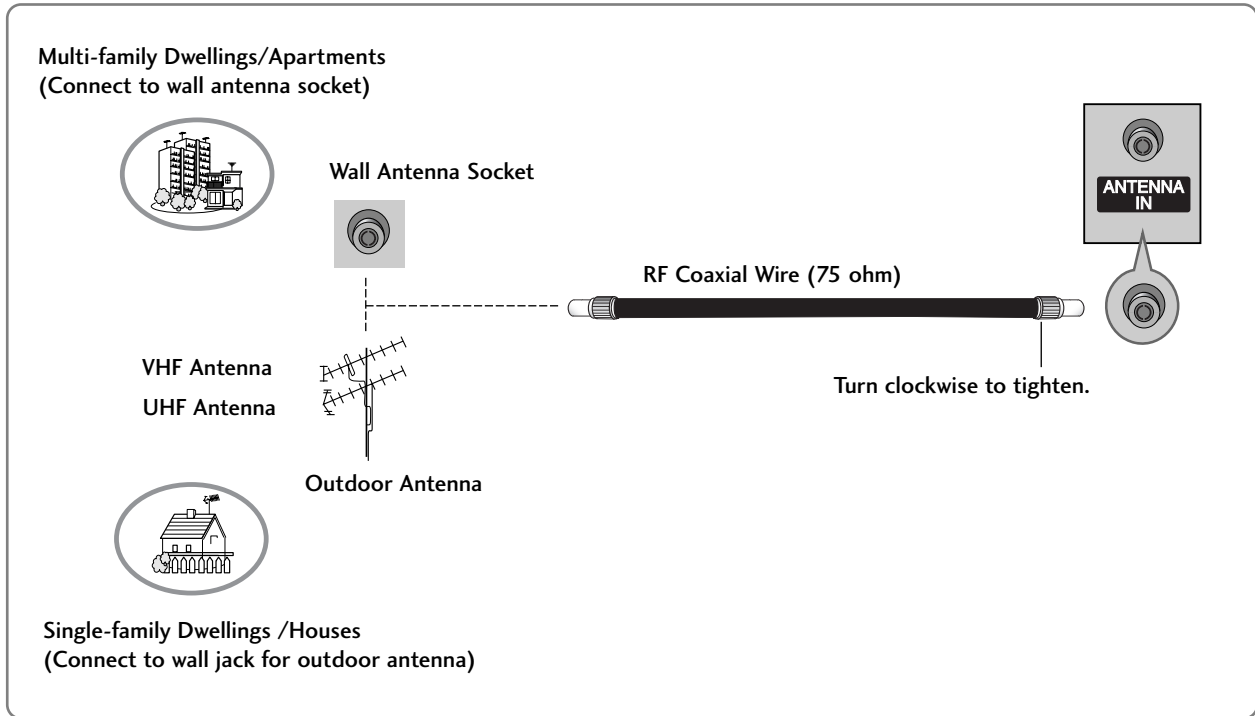

- In poor signal areas, to get better picture quality, install a signal amplifier to the antenna as shown to the right.
- If signal needs to be split for two TVs, use an antenna signal splitter for connection.

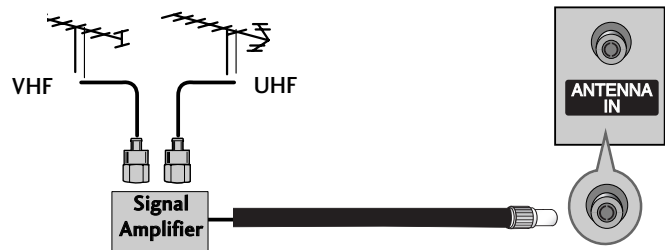

CONNECTIONS & SETUP

VCR SETUP

- To avoid picture noise (interference), leave an adequate distance between the VCR and TV.
- Typically a frozen still picture from a VCR. If the 4:3 picture format is used; the fixed images on the sides of the screen may remain visible on the screen.

When connecting with an antenna

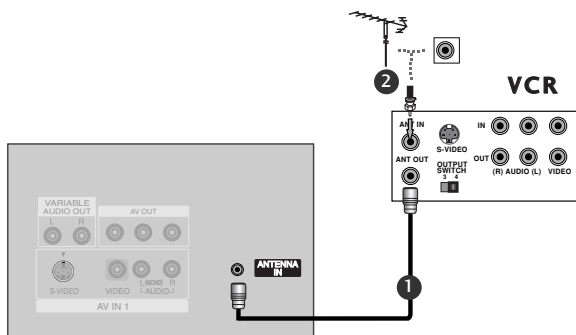

- 1 Connect the **ANT OUT** of the VCR to the **ANTENNA IN** socket on the set.
- 2 Connect the antenna cable to the **ANT IN** antenna socket of the VCR.
- 3 Press the **PLAY** button on the VCR and match the appropriate programme between the TV and VCR for viewing.

When connecting with a RCA cable

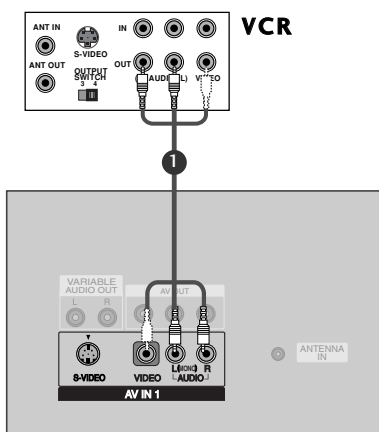

- 1 Connect the **AUDIO/VIDEO** jacks between TV and VCR. Match the jack colors (Video = yellow, Audio Left = white, and Audio Right = red)
- 2 Insert a video tape into the VCR and press **PLAY** on the VCR. (Refer to the VCR owner's manual.)
- 3 Select **AV1** input source using the **INPUT** button on the remote control.
- If connected to **AV IN2**, select **AV2** input source.

NOTE

- ▶ If you have a mono VCR, connect the audio cable from the VCR to the **AUDIO L/MONO** jack of the set.

VCR SETUP

When connecting with an S-Video cable

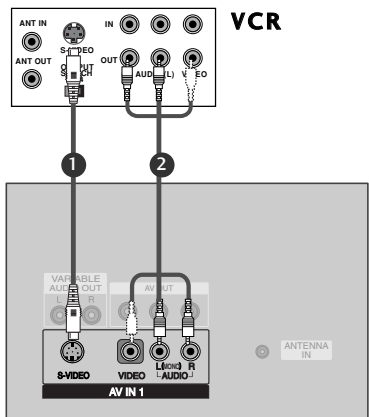

- 1 Connect the S-VIDEO output of the VCR to the **S-VIDEO** input on the set. The picture quality is improved; compared to normal composite (RCA cable) input.
- 2 Connect the audio outputs of the VCR to the **AUDIO** input jacks on the set.
- 3 Insert a video tape into the VCR and press **PLAY** on the VCR. (Refer to the VCR owner's manual.)
- 4 Select **AV1** input source with using the **INPUT** button on the remote control.

! NOTE

- ▶ If both S-Video and VIDEO sockets have been connected to the S-VHS VCR simultaneously, only the S-Video can be received.

CONNECTIONS & SETUP

EXTERNAL EQUIPMENT CONNECTIONS

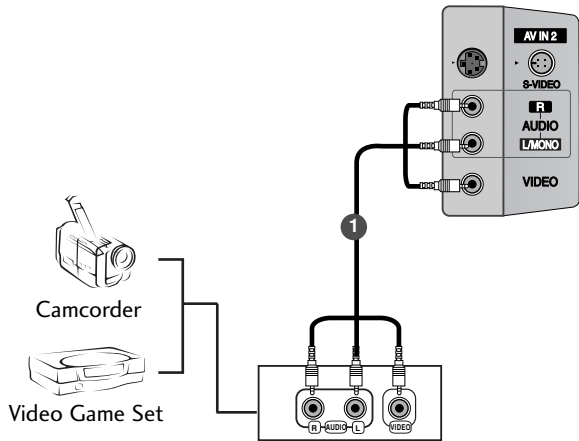

- 1 Connect the **AUDIO/VIDEO** jacks between TV and external equipment. Match the jack colors (Video = yellow, Audio Left = white, and Audio Right = red).
- 2 Select **AV2** input source with using the **INPUT** button on the remote control.
- If connected to **AV IN1** input, select **AV1** input source.
- 3 Operate the corresponding external equipment. Refer to external equipment operating guide.

EXTERNAL STEREO

- Use to connected either an external amplifier, or add a sub-woofer to your surround sound system.

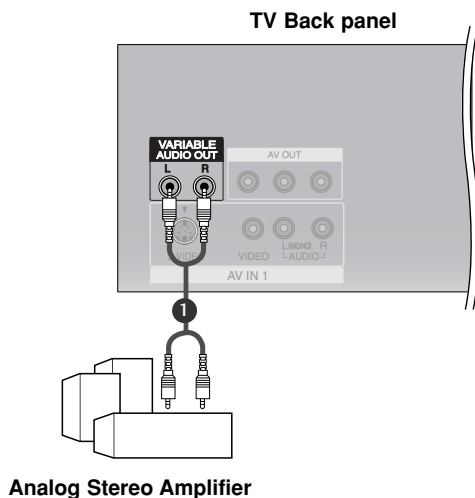

- 1 Connect the input jack of the stereo's amplifier to the **VARIABLE AUDIO OUT** jacks on the set.
- 2 Set up your speakers through your analog stereo amplifier, according to the instructions provided with the amplifier.
 - When connecting with external audio equipments, such as amplifiers or speakers, please turn the TV speakers off.

DVD SETUP

When connecting with a S-Video cable

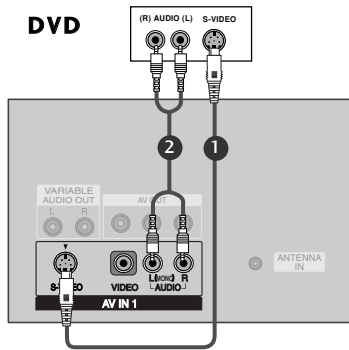

- 1 Connect the S-VIDEO output of the DVD to the **S-VIDEO** input on the set.
- 2 Connect the audio outputs of the DVD to the **AUDIO** input jacks on the set.
- 3 Turn on the DVD player, insert a DVD.
- 4 Select **AV1** input source with using the **INPUT** button on the remote control.
- 5 Refer to the DVD player's manual for operating instructions.

When connecting with a HDMI cable

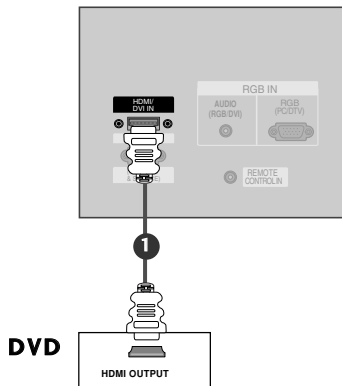

- 1 Connect the HDMI output of the DVD to the **HDMI/DVI IN** jack on the set.
- 2 Select **HDMI/DVI** input source with using the **INPUT** button on the remote control.
- 3 Refer to the DVD player's manual for operating instructions.

! NOTE

- ▶ Set can receive the video and audio signal simultaneously with using a HDMI cable.
- ▶ If the DVD supports Auto HDMI function, the DVD output resolution will be automatically set to 1280x720p.
- ▶ If the DVD does not support Auto HDMI, you need to set the output resolution appropriately. To get the best picture quality, adjust the output resolution of the DVD to 1280x720p.

CONNECTIONS & SETUP

DVD SETUP

When connecting with a component cable

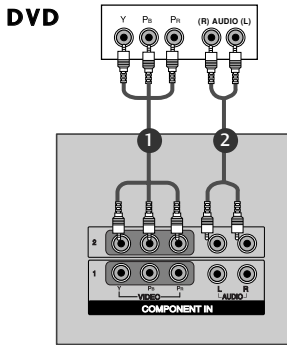

- 1 Connect the video outputs (Y, PB, PR) of the DVD to the **COMPONENT IN VIDEO** jacks on the set.
- 2 Connect the audio outputs of the DVD to the **COMPONENT IN AUDIO** jacks on the set.
- 3 Turn on the DVD player, insert a DVD.
- 4 Select **Component1** or **Component2** input source with using the **INPUT** button on the remote control.
- 5 Refer to the DVD player's manual for operating instructions.

! NOTE

► Component Input ports

To get better picture quality, connect a DVD player to the component input ports as shown below.

Component ports on the SET	Y	P _B	P _R
Video output ports on DVD player	Y	P _b	P _r
	Y	B-Y	R-Y
	Y	P _B	P _R

STB(SET-TOP BOX) SETUP

- This set can receive Digital Over-the-air/Cable signals without an external digital set-top box. However, if you do receive Digital signals from a digital set-top box or other digital external device, refer to the figure as shown below.

When connecting with a D-sub 15 pin cable

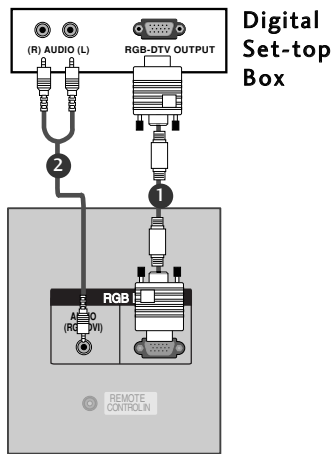

- 1 Connect the RGB output of the digital set-top box to the **RGB IN (PC/DTV)** jack on the set.
- 2 Connect the audio outputs of the set-top box to the **AUDIO (RGB/DVI)** jack on the set.
- 3 Turn on the digital set-top box. (Refer to the owner's manual for the digital set-top box.)
- 4 Select **RGB** input source with using the **INPUT** button on the remote control.

When connecting with a HDMI cable

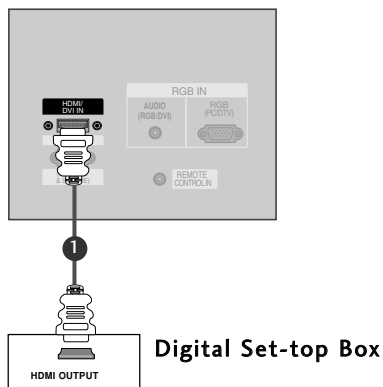

- 1 Connect the HDMI output of the digital set-top box to the **HDMI/DVI IN** jack on the set.
- 2 Select **HDMI/DVI** input source with using the **INPUT** button on the remote control.
- 3 Turn on the digital set-top box. (Refer to the owner's manual for the digital set-top box.)

! NOTE

- ▶ Set can receive the video and audio signal simultaneously with using a HDMI cable.
- ▶ If the digital set-top box supports Auto HDMI function, output resolution of the digital set-top box will be automatically set to 1280x720p.
- ▶ If the digital set-top box does not support Auto HDMI, you need to set the output resolution appropriately. To get the best picture quality, adjust the output resolution of the digital set-top box to 1280x720p.

CONNECTIONS & SETUP

STB(SET-TOP BOX) SETUP

When connecting with a component cable

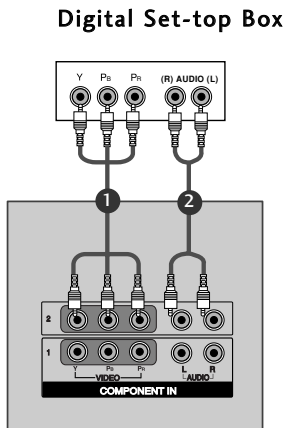

- 1 Connect the video outputs (Y, Pb, Pr) of the digital set-top box to the **COMPONENT IN VIDEO** jacks on the set.
- 2 Connect the audio output of the digital set-top box to the **COMPONENT IN AUDIO** jacks on the set.
- 3 Turn on the digital set-top box. (Refer to the owner's manual for the digital set-top box.)
- 4 Select **Component1** or **Component2** input source with using the **INPUT** button on the remote control.

! NOTE

Signal	Component	RGB-DTV	HDMI-DTV
480i/576i	Yes	No	No
480p/576p/720p/1080i	Yes	Yes	Yes

When connecting with a HDMI to DVI cable

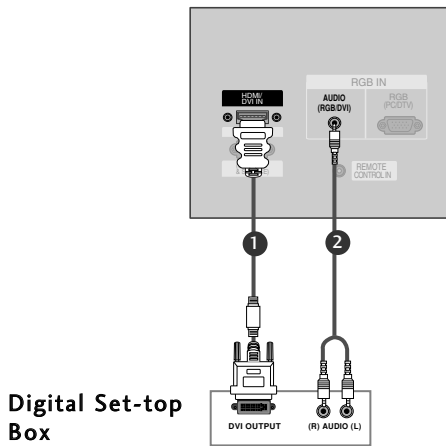

- 1 Connect the DVI output of the digital set-top box to the **HDMI/DVI IN** jack on the set.
- 2 Connect the audio outputs of the set-top box to the **AUDIO (RGB/DVI)** jack on the set.
- 3 Turn on the digital set-top box. (Refer to the owner's manual for the digital set-top box.)
- 4 Select **HDMI/DVI** input source with using the **INPUT** button on the remote control.

! NOTE

- ▶ If the digital set-top box has a DVI output and no HDMI output, a separated audio connection is necessary.
- ▶ If the digital set-top box supports Auto DVI function, the output resolution of the digital set-top box will be automatically set to 1280x720p.
- ▶ If the digital set-top box does not support Auto DVI, you need to set the output resolution appropriately. To get the best picture quality, adjust the output resolution of the digital set-top box to 1280x720p.

PC SETUP

- This set provides Plug and Play capability, meaning that the PC adjusts automatically to the set's settings.

When connecting with a D-sub 15 pin cable

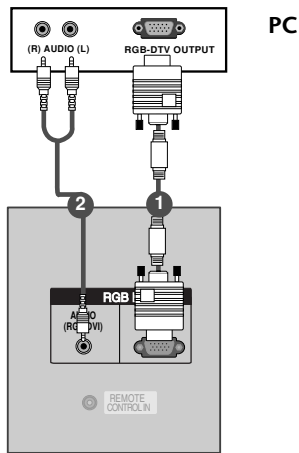

- 1 Connect the RGB output of the PC to the **RGB IN (PC/DTV)** jack on the set.
- 2 Connect the audio outputs of the PC to the **AUDIO (RGB/DVI)** jack on the set.
- 3 Turn on the PC and the set.
- 4 Select **RGB** input source with using the **INPUT** button on the remote control.

When connecting with a HDMI to DVI cable

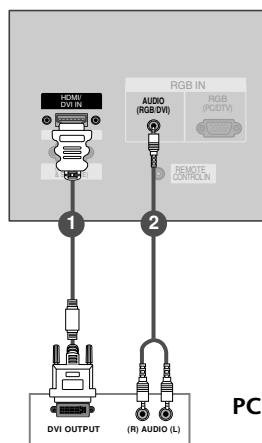

- 1 Connect the DVI output of the PC to the **HDMI/DVI IN** jack on the set.
- 2 Connect the audio outputs of the PC to the **AUDIO (RGB/DVI)** jack on the set.
- 3 Turn on the PC and the set.
- 4 Select **HDMI/DVI** input source with using the **INPUT** button on the remote control.

! NOTE

- ▶ If the PC has a DVI output and no HDMI output, a separated audio connection is necessary.
- ▶ If the PC does not support Auto DVI, you need to set the output resolution appropriately. To get the best picture quality, adjust the output resolution of PC graphics card's output resolution to 1024x768, 60Hz.

CONNECTIONS & SETUP

! NOTE

- ▶ To enjoy vivid picture and sound, connect a PC to the set.
- ▶ Avoid keeping a fixed image on the set's screen for a long period of time. The fixed image may become permanently imprinted on the screen; use a screen saver when possible.
- ▶ Connect PC to the RGB (PC/DTV) or HDMI/DVI port of the set; change the resolution output of PC accordingly.
- ▶ There might be noise according to some resolution, vertical pattern, contrast or brightness in PC mode. Change the PC mode into another resolution or change the refresh rate into another rate or adjust the brightness and contrast on the menu until the picture is clean. If the refresh rate of the PC graphic card can not be changed, change the PC graphic card or consult it to the manufacturer of the PC graphic card.
- ▶ The synchronization input waveform for Horizontal and Vertical frequencies are separate.
- ▶ In 42PC1RR/50PB2RR models, we recommend using 1024x768, 60Hz for the PC mode, they provide the best picture quality.
- ▶ In 37LC2RR/42LC2RR models, we recommend using 1360x768, 60Hz for the PC mode, they provide the best picture quality.
- ▶ If the resolution of PC is over UXGA, there will be no picture on the set.
- ▶ Connect the signal cable from the monitor output port of the PC to the RGB (PC/DTV) port of the set or the signal cable from the HDMI output port of the PC to the HDMI/DVI port on the set.
- ▶ Connect the audio cable from the PC to the Audio input on the set. (Audio cables are not included with the set).
- ▶ If using a sound card, adjust PC sound as required.
- ▶ This set uses a VESA Plug and Play Solution. The set provides EDID data to the PC system with a DDC protocol. The PC adjusts automatically when using this set.
- ▶ DDC protocol is preset for RGB (Analog RGB), HDMI (Digital RGB) mode.
- ▶ If required, adjust the settings for Plug and Play functionally.
- ▶ If graphic card on the PC does not output analog and digital RGB simultaneously, connect only one of either RGB (PC/DTV) or HDMI/DVI to display the PC on the set.
- ▶ If graphic card on the PC does output analog and digital RGB simultaneously, set the set to either RGB or HDMI; (the other mode is set to Plug and Play automatically by the set.)
- ▶ DOS mode may not work depending on video card if you use a HDMI to DVI cable.
- ▶ When you use too long RGB-PC cable, there might be a noise on the screen. We recommend using under 5m of the cable. It provides the best picture quality.
- ▶ In RGB, HDMI/DVI input sources, you can select the PC or DTV mode when the below signals are input;
 - PC : 640x480, 60Hz / 720x480, 60Hz / 848x480, 60Hz / 858x480, 60Hz / 1280x720, 60Hz
 - DTV : 480p / 720p, 60Hz

**Supported Display Resolution (RGB / HDMI mode)
(37LC2RR *, 42LC2RR *)**

Resolution	Horizontal Frequency(KHz)	Vertical Frequency(Hz)
720x400	31.468	70.8
640x480	31.469 37.684	59.94 75.00
800x600	37.879 46.875	60.31 75.00
832x624	49.725	74.55
1024x768	48.363 56.47 60.123	60.00 70.00 75.029
1280x768	47.776	59.870
1360x768	47.720	59.799
1366x768	47.720	59.799

**Supported Display Resolution (RGB / HDMI mode)
(42PC1RR *, 50PB2RR *)**

Resolution	Horizontal Frequency(KHz)	Vertical Frequency(Hz)
640x350	31.468 37.861	70.09 85.08
720x400	31.469 37.927	70.08 85.03
640x480	31.469 35.000 37.861 37.500 43.269	59.94 66.66 72.80 75.00 85.00
848x480	31.500 37.799 39.375	60.00 70.00 75.00
852x480	31.500 37.799 39.375	60.00 70.00 75.00
800x600	35.156 37.879 48.077 46.875 53.674	56.25 60.31 72.18 75.00 85.06
832x624	49.725	74.55
1024x768	48.363 56.476 60.023	60.00 70.06 75.02
1360x768	47.700	60.00
1366x768	47.700	60.00
1152x864	54.348	60.05
1280x768	47.776	59.87

BASIC OPERATION

TURNING THE SET ON

If your set will be turned on, you will be able to use its features.

Turning the set on

- 1 First, connect power cord correctly.
At this moment, the set switches to standby mode.
 - In standby mode to turn set on, press the ϕ /I, INPUT, PR \blacktriangle / \blacktriangledown button on the set or press the POWER, INPUT, MULTIMEDIA, PR \blacktriangle / \blacktriangledown , NUMBER button on the remote control and then the set will switch on.

Volume Adjustment

- 1 Press the VOL \blacktriangle / \blacktriangledown button to adjust the volume.
- 2 If you want to switch the sound off, press the MUTE button.
- 3 You can cancel this function by pressing the MUTE, VOL \blacktriangle / \blacktriangledown or I/II button.

Programme selection

- 1 Press the PR \blacktriangle / \blacktriangledown or NUMBER button to select a programme number.

On-Screen Menu Language Selection (option)

- The menus can be shown on the screen in the selected language.
First select your language.

- 1 Press the MENU button and then use \blacktriangle / \blacktriangledown button to select the SPECIAL menu.
- 2 Press the \blacktriangleright button and then use \blacktriangle / \blacktriangledown button to select Language.
- 3 Press the \blacktriangleright button and then use \blacktriangle / \blacktriangledown button to select your desired language. From this point on, the on-screen menus will be shown in the language of your choice.
- 4 Press the EXIT button to return to normal TV viewing.

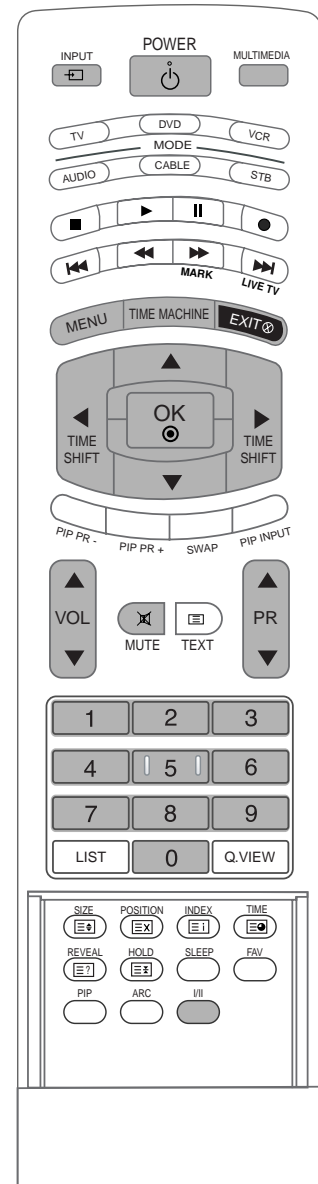

NOTE

► If you intend to be away on vacation, disconnect the power plug from wall power outlet.

SPECIAL FUNCTIONS | DVR (Digital Video Recorder)

TIMESHIFT

- This function allows the unit to automatically record live TV and make it available for reviewing at any time.
- With Timeshift turned on, you may pause and rewind normal TV viewing at any time without missing any of the live broadcast.

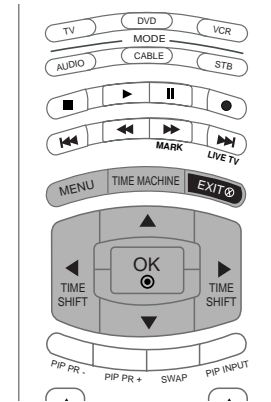

- 1 Press the **MENU** button and then use ▲ / ▼ button to select the **DVR** menu.
- 2 Press the ► button and then use ▲ / ▼ button to select the **Timeshift**.
- 3 Press the ► button and then use ▲ / ▼ button to select **On** or **Off**.
- 4 Press the **EXIT** button to return to normal TV viewing.



1

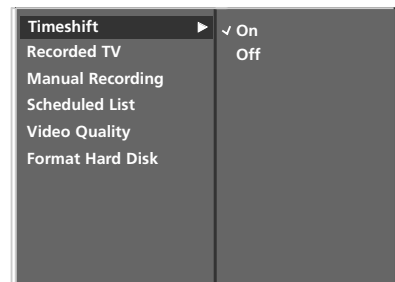

2 3

PROGRESSING THE TIMESHIFT FUNCTION



- 1 After selecting the **Timeshift On**, press the **OK** button.
 - As soon as Timeshift starts, a progress bar indicating the current recording status is displayed in the bottom of the screen.
 - Press the **EXIT** button to hide the 'Progress Bar' or press the **OK** button to display the 'Progress Bar'.
 - This function is preserved even change a programme on progressing the Timeshift.

The 'Progress Bar'?

This function indicates a possible DVR reshoving section ,a current on-screen and real on-broad-casting position, a section of section-recording.

- 1 Status of current displayed video.
- 2 Current save time.
- 3 15 minute intervals from Timeshift start time.
(Total - one hour).
- 4 Indicates current Timeshift position.

- 2 When finishing the Timeshift function, enter the option menu and turn **Timeshift Off**.

! NOTE

- ▶ DVR (Digital Video Recorder) : A device which records and plays broadcast program contents onto a hard disk in set or SET TOP BOX.
- ▶ In order to save hard-disk space, nothing is saved when there is no signal.
- ▶ The total storage space of the hard-disk is 80 GB. 4 GB minimum is reserved for Timeshift.
- ▶ When turning power on, it may take up to maximum 3 minutes to initialize the HDD.
- ▶ The Recording function will not initiate for a copy-protected program.
- ▶ Because an analog broadcast is transferred to a digital signal, video that contains rapid movement may show "cross stripes". This happens when the analog signal is compressed and then restored in the digital signal. The unit will attempt to reduce this excessive picture noise.
- ▶ When using the PIP/DW, POP mode, Timeshift is stopped.
- ▶ Timeshift is available in TV, AV1, AV2, Component(480i/576i) mode.
- ▶ Timeshift is not available for Audio only channels.





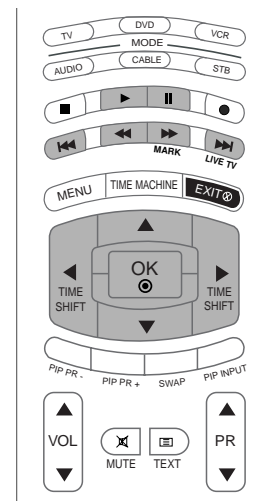
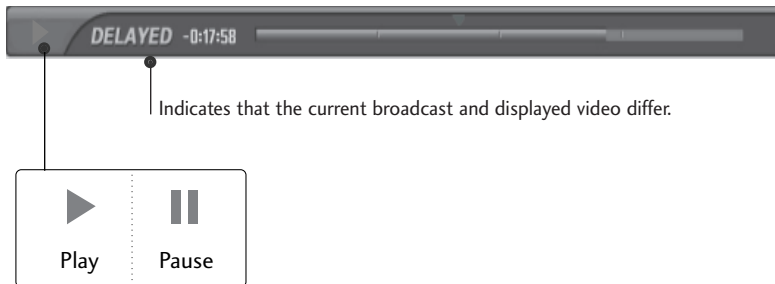





























Progressing the Timeshift function, play

- On progressing Timeshift, it can do a diversified playing.



Using the remote control

You can shift playback to any point within playing the recorded program



	<p>When playing,</p> <p>repeatedly, press the REW() button to speed up  ->  -> </p> <p>->  ->  .</p> <p>repeatedly, press the FF() button to speed up  ->  -> </p> <p>->  ->  .</p> <ul style="list-style-type: none"> Pressing these buttons repeatedly increases the fast forward/reverse speed.
  	<p>Press the  or  button to move back and forth within the current program.</p> <ul style="list-style-type: none"> Press the  button to jump at the front of the programme. Pressing the  button to jump at the end of the programme. <p>Press the  button to jump about 20 seconds forward.</p> <ul style="list-style-type: none"> Pressing the  button to jump about 8 seconds backward.
	<p>During playback, press the Pause() button.</p> <ul style="list-style-type: none"> Still screen is displayed. Repeatedly press the Pause() button to advance frame by frame. Press the Pause() button and then use the FF() button for slow motion (as showing the )
	<ul style="list-style-type: none"> When using the  or  button during playback the cursor can be viewed on the screen.
	<p>Press the PLAY() button to return to normal playback.</p>
	<p>If you want to return to the current live broadcast, press the  button.</p>

RECORDING

- Use this function to record the program you are watching on the main screen.

Instant Record

This function records the currently displayed programme.

1 Select the desired programme to record and then press the  button. During recording  is displayed. Use this feature to record up to 2 hours of programming.





2 If you want to stop recording, press the  button.

■ While recording, if you press the  button fewer than 10 seconds, this message is displayed.

 Recording is not completed.
Recording time must exceed 10 seconds.

■ If you press the  button more than 10 seconds, this message is displayed.

 Recording is completed.

3 You can add/subtract recording time by pressing the  button while recording. Press the  or  button repeatedly to add/subtract to the recording time. Each time you press  or  button the recording duration changes as shown below.

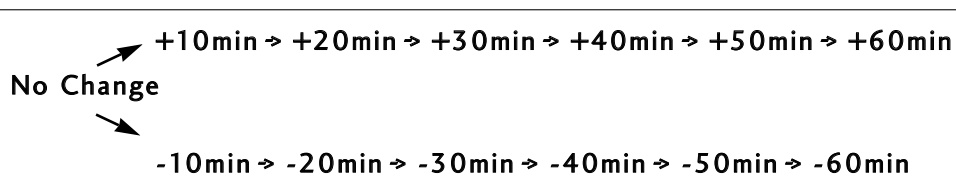

The extra recording time added to existing setting equals the final recording time.

- 4 After adjusting the recording time, select **OK**. The Status bar will be displayed.



- Press the **EXIT** button to hide the Status bar. Press the **OK** button to display the Status bar.

- 5 Recording stops when the selected duration is reached or when you press the  button. Although recording has stopped, the Timeshift feature remains active.

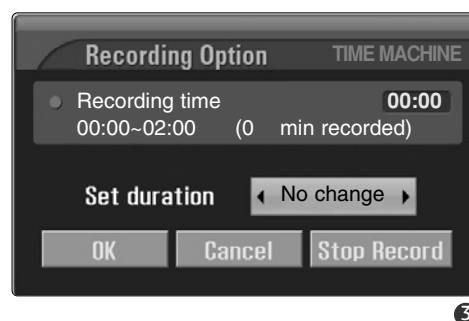

NOTE

- ▶ When recording, if the available storage space becomes low, the recording will be automatically stopped.
- ▶ Recordings of less than 10 seconds will not be saved.
- ▶ To save disk space while recording broadcasts, no data will be saved if there is no signal.
- ▶ The recording function will not initiate for a copy-protected program.
- ▶ The displayed time slightly differ from the actual time.
- ▶ In no signal or film source, the displayed time slightly differ from the actual time.
- ▶ The recording can not be used with content-protected programs on progressing Timeshift .

 Stop recording due to copy protection.

- ▶ If the old tape is recorded, this may cause damage to the recording quality.
- ▶ It will be stored separately the programme according to the colour system signal.

WATCHING & RECORD

- While recording, you can change programmes or inputs without disturbing the recording. The broadcast being recorded can be shown in the lower-right corner of the main screen.
- It's available to use this function in TV, AV1, AV2, Component 480i/576i modes.

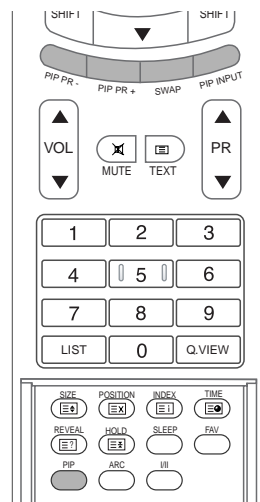

- After starting an Instant Record or Reserved Record, change the programme or input.
 - You can check the show being recorded in the lower-right corner the main screen (as shown below).
 - Press the **PIP** button to hide or show the program being recorded.
 - Press the **SWAP** button to return to the program being recorded in Watching & Record.
 - When changed to the programme recorded in Watching & Record, the screen is changed to Instant Record state or Reserved Record state.



screen being recorded

Record Watching	Analog	AV1	AV2	Component1 (480i/576i)	Component2 (480i/576i)
Analog	0	0	0	0	0
AV1	0	0	0	0	0
AV2	0	0	0	0	0
Component1	0	0	0	0	0
Component2	0	0	0	0	0
RGB	0	0	0	0	0
HDMI/DVI	0	0	0	0	0

Watching & Record Input

CAUTION

- ▶ If you turn the power off on recording, this message is displayed as shown below.

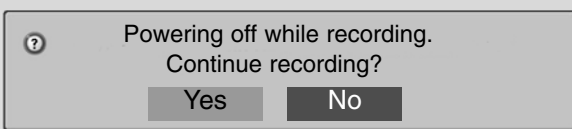

- ▶ If you selects No, recording stops and then power is off.
- ▶ If you selects Yes, recording continues and the power is turned off.
- ▶ If you press the **EXIT** button to disappear this message.

RECORDED TV

- You can watch the recorded program list at a glance.
- This function is available to use in DVR menu.

- 1 Press the **TIME MACHINE** button to display **HOME** menu. Use the **▲** or **▼** button to select the **Recorded TV** and then use the **OK** or **▶** button.

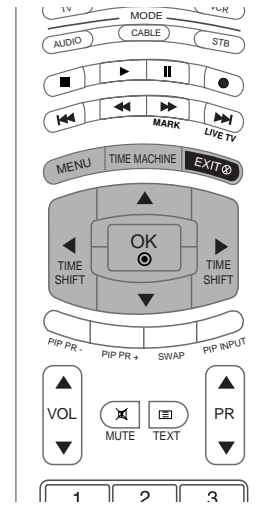
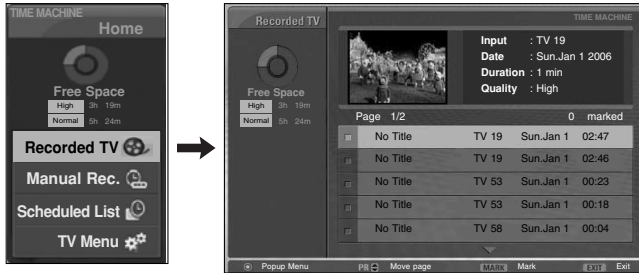

RECORDED PROGRAM SELECTION AND POPUP MENU

- The thumbnail recorded list is shown above.

- 1 Use the **▲** or **▼** button for page up/down navigation.
- 2 Use the **MARK** button to delete from the list. A is displayed next to the thumbnail photo if an item is marked.

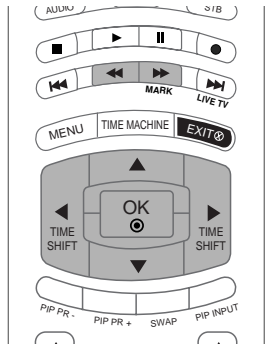

1

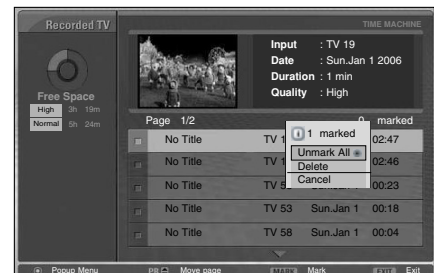

2

3 Use ▲▼◀▶ button to navigate the appropriate thumbnail photo, then press the **OK** button to open the Pop-up Menu.

- ▶ **Play** : Begin playback of selected recording.
- ▶ **Mark All** : mark all photos on the screen.
- ▶ **Unmark All** : Change marked photos to unmarked photos.
- ▶ **Delete** : Delete the selected recording.
- ▶ **Rename** : Edit recorded program title.
- ▶ **Cancel** : Close the Pop-up Menu.



3

4 Repeatedly, press **EXIT** button to return to TV viewing or press **TIME MACHINE** button to return to the **Home** menu.

- If the HDD has a problem performing a function (Recording) related to the DVR, this message is displayed.
- If the temperature is below zero (0°), a warning message is displayed and you need to initialize the HDD.

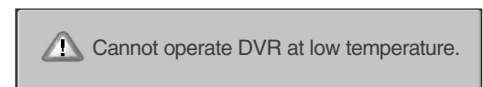
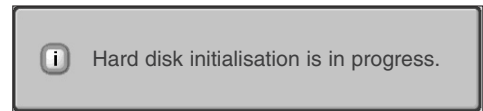

4

SPECIAL FUNCTIONS

PLAYING RECORDED PROGRAMS

- You can play the selected program in the recorded program list.

- 1** Play a recorded program.
- 2** While playing, You can see a diversified playback screen as shown below.
 - At first, an icon showing current playback mode is displayed as marking **PLAYING**. Then press the **OK** button to display the progress bar
 - To stop displaying the recorded programs icon, press the **EXIT** button.

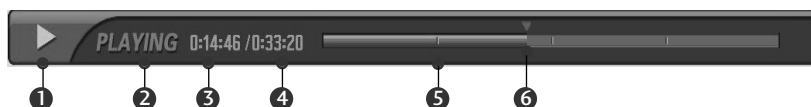







































The 'Progress Bar'?

This function indicates a possible DVR reshoving section ,a current on-screen and real on-broadcasting position, a section of section-recording.

- 1** Indicates movement of recorded program.
- 2** Indicates status of recorded program.
- 3** Indicates elapsed playback time.
- 4** Indicates total playback time.
- 5** Indicates a quarter of program runtime.
- 6** Indicates current playback position.

USING THE REMOTE CONTROL





You can shift playback to any point within playing the recorded program.



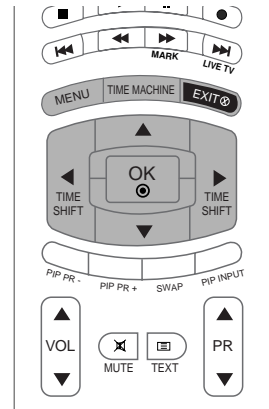

	<p>When playing, repeatedly, press the REW () button to speed up  ->  ->  ->  ->  .</p> <p>repeatedly, press the FF () button to speed up  ->  ->  ->  ->  .</p> <ul style="list-style-type: none"> ▪ Pressing these buttons repeatedly increases the fast forward/reverse speed.
    	<p>Press the  or  button to move back and forth within the current program.</p> <ul style="list-style-type: none"> ▪ Press the  button to jump at the front of the programme. ▪ Pressing the  button to jump at the end of the programme. <p>Press the  button to jump about 20 seconds forward.</p> <ul style="list-style-type: none"> ▪ Pressing the  button to jump about 8 seconds backward.
	<p>During playback, press the Pause () button.</p> <ul style="list-style-type: none"> ▪ Still screen is displayed. ▪ Repeatedly press the Pause () button to advance frame by frame. ▪ Press the Pause () button and then use the FF () button for slow motion (as showing the  .)
	<ul style="list-style-type: none"> ▪ When using the  or  button during playback the cursor can be viewed on the screen.
	<p>Press the PLAY () button to return to normal playback.</p>
	<p>If you want to return to the current live broadcast, press the  button.</p>
	<ul style="list-style-type: none"> ▪ If you press the STOP () button, you can watch set.

MANUAL RECORDING

- This function is easy to register to reserved recording.
- This function is available to use in DVR menu.
- When Manual Recording, it's stored the default sound of the set.



1 Press the  button to display **Home** menu. Use the  or  button to select the **Manual Rec** and then use the **OK** or  button.

2 **Manual Rec** screen is displayed as shown below. Use the     button to set the **Input**, **PR**, **Date**, **Time**, **Duration**, **Frequency** .

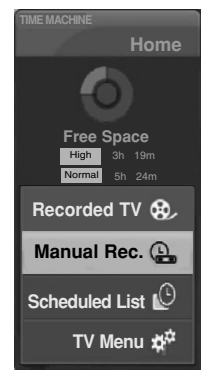

- ▶ **Input** : Select the input source from the TV, AV1, AV2, Component1, Component2.
- ▶ **PR** : Select either the current programme or a scanned programme.
- ▶ **Date** : You can select a date up to one month in the future.
- ▶ **Time /Duration** : Ensure you have set correctly.
- ▶ **Frequency** : Choose among Once, Daily and Weekly.

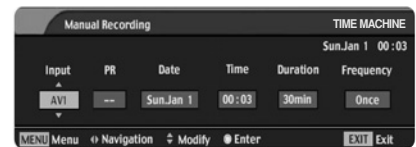

2

3 After setting the **Manual Rec** , press the **OK** button.

SCHEDULED LIST

- You can store up to 8 programmes.
- This function is available to use in DVR menu.

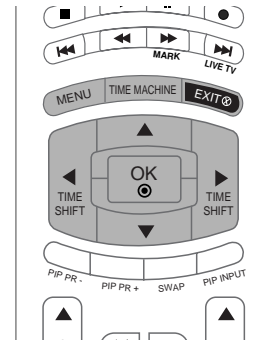

- 1 Press the **TIME MACHINE** button to display **Home** menu. Use the **▲** or **▼** button to select the **Scheduled List** and then use the **OK** or **▶** button.
- 2 **Scheduled List** screen is displayed as shown below. Use the **▲** **▼** button to select recorded programme.

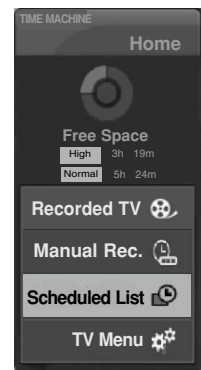

VIDEO QUALITY

- It's not available to use this function on recording programme.

- 1 Press the **MENU** button and then use **▲** / **▼** button to select the **DVR** menu.
- 2 Press the **▶** button and then use **▲** / **▼** button to select the **Video Quality**.
- 3 Press the **▶** button and then use **▲** / **▼** button to select **High** or **Normal**.
- 4 Press the **EXIT** button to return to normal TV viewing.

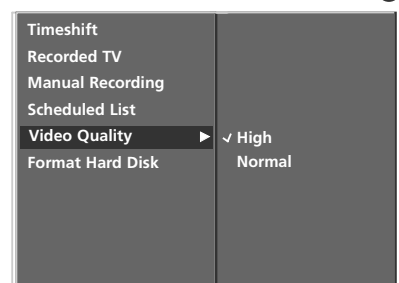

FORMAT HARD DISK

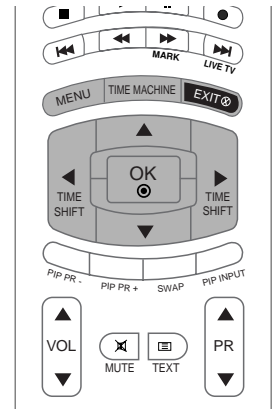

- 1 Press the **MENU** button and then use ▲ / ▼ button to select the **DVR** menu.
- 2 Press the ► button and then use ▲ / ▼ button to select the **Format Hard Disk**.
- 3 Press the ► button to start **Format Hard Disk**.



1

■ if you press the ► button, this message is displayed.

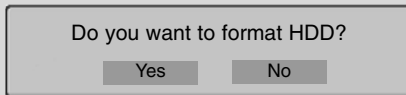

■ if you selects Yes, this message is displayed.

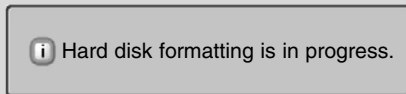

■ When completing, this message is displayed.

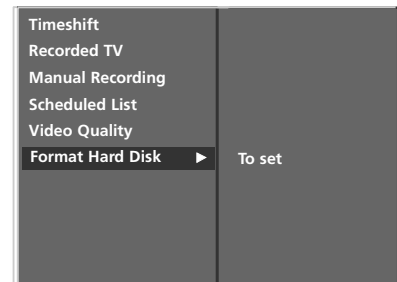
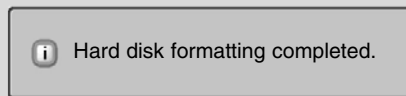

2 3

- 4 Press the **EXIT** button to return to normal TV viewing.

SPECIAL FUNCTIONS | PIP / POP / Twin Picture

PIP (PICTURE-IN-PICTURE) FEATURE

PIP lets you view 2 different inputs (sources) on your set screen at the same time. One source will be large, and the other source will show a smaller inset image. It's not available to use this function in TELETEXT mode. Twin Picture mode splits the screen into two images, allowing two picture sources to be shown on the set screen at the same time. Each source is given half the screen. When recording or playing, it's not available to use this function.

! NOTE

- ▶ When the sub picture size is 1/2 of the main picture, the picture quality may decrease.
- ▶ The motion of the sub picture can be unnatural because the set displays full screen by synchronizing the main picture source when the refresh rate between the main picture source and the sub picture source is different in PIP mode.

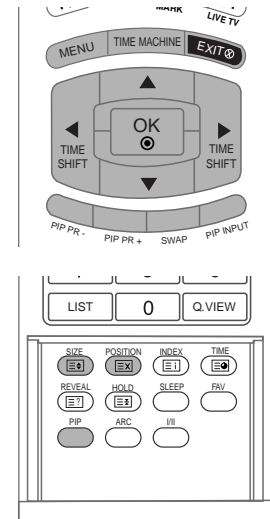

WATCHING PIP

Press the PIP button to access the sub picture.

Each press of PIP changes the PIP options as shown below.

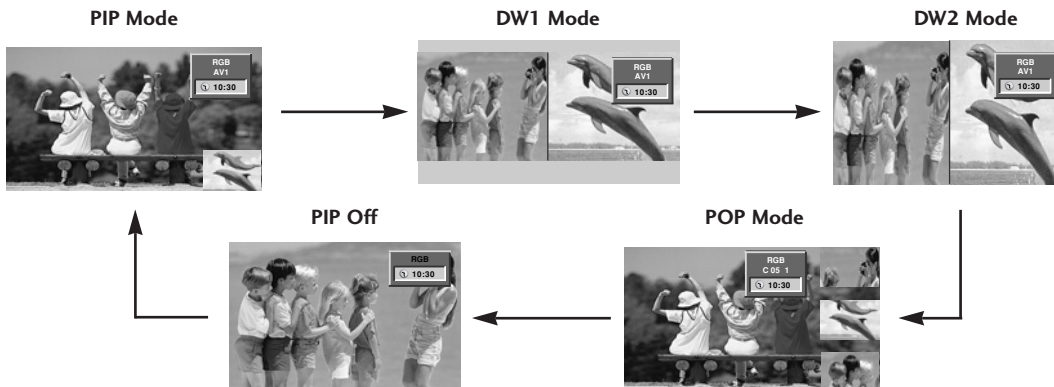

ADJUSTING PIP TRANSPARENCY (PIP MODE ONLY)

- 1 Press the **MENU** button and then **▲** / **▼** button to select the **PIP/DW** menu.
- 2 Press the **▶** button and then **▲** / **▼** button to select **PIP Transparency**.
- 3 Press the **▶** button and then **◀** / **▶** button to adjust PIP transparency.
- 4 Press the **EXIT** button to return to normal TV viewing.

PROGRAMME SELECTION FOR SUB PICTURE

- 1 Press the **PIP PR + /-** button to select a programme for the sub picture.

ADJUSTING THE SCREEN FOR THE PIP

- 1 In TV or AV modes for the main picture and RGB[PC] for the sub picture, you can use Auto config and Manual config to adjust the screen of the sub picture.
 - In TV or AV modes for main picture and HDMI[DTV] or Component 480p, 576p, 720p, 1080i for the sub picture, you can use Manual config to adjust the screen of the sub picture.

SELECTING AN INPUT SIGNAL SOURCE FOR THE PIP

- 1 Press the **PIP INPUT** button to select the input source for the sub picture.
 - In some models, when the sub picture quality get poor for sub picture, select Auto, PAL, SECAM or NTSC in PIP System menu.
 - Each press of **PIP INPUT** button is pressed, each input source for the sub picture is displayed as shown below.



SUB PICTURE SIZE ADJUSTMENT (PIP MODE ONLY)

- 1 Press the **SIZE** button and then **◀/▶** button to adjust the sub picture size.
 - With **SIZE** button in DW1, DW2 modes, main and sub picture is adjusted simultaneously. With **SIZE** button in PIP mode, sub picture is adjusted.



MOVING THE PIP (PIP MODE ONLY)

- 1 Press the **POSITION** button.
 - Repeatedly press the **▲/▼** or **◀/▶** button until desired position is achieved. The sub picture moves up/down or left/right.



SWAPPING BETWEEN MAIN AND SUB PICTURES

- 1 Press the **SWAP** button to exchange the main and sub pictures.

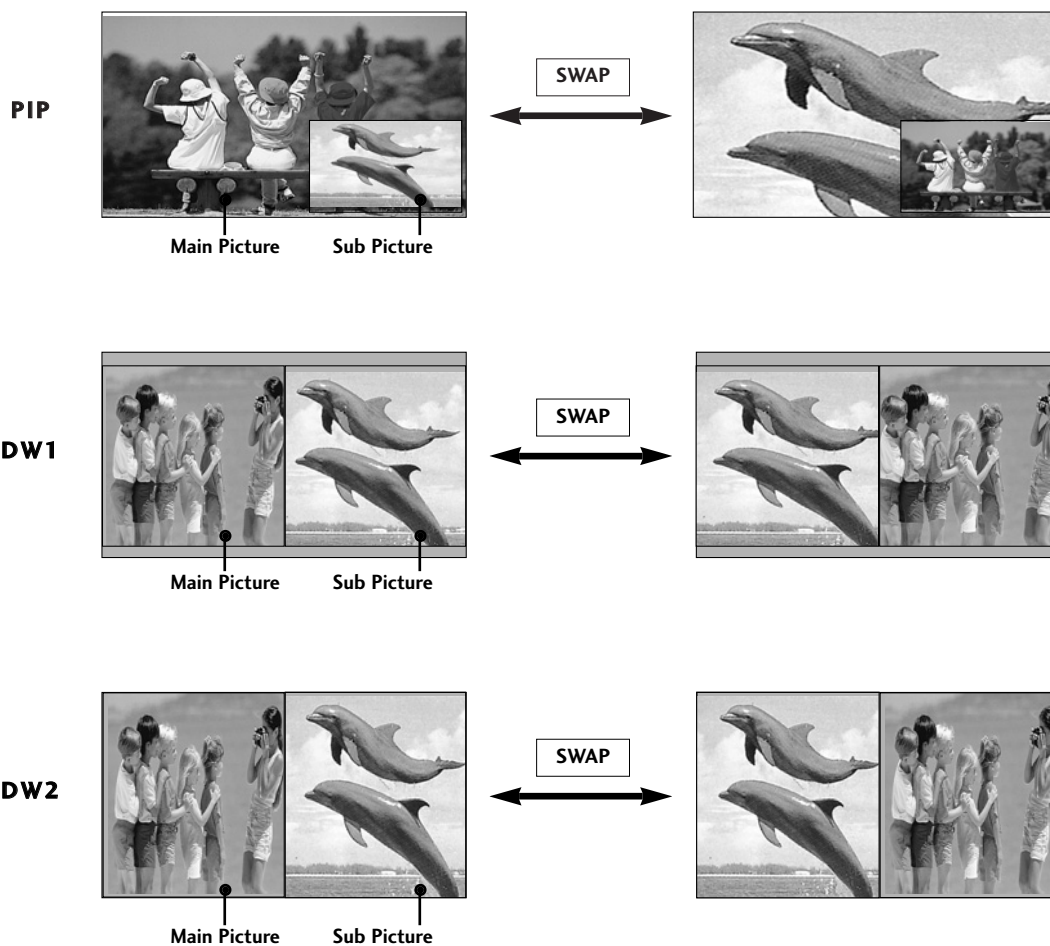

POP (PICTURE-OUT-OF-PICTURE: CHANNEL SCAN)

- 1 Use POP to search the programmes of all the memorized channels one-by-one on the 3 PIP screen display, (while the main picture source remains the current programme). The pictures of all the programmed channels are searched with the 3 POP screen.



SPECIAL FUNCTIONS | Teletext

- Teletext (or TOP text) is an optional function, therefore only the set with the teletext system can receive the teletext broadcast.
- Teletext is a free service broadcast by most TV stations which gives up-to-the-minute information on news, weather, television programmes, share prices and many other topics.
- The teletext decoder of this set can support the SIMPLE, TOP and FASTEXT systems. SIMPLE (standard teletext) consists of a number of pages which are selected by directly entering the corresponding page number. TOP and FASTEXT are more modern methods allowing quick and easy selection of teletext information.

TELETEXT LANGUAGE SELECTION (OPTION)

- 1 Press the **MENU** button and then use ▲ / ▼ button to select the **SPECIAL** menu.
- 2 Press the ► button and then use ▲ / ▼ button to select **Language** .
- 3 Press the ► button and then use ► button to select **Teletext Language** .
- 4 Press the ▲ / ▼ button to select the required language.
- 5 Press the **EXIT** button to return to normal TV viewing.

! NOTE

- a. Please select your local teletext language.
- b. If you don't, the teletext may not appear correctly on the screen.
- c. This feature is not available in all countries.

SWITCH ON/OFF

- 1 Press the **TEXT** button to switch to teletext. The initial page or last page appears on the screen. Two page numbers, TV station name, date and time are displayed on the screen headline. The first page number indicates your selection, while the second shows the current page displayed. Press the **TEXT** button to switch off teletext. The previous mode reappears.

SIMPLE TEXT (OPTION)

■ Page selection

- 1 Enter the desired page number as a three digit number with the NUMBER buttons. If during selection you press a wrong number, you must complete the three digit number and then re-enter the correct page number.
 - 2 The PR ▲ / ▼ button can be used to select the preceding or following page.
-

TOP TEXT (OPTION)

- The user guide displays four fields-red, green, yellow and blue at the bottom of the screen. The yellow field denotes the next group and the blue field indicates the next block.

■ Block / group / page selection

- 1 With the blue button you can progress from block to block.
 - 2 Use the yellow button to proceed to the next group with automatic overflow to the next block.
 - 3 With the green button you can proceed to the next existing page with automatic overflow to the next group.
 - Alternatively the PR ▲ button can be used.
 - 4 The red button permits to return to previous selection. Alternatively the PR ▼ button can be used.
-

■ Direct page selection

- 1 Corresponding to the SIMPLE teletext mode, you can select a page by entering it as a three digit number using the NUMBER buttons in TOP mode.
-

FASTEXT

- The teletext pages are colour coded along the bottom of the screen and are selected by pressing the corresponding coloured button.

■ Page selection

- 1 Press the  button to select the index page.
 - 2 You can select the pages which are colour coded along the bottom line with the same coloured buttons.
 - 3 Corresponding to the SIMPLE teletext mode, you can select a page by entering its three digit page number with the NUMBER buttons in FASTEXT mode.
 - 4 The PR ▲ / ▼ button can be used to select the preceding or following page.
-

SPECIAL TELETEXT FUNCTIONS

REVEAL

Press this button to display concealed information, such as solutions of riddles or puzzles.

Press this button again to remove the information from the display.

SIZE

Selects double height text.

Press this button to enlarge the top half of the page.

Press this button again to enlarge the bottom half of the page.

Press this button again to return to the normal display.

UPDATE

Displays the TV picture on the screen while waiting for the new teletext page.

Press this button to view the updated teletext page.

HOLD

Stops the automatic page change which will occur if a teletext page consists of 2 or more sub pages. The number of sub pages and the sub page displayed is, usually, shown on the screen below the time. When this button is pressed the stop symbol is displayed at the top left-hand corner of the screen and the automatic page change is inhibited.

To continue press this button again.

TIME

This button has two functions:

a) When viewing a TV programme, press this button to display the time at the top right hand corner of the screen. Press this button again to remove the display.

b) In teletext mode, press this button to select a sub page number. The sub page number is displayed at the bottom of the screen. To hold or change the sub page, press the RED/ GREEN or PR ▲ / ▼ buttons. Press this button again to exit this function.

TV MENU

ON SCREEN MENUS SELECTION AND ADJUSTMENT

Your set's OSD (On Screen Display) may differ slightly from what is shown in this manual.

- 1 Press the **MENU** button and then **▲ / ▼** button to display each menu.
- 2 Press the **▶** button and then **▲ / ▼** button to select a menu item.
- 3 Change the setting of an item in the sub or pull-down menu with **◀ / ▶** button.
You can move to the higher level menu by pressing the **OK** or **MENU** button.

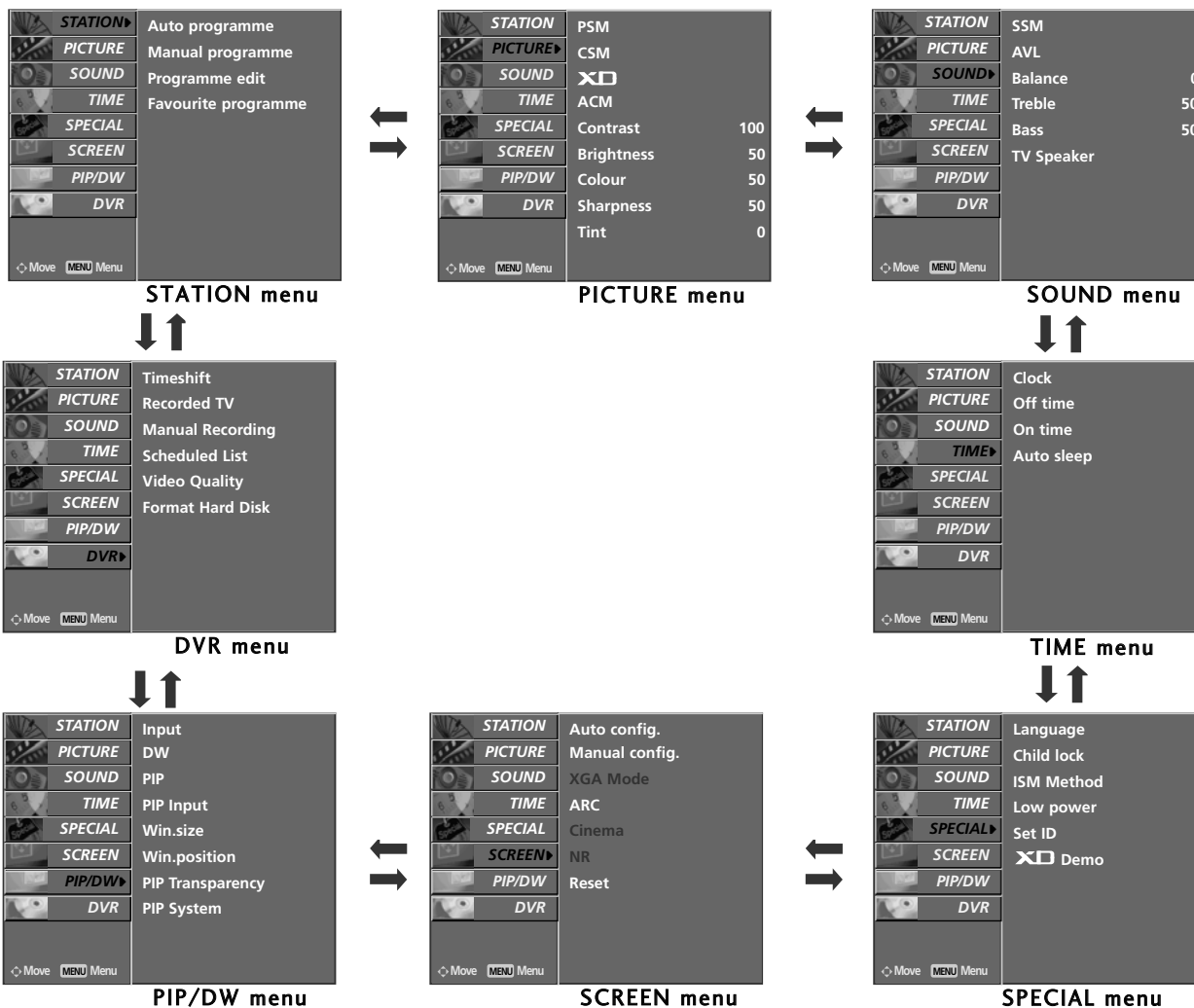

! NOTE

- a. In the teletext mode, menus are not displayed.
- b. It's not available to use STATION, PIP/DW menu on playing recorded programme.

AUTO PROGRAMME TUNING

- All stations that can be received are stored by this method. It is recommended that you use auto programme during installation of this set.
- It's not available to use this function on recording programme.

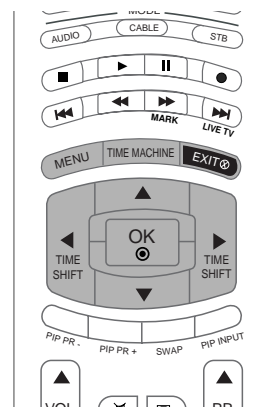

- 1 Press the **MENU** button and then **▲ / ▼** button to select the **STATION** menu.
- 2 Press the **▶** button and then **▲ / ▼** button to select **Auto programme**.
- 3 Press the **▶** button to select **System**.
- 4 Select a TV system with the **◀ / ▶** button;

- L** : SECAM L/L' (option)
- BG** : PAL B/G, SECAM B/G (Europe / East Europe / Asia / New Zealand / M.East / Africa / Australia)
- I** : PAL I/II (U.K. / Ireland / Hong Kong / South Africa)
- DK** : PAL D/K, SECAM D/K (East Europe / China / Africa / CIS)
- M** : (USA / Korea / Philippines) (option)

- 5 Press the **▼** button to select **Storage from**.
- 6 Select the beginning programme number with the **◀ / ▶** button or **NUMBER** buttons on the **Storage from** menu.
- 7 Press the **▼** button to select **Start**.
- 8 Press the **▶** button to begin auto programming. All receivable stations are stored.

! NOTE

In some models, the station name is stored for stations which broadcast VPS (Video Programme Service), PDC (Programme Delivery Control) or TELETEXT data. If no station name can be assigned to a station, the channel number is assigned and stored as C (V/UHF 01-69) or S (Cable 01-47), followed by a number.

- 9 To stop auto programming, press the **MENU** button. When auto programming is completed, the **Programme edit** menu appears on the screen. See the 'Programme edit' section to edit the stored programme.
- 10 Press the **EXIT** button to return to normal TV viewing.

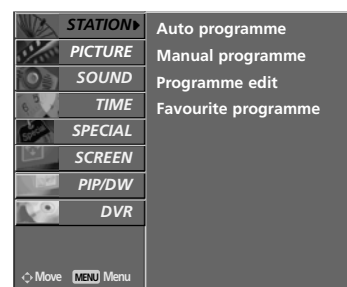

1

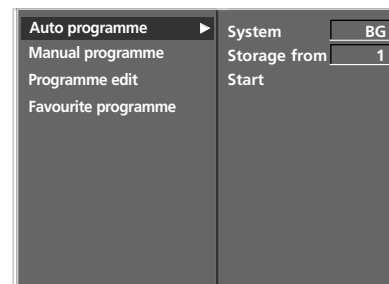

2 3 4 5 6 7

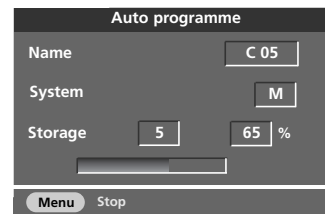

8 9

MANUAL PROGRAMME TUNING

- Manual programme lets you manually tune and arrange the stations in whatever order you desire. Also you can assign a station name with five characters to each programme number.
- It's not available to use this function in Timeshift **On** mode.
- It's not available to use this function on recording programme.

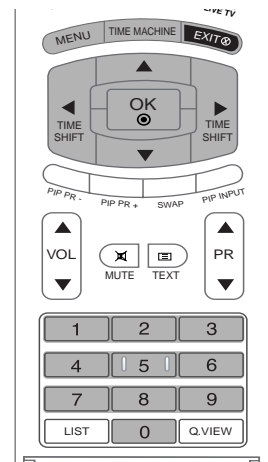

- 1 Press the **MENU** button and then **▲ / ▼** button to select the **STATION** menu.
- 2 Press the **▶** button and then **▲ / ▼** button to select **Manual programme**.
- 3 Press the **▶** button to select **Storage**. Select the desired programme number with the **◀ / ▶** button or **NUMBER** buttons on the **Storage** menu.
- 4 Press the **▼** button to select **System**.
- 5 Select a TV system with the **◀ / ▶** button;
 - L** : SECAM L/L' (option)
 - BG** : PAL B/G, SECAM B/G (Europe / East Europe / Asia / New Zealand / M.East / Africa /Australia)
 - I** : PAL I/II (U.K. / Ireland / Hong Kong / South Africa)
 - DK** : PAL D/K, SECAM D/K (East Europe / China / Africa / CIS)
 - M** : (USA / Korea / Philippines) (option)
- 6 Press the **▼** button to select **Band**.
- 7 Press the **◀ / ▶** button to select **V/UHF** or **Cable** as required.
- 8 Press the **▼** button to select **Channel**.
- 9 You can select the desired channel number with the **◀ / ▶** button or **NUMBER** buttons. If possible, select the channel number directly with the number buttons.
- 10 Press the **▼** button to select **Search**.
- 11 Press the **◀ / ▶** button to commence searching. If a station is found the search will stop.
- 12 Press the **OK** button to store it.
- 13 To store another station, repeat steps **3** to **12**.
- 14 Press the **EXIT** button to return to normal TV viewing.

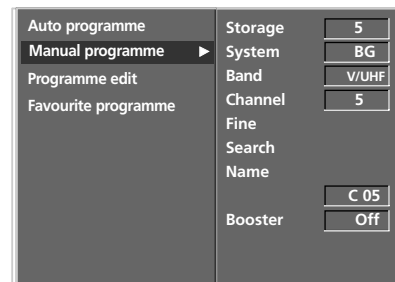
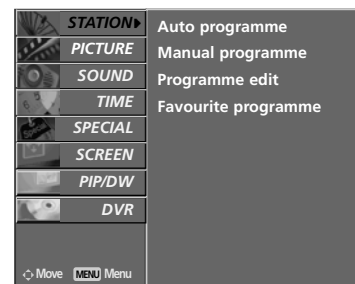

- 2
- 3
- 4
- 5
- 6
- 7
- 8
- 9
- 10
- 11
- 12

FINE TUNING

- Normally fine tuning is only necessary if reception is poor.

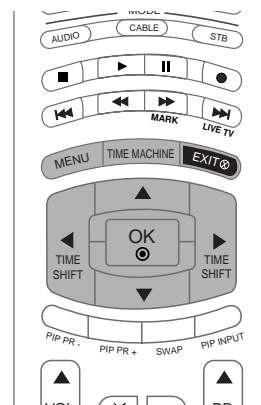

- 1 Press the **MENU** button and then ▲ / ▼ button to select the **STATION** menu.
- 2 Press the ► button and then ▲ / ▼ button to select **Manual programme**.
- 3 Press the ► button and then ▲ / ▼ button to select **Fine**.
- 4 Press the ◀ / ▶ button to to fine tune for the best picture and sound.
- 5 Press the **OK** button.
- 6 Press the **EXIT** button to return to normal TV viewing.
The finely tuned programme will be indicated by yellow number during programme selection.

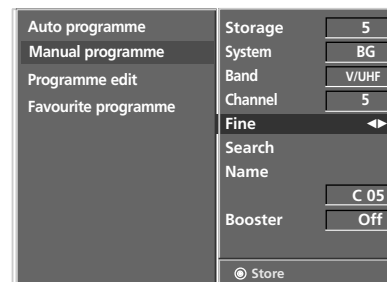
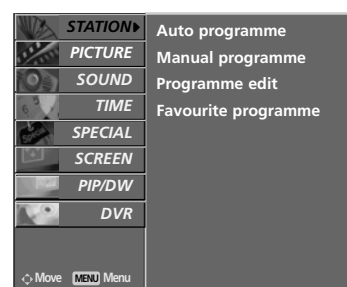

3 4 5

ASSIGNING A STATION NAME

- You can assign a station name with five characters to each programme number.

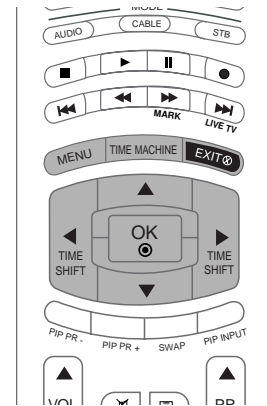

- 1 Press the **MENU** button and then **▲ / ▼** button to select the **STATION** menu.
- 2 Press the **▶** button and then **▲ / ▼** button to select **Manual programme**.
- 3 Press the **▶** button to display the **Name** menu.
- 4 Press the **▲** button. You can use a blank, +, -, the alphabet **A to Z** and the numeric **0 to 9**.
With the **▼** button you can select in the opposite direction.
- 5 Select the next position by pressing the **▶** button and then take your choice of the second character, and so on.
- 6 Press the **OK** button in twice.
- 7 Press the **EXIT** button to return to normal TV viewing.

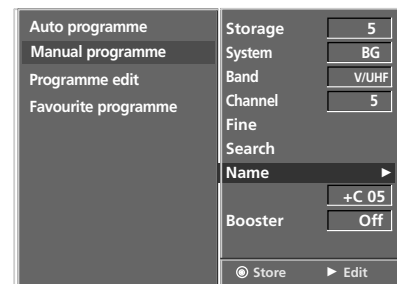
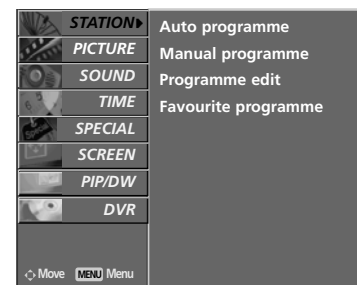

- 2
- 3
- 4
- 5
- 6

BOOSTER (OPTION)

- In some models, **Booster** is an optional function. Only a set with **Booster** can perform this function.
- If the reception is poor at the fringe area of TV signal, select **Booster to On**.

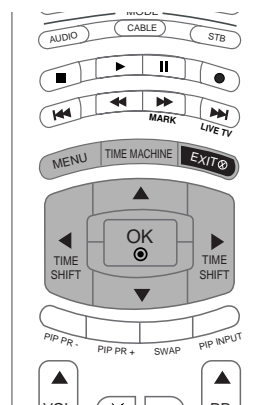

- 1 Press the **MENU** button and then **▲ / ▼** button to select the **STATION** menu.
- 2 Press the **▶** button and then **▲ / ▼** button to select **Manual programme**.
- 3 Press the **▶** button and then use **▲ / ▼** button to select **Booster**.
- 4 Press the **◀ / ▶** button to select **On** or **Off**.
- 5 Press the **OK** button.
- 6 Press the **EXIT** button to return to normal TV viewing.

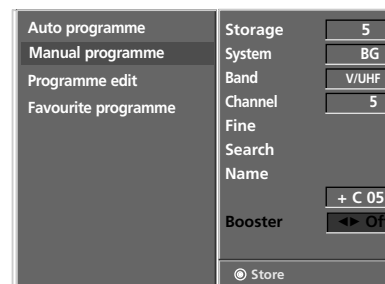
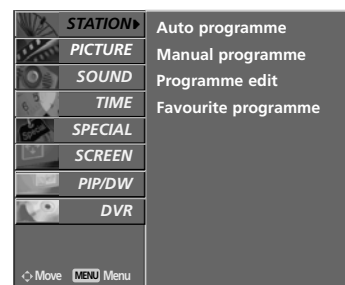

2 3 4 5

PROGRAMME EDIT

- This function enables you to delete or skip the stored programmes. Also you can move some stations to other programme numbers or copy a blank station data into the selected programme number.
- It's not available to use this function on recording programme.

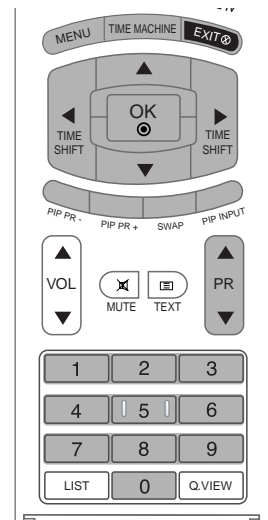

- 1 Press the **MENU** button and then **▲ / ▼** button to select the **STATION** menu.
- 2 Press the **▶** button and then **▲ / ▼** button to select **Programme edit**.
- 3 Press the **▶** button to display the **Programme edit** menu.

■ Deleting a programme

1. Select a programme to be deleted with the **▲ / ▼ / ◀ / ▶** button.
2. Press the **RED** button twice. The selected programme is deleted, all the following programmes are shifted up one position.

■ Copying a programme

1. Select a programme to be copied with the **▲ / ▼ / ◀ / ▶** button.
2. Press the **GREEN** button. All the following programmes are shifted down one position.

■ Moving a programme

1. Select a programme to be moved with the **▲ / ▼ / ◀ / ▶** button.
2. Press the **YELLOW** button.
3. Move the programme to the desired programme number with the **▲ / ▼ / ◀ / ▶** button.
4. Press the **YELLOW** button again to release this function.

■ Skipping a programme number

1. Select a programme number to be skipped with the **▲ / ▼ / ◀ / ▶** button.
2. Press the **BLUE** button. The skipped programme turns to blue.
3. Press the **BLUE** button again to release the skipped programme. When a programme number is skipped it means that you will be unable to select it using the **PR ▲ / ▼** button during normal TV viewing. If you want to select the skipped programme, directly enter the programme number with the **NUMBER** buttons or select it in the programme edit or table menu.

- 4 Press the **EXIT** button to return to normal TV viewing.

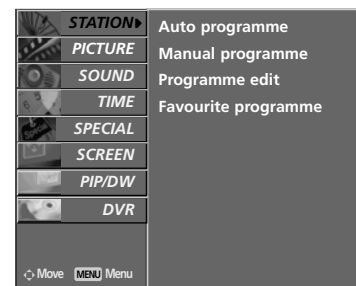

1

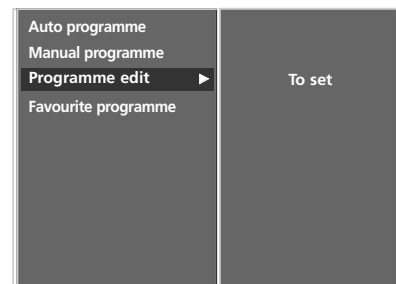

2

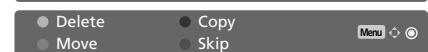
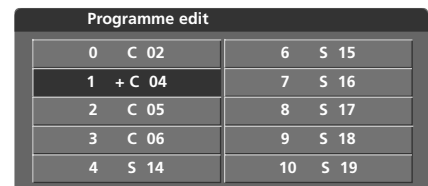

3

FAVOURITE PROGRAMME

This function lets you select your favourite programmes directly. Repeatedly press the **FAV** button to select stored favourite programmes.

- 1 Press the **MENU** button and then **▲ / ▼** button to select the **STATION** menu.
- 2 Press the **▶** button and then **▲ / ▼** button to select **Favourite programme**.
- 3 Press the **▶** button to display the **Favourite programme** menu.
- 4 Press the **▲ / ▼** button to select - - - - -.
- 5 Select a desired programme with the **◀ / ▶** button or **NUMBER** buttons. Any number under 10 is entered with a numeric '0' (or '00') in front of it, i.e. '05' (or '005') for 5.
- 6 To store another programme, repeat steps 4 to 5. You can store up to 8 programmes.
- 7 Press the **OK** button.
- 8 Press the **EXIT** button to return to normal TV viewing.

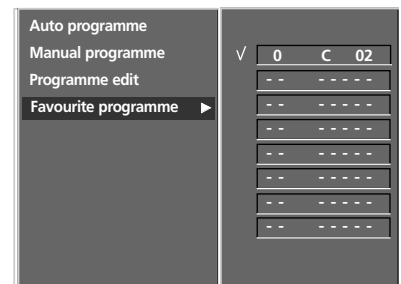
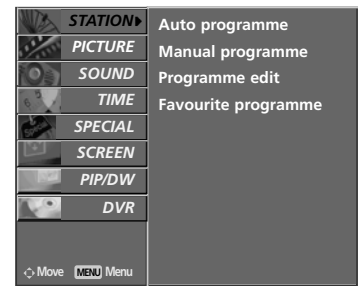
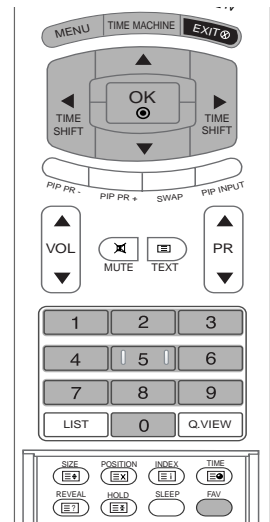

- 2
- 3
- 4
- 5
- 6
- 7

CALLING THE PROGRAMME TABLE

- You can check the programmes stored in the memory by displaying the programme table.

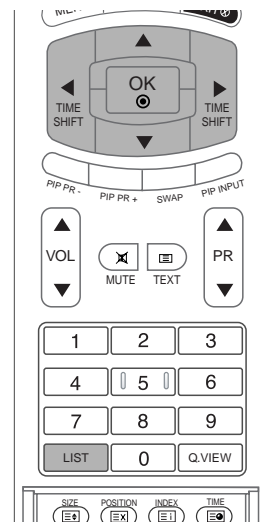

■ Displaying programme table

Press the **LIST** button to display the Programme table menu.
The programme table appears on the screen.

! NOTE

- You may find some blue highlighted programmes shown. They have been set up in the programme edit mode.
- Some programmes with the channel number shown in the programme table indicate there is no station name assigned.

■ Selecting a programme in the programme table

Select a programme with the **▲ / ▼ / ◀ / ▶** button.
Then press the **OK** button.
The set switches to the chosen programme number.

■ Paging through a programme table

There are 10 programme table pages in which contain 100 programmes.
Pressing the **▲ / ▼ / ◀ / ▶** button repeatedly turns the pages.

Press the **LIST** button to return to normal TV viewing.

Programme list

0	C 02	6	S 15
1	C 04	7	S 16
2	C 05	8	S 17
3	C 06	9	S 18
4	S 14	10	S 19

PSM (PICTURE STATUS MEMORY)

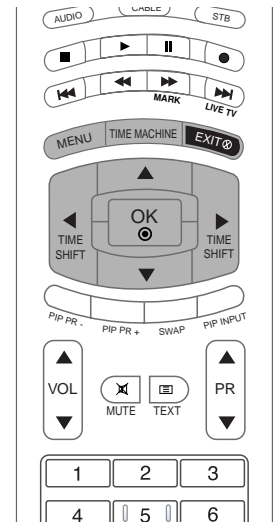

1 Press the **MENU** button and then ▲ / ▼ button to select the **PICTURE** menu.

2 Press the ► button and then ▲ / ▼ button to select **PSM**.

3 Press the ► button and then ▲ / ▼ button to select **Dynamic, Standard, Mild or User**.

4 Press the **EXIT** button to return to normal TV viewing.

- This function adjusts the set to the best picture appearance. Select the preset value in the **PSM** menu based on the programme category.
- When adjusting picture options (contrast, brightness, colour, sharpness and tint (NTSC input only)) manually, **PSM** is automatically changed to **User**.
- Picture options **Dynamic, Standard, Mild and User** are preset and programmed for good picture quality at the factory and cannot be changed.

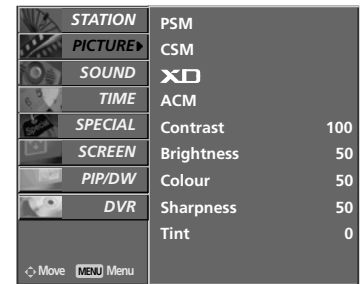

1

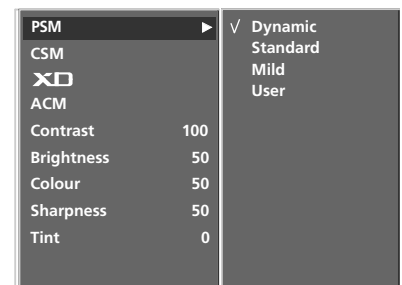

2 3

CSM (COLOUR STATUS MEMORY)

- To initialize values (reset to default settings), select the **Normal** option.
- When adjusting colour temperature options (red, green, or blue) manually, CSM automatically changes to **User**.
- Choose one of three automatic colour adjustments. Set to warm to enhance hotter colours such as red, or set to cool to see less intense colours with more blue.

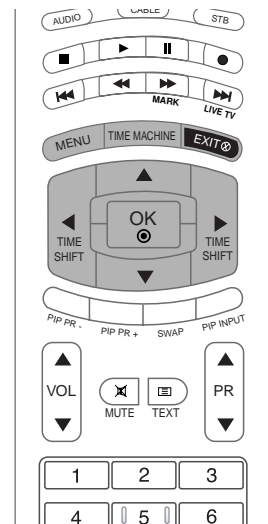

- 1 Press the **MENU** button and then ▲ / ▼ button to select the **PICTURE** menu.
- 2 Press the ► button and then ▲ / ▼ button to select **CSM**.
- 3 Press the ► button and then use ▲ / ▼ button to select the desired colour temperature.
- 4 Press the **EXIT** button to return to normal TV viewing.



1

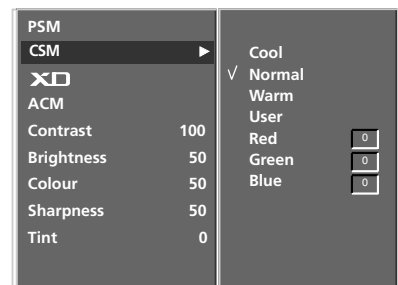

2 3

MANUAL COLOUR TEMPERATURE CONTROL (CSM - USER OPTION)

- You can adjust red, green, blue to any colour temperature you prefer.

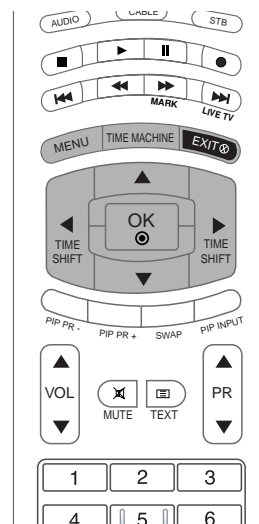

- 1 Press the **MENU** button and then ▲ / ▼ button to select the **PICTURE** menu.
- 2 Press the ► button and then ▲ / ▼ button to select **CSM**.
- 3 Press the ► button and then ▲ / ▼ button to select **User**.
- 4 Press the ► button and then use ▲ / ▼ / ◀ / ▶ button to make appropriate adjustments.
- 5 Press the **EXIT** button to return to normal TV viewing.

STATION	PSM	
PICTURE	CSM	
SOUND	XD	
TIME	ACM	
SPECIAL	Contrast	100
SCREEN	Brightness	50
PIP/DW	Colour	50
DVR	Sharpness	50
	Tint	0

◁ Move MENU Menu

1

PSM		
CSM	►	Cool
XD		Normal
ACM		Warm
Contrast	100	√ User
Brightness	50	Red
Colour	50	Green
Sharpness	50	Blue
Tint	0	0

2 3 4

XD FUNCTION

- XD is LG Electronic's unique picture improving technology to display a real HD source through an advanced digital signal processing algorithm.
- You can enjoy the vivid and hi-definition picture with LG's Excellent Digital Reality processor technology.
- It's not available to use this function in RGB[PC] or HDMI[PC] modes.
- When selecting picture options (Dynamic, Standard and Mild) in PICTURE menu, XD is automatically changed to On.

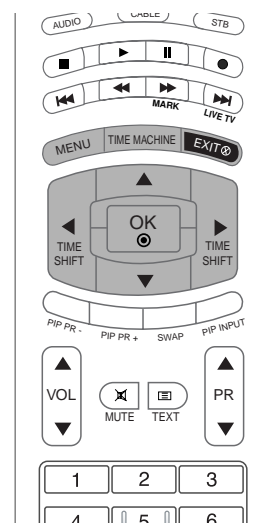

- 1 Press the **MENU** button and then ▲ / ▼ button to select the **PICTURE** menu.
- 2 Press the ► button and then ▲ / ▼ button to select **XD**.
- 3 Press the ► button and then ▲ / ▼ button to select **On** or **Off**.
- 4 Press the **EXIT** button to return to normal TV viewing.

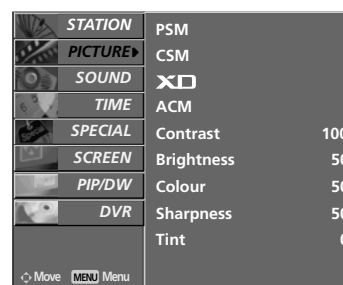

1

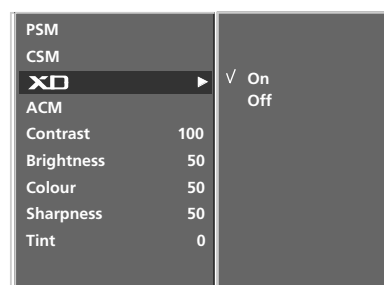

2 3

sRGB FUNCTION

- When the set is connected to external equipment with the sRGB function, the colour difference is adjusted the equal image of each other.
- This function works in the following mode : RGB[PC], HDMI[PC].

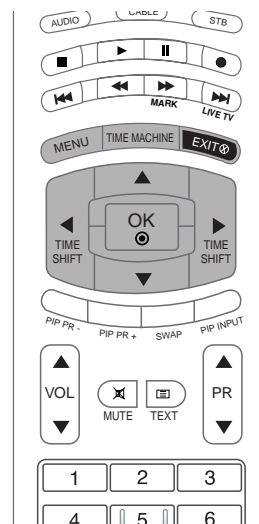

- 1 Press the **MENU** button and then ▲ / ▼ button to select the **PICTURE** menu.
- 2 Press the ► button and then ▲ / ▼ button to select **sRGB**.
- 3 Press the ► button and then ▲ / ▼ button to select **On** or **Off**.
- 4 Press the **EXIT** button to return to normal TV viewing.



1



2 3

ACM (ACTIVE COLOUR MANAGEMENT)

- Adjust the ACM to select the desired skin colour option.
- This function works in the following mode:
TV, AV1, AV2, COMPONENT, RGB[DTV], HDMI[DTV].
- It's not available to use this function in XD Off mode.

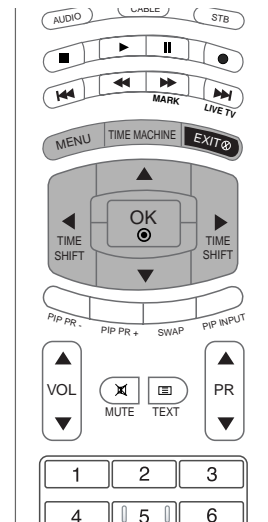

- 1 Press the **MENU** button and then ▲ / ▼ button to select the **PICTURE** menu.
- 2 Press the ► button and then ▲ / ▼ button to select **ACM**.
- 3 Press the ► button and then use ◀ / ▶ button to make appropriate adjustments.
- 4 Press the **EXIT** button to return to normal TV viewing.



1

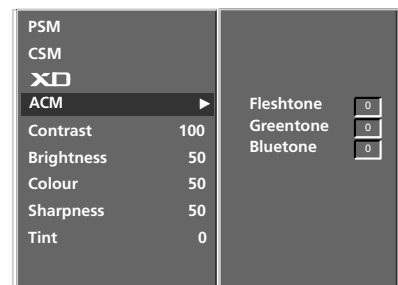

2 3

MANUAL PICTURE CONTROL

- You can adjust picture contrast, brightness, colour, sharpness and tint (NTSC input only) to the levels you prefer.
- It's not available to use colour, sharpness function in RGB[PC], HDMI[PC] mode.
- In the broadcasting system PAL/SECAM, the picture item Tint doesn't work.

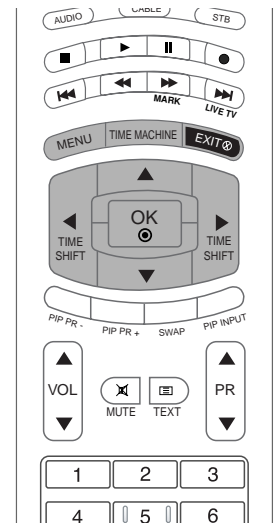

- 1 Press the **MENU** button and then ▲ / ▼ button to select the **PICTURE** menu.
- 2 Press the ► button and then use ▲ / ▼ button to select the desired picture option.
- 3 Press the ► button and then use ◀ / ▶ button to make appropriate adjustments.
- 4 Press the **EXIT** button to return to normal TV viewing.

STATION	PSM	
PICTURE	CSM	
SOUND	XD	
TIME	ACM	
SPECIAL	Contrast	100
SCREEN	Brightness	50
PIP/DW	Colour	50
DVR	Sharpness	50
	Tint	0

◁ Move MENU Menu

1

PSM	
CSM	
XD	
ACM	
Contrast	100 ▶
Brightness	50
Colour	50
Sharpness	50
Tint	0

2 3

SSM (SOUND STATUS MEMORY)

- This function lets you enjoy the best sound without any special adjustment because the set automatically selects the appropriate sound option based on the program content.
- When adjusting sound options (treble and bass) manually, SSM is automatically changed to User.
- The sound **SRS TSXT**, **Flat**, **Music**, **Movie** and **Sports** are programmed for good sound reproduction at the factory and cannot be changed.

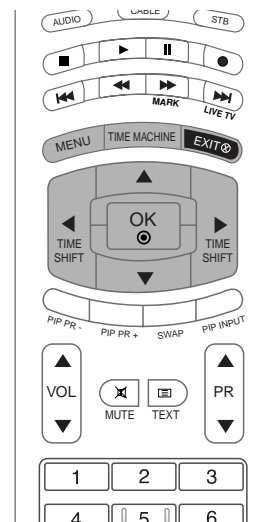

- 1 Press the **MENU** button and then **▲ / ▼** button to select the **SOUND** menu.
- 2 Press the **▶** button and then **▲ / ▼** button to select **SSM**.
- 3 Press the **▶** button and then **▲ / ▼** button to select **SRS TSXT**, **Flat**, **Music**, **Movie**, **Sports** or **User**.
- 4 Press the **EXIT** button to return to normal TV viewing.

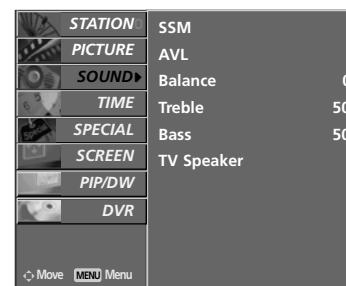

1

! NOTE

- a. **SRS** is a trademark of SRS Labs, Inc.
- b. TruSurround XT technology is incorporated under license from SRS Labs, Inc.

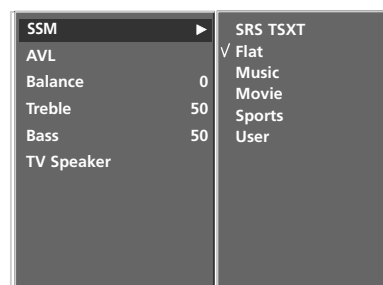

2 3

AVL (AUTO VOLUME LEVELER)

- AVL automatically keeps on an equal volume level even if you change programmes.

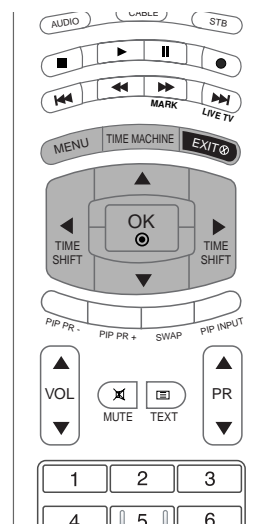

- 1 Press the **MENU** button and then ▲ / ▼ button to select the **SOUND** menu.
- 2 Press the ► button and then ▲ / ▼ button to select **AVL**.
- 3 Press the ► button and then ▲ / ▼ button to select **On** or **Off**.
- 4 Press the **EXIT** button to return to normal TV viewing.

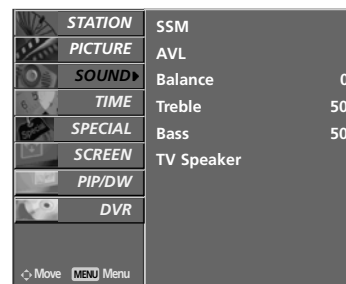

1

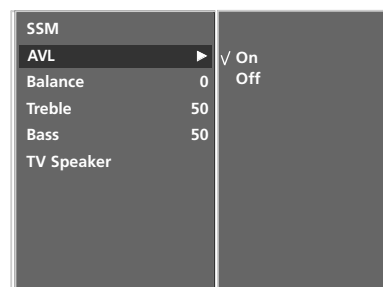

2 3

ADJUSTING SOUND CONTROL

- 1 Press the **MENU** button and then ▲ / ▼ button to select the **SOUND** menu.
- 2 Press the ► button and then use ▲ / ▼ button to select the desired sound item.
- 3 Press the ► button and then use ◀ / ▶ button to make appropriate adjustments.
- 4 Press the **EXIT** button to return to normal TV viewing.

! NOTE

- a. Treble or Bass aren't suitable for use with **SRS TSXT**.

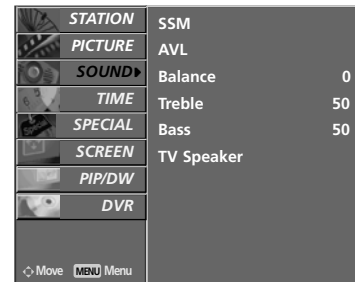
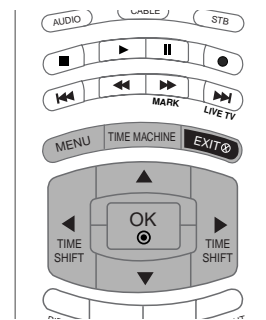

1

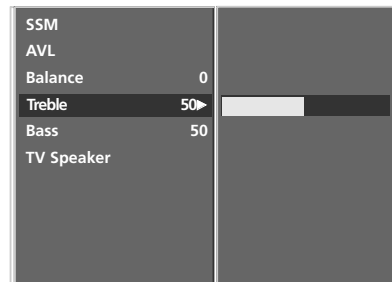

2 3

TV SPEAKER

You can adjust the internal speaker status.

In AV1, AV2, COMPONENT, RGB and HDMI/DVI with HDMI to DVI cable, TV speaker and/or variable audio can be outputted even though there is no video signal.

If you want to use your external hi-fi stereo system, turn off the internal speakers of the set.

- 1 Press the **MENU** button and then ▲ / ▼ button to select the **SOUND** menu.
- 2 Press the ► button and then ▲ / ▼ button to select **TV Speaker**.
- 3 Press the ► button and then ▲ / ▼ button to select **On** or **Off**.
- 4 Press the **EXIT** button to return to normal TV viewing.

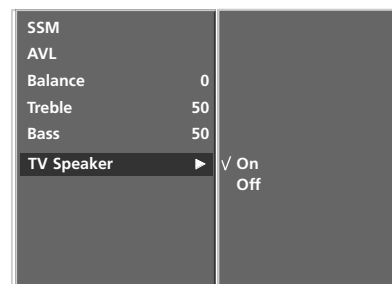
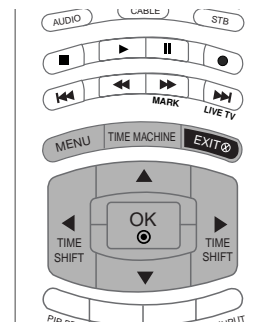

2 3

STEREO/DUAL RECEPTION

- When a programme is selected, the sound information for the station appears after the programme number and station name disappear.

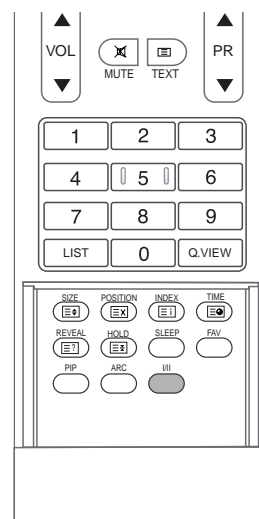

1 On Screen Display

Press the I/II button to received broadcast state.

Broadcast	On Screen Display
Mono	MONO
Stereo	STEREO
Dual	DUAL I

2 Mono sound selection

In stereo reception if the stereo signal is weak, you can switch to mono by pressing the I/II button twice. In mono reception the depth of sound is improved. To switch back to stereo, press the I/II button twice again.

3 Language selection for dual language broadcast

If a programme received in two languages (dual language), you can switch to **DUAL I**, **DUAL II** or **DUAL I+II** by pressing the I/II button repeatedly.

- **DUAL I** sends the primary broadcast language to the loudspeakers.
- **DUAL II** sends the secondary broadcast language to the loudspeakers.
- **DUAL I+II** sends a separate language to each loudspeaker.

NICAM RECEPTION (OPTION)

If the set is equipped with the receiver for NICAM reception, the high quality NICAM (Near Instantaneous Companding Audio Multiplex) digital sound can be received.

Sound output can be selected according to the type of received broadcast as follows by pressing the I/II button repeatedly.

-
- 1 When NICAM mono is received, you can select **NICAM MONO** or FM MONO.
 - 2 When NICAM stereo is received, you can select **NICAM STEREO** or FM MONO. If the stereo signal is weak, switch to FM mono.
 - 3 When NICAM dual is received, you can select **NICAM DUAL I**, **NICAM DUAL II**, **NICAM DUAL I + II**, or **MONO**. When FM mono is selected the display **MONO** appears on the screen.
-

SOUND OUTPUT SELECTION

- In AV, Component, RGB or HDMI/DVI mode, you can select output sound for the left and right loudspeakers.

Repeatedly press the I/II button to select the sound output.

- **L+R** : Audio signal from audio L input is sent to left loud-speaker and audio signal from audio R input is sent to right loud-speaker.
- **L+L** : Audio signal from audio L input is sent to left and right loud-speakers.
- **R+R** : Audio signal from audio R input is sent to left and right loud-speakers.

TV MENU | Time Menu Options

SETTING THE CLOCK

- If current time setting is erased by a power failure or the set is unplugged, reset the clock.

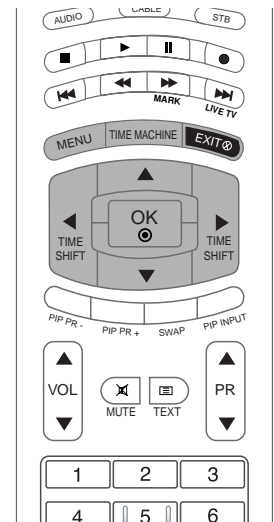

- 1 Press the **MENU** button and then use ▲ / ▼ button to select the **TIME** menu.
- 2 Press the ► button and then use ▲ / ▼ button to select **Clock**.
- 3 Press the ► button and then use ▲ / ▼ button to adjust the hour.
- 4 Press the ► button and then use ▲ / ▼ button to adjust the minute.
- 5 Press the **EXIT** button to return to normal TV viewing.

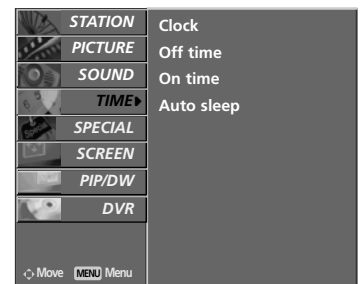

1

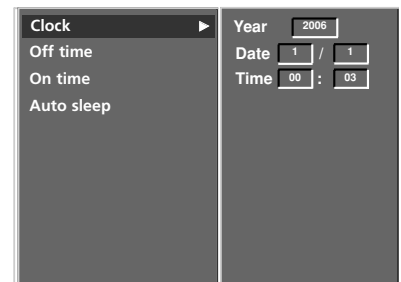

2 3 4

SETTING THE ON/OFF TIME

- Time function operates only if current time has been already set.
- Off Time function overrides On Time function if they are set to the same time.
- The set must be in standby mode for the On Time to work.

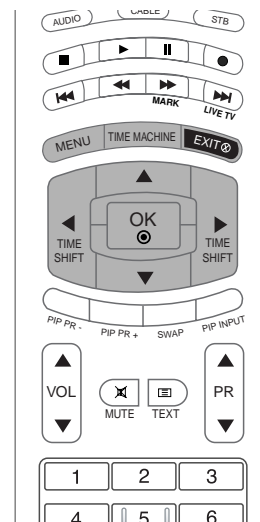

- 1 Press the **MENU** button and then use ▲ / ▼ button to select the **TIME** menu.
- 2 Press the ► button and then use ▲ / ▼ button to select **Off time** or **On time**.
- 3 Press the ► button and then use ▲ / ▼ button to select **On**.
- 4 Press the ► button and then use ▲ / ▼ button to adjust the hour.
- 5 Press the ► button and then use ▲ / ▼ button to adjust the minute.
- 6 Only **On time** function; Press the ► button and then use ▲ / ▼ button to adjust programme number or volume level.
- 7 Press the **EXIT** button to return to normal TV viewing.

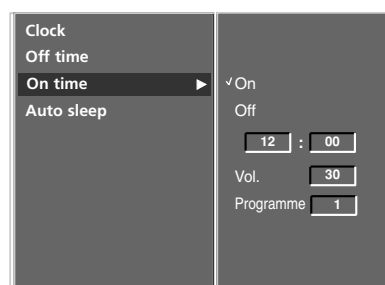
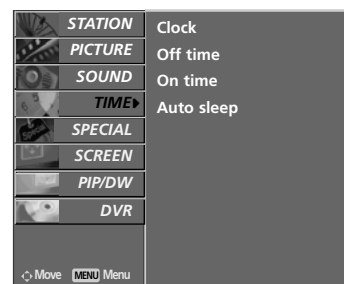

- 2
- 3
- 4
- 5
- 6

! NOTE

- To cancel **Off/On time** function. Press the ▲ / ▼ button to select **Off** in step 3.
- Two hours after the set is switched on by the **On time** function it will automatically switch back to standby mode unless a button has been pressed.

AUTO SLEEP

If set to on and there is no input signal, the set turns off automatically after 10 minutes.

- 1 Press the **MENU** button and then use ▲ / ▼ button to select the **TIME** menu.
- 2 Press the ► button and then use ▲ / ▼ button to select **Auto sleep**.
- 3 Press the ► button and then use ▲ / ▼ button to select **On** or **Off**.
- 4 Press the **EXIT** button to return to normal TV viewing.

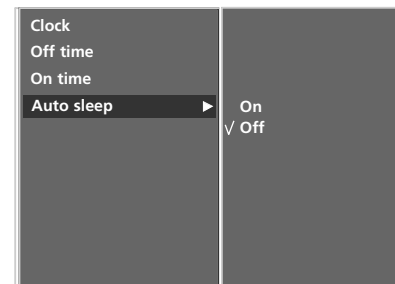
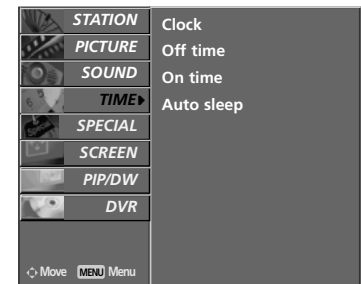
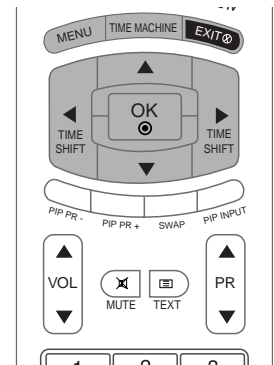

SLEEP TIMER

- Sleep timer turns the set off at the preset time.
- Press the **SLEEP** button to select the number of minutes. The display **L^{zz} --- Min** will appear on the screen, followed by **10, 20, 30, 60, 90, 120, 180** and **240** minutes. The timer begins to count down from the number of minutes selected.

- 1 To check the remaining sleep timer, press the **SLEEP** button once.
- 2 To cancel the sleep timer, repeatedly press the **SLEEP** button until the display **L^{zz} --- Min** appears.
- 3 If you turn the set off after setting the sleep timer, the setting will be erased.

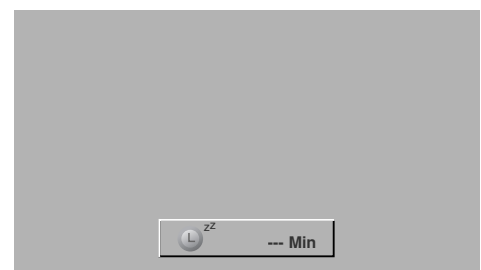
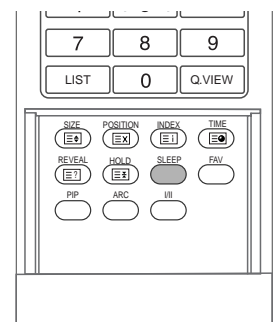

TV MENU | Special Menu Options

CHILD LOCK

- The set can be set so that the remote control handset is needed to control it.
- This feature can be used to prevent unauthorized viewing.

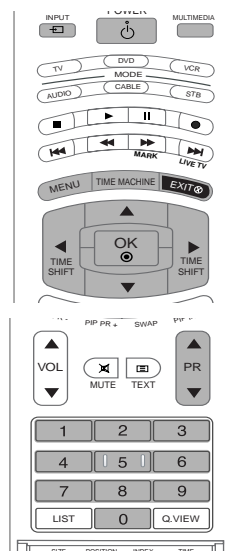

- 1 Press the **MENU** button and then use ▲ / ▼ button to select the **SPECIAL** menu.
- 2 Press the ► button and then use ▲ / ▼ button to select **Child lock**.
- 3 Press the ► button and then use ▲ / ▼ button to select **On** or **Off**.
- 4 Press the **EXIT** button to return to normal TV viewing.

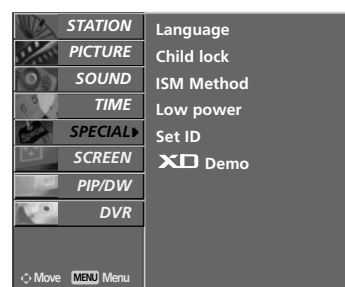

1

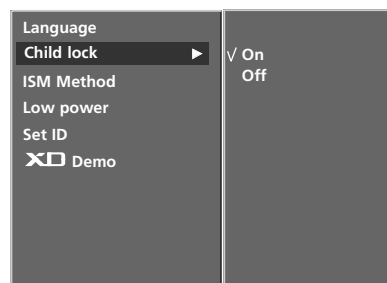

2 3

TV MENU

! NOTE

- The set is programmed to remember which option it was last set to even if you turn the set off.
- In **Child lock 'on'**, if the set is turned off, press the **⏻/I**, **INPUT**, **PR ▲ / ▼** button on the set or **POWER**, **INPUT**, **MULTIMEDIA**, **PR ▲ / ▼** or **NUMBER** buttons on the remote control.
- With the **Child lock on**, the display '**Child lock on**' appears on the screen if any button on the front panel is pressed while viewing the set.

ISM (IMAGE STICKING MINIMIZATION) METHOD

- A frozen or still picture from a PC/video game displayed on the screen for prolonged periods will result in a ghost image remaining even when you change the image. Avoid allowing a fixed image to remain on the set's screen for a long period of time.
- It's not available to use this function in LCD TV models.

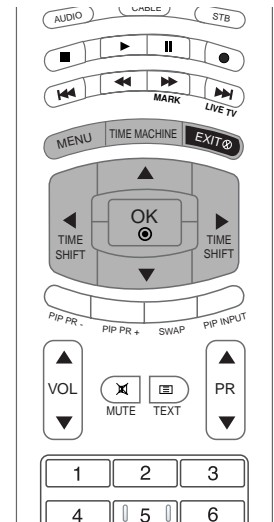

- 1 Press the **MENU** button and then use **▲ / ▼** button to select the **SPECIAL** menu.
- 2 Press the **▶** button and then **▲ / ▼** button to select **ISM Method**.
- 3 Press the **▶** button and then **▲ / ▼** button to select either **Normal, White wash, Orbiter** or **Inversion**. If you don't need to set this function, set **Normal**.

- **White wash :**
White Wash removes permanent images from the screen.
Note: An excessive permanent image may be impossible to clear entirely with White Wash.
- **Orbiter :**
Orbiter may help prevent ghost images. However, it is best not to allow any fixed image to remain on the screen. To avoid a permanent image on the screen, the screen will move every 2 minutes.
- **Inversion :**
This is the function to invert the panel colour of the screen. The panel colour is automatically inverted every 30 minutes.
- **Normal :**
When input signal is constantly static or temperature is high, brightest level will be decrease automatically for image sticking minimalization.



1

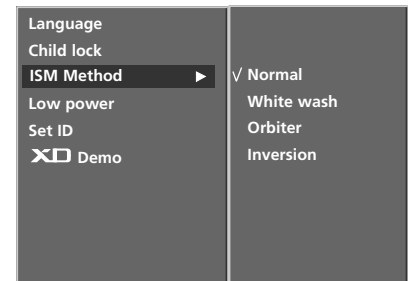

2 3

- 4 Press the **EXIT** button to return to normal TV viewing.

LOW POWER

- This is the function to reduce the power consumption of the set.
- It's not available to use this function in LCD TV models.

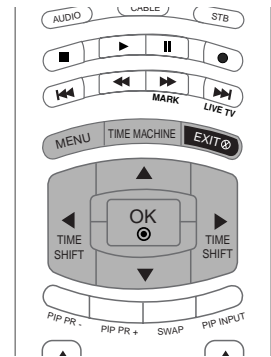

- 1 Press the **MENU** button and then use ▲ / ▼ button to select the **SPECIAL** menu.
- 2 Press the ► button and then use ▲ / ▼ button to select **Low power**.
- 3 Press the ► button and then use ▲ / ▼ button to select **On** or **Off**.
- 4 Press the **EXIT** button to return to normal TV viewing.



1

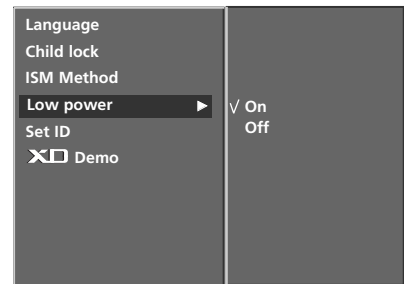

2 3

XD DEMO

- Use it to see the difference between XD Demo on and XD Demo off.
- It's not available to use this function in RGB[PC], HDMI[PC] mode.

- 1 Press the **MENU** button and then use ▲ / ▼ button to select the **SPECIAL** menu.
- 2 Press the ► button and then use ▲ / ▼ button to select **XD Demo**.
- 3 Press the ► button to begin **XD Demo**.
- 4 To stop **XD Demo**, press the **MENU** or **EXIT** button.

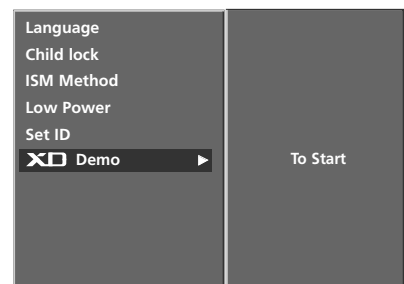

2 3

INDEX (OPTION)

- You can switch FRONT DISPLAY on or off.

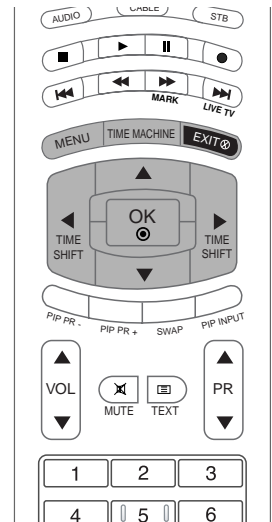

- 1 Press the **MENU** button and then use ▲ / ▼ button to select the **SPECIAL** menu.
- 2 Press the ► button and then use ▲ / ▼ button to select **Index**.
- 3 Press the ► button and then use ▲ / ▼ button to select **On** or **Off**.

When you select **On** mode, The FRONT DISPLAY illuminates brightly.

- 4 Press the **EXIT** button to return to normal TV viewing.

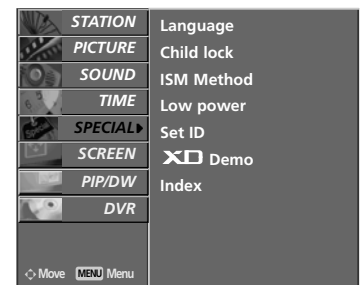

1

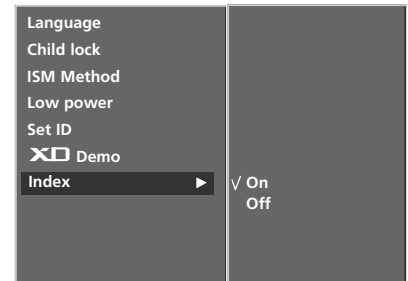

2 3

TV MENU | Screen Menu Options

AUTO CONFIG.

- Automatically adjusts picture position and minimizes image shaking.
- Although the image is still not correct, your set is functioning properly but needs further adjustment.
- The **Auto config.** functions don't need to be run for HDMI/DVI mode.
- This function works in the following mode : RGB[PC]
- This function is for the automatic adjustment of the screen position, clock, and phase. The displayed image will disappear for a few seconds while the auto configuration is in progress.

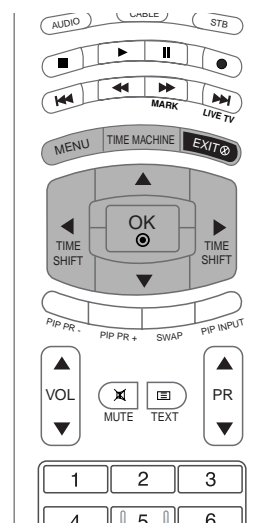

- 1 Press the **MENU** button and then use ▲ / ▼ button to select the **SCREEN** menu.
- 2 Press the ► button and then use ▲ / ▼ button to select **Auto config.**
- 3 Press the ► button to start **Auto config.**.
 - When **Auto config.** has finished, **OK** will be shown on screen.
 - If the position of the image is still not correct, try Auto adjustment again.
- 4 If picture needs to be adjusted more after Auto adjustment in RGB (PC), you can adjust the **Manual config.**
- 5 Press the **EXIT** button to return to normal TV viewing.

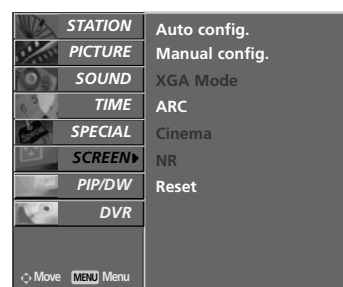

1

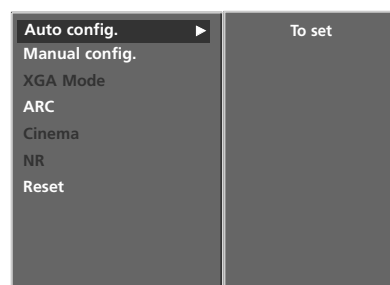

2 3 4

MANUAL CONFIG.

- If the picture isn't clear after auto adjustment and especially if characters are still trembling, adjust the picture phase manually.
- To correct the screen size, adjust **Clock**.
- This function works in the following mode:
RGB[PC], RGB[DTV], HDMI[DTV], COMPONENT[DTV] mode only
- It's not available to use **Phase, Clock** function in **RGB[DTV], HDMI[DTV], COMPONENT[DTV]** mode.

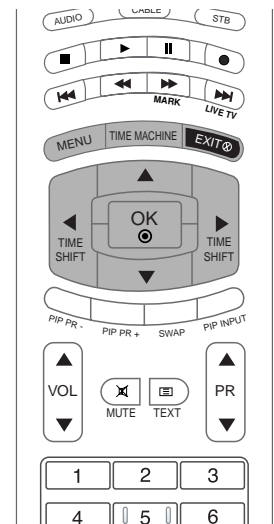

Mini Glossary

Clock This function is to minimize any vertical bars or stripes visible on the screen background. And the horizontal screen size will also change.

Phase This function allows you to remove any horizontal noise and clear or sharpen the image of characters.



- 1 Press the **MENU** button and then ▲ / ▼ button to select the **SCREEN** menu.
- 2 Press the ► button and then ▲ / ▼ button to select **Manual config.**
- 3 Press the ► button and then ▲ / ▼ button to select **Phase, Clock, H-Position** or **V-Position**.
- 4 Press the ◀ / ▶ button to make appropriate adjustments.
- 5 Press the **EXIT** button to return to normal TV viewing.

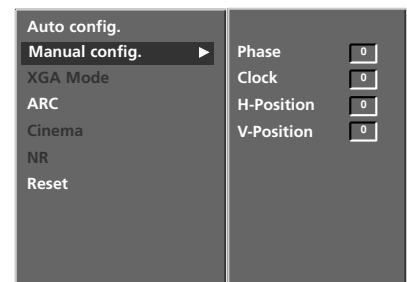

2 3 4

SELECTING WIDE XGA/VGA MODE

- To see a normal picture, match the resolution of RGB mode and selection of VGA/XGA mode.
- In some models, it's not available for selecting VGA mode.
- This function works in the following mode : RGB[PC]

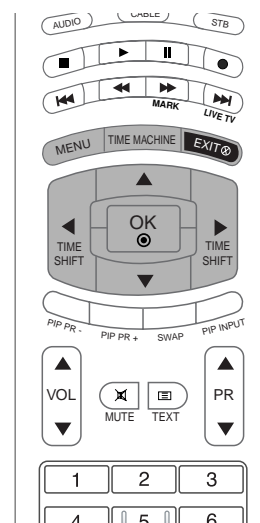

- 1 Press the **MENU** button and then use ▲ / ▼ button to select the **SCREEN** menu.
- 2 Press the ► button and then use ▲ / ▼ button to select **XGA Mode (VGA Mode)**.
- 3 Press the ► button and then use ▲ / ▼ button to select the desired XGA/VGA resolution.
- 4 Press the **EXIT** button to return to normal TV viewing.



1

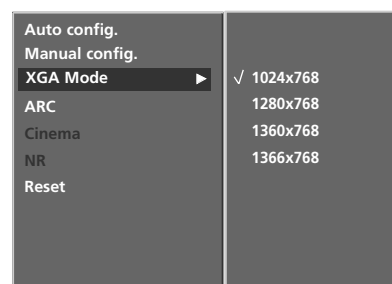

2 3

SETTING PICTURE FORMAT

- You can watch the screen in various picture formats; **Spectacle**, **Full** (option), **Original**, **4:3**, **16:9** (Wide), **14:9** and **Zoom**.
- If a fixed image is displayed on the screen for a long time, that fixed image may become imprinted on the screen and remain visible.
- You can only select **4:3** and **16:9** (Wide) in RGB[PC], HDMI[PC] mode only.
- You can only select **4:3**, **16:9** (Wide) and **Zoom** in RGB[DTV], HDMI[DTV], Component [DTV] mode only.
- You can only select **Spectacle**, **Full**, **4:3**, **16:9** (Wide), **14:9** and **Zoom** in Component [480i/576i] mode only.
- It might be uncomfortable in full mode. Then change into other mode.
- You can adjust the enlarge proportion using **▲ / ▼** button.
- This function works in the following signal.

- 1 Press the **MENU** button and then **▲ / ▼** button to select the **SCREEN** menu.
- 2 Press the **▶** button and then use **▲ / ▼** button to select **ARC**.
- 3 Press the **▶** button and then use **▲ / ▼** button to select **Spectacle**, **Full** (option), **Original**, **4:3**, **16:9** (Wide), **14:9** or **Zoom**.

• Spectacle

When your set receives the wide screen signal, when selected it will adjust the picture horizontally, in non-linear proportion, to fill the entire screen.

• Full (option)

When your set receives the wide screen signal, when selected it will adjust the picture horizontally or vertically, in a linear proportion, to fill the entire screen fully.

• Original

When your set receives the wide screen signal, it will be automatically changed to the picture format to be sent.

• 4:3

Following selection will lead you to view a picture with an original 4:3 aspect ratio, with gray bars appearing at both the left and right sides.

• 16:9 (Wide)

Following selection will lead you to adjust the picture horizontally, in a linear proportion, to fill the entire screen (useful for viewing 4:3 formatted DVDs).

• 14:9

You can enjoy the picture format of 14:9 or general set programme through the 14:9 mode.

The screen 14:9 is viewed just like that the screen 4:3 is magnified to the left / right.

• Zoom

Following selection will lead you to view the picture without any alternation, while filling the entire screen. However, the top and bottom portions of the picture will be cropped.

- 4 Press the **EXIT** button to return to normal TV viewing.

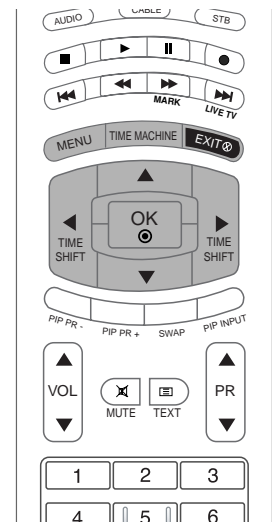

1

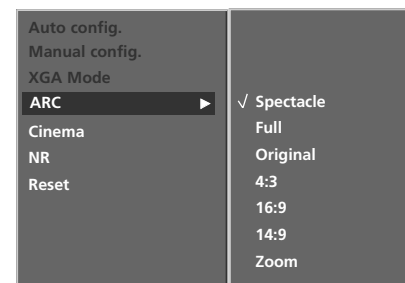

2 3

CINEMA

- When you watch the movie, this function adjusts the set to the best picture appearance.
- This function works in the following mode: TV, AV1, AV2 or COMPONENT (480i/576i).

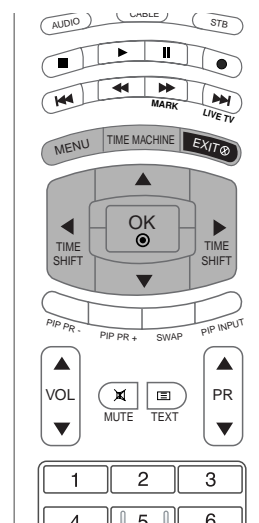

- 1 Press the **MENU** button and then ▲ / ▼ button to select the **SCREEN** menu.
- 2 Press the ► button and then use ▲ / ▼ button to select **Cinema**.
- 3 Press the ► button and then use ▲ / ▼ button to select **On** or **Off**.
- 4 Press the **EXIT** button to return to normal TV viewing.



1

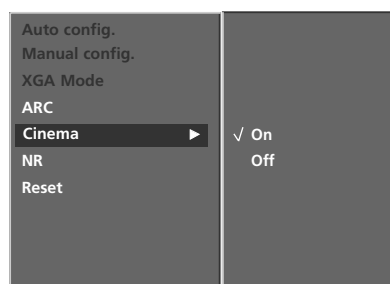

2 3

NR (NOISE REDUCTION)

- You can select **3D NR** or **MPEG NR** to reduce the picture noise which may appear on the screen during watching the set.
- This function is not available for use in **RGB[PC], HDMI[PC]** mode.
- **3D NR** is not available for use in **RGB, HDMI** and **Component[DTV]** mode.

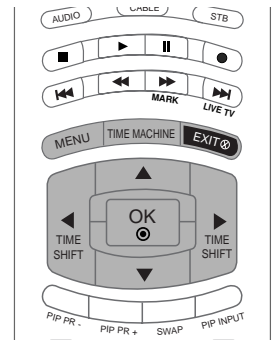

- 1 Press the **MENU** button and then use **▲ / ▼** button to select the **SCREEN** menu.
- 2 Press the **▶** button and then use **▲ / ▼** button to select **NR**.
- 3 Press the **▶** button and then use **▲ / ▼** button to select **3D NR** or **MPEG NR**.
- 4 Press the **◀ / ▶** button to make appropriate adjustments.
- 5 Press the **EXIT** button to return to normal TV viewing.

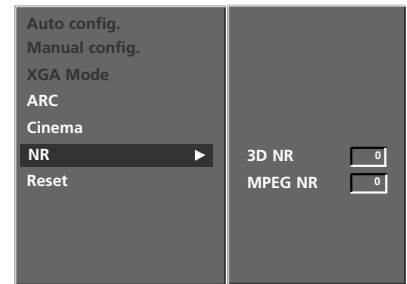

TV MENU

INITIALIZING (RESET TO ORIGINAL FACTORY SETTINGS)

- This function operates in current mode.
- To initialize the adjusted values.

- 1 Press the **MENU** button and then use **▲ / ▼** button to select the **SCREEN** menu.
- 2 Press the **▶** button and then **▲ / ▼** button to select **Reset**.
- 3 Press the **▶** button.
 - You can initialize Phase, Clock, H-Position, V-Position, Position, Win. size, Win. position, PIP Transparency and sub picture size of twin picture.

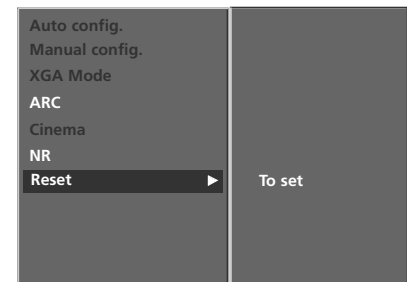
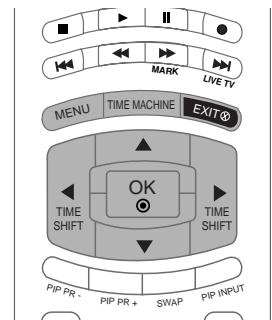

APPENDIX

EXTERNAL CONTROL DEVICE SETUP

- Connect the RS-232C input jack to an external control device (such as a computer or an A/V control system) and control the set's functions externally.

How to connect external control equipment

- Connect the serial port of the control device to the RS-232C jack on the Monitor back panel.
- RS-232C connection cables are not supplied with the set.
- The set remote control and front panel controls (except main power) will not be functional if the Monitor is controlled by a PC computer or other external device.

RS-232C Setup

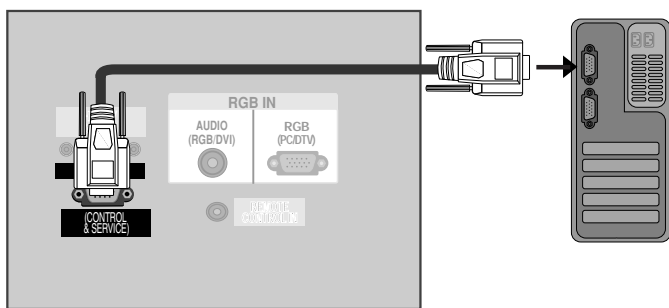

Type of Connector; D-Sub 9-Pin Male

No.	Pin Name
1	No connection
2	RXD (Receive data)
3	TXD (Transmit data)
4	DTR (DTE side ready)
5	GND
6	DSR (DCE side ready)
7	RTS (Ready to send)
8	CTS (Clear to send)
9	No Connection

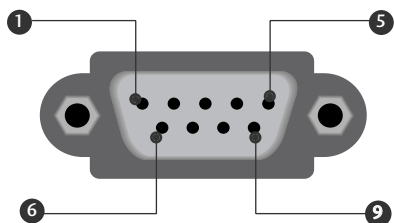

APPENDIX

RS-232C Configurations

7-Wire Configurations (Standard RS-232C cable)

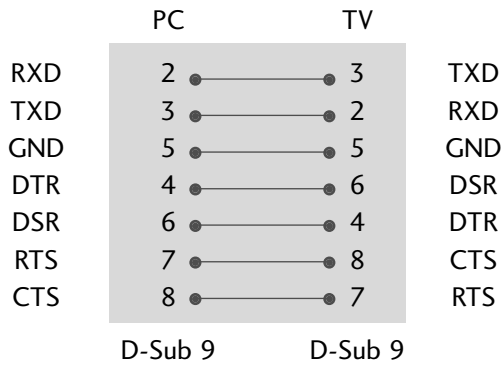

3-Wire Configurations (Not standard)

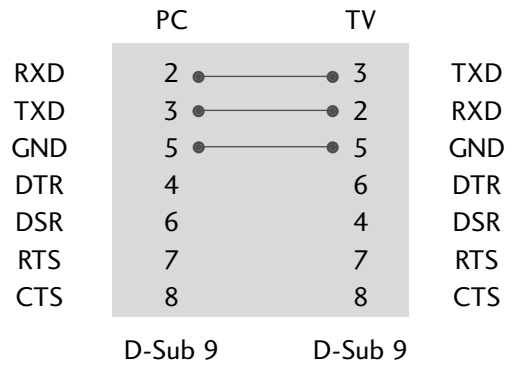

Set ID

Use this function to specify a set ID number. Refer to 'Real Data Mapping 1'. See page 86.

- 1 Press the **MENU** button and then use the ▲ / ▼ button to select the **SPECIAL** menu.
- 2 Press the ► button and then use ▲ / ▼ button to select **Set ID**.
- 3 Press the ► button and then use ◀ / ▶ button to adjust **Set ID** to choose the desired monitor ID number.
 - The adjustment range of **Set ID** is 1 ~ 99.
- 4 Press the **EXIT** button to return to normal TV viewing.

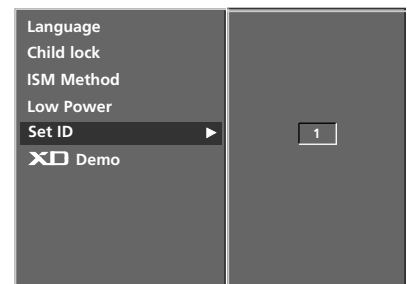
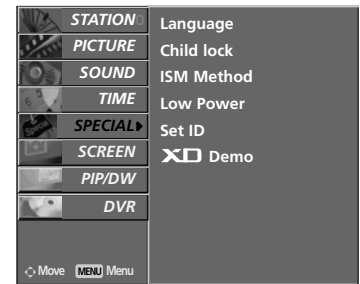
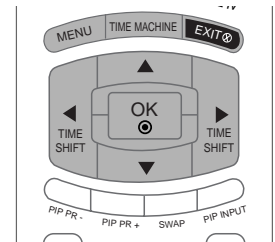

Communication Parameters

- Baud rate : 9600 bps (UART)
- Data length : 8 bits
- Parity : None
- Use a crossed (reverse) cable.
- Stop bit : 1 bit
- Communication code : ASCII code

Command Reference List

* When setting the 24 ~ 34, a menu doesn't display on screen.

	COMMAND1	COMMAND2	DATA (Hexadecimal)		COMMAND1	COMMAND2	DATA (Hexadecimal)
01. Power	k	a	0 ~ 1	18. Balance	k	t	0 ~ 64
02. Input Select	k	b	0 ~ 6	19. Colour Temperature(CSM)	k	u	0 ~ 3
03. Aspect Ratio	k	c	Refer to p.84	20. Red Adjustment	k	v	0 ~ 50
04. Screen Mute	k	d	0 ~ 1	21. Green Adjustment	k	w	0 ~ 50
05. Volume Mute	k	e	0 ~ 1	22. Blue Adjustment	k	\$	0 ~ 50
06. Volume Control	k	f	0 ~ 64	23. PIP input Source	k	y	0 ~ 6
07. Contrast	k	g	0 ~ 64	24. Abnormal Status	k	z	0 ~ 9
08. Brightness	k	h	0 ~ 64	25. ISM Method (option)	j	p	0 ~ 3
09. Colour	k	i	0 ~ 64	26. Low Power (option)	j	q	0 ~ 1
10. Tint (option)	k	j	0 ~ 64	27. Orbiter Time Setting (option)	j	r	1 ~ FE
11. Sharpness	k	k	0 ~ 64	28. Orbiter Pixel Setting (option)	j	s	1 ~ 3
12. OSD Select	k	l	0 ~ 1	29. Picture Size (option)	j	t	0 ~ 20
13. Remote Control Lock Mode	k	m	0 ~ 1	30. Auto Configure (option)	j	u	1
14. PIP/DW	k	n	Refer to p.85	31. Programme selection	m	a	0 ~ 63
15. PIP Position	k	q	0 ~ 3	32. Send IR Code	m	c	Key Code
16. Treble	k	r	0 ~ 64	33. Input select (Main)	x	b	Refer to p.87
17. Bass	k	s	0 ~ 64	34. Input select (PIP)	x	y	Refer to p.87

Transmission / Receiving Protocol

Transmission

[Command1][Command2][][Set ID][][Data][Cr]

- [Command 1] : First command to control set. (j, k, m or x)
- [Command 2] : Second command to control set.
- [Set ID] : You can adjust the set ID to choose desired set ID number in special menu. Adjustment range is 1 ~ 99. When selecting Set ID '0', every connected set is controlled. Set ID is indicated as decimal (1~99) on menu and as Hexa decimal (0x0~0x63) on transmission/receiving protocol.
- * [DATA] : To transmit command data. Transmit 'FF' data to read status of command.
- * [Cr] : Carriage Return
ASCII code '0x0D'
- * [] : ASCII code 'space (0x20)'

OK Acknowledgement

[Command2][][Set ID][][OK][Data][x]

The set transmits ACK (acknowledgement) based on this format when receiving normal data. At this time, if the data is data read mode, it indicates present status data. If the data is data write mode, it returns the data of the PC computer.

Error Acknowledgement

[Command2][][Set ID][][NG][Data][x]

The set transmits ACK (acknowledgement) based on this format when receiving abnormal data from non-viable functions or communication errors.

- Data1: Illegal Code
- Data2: Not supported function
- Data3: Wait more time

APPENDIX

01. Power (Command2:a)

To control Power On/Off of the set.

Transmission [k][a][][Set ID][][Data][Cr]

Data 0 : Power Off Data 1 : Power On

Acknowledgement [a][][Set ID][][OK][Data][x]

To show Power On/Off.

Transmission [k][a][][Set ID][][FF][Cr]

Acknowledgement [a][][Set ID][][OK][Data][x]

* In a like manner, if other functions transmit 'FF' data based on this format, Acknowledgement data feedback presents status about each function.

02. Input Select (Command 2 : b)

To select input source for the set.

You can also select an input source using the INPUT SELECT button on the set's remote control.

Transmission [k][b][][Set ID][][Data][Cr]

Date 0: TV Date 4: Component2
Date 1: AV1 Date 5: RGB
Date 2: AV2 Date 6: HDMI/DVI
Date 3: Component1

Acknowledgement [b][][Set ID][][OK][Data][x]

03. Aspect Ratio (Command2:c) (Main picture size)

To adjust the screen format. (Main picture format)

You can also adjust the screen format using the ARC (Aspect Ratio Control) button on remote control or in the SCREEN menu.

Transmission [k][c][][Set ID][][Data][Cr]

Date 1: Normal screen (4:3) Date 6: Original
Date 2: Wide screen (16:9) Date 7: 14:9
Date 3: Horizon (Spectacle) Date 8: Full (option)
Date 4: Zoom

Acknowledgement [c][][Set ID][][OK][Data][x]

* Using the PC input, you select either 16:9 or 4:3 screen aspect ratio.

04. Screen Mute (Command2:d)

To select screen mute on/off.

Transmission [k][d][][Set ID][][Data][Cr]

Data 0 : Screen mute off (Picture on)
Data 1 : Screen mute on (Picture off)

Acknowledgement [d][][Set ID][][OK][Data][x]

05. Volume Mute (Command2:e)

To control volume mute on/off.

You can also adjust mute using the MUTE button on remote control.

Transmission [k][e][][Set ID][][Data][Cr]

Data 0 : Volume mute on (Volume off)
Data 1 : Volume mute off (Volume on)

Acknowledgement [e][][Set ID][][OK][Data][x]

06. Volume Control (Command2:f)

To adjust volume.

You can also adjust volume with the volume buttons on remote control.

Transmission [k][f][][Set ID][][Data][Cr]

Data Min : 0 ~ Max : 64

Refer to 'Real data mapping 1'. See page 86.

Acknowledgement [f][][Set ID][][OK][Data][x]

07. Contrast (Command2:g)

To adjust screen contrast.

You can also adjust contrast in the PICTURE menu.

Transmission [k][g][][Set ID][][Data][Cr]

Data Min : 0 ~ Max : 64

Refer to 'Real data mapping 1'. See page 86.

Acknowledgement [g][][Set ID][][OK][Data][x]

08. Brightness (Command2:h)

To adjust screen brightness.

You can also adjust brightness in the PICTURE menu.

Transmission [k][h][][Set ID][][Data][Cr]

Data Min : 0 ~ Max : 64

Refer to 'Real data mapping 1'. See page 86.

Acknowledgement [h][][Set ID][][OK][Data][x]

09. Colour (Command2:i)

To adjust the screen colour.

You can also adjust colour in the PICTURE menu.

Transmission [k][i][][Set ID][][Data][Cr]

Data Min : 0 ~ Max : 64

Refer to 'Real data mapping 1'. See page 86.

Acknowledgement [i][][Set ID][][OK][Data][x]

10. Tint (Command2:j) (option)

To adjust the screen tint.

You can also adjust tint in the PICTURE menu.

Transmission [k][j][][Set ID][][Data][Cr]

Data Min : 0 ~ Max : 64

Refer to 'Real data mapping 1'. See page 86.

Acknowledgement [j][][Set ID][][OK][Data][x]

11. Sharpness (Command2:k)

To adjust the screen sharpness.

You can also adjust sharpness in the PICTURE menu.

Transmission [k][k][][Set ID][][Data][Cr]

Data Min : 0 ~ Max : 64

Refer to 'Real data mapping 1'. See page 86.

Acknowledgement [k][][Set ID][][OK][Data][x]

12. OSD Select (Command2:l)

To select OSD (On Screen Display) on/off when controlling remotely.

Transmission [k][l][][Set ID][][Data][Cr]

Data 0: OSD off

Data 1: OSD on

Acknowledgement [l][][Set ID][][OK][Data][x]

13. Remote Control Lock Mode (Command2:m)

To lock the remote control and the front panel controls on the set.

Transmission [k][m][][Set ID][][Data][Cr]

Data 0: Lock off Data 1: Lock on

Acknowledgement [m][][Set ID][][OK][Data][x]

If you're not using the remote control and front panel controls on the set, use this mode. When main power is on/off, remote control lock is released.

14. PIP / DW (Command2:n)

To control the PIP (Picture In picture)/DW.

You can also control the PIP/DW using the PIP button on the remote control or in the PIP/DW menu.

Transmission [k][n][][Set ID][][Data][Cr]

Data 0: PIP/DW off Data 1: PIP

Data 2: DW1 Data 3: DW2

Data 5: POP

Acknowledgement [n][][Set ID][][OK][Data][x]

15. PIP Position (Command2:q)

To select sub picture position for PIP.

You can also adjust the sub picture position using POSITION button on the remote control or in the PIP/DW menu.

Transmission [k][q][][Set ID][][Data][Cr]

Data 0: Right down on screen

Data 1: Left down on screen

Data 2: Left up on screen

Data 3: Right up on screen

Acknowledgement [q][][Set ID][][OK][Data][x]

16. Treble (Command 2 :r)

To adjust treble.

You can also adjust treble in the SOUND menu.

Transmission [k][r][][Set ID][][Data][Cr]

Data Min: 0 ~ Max: 64

Refer to 'Real data mapping 1'. See page 86.

Acknowledgement [r][][Set ID][][OK][Data][x]

17. Bass (Command 2 : s)

To adjust bass.

You can also adjust bass in the SOUND menu.

Transmission [k][s][][Set ID][][Data][Cr]

Data Min: 0 ~ Max: 64

Refer to 'Real data mapping 1'. See page 86.

Acknowledgement [s][][Set ID][][OK][Data][x]

18. Balance (Command2:t)

To adjust balance.

You can also adjust balance in the SOUND menu.

Transmission [k][t][][Set ID][][Data][Cr]

Data Min: 0 ~ Max: 64

Refer to 'Real data mapping 1'. See page 86.

Acknowledgement [t][][Set ID][][OK][Data][x]

19. Colour Temperature (Command2:u)

To adjust colour temperature.

You can also adjust CSM in the PICTURE menu.

Transmission [k][u][][Set ID][][Data][Cr]

Data 0: Cool 1: Normal 2: Warm 3: User

Acknowledgement [u][][Set ID][][OK][Data][x]

20. Red Adjustment (Command2:v)

To adjust red in colour temperature.

Transmission [k][v][][Set ID][][Data][Cr]

Data Min: 0 ~ Max: 50

Refer to 'Real data mapping 2'. See page 86.

Acknowledgement [v][][Set ID][][OK][Data][x]

21. Green Adjustment (Command2:w)

To adjust green in colour temperature.

Transmission [k][w][][Set ID][][Data][Cr]

Data Min: 0 ~ Max: 50

Refer to 'Real data mapping 2'. See page 86.

Acknowledgement [w][][Set ID][][OK][Data][x]

22. Blue Adjustment (Command2:\$)

To adjust blue in colour temperature.

Transmission [k][\$][][Set ID][][Data][Cr]

Data Min: 0 ~ Max: 50

Refer to 'Real data mapping 2'. See page 86.

Acknowledgement [\$][][Set ID][][OK][Data][x]

23. PIP Input Select (Command 2 : y)

To select input source for sub picture in PIP/DW picture mode. You can also adjust input source for sub picture using PIP INPUT button on remote control.

Transmission [k][y][][Set ID][][Data][Cr]

Date 0: TV Date 1: AV1

Date 2: AV2 Date 3: Component 1

Date 4: Component 2 Date 5: RGB

Date 6: HDMI/DVI

Acknowledgement [y][][Set ID][][OK][Data][x]

24. Abnormal State (Command2:z)

To recognize an abnormal state.

This feature is not available for all models.

Transmission [k][z][][Set ID][][Data][][Cr]

Data FF: Read

Acknowledgement [z][][Set ID][][OK][Data][x]

Data 0: Normal (Power on and signal exist)

Data 1: No signal (Power on)

Data 2: Turn the set off by remote control

Data 3: Turn the set off by sleep time function

Data 4: Turn the set off by RS-232C function

Data 5: 5V down

Data 6: AC down

Data 7: Turn the set off by Fan Alarm function (option)

Data 8: Turn the set off by Off time function

Data 9: Turn the set off by Auto sleep function

* This function is "read only".

25. ISM Method (Command1:j, Command2:p) (option)

To control the ISM method. You can also adjust ISM Method in SPECIAL menu.

This feature is not available for all models.

Transmission [j][p][][Set ID][][Data][Cr]

Data 0: Normal

Data 1: White Wash

Data2: Orbiter

Data3: Inversion

Acknowledgement [p][][Set ID][][OK][Data][x]

26. Low power (Command1:j, Command2:q) (option)

To reduce the power consumption of the monitor. You can also adjust Low power in SPECIAL menu.

This feature is not available for all models.

Transmission [j][q][][Set ID][][Data][][Cr]

Data 0: Off

Data 1: On

Acknowledgement [q][][Set ID][][OK][Data][x]

27. Orbiter Time Setting (Command1:j, Command2:r) (option)

To adjust orbiter operation time term.

This feature is not available for all models.

Transmission [j][r][][Set ID][][Data][][Cr]

Data Min: 1 ~ Max: FE

Refer to 'Real data mapping 1'.

Acknowledgement [r][][Set ID][][OK][Data][x]

28. Orbiter Pixel Setting (Command1:j, Command2:s) (option)

To adjust pixel number in orbiter function.

This feature is not available for all models.

Transmission [j][s][][Set ID][][Data][Cr]

Data Min: 1 ~ Max: 3

Refer to 'Real data mapping 1'.

Acknowledgement [s][][Set ID][][OK][Data][x]

29. Picture Size Setting for Twin Picture Mode (Command 1 : j, Command 2 : t) (option)

To adjust pixel number in orbiter function.

This feature is not available for all models.

Transmission [j][t][][Set ID][][Data][Cr]

Data Min: 0 ~ Max: 20

Refer to 'Real data mapping 1'.

Acknowledgement [t][][Set ID][][OK][Data][x]

30. Auto Configure (Command1:j, Command2:u) (option)

To adjust picture position and minimize image shaking automatically. It works only in RGB (PC) mode.

Transmission [j][u][][Set ID][][Data][Cr]

Data 1: To set

Acknowledgement [u][][Set ID][][OK][Data][x]

31. Programme selection (Command1:m, Command2:a)

To select a programme for the main picture.

Transmission [m][a][][Set ID][][Data0][][Data1][][Data2][Cr]

Data 0: Min: 0 ~ Max: 63 (0 ~ C7, 200Pr is on)

Refer to 'Real data mapping 1'.

Data 1: Don't care

Data 2: 0 : Main

1 : Sub

Acknowledgement [a][][Set ID][][OK][Data0][x]

* Real data mapping 1

0 : Step 0
 ⋮
 A : Step 10 (Set ID 10)
 ⋮
 F : Step 15 (Set ID 15)
 10 : Step 16 (Set ID 16)
 ⋮
 64 : Step 100
 ⋮
 6E : Step 110
 ⋮
 73 : Step 115
 74 : Step 116
 ⋮
 C7 : Step 199
 FE : Step 254
 FF : Step 255

* Real data mapping 2

0 : -40
 1 : -39
 2 : -38
 ⋮
 28 : 0
 ⋮
 4E : +38
 4F : +39
 50 : +40

32. Send IR Code (Command1:m, Command2:c)

To send IR remote key code.

Transmission [m][c][][Set ID][][Data][Cr]

Data: Key code - Refer to page 89.

Acknowledgement [c][][Set ID][][OK][Data][x]

**33. Input select (Command1:x, Command2:b)
(Main Picture Input)**

To select input source for set

Transmission [x][b][][Set ID][][Data][Cr]

Data: Structure

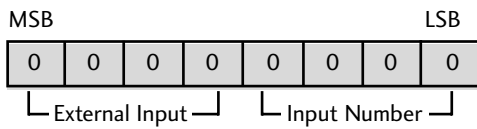

External Input				Data
0	0	0	1	Analog
0	0	1	0	AV
0	1	0	0	Component
0	1	0	1	RGB-DTV
0	1	1	0	RGB-PC
1	0	0	1	HDMI/DVI

Input Number				Data
0	0	0	0	Input1
0	0	0	1	Input2
0	0	1	0	Input3
0	0	1	1	Input4

Acknowledgement [b][][Set ID][][OK][Data][x]

34. Input select (Command1:x, Command2:y)

To adjust input source for sub picture in PIP mode

Transmission [x][y][][Set ID][][Data][Cr]

Data: Structure

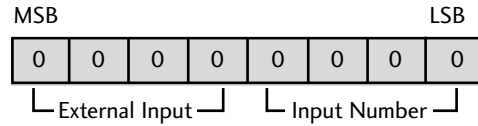

External Input				Data
0	0	0	1	Analog
0	0	1	0	AV
0	1	0	0	Component
0	1	0	1	RGB-DTV
0	1	1	0	RGB-PC
1	0	0	1	HDMI/DVI

Input Number				Data
0	0	0	0	Input1
0	0	0	1	Input2
0	0	1	0	Input3
0	0	1	1	Input4

Acknowledgement [y][][Set ID][][OK][Data][x]

APPENDIX

IR CODES

1. How to Connect

- Connect your wired remote control to the Remote Control port on the set.

2. Remote Control IR Codes (NEC Format)

■ Output waveform

Single pulse, modulated with 37.917KHz signal at 455KHz

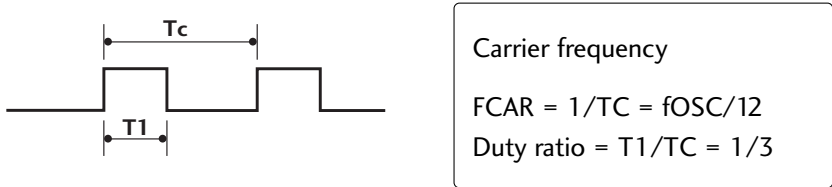

■ Configuration of frame

1st frame

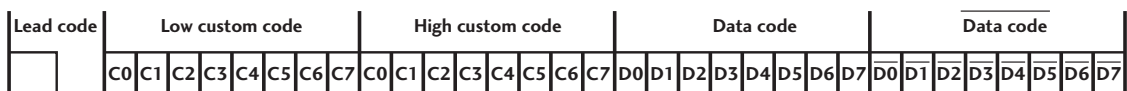

Repeat frame

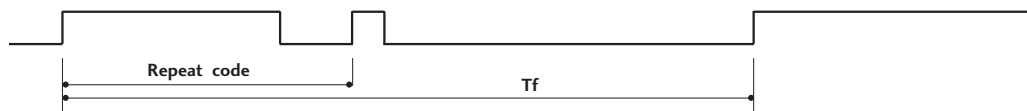

■ Lead code



■ Repeat code

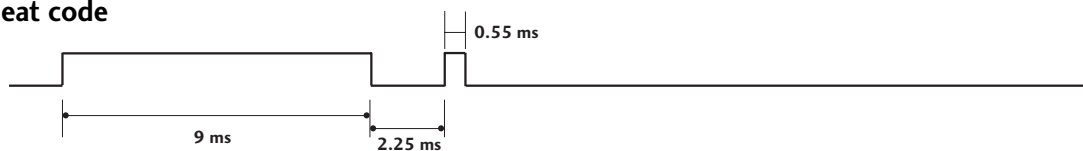

■ Bit description

Bit "0"

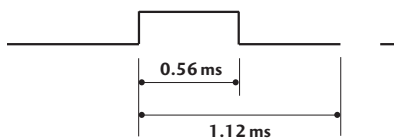

Bit "1"

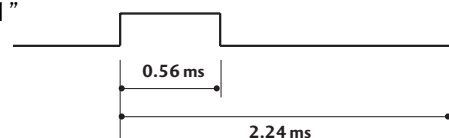

■ Frame interval: Tf

The waveform is transmitted as long as a key is depressed.

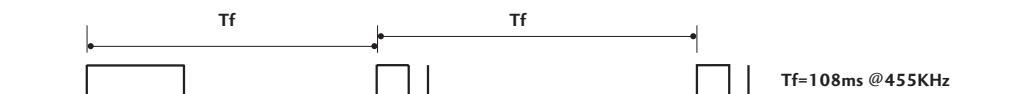

REMOTE CONTROL IR CODES

Code (Hexa)	Function	Note	Code (Hexa)	Function	Note
00	PR ▲	R/C Button	1A	Q.VIEW	R/C Button
01	PR ▼	R/C Button	0A	I/II	R/C Button
02	VOL ▲	R/C Button	0E	SLEEP	R/C Button
03	VOL ▼	R/C Button	43	MENU	R/C Button
40	▲	R/C Button	44	OK(⊙)	R/C Button
41	▼	R/C Button	4D	PSM	R/C Button
06	▶	R/C Button	52	SSM	R/C Button
07	◀	R/C Button	53	LIST	R/C Button
08	POWER	R/C Button (Power On/Off)	20	TEXT	R/C Button
C4	POWER ON	Discrete IR Code (Only Power On)	2A	REVEAL	R/C Button
C5	POWER OFF	Discrete IR Code (Only Power Off)	22	MODE	R/C Button
09	MUTE	R/C Button	24	MIX	R/C Button
10	Number Key 0	R/C Button	26	TIME	R/C Button
11	Number Key 1	R/C Button	62	UPDATE / POSITION	R/C Button
12	Number Key 2	R/C Button	64	SIZE	R/C Button
13	Number Key 3	R/C Button	65	HOLD	R/C Button
14	Number Key 4	R/C Button	70	INDEX	R/C Button
15	Number Key 5	R/C Button	60	PIP	R/C Button
16	Number Key 6	R/C Button	61	PIP INPUT	R/C Button
17	Number Key 7	R/C Button	63	SWAP	R/C Button
18	Number Key 8	R/C Button	71	PIP PR+	R/C Button
19	Number Key 9	R/C Button	72	PIP PR-	R/C Button
0B	INPUT	R/C Button	79	ARC	R/C Button
98	MULTIMEDIA	R/C Button	76	ARC (4:3)	Discrete IR Code (Only 4:3 mode)
BF	COMPONENT	Discrete IR Code (Input COMPONENT Selection)	77	ARC (16:9)	Discrete IR Code (Only 16:9 mode)
C6	HDMI	Discrete IR Code (Input HDMI Selection)	AF	ARC (Zoom)	Discrete IR Code (Only Zoom mode)
D5	RGB	Discrete IR Code (Input RGB Selection)	B5	MARK	R/C Button
D6	TV	Discrete IR Code (Input TV Selection)	B0	PLAY	R/C Button
5A	AV1	Discrete IR Code (Input AV1 Selection)	B1	STOP	R/C Button
D0	AV2	Discrete IR Code (Input AV2 Selection)	BA	PAUSE	R/C Button
1E	FAV (Favorite)	R/C Button			

PROGRAMMING THE REMOTE

The remote is a multi-brand or a universal remote. It can be programmed to operate most remote-control-able devices of other manufacturers.

Note that the remote may not control all models of other brands.

Programming a code into a remote mode

- 1** To find out whether your remote can operate the device without programming, turn on the device such as a VCR and press the corresponding mode button on the remote. After that, press the POWER button. If the device is turned off then it responds properly and the remote need not to be programmed. If not, the remote should be programmed to operate the device. The programming procedures are explained below.
- 2** Press the MENU and MUTE button continuously at the same time for 2 seconds, the current selected device button will be illuminated. If you don't press any button for 20 seconds, the light on the mode button will be turned off. In that case, you have to repeat from step 2.
- 3** Enter code numbers using the number button on the remote by referring the code table on the following pages. When pressing the button, the light blinks at a time. If the device turned off, the programming is successful.
- 4** Press the MENU button to store the code. After blinking twice, this code is stored.
- 5** Test the remote functions to see if the device responds properly. If not, repeat from step 2.

PROGRAMMING CODES

VCRs

Brand	Codes	Brand	Codes	Brand	Codes
AIWA	034	MAGNAVOX	031 033 034 041	SAMSUNG	032 040 102 104
AKAI	016 043 046 124		067 068		105 107 109 112
	125 146	MARANTZ	012 031 033 067		113 115 120 122
AMPRO	072		069		125
ANAM	031 033 103	MARTA	101	SANSUI	022 043 048 135
AUDIO DYNAMICS	012 023 039 043	MATSUI	027 030	SANYO	003 007 010 014
BROKSONIC	035 037 129	MEI	031 033		102 134
CANON	028 031 033	MEMOREX	003 010 014 031	SCOTT	017 037 112 129
CAPEHART	108		033 034 053 072		131
CRAIG	003 040 135		101 102 134 139	SEARS	003 008 009 010
CURTIS MATHES	031 033 041	MGA	045 046 059		013 014 017 020
DAEWOO	005 007 010 064	MINOLTA	013 020		031 042 073 081
	065 108 110 111	MITSUBISHI	013 020 045 046		101
	112 116 117 119		049 051 059 061	SHARP	031 054 149
DAYTRON	108		151	SHINTOM	024
DBX	012 023 039 043	MTC	034 040	SONY	003 009 031 052
DYNATECH	034 053	MULTITECH	024 034		056 057 058 076
ELECTROHOME	059	NEC	012 023 039 043		077 078 149
EMERSON	006 017 025 027		048	SOUNDESIGN	034
	029 031 034 035	NORDMENDE	043	STS	013
	036 037 046 101	OPTONICA	053 054	SYLVANIA	031 033 034 059
	129 131 138 153	PANASONIC	066 070 074 083		067
FISHER	003 008 009 010		133 140 145	SYMPHONIC	034
FUNAI	034			TANDY	010 034
GE	031 033 063 072	PENTAX	013 020 031 033	TATUNG	039 043
	107 109 144 147		063	TEAC	034 039 043
GO VIDEO	132 136	PHILCO	031 034 067	TECHNICS	031 033 070
HARMAN KARDON	012 045	PHILIPS	031 033 034 054	TEKNIKA	019 031 033 034
HITACHI	004 018 026 034		067 071 101		101
	043 063 137 150	PILOT	101	THOMAS	034
INSTANTREPLAY	031 033	PIONEER	013 021 048	TMK	006
JCL	031 033	PORTLAND	108	TOSHIBA	008 013 042 047
JCPENNY	012 013 015 033	PULSAR	072		059 082 112 131
	040 066 101	QUARTZ	011 014	TOTEVISION	040 101
JENSEN	043	QUASAR	033 066 075 145	UNITECH	040
JVC	012 031 033 043	RCA	013 020 033 034	VECTOR RESEARCH	012
	048 050 055 060		040 041 062 063	VICTOR	048
	130 150 152		107 109 140 144	VIDEO CONCEPTS	012 034 046
KENWOOD	014 034 039 043		145 147	VIDEOSONIC	040
	047 048	REALISTIC	003 008 010 014	WARDS	003 013 017 024
LG (GOLDSTAR)	001 012 013 020		031 033 034 040		031 033 034 040
	101 106 114 123		053 054 101		053 054 131
LLOYD	034	RICO	058	YAMAHA	012 034 039 043
LXI	003 009 013 014	RUNCO	148	ZENITH	034 048 056
	017 034 101 106	SALORA	014		058 072 080 101
MAGIN	040				

APPENDIX

PROGRAMMING CODES

CATV

Brand	Codes	Brand	Codes	Brand	Codes
ABC	003 004 039 042 046 052 053	LG (GOLDSTAR)	001 106 101 005	SHERITECH	022
AJIN	112	M-NET	037	SIGNAL	030
ANTRONIK	014	MACOM	033	SIGNATURE	052
ARCHER	005 007 014 024	MAGNAVOX	010 012 064 079	SL MARX	030
CABLE STAR	026	MEMOREX	100	SPRUCER	047 078
CENTURION	092	MOVIE TIME	028 032	STARCOM	002 004 008 009
CENTURY	007	NSC	015 028 038 071 073	STARGATE	008 030
CITIZEN	007	OAK	016 031 037 053	TADIRAN	030
COLOUR VOICE	065 090	PANASONIC	044 047	TAEKWANG	110
COMBANO	080 081	PARAGON	100	TAIHAN	105
COMTRONICS	019 030	PHILIPS	006 012 013 020 065 085 090	TANDY	017
DIAMOND	023	PIONEER	034 051 052 063 076	TEXSCAN	029
EAGLE	020 030 040	POST NEWS WEEK	016	TOCOM	039 040 056
EASTERN	057 062 066	PRUCER	059	TOSHIBA	100
ELECTRICORD	032	PTS	011 048 071 072 073 074	UNIKA	007 014 024
GE	072	PULSAR	100	UNITED CABLE	004 053
GEMINI	008 022 025 054	RCA	047	UNIVERSAL	005 007 014 024 026 027 032 035
GI	052 074	REGAL	049 050	VIEWSTAR	012 015 018 086 087 088 089
GOLDEN CHANNEL	030	REGENCY	057	ZENITH	100 114 060 093
HAMLIN	049 050 055	REMBRANT	025		
HITACHI	052 055	SAMSUNG	102 107 030 068		
HOSPITALITY	070 077	SCIENTIFIC ATLANTA	003 011 041 042 043 045 046		
JERROLD	002 003 004 008 009 010 052 069 074				

HDSTB

Brand	Codes	Brand	Codes	Brand	Codes
ALPHASTAR DSR	123	HOUSTON TRACKER	033 037 039 051	PROSAT	072
AMPLICA	050		057 104	RCA	066 106
BIRDVIEW	051 126 129	HUGHES	068	REALISTIC	043 074
CHANNEL MASTER	013 014 015 018 036 055	JANIEL	060 147	SAMSUNG	123
CHAPARRAL	008 009 012 077	JERROLD	061	SATELLITE SERVICE CO	028 035 047 057 085
CITOH	054	KATHREIN	108	SCIENTIFIC ATLANTA	032 138
CURTIS MATHES	050 145	LEGEND	057	SONY	103
DRAKE	005 006 007 010 011 052 112 116 141	LG	001	STARCAST	041
DX ANTENNA	024 046 056 076	LUTRON	132	SUPER GUIDE	020 124 125
ECHOSTAR	038 040 057 058 093 094 095 096 097 098 099 100 122	LUXOR	062 144	TEECOM	023 026 075 087 088 090 107 130 137
ELECTRO HOME	089	MACOM	010 059 063 064 065	TOSHIBA	002 127
EUROPLUS	114	MEMOREX	057	UNIDEN	016 025 042 043 044 045 048 049 078 079 080 086 101 135 136
FUJITSU	017 021 022 027 133 134	NEXTWAVE	028 124 125	VIEWSTAR	115
GENERAL INSTRUMENT	003 004 016 029 031 059 101	NORSAT	069 070	WINEGARD	128 146
HITACHI	139 140	PACE SKY SATELLITE	143	ZENITH	081 082 083 084 091 120
		PANASONIC	060 142		
		PANSAT	121		
		PERSONAL CABLE	117		
		PHILIPS	071		
		PICO	105		
		PRESIDENT	019 102		
		PRIMESTAR	030 110 111		

DVD

Brand	Codes	Brand	Codes	Brand	Codes
APEX DIGITAL	022	mitsubishi	002	RCA	005 006
DENON	020 014	NAD	023	SAMSUNG	011 015
GE	005 006	ONKYO	008 017	SONY	007
HARMAN KARDON	027	PANASONIC	003 009	THOMPSON	005 006
JVC	012	PHILIPS	013	TOSHIBA	019 008
LG	001 010 016 025	PIONEER	004 026	YAMAHA	009 018
MAGNAVOX	013	PROCEED	021	ZENITH	010 016 025
MARANTZ	024	PROSCAN	005 006		

APPENDIX

PROGRAMMING CODES

Audio

Brand	Codes	Brand	Codes	Brand	Codes
AIWA	014 028 070 096 125 129 139 229 230	NAD	045 046	SANYO	019 083 234
AKAI	163	LOTTE	014 016 036 098 100 172 173 174 175 176 177 178 179 180 181 183 201 202 208 213 214 219 223 232 238 240	SCOTT	106 186
ANAM	003 014 017 023 059 106 189 216 217 235 236	LXI	103	SHARP	031 032 051 052 072 082 117 119 156 184 199 200 206 209
BURMECTER	252	MAGNAVOX	111	SHERWOOD	005 006 158
CARVER	086	MARANTZ	002 018 020 025 034 041 081 090 097 112	SONY	044 045 109 114 118 126 248 249
CLARION	199	MCINTOSH	049	TAEKWANG	012 020 073 074 076 077 105 161 162 163 164 165 166 167 168 169 205 231 233 242
DAEWOO	027 053 060 084 102 148 198 221	MCS	104	TEAC	010 085 106 136 185 187 237
DENON	015 075 130 143	MEMOREX	107	TECHNICS	101 113 128 134 147 218
FANTASIA	071	NAD	046	TOSHIBA	137
FINEARTS	022	ONKYO	013 040 041 047 048 056 057 132 133 140	THE	061
FISHER	089 099	OPTIMUS	158	VICTOR	088 131
LG(GOLDSTAR)	001 021 024 029 087 107 108 110 190 191 192 210 211 212 239	PANASONIC	007 033 064 113 142 220 241 251	WARDS	089
HAITAI	034 035 188 222	PENNEY	104	YAMAHA	054 055 066 092 199
HARMAN/KARDON	068	PHILIPS	026 112 143		
INKEL	037 058 062 069 078 079 095 121 122 149 150 151 152 153 154 155 157 158 159 160 189 207 222 224 225 226 227 243 247	PIONEER	039 042 043 063 065 091 093 094 115 123 127 250		
JVC	004 013 141	QUASAR	113		
KEC	185 186 187	RCA	080		
KENWOOD	038 050 067 089 170 171 197 206 215 222	RCX	092		
KOHEL	030	REALISTIC	103 106		
		SAMSUNG	124 145 146 182 193 194 195 203 204 244 245 246		
		SANSUI	011 135 138 144		

TROUBLESHOOTING CHECKLIST

The operation does not work normally.	
The remote control doesn't work	<ul style="list-style-type: none"> ■ Check to see if there is any object between the set and the remote control causing obstruction. ■ Are batteries installed with correct polarity (+ to +, - to -)? ■ Correct remote operating mode set: TV, VCR etc.? ■ Install new batteries.
Power is suddenly turned off	<ul style="list-style-type: none"> ■ Is the sleep timer set? ■ Check the power control settings. Power interrupted. ■ No broadcast on station tuned with Auto off activated.

The operation does not work normally.	
No picture & No sound	<ul style="list-style-type: none"> ■ Check whether the set is turned on. ■ Try another programme. The problem may be with the broadcast. ■ Is the power cord inserted into wall power outlet? ■ Check your antenna direction and/or location. ■ Test the wall power outlet, plug another set's power cord into the outlet where the set's power cord was plugged in.
Picture appears slowly after switching on	<ul style="list-style-type: none"> ■ This is normal, the image is muted during the set startup process. Please contact your service center, if the picture has not appeared after five minutes.
No or poor colour or poor picture	<ul style="list-style-type: none"> ■ Adjust Colour in menu option. ■ Keep a sufficient distance between the set and the VCR. ■ Try another programme. The problem may be with the broadcast. ■ Are the video cables installed properly? ■ Activate any function to restore the brightness of the picture.
Horizontal/vertical bars or picture shaking	<ul style="list-style-type: none"> ■ Check for local interference such as an electrical appliance or power tool.
Poor reception on some channels	<ul style="list-style-type: none"> ■ Station or cable set experiencing problems, tune to another station. ■ Station signal is weak, reorient antenna to receive weaker station. ■ Check for sources of possible interference.
Lines or streaks in pictures	<ul style="list-style-type: none"> ■ Check antenna (Change the direction of the antenna).

APPENDIX

TROUBLESHOOTING CHECKLIST

The audio function does not work.	
Picture OK & No sound	<ul style="list-style-type: none">■ Press the VOL ▲ / ▼ button.■ Sound muted? Press MUTE button.■ Try another programme. The problem may be with the broadcast.■ Are the audio cables installed properly?
No output from one of the speakers	<ul style="list-style-type: none">■ Adjust Balance in menu option.
Unusual sound from inside the set	<ul style="list-style-type: none">■ A change in ambient humidity or temperature may result in an unusual noise when the set is turned on or off and does not indicate a fault with the set.

There is a problem in PC mode. (Only PC mode applied)	
The signal is out of range	<ul style="list-style-type: none">■ Adjust resolution, horizontal frequency, or vertical frequency.■ Check the input source.
Vertical bar or stripe on background & Horizontal Noise & Incorrect position	<ul style="list-style-type: none">■ Work the Auto configure or adjust clock, phase, or H/V position. (Option)
Screen colour is unstable or single colour	<ul style="list-style-type: none">■ Check the signal cable.■ Reinstall the PC video card.

MAINTENANCE

Early malfunctions can be prevented. Careful and regular cleaning can extend the amount of time you will have your new set. Be sure to turn the power off and unplug the power cord before you begin any cleaning.

Cleaning the Screen

- 1 Here's a great way to keep the dust off your screen for a while. Wet a soft cloth in a mixture of lukewarm water and a little fabric softener or dish washing detergent. Wring the cloth until it's almost dry, and then use it to wipe the screen.
- 2 Make sure the excess water is off the screen, and then let it air-dry before you turn on your set.

Cleaning the Cabinet

- To remove dirt or dust, wipe the cabinet with a soft, dry and lint-free cloth.
- Please be sure not to use a wet cloth.

Extended Absence

CAUTION

- ▶ If you expect to leave your set dormant for a long time (such as a vacation), it's a good idea to unplug the power cord to protect against possible damage from lightning or power surges.

APPENDIX

PRODUCT SPECIFICATIONS

MODELS		42PC1RR*	50PB2RR*
		42PC1RR-TL	50PB2RR-TL
Dimensions (Width x Height x Depth)	with stand	1129.0 x 748.5 x 380.0 mm 44.5 x 29.5 x 15.0 inches	1382 x 913 x 377 mm 54.4 x 36.0 x 14.9 inches
	without stand	1129.0 x 695.0 x 108.9 mm 44.5 x 27.4 x 4.3 inches	1382 x 848.5 x 125 mm 54.4 x 33.4 x 4.9 inches
Weight	including stand	29.1 kg/64.2 lbs	62.2 kg/137.1 lbs
	excluding stand	25.6kg/56.5 lbs	49.2 kg/108.5 lbs
Power requirement Power consumption Television System External Antenna Impedance		AC100-240V~ 50/60Hz 310 W 450W PAL/SECAM B/G/D/K, PAL I/II, SECAM L/L' 75 Ω	
Environment condition	Operating Temperature Operating Humidity	0 ~ 40°C / 32 ~ 104°F Less than 80%	
	Storage Temperature Storage Humidity	-20 ~ 60°C / -4 ~ 140°F Less than 85%	

■ The specifications shown above may be changed without prior notice for quality improvement.

PRODUCT SPECIFICATIONS

MODELS		37LC2RR*	42LC2RR*
		37LC2RR-TL	42LC2RR-TL
Dimensions (Width x Height x Depth)	with stand	944.0 x 729 x 286 mm 37.1 x 28.7 x 11.2 inches	1054 x 813 x 286 mm 41.4 x 32 x 11.2 inches
	without stand	944.0 x 659.3 x 129.7 mm 37.1 x 26 x 5.1 inches	1054 x 746 x 136.8mm 41.4 x 29.3 x 5.3 inches
Weight	including stand	30.4 kg/67.0 lbs	42.3kg/93.2 lbs
	excluding stand	25.9 kg /57.1 lbs	35.7kg/78.7 lbs
Power requirement		AC100-240V~ 50/60Hz	
Power consumption		200W	250W
Television System		PAL/SECAM B/G/D/K, PAL I/II, SECAM L/L'	
External Antenna Impedance		75 Ω	
Environment condition	Operating Temperature	0 ~ 40°C / 32 ~ 104°F	
	Operating Humidity	Less than 80%	
	Storage Temperature	-20 ~ 60°C / -4 ~ 140°F	
	Storage Humidity	Less than 85%	

■ The specifications shown above may be changed without prior notice for quality improvement.

LG Electronics Inc.