

W2_XA12_BESPLK_ENG_MFL39672005



MODEL : XA12

ENGLISH

There is so much your Hi-Fi system can do



Play CDs

Go to page 6



Lull me to sleep
and wake me up

Go to page 7

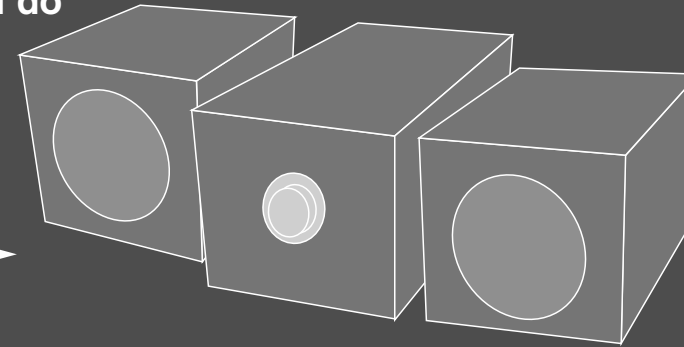

Play from many
external devices

Go to page 7

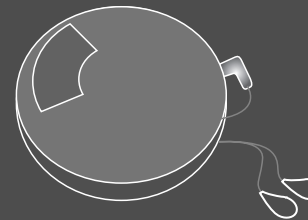

Portable CD player

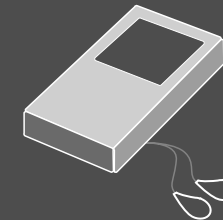

MP3 player

Contents

Setting up	3
About Player	4
About Remote control	5
Listening to the radio	6
Listening to CDs	6
Listening to music from your portable player	7
About MP3/WMA	7
Setting the Clock	7
Use your player as an alarm clock	7
Safety Precaution	8
Troubleshooting	9
Specifications	9

Before connecting, operating or adjusting this product, please read this instruction booklet carefully and completely.

Setting up

1 Connect the speaker cables to the player

Cables from the left-hand speaker connect to the terminal marked L (left) + (plus) and - (minus). Cables from the right-hand speaker are connected to the terminal marked R (right) + (plus) and - (minus). To connect the cable to the player, press each of the four square plastic finger pads on the rear of the player. The connector will open ready to receive a cable.

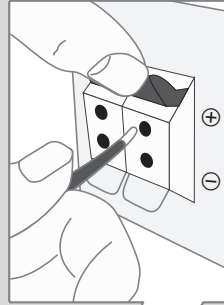

Put the batteries in the remote control

Make sure that the + (plus) and - (minus) on the batteries (size AAA) match those on the remote control.

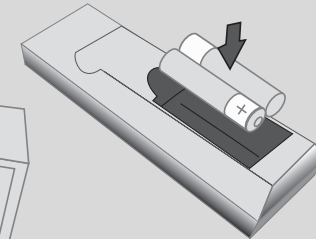

2 Fit the AM loop aerial to its stand - OPTIONAL

Connect the AM loop aerial to the player.

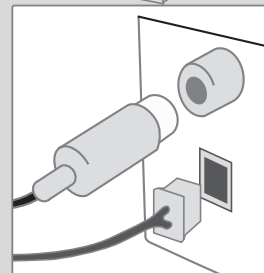
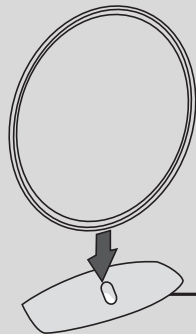

3 Connect the FM aerial

The reception will be at its best when the two loose ends of the aerial are in a straight line and horizontal.

4 Plug the power plug into a wall socket

About Player

MO./ST.

This will change the tuner from stereo to mono and usually improve the reception.

SET

SET confirms the time you have selected when setting the clock. (see Setting the clock)

FUNC.

Change the functions between FM, AM (OPTIONAL), CD, PORTABLE etc.

⏻ (POWER)

You can set up the unit into an economic power save mode. In the power-on status, press and hold ⏻ (POWER) for about 3 seconds. To cancel power save mode, press ⏻ (POWER).

PORTABLE IN

For connecting a portable device and playing it through the system's speakers.

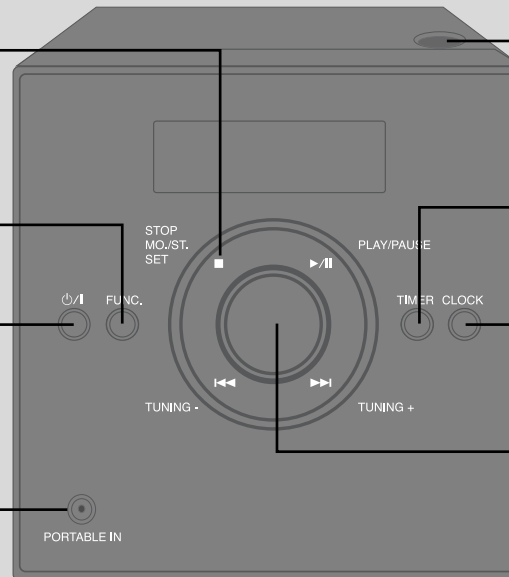

CD door

You can use it when inserting or removing CDs. Don't open the door while CD plays back.

TIMER

With the TIMER function you can turn CD play and radio reception on or off at a desired time.

CLOCK

For setting the clock and checking the time.

VOLUME

Control the volume when using any function.

About Remote control

Search for a folder of MP3/WMA files

When a CD containing MP3/WMA files in several folders is being played, press **PRESET/FOLDER** to select the folder you want to play.

Choose a 'preset number' for a radio station (see Listening to the radio)

Fall asleep while listening to your player

Firstly, start a radio station or music. Press **SLEEP** on the remote one or more times to select delay time between 10 and 180 minutes, after the player will turn off.

Listen to your tracks again and again

Press **REPEAT** once to repeat the track currently playing. Press **REPEAT** twice to repeat the whole CD, or if you're listening to the whole folder of MP3/WMA CD. The display will show what is being repeated.

Sound quality adjustment

You can choose between 4 fixed sound impressions. Select a desired sound mode by using **EQ**.
(NORMAL → ROCK → POP → CLASSIC)

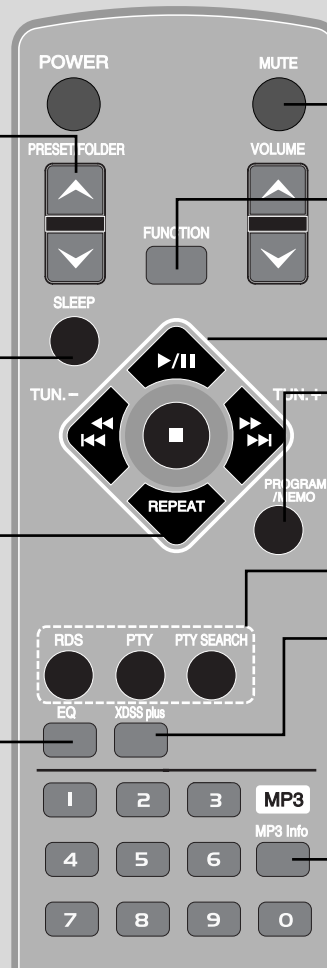

Temporarily stop the sound
Press the button again to return to the sound.

To change the functions
Change the functions between FM, AM (OPTIONAL), CD or PORTABLE.

Use when playing a CD

For storing radio stations
If you have saved radio stations using **PROGRAM/MEMO**, you can scroll through them and select one. (see Listening to the radio)
Listen to your tracks in any order
(see Listening to the CDs)

Search radio stations by radio type
- **OPTIONAL** (See Listening to radio)

eXtreme Dynamic Sound System
Reinforce the treble, bass and surround sound effect. XDSS will show in the display.
Press again for **NORMAL**.

MP3 - OPT
Optimizes compressible MP3 files so that it improves the bass sound.
(XDSS → MP3-OPT → NORMAL)

See information about your music
MP3/WMA files often come with tags. The tag gives the Title, Artist, Album or Time information. Press **MP3 Info** while a file is playing to see this information.

Listening to the radio

	ON PLAYER	ON REMOTE
1. Select the FM (AM - OPTIONAL):	FUNC.	FUNCTION
2. Select the radio station:	TUNING-/TUNING+	TUN.-/TUN.+
3. To 'save' a radio station: A preset number will show in the display.		PROGRAM/MEMO
4. To select a 'saved' station: Up to 50 radio stations can be saved.		PRESET/FOLDER
5. To confirm press:		PROGRAM/MEMO

Listening to the radio - more you can do

See information about your radio stations - OPTIONAL

The FM tuner is supplied with the Radio Data System (RDS) facility. This shows the letters RDS on the display, plus information about the radio station being listened to. Press **RDS** on the remote control several times to view the information.

PTY - Programme Type, such as News, Sport, Jazz Music.

RT - Radio Text, the name of the radio station.

CT - Time Control, the time at the location of the radio station.

PS - Programme Service name, the name of channel.

You can search the radio stations by programme type by pressing **RDS**. The display will show the last PTY in use. Press **PTY** one or more times to select your preferred programme type. Press and hold **PTY SEARCH**. The tuner will search automatically. When a station is found the search will stop.

Look for radio stations automatically

Press **TUNING - /TUNING +** on the front panel (or press **TUN.- / TUN.+** on the remote control for more than 0.5 second. The tuner will scan automatically and stop when it finds a radio station.

Delete all the saved stations

Press and hold **PROGRAMME/MEMO** for two seconds. "CLEAR" shows. Press **PROGRAMME/MEMO** to erase all the saved stations.

Choose a 'preset number' for a radio station

Select a station you want by pressing **TUN.- / TUN.+** on the remote control or **TUNING - /TUNING +** on the front panel. Press **PROGRAM/MEMO**, the station flashes. Press **PRESET/FOLDER** on the remote control to select the preset number you want. Press **PROGRAM/MEMO** to save it.

Listening to CDs

	ON PLAYER	ON REMOTE
1. Open the CD door:	PUSH OPEN	
2. Insert the CD : Label facing up.		
3. Close the CD door: The display will show the total number of tracks (files).	PUSH OPEN	
4. Select the CD function:	FUNC.	FUNCTION
5. Start the CD playing:	▶/ 	▶/
6. To stop a CD playing:	■	■

Listening to CDs - more you can do

Pause or restart a CD

Press **▶/||** during playback. Press this button again to resume play.

Search for a section within a track

Hold **I◀◀/▶▶I** on the front panel or **I◀◀◀◀/▶▶▶▶I** on the remote control. (This function is only available for Audio CD's.)

Skip to another track

Press **I◀◀/▶▶I** on the front panel or **I◀◀◀◀/▶▶▶▶I** on the remote control.

Listen to your tracks in any order

Up to 20 tracks on a CD can be listened to in the order of your choice. Insert a CD and wait for it to be read. Press **PROGRAM/MEMO** on the remote control, then use **I◀◀/▶▶I** to select the track. Press **PROGRAM/MEMO** again to save and select the next track. Press **▶/||**. To clear your selection, press **STOP, PROGRAM/MEMO, STOP**.

Listening to music from your portable player

The player can be used to play the music from many types of portable player.







	ON PLAYER	ON REMOTE
1. Connect the portable player by plugging the unit into PORTABLE IN on the front of the player.		
2. Turn the power on:	 /I	POWER
3. Select the PORTABLE function:	FUNC.	FUNCTION
4. Turn the portable player on and start it playing:		

About MP3/WMA

MP3/WMA Disc compatibility with this unit is limited as follows:







- Sampling Frequency
8 - 48 kHz (MP3), 32 - 48 kHz (WMA)
- Bit rate
8 - 320 kbps (MP3), 48 - 320 kbps (WMA)
- CD-R physical format should be "ISO 9660"
- If you record MP3/WMA files using the software which cannot create a FILE SYSTEM, for example "Direct-CD" etc., it is impossible to playback MP3 files. We recommend that you use "Easy-CD Creator", which creates an ISO 9660 file system.
- File names should be named using 30 letters or less and must incorporate ".mp3", ".wma" extension e.g. "*****.MP3" or "*****.WMA"
- Do not use special letters such as "/ : * ? " < >" etc.
- Even if the total number of files on the disc has more than 1000, it will only be shown up to 999.



Setting the Clock

	ON PLAYER
1. Press for at least 2 seconds:	CLOCK
2. Choose from either: AM 12:00 (for an am and pm display) or 0:00 (for a 24 hour display).	 / 
3. Confirm your selection:	SET
4. Select the hours:	 / 
5. Press:	SET
6. Select the minutes:	 / 
7. Press:	SET

Use your player as an alarm clock

Press and hold **TIMER** for two seconds. Each function, TUNER, CD flashes for two seconds. Press **SET** when the function you want to be woken by is showing.

If you choose **TUNER** you will be shown the stations you have saved as presets. Use  or  to select the station you want, then press **SET**. You will be shown the ON TIME display. This is where you set the time you want the alarm to go off. Use  or  to change the hours and minutes and **SET** to save. You will then be shown the OFF TIME display. This is where you set the time you want the function to stop. Use  or  to change the hours and minutes and press **SET** to save.

Next you will be shown the volume (VOL) you want to be woken by. Use  or  to change the volume and **SET** to save. Switch the system off. The clock icon shows that the alarm is set.

When the system is turned off you can check the time the alarm is set for by pressing **TIMER**. You can also turn the alarm on and off by pressing **TIMER**. To set the alarm to go off at a different time, switch the system on and reprogramme following the same steps above.

Safety Precaution



CAUTION: TO REDUCE THE RISK OF ELECTRIC SHOCK DO NOT REMOVE COVER (OR BACK) NO USER-SERVICEABLE PARTS INSIDE REFER SERVICING TO QUALIFIED SERVICE PERSONNEL.



This lightning flash with arrowhead symbol within an equilateral triangle is intended to alert the user to the presence of uninsulated dangerous voltage within the product's enclosure that may be of sufficient magnitude to constitute a risk of electric shock to persons.



The exclamation point within an equilateral triangle is intended to alert the user to the presence of important operating and maintenance (servicing) instructions in the literature accompanying the product.

WARNING: TO PREVENT FIRE OR ELECTRIC SHOCK HAZARD, DO NOT EXPOSE THIS PRODUCT TO RAIN OR MOISTURE.

WARNING: Do not install this equipment in a confined space such as a book case or similar unit.

CAUTION: Do not block any ventilation openings. Install in accordance with the manufacturer's instructions.

Slots and openings in the cabinet are provided for ventilation and to ensure reliable operation of the product and to protect it from over heating. The openings should be never be blocked by placing the product on a bed, sofa, rug or other similar surface. This product should not be placed in a built-in installation such as a bookcase or rack unless proper ventilation is provided or the manufacturer's instruction has been adhered to.

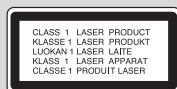

CAUTION:

This product employs a Laser System.

To ensure proper use of this product, please read this owner's manual carefully and retain it for future reference. Should the unit require maintenance, contact an authorized service center. Use of controls, adjustments or the performance of procedures other than those specified herein may result in hazardous radiation exposure.

To prevent direct exposure to laser beam, do not try to open the enclosure. Visible laser radiation when open. DO NOT STARE INTO BEAM.

CAUTION: The apparatus should not be exposed to water (dripping or splashing) and no objects filled with liquids, such as vases, should be placed on the apparatus.

CAUTION concerning the Power Cord

Most appliances recommend they be placed upon a dedicated circuit;

That is, a single outlet circuit which powers only that appliance and has no additional outlets or branch circuits. Check the specification page of this owner's manual to be certain.

Do not overload wall outlets. Overloaded wall outlets, loose or damaged wall outlets, extension cords, frayed power cords, or damaged or cracked wire insulation are dangerous. Any of these conditions could result in electric shock or fire. Periodically examine the cord of your appliance, and if its appearance indicates damage or deterioration, unplug it, discontinue use of the appliance, and have the cord replaced with an exact replacement part by an authorized servicer.

Protect the power cord from physical or mechanical abuse, such as being twisted, kinked, pinched, closed in a door, or walked upon. Pay particular attention to plugs, wall outlets, and the point where the cord exits the appliance.

To disconnect power from the mains, pull out the mains cord plug. When installing the product, ensure that the plug is easily accessible.



Disposal of your old appliance

1. When this crossed-out wheeled bin symbol is attached to a product it means the product is covered by the European Directive 2002/96/EC.
2. All electrical and electronic products should be disposed of separately from the municipal waste stream via designated collection facilities appointed by the government or the local authorities.
3. The correct disposal of your old appliance will help prevent potential negative consequences for the environment and human health.
4. For more detailed information about disposal of your old appliance, please contact your city office, waste disposal service or the shop where you purchased the product.



This product is manufactured to comply with the EEC DIRECTIVE 2004/108/EC and 2006/95/EC.

Troubleshooting

Symptom	Cause	Correction
No power	<ul style="list-style-type: none"> The power cord is disconnected. 	<ul style="list-style-type: none"> Plug the power cord into the wall outlet securely.
No sound	<ul style="list-style-type: none"> The power of the external source equipment is turned off. 	<ul style="list-style-type: none"> Switch on the external source equipment.
	<ul style="list-style-type: none"> The speaker cable is connected to a wrong position. 	<ul style="list-style-type: none"> Set the speaker cable to the correct position, then turn on the unit again by pressing POWER.
The unit does not start playback	<ul style="list-style-type: none"> An unplayable disc is inserted. 	<ul style="list-style-type: none"> Insert a playable disc.
	<ul style="list-style-type: none"> The disc is placed upside down. 	<ul style="list-style-type: none"> Place the disc with the playback side down.
	<ul style="list-style-type: none"> The disc is not placed within the guide. 	<ul style="list-style-type: none"> Place the disc on the disc tray correctly inside the guide.
	<ul style="list-style-type: none"> The disc is dirty. 	<ul style="list-style-type: none"> Clean the disc.
The remote control does not work properly	<ul style="list-style-type: none"> The remote control is not pointed at the remote sensor of the unit. 	<ul style="list-style-type: none"> Point the remote control at the remote sensor of the unit.
	<ul style="list-style-type: none"> The remote control is too far from the unit. 	<ul style="list-style-type: none"> Operate the remote control within about 23 ft (7 m).
	<ul style="list-style-type: none"> There is an obstacle in the path of the remote control and the unit. 	<ul style="list-style-type: none"> Remove the obstacle.
	<ul style="list-style-type: none"> The batteries in the remote control are exhausted. 	<ul style="list-style-type: none"> Replace the batteries with new ones.

Specifications

General	
Net Weight	1.5 kg
External dimensions (WxHxD)	150 x 150 x 205 mm
Tuner	
FM Tuning Range	87.5 - 108.0 MHz or 65 - 74 MHz, 87.5 - 108.0 MHz
AM Tuning Range - OPTIONAL	522 - 1620 kHz or 520 - 1720 kHz
Amplifier	
Output Power	5 W + 5 W (T.H.D 10 %)
Frequency Response	30 - 20000 Hz
Signal-to-noise ratio	75 dB
CD	
Frequency response	40 - 20000 Hz
Signal-to-noise ratio	75 dB
Dynamic range	75 dB
Speakers (XAS12F)	
Type	1 Way 1 Speaker
Impedance	6 Ω
Frequency Response	100 - 17000 Hz
Sound Pressure Level	84 dB/W (1m)
Rated Input Power	5 W
Max. Input Power	10 W
Net Dimensions (WxHxD)	150 x 150 x 150 mm
Net Weight (1EA)	0.99 kg

Designs and specifications are subject to change without notice.



P/NO : MFL39672005