

User's Guide

M4210C

Make sure to read the **Important Precautions** before using the product.

Keep the User's Guide(CD) in an accessible place for future reference.

See the label attached on the product and give the information to your dealer when you ask for service.



Safety Precautions

Please read these safety precautions carefully before using the product.

 **Warning** If you ignore the warning message, you may be seriously injured or there is a possibility of accident or death.

 **Caution** If you ignore the caution message, you may be slightly injured or the product may be damaged

Precautions in installing the Product

Warning

- **Keep away from heat sources like electrical heaters.**
 - Electrical shock, fire, malfunction or deformation may occur.
- **Keep the packing anti-moisture material or vinyl packing out of the reach of children.**
 - Anti-moisture material is harmful if swallowed. If swallowed by mistake, force the patient to vomit and visit the nearest hospital. Additionally, vinyl packing can cause suffocation. Keep it out of the reach of children.
- **Do not put heavy objects on the product or sit upon it.**
 - If the product collapses or is dropped, you may be injured. Children must pay particular attention.
- **Do not leave the power or signal cable unattended on the pathway.**
 - The passerby can falter, which can cause electrical shock, fire, product breakdown or injury.
- **Install the product in a neat and dry place.**
 - Dust or moisture can cause electrical shock, fire or product damage.
- **If you can smell smoke or other odors or hear a strange sound unplug the power cord and contact the service center.**
 - If you continue to use without taking proper measures, electrical shock or fire can occur.
- **If you dropped the product or the case is broken, turn off the product and unplug the power cord.**
 - If you continue to use without taking proper measures, electrical shock or fire can occur. Contact the service center.
- **Do not drop an object on or apply impact to the product. Do not throw any toys or objects on the product screen.**
 - It can cause injury to human, problem to product and damage the display.

Caution

- **Make sure the product ventilation hole is not blocked. Install the product in a suitably wide place (more than 10cm from the wall)**
 - If you install the product too close to the wall, it may be deformed or fire can break out due to internal heat.
- **Do not block the ventilation hole of the product by a tablecloth or curtain.**
 - The product can be deformed or fire can break out due to overheating inside the product.
- **Install the product on a flat and stable place that has no risk of dropping the product.**
 - If the product is dropped, you may be injured or the product may be broken.
- **Install the product where no EMI occurs.**
- **Keep the product away from direct sunlight.**
 - The product can be damaged.

Safety Precautions

Electrical Power Related Precautions

Warning

- **Make sure to connect the power cable to the grounded current.**
 - You may be electrocuted or injured.
- **Use the rated voltage only.**
 - The product can be damaged, or you may be electrocuted.
- **In the presence of thunder and lightning, never touch the power cord and signal cable because it can be very dangerous.**
 - It can cause electric shock.
- **Do not connect several extension cords, electrical appliances or electrical heaters to a single outlet. Use a power bar with a grounding terminal designed for exclusive use with the computer.**
 - A fire can break out due to overheating.
- **Do not touch the power plug with wet hands. Additionally, if the cord pin is wet or covered with dust, dry the power plug completely or wipe dust off.**
 - You may be electrocuted due to excess moisture.
- **If you don't intend to use the product for a long time, unplug the power cable from the product.**
 - Covering dust can cause a fire, or insulation deterioration can cause electric leakage, electric shock or fire.
- **Fix the power cable completely.**
 - If the power cable is not fixed completely, a fire can break out.
- **Hold the plug when pulling out the power cable. Do not bend the power cord with excessive force or put heavy objects on the power cord.**
 - The power line can be damaged, which may cause electric shock or fire.
- **Do not insert a conductor (like a metal chopstick) into one end of the power cable while the other end is connected to the input terminal on the wall. Additionally, do not touch the power cable right after plugging into the wall input terminal.**
 - You may be electrocuted.
- **The power supply cord is used as the main disconnection device. Ensure that the socket-outlet is easily accessible after installation.**
- **Main power breaker is the power cord and this breaking device must be located at a location where it is easy to operate.**

Caution

- **Do not unplug the power cord while the product is in use.**
 - Electrical shock can damage the product.

Precautions in Moving the Product

Warning

- **Make sure to turn off the product.**
 - You may be electrocuted or the product can be damaged.
- **Make sure to remove all cables before moving the product.**
 - You may be electrocuted or the product can be damaged.

Safety Precautions

Caution

- **Do not shock the product when moving it.**
 - You may be electrocuted or the product can be damaged.
 - **Do not dispose the product-packing box. Use it when you move.**
 - **Make the panel face forward and hold it with both hands to move.**
 - If you drop the product, the damaged product can cause electric shock or fire. Contact with the service center for repair.
-

Precautions in Using the Product

Warning

- **Do not disassemble, repair or modify the product at your own discretion.**
 - Fire or electric shock accident can occur.
 - Contact the service center for check, calibration or repair.
- **When cleaning the brown tube surface, unplug the power cord and scrub with soft cloth to prevent scratching. Do not clean with a wet cloth.**
- **Keep the product away from water.**
 - Fire or electric shock accident can occur.

Caution

- **Do not put or store inflammable substances near the product.**
 - There is a danger of explosion or fire due to careless handling of the inflammable substances.
 - **When cleaning the brown tube surface, unplug the power cord and scrub with soft cloth to prevent scratching. Do not clean with a wet cloth.**
 - The water can sink into the product, which can cause electric shock or serious malfunction.
 - **Take a rest from time to time to protect your vision.**
 - **Keep the product clean at all times.**
 - **Take a comfortable and natural position when working with a product to relax the muscles.**
 - **Take a regular break when working with a product for a long time.**
 - **Do not press strongly upon the panel with a hand or sharp object such as nail, pencil or pen, or make a scratch on it.**
 - **Keep the proper distance from the product.**
 - Your vision may be impaired if you look at the product too closely.
 - **Set the appropriate resolution and clock by referring to the User's Guide.**
 - Your vision can be impaired.
 - **Use authorized detergent only when cleaning the product. (Do not use benzene, thinner or alcohol.)**
 - Product can be deformed.
-

On Disposal

- **The fluorescent lamp used in this product contains a small amount of mercury.**
- **Do not dispose of this product with general household waste.**
 - Disposal of this product must be carried out in accordance to the regulations of your local authority.

Using the Remote Control

● Name of the Remote Control Buttons (A type)

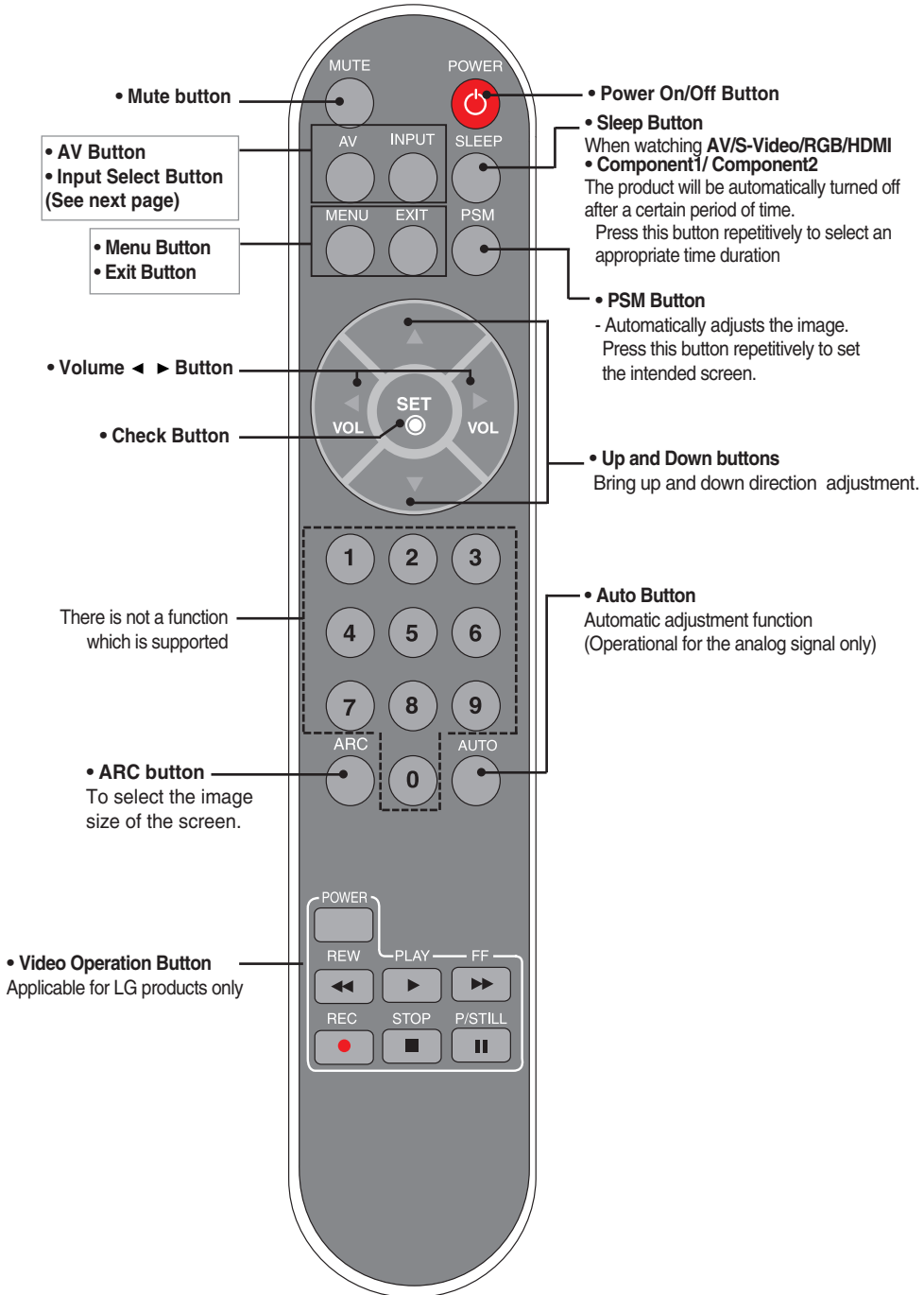

Using the Remote Control

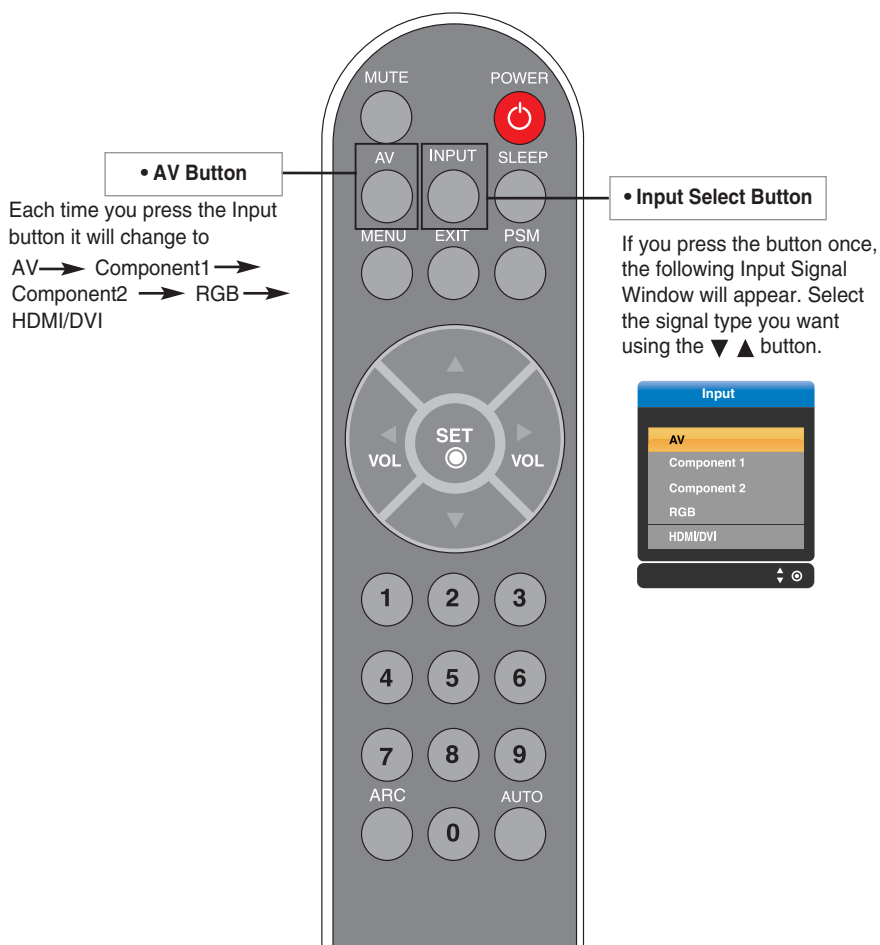

Inserting batteries into remote control.

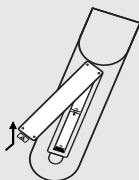

1. Take out the battery cap.
2. Insert the batteries with correct polarity (+/-).
3. Close the battery cap.
 - Dispose of used batteries in the recycle bin to prevent environmental pollution.

Using the Remote Control

● Name of the Remote Control Buttons(B type)

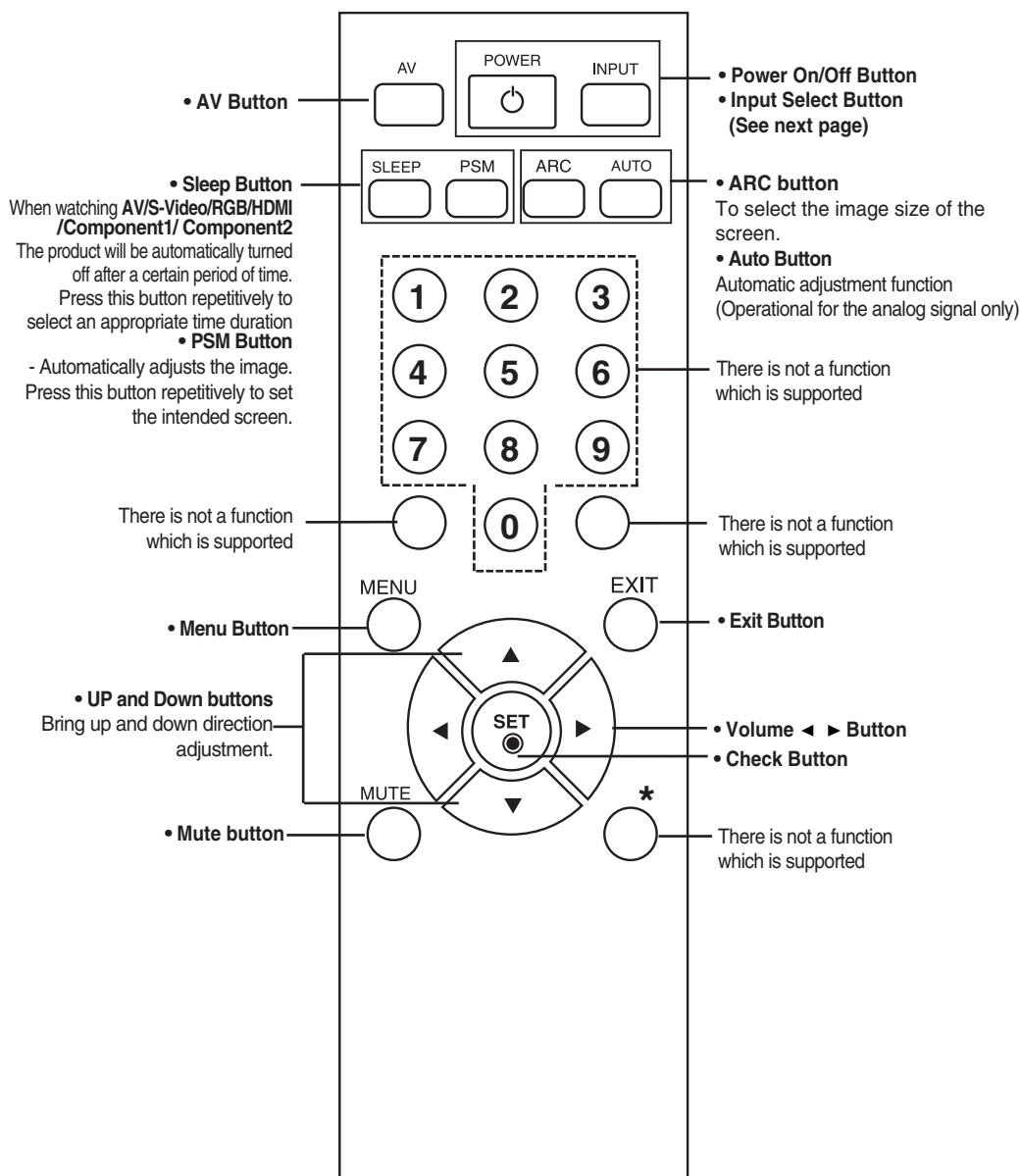

Using the Remote Control

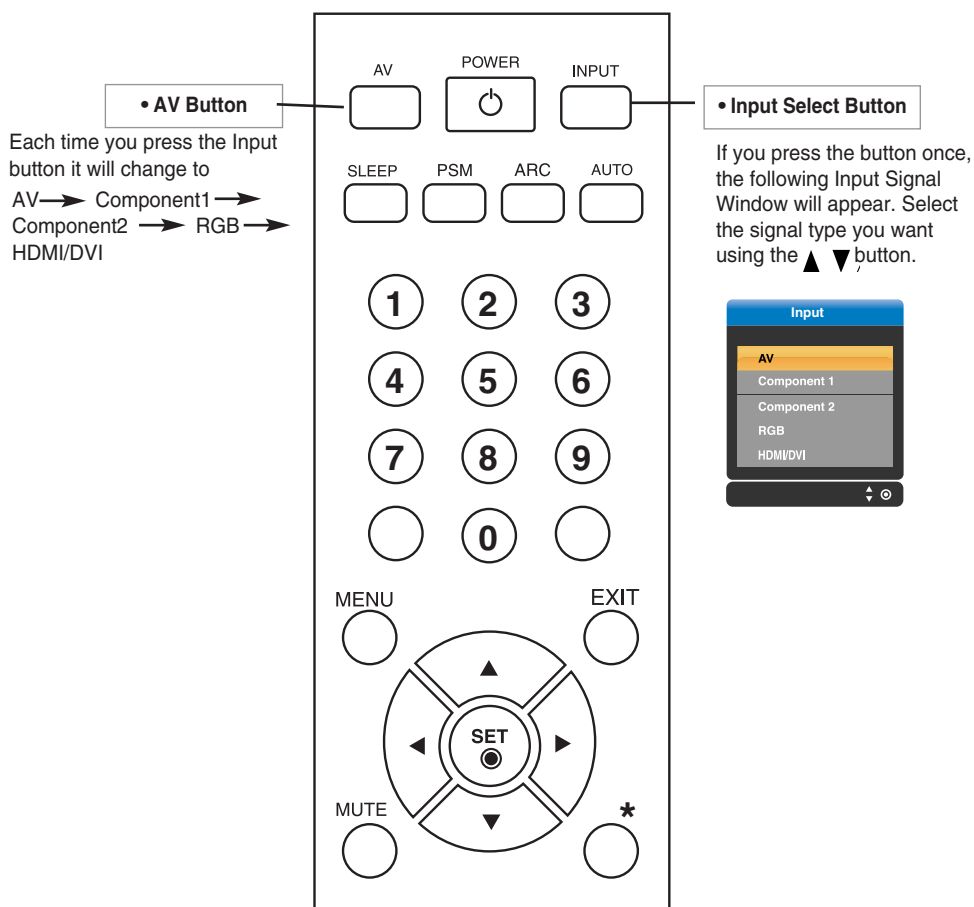

Inserting batteries into remote control.

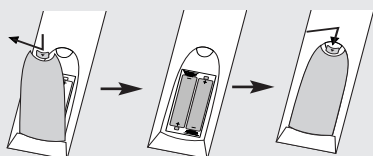

1. Take out the battery cap.
2. Insert the batteries with correct polarity (+/-).
3. Close the battery cap.
 - Dispose of used batteries in the recycle bin to prevent environmental pollution.

Connecting the Speakers

* Applicable only for models that support the speakers

Mount the product onto the speaker by using a screw as shown in the following picture, and then connect the speaker cable.

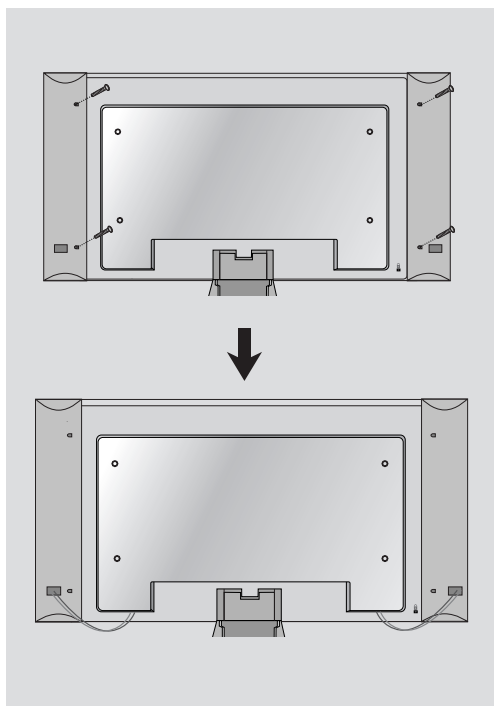

When the speaker is installed.

Name and Function of the Parts

* The product image in the user's guide could be different from the actual image.

Rear View

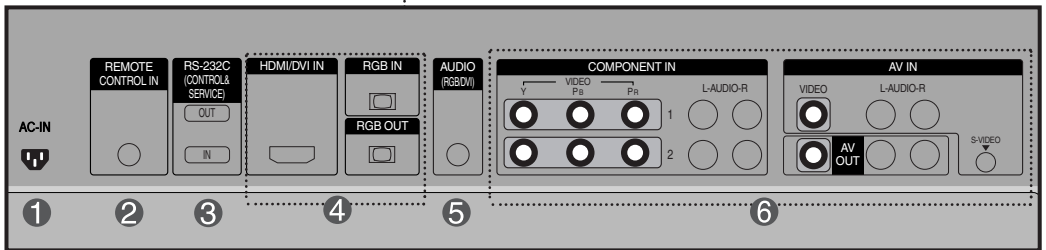
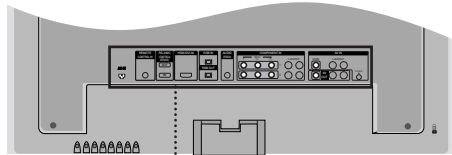

- 1 **Power Connector** : Connect the power cord
- 2 **Wired Remote Control Port**
- 3 **RS-232C Serial Ports**
- 4 **RGB, HDMI/DVI Ports**
- 5 **PC Sound Jack**
: Connect the audio cable to the *LINE OUT jack of the PC sound card.
- 6 **AV Ports**

*LINE OUT

A terminal used to connect to the speaker including a built-in amplifier (Amp). Make sure that the connecting terminal of the PC sound card is checked before connecting. If the Audio Out of PC sound card has only Speaker Out, reduce the PC volume.

If the Audio Out of the PC sound card supports both Speaker Out and Line Out, convert to Line Out using the card jumper of the program (Refer to the Sound Card Manual).

Connecting to External Devices

■ ■ ■ When Connecting to your PC

1 First of all, see if the computer, product and the peripherals are turned off. Then, connect the signal input cable.

- A** When connecting with the D-Sub signal input cable.
- B** When connecting with the HDMI to DVI signal input cable (not included).

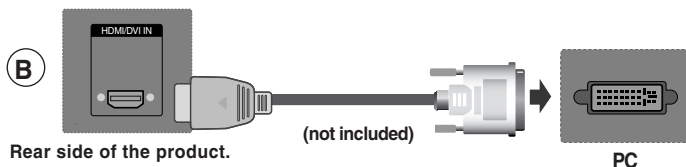
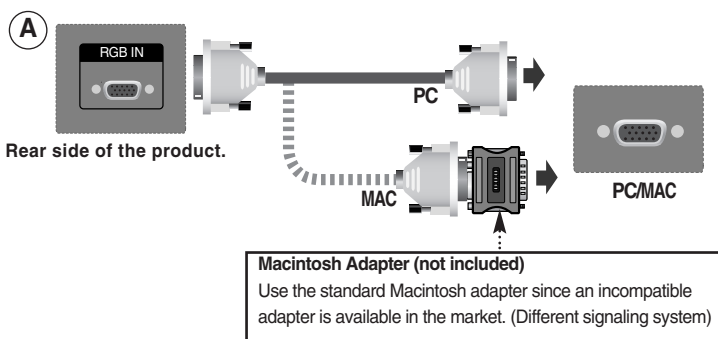

2 Connect the Audio cable.



3 Connect the power cord.

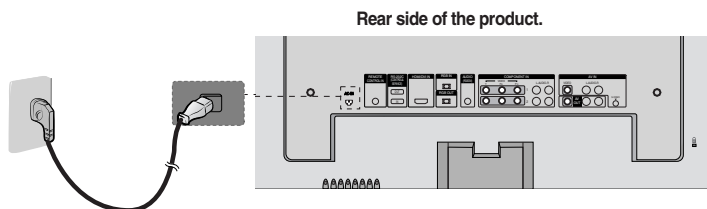

Connecting to External Devices

- 4 ① Turn on power by pressing the power button on the product.



- ② Turn on the PC.

- 5 Select an input signal.
Press the INPUT button on the remote control to select the input signal.

INPUT → ▼▲ → SET

Or, press the SOURCE button on the back of the product.

SOURCE → ▼▲ → AUTO/SET

- A When connecting with a D-Sub signal input cable.
• Select **RGB** : 15-pin D-Sub analog signal.
- B When connecting with a HDMI to DVI signal input cable.
• Select **HDMI/DVI** : HDMI to DVI Digital signal.

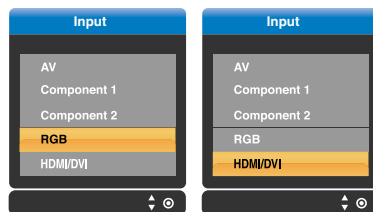

Note

- **How to connect to two computers.**
Connect the signal cables (HDMI to DVI and D-Sub) to each computer.
Press the INPUT button on the remote control to select the computer to use.
- **Directly connect to a grounded power outlet on the wall or a power bar with a ground wire.**

Connecting to External Devices

■ ■ ■ Watching RGB Outputs

Use this function when displaying ANALOG RGB inputs of a PC to the other product.

- **To use different products connected to each other**

Connect one end of the signal input cable(15-pin D-Sub Signal Cable) to the **RGB OUT** connector of **product 1** and connect the other end to the RGB IN connector of other products.

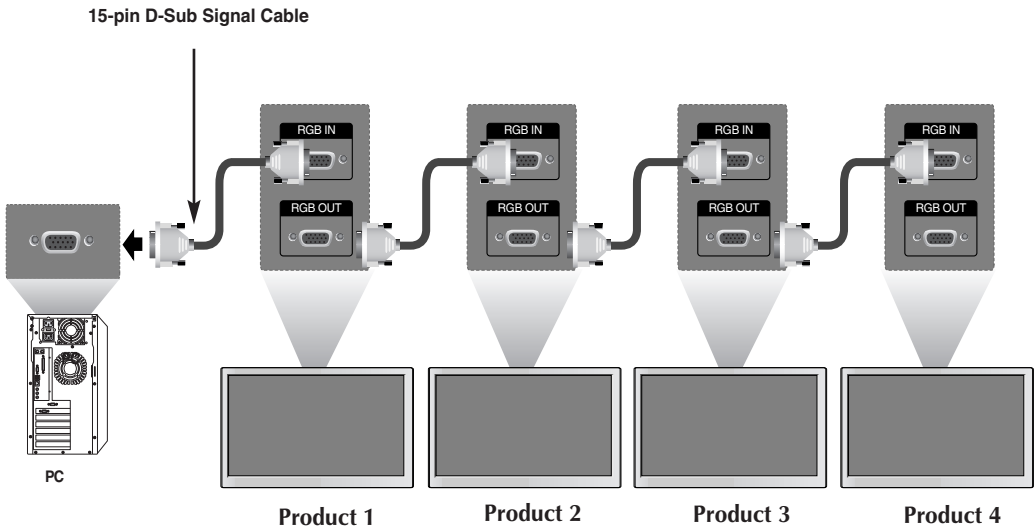

Note

- When multi-connecting in/out cascade format, cables to be less damaged are recommended. We recommend that you should use cable distributor.

Connecting to External Devices

When watching VCR / DVD

1 Connect the video cable as shown in the below figure and then connect the power cord (See page 10).

- A** When connecting with a BNC cable.
- Connect the input terminal with a proper color match.

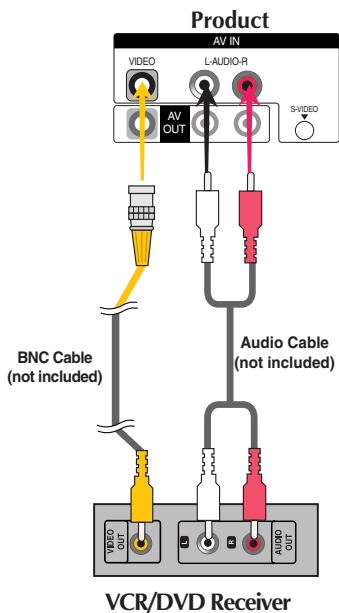

- B** When connecting with a S-Video cable.
- Connect to the S-Video input terminal to watch high image quality movies.

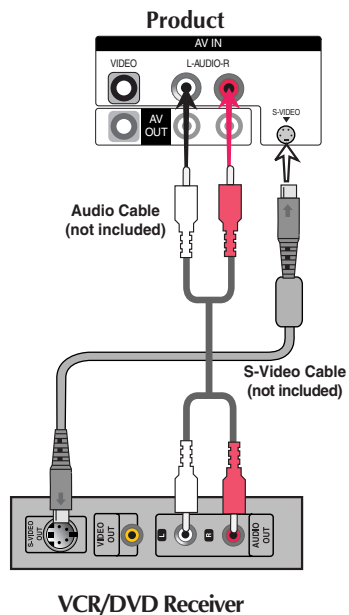

2 Select an input signal.
Press the INPUT button on the remote control to select the input signal.

INPUT → ▼▲ → SET

Or, press the SOURCE button on the back of the product.

SOURCE → ▼▲ → AUTO/SET

- A** When connecting with an BNC cable.
- Select **AV**.
- B** When connecting with an S-Video cable.
- Select **AV**.

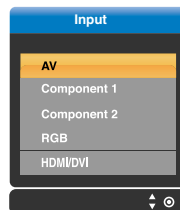

Note

- When the BNC cable is connected simultaneously with S-Video cable, S-Video cable is first.

Connecting to External Devices

■ ■ ■ When watching HDTV/DVD(480p/576p/720p/1080i/480i/576i)

1 Connect the video/audio cable as shown in the below figure and then, connect the power cord (See page 10).

- Connect the input terminal with a proper color match.

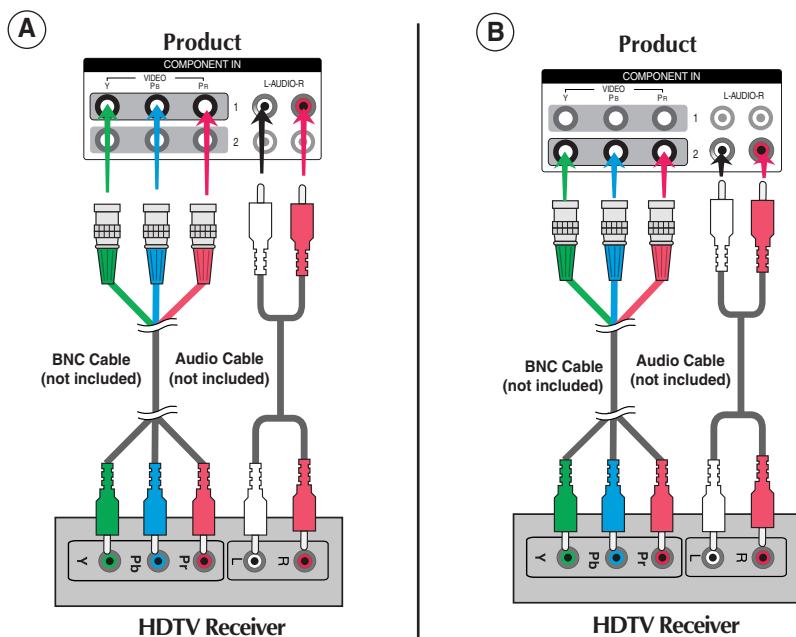

2 Select an input signal.
Press the INPUT button on the remote control to select the input signal.

INPUT → ▼▲ → SET

Or, press the SOURCE button on the back of the product.

SOURCE → ▼▲ → AUTO/SET

A • Select Component 1

B • Select Component 2

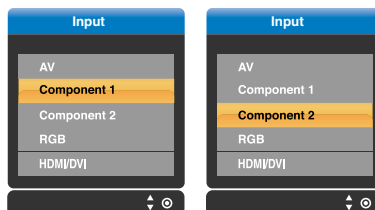

Connecting to External Devices

■ ■ ■ When watching HDMI/DVI/RGB from the VCR/DVD/Set-top Box (480p/576p/720p/1080i)

1 Connect the video/audio cable as shown in the below figure and then connect the power cord (See page 10).

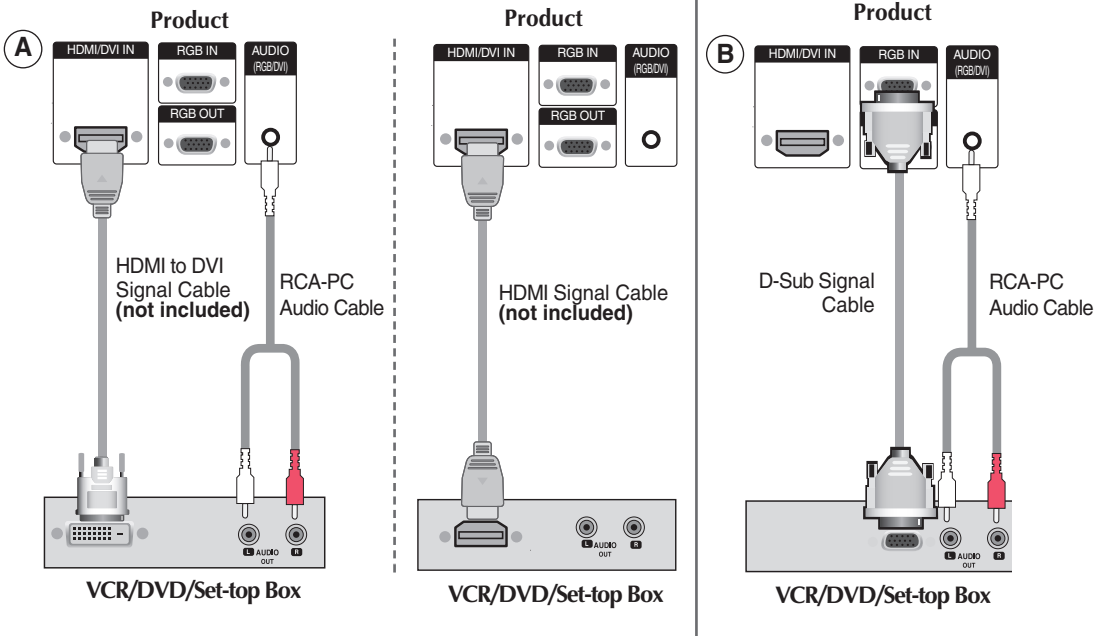

2 Select an input signal. Press the INPUT button on the remote control to select the input signal.

INPUT → ▼▲ → SET

Or, press the SOURCE button on the back of the product.

SOURCE → ▼▲ → AUTO/SET

A When connecting with a HDMI to DVI signal input cable. When connecting with a HDMI signal input cable.
• Select **HDMI/DVI**

B When connecting with a D-Sub signal input cable.
• Select **RGB**

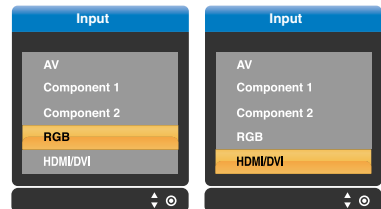

Connecting to External Devices

■ ■ ■ Watching AV Outputs

- When you set the input signal of the main screen as 'AV (CVBS)', you can transmit the signal that you're watching to the AV output terminal.

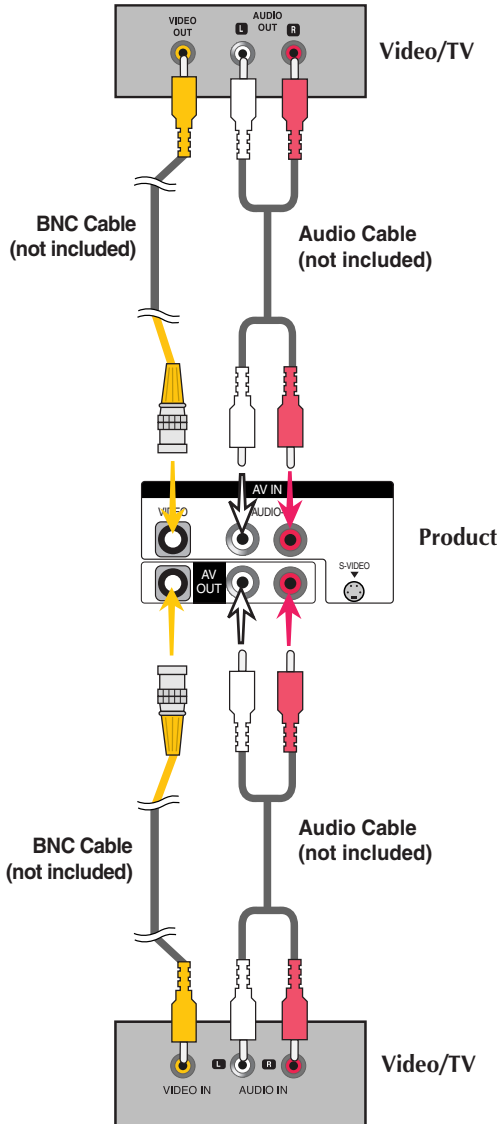

Note

- When multi-connecting in/out cascade format, cables to be less damaged are recommended. We recommend that you should use cable distributor.

To arrange cables using cable management

* Applicable only for models that support the stand.

1. Arrange the cables in the center as shown in the following picture.

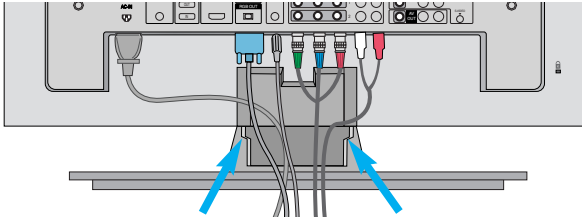

2. Fit the cable management to the Holder Groove downwards.

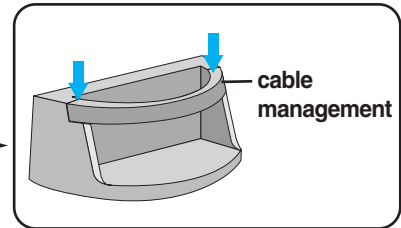
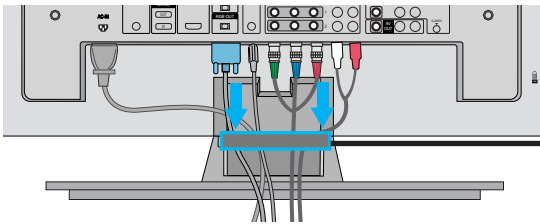

3. Bundle the cables using the supplied twister holder.

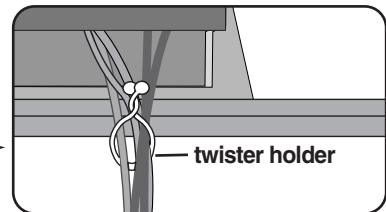
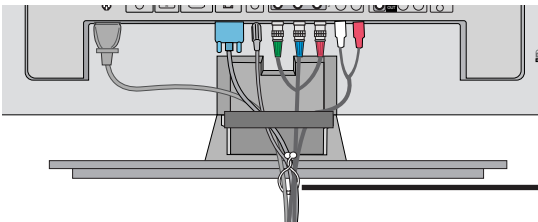

* When you want remove it.

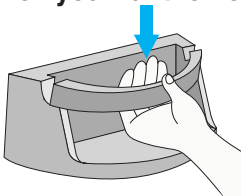

Hold the Cable management with both hands and pull it downward.

Warning

- Do not use the cable management as a handle for the Monitor.
- Do not press the cable management.

Attaching the product to a wall

* Applicable only for models that support the stand.

- Set it up close to the wall so the product doesn't fall over when it is pushed backwards.

The instructions shown below are a safer way to set up the product, which is to fix it on the wall so the product doesn't fall over when it is pulled forward. It will prevent the product from falling forward and hurting people. It will also prevent the product from damage caused by a fall. Please make sure that children don't climb on or hang from the product.

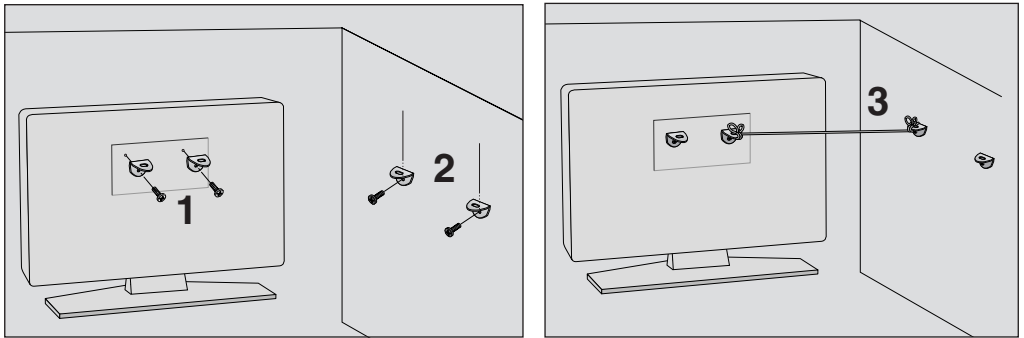

1. Use the bracket and the bolt to fix the product to the wall as shown in the picture.
2. Secure the bracket with the bolt(not provided with product, purchase separately) on the wall.
3. Use a sturdy rope (not provided with the product, purchase separately) to tie the product. It is safer to tie the rope horizontally between the wall and the product.



Note

- When moving the product to another place, undo the ropes first.
- Use a product holder or a cabinet that is big and strong enough for the size and weight of the product.
- To use the product safely, make sure that the height of the bracket that is mounted on the wall is same as that of the product.

Selecting and Adjusting the Screen

● Name of the Buttons in the Screen Adjustment Unit

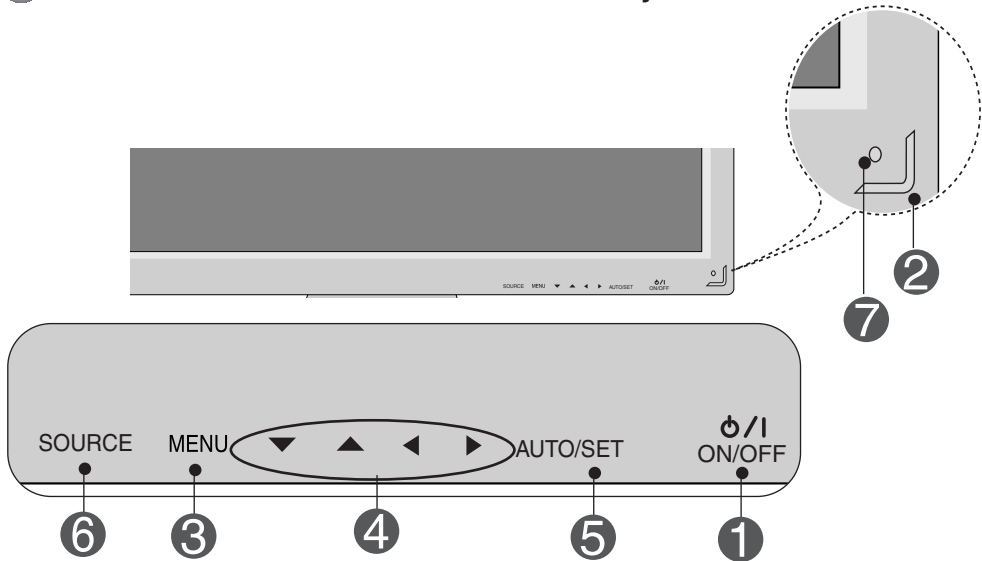

1

Power Button

• Press this button to turn on the power. Press this button again to turn it off.

2

Power Indicator

• This Indicator lights up blue when the display operates normally (on mode). If the display is in sleep (Energy Saving) mode, this indicator colour changes to amber.

3

MENU Button

• Use this button to show/hide the OSD (On Screen Display) menu screen.

4

OSD Select / Adjust Button

• Use this button to select an icon or adjust the setting in the OSD screen.

▼ ▲ • Adjust the up and down.

◀ ▶ • Adjust the volume.



Selecting and Adjusting the Screen

5 Name of the Buttons in the Screen Adjustment Unit

5

AUTO/SET Button

[For PC Analog signal]

Auto in progress
For optimal display change
resolution to 1360 X 768

[When XGA Mode is active and
1360 X768 is selected]

Auto in progress

6

SOURCE Button

SOURCE → ▼ ▲ → **AUTO/SET**

• Select the input signal

AV	Composite Video, Separate Video
Component 1	HDTV, DVD
Component 2	HDTV, DVD
RGB	15-pin D-Sub analog signal
HDMI/DVI	Digital signal

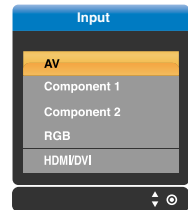





7

IR Receiver

• The unit that receives the signal from the remote control.

Selecting and Adjusting the Screen

● OSD Menu

Icon	Function Description
 PICTURE	Adjusts screen brightness, contrast and color that you prefer.
 SOUND	Adjusts the audio function.
 TIMER	Adjusts the timer function.
 SPECIAL	Adjusts the screen status according to the circumstances.
 SCREEN	Adjusts the screen video.



Note

OSD(On Screen Display)

The OSD function enables you to adjust the screen status conveniently since it provides graphical presentation.

Selecting and Adjusting the Screen

How to adjust the OSD (On Screen Display) screen

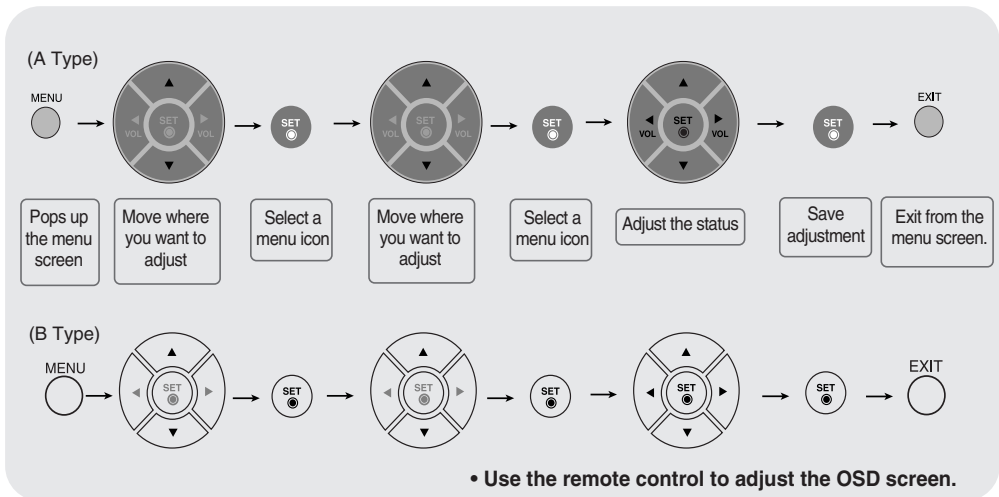

- 1 Press the **MENU** Button, then the main menu of the OSD appears.
- 2 To access a control, use the **▼ ▲** Buttons.
- 3 When the icon you want becomes highlighted, press the **SET** Button.
- 4 Use the **▼ ▲ ◀ ▶** Buttons to adjust the item to the desired level.
- 5 Accept the changes by pressing the **SET** Button.
- 6 Exit the OSD by pressing the **EXIT** Button.

How to adjust the screen automatically

You need to adjust the screen display when connecting the product to a new computer or changing the mode. Refer to the following section to set an optimal product screen.

[When XGA Mode is active and 1360 X768 is selected]

Auto in progress

Press the **AUTO/SET** button (**AUTO** button in a remote Control) in the PC analog signal. Then, an optimal screen status will be selected that fits into the current mode.

If adjustment is not satisfactory, you need to adjust screen position, clock and phase in the OSD menu.

Selecting and Adjusting the Screen



Adjusting Screen Color

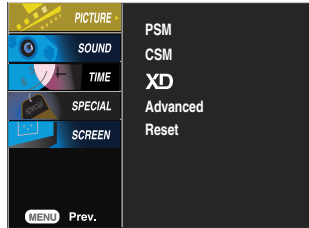

PSM

The **PSM** function automatically adjusts the screen image quality depending on the AV usage environment.

- **Dynamic** : Select this option to display with a sharp image.
- **Standard** : The most general and natural screen display status.
- **Mild** : Select this option to display with a mild image.
- **User1,2** : Select this option to use the user-defined settings.

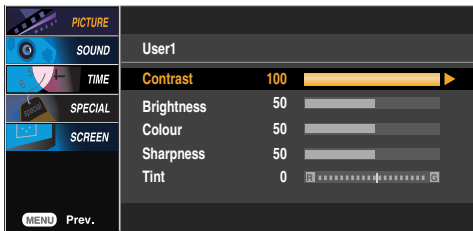

Contrast : Adjust the difference between the light and dark levels in the picture.

Brightness : To adjust the brightness of the screen.

Colour : To adjust the color to desired level.

Sharpness : To adjust the clearness of the screen.

Tint :To adjust the tint to desired level.

CSM

Selecting a factory setting color set.

- **Warm** : Slightly reddish white.
- **Normal** : Slightly bluish white.
- **Cool** : Slightly purplish white.
- **User** : Select this option to use the user-defined settings.

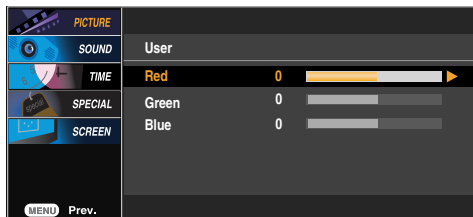

Red / Green / Blue
Set your own color levels.



Note

If the '**PSM**' setting in the **PICTURE** menu is set to **Dynamic**, **Standard** or **Mild** the subsequent menus will be automatically set.

Selecting and Adjusting the Screen

PICTURE

Adjusting Screen Color

- XD** XD is LG Electronics' unique picture improving technology that displays a real **HD** source through an advanced digital signal processing algorithm. This function is not available in **RGB-PC** or **HDMI/DVI PC** modes. This menu is activated after selecting **User1** or **User2** of **PSM**.

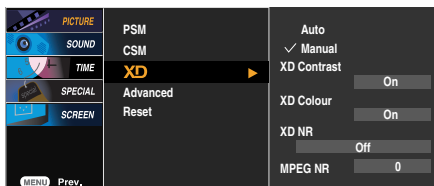

- **Auto** : XD is automatically changed to Auto.
- **Manual** : When selecting the Manual, you can adjust the **XD Contrast**, **XD Colour**, **XD NR**, **MPEG NR**.

- **XD Contrast** : Optimizing the contrast automatically according to the brightness of the reflection.
- **XD Colour** : Adjusting the colours of the reflection automatically to reproduce as closely as possible to natural colours.
- **XD NR** : Removing the noise up to the point where it does not damage the original picture.
- **MPEG NR** : You can select **MPEG NR** to reduce the picture noise which may appear on the screen while watching the AV.

Advanced

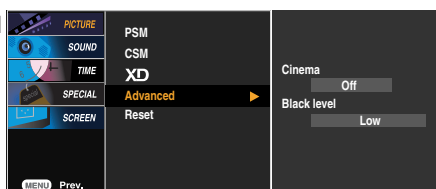

- **Cinema** : (Function works in the following mode - AV, Component 480i/576i)
When you watch the movie, this function adjusts the set to the best picture appearance.
- **Black Level** : (Function works in the following mode - AV(NTSC), HDMI/DVI)
adjusts the contrast and the brightness of the screen using the black level of the screen.

- **Low** : The reflection of the screen gets brighter.
- **High** : The reflection of the screen gets darker.
- **Auto** : Realizing the black level of the screen and set it to High or Low automatically.

Reset Return **PSM**, **CSM**, **XD**, **Advanced** to the default factory settings.

Selecting and Adjusting the Screen

SOUND Adjusting the audio function

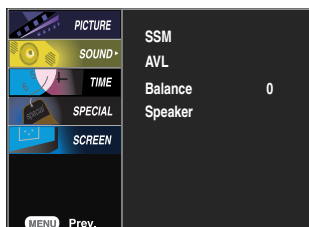

SSM

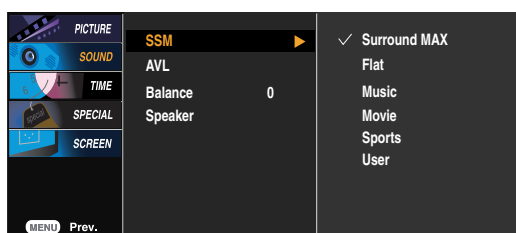

The best sound tone quality will be selected automatically depending on the video type that you're currently watching.

- **Surround MAX** : Set the **Surround MAX** on. This function plays back the mono or stereo sound input with the dynamic surround effects. It will provide rich and profound sound tone. If you set the **Surround MAX** on, user audio setting can not be adjusted.
- **Flat** : The most commanding and natural audio.
- **Music** : Select this option to enjoy the original sound when listening to the music.
- **Movie** : Select this option to enjoy sublime sound.
- **Sports** : Select this option to watch sports broadcasting.
- **User** : Select this option to use the user-defined audio settings.

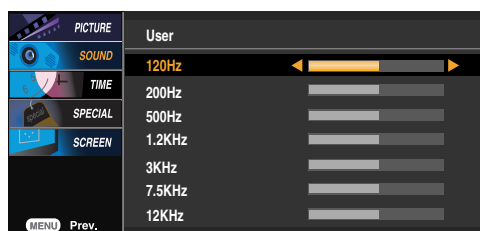

AVL To adjust uneven sound volumes across all channels or signals automatically to the most appropriate level. To use this feature, select On.

Balance Use this function to balance sound from the left and right speakers.

Speaker You can adjust internal speaker status.
If you want to use your external hi-fi stereo system, turn off the internal speakers of the set.



Note

When connected to your computer and the 'SSM' setting in the audio menu is **Flat**, **Music**, **Movie** or **Sports**, the available menus are **Balance**, **AVL** and **Surround MAX**.

Selecting and Adjusting the Screen

Adjusting the timer function

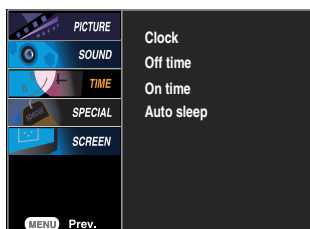

Clock

If the time is on the clock is incorrect, reset the clock manually.

- 1) Press the **MENU** button and then use **▼▲** button to select the **TIME** menu.
- 2) Press the **▶** button and then use **▼▲** button to select the **Clock** menu.
- 3) Press the **▶** button and then use **▼▲** button to set the hour(00~23).
- 4) Press the **▶** button and then use **▼▲** button to set the minutes(00~59).

Off / On time

The off time automatically switches the set to standby at the pre-set time.

- 1) Press the **MENU** button and then use **▼▲** button to select the **TIME** menu.
- 2) Press the **▶** button and then use **▼▲** button to select **Off time** or **On time**.
- 3) Press the **▶** button and then use **▼▲** button to set the hour(01~23).
- 4) Press the **▶** button and then use **▼▲** button to set the minutes(00~59).
- 5) Press the **▶** button and then use **▼▲** button to select **On** or **Off**.

Auto sleep

If **Auto sleep** is active and there is no input signal, the set switches to standby mode automatically after 10 minutes.

- 1) Press the **MENU** button and then use **▼▲** button to select the **Auto sleep** menu.
- 2) Press the **▶** button and then use **▼▲** button to select **On** or **Off**.

Note



- In the event of power interruption (disconnection or power failure), the clock must be reset.
- Once the on or off time is set, these functions operate daily at the preset time.
- Off time function overrides On time function if they are set to the same time.
- The set must be in standby mode for the On time to work.
- When On time is operated, input screen is turned on as it was turned off.

Selecting and Adjusting the Screen

SPECIAL Selecting the options

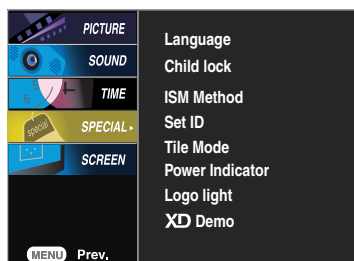

Language

To choose the language in which the control names are displayed.

Child lock

Use the ▼▲ buttons to select **On** or **Off**. The monitor can be set up so that it can only be used with the remote control. This feature can prevent unauthorized viewing.

In order to lock the OSD screen adjustment, set the **Child lock** tab to the 'On' position. In order to unlock it, do the following :

- Push the **MENU** button on the remote control and set **Child lock** to the 'Off' position.

ISM Method

A frozen or still picture from a PC/Video game displayed on the screen for prolonged periods will result in a ghost image remaining even when you change the image. Avoid allowing a fixed image to remain on the screen for a long period of time.

Normal : If image sticking is never a problem, ISM is not necessary -set to Normal.

White wash : White wash removes permanent images from the screen.

(An excessive permanent image may be impossible to clear entirely with white wash.

Orbiter : May help prevent ghost images. However, it is best not to allow any fixed image to remain on the screen. To avoid a permanent image on the screen, the screen will move every 2 minutes.

Inversion : This function inverts the panel colour of the screen. The panel colour is automatically inverted every 30 minutes.

Orb.+Inv. : This function inverts the panel colour of the screen and may help prevent ghost images. The panel colour is automatically inverted every 30 minutes and the screen will move every 2 minutes.

Set ID

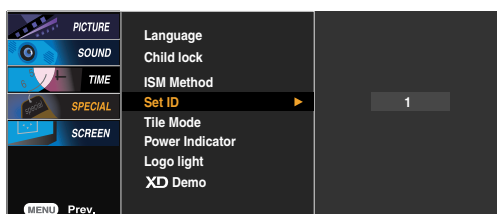

You can assign a unique **Set ID** NO (name assignment) to each product when several products are connected for display. Specify the number (1-99) using the ▼▲ button and exit. Use the assigned **Set ID** to individually control each product using the Product Control Program.

Selecting and Adjusting the Screen

SPECIAL Selecting the options

• To use this function

- Must be displayed with various other products.
- Must be in a function that can be connected to RS-232C or RGB Out

Tile mode

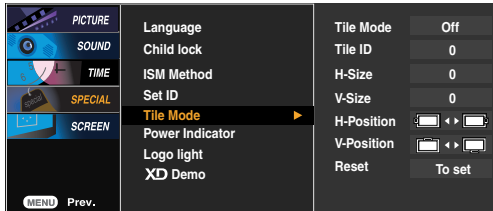

It is used to enlarge the screen and also used with several products to view screen.

• Tile Mode

Tile mode and choose Tile alignment and set the ID of the current product to set location.

* Only after pressing the SET button the adjustments made to the settings will be saved.

- Tile mode : row x column (r = 1, 2, 3, 4 c = 1, 2, 3, 4)
- 4 x 4 available.
- Configuration of an integration screen is also available as well as configuration of One by one Display.



- Tile mode (product 1 ~ 4) : r(2) x c(2)

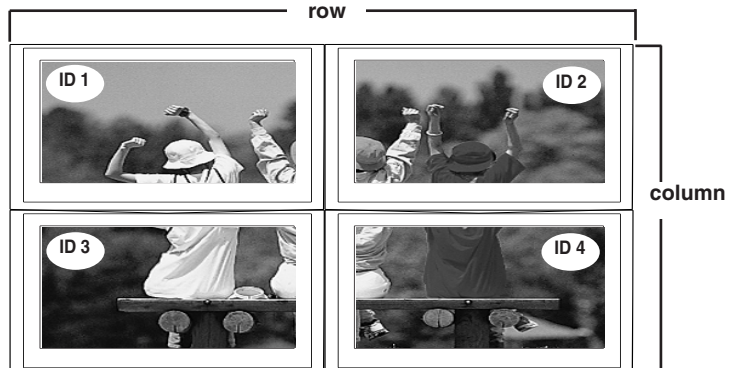

Selecting and Adjusting the Screen



SPECIAL

Selecting the options

- Tile mode (product 1 ~ 9) : r(3) x c(3)

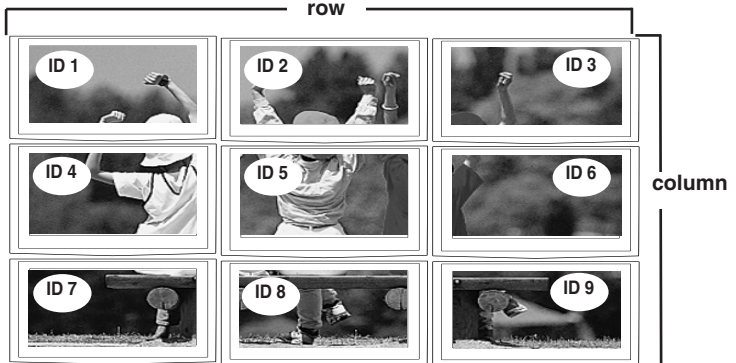

- Tile mode (product 1 ~ 2) : r(2) x c(1)

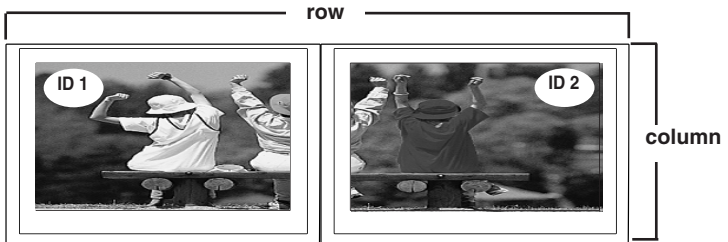

- Tile mode (product 1 ~ 16) : r(4) x c(4)

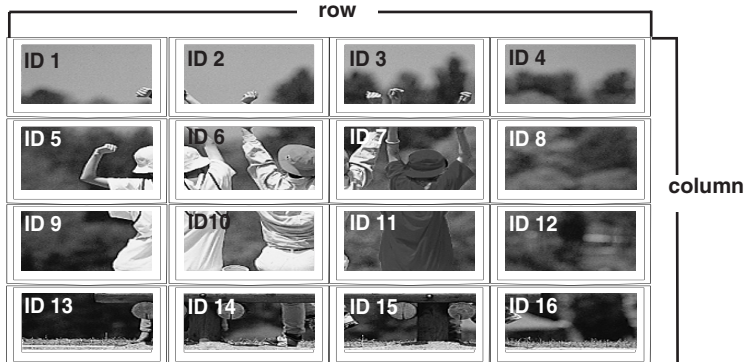

Selecting and Adjusting the Screen

SPECIAL Selecting the options

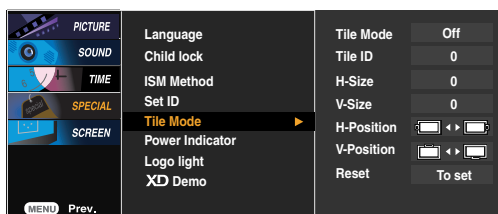

- **Tile ID** Select the location of the Tile by setting an ID.
- **H Size** Adjust the horizontal size of the screen taking into account the size of the bezel.
- **V Size** Adjust the vertical size of the screen taking into account the size of the bezel.
- **H-Position** Moving the screen position horizontally.
- **V-Position** Moving the screen position vertically.
- **Reset** Function to initialize and release Tile.
All Tile setting are released when selecting Tile recall and the screen returns to Full screen.

Power Indicator Use this function to set the power indicator on the front side of the product to **On** or **Off**.
If you set **Off**, it will go off. If you set **On** at any time, the power indicator will automatically be turned on.

Logo Light Use this function to set the Logo Display Lamp on the front side of the product to **On** or **Off**. If you set **On**, the lamp will automatically be turned on.

XD Demo Use it to see the difference between XD demo on and XD Demo off.
(XD Demo function is not available in RGB PC/ HDMI/DVI PC mode.)

Selecting and Adjusting the Screen

SCREEN Adjusting Screen CLOCK/PHASE and Position

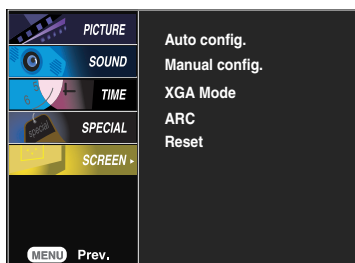

Auto-config. (RGB PC input only)

This button is for the automatic adjustment of the screen position, clock and phase. This function is suitable for analogue signal input only.

Manual- config.

If the picture isn't clear after auto adjustment and characters are still trembling, adjust the picture phase manually.

* Phase, Clock function are not available in RGB DTV, Component, HDMI/DVI DTV.)

Clock

To minimize any vertical bars or stripes visible on the screen background. The horizontal screen size will also change. This function is suitable for analogue signal input only

Phase

To adjust the focus of the display. This item allows you to remove any horizontal noise and clear or sharpen the image of characters. This function is suitable for analogue signal input only.

H-Position

Moving the screen position horizontally.

V-Position

Moving the screen position vertically.

XGA Mode (RGB-PC only).

For more improved or better picture quality, select the same mode corresponding to computer resolution.

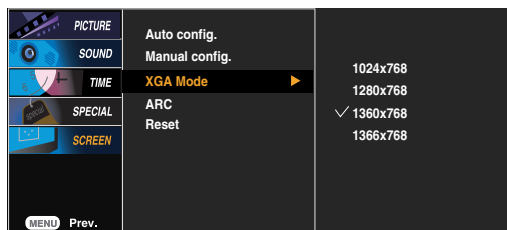

Selecting and Adjusting the Screen



SCREEN

Adjusting Screen CLOCK/PHASE and Position

ARC To select the image size of the screen.

- Spectacle** When your AV receives the wide screen signal, it will lead you to adjust the picture horizontally, in a nonlinear proportion, to fill the entire screen.
- Full** When your AV receives the wide screen signal, it will lead you to adjust the picture horizontally or vertically, in a linear proportion, to fill the entire screen fully. (Europe an version only)
- Original** When your AV receives the wide screen signal, it will be automatically changed to picture format to be sent.
- 4:3** This picture format is 4:3 of general AV.
- 16:9** You can enjoy movies (the picture format of 16:9) or general TV programmes thorough 16:9 mode. Programmes with 16:9 format are viewed naturally but 4:3 programmes are magnified on the left and right so that the screen is 16:9 format.
- 1:1** This picture format is 1:1 of general AV. (only RGB PC, HDMI/DVI PC)
- 14:9** You can enjoy the picture format of 14:9 or general AV programmes through 14:9 mode. Programmes with 14:9 are viewed naturally, but 4:3 programmes are magnified on the top/bottom and left/right sides.
- Zoom1, 2** You can enjoy movies on a vast screen through Zoom mode. The 4:3 programmes are magnified on the top/bottom and left/right sides so that screen is 16:9 format. The bottom and top of the picture may be lost.

ARC \ MODE	MODE		HDMI/DVI		RGB	
	AV	Component	DTV	PC	DTV	PC
Spectacle	●	×	×	×	×	×
Full	●	×	×	×	×	×
Original	●	×	×	×	×	×
4:3	●	●	●	×	●	×
16:9	●	●	●	●	●	●
14:9	●	×	×	×	×	×
Zoom1	●	●	●	×	●	×
Zoom2	●	●	●	×	●	×
1:1	×	×	×	●	×	●

Reset

Return **Manual config.** to the default factory settings.

Troubleshooting

No image is displayed

- Is the product power cord connected?
 - See if the power cord is properly connected to the outlet.
 - See if the power switch is turned on.
 - Adjust brightness and contrast again.
- Is the power indicator light on?
- Power is on, power indicator is blue but the screen appears extremely dark.
 - If the product is in power saving mode, move the mouse or press any key.
- the power indicator amber?
 - The signal from the PC (video card) is out of the vertical or horizontal frequency range of the product. Adjust the frequency range by referring to the Specifications in this manual.
 - * **Maximum resolution**
RGB : 1600 x 1200 @60Hz
HDMI/DVI : 1280 x 1024 @60Hz
- Does the 'Out of range' message appear?
 - The signal cable between PC and product is not connected. Check the signal cable.
 - Press the 'INPUT' menu in the remote Control to check the input signal.
- Does the 'Check signal cable' message appear?

'Unknown Product' message appears when the product is connected.

- Did you install the driver?
 - Install the product driver, which is provided with the product, or download it from the web site. (<http://www.lge.com>)
 - See if the plug&play function is supported by referring to the video card user manual.

'Controls Locked' message appears.

- The 'Controls Locked' message appears when pressing the Menu button.
 - The control locking function prevents unintentional OSD setting change due to careless usage. To unlock the controls, simultaneously press the Menu button and ► button for several seconds. (You cannot set this function using the remote control buttons. You can set this function in the product only.)



Note

* **Vertical frequency:** To enable the user to watch the product display, screen image should be changed tens of times every second like a fluorescent lamp. The vertical frequency or refresh rate is the times of image display per second. The unit is Hz.

* **Horizontal frequency:** The horizontal interval is the time to display one vertical line. When 1 is divided by the horizontal interval, the number of horizontal lines displayed every second can be tabulated as the horizontal frequency. The unit is kHz.

Troubleshooting

The screen image looks abnormal.

- **Is the screen position wrong?**
 - D-Sub analog signal – Press the “AUTO” button in the remote control to automatically select the optimal screen status that fits into the current mode. If adjustment is not satisfactory, use the Position OSD menu.
 - See if the video card resolution and frequency are supported by the product. If the frequency is out of range, set to the recommended resolution in the Control Panel – Display – Setting menu.
- **Do thin lines appear on the background screen?**
 - D-Sub analog signal – Press the “AUTO” button in the remote control to automatically select an optimal screen status that fits into the current mode. If adjustment is not satisfactory, use the Clock OSD menu.
- **Horizontal noise appears or the characters look blurred.**
 - D-Sub analog signal – Press the “AUTO” button in the remote control to automatically select an optimal screen status that fits into the current mode. If adjustment is not satisfactory, use the Phase OSD menu.
- **The screen is displayed abnormally.**
 - The proper input signal is not connected to the signal port. Connect the signal cable that matches with the source input signal.

After-image appears on the product.

- **After-image appears when the product is turned off.**
 - If you use a fixed image for a long time, the pixels may be damaged quickly. Use the screen-saver function.

Troubleshooting

The audio function does not work.

- **No sound?**
 - See if the audio cable is connected properly.
 - Adjust the volume.
 - See if the sound is set properly.
 - Select the appropriate equalize sound.
 - Adjust the volume.
- **Sound is too dull.**
- **Sound is too low.**

Screen color is abnormal.

- **Screen has poor color resolution (16 colors).**
 - Set the number of colors to more than 24 bits (true color)
Select Control Panel – Display – Settings – Color Table menu in Windows.
- **Screen color is unstable or mono-colored.**
 - Check the connection status of the signal cable.
Or, re-insert the PC video card.
- **Do black spots appear on the screen?**
 - Several pixels (red, green, white or black color) may appear on the screen, which can be attributable to the unique characteristics of the LCD panel. It is not a malfunction of the LCD.

Specifications

The product specifications can change without prior notice for product improvement.

Video Signal	Max. Resolution	RGB : 1600 X 1200 @60Hz HDMI/DVI : 1280 X 1024 @60Hz – It may not be supported depending on the OS or video card type.
	Recommended Resolution	RGB : WSXGA 1360 X 768 @60Hz HDMI/DVI : WSXGA 1360 X 768 @60Hz – It may not be supported depending on the OS or video card type.
	Horizontal Frequency	RGB : 30 - 83 kHz HDMI/DVI : 30 - 72 kHz
	Vertical Frequency	56 - 85 Hz
	Synchronization Type	Separate/Composite/SOG (Sync On Green)/Digital
Input Connector	15-pin D-Sub type, HDMI (digital), S-Video, Composite Video, Component, RS-232C	
Environmental Conditions	Operational Condition	Temperature: 10°C ~ 35°C , Humidity: 10% ~ 80%
	Storage Condition	Temperature: -20°C ~ 60°C , Humidity: 5% ~ 95%

* Applicable only for models that support the speakers

Audio	RMS Audio Output	10W+10W(R+L)
	Input Sensitivity	0.7Vrms
	Speaker Impedance	8Ω

NOTE

- Information in this document is subject to change without notice.

Specifications

● PC Mode – Preset Mode

Preset mode		Horizontal Frequency (kHz)	Vertical Frequency (Hz)	Preset mode		Horizontal Frequency (kHz)	Vertical Frequency (Hz)
1	VGA 640 x 350	31.469	70	11	VESA 1024 x 768	60.123	75
2	VGA 720 x 400	31.468	70	12	VESA 1024 x 768	68.68	85
3	VGA 640 x 480	31.469	60	13	VESA 1280 x 720	44.772	60
4	VESA 640 x 480	37.500	75	14	VESA 1280 x 768	47	60
5	VESA 640 x 480	43.269	85	15	VESA 1360 x 768	47.72	60
6	VESA 800 x 600	37.879	60	16	VESA 1366 x 768	47	60
7	VESA 800 x 600	46.875	75	17	VESA 1280 x 1024	63.981	60
8	VESA 800 x 600	53.674	85	18	VESA 1280 x 1024	79.98	75
9	MAC 832 x 624	49.725	75	19	VESA 1600 x 1200	75.00	60
10	VESA 1024 x 768	48.363	60				

RGB : Mode 1 ~ Mode 19
HDMI/DVI : Mode 1 ~ Mode 17

● DTV Mode

	Component	RGB(DTV)	HDMI/DVI(DTV)
480i	o	x	x
576i	o	x	x
480p	o	o	o
576p	o	o	o
720p	o	o	o
1080i	o	o	o

● Power Indicator

Mode	Product
On Mode	Blue
Sleep Mode	Amber
Off Mode	-

NOTE

- DTV/PC selection on RGB and HDMI/DVI inputs is available for PC resolutions : 640 X 480/60Hz, 1280 X 720/60Hz and DTV resolutions : 480p, 720p.

Specifications

VESA wall mounting

Connected to another object (stand type and wall-mounted type.) This product accepts a VESA-compliant mounting interface pad.- **(This has to be purchased separately if required.)**

For further information, refer to the VESA Wall Mounting Instruction Guide.

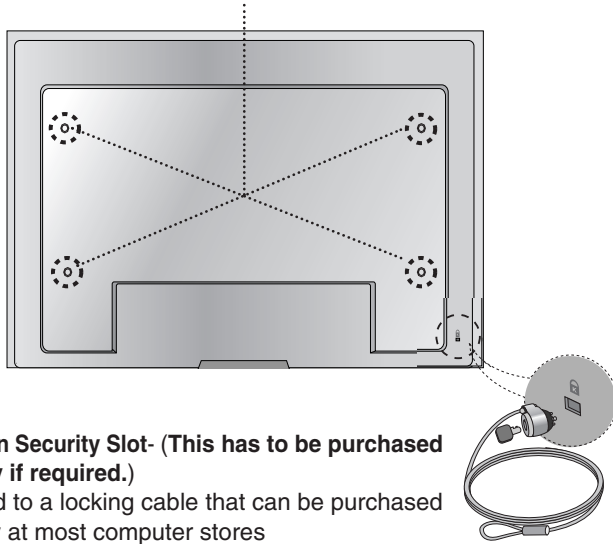

Kensington Security Slot- **(This has to be purchased separately if required.)**

Connected to a locking cable that can be purchased separately at most computer stores

Use this method to connect several products to a single PC.

You can control several products at a time by connecting them to a single PC.

Connecting the cable

Connect the RS-232C cable as shown in the picture.

* The RS-232C protocol is used for communication between the PC and product. You can turn the product on/off, select an input source or adjust the OSD menu from your PC.

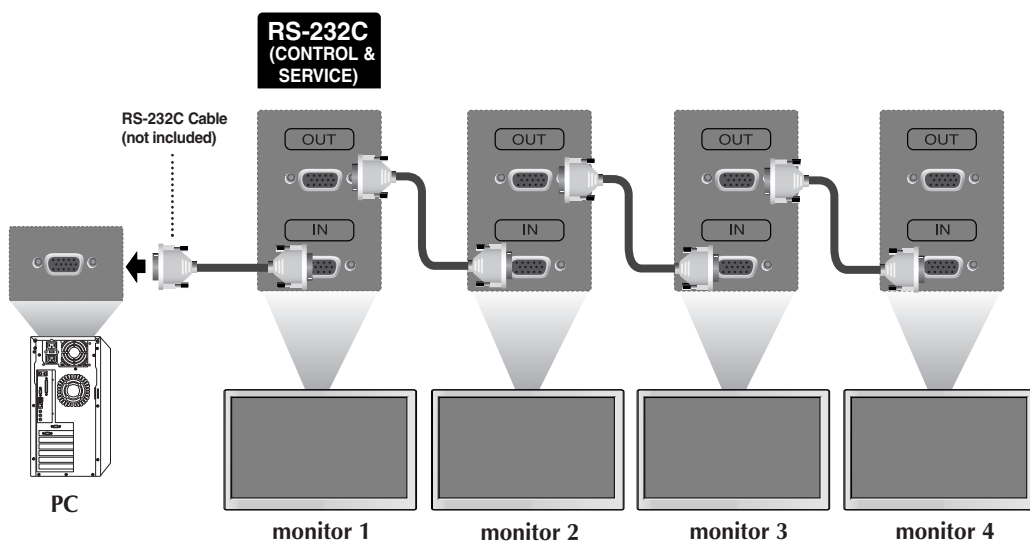

Communication Parameter

- ▶ Baud Rate : 9600bps (UART)
- ▶ Data Length : 8bits
- ▶ Parity Bit : None
- ▶ Stop Bit : 1bit
- ▶ Flow Control : None
- ▶ Communication Code : ASCII code

 Command Reference List

	COMMAND1	COMMAND2	DATA(Hexa)
01. Power	k	a	00H - 01H
02. Input Select	k	b	02H - 09H
03. Aspect Ratio	k	c	01H - 09H
04. Screen Mute	k	d	00H - 01H
05. Volume Mute	k	e	00H - 01H
06. Volume Control	k	f	00H - 64H
07. Contrast	k	g	00H - 64H
08. Brightness	k	h	00H - 64H
09. Color	k	i	00H - 64H
10. Tint	k	j	00H - 64H
11. Sharpness	k	k	00H - 64H
12. OSD Select	k	l	00H - 01H
13. Remote Lock/ key Lock	k	m	00H - 01H
14. Balance	k	t	00H - 64H
15. Color Temperature	k	u	00H - 03H
16. Abnormal state	k	z	FFH
17. ISM mode	j	p	00H - 08H
18. Auto configuration	j	u	01H
19. Key	m	c	Key Code
20. Tile Mode	d	d	00H - 44H
21. Tile H Size	d	g	00H - 64H
22. Tile V Size	d	h	00H - 64H
23. Tile ID Set	d	i	00H - 10H
24. Elapsed time return	d	l	FFH
25. Temperature value	d	n	FFH
26. Lamp fault check	d	p	FFH

● Transmission / Receiving Protocol

Transmission

```
[Command1][Command2][ ][Set ID][ ][Data][Cr]
```

- * [Command 1]: First command. (j, k, m, d)
- * [Command 2]: Second command.
- * [Set ID]: Set up the Set ID number of product.
 range : 1~99. by setting '0', server can control all products.
 * In case of operating with more than 2 sets using set ID as '0' at the same time, it should not be checked the ack message.
 Because all sets will send the ack message, so it's impossible the check the whole ack messages.
- * [DATA]: To transmit command data.
 Transmit 'FF' data to read status of command.
- * [Cr]: Carriage Return
 ASCII code '0x0D'
- * []: ASCII code Space (0x20)

OK Acknowledgement

```
[Command2][ ][Set ID][ ][OK][Data][x]
```

- * The Product transmits ACK (acknowledgement) based on this format when receiving normal data. At this time, if the data is data read mode, it indicates present status data. If the data is data write mode, it returns the data of the PC computer.

Error Acknowledgement

```
[Command2][ ][Set ID][ ][NG][Data][x]
```

- * If there is error, it returns NG

● Transmission / Receiving Protocol

01. Power(Command : a)

- ▶ To control Power On/Off of the Set.

Transmission

```
[k][a][ ][Set ID][ ][Data][Cr]
```

Data 0 : Power Off 1 : Power On

Acknowledgement

```
[a][ ][Set ID][ ][OK][Data][x]
```

- ▶ To show the status of Power On/Off.

Transmission

```
[k][a][ ][Set ID][ ][FF][Cr]
```

Acknowledgement

```
[a][ ][Set ID][ ][OK][Data][x]
```

Data 0 : Power Off 1 : Power On

02. Input Select (Command : b) (Main Picture Input)

- ▶ To select input source for the Set.
You can also select an input source using the SOURCE button on the remote control.

Transmission

```
[k][b][ ][Set ID][ ][Data][Cr]
```

Data 2 : AV	6 : RGB (DTV)
4 : Component 1	7 : RGB (PC)
5 : Component 2	8 : HDMI (DTV)
	9 : HDMI (PC)

Acknowledgement

```
[b][ ][Set ID][ ][OK][Data][x]
```

Data 2 : AV	6 : RGB (DTV)
4 : Component 1	7 : RGB (PC)
5 : Component 2	8 : HDMI (DTV)
	9 : HDMI (PC)

● Transmission / Receiving Protocol

03. Aspect Ratio(Command : c) (Main picture format)

▶ To adjust the screen format.

You can also adjust the screen format using the ARC (Aspect Ratio Control) button on remote control or in the Screen menu.

Transmission

```
[k][c][ ][Set ID][ ][Data][Cr]
```

Data 1 : Normal Screen (4:3)	5 : Zoom2
2 : Wide Screen (16 :9)	6 : Original
3 : Horizon (Spectacle)	7 : 14 : 9
4 : Zoom1	8 : Full (Europe version only)
	9 : 1 : 1 (PC)

Acknowledgement

```
[c][ ][Set ID][ ][OK][Data][x]
```

04. Screen Mute(Command : d)

▶ To select screen mute on/off.

Transmission

```
[k][d][ ][Set ID][ ][Data][Cr]
```

Data 0 : Screen mute off (Picture on)
1 : Screen mute on (Picture off)

Acknowledgement

```
[d][ ][Set ID][ ][OK][Data][x]
```

● Transmission / Receiving Protocol

05. Volume Mute(Command : e)

▶ To control On/Off of the Volume Mute.

Transmission

```
[k][e][ ][Set ID][ ][Data][Cr]
```

Data 0 : Volume Mute On (Volume Off)

1 : Volume Mute Off (Volume On)

Acknowledgement

```
[e][ ][Set ID][ ][OK][Data][x]
```

Data 0 : Volume Mute On (Volume Off)

1 : Volume Mute Off (Volume On)

06. Volume Control(Command : f)

▶ To adjust Volume .

Transmission

```
[k][f][ ][Set ID][ ][Data][Cr]
```

Data Min : 00H ~ Max : 64H
(Hexadecimal code)

Acknowledgement

```
[f][ ][Set ID][ ][OK][Data][x]
```

Data Min : 00H ~ Max : 64H

• Refer to 'Real data mapping' page A7.

● Transmission / Receiving Protocol

07. Contrast(Command : g)

▶ To adjust screen contrast.

You can also adjust the contrast in the Picture menu.

Transmission

```
[k][g][ ][Set ID][ ][Data][Cr]
```

Data Min : 00H ~ Max : 64H

• Refer to 'Real data mapping' as shown below.

Acknowledgement

```
[g][ ][Set ID][ ][OK][Data][x]
```

* Real data mapping

0 : Step 0

:

A : Step 10

:

F : Step 15

10 : Step 16

:

64 : Step 100

08. Brightness(Command : h)

▶ To adjust screen brightness.

You can also adjust the brightness in the Picture menu.

Transmission

```
[k][h][ ][Set ID][ ][Data][Cr]
```

Data Min : 00H ~ Max : 64H

• Refer to 'Real data mapping' as shown below.

Acknowledgement

```
[h][ ][Set ID][ ][OK][Data][x]
```

* Real data mapping

0 : Step

:

A : Step 10

:

F : Step 15

10 : Step 16

:

64 : Step 100

● Transmission / Receiving Protocol

09. Color(Command : i) (Video only)

- ▶ To adjust the screen color.
You can also adjust the color in the Picture menu.

Transmission

```
[k][i][ ][Set ID][ ][Data][Cr]
```

Data Min : 00H ~ Max : 64H
(Hexadecimal code)

- Refer to 'Real data mapping' page A7.

Acknowledgement

```
[l][ ][Set ID][ ][OK][Data][x]
```

Data Min : 00H ~ Max : 64H

10. Tint(Command : j) (Video only)

- ▶ To adjust the screen tint.
You can also adjust the tint in the Picture menu.

Transmission

```
[k][j][ ][Set ID][ ][Data][Cr]
```

Data Red: 00H ~ Green: 64H
(Hexadecimal code)

- Refer to 'Real data mapping' page A7.

Acknowledgement

```
[l][ ][Set ID][ ][OK][Data][x]
```

Data Red: 00H ~ Green: 64H

- * Tint Real data mapping
0 : Step -50
:
64 : Step 50

● Transmission / Receiving Protocol

11. Sharpness(Command : k) (Video only)

▶ To adjust the screen Sharpness.

You can also adjust the sharpness in the Picture menu.

Transmission

```
[k][k][ ][Set ID][ ][Data][Cr]
```

Data Min : 00H ~ Max : 64H
(Hexadecimal code)

- Refer to 'Real data mapping' page A7.

Acknowledgement

```
[k][ ][Set ID][ ][OK][Data][x]
```

Data Min : 00H ~ Max : 64H

12. OSD Select(Command : I)

▶ To control OSD on/off to the set.

Transmission

```
[k][I][ ][Set ID][ ][Data][Cr]
```

Data 0 : OSD Off 1 : OSD On

Acknowledgement

```
[I][ ][Set ID][ ][OK][Data][x]
```

Data 0 : OSD Off 1 : OSD On

13. Remote Lock /Key Lock (Command : m)

▶ To control Remote Lock on/off to the set.

This function, when controlling RS-232C, locks the remote control and the local keys.

Transmission

```
[k][m][ ][Set ID][ ][Data][Cr]
```

Data 0 : Off 1 : On

Acknowledgement

```
[m][ ][Set ID][ ][OK][Data][x]
```

Data 0 : Off 1 : On

● Transmission / Receiving Protocol

14 Balance(Command : t)

▶ To adjust the sound balance.

Transmission

```
[k][t][ ][Set ID][ ][Data][Cr]
```

Data Min : 00H ~ Max : 64H

(Hexadecimal code)

• Refer to 'Real data mapping' page A7.

Acknowledgement

```
[t][ ][Set ID][ ][OK][Data][x]
```

Data Min : 00H ~ Max : 64H

* Balance : L50 ~ R50

15. Color Temperature (Command : u)

▶ To adjust the screen color temperature.

Transmission

```
[k][u][ ][Set ID][ ][Data][Cr]
```

Data 0 : Normal

1 : Cool

2 : Warm

3 : User

Acknowledgement

```
[u][ ][Set ID][ ][OK][Data][x]
```

Data 0 : Normal

1 : Cool

2 : Warm

3 : User

● Transmission / Receiving Protocol

16. Abnormal state (Command : z)

▶ Abnormal State : Used to Read the power off status when Stand-by mode.

Transmission

```
[k][z][ ][Set ID][ ][Data][Cr]
```

Data FF : Read

- 0 : Normal (Power on and signal exist)
- 1 : No signal (Power on)
- 2 : Turn the monitor off by remote control
- 3 : Turn the monitor off by sleep time function
- 4 : Turn the monitor off by RS-232C function
- 6 : AC down
- 8 : Turn the monitor off by off time function
- 9 : Turn the monitor off by auto off function

Acknowledgement

```
[z][ ][Set ID][ ][OK][Data][x]
```

17. ISM mode(Command: j p)

▶ Used to select the afterimage preventing function.

Transmission

```
[j][p][ ][Set ID][ ][Data][Cr]
```

- Data
- 1H : Inversion
 - 2H : Orbiter
 - 3H : Orb.+Inv.
 - 4H : White Wash
 - 8H : Normal

Acknowledgement

```
[p][ ][Set ID][ ][OK][Data][x]
```

● Transmission / Receiving Protocol

18. Auto Configure(Command: j u)

- ▶ To adjust picture position and minimize image shaking automatically. it works only in RGB(PC) mode.

Transmission

```
[j][u][ ][Set ID][ ][Data][Cr]
```

Data 1 : To set

Acknowledgement

```
[u][ ][Set ID][ ][OK][Data][x]
```

19. Key(Command : m c)

- ▶ To send IR remote key code.

Transmission

```
[m][c][ ][Set ID][ ][Data][Cr]
```

Data Key code : Refer to page A18.

Acknowledgement

```
[c][ ][Set ID][ ][OK][Data][x]
```

● Transmission / Receiving Protocol

20. Tile Mode(Command : d d)

▶ Change a Tile Mode.

Transmission

[d][d][Set ID][Data][x]

Data	Description
00	Tile mode is off.
12	1 x 2 mode(column x row)
13	1 x 3 mode
14	1 x 4 mode
...	...
44	4 x 4 mode

* The data can not be set to 0X or X0 except 00.

Acknowledgement

[d][00][OK/NG][Data][x]

 Transmission / Receiving Protocol**21. Tile H Size(Command : d g)**

▶To set the Horizontal size.

Transmission

[d][g][][Set ID][][Data][x]

Data Min : 00H ~ Max : 64H

Acknowledgement

[g][][Set ID][][OK/NG][Data][x]

22. Tile V Size(Command : d h)

▶To set the Vertical size.

Transmission

[d][h][][Set ID][][Data][x]

Data Min : 00H ~ Max : 64H

Acknowledgement

[h][][Set ID][][OK/NG][Data][x]

● Transmission / Receiving Protocol

23. Tile ID Set(Command : d i)

▶ To assign the Tile ID for Tiling function .

Transmission

```
[d][i][Set ID][Data][x]
```

Data Min : 00H ~ Max : 10H
(Hexadecimal code)

Acknowledgement

```
[i][Set ID][OK/NG][Data][x]
```

24. Elapsed time return(Command : d l)

▶ To read the elapsed time.

Transmission

```
[d][l][Set ID][Data][x]
```

* The data is always FF(in Hex).

Acknowledgement

```
[l][Set ID][OK/NG][Data][x]
```

* The data means used hours.
(Hexadecimal code)

● Transmission / Receiving Protocol

25. Temperature value (Command : d n)

▶ To read the inside temperature value.

Transmission

```
[d][n][Set ID][Data][x]
```

* The data is always FF(in Hex).

Acknowledgement

```
[n][Set ID][OK/NG][Data][x]
```

* The data is 1 byte long in Hexadecimal.

26. Lamp fault Check(Command : d p)

▶ To check lamp fault.

Transmission

```
[d][p][Set ID][Data][x]
```

* The data is always FF(in Hex).

Acknowledgement

```
[p][Set ID][OK/NG][Data][x]
```

Data 0 : Lamp Fault

1: Lamp OK

How to connect

- ▶ Connect your wired remote control to Remote Control port on the Product.

Remote Control IR Code

▶ **Output waveform**

single pulse, modulated with 37.917KHz signal at 455KHz

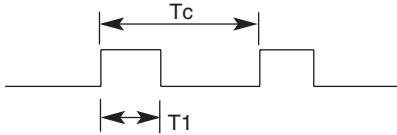

Carrier frequency

$$FCAR = 1/Tc = fosc/12$$

$$\text{Duty ratio} = T1/Tc = 1/3$$

▶ **Configuration of frame**

- 1st frame

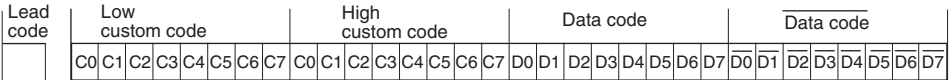

- Repeat frame

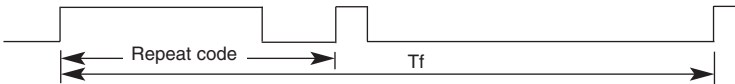

▶ **Lead code**

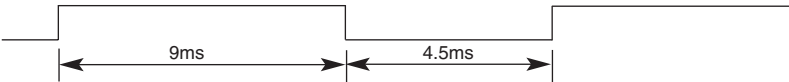

▶ **Repeat code**

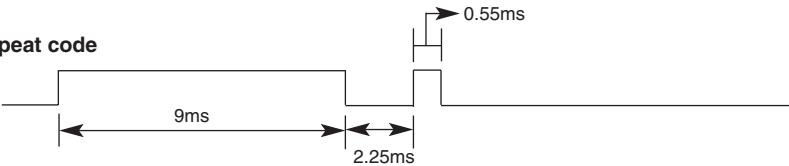

▶ **Bit description**

- Bit "0"

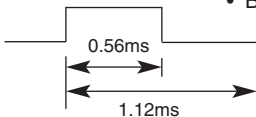

- Bit "1"

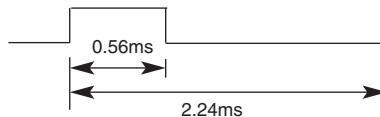

▶ **Frame interval : Tf**

- The waveform is transmitted as long as a key is depressed.



Tf=108ms@455KHz

Code(Hexa)	Function	Note
00	▲	R/C Button
01	▼	R/C Button
02	VOL(▶)	R/C Button
03	VOL(◀)	R/C Button
08	POWER ON/OFF	PR/C Button (Power On/Off)
C4	POWER ON	Discrete IR Code(Only Power On)
C5	POWER OFF	Discrete IR Code(Only Power On)
09	MUTE	R/C Button
98	AV	R/C Button
0B	INPUT	R/C Button
0E	SLEEP	R/C Button
43	MENU	R/C Button
5B	EXIT	R/C Button
6E	PSM	R/C Button
44	SET	R/C Button
10	Number Key 0	R/C Button
11	Number Key 1	R/C Button
12	Number Key 2	R/C Button
13	Number Key 3	R/C Button
14	Number Key 4	R/C Button
15	Number Key 5	R/C Button
16	Number Key 6	R/C Button
17	Number Key 7	R/C Button
18	Number Key 8	R/C Button
19	Number Key 9	R/C Button
5A	AV	Discrete IR Code(Input AV Selection)
BF	COMPONENT1	Discrete IR Code(Input COMPONENT1 Selection)
D4	COMPONENT2	Discrete IR Code(Input COMPONENT2 Selection)
D5	RGB PC	Discrete IR Code(Input RGB PC Selection)
D7	RGB DTV	Discrete IR Code(Input RGB DTV Selection)
C6	HDMI/DVI	Discrete IR Code(Input HDMI/DVI Selection)
79	ARC	R/C Button
76	ARC (4:3)	Discrete IR Code(Only 4:3 mode)
77	ARC (16:9)	Discrete IR Code(Only 16:9 mode)
AF	ARC (ZOOM)	Discrete IR Code(Only ZOOM1, ZOOM2 mode)
99	AUTO CONFIG	Discrete IR Code