



# Color Television OWNER'S MANUAL

Please read this manual carefully before operating your set.  
Retain it for future reference.  
Record model number and serial number of the set.  
See the label attached on the back cover and quote this  
information to your dealer when you require service.

## Safety Precautions

**WARNING : TO REDUCE THE RISK OF FIRE OR ELECTRIC SHOCK, DO NOT EXPOSE THIS PRODUCT TO RAIN OR MOISTURE.**

**CAUTION : TO REDUCE THE RISK OF ELECTRIC SHOCK, DO NOT REMOVE COVER(OR BACK). NO USER-SERVICEABLE PARTS IN SIDE. REFER SERVICING TO QUALIFIED SERVICE PERSONNEL.**

### Cleaning

Unplug this television receiver from the wall outlet before cleaning. Do not use liquid cleaners or aerosol cleaners. Use a damp cloth for cleaning. Do not use attachments not recommended by the television receiver manufacturer as they may cause hazards.

### Power Supply

This television receiver should be operated only from the type of power source indicated on the marking label. If you are not sure of the type of power supplied to your home, consult your television dealer or local power company.

### Installation

Do not use this television receiver near water, for example, near a bathtub, washbowl, kitchen sink, or laundry tub, in a wet basement, or near a swimming pool, etc.

Do not place this television receiver on an unstable cart, stand, or table. The television receiver may fall, causing serious injury to a child or an adult, and serious damage to the appliance. Use only with a cart or stand recommended by the manufacturer, or sold with the television receiver. Wall or shelf mounting should follow the manufacturer's instructions and should use a mounting kit approved by the manufacturer.

Slots and openings in the cabinet and the back or bottom are provided for ventilation, and to insure reliable operation of the television receiver, and to protect it from overheating. These openings must not be blocked or covered. The openings should

never be blocked by placing the television receiver on a bed, sofa, rug, or other similar surface. This television receiver should not be placed in a built-in installation such as a bookcase unless proper ventilation is provided.

It is recommended not to operate this unit near speakers or big metallic furnitures in order to keep their magnetism from disturbing colors purity (uniformity) on the screen.

### Wet Location Marking:

Apparatus shall not be exposed to dripping or splashing and no objects filled with liquids, such as vases, shall be placed on the apparatus.

### Use

Do not allow anything to rest on the power cord. Do not locate this television receiver where the cord will be abused by persons walking on it.

Do not overload wall outlets and extension cords as this can result in fire or electric shock.

Never push objects of any kind into this television receiver through cabinet slots as they may touch dangerous voltage points or short out parts that could result in a fire or electric shock.

Never spill liquid of any kind on the television receiver.

### Service

Do not attempt to service this television yourself as opening or removing covers may expose you to dangerous voltage or other hazards. Refer all servicing to qualified personnel.

## Writing Model And Serial Numbers

The serial number and model number are found on the back of this unit. The serial number is unique to this unit. You should record requested information here and retain this guide as a permanent record of your purchase. Please retain your purchase receipt as your proof of purchase.

Date of Purchase \_\_\_\_\_  
Dealer Purchased from \_\_\_\_\_  
Dealer Address \_\_\_\_\_  
Dealer Phone No. \_\_\_\_\_  
Model No. \_\_\_\_\_  
Serial No. \_\_\_\_\_

## CONTENTS

<b>Description of controls .....</b>	<b>4 ~ 5</b>
<b>Basic TV operation .....</b>	<b>6</b>
Turning on/off the TV .....	6
Selecting the on screen language .....	6
Memorizing Channels .....	7
Memorizing the Channels by AUTO PROGRAM .....	7
Memorizing the Channels by MANUAL PROGRAM .....	8
Selecting the Channel .....	8
Adjusting the Volume .....	8
<b>Various function .....</b>	<b>9</b>
Setting the Clock .....	9
Setting the Off timer.....	9
Setting the On timer.....	9
Setting the Sleep Time .....	10
Auto Off .....	10
Game (some models).....	11
Key Lock.....	11
Favorite channel memory.....	12
Adjusting the Fine.....	12
<b>Picture control .....</b>	<b>13</b>
Enjoying the Eye Function (some models) .....	13
Auto Picture Control .....	13
Adjusting the Picture.....	14
XD (some models).....	14
<b>Sound control .....</b>	<b>15</b>
Enjoying the Stereo/SAP Broadcast (some models) .....	15
Auto Sound Control.....	15
Turbo Sound (some models).....	16
X-WAVE(Wireless Sound) (some models) .....	16
AVL (Auto Volume Leveler) (some models) .....	17
Adjusting the balance (some models) .....	17
Adjusting the treble (some models).....	17
Adjusting the Bass (some models).....	17
<b>Closed caption function (some models) .....</b>	<b>18</b>
Using Closed Captions .....	18
Operating the Caption and Text .....	19
<b>Antenna Connections .....</b>	<b>20</b>
<b>Connection of external equipment (some models).....</b>	<b>21 ~ 22</b>
<b>Connecting DVD player (some models) .....</b>	<b>23</b>
<b>Troubleshooting check list.....</b>	<b>Back cover</b>

## Description of controls

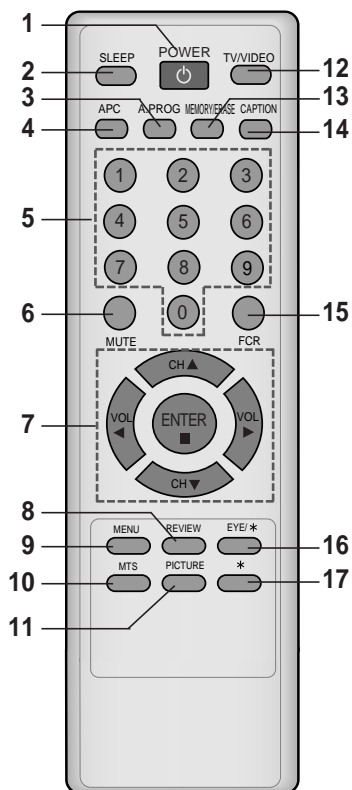

1. **POWER BUTTON (or ON/OFF,  $\phi$ /1)**  
Refer to "Turning on/off the TV".
2. **SLEEP BUTTON**  
To set the desired sleep time.
3. **A. PRGO (Auto program) BUTTON**  
To memorize channels by AUTO PROGRAM.
4. **APC (Auto Picture Control) BUTTON**  
To adjust the factory preset pictures corresponding to the lighting around.
5. **NUMBER BUTTONS**  
To select the desired channel directly.
6. **MUTE BUTTON**  
To mute the sound. Again to restore the muted sound.
7. **CH UP/DOWN ( $\blacktriangle$ / $\blacktriangledown$ ) BUTTONS**
  - To select the desired channel.
  - To select the desired menu item when menu is displayed on the screen.
- VOLUME UP/DOWN ( $\blacktriangleleft$ / $\blacktriangleright$ ) BUTTONS**
  - To increase or decrease volume level.
  - To enter or adjust the selected menu when menu is displayed on the screen.
- ENTER ( $\blacksquare$ ) BUTTON**
  - To exit from the displayed menu.
  - To memorize the adjusted menu.
  - To recall the current TV mode (by remote control only).
8. **REVIEW BUTTON (some models)**  
To return to the previous channel.
9. **MENU BUTTON**  
To display on screen menus.
10. **MTS BUTTON (some models)**  
To listen to the MTS sound.
11. **PICTURE BUTTON**  
To display picture modes one by one.
12. **TV/VIDEO BUTTON**  
To select TV, VIDEO or COMPONENT mode.
13. **MEMORY/ERASE BUTTON (some models)**  
To memorize or erase the desired channel.

This is a simplified representation of front panel.

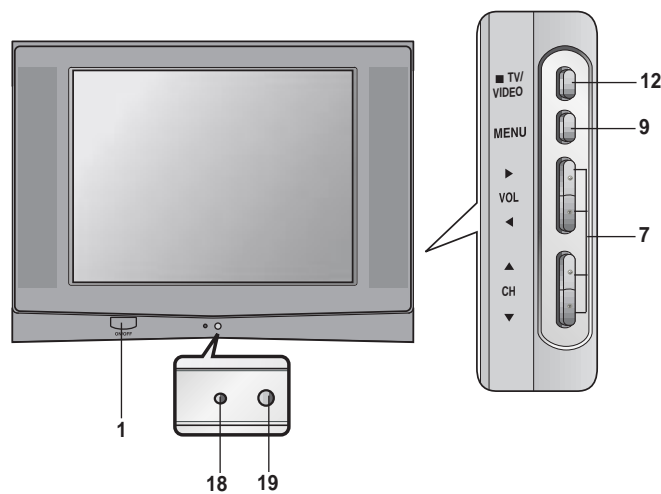

**14. CAPTION BUTTON (some models)**

To select the CAPTION mode.  
Refer to "Closed caption function".

**15. FCR (Favorite Channel Review) BUTTON**

To select the favorite channel.  
Refer to "Favorite channel memory".

**16. EYE/\* BUTTON (some models)**

To switch on or off eye picture.  
Refer to "Enjoying the Eye Function".

\* : No function.

17. \* : No function.

**18. STAND BY INDICATOR (STAND BY)**

Illuminates red when the TV is in standby mode.  
Refer to "Turning on/off the TV".

**19. REMOTE CONTROL SENSOR**

**Note: Fitting Batteries in the Remote Control Unit**

- Open the battery compartment cover on the back side and insert the batteries with correct polarity.
- Apply two 1.5V batteries of AAA type. Don't mix the used batteries with new batteries.

## Basic TV operation

Before operating your TV, make sure the following instructions have been completed.

- Your TV has been connected to an antenna or a cable system.
- Your TV has been plugged in a power outlet.
- In this manual, the OSD (On Screen Display) may be different from your TV's because it is just an example to help you with the TV operation.

### Turning on/off the TV

Press the **POWER** (or **ON/OFF**) button on the set. At this time, the set switches to standby mode and the standby indicator lights up in red.

To switch the TV on from standby mode, press the TV/VIDEO, CH ▲/▼ button on the set or POWER, TV/VIDEO, CH ▲/▼ or number button on the remote control.

A channel number will be displayed on the screen. The on-screen display will disappear after a few seconds.

Press the **POWER** button on the remote control. It reverts to standby mode.

To switch the TV off, press the **POWER** button on the set.

### Selecting the on screen language

1. Press the **MENU** button and then ▲ / ▼ button until the menu is displayed as shown right.
2. Press the ► and then ▲/▼ button to select **Language**.
3. Press the ► and then use ▲ / ▼ button to select the desired language.

From this point on, the on-screen display will be presented in the language of your choice.

4. Repeatedly press the **MENU** button to exit.

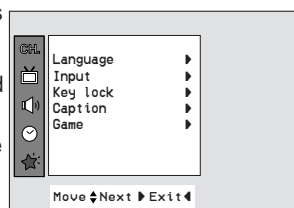

## Memorizing Channels

This is the function to memorize all the active channels in your area before you can use the TV.

There are two ways of memorizing channels. You can use either.

One is called **AUTO PROGRAM** and the other is called **MANUAL PROGRAM**.

In **AUTO PROGRAM** the TV will memorize the channels in ascending order. If there are additional channels you want to add or delete, you can manually add or delete those channels.

### Memorizing the Channels by AUTO PROGRAM

**AUTO PROGRAM** searches and memorizes all the active channels in your area then you can select the desired channel with the ▲ / ▼ buttons.

#### Using the A.PROG button

You can conveniently perform AUTO PROGRAM using the **AUTOPRG.** button on the remote control.

1. Press the **AUTOPRG.** button.
2. Press the ► or **AUTOPRG.** button.  
The AUTO PROGRAM starts now.

If you want to stop auto programming, press the **ENTER (■)** button. Only the channels searched up to that time are memorized.

**Notes :** • If the programmed signal has poor quality, memorize again in the **Auto prog.**.

- AUTO PROGRAM stores all receivable channels regardless of receiving signal (RF, Cable).
- If channels of general wireless TV and cable TV are duplicated, press the number buttons (0 ~ 9) to change as .

Channels of general wireless TV ↔ Channels of Cable TV

#### Using the MENU button

1. Press the **MENU** button and then ▲ / ▼ button until the menu is displayed as shown right.
2. Press the ► and then ▲ / ▼ button to select **Auto prog.**.
3. Press the ► button to enter the **Auto prog.** mode.
4. The AUTO PROGRAM starts now.

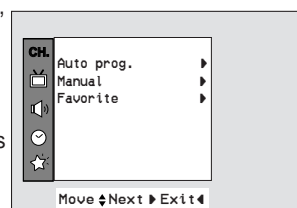
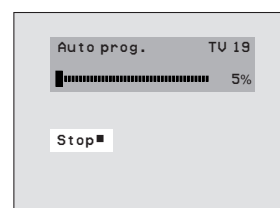
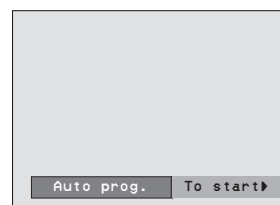

## Basic TV operation

### Memorizing the Channels by MANUAL PROGRAM

#### Using the MEMORY/ERASE button

You can conveniently perform MANUAL PROGRAM using the **MEMORY / ERASE** button on the remote control.

1. Press the **▲/▼** or **NUMBER** buttons to select the channel number you want to memorize or erase.
2. Press the **MEMORY/ERASE** button to select **Memory** or **Erase**.  
The on screen display appears as shown right.



#### Using the MENU

1. Press the **MENU** button and then **▲/▼** button until the menu is displayed as shown right.
2. Press the **▶** and then use **▲/▼** button to select **Manual**.
3. Press the **▶** button and then use **▲/▼** button to select **Channel**.
4. Press the **▶** button and then use **▲/▼** button to select the channel number you want to memorize or erase.
5. Press the **◀** button and then use **▲/▼** button to select **Memory**.
6. Press the **▶** button and then **▲/▼** to select **On** or **Off**.
7. Repeatedly press the **MENU** button to exit.

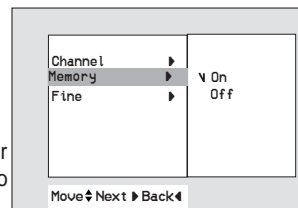
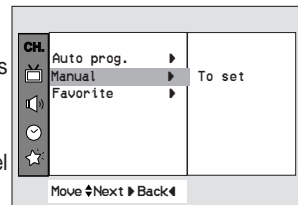

### Selecting the Channel

Press the **▲/▼** button to conveniently select the upper or lower channel then the channel being viewed, or **NUMBER** buttons to directly select the desired channel.

### Adjusting the Volume

Press the **▶** button to increase the volume level or **◀** button to decrease the volume level.

To mute the sound, Press the **MUTE** button.

The word **Mute** is displayed.

It's convenient when you get the telephone calls.

To restore the muted sound, press the **MUTE** button again or **VOL ◀/▶** button.

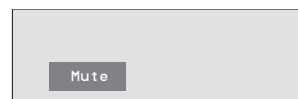
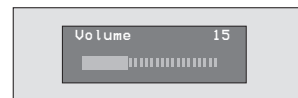



## Various function

### Setting the Clock

Before setting the on/off timer, first you should set the current time.

1. Press the **MENU** button and then **▲ / ▼** button until the menu is displayed as shown right.
2. Press the **▶** and then **▲ / ▼** button to select **Clock**.
3. Press the **▶** button and then press the **▲ / ▼** button to adjust the hour.
4. Press the **▶** button and then press the **▲ / ▼** button to adjust the minute.
5. Repeatedly press the **MENU** button to exit.

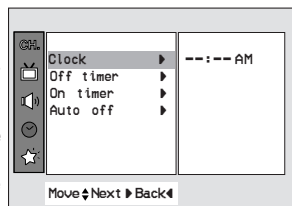

### Setting the Off Timer

This is the function to automatically switch the TV to standby mode at a preset time.

1. Press the **MENU** button and then **▲ / ▼** button until the menu is displayed as shown right.
2. Press the **▶** and then **▲ / ▼** button to select **Off timer**.
3. Press the **▶** button and then press the **▲ / ▼** button to adjust the hour.
4. Press the **▶** button and then press the **▲ / ▼** button to adjust the minute.
5. **On/Off** is used to activate or deactivate preset on/off times. Press the **▶** and then **▲ / ▼** button to select **Off** or **On**.
6. Repeatedly press the **MENU** button to exit.

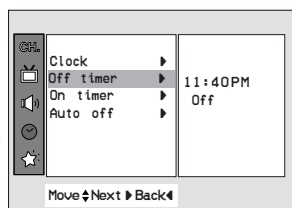

**Note:** If the same time is set for the on time and off time, only the off time operates.

### Setting the On Timer

This is the function to automatically turn the TV on at a preset time and channel.

1. Press the **MENU** button and then **▲ / ▼** button until the menu is displayed as shown right.
2. Press the **▶** and then **▲ / ▼** button to select **On timer**.
3. Press the **▶** and then use **▲ / ▼** button to adjust the hour.
4. Press the **▶** and then use **▲ / ▼** button to adjust the minute.
5. Press the **▶** and then use **▲ / ▼** button to select the desired channel among the memorized channels in auto program.
6. Press the **▶** and then use **▲ / ▼** button to adjust the desired volume level.
7. **On/Off** is used to activate or deactivate preset on/off times. Press the **▶** button and then use **▲ / ▼** button to select **Off** or **On**.
8. Repeatedly press the **MENU** button to exit.

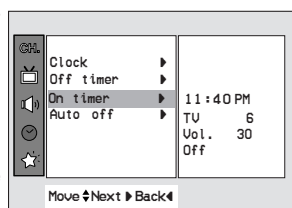

**Notes:**

- If you don't press any button within 2 hours after turning on the TV set by ON TIMER function, the set will be automatically switched back to standby mode.
- TV must be in standby mode for the On timer to work.

## Various function

### Setting the Sleep Time

You don't have to remember to switch the TV to standby mode before you go to sleep. The sleep timer automatically turns the TV off after the preset time elapses.

Press the **SLEEP** button to select the desired sleep time.

Each time you press this button, the sleep time is displayed one by one as shown below. The timer begins to count down from the number of minutes selected.

▶ --- → **10** → **20** → **30** → **60** → **90** → **120** → **180** → **240**



**Notes:** • After a few seconds, the desired sleep time will disappear and be operated automatically.

- To view the remaining sleep time, press the **SLEEP** button once and the remaining sleep time will be displayed.
- To cancel the sleep time, select the **Sleep ---** mode by using the **SLEEP** button.

### Auto Off

If there is no input signal, the TV is switched to standby mode automatically in 10 minutes.

1. Press the **MENU** button and then **▲** / **▼** button until the menu is displayed as shown right.
2. Press the **▶** and then **▲** / **▼** button to select **Auto off**.
3. Press the **▶** and then **▲** / **▼** button to select **On** or **Off**.
4. Repeatedly press the **MENU** button to exit.

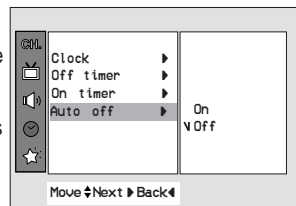

## Game (some models)

You can enjoy the TV game with this set.

1. Press the **MENU** button and then **▲ / ▼** button until the menu is displayed as shown right.
2. Press the **▶** and then **▲ / ▼** button to select **Game**.
3. Press the **▶** button to enter the game mode.
4. Press the **▲ / ▼** button to select the desired game.
5. Press the **ENTER (■)** button to repeatedly start a game.
6. Repeatedly press the **MENU** button to exit game mode.  
If you want to return the game list, press the **▲ / ▼** button.  
For further information, refer to the game manual.

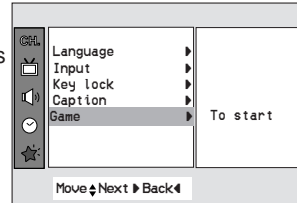

## Key Lock

The TV can be set so that the remote control is needed to control it. This feature can be used to prevent unauthorized viewing.

1. Press the **MENU** button and then **▲ / ▼** button until the menu is displayed as shown right.
2. Press the **▶** and then **▲ / ▼** button to select **Key lock**.
3. Press the **▶** button and then **▲ / ▼** button to select **On** or **Off**.
4. Repeatedly press the **MENU** button to exit.

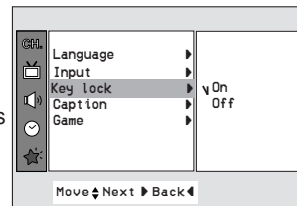

- Notes :**
- With the key lock on, the display **Key lock** appears on the screen if any button on the front panel is pressed while viewing the TV.
  - This programmed to remember which option it was last set to even if you switch the TV from standby mode.

## Various function

### Favorite channel memory

Favorite channel memory is a convenient feature that lets you quickly scan up to 8 channels of your choice without having to wait for the TV to scan through all the in-between channels.

1. Press the **MENU** button and then **▲ / ▼** button until the menu is displayed as shown right.
2. Press the **▶** and then **▲ / ▼** button to select **Favorite**.
3. Press the **▶** button and then use **▲ / ▼** button to select a favorite channel position.
4. Use the **◀ / ▶** button to select the desired channel number.
5. Repeat steps 3 to 4.
6. Repeatedly press the **MENU** button to exit.

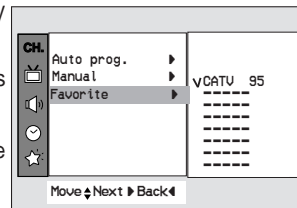

To select the favorite channel, repeatedly press the **FCR** (Favorite Channel Review) button. Eight channels programmed appear on the screen one by one.

### Adjusting the Fine

This function is to adjust the picture to stable condition when it is poor, for example, a horizontal stripe, twisted picture or no color in broadcasting.

1. Press the **MENU** button and then **▲ / ▼** button until the menu is displayed as shown right.
2. Press the **▶** and then **▲ / ▼** button to select **Manual**.
3. Press the **▶** and then **▲ / ▼** button to select **Fine**.
4. Press the **▶** button to enter the **Fine** mode.
5. Press the **◀ / ▶** button to tune the desired picture condition.
6. Press the **ENTER (■)** button to memorize.
7. Repeatedly press the **MENU** button to exit.

- Notes :**
- To release the memorized fine tuning, program again the fine-tuned channel by **AUTO PROGRAM** or **MANUAL PROGRAM**.
  - If the finely tuned channel is memorized, the color of the channel number changes to yellow.

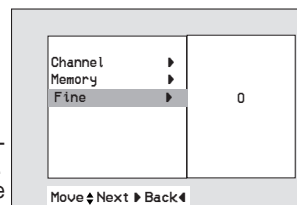
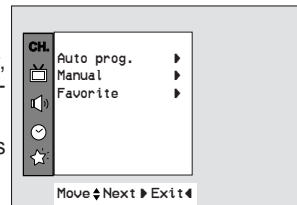

## Picture control

### Enjoying the Eye Function (some models)

The set will automatically adjust the picture according to the surrounding conditions with the display **Magic eye**.

1. Press the **EYE** button on the remote control.  
The display **Magic eye** appears and the picture is adjusted.
2. Press the **EYE** button again to switch the Eye function off.

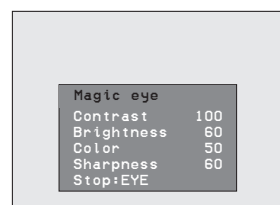

### Auto Picture Control

You can select picture modes programmed at factory as you prefer.

#### Using the APC button

1. Press the **APC** button.
2. Press the **APC** button to select **Magic eye**(some models), **Clear**, **Optimum**, **Soft** or **User**.
3. Press the **ENTER**(**■**) button to exit.



#### Using the MENU button

1. Press the **MENU** button and then **▲** / **▼** button until the menu is displayed as shown right.
2. Press the **▶** and then **▲** / **▼** button to select **APC**.
3. Press the **▶** button to enter the **APC** mode.
4. Press the **▲** / **▼** button to select **Magic eye**(some models), **Clear**, **Optimum**, **Soft** or **User**.
5. Repeatedly press the **MENU** button to exit.

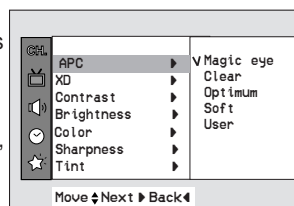

## Picture control

### Adjusting the Picture

This is the function to manually adjust the desired picture levels (**Contrast, Brightness, Color, Sharpness, Tint**) of the screen as you like. If the picture you set is not satisfactory, you can select a factory preset picture. In the broadcasting system PAL-M/N, the picture item **Tint** is not displayed.

1. Press the **MENU** button and then **▲ / ▼** button until the menu is displayed as shown right.
2. Press the **▶** and then **▲ / ▼** button to select the desired picture mode.
3. Press the **▶** button.
4. Press the **◀ / ▶** button to adjust the level.  
The level of displayed is adjusted.
5. Repeatedly press the **MENU** button to exit.

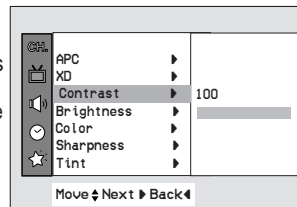
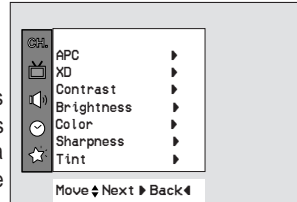

### XD (some models)

XD is LG Electronic's unique picture improving technology to display a real HD source through an advanced digital signal processing algorithm.

1. Press the **MENU** button and then **▲ / ▼** button until the menu is displayed as shown right.
2. Press the **▶** and then **▲ / ▼** button to select **XD**.
3. Press the **▶** button and then **▲ / ▼** button to select **On** or **Off**.
4. Press the **MENU** button to exit.

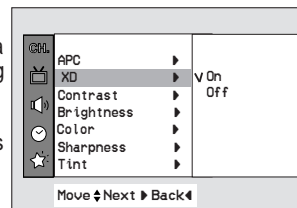

Note : When selecting APC options, XD is automatically change to Off.

## Sound control

### Enjoying the Stereo/SAP Broadcast (some models)

This TV set can receive MTS stereo programs and any SAP (Secondary Audio Program) that accompanies the stereo program, as the system to be transmitted one additional sound signal as well as the original one. MTS function doesn't operate in the video mode.

#### Using the MTS Button

1. Press the **MTS** button to select your desired MTS mode.  
Each time you press this button, the **MONO**, **STEREO** or **SAP** mode appears in turn.
2. Press the **ENTER** (■) button to exit.

#### Notes:

- Stereo or SAP can only be received if the TV station transmits those signals, even though you have selected **STEREO** or **SAP**.
- Mono sound is automatically received if the broadcast is only in Mono; even though **STEREO** or **SAP** has been selected.
- Select **MONO** if you want to listen to mono sound in remote fringe areas during stereo/SAP broadcasting.

### Auto Sound Control

You can enjoy the best sound without any special adjustment because this TV set automatically adjusts the sound appropriate to viewing program character by self-intelligence.

1. Press the **MENU** button and then ▲ / ▼ button until the menu is displayed as shown right.
2. Press the ► and then the ▲ / ▼ button to select **DASP**.
3. Press the ► and then the ▲ / ▼ button to select **Flat**, **Music**, **Movie**, **Sports** or **User**.
4. Repeatedly press the **MENU** button to exit.

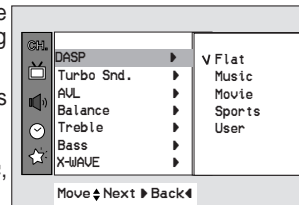

## Sound control

### Turbo Sound (some models)

With this function sound will be more emphasized and amplified than normal sound. You can enjoy the Turbo sound so much better than normal sound.

1. Press the **MENU** button and then use ▲ / ▼ button to select the Sound menu.
2. Press the ► and then ▲ / ▼ button to select **Turbo Snd.**
3. Press the ► and then ▲ / ▼ button to select **On** or **Off**.
4. Press the **MENU** button to exit.

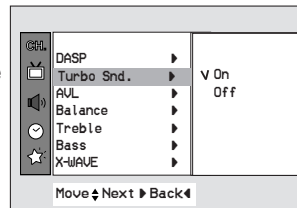

### X-wave (Wireless Sound) (some models)

You can also listen to the sound through the FM receiver.

1. Press the **MENU** button and then ▲ / ▼ button until the menu is displayed as shown right.
2. Press the ► and then ▲ / ▼ button to select **X-WAVE**.
3. Press the ► and then ▲ / ▼ button to select **Set Freq.**
4. Press the ► button to tune in a frequency on the X-wave menu.
5. Use the number **0** to **9** or press the ◀ / ▶ button to match the TV's frequency and the FM receiver's.

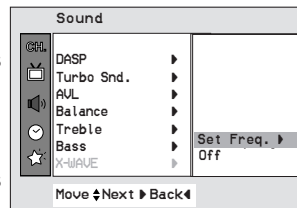

#### Note:

1. If the reception is poor or weak, select a different frequency.
2. For best results, there should be no more than 5m(16.4ft) between the TV and FM Receiver.
3. In certain areas, the FM transmitter ability may be weak, such as near a broadcast tower.
4. The reception sensitivity may depend on the kinds of receiver (FM radio).

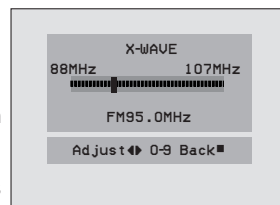



## AVL (Auto Volume Leveler) (some models)

AVL automatically keeps on an equal volume level even if you change channels.

### Using the MENU Button

1. Press the **MENU** button and then ▲/▼ button the until the menu is displayed as shown right.
2. Press the ► and then ▲/▼ button to select **AVL**.
3. Press the ► and then ▲/▼ button to select **On** or **Off**.
4. Repeatedly press the **MENU** button to exit.

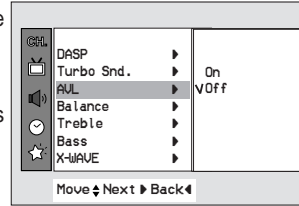

## Adjusting the balance (some models)

1. Press the **MENU** button and then ▲/▼ button the until the menu is displayed as shown right.
2. Press the ► and then ▲/▼ button to select **Balance**.
3. Press the ► and then ◀/▶ button to adjust the balance level.
4. Repeatedly press the **MENU** button to exit.

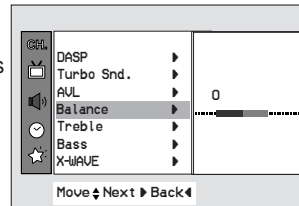

## Adjusting the treble (some models)

This function is to increase or decrease treble.

1. Press the **MENU** button and then ▲/▼ button until the menu is displayed as shown right.
2. Press the ► and then ▲/▼ button to select **Treble**.
3. Press the ► button to enter the **Treble** mode.
4. Press the ◀/▶ button to adjust the treble level.
5. Repeatedly press the **MENU** button to exit.

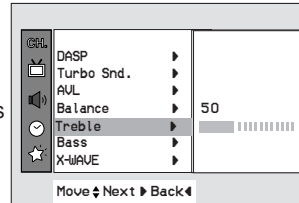

## Adjusting the bass (some models)

This function is to increase or decrease bass.

1. Press the **MENU** button and then ▲/▼ button until the menu is displayed as shown right.
2. Press the ► and then ▲/▼ button to select **Bass**.
3. Press the ► button to enter the **Bass** mode.
4. Press the ◀/▶ button to adjust the bass level.
5. Repeatedly press the **MENU** button to exit.

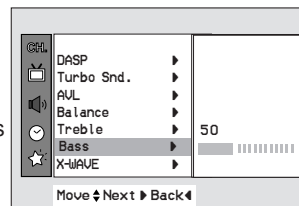

## Closed caption function (some models)

Closed captioning is a process which converts the audio portion of a television program into written words, which then appear on the television screen in a form similar to subtitles. Closed captions allow viewers to read the dialogue and narration of television programs.

### Using Closed Captions

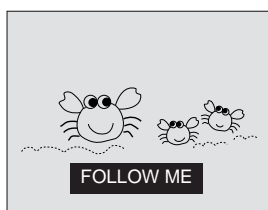

Captions are the subtitles of the dialogue and narration of television programs. For prerecorded programs, program dialogue can be arranged into captions in advance. It's possible to caption a live program by using a process called "real-time captioning", which creates captions instantly. Real-time captioning is normally done by professional reporters using a machine shorthand system and computer for translation into English.

Captioning is an effective system for the hearing-impaired, and it can also aid in teaching language skills.

- The picture at left shows a typical caption.

### Caption Tips

- Not all TV broadcasts include closed caption signals.
- Sometimes TV stations broadcast two different caption signals on the same channel. By selecting MODE 1 or MODE 2, you can choose which signal you view. MODE 1 is usually the signal with the captions, while MODE 2 might show demonstration or programming information.
- Your TV might not receive caption signals normally in the following situations.

1] Poor reception conditions are encountered:



#### ■ IGNITION:

Picture may flutter, drift, suffer from black spots or horizontal streaking. Usually caused by interference from automobile ignition systems, neon lamps, electrical drills and other electrical appliances.



#### ■ GHOSTS:

Ghosts are caused when the TV signal splits and follows two paths. One is the direct path and the other is reflected off tall buildings, hills or other objects. Changing the direction or position of the antenna may improve reception.



#### ■ SNOW:

If your receiver is located at the weak, fringe area of a TV signal, your picture may be marred by small dots. It may be necessary to install a special antenna to improve the picture.

- 2] An old, bad or illegally recorded tape is played.
- 3] Strong, random signals from a car or airplane interfere with the TV signal.
- 4] The signal from the antenna is weak.
- 5] The program wasn't captioned when it was produced, transmitted or taped.

## Using the Text Function

Text services give a wide variety of information on all kind of subjects (ex. captioned program lists, weather forecasts, stock exchange topics, news for hearing-impaired---) through the full TV screen. But not all stations offer text services, even though they might offer captioning.

**Note:** In the event you receive a poor signal, an empty black box may appear and disappear, even when the text mode is selected. This is normal function in such an event.

## Operating the Caption and Text

### Using the CAPTION button

1. Press the **CAPTION** button.
2. Press the **CAPTION** button to select **OFF, Mode 1, Mode 2, Text 1** or **Text 2**.
3. Press the **ENTER (■)** button to exit.

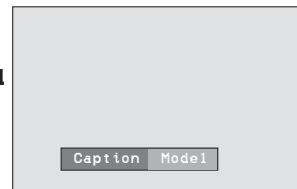

### Using the MENU button

1. Press the **MENU** button and then use **▲ / ▼** button to select the Special menu.
2. Press the **▶** and then **▲/▼** button to select **Caption**.
3. Press the **▶** button and then use **▲/▼** button to select **Off, Mode 1, Mode 2, Text 1** or **Text 2**.
4. Repeatedly press the **MENU** button to exit.

**Note:** This TV is programmed to remember which mode it was last set to, even if you turn the TV off.

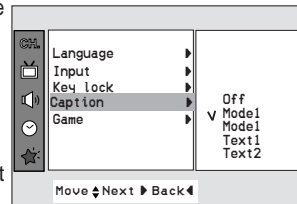

## Antenna Connections

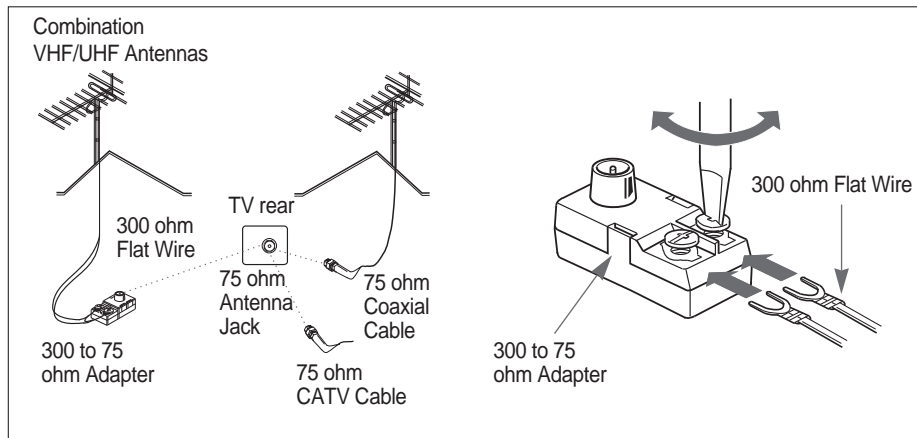

### Connecting an Outdoor Antenna

For the best reception, we recommend you use an outdoor antenna. Severely weathered antennas and antenna cables can reduce the signal quality. Before connecting it, necessarily inspect them. Any service center can explain the various outdoor antennas available to you.

#### 300 Ohm Flat Wire

1. Connect the 300 ohm flat wire to screws on the 300 ohm to 75 ohm adapter.
2. Push the end of 300 ohm to 75 ohm adapter into 75 ohm antenna jack.

#### 75 Ohm Coaxial Cable

1. Connect the 75 ohm coaxial cable directly to the 75 ohm antenna jack.

### Connecting a CATV Cable

If you subscribe to a CATV system, change the antenna connection as described below.

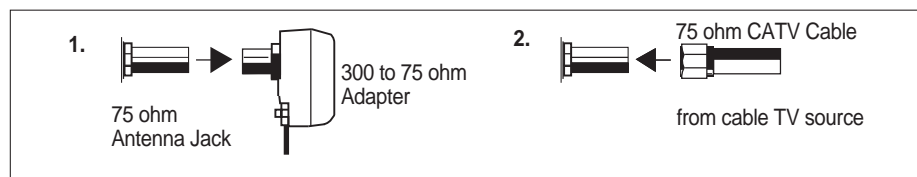

1. Remove the 300 to 75 ohm adapter or the cable from the set if attached.
2. Connect the CATV cable (75 ohm coaxial cable) to the 75 ohm antenna jack.

## Connection of external equipment (some models)

You can connect additional equipment, such as VCRs, camcorders etc. to your set. Here shown may be somewhat different from your set. These are an example drawing of typical jack layout.

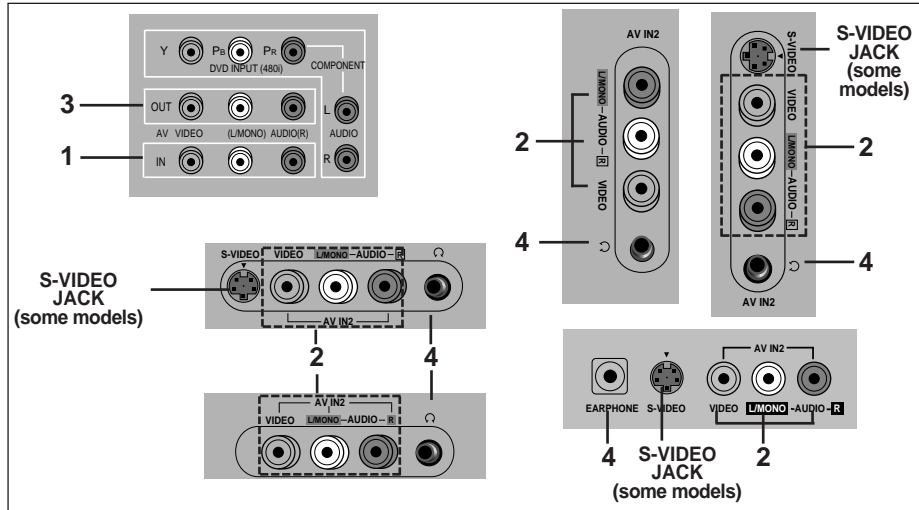

- IN 1 JACKS** : Connect external equipment outputs (VCR, LASER DISC, CAMCORDER) to these inputs. Press the **TV/VIDEO** button to select **AV1** or **AV**.
- IN 2 JACKS** : Connect external equipment outputs (VCR, LASER DISC, CAMCORDER) to these inputs. Press the **TV/VIDEO** button to select **AV2** or **S-VIDEO**.
- OUT JACKS**: Connect external equipment inputs (VCR, Audio amplifier) to these outputs for recording or monitoring the selected program.
- ⊘ / EARPHONE JACK** (some models) : In some models, this jack is located on the front or side of TV.

**Note:** This TV is programmed to remember which mode it was last set to, even if you turn the TV off.

### Connecting AUDIO/VIDEO IN Jacks

- Connect the audio/video output jacks of the VCR to **IN 1(AV)** jacks on the side or back of TV.  
If you connect the audio jack only, you can't hear the sound from the TV.
- Press the **TV/VIDEO** button to select **AV1**.  
**Note:** In some stereo models, if you connect the audio/video output jacks of the VCR to the **IN 2 (AV)** jacks on the front or side of TV, select **AV2**.
- Press the **PLAY** button on the VCR.  
The video playback is on the TV screen.

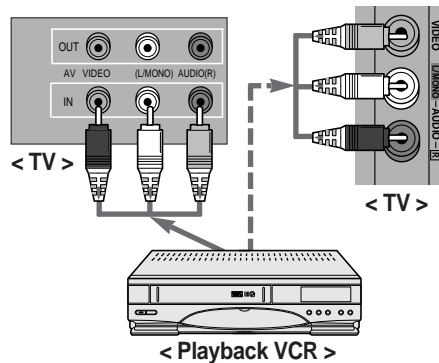

**Note:** In case of MONO VCR, connect the output jack of VCR to the **AUDIO L/MONO IN** jack of TV so that the sound can be heard from both speakers. If you connect it to the **AUDIO R IN** jack of TV the sound is heard only from right speaker.

## Connection of external equipment (some models)

**Note:** In some mono models, when the input jacks on the front panel and back panel are connected to external equipments at the same time, the input jacks on the front panel have priority over the input jacks on the back panel of the TV.

### Connecting the S-VHS VCR (some models)

1. Connect the S-VHS output jack of the VCR to the **S-VIDEO** jack on the side or back of TV.
2. Connect the audio/video output jacks of the VCR to the **IN 2(A/V)** jacks on the front or side of TV.
3. Press the **TV/VIDEO** button to select **S-VIDEO**.
4. Press the **PLAY** button on the VCR.  
The video playback is visible on the TV screen.

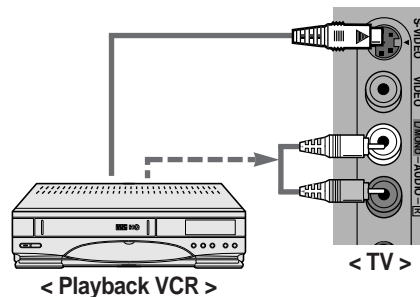

### VCR Recording (some models)

1. Connect the audio/video input jacks of the recording VCR to the **OUT (A/V)** jacks on the back.
2. Select the program number on the TV.
3. Set the recording VCR to record.

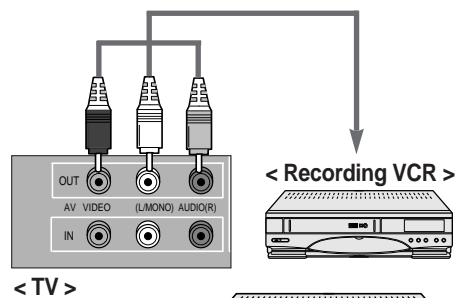

### Recording a program from connected other equipment (some models)

1. Connect the output jacks of the playback VCR to the **IN 1(A/V)** jacks on the side or back of TV.
2. Connect the input jacks of the recording VCR to the **OUT (A/V)** jacks on the back of TV.
3. Press the **TV/VIDEO** button to select **AV1**.  
If you connect it to the **IN 2 (A/V)** jacks on the side of TV, you should select **AV2**.
4. Press the **PLAY** button on the playback VCR and set the recording VCR to record.

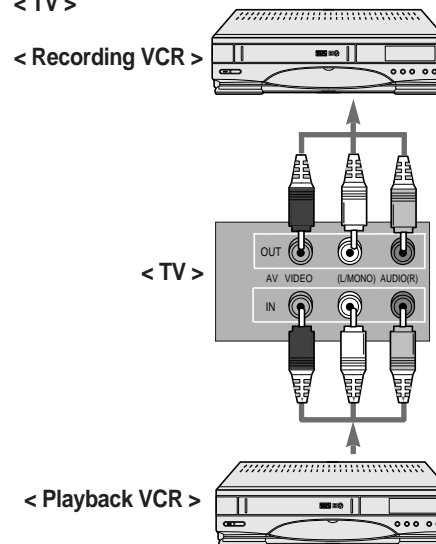

## Connecting DVD player (some models)

- Connect component DVD inputs to Y, Pb, PR(480i) and audio **IN** to audio(L/R) ports.
- **Note:** This TV is programmed to remember which mode it was last set to, even if you turn the TV off.

### 1.How to connect

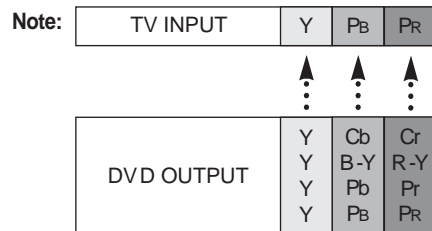
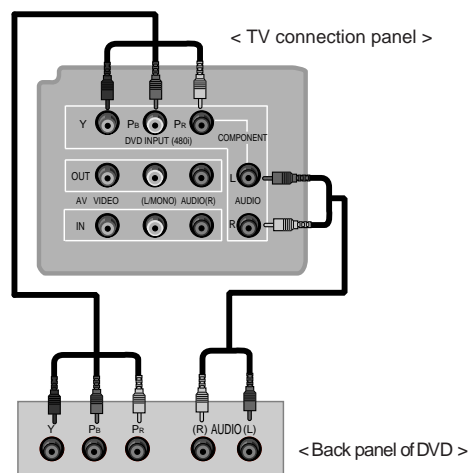

### 2.How to use

- Turn the set on and press the **TV/VIDEO** button on the remote control or **TV/VIDEO** button on the front panel to select **COMPONENT**.
- Try this after turning on the DVD set.

## Troubleshooting check list

### SYMPTOMS

No power

No picture or sound

Poor picture but good sound

Poor reception

Lines in picture

Ghosts (multiple images)

Remote control does not work.

Cannot tune desired channel.

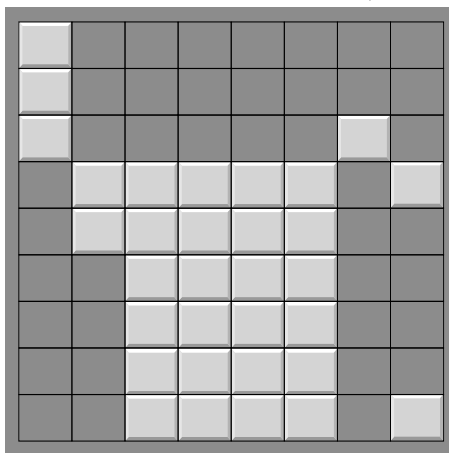
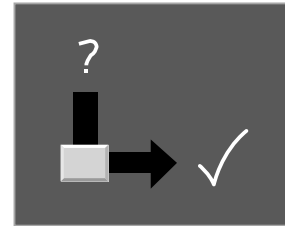

### CHECK THESE THINGS

- Is power cord plugged in?
- Is television turned on?
- Check batteries in remote control.
- Try another channel (station trouble).
- Check antenna connectings.
- Check for local interference.
- Adjust the antenna.
- Adjust the picture control.
- Program channel using AUTO PROGRAM.

