



LG

website:<http://us.lgservice.com>

MICROWAVE OVEN

OWNER'S MANUAL & COOKING GUIDE

PLEASE READ THIS OWNER'S MANUAL THOROUGHLY BEFORE INSTALLING OR OPERATING YOUR OVEN.

LMH1017CVW
LMH1017CVB
LMH1017CVST

P/NO.: 3828W5A8035

TABLE OF CONTENTS

SAFETY	3-4	UNDERSTANDING YOUR	
Precautions to Avoid Possible Exposure		CONVECTION OVEN	17
to Excessive Microwave Energy	3	Tips for Convection Cooking	17
Grounding Instructions	3	Precautions	17
Important Safety Instructions	4	USING YOUR CONVECTION OVEN	18-21
UNDERSTANDING YOUR		Convection	18
MICROWAVE OVEN	5-10	Convection Cooking Guide	19
Specifications	5	Convection Baking Table	20
Installation	5	Meat Roasting Table for Convection Cooking	21
Part and Accessories	6	UNDERSTANDING YOUR	
Control Panel	6	COMBINATION OVEN	22
Cooking Comparison Guide	7	Tips for Combination Cooking	22
Cookware Guide	8	Helpful Hints for Combination Cooking	22
How to Use Accessories	9	Precautions	22
Tips for Microwave Cooking	10	Combination Roast	22
Cleaning	10	USING YOUR COMBINATION OVEN	23-25
USING YOUR MICROWAVE OVEN	11-16	Combination Roast Cooking Guide	23
Microwave	11	Combination Bake	24
2-Stage Timed Cooking	11	Combination Bake Cooking Guide	24
Microwave Power Levels	11	Combination Auto Cook	25
Child Lock	12	Combination Auto Cooking Guide	25
Kitchen Timer	12	HEATING/REHEATING GUIDE	26
Ez-On	12	FRESH VEGETABLE GUIDE	27
More/Less	12	TROUBLESHOOTING	28-30
Custom Set	13	Questions and Answers	28-29
Sensor Cooking Operation Instruction	14	Before Calling for Service	30
Sensor Cook	14	WARRANTY	Inside back cover
Sensor Reheat	15		
Sensor Popcorn	15		
Q-Defrost	15		
Auto Defrost	16		
Auto Defrost Table	16		

Thank you for purchasing a LG microwave oven.

Please record the model number and serial number of this unit for future reference. These's are located on the back of the oven. We also suggest you record the details of your contact with LG (LG Electronics U.S.A., Inc.) concerning this unit.

Staple your receipt here for proof of purchase.

Model No: _____

Serial No: _____

Dealer: _____

Dealer Phone No: _____

Customer Relations
 LG Electronics U.S.A., Inc.
 Service Division Bldg. #3
 201 James Record Rd.
 Huntsville, AL 35824-0126

SAFETY

PRECAUTIONS TO AVOID POSSIBLE EXPOSURE TO EXCESSIVE MICROWAVE ENERGY

- **Do not attempt to operate this oven with the door open**, since open-door operation can result in harmful exposure to microwave energy. It is important not to defeat or tamper with the safety interlocks.
- **Do not place any object between the oven front face and the door**, or allow soil or cleaner residue to accumulate on sealing surfaces.
- **Do not operate the oven if it is damaged.** It is particularly important that the oven door closes properly and that there is no damage to the:
 - door (bent),
 - hinges and latches (broken or loosened),
 - door seals and sealing surfaces.
- **The oven should not be adjusted or repaired** by anyone except properly qualified service personnel.

GROUNDING INSTRUCTIONS

This appliance must be grounded. In the event of an electrical short circuit, grounding reduces the risk of electric shock by providing an escape wire for the electric current. This appliance is equipped with a cord having a grounding wire and a grounding plug. The plug must be plugged into an outlet that is properly installed and grounded.

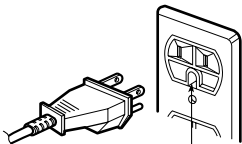

Ensure proper ground exists before use

⚠ WARNING ⚠

Improper grounding can result in a risk of electric shock. Consult a qualified electrician if the grounding instructions are not completely understood, or if doubt exists as to whether the appliance is properly grounded.

1. If it is necessary to use an extension cord, use only a 3-wire extension cord that has a 3-blade grounding plug and a 3-slot receptacle that will accept the plug on the appliance.

The marked rating of the extension cord shall be equal to or greater than the electrical rating of the appliance. or

2. Do not use an extension cord. If the power supply cord is too short, have a qualified electrician or serviceman install an outlet near the appliance.

NOTES:

1. A short power-supply cord is provided to reduce the risks resulting from becoming entangled in or tripping over a longer cord.
2. May be used if care is exercised in their use.
3. If a long cord or extension cord is used, (1) the marked electrical rating of the cord set or extension cord should be at least as great as the electrical rating of the appliance, (2) the extension cord must be a grounding-type 3-wire cord, and (3) the longer cord should be arranged so that it will not drape over the countertop or tabletop where it can be pulled on by children or tripped over accidentally.

SAFETY

IMPORTANT SAFETY INSTRUCTIONS

The safety instructions below will tell you how to use your oven to avoid harm to yourself or damage to your oven.

WARNING - To reduce the risk of burns, electric shock, fire, injury to persons, or exposure to excessive microwave energy:

1. Read all instructions before using the appliance.
2. Read and follow the specific **PRECAUTIONS TO AVOID POSSIBLE EXPOSURE TO EXCESSIVE MICROWAVE ENERGY** found on page 3 of this manual.
3. This appliance must be grounded. Connect only to properly grounded outlet. See **GROUNDING INSTRUCTIONS** found on page 3 of this manual.
4. Install or locate this appliance only in accordance with the provided installation instructions.
5. Some products such as whole eggs and sealed containers – for example, closed glass jars can explode and should not be heated in this oven.
6. Use this appliance only for its intended use as described in the manual. Do not use corrosive chemicals or vapors in this appliance. This type of oven is specifically designed to heat, cook, or dry food. It is not designed for industrial or laboratory use.
7. As with any appliance, close supervision is necessary when used by children.
8. Do not operate this appliance if it has a damaged cord or plug, if it is not working properly, or if it has been damaged or dropped.
9. This appliance should be serviced only by qualified service personnel. Contact the nearest authorized service facility for examination, repair, or adjustment.
10. Do not cover or block any openings on the appliance.
11. Do not store this appliance outdoors. Do not use this product near water – for example, near a kitchen sink, in a wet basement, near a swimming pool, or similar location.
12. Do not immerse cord or plug in water.
13. Keep cord away from heated surfaces.
14. Do not let cord hang over the edge of a table or counter.
15. When cleaning surfaces of door and oven that come together on closing the door, use only mild, nonabrasive soaps or detergents applied with a sponge or soft cloth.
16. To reduce the risk of fire in the oven cavity.
 - a. Do not over cook food. Carefully attend appliance when paper, plastic, or other combustible materials are placed inside the oven to facilitate cooking.
 - b. Remove wire twist-ties from paper or plastic bags before placing bag in oven.
 - c. If materials inside the oven ignite, **KEEP OVEN DOOR CLOSED**, turn oven off, and disconnect the power cord or shut off power at the fuse or circuit breaker panel.
 - d. Do not use the cavity for storage purposes. Do not leave paper products, cooking utensils, or food in the cavity when not in use.
17. Do not heat any type of baby bottles or baby food. Uneven heating may occur and could cause personal injury.
18. Avoid heating small-necked containers such as syrup bottles.
19. Avoid using corrosive and vapors, such as sulfide and chloride.
20. Liquids heated in certain shaped containers (especially cylindrical-shaped containers) may become overheated. The liquid may splash out with a loud noise during or after heating or when adding ingredients (instant coffee, etc.), resulting in harm to the oven and possible injury. In all containers, for best results, stir the liquid several times before heating. Always stir liquid several times between reheatings.
21. Liquids such as water, coffee, or tea are able to be overheated beyond the boiling point without appearing to be boiling. Visible bubbling or boiling when the container is removed from the microwave oven is not always present. **THIS COULD RESULT IN VERY HOT LIQUIDS SUDDENLY BOILING OVER WHEN THE CONTAINER IS DISTURBED OR A SPOON OR OTHER UTENSIL IS INSERTED INTO THE LIQUID.**

To reduce the risk of injury to persons;

 - Do not overheat the liquid.
 - Stir the liquid both before and halfway through heating it.
 - Do not use straight-sided containers with narrow necks.
 - After heating, allow the container to stand in the microwave oven for a short time before removing the container.
 - Use extreme care when inserting a spoon or other utensil into the container.

SAVE THESE INSTRUCTIONS

UNDERSTANDING YOUR MICROWAVE OVEN

SPECIFICATIONS

Power Supply		120 V AC,60 Hz
Rated Power	Microwave	1,400 W
Consumption	Convection	1,350 W
Power Output	Microwave	1,000W*
	Convection	1,350W
Frequency		2,450 MHz
Rated Current	Microwave	12.5 A
	Convection	11 A
Overall Dimensions (WxHxD)		20 ¹ / ₈ " x 12 ¹ / ₄ " x 19 ⁵ / ₁₆ "
Oven Cavity Dimensions (WxHxD)		14" x 8 ¹ / ₂ " x 13 ¹³ / ₁₆ "
Capacity of Oven Cavity		1.0 Cu.Ft.

*IEC 60705 RATING STANDARD

Specifications subject to change without prior notice.

INSTALLATION

A. Circuits

For safety purposes this oven must be plugged into a 20 Amp circuit. No other electrical appliances or lighting circuits should be on this line. If in doubt, consult a licensed electrician.

B. Voltage Warning

The voltage used at the wall receptacle must be the same as specified on the oven name plate located on the front or on the side of the control panel of the oven. Use of a higher voltage is dangerous and may result in a fire or other type of accident causing oven damage. Low voltage will cause slow cooking. In case your microwave oven does not perform normally in spite of proper voltage, remove and reinsert the plug.

C. Placement of the Oven

Your microwave oven can be placed easily in your kitchen, family room, or anywhere else in your home. Place the oven on a flat surface such as a kitchen countertop or a specially designed microwave oven cart at least 100 cm (39.4 inches) from floor. Do not place oven above a gas or electric range. Free air flow around the oven is important. Allow at least 4 inches of space at the top, sides, and back of the oven for proper ventilation.

NOTES:

- Never place the turntable in the oven upside down.

D. Do not block the air vents

All air vents should be kept clear during cooking. If air vents are covered during oven operation the oven may overheat. In this case, a sensitive thermal safety device automatically turns the oven off. The oven will be inoperable until it has cooled sufficiently.

E. Radio interference

1. Microwave oven operation may interfere with TV or radio reception.
2. When there is interference, it may be reduced or eliminated by taking the following measures:
 - a. Clean the door and the sealing surfaces of the oven.
 - b. Reorient the receiving antenna of radio or TV.
 - c. Relocate the microwave oven in relation to the TV or radio.
 - d. Move the microwave oven away from the receiver.
 - e. Plug the microwave oven into a different outlet so that microwave oven and receiver are on different branch circuits .
 - f. This oven should not be built in cabinetry or mounted on a shelf above an electric or gas range.

UNDERSTANDING YOUR MICROWAVE OVEN

PARTS AND ACCESSORIES

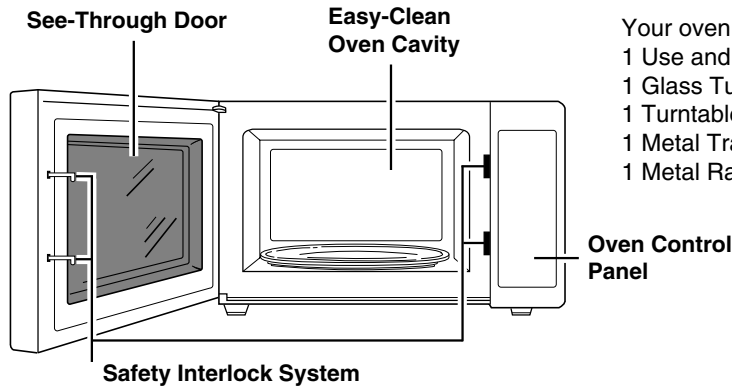

Your oven comes with the following accessories:

- 1 Use and Care Guide (Owner's Manual)
- 1 Glass Turntable
- 1 Turntable Rotating Ring
- 1 Metal Tray
- 1 Metal Rack

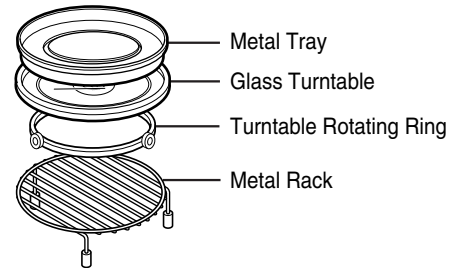

CONTROL PANEL

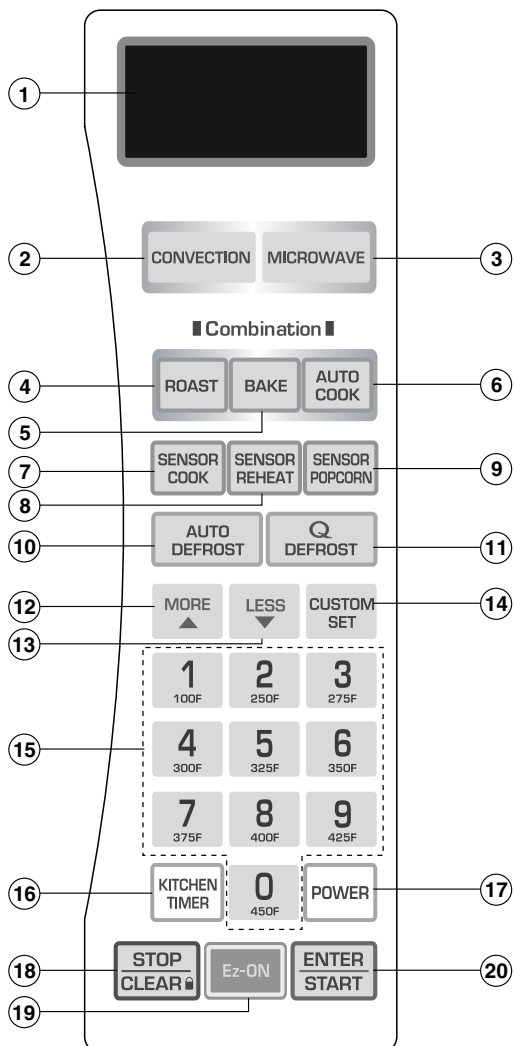

Note: Always leave the turn table in the oven. It is not always necessary to use the tray and rack.

1. **DISPLAY.** The display includes a clock and indicators that tell you time of day, cooking time settings, and cooking functions selected.
2. **CONVECTION.** Touch this button to cook foods on convection mode.
3. **MICROWAVE.** Touch this button to cook foods on microwave mode, and to set cooking time and power level.
4. **ROAST.** Touch this button to roast foods on combination mode.
5. **BAKE.** Touch this button to bake foods on combination mode.
6. **AUTO COOK.** Touch this pad to cook foods automatically on combination mode.
7. **SENSOR COOK.** Touch this button to cook most of your favorite foods without entering cooking time or power level.
8. **SENSOR REHEAT.** Touch this button to reheat foods without entering cooking time and power level.
9. **SENSOR POPCORN.** Touch this button to cook popcorn automatically.
10. **AUTO DEFROST.** Meat, Poultry, Fish, Bread. Touch this pad to select food type and defrost food by weight.
11. **Q DEFROST.** This pad provides you with the rapid defrosting method for 1.0 pounds frozen foods.
12. **MORE.** Touch this pad to add ten seconds of cooking time each time you press it.
13. **LESS.** Touch this pad to subtract ten seconds of cooking time each time you press it.
14. **CUSTOM SET.** Touch this button to change the oven's default settings for sound, clock, scroll speed, and Lbs/kg.
15. **NUMBER.** Touch number pads to enter cooking time, power level, quantities, or weights.
16. **KITCHEN TIMER.** Touch this button to use as a kitchen timer without operating the oven.
17. **POWER.** Touch this pad to set a cook power.
18. **STOP/CLEAR:** Touch this button to stop the oven or to clear entries and to engage or disengage the child lock. See page 12.
19. **Ez-ON:** You can extend cooking time in multiples of 30 seconds by repeatedly touching this pad during cooking.
20. **ENTER/START.** Touch this button to start entries.

UNDERSTANDING YOUR MICROWAVE OVEN

COOKING COMPARISON GUIDE

Cooking with your new oven offers a wide variety of food preparation options: microwave cooking, convection cooking, and combination cooking.

Microwave cooking uses very short, high-frequency radio waves. The movement of the microwaves through the food generates heat and cooks most foods faster than regular methods while retaining their natural texture and moisture. Microwave cooking heats food directly, not the cookware or the interior of the oven.

Reheating is easy and defrosting is particularly convenient because less time is spent in food preparation.

Convection cooking constantly circulates heated air around the food, creating even browning and sealed in flavor by the constant motion of hot air over the food surfaces.

Combination cooking combines microwave energy with convection to cook with speed and accuracy, while browning and crisping to perfection.

You can use microwave cooking, convection cooking, or combination cooking to cook by time. Simply preset the length of cooking time desired and your oven turns off automatically.

The following guide shows at a glance the difference between microwave, convection, and combination cooking.

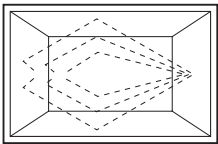
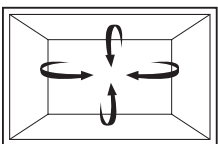
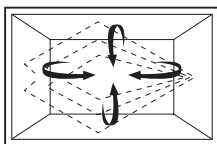
	MICROWAVE	CONVECTION	COMBINATION
COOKING METHOD	 <p>Microwave energy is distributed evenly throughout the oven for fast, thorough cooking of food.</p>	 <p>Hot air circulates around food to produce browned exteriors and sealed in juices.</p>	 <p>Microwave energy and convection heat combine to shorten the cooking time of regular ovens, while browning and sealing in juices.</p>
HEAT SOURCE	Microwave energy.	Circulating heated air.	Microwave energy and circulating heated air.
BENEFITS	<ul style="list-style-type: none"> • Fast, high efficiency cooking. • Oven and surroundings do not get hot. • Easy clean-up. 	<ul style="list-style-type: none"> • Aids in browning and seals in flavor. • Cooks some foods faster than regular ovens. 	<ul style="list-style-type: none"> • Shortened cooking time from microwave energy. • Browning and crisping from convection heat.
<p>Read this guide to learn the many different things your Microwave/Convection/Combination Oven can do. You will find a wide variety of cooking methods and programs designed to suit your lifestyle.</p>			

UNDERSTANDING YOUR MICROWAVE OVEN

COOKWARE GUIDE

Microwave Cooking

Most heat-resistant, non-metallic cookware is safe for use in your microwave oven.

However, to test cookware before using, follow these steps:

1. Place the empty cookware in the microwave oven.
2. Measure 1 cup of water in a glass measuring cup and place it in the oven beside the cookware.
3. Microwave on 100% power for 1 minute. If the dish is warm, it should not be used for microwave cooking.

Convection Cooking

- Metal Pans are recommended for all types of baked products, but especially where browning or crusting is important.
- Dark or dull finish metal pans are best for breads and pies because they absorb heat and produce a crisper crust.
- Shiny aluminum pans are better for cakes, cookies, or muffins because these pans reflect heat and help produce a light, tender crust.
- Glass or glass-ceramic casserole or baking dishes are best suited for egg and cheese recipes due to the cleanability of glass.

Combination Cooking

- Glass or glass-ceramic baking containers are recommended. Be sure not to use items with metal trim as it may cause arcing (sparking) with oven wall or oven shelf, damaging the cookware, the shelf, or the oven.
- Heat-resistant plastic microwave cookware (safe to 450° F) may be used, but is not recommended for foods that require crusting or all around browning, because plastic is a poor conductor of heat.

COOKWARE	MICROWAVE	CONVECTION	COMBINATION
Heat-Resistant Glass, Ceramic Glass	Yes	Yes	Yes
Ceramics, China	Yes (Do not use china with gold or silver trim.)	Yes	Yes
Metal Cookware	No	Yes	No
Non Heat-Resistant Glass	No	No	No
Microwave-Safe Plastic	Yes	No	Yes*
Plastic Wrap, Wax Paper	Yes	No	No
Paper Products	Yes	No	No
Straw, Wicker, and Wood	Yes	No	No

*Use only microwave cookware that is safe to 450° F

UNDERSTANDING YOUR MICROWAVE OVEN

HOW TO USE ACCESSORIES



Glass Turntable



Metal Tray

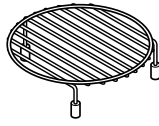

Metal Rack

○ Possible to use

⊙ Recommended method

X Do not use

	MICROWAVE	CONVECTION	COMBINATION
	⊙	○	○
	X	○	○
	X	⊙	⊙
	X	⊙	X
	X	⊙	⊙

Notes :

- Do not operate the oven when it is empty except preheating.
- Always use the Rotating Ring and Turn Table when using this oven on the Day setting.

UNDERSTANDING YOUR MICROWAVE OVEN

TIPS FOR MICROWAVE COOKING

BROWNING

Meat and poultry with high fat content that are cooked for 10 or 15 minutes or longer will brown lightly. Foods cooked a shorter time can be brushed with a browning agent, such as Worcestershire sauce, soy sauce, or barbecue sauce.

COVERING

A cover traps heat and steam and causes the food to cook more quickly. Use a lid or microwave-safe plastic wrap with one corner folded back to vent the excess steam. Lids on glass casseroles can become hot during cooking. Handle carefully. Waxed paper will prevent the food from splattering in the oven and help retain heat. When warming bread items, use waxed paper, napkins, or paper towels. To absorb extra moisture, wrap sandwiches and fatty foods in paper towels.

SPACING

Arrange individual foods, such as baked potatoes, cupcakes, and hors d'oeuvres in a circle and at least 1 inch apart. This will help the food cook more evenly.

STIRRING

Stirring blends flavors and redistributes the heat in foods. Always stir from the outside toward the center of the dish. Food at the outside of the dish heats first.

TURNING

Large foods, such as roasts and whole poultry, should be turned so that the top and bottom cook evenly. Also turn over chicken pieces and chops.

CLEANING

Wipe the oven inside and outside with a soft cloth and a mild detergent solution. Then rinse and wipe dry. This should be done weekly or more often, if needed. Never use cleaning powders or rough pads. Excessive oil splatters on the inside top will be difficult to remove if left for many days. Wipe splatters with a wet paper towel, especially after cooking chicken or bacon.

REMOVABLE PARTS

The metal tray, metal rack, glass turntable and turntable roller rest are removable. They should be hand-washed in warm (not hot) water with a mild detergent and a soft cloth. Once they are clean, rinse well and dry with a soft cloth. Never use cleaning powders, steel wool, or rough pads.

ARRANGEMENT

Do not stack food. Arrange in a single layer in the dish for more even cooking. Because dense foods cook more slowly, place thicker portions of meat, poultry, fish, and vegetables toward the outside of the dish.

TESTING FOR DONENESS

Because foods cook quickly in a microwave oven, you need to test frequently for doneness.

STANDING TIME

Depending on density, food often needs to stand from 2 to 15 minutes either in or outside the oven after cooking power shuts off. After removing it from the oven, cover food during standing time to retain heat.

Remove most foods when they are slightly undercooked and they will finish cooking during standing time. The internal temperature of food will rise about 10° F during standing time.

SHIELDING

To prevent some portions of rectangular or square dishes from overcooking, you may need to shield them with small strips of aluminum foil to block the microwaves. You can also cover poultry legs and wing tips with foil to keep them from overcooking.

Always keep foil at least 1 inch from oven walls to prevent arcing.

PIERCING

Pierce the shell, skin, or membrane of foods before cooking to prevent them from bursting. Foods that require piercing include yolks and whites of eggs, hot dogs, clams, oysters, and whole vegetables, such as potatoes and squash.

- Removable parts may be cleaned at the sink. Be careful not to chip or scratch the edges as this may cause them to break during use.
- The metal tray and glass turntable may also be cleaned in a dishwasher.
- The turntable roller rest should be cleaned regularly.

SPECIAL CARE

For best performance and safety, the inner door panel and the oven front frame should be free of food or grease buildup. Wipe often with a mild detergent, then rinse and wipe dry. Never use cleaning powders or rough pads.

After cleaning the control panel, touch STOP/CLEAR to clear any entries that might have been entered accidentally while cleaning the panel.

USING YOUR MICROWAVE OVEN

MICROWAVE

This function allows you to cook food for a desired time. And in order to give you the best results, there are 10 power level settings in addition to HI-POWER because many food need slower cooking (at less than HI-POWER).

Example: To cook food on 80% Power (Power8) for 5 minutes 30 seconds

1. Touch **STOP/CLEAR**.
2. Touch **MICROWAVE**
ENTER COOKING TIME shows in the display.
3. Enter 5 minutes 30 seconds by touching **[5]**, **[3]**, **[0]**. *TOUCH START OR POWER LEVEL* shows in the display.
4. Touch **POWER**.
POWER 100 ENTER POWER LEVEL 0 TO 10 shows in the display.
5. Touch **[8]**.
To select power level 80%. *POWER 80 TOUCH START* shows in the display.
6. Touch **ENTER/START**.

When cooking is complete, four short tones will sound. The word *COOK END* shows in the display window. Then the oven shuts itself off.

NOTE:

If you do not select the power level, the oven will operate at power HIGH. To set HI-POWER cooking, skip steps 4 and 5 above.

2 STAGE TIMED COOKING

For Two-Stage cooking, repeat microwave steps 2 through 5 on this page before touching the START pad for additional Time and Power program you want to add.

Auto Weight Defrost can be programmed before the first stage to defrost first and then cook.

MICROWAVE POWER LEVELS

Your microwave oven is equipped with ten power levels to give you maximum flexibility and control over cooking. The table below will give you some idea of which foods are prepared at each of the various power levels.

*The table below shows the power level settings for your oven.

MICROWAVE POWER LEVEL TABLE

Power Level	Use
10 (High)	*Boiling water. *Making candy. *Cooking poultry pieces, fish, & vegetables. *Cooking tender cuts of meat. *Whole poultry.
9	*Reheating rice, pasta, & vegetables.
8	*Reheating prepared foods quickly. *Reheating sandwiches.
7	*Cooking egg, milk and cheese dishes. *Cooking cakes and breads. *Melting chocolate.
6	*Cooking veal. *Cooking whole fish. *Cooking puddings and custard.
5	*Cooking ham, whole poultry and lamb. *Cooking rib roast and sirloin tip.
4	*Thawing meat, poultry and seafood.
3	*Cooking less tender cuts of meat. *Cooking pork chops and roast.
2	*Taking chill out of fruit. *Softening butter.
1	*Keeping casseroles and main dishes warm. *Softening butter and cream cheese.
0	* Standing time. * Independent.

USING YOUR MICROWAVE OVEN

CHILD LOCK

This is a unique safety feature that prevents unwanted oven operation such as used by children. Once the CHILD LOCK is set, no cooking can take place.

To set the child lock



Touch and hold **STOP/CLEAR** until **LOCKED** appears in the display and two beeps are heard. If the time of day was already set, the time of day will return to the display window.

If the CHILD LOCK was already set and you touched another cooking pad, the word **LOCKED** shows in the display. Then you can cancel the CHILD LOCK according to below procedure.

To cancel the child lock



Touch and hold **STOP/CLEAR** pad until **LOCKED** disappears in the display.

After the CHILD LOCK is turned off, the time of day will return to the display window. The oven will operate normally.

KITCHEN TIMER

You can use the Timer of your oven for purposes other than food cooking.

Example : To set the timer 3 minutes.



1. Touch **STOP/CLEAR**.



2. Touch **KITCHEN TIMER**.
ENTER TIME IN MIN AND SEC shows in the display.



3. Touch **[3], [0], [0]**.
TOUCH START shows in the display.



4. Touch **ENTER/START** pad.

Ez-ON

A time-saving pad, this simplified control lets you quickly set and start microwave cooking without the need to touch ENTER/START.

NOTE:

If you touch Ez-ON, it will add 30 seconds up to 3 minutes 30 seconds; after 3 minutes 30 seconds, every touch will add 1 minute up to 99 min 59 seconds.

Example : To set Ez-ON cooking 2 minutes.



1. Touch **STOP/CLEAR**.



2. Touch **Ez-ON** 4 times.
The oven begins cooking and display shows time counting down.

MORE/LESS

By using the MORE or LESS keys, MICROWAVE program can be adjusted to cook food for a longer or shorter time. Pressing MORE will add 10 seconds to the cooking time each time you press it. Pressing LESS will subtract 10 seconds of cooking time each time you press it.

USING YOUR MICROWAVE OVEN

CUSTOM SET

CUSTOM SET provides five modes which make using your microwave oven quite handy. You can select CLOCK SETTING, SOUND ON/OFF, CLOCK ON/OFF, SCROLL SPEED and LBS/KG.

Example 1 : To turn off Sound of beeper.



1. Touch **STOP/CLEAR**.
2. Touch **CUSTOM SET**.
Five modes show in the display repeatedly. You can set them according to your intention:
3. Touch **[2]**. *SOUND ON TOUCH 1 OFF TOUCH 2* shows in the display.
4. Touch **[2]**. *SOUND OFF* shows in the display and the current time will be displayed.

NOTE: To turn beep sound back on, repeat steps 1 - 3 then touch number 1.

Example 2 : To set the units.



1. Touch **STOP/CLEAR**.
2. Touch **CUSTOM SET**.
Five modes show in the display repeatedly. You can set them according to your intention:
3. Touch **[5]**. *LBS TOUCH 1 KG TOUCH 2* shows in the display.
4. Touch **[2]**. *KG* shows in the display and the current time will be displayed.

CUSTOM SET FUNCTION TABLE

NUMBER	FUNCTION	CHOICE
1	CLOCK SETTING	Enter Time of Day
2	SOUND ON / OFF	Sound On or Sound Off
3	CLOCK ON / OFF	Clock On or Clock Off
4	SCROLL SPEED	Slow, Normal, or Fast
5	LBS / KG	Lbs or Kg

NOTE: When the power cord is first plugged in, the default setting are Sound ON, Clock ON, Normal Speed and LBS.

USING YOUR MICROWAVE OVEN

SENSOR COOKING OPERATION INSTRUCTION

A sensor detects steam from the food and automatically adjusts cook time for the best cooking results. It's easy and convenient—the oven will guide you, step by step, to cook or reheat foods. The Sensor Menu, with many popular food choices, is preprogrammed to cook or reheat food perfectly everytime.

For more information about Sensor Cooking Programs, see the Sensor Reheat & Cook Tables on pages 14 & 15. These tables provide specific instructions for cooking and heating a variety of foods.

- The Sensor Cooking system works by detecting a build-up of vapor.
- Make sure the door remains closed.
- Once the vapor is detected, two beeps will sound.
- Opening the door or touching the STOP/CLEAR before the vapor is detected will abort the process. The oven will stop.
- Before using Sensor Cooking, make sure the glass turntable is dry, to assure the best results.

Categories:

- Sensor Cook
- Sensor Reheat
- Sensor Popcorn

SENSOR COOK

SENSOR COOK allows you to cook most of your favorite foods without having to select cooking times and power levels. The oven automatically determines required cooking times for each food item. SENSOR COOK has 5 food categories.

Example :To cook frozen entrée.



1. Touch **STOP/CLEAR**.
2. Touch **SENSOR COOK**.
Then *SELECT MENU 1 TO 5* shows in the display.
3. Touch **[3]**.
FROZEN ENTREE shows in the display.

The oven will cook food automatically by sensor system.

SENSOR COOK TABLE

CATEGORY	DIRECTION	AMOUNT
Potato	Pierce each potato with a fork and place on the oven tray around the edge, at least one inch apart. After cooking, allow to stand for 5 minutes.	1~4 medium approx. 8 to 10 oz. each
Rice	Place rice and twice as much liquid (water or chicken or vegetable stock) in a 2-quart microwavable dish. Cover with plastic wrap. When cooking is complete, allow 10 minutes standing time. Stir for fluffier rice.	1/2~2 cups Use medium or long grain rice. Cook instant rice according to directions on the package.
Frozen Entrée	Remove from outer display package. Slit cover. If not in microwave-safe container, place on plate, cover with plastic wrap, and vent. After cooking, allow to stand for 5 minutes.	10 to 21 oz.
Fresh Vegetable	Prepare as desired, wash, and leave residual water on the vegetables. Place in an appropriately-sized microwave container, cover with plastic wrap and vent. After cooking, allow to stand for 5 minutes.	1~4 cups
Frozen Vegetable	Remove from package, rinse off frost under running water. Place in an appropriately-sized microwave container, cover with plastic wrap and vent. After cooking, allow to stand for 5 minutes.	1~4 cups

NOTE: If you open the door or press STOP/CLEAR during sensing, the process will be canceled.

USING YOUR MICROWAVE OVEN

SENSOR REHEAT

This feature allows you to reheat precooked room-temperature or refrigerated foods without selecting cooking times and power levels. This feature has 3 categories: Dinner Plate, Soup/Sauce, Casserole. See the table below for more information.

Example :To reheat casserole.

1. Touch **STOP/CLEAR**.

2. Touch **SENSOR REHEAT**.
SELECT MENU 1 TO 3 shows in the display.

3. Touch **[3]**.
To select *CASSEROLE* menu.

The oven will reheat food automatically by sensor system.

SENSOR REHEAT TABLE

Category	Direction	Amount
Dinner plate	Place foods to be heated on dinner plate or similar dish. Cover with plastic wrap and vent. After cooking, allow to stand for 3 minutes.	Approx. 1/2 -1lbs
Soup/Sauce	Place foods to be heated in an appropriately sized microwave container. Cover with plastic wrap and vent. After cooking, stir and allow to stand for 3 minutes.	1-4 cups
Casse- role	Cover dish containing the casserole with plastic wrap and vent. After cooking, stir and allow to stand for 3 minutes.	1-4 cups

SENSOR POPCORN

SENSOR POPCORN lets you pop commercially packaged microwave popcorn (3.0 or 3.5 oz.).

For best results:

- Use fresh popcorn.
- Place only one bag of prepackaged microwave popcorn on the center of turntable.

Example :To pop 3.5 oz.

1. Touch **STOP/CLEAR**.

2. Touch **SENSOR POPCORN**.
POPCORN shows in the display.

The oven will cook food automatically by sensor system.

NOTES:

- Do not attempt to reheat or cook any unpopped kernels.
- Do not use popcorn popping devices in microwave oven with this feature.
- If you use a microwave popper, test it on sensor. There are many such devices available and their results may vary.
- IN NO CASE should you use a popper that concentrates the microwave energy.
- Do not leave Popcorn unattended.
- Listen to the popping. When the popping slows to 1-2 pops per second, stop cooking.
- WARNING needs to be added for 1.75 oz snack size.

Q Defrost

Use this function to thaw only 1.0 lb. of ground meat very quickly.

NOTE: The oven beeps during the defrost cycle. After it beeps, open the door and turn over, separate, or rearrange the food. Q DEFROST provides just enough defrosting so that the food can be used in recipes or for cooking. Some ice crystals remain.

This feature is designe for use with 1 pound packages only. For any other weight, use the Auto Defrost opition instead.

Example: Q Defrost

1. Touch **STOP/CLEAR**.

2. Touch **Q DEFROST**.
TOUCH START shows in the display.

3. Touch **ENTER/START**.
QUICK DEFROST shows in the display.

USING YOUR MICROWAVE OVEN

AUTO DEFROST

Four defrost choices are preset in the oven. The defrost feature provides you with the best defrosting method for frozen foods, because the oven automatically sets the defrosting times for each food item according to the weight you enter. For added convenience, the AUTO DEFROST includes a built-in tone mechanism that reminds you to check, turn over, separate, or rearrange the food during the defrost cycle. Four different defrosting options are provided.

1. MEAT
2. POULTRY
3. FISH
4. BREAD

After touching the AUTO DEFROST once, select the food category. Available weight ranges for Meat, Poultry and Fish are 0.1 to 6.0 lbs. The available weight range for Bread is 0.1 to 1.0 lb.

Example :To defrost 1.2 lbs of meat.

1. Touch **STOP/CLEAR**.
2. Touch **AUTO DEFROST**.
MEAT TOUCH 1
POULTRY TOUCH 2
FISH TOUCH 3
BREAD TOUCH 4
shows in the display.
3. Touch **[1]**.
MEAT ENTER WEIGHT shows in the display.
4. Touch **[1], [2]**.
TOUCH START shows in the display.
5. Touch **ENTER/START**.
DEFROST shows in the display.

NOTE: After you touch ENTER/START button, the display counts down the defrost time. The oven will beep once during the Defrost cycle. At this time, open the door and turn, separate, or rearrange the food as needed. Remove any portions that have thawed then return frozen portions to the oven and touch ENTER/START button to resume the defrost cycle. **The oven will not STOP during the BEEP unless the door is opened.**

For best results:

- Remove fish, shellfish, meat, and poultry from its original closed paper or plastic package (wrapper). Otherwise, the wrap will hold steam and juice close to the foods, which can cause the outer surface of the foods to cook.
- Form the meat into the shape of a doughnut before freezing. When defrosting, scrape off thawed meat when the beep sounds and continue defrosting.
- Place foods in a shallow glass baking dish or on a microwave roasting rack to catch drippings.
- Foods should still be somewhat icy in the center when removed from the oven.

AUTO DEFROST TABLE

Category	Food
MEAT 0.1 to 6.0 lbs (0.1 to 4.0kg)	BEEF Ground beef, Round steak, Cubes for stew, Tenderloin steak, Pot roast, Rib roast, Rump roast, Chuck roast, Hamburger patty. LAMB Chops (1-inch thick), Rolled roast PORK Chops (1/2 -inch thick), Hot dogs, Spareribs, Country-style ribs. Rolled roast, Sausage. VEAL Cutlets (1 lb, 1/2 -inch thick)
POULTRY 0.1 to 6.0 lbs (0.1 to 4.0kg)	POULTRY Whole (under 4 lbs), Cut up, Breasts (boneless) CORNISH HENS Whole TURKEY Breast (under 6 lbs)
FISH 0.1 to 6.0 lbs (0.1 to 4.0kg)	FISH Fillets, Whole Steaks SHELLFISH Crab meat, Lobster tails, Shrimp, Scallops
BREAD 0.1 to 1.0 lbs (0.1 to 0.5kg)	MUFFINS ROLL CAKE

UNDERSTANDING YOUR CONVECTION OVEN

TIPS FOR CONVECTION COOKING

This section gives you cooking instructions and procedures for operating each convection function. Please read these instructions carefully.

Convection cooking circulates hot air through the oven cavity with a fan. The constantly moving air surrounds the food to heat the outer portion quickly, creating even browning and sealed-in flavor by the constant motion of hot air over the food surfaces. Your oven uses convection cooking whenever you use the Convection Button. **DO NOT USE THE OVEN WITHOUT THE TURNTABLE IN PLACE.**

1. **Always use the metal rack** on the turntable when convection cooking.
2. **Do not cover** turntable or metal rack with aluminum foil. It interferes with the flow of air that cooks the food.
3. **Round pizza pans** are excellent cooking utensils for many convection-only items.
Choose pans that do not have extended handles.
4. **Use convection cooking** for items like soufflés, breads, cookies, angel food cakes, pizza, and for some meat and fish cooking.
5. **Your oven comes** equipped with a metal tray which can be used for cooking in convection mode or combination mode.
6. **You do not need to use** any special techniques to adapt your favorite oven recipes to convection cooking; however, you need to lower oven temperature by 25° F from recommended temperature mentioned in package instructions when cooking packaged food in convection mode.
7. **When baking** cakes, cookies, breads, rolls, or other baked foods, most recipes call for preheating. Preheat the empty oven just as you do a regular oven. You can start heavier dense foods such as meats, casseroles, and poultry without preheating.
8. **All heatproof** cookware or metal utensils can be used in convection cooking.
9. **As in conventional cooking**, the distance of the food from the heat source affects cooking results. Refer to the charts in this Use and Care Guide.
10. **Use metal utensils** only for convection cooking. Never use for microwave or combination cooking since arcing and damage to the oven may occur.
11. **After preheating**, if you do not open the door, the oven will automatically hold at the preheated temperature for 30 minutes.

PRECAUTIONS

- The oven cavity, door, turntable, roller rest, metal tray, metal rack, and cooking utensils will become very hot. **USE THICK OVEN GLOVES** when removing the food, cooking utensils, metal rack, metal tray, and turntable from the oven after convection cooking.
- Do not use lightweight plastic containers, plastic wraps, or paper products during any convection cycle.

USING YOUR CONVECTION OVEN

CONVECTION

During convection cooking, a heating element is used to raise the temperature of the air inside the oven.

Convection cooking temperature ranges from 225° F to 450° F and 100° F may be programmed.

It is best to preheat the oven when convection cooking.

Lower oven temperature by 25° F from package recommended temperature, instructions. The baking time may vary according to the food condition or individual preference. Check doneness at the minimum time and then adjust time.

Example: To set the convection cooking at 325° F for 45 minutes with preheating.



1. Touch **STOP/CLEAR**.



2. Touch **CONVECTION**
ENTER TEMPERATURE OR TOUCH ENTER shows in the display.



3. Touch **[5]**.
TOUCH ENTER shows in the display.



4. Touch **ENTER/START**.
325F ENTER COOKING TIME shows in the display.



5. Touch **ENTER/START**.
PREHEAT shows in the display.

NOTE: After preheating display scrolls “PREHEAT END” with sound. Open the door, place food on the metal tray or rack, and close the door. Display scrolls “ENTER COOKING TIME”



6. Touch **[4], [5], [0], [0]**.
TOUCH START shows in the display.



7. Touch **ENTER/START**.
325F CONVECTION shows in the display.

NOTES:

- When the oven reaches the set preheat temperature, five tones will sound and the oven will automatically hold that temperature for 30 minutes.
- The oven temperature drops very quickly when the door is opened, however, this should not prevent food from being fully cooked during normal cooking time.

Example: To set the convection cooking at 375° F for 30 minutes without preheating.



1. Touch **STOP/CLEAR**.



2. Touch **CONVECTION**.
ENTER TEMPERATURE OR TOUCH ENTER shows in the display.



3. Touch **[7]**.
TOUCH ENTER shows in the display.



4. Touch **ENTER/START**.
375F ENTER COOKING TIME shows in the display.

NOTE: If you press the ENTER/START button, it will operate.



5. Touch **[3], [0], [0], [0]**.
375F TOUCH START shows in the display.



6. Touch **ENTER/START**.
375F CONVECTION shows in the display.

NOTES:

- The temperature range has 10 steps.
- The default temperature is 350° F.

USING YOUR CONVECTION OVEN

CONVECTION COOKING GUIDE

1. Always use the metal rack when convection baking. Place food directly on rack or place in metal tray and then place tray on rack. (See page 9.)
2. Aluminum pans conduct heat quickly. For most convection baking, light, shiny finishes give best results because they prevent overbrowning in the time it takes to cook the center areas. Pans with dull (satin-finish) bottoms are recommended for cake pans and pie pans for best bottom browning.
3. Dark or non-shiny finishes, and glass, absorb heat which may result in dry, crisp crusts.
4. Preheating the oven is recommended when baking foods by convection.
5. To prevent uneven heating and save energy, open the oven door to check food as little as possible.

FOOD		Oven Temp.	Time, Min.	Comments
Breads	Biscuits	375° F	14 to 16	Canned refrigerated biscuits take 2 to 4 minutes less time.
	Corn Bread	375° F	22 to 27	Remove from pans immediately and cool slightly on wire rack.
	Muffins	375° F	28 to 32	
	Popovers	325° F	45 to 55	
	Nut Bread or Fruit Bread	350° F	55 to 65	Interiors will be moist and tender.
	Yeast Bread	375° F	18 to 25	Lightly grease baking sheet.
Plain or Sweet Rolls	350° F	13 to 16		
Cakes	Angel Food	325° F	53 to 63	Invert and cool in pan.
	Cheesecake	300° F	80 to 85	After cooking, turn oven off and let cheesecake stand in oven 30 minutes with door ajar.
	Coffee Cake	325° F	30 to 35	Interior will be moist and tender.
	Cup Cakes	325° F	20 to 25	
	Fruit Cake (loaf)	275° F	90 to 100	
	Gingerbread	325° F	42 to 47	
	Butter Cakes, Cake Mixes	325° F	35 to 45	Grease and flour pan. Cool in pan 10 minutes before inverting on wire rack.
	Fluted Tube Cake	325° F	30 to 40	
Pound Cake	325° F	45 to 55		
Cookies	Bar	325° F	40 to 50	Use same time for bar cookies from a mix.
	Drop or Sliced	350° F	15 to 19	Use same time for sliced cookies from a mix.

NOTES:

- The oven temperature indicated in the chart above is recommended over the package instruction temperature.
- The baking time in the chart above is only guidelines for your reference. You need to adjust time according to the food condition or your preference. Check doneness at the minimum time and then adjust time.

USING YOUR CONVECTION OVEN

CONVECTION BAKING TABLE

FOOD		Oven Temp.	Time, Min.	Comments
Fruits, Other Desserts	Baked Apples or Pears	350° F	25 to 35	Bake in cookware with shallow sides.
	Bread Pudding	300° F	35 to 40	Pudding is done when knife inserted near center comes out clean.
	Cream Puffs	400° F	30 to 35	Puncture pastries twice with toothpick to release steam after 25 minutes of baking time.
	Custard (individual)	350° F	45 to 50	Set cups in baking dish. Pour boiling water around cups to a depth of 1 inch.
	Meringue Shells	300° F	30 to 35	When done, turn oven off and let shells stand in oven 1 hour to dry.
Pies, Pastries	Frozen	375° F	70 to 80	Follow package directions for preparation.
	Meringue-topped	450° F	9 to 11	Follow package directions for preparation.
	Two-crust	400° F	50 to 55	Follow package directions for preparation.
	Quiche	350° F	30 to 35	Let stand 5 minutes before cutting.
	Pastry Shell	400° F	10 to 16	Pierce pastry with fork to prevent shrinkage.
Casseroles	Meat, chicken, seafood combinations	350° F	20 to 40	Cook times vary with casserole size and ingredients.
	Pasta	350° F	25 to 45	Cook times vary with casserole size and ingredients.
	Potatoes, scalloped	350° F	55 to 60	Let stand 5 minutes before serving.
	Vegetable	350° F	25 to 35	Cook times vary with casserole size and ingredients.
Convenience Foods	Frozen Bread Dough	350° F	30 to 35	Follow package directions for preparation.
	Frozen Entrée	325° F	70 to 80	Follow package directions for preparation.
	Frozen Pizza Rolls, Egg Rolls	400° F	9 to 11	Follow package directions for preparation.
	Pizza	375° F	15 to 25	Follow package directions for preparation.
	Slice and Bake Cookies	375° F	13 to 15	Let stand a few minutes before removing from pan to cool.
Main Dishes	Meat Loaf	325° F	55 to 60	Let stand 5 minutes after cooking.
	Oven-Baked Stew	325° F	80 to 90	Brown meat before combining with liquid and vegetables.
	Swiss Steak	350° F	60 to 70	Let stand 2 minutes after cooking.
	Stuffed Peppers	350° F	40 to 45	Use green, red, or yellow peppers.
Vegetables	Acorn Squash Halves	375° F	55 to 60	Pierce skin several places. Add 1/4 cup water to dish. Turn squash halves cut side up after 30 minutes of cook time and cover.
	Baked Potatoes	425° F	50 to 60	Pierce skin with a fork before baking.
	Twice-Baked Potatoes	400° F	25 to 30	Pierce skin with fork before baking.

NOTES:

- The oven temperature indicated in the chart above is recommended over the package instruction temperature.
- The baking time in the chart above is only guidelines for your reference. You need to adjust time according to the food condition or your preference. Check doneness at the minimum time and then adjust time.

USING YOUR CONVECTION OVEN

MEAT ROASTING TABLE FOR CONVECTION COOKING

MEATS		Oven Temp.	Time, Min./lb.
Beef	Rib (2 to 4 lbs.)		
	Rare	300° F	42 to 47
	Medium	300° F	47 to 52
	Well	300° F	52 to 57
	Boneless Rib, Top Sirloin		
	Rare	300° F	50 to 55
	Medium	300° F	55 to 60
	Well	300° F	60 to 65
	Beef Tenderloin		
	Rare	300° F	25 to 29
Medium	300° F	29 to 33	
Pot Roast (2½ to 3 lbs.)			
Chuck, Rump	300° F	80 to 85	
Ham	Canned (3-lb. fully cooked)	325° F	20 to 25
	Butt (5-lb. fully cooked)	325° F	20 to 25
	Shank (5-lb. fully cooked)	325° F	17 to 20
Lamb	Bone-in (2 to 4 lbs.)		
	Medium	300° F	42 to 47
	Well	300° F	47 to 52
	Boneless (2 to 4 lbs.)		
	Medium	300° F	50 to 55
Well	300° F	55 to 60	
Pork	Bone-in (2 to 4 lbs.)	300° F	48 to 52
	Boneless (2 to 4 lbs.)	300° F	56 to 61
	Pork Chops (½ to 1-inch thick)		
	2 chops	325° F	42 to 45
	4 chops	325° F	45 to 48
	6 chops	325° F	48 to 55
Poultry	Whole Chicken (2½ to 3½ lbs.)	375° F	25 to 35
	Chicken Pieces (2½ to 3½ lbs.)	350° F	18 to 21
	Cornish Hens		
	Unstuffed (1 to 1½ lbs.)	375° F	10 to 15
	Stuffed (1 to 1½ lbs.)	375° F	15 to 20
	Duckling (4 to 5 lbs.)	375° F	19 to 21
	Turkey Breast (4 to 6 lbs.)	325° F	21 to 25
Seafood	Fish, whole (3 to 5 lbs.)	400° F	13 to 18
	Lobster Tails (6 to 8-oz. each)	350° F	12 to 17

NOTES:

- The roasting time in the chart above is only guidelines for your reference. You need to adjust time according to the food condition or your preference. Check doneness at the minimum time and then adjust time.

UNDERSTANDING YOUR COMBINATION OVEN

TIPS FOR COMBINATION COOKING

This section gives you instructions to operate each combination cooking function. Please read these instructions carefully. Sometimes combination microwave-convection cooking is suggested to get the best cooking results since it shortens the cooking time for foods that normally need a long time to cook. This cooking process also leaves meats juicy on the inside and crispy on the outside. In combination cooking, the convection heat and microwave energy alternate automatically. Your oven has three preprogrammed settings that make it easy to use combination cooking.

HELPFUL HINTS FOR COMBINATION COOKING

1. **Meats** may be roasted directly on the metal rack or in a shallow roasting pan placed on the rack. When using the metal rack, please check your cooking guide for information on proper use.
2. Less tender cuts of beef can be roasted and tenderized using oven cooking bags.
3. When baking, check for doneness after cooking time is up. If not completely done, let stand in oven for a few minutes to complete cooking.

PRECAUTIONS

1. All cookware used for combination cooking must be BOTH microwave-safe and ovenproof.
2. During combination baking, some baking cookware may cause arcing when it comes in contact with the oven walls or metal accessory racks. Arcing is a discharge of electricity that occurs when microwaves come in contact with metal.
 - If arcing occurs, place a heatproof dish between the pan and the metal rack.
 - We recommend you use the metal tray applied with your oven. It has rubber feet that helps prevent arcing.
 - If arcing occurs with other baking cookware, do not use them for combination cooking.

COMBINATION ROAST

	Oven Temperature	Microwave Power
Combination Roast	375° F	30%

Example: To roast with combination cooking for 45 minutes.



1. Touch **STOP/CLEAR**.



2. Touch **ROAST**.
ENTER TEMPERATURE OR TOUCH ENTER shows in the display.



3. Touch **ENTER/START**.
375F ENTER COOKING TIME shows in the display.



4. Touch **[4], [5], [0], [0]**.
TOUCH START shows in the display.



5. Touch **ENTER/START**.
375F COMBI ROAST shows in the display.

NOTES:

- The temperature range has 10 steps.
- By touch more/less key in combination cooking, you can set the desired temperature.

USING YOUR COMBINATION OVEN

COMBINATION ROAST COOKING GUIDE

MEATS		Oven Temp.	Time,Min./lb.
Beef	Rib (2 to 4 lbs.)		
	Rare	300° F	11 to 14
	Medium	300° F	14 to 17
	Well	300° F	17 to 20
	Boneless Rib, Top Sirloin		
	Rare	300° F	11 to 14
	Medium	300° F	14 to 17
	Well	300° F	17 to 20
	Beef Tenderloin		
	Rare	300° F	14 to 17
Medium	300° F	17 to 20	
Chuck, Rump or Pot Roast (2½ to 3 lbs.) (Use cooking bag for best results.) Turn over after half of cooking time.	275° F	30 to 40	
Ham	Canned (3-lb. fully cooked)	300° F	15 to 18
	Butt (5-lb. fully cooked)	300° F	15 to 18
	Shank (5-lb. fully cooked)	300° F	15 to 18
	Turn over after half of cooking time.		
Lamb	Bone-in (2 to 4 lbs.)		
	Medium	300° F	13 to 18
	Well	300° F	18 to 23
	Boneless (2 to 4 lbs.)		
	Medium	300° F	14 to 19
Well	300° F	19 to 24	
Turn over after half of cooking time.			
Pork	Bone-in (2 to 4 lbs.)	300° F	23 to 26
	Boneless (2 to 4 lbs.)	300° F	25 to 28
	Pork Chops (¾ to 1-inch thick)		
	2 chops	350° F	10 to 13
	4 chops	350° F	13 to 16
	6 chops	350° F	16 to 19
	Turn over after half of cooking time.		
Poultry	Whole Chicken (2½ to 6 lbs.)	400° F	19 to 21
	Chicken Pieces (2½ to 6 lbs.)	375° F	15 to 18
	Cornish Hens		
	Unstuffed	375° F	18 to 25
	Stuffed	375° F	23 to 30
	Duckling	375° F	15 to 18
Turkey Breast (4 to 6 lbs.)	300° F	11 to 15	
Turn breast side up after half of cooking time.			
Seafood	Fish		
	1-lb. fillets	350° F	7 to 10
	Lobster Tails (6 to 8-oz. each)	350° F	10 to 15
	Shrimp (1 to 2 lbs.)	350° F	9 to 14
	Scallops (1 to 2 lbs.)	350° F	8 to 13

NOTES:

- The roasting time in the chart above is only guidelines for your reference. You need to adjust time according to the food condition or your preference. Check doneness at the minimum time and then adjust time.

USING YOUR COMBINATION OVEN

COMBINATION BAKE

	Oven Temperature	Microwave Power
Combination Bake	325° F	10%

Example: To bake with combination cooking for 45 minutes.

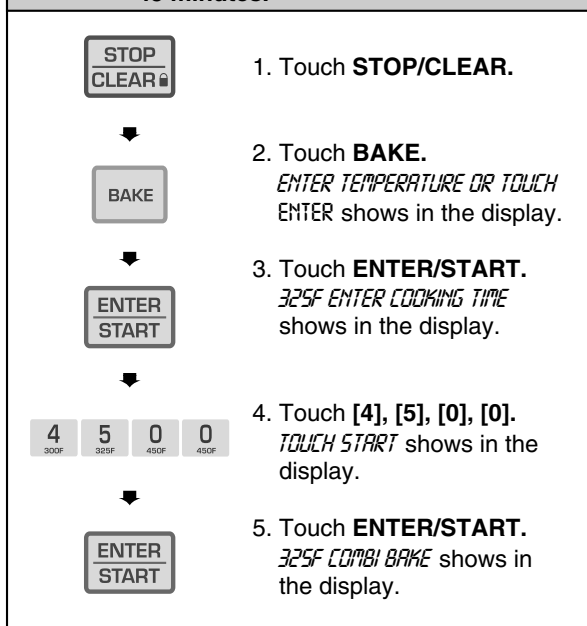

NOTES:

- The temperature range has 10 steps.
- By touch more/less key in combination cooking, you can set the desired temperature.

COMBINATION BAKE COOKING GUIDE

FOOD		Oven Temp	Time,in	Comments
Breads	Biscuits	400° F	13 to 15	Canned refrigerated biscuits take 1 to 3 minutes less time.
Pies, Pastries	Quiche	425° F	15 to 17	Let stand 5 minutes before cutting.
Convenience Foods	Frozen Entrée	375° F	39 to 43	Follow package directions for preparation.
	Frozen Pizza Rolls, Egg Rolls	450° F	4 to 6	Follow package directions for preparation.
	Pizza	450° F	23 to 26	Follow package directions for preparation.
Vegetables	Baked Potatoes	450° F	36 to 40	Pierce skin with a fork before baking.

USING YOUR COMBINATION OVEN

COMBINATION AUTO COOK

Use this function to cook food without entering cooking time or power level on combination mode. AUTO COOK has 4 food categories. Refer to the following auto cook guide for more information.

Example: To cook 3.5 lbs whole chicken.

1. Touch **STOP/CLEAR**.
2. Touch **AUTO COOK**.
SELECT MENU 1 TO 4 shows in the display.
3. Touch **[1]**.
WHOLE CHICKEN ENTER WEIGHT shows in the display.
4. Touch **[3], [5]**.
TOUCH START shows in the display.
5. Touch **ENTER/START**.
WHOLE CHICKEN shows in the display.

COMBINATION AUTO COOKING GUIDE

Category	Direction	Amount
Whole Chicken	Thoroughly wash inside and outside of chicken with cold water. Pat chicken dry with paper towels, secure the legs with kitchen twine. Brush outside of chicken with melted butter or margarine. Place chicken breast side down on metal rack on metal tray. After cooking, loosely tent chicken with aluminum foil. Let stand for 10 minutes after cooking.	2.0~4.0 lbs (0.9~1.8 kg)
Chicken Pieces	Pat chicken pieces dry with paper towels. Brush chicken pieces with melted butter or margarine. Arrange chicken pieces on metal rack on metal tray.	0.4~2.0 lbs (0.2~0.9 kg)
Baked Potato	Pierce each potato several times with a fork and place on metal rack metal tray.	1~4 ea.
Frozen Lasagna	Remove from outer package. Remove film cover. If entrée is not in a ovenproof container, place it on a ovenproof dish. Place on metal rack on metal tray. Let stand for 5 minutes after cooking.	10 or 21 oz.

HEATING /REHEATING GUIDE

To heat or reheat successfully in a microwave oven, it is important to follow several guidelines. Measure the amount of food in order to determine the time needed to reheat. Arrange the food in a circular pattern for best results. Room temperature food will heat faster than refrigerated food. Canned foods should be taken out of the can and placed in a microwave-safe container. The food will heat more evenly if covered with a microwave-safe lid or vented plastic wrap. Remove cover carefully to prevent steam burns. Use the following chart as a guide for reheating cooked food.

ITEMS	COOK TIME (AT HIGH)	SPECIAL INSTRUCTIONS
Sliced meat 3 slices (1/4 -inch thick)	1-2 minutes	Place sliced meat on microwavable plate. Cover with plastic wrap and vent. Note: Gravy or sauce helps to keep meat juicy.
Chicken pieces 1 breast 1 leg and thigh	2-3 1/2 minutes 1 1/2 -3 minutes	Place chicken pieces on microwavable plate. Cover with plastic wrap and vent.
Fish fillet (6-8 oz.)	2-4 minutes	Place fish on microwavable plate. Cover with plastic wrap and vent.
Lasagna 1 serving (10 1/2 oz.)	4-6 minutes	Place lasagna on microwavable plate. Cover with plastic wrap and vent.
Casserole 1 cup 4 cups	1-3 1/2 minutes 5-8 minutes	COOK covered in microwavable casserole. Stir once halfway through cooking.
Casserole – cream or cheese 1 cup 4 cups	1 1/2 -3 minutes 3 1/2 -5 1/2 minutes	COOK covered in microwavable casserole. Stir once halfway through cooking.
Sloppy Joe or Barbecued Beef 1 sandwich (1/2 cup meat filling) without bun	1 -2 1/2 minutes	Reheat filling and bun separately. Cook filling covered in microwavable casserole. Stir once. Heat bun as directed in chart below.
Mashed potatoes 1 cup 4 cups	1-3 minutes 5-8 minutes	COOK covered in microwavable casserole. Stir once halfway through cooking.
Baked beans 1 cup	1 1/2 -3 minutes	COOK covered in microwavable casserole. Stir once halfway through cooking.
Ravioli or pasta in sauce 1 cup 4 cups	2 1/2 -4 minutes 7 1/2 -11 minutes	COOK covered in microwavable casserole. Stir once halfway through cooking.
Rice 1 cup 4 cups	1 1/2 -3 1/2 minutes 4-6 1/2 minutes	COOK covered in microwavable casserole. Stir once halfway through cooking.
Sandwich roll or bun 1 roll	15-30 seconds	Wrap in paper towel and place on glass microwavable rack
Vegetables 1 cup 4 cups	1 1/2-2 1/2 minutes 4-6 minutes	COOK covered in microwavable casserole. Stir once halfway through cooking.
Soup 1 serving (8 oz.)	1 1/2-2 1/2 minutes	COOK covered in microwavable casserole. Stir once halfway through cooking.

FRESH VEGETABLE GUIDE

Vegetable	Amount	Cook Time at High (Minute)	Instructions	Standing Time
Artichokes (8 oz. each)	2 medium 4 medium	5-8 10-13	Trim. Add 2 tsp water and 2 tsp juice. Cover.	2-3 minutes
Asparagus, Fresh, Spears	1 lb.	3-6	Add ½ cup water. Cover.	2-3 minutes
Beans, Green & Wax	1 lb.	7-11	Add ½ cup water in 1½ qt. casserole. Stir halfway through cooking.	2-3 minutes
Beets, Fresh	1 lb.	12-16	Add ½ cup water in 1½ qt. covered casserole. Rearrange halfway through cooking.	2-3 minutes
Broccoli, Fresh, Spears	1 lb.	4-8	Place broccoli in baking dish. Add ½ cup water.	2-3 minutes
Cabbage, Fresh, Chopped	1 lb.	4-7	Add ½ cup water in 1½ qt. covered casserole. Stir halfway through cooking.	2-3 minutes
Carrots, Fresh, Sliced	2 cups	2-4	Add ¼ cup water in 1 qt. covered casserole. Stir halfway through cooking.	2-3 minutes
Cauliflower, Fresh, Whole	1 lb.	7-11	Trim. Add ¼ cup water in 1 qt. covered casserole. Stir halfway through cooking.	2-3 minutes
Flowerettes, Fresh	2 cups	2½ - 4½	Slice. Add ½ cup water in 1½ qt. covered casserole. Stir halfway through cooking.	2-3 minutes
Celery, Fresh, Sliced	4 cups	6-8		
Corn, Fresh	2 ears	5-9	Husk. Add 2 tbsp water in 1½ qt. baking dish. Cover.	2-3 minutes
Mushrooms, Fresh, Sliced	½ lb.	2-3½	Place mushrooms in 1½ qt. covered casserole. Stir halfway through cooking.	2-3 minutes
Parsnips, Fresh, Sliced	1 lb.	4-8	Add ½ cup water in 1½ qt. covered casserole. Stir halfway through cooking.	2-3 minutes
Peas, Green, Fresh	4 cups	7-10	Add ½ cup water in 1½ qt. covered casserole. Stir halfway through cooking.	2-3 minutes
Sweet Potatoes Whole Baking (6-8 oz. each)	2 medium 4 medium	5-10 7-13	Pierce potatoes several times with fork. Place on 2 paper towels. Turn over halfway through cooking.	2-3 minutes 2-3 minutes
White Potatoes, Whole Baking (6-8 oz. each)	2 potatoes 4 potatoes	5-8 10-14	Pierce potatoes several times with fork. Place on 2 paper towels. Turn over halfway through cooking.	2-3 minutes 2-3 minutes
Spinach, Fresh, Leaf	1 lb.	4-7	Add ½ cup water in 2 qt. covered casserole.	2-3 minutes
Squash, Acorn or Butternut, Fresh	1 medium	6-8	Cut squash in half. Remove seeds. Place in 8 x 8-inch baking dish. Cover.	2-3 minutes
Zucchini, Fresh, Sliced	1 lb.	4½ - 7½	Add ½ cup water in 1½ qt. covered casserole. Stir halfway through cooking.	2-3 minutes
Zucchini, Fresh, Whole	1 lb.	6-9	Pierce. Place on 2 paper towels. Turn over and rearrange halfway through cooking.	2-3 minutes

TROUBLESHOOTING

Questions and Answers

Operation

Question	Answer
Why is the oven light not on during cooking?	There may be several reasons why the oven light is not on. Have you: <ul style="list-style-type: none"> • Set a cook time? • Touched ENTER/START?
Why does steam come out of the air exhaust vent?	Steam is normally produced during cooking. The microwave oven has been designed to vent this steam.
Will the microwave oven be damaged if it operates empty?	Yes. Never operate the oven empty or without the glass turntable.
Does microwave energy pass through the viewing screen in the door?	No. The metal screen bounces the energy back to the oven cavity. The holes (or ports) allow only light to pass through. They do not let microwave energy pass through.
Why does a tone sound when a pad on the control panel is touched?	The tone tells you that the setting has been entered.
Can my microwave oven be damaged if food is cooked for too long?	Like any other cooking appliance, it is possible to overcook food to the point that the food creates smoke and possibly even fire and damage to the inside of the oven. It is always best to be near the oven while you are cooking.
When the oven is plugged into wall outlet for the first time, it might not work properly. What is wrong?	The microcomputer controlling your oven may temporarily become scrambled and fail to function as programmed when you plug in for the first time or when power resumes after a power interruption. Unplug the oven from the 120 Volt household outlet and then plug it back in to reset the microcomputer.
Why do I see light reflection around the outer case?	This light is from the oven light which is located between the oven cavity and the outer wall of the oven.
What are the various sounds I hear when the microwave oven is operating?	The clicking sound is caused by a mechanical switch turning the microwave oven's magnetron ON and OFF. The heavy hum and clunk is from the change in power the magnetron draws as it is turned ON and OFF by a mechanical switch. The change in blower speed is from the change in line voltage caused by the magnetron being turned ON and OFF.

TROUBLESHOOTING

Questions and Answers (continued)

Food

Question	Answer
What is wrong when baked foods have a hard, dry, brown spot?	A hard, dry, brown spot indicates overcooking. Shorten the cooking or reheating time.
Why do eggs sometimes pop?	When baking, frying, or poaching eggs, the yolk may pop due to steam buildup inside the yolk membrane. To prevent this, simply pierce the yolk with a wooden toothpick before cooking. CAUTION: Never microwave eggs in the shell.
Why are scrambled eggs sometimes a little dry after cooking?	Eggs will dry out when they are overcooked, even if the same recipe is used each time. The cooking time may need to be varied for one of these reasons: <ul style="list-style-type: none"> • Eggs vary in size. • Eggs are at room temperature one time and at refrigerator temperature another time. • Eggs continue cooking during standing time.
Why do baked apples sometimes burst during cooking?	The peel has not been removed from the top half of each apple to allow for expansion of the interior of the apple during cooking. As in conventional cooking methods, the interior of the apple expands during the cooking process.
Why do baked potatoes sometimes burn during cooking?	If the cooking time is too long, fire could result. At the end of the recommended cooking time, potatoes should be slightly firm. CAUTION: Do not overcook.
Why is a standing time recommended after microwave cooking time is over?	Standing time allows foods to continue cooking evenly for a few minutes after the actual microwave oven cooking cycle ends. The amount of standing time depends upon the density of the foods.
Why is additional time required for cooking food stored in the refrigerator?	As in conventional cooking, the initial temperature of food affects total cooking time. You need more time to cook food taken out of a refrigerator than for food at room temperature.

TROUBLESHOOTING

BEFORE CALLING FOR SERVICE

You can often correct operating problems yourself. If your microwave oven fails to work properly, locate the operating problem in the list below and try the solutions listed for each problem. If the microwave oven still does not work properly, contact the nearest LG Parts & Repair Center, which is fully equipped to handle your service requirements.

Problem	Possible Causes
Oven does not start	<ul style="list-style-type: none"> • Is the power cord plugged in? • Is the door closed? • Is the cooking time set?
Arcing or sparking	<ul style="list-style-type: none"> • Are you using approved cookware? • Is the oven empty?
Incorrect time of day	<ul style="list-style-type: none"> • Have you tried to reset the time of day?
Unevenly cooked foods	<ul style="list-style-type: none"> • Are you using approved cookware? • Is the glass turntable in the oven? • Did you turn or stir the food while it was cooking? • Were the foods completely defrosted? • Was the time/cooking power level correct?
Overcooked foods	<ul style="list-style-type: none"> • Was the time/cooking power level correct?
Undercooked foods	<ul style="list-style-type: none"> • Are you using approved cookware? • Were the foods completely defrosted? • Was the time/cooking power level correct? • Are the ventilation ports clear?
Improper defrosting	<ul style="list-style-type: none"> • Are you using approved cookware? • Was the time/cooking power level correct? • Did you turn or stir the food during the defrosting cycle?

FEDERAL COMMUNICATIONS COMMISSION RADIO FREQUENCY INTERFERENCE STATEMENT

WARNING:

This equipment generates and uses ISM frequency energy and if not installed and used properly, that is in strict accordance with the manufacturer's instructions, may cause interference to radio and television reception. It has been type tested and found to comply with limits for ISM Equipment pursuant to part 18 of FCC Rules, which are designed to provide reasonable protection against such interference in a residential installation.

However, there is no guarantee that interference will not occur in a particular installation. If this equipment does cause interference to radio or television reception, which can be determined by turning the equipment off and on, the user is encouraged to try to correct the interference by one or more of the following:

- Reorient the receiving antenna of the radio or television.
- Relocate the Microwave Oven with respect to the receiver.
- Move the microwave oven away from the receiver.
- Plug the microwave oven into a different outlet so that the microwave oven and the receiver are on different branch circuits.

The manufacturer is not responsible for any radio or TV interference caused by **unauthorized modification** to this microwave oven. It is the responsibility of the user to correct such interference.



LG MICROWAVE OVEN LIMITED WARRANTY — USA

Model: LMH1017CVB / LMH1017CVW / LMH1017CVST

LG Electronics Inc. will repair or replace your product, at LG's option, if it proves to be defective in material or workmanship under normal use, during the warranty period set forth below, effective from the date of original consumer purchase of the product. This warranty is good only to the original purchaser of the product and effective only when used in the United States, including U.S. Territories.

<p><u>WARRANTY PERIOD:</u></p> <p>LABOR: One Year from the Date of Purchase*.</p> <p>PARTS (except as listed below): One Year from the Date of Purchase*.</p> <p>MAGNETRON: Ten Years from the Date of Purchase*.</p> <p>Replacement Units and Repair Parts are warranted for the remaining portion of the original unit's warranty period.</p> <p>* Retain your Sales Receipt to prove the date of purchase. A copy of your Sales Receipt must be submitted at the time warranty service is provided.</p>	<p><u>HOW SERVICE IS HANDLED:</u></p> <p>Please call 1-800-243-0000 and choose the appropriate option. (Phones are answered 24 hours a day, 365 days per year.) Please have the product type (Microwave) and your ZIP code ready.</p> <p>Or visit our website at: http://us.lgservice.com</p>
--	---

THIS WARRANTY IS IN LIEU OF ANY OTHER WARRANTY, EXPRESS OR IMPLIED, INCLUDING WITHOUT LIMITATION, ANY WARRANTY OF MERCHANTABILITY OR FITNESS FOR A PARTICULAR PURPOSE. TO THE EXTENT ANY IMPLIED WARRANTY IS REQUIRED BY LAW, IT IS LIMITED IN DURATION TO THE EXPRESS WARRANTY PERIOD ABOVE. LG WILL NOT BE LIABLE FOR ANY INCIDENTAL, CONSEQUENTIAL, INDIRECT, SPECIAL, OR PUNITIVE DAMAGES OF ANY NATURE, INCLUDING WITHOUT LIMITATION, LOST REVENUES OR PROFITS, OR ANY OTHER DAMAGE WHETHER BASED IN CONTRACT, TORT, OR OTHERWISE. Some states do not allow the exclusion or limitation of incidental or consequential damages or limitations on how long an implied warranty lasts, so the above exclusion or limitation may not apply to you. This warranty gives you specific legal rights and you may also have other rights that vary from state to state.

THIS LIMITED WARRANTY DOES NOT APPLY TO:

- Service trips to your home to deliver, pick up, and/or install the product, instruct, or replace house fuses or correct wiring, or correction of unauthorized repairs.
- Damages or operating problems that result from misuse, abuse, operation outside environmental specifications or contrary to the requirements of precautions in the Operating Guide, accident, vermin, fire, flood, improper installation, acts of God, unauthorized modification or alteration, incorrect electrical current or voltage, or commercial use, or use for other than intended purpose.

The cost of repair or replacement under these excluded circumstances shall be borne by the consumer.

CUSTOMER INTERACTIVE CENTER NUMBERS

<p>To obtain Customer Assistance, Product Information, or Dealer or Authorized Service Center location:</p>	<p>Call 1-800-243-0000 (24 hours a day, 365 days per year) and select the appropriate option from the menu.</p> <p>Or visit our website at: http://us.lgservice.com</p>
--	--

TO CONTACT LG ELECTRONICS BY MAIL:

LG Customer Interactive Center
P. O. Box 240007
201 James Record Road
Huntsville, Alabama 35824
ATTN: CIC



LG Electronics Inc.

Printed in Korea