

LCD TV | PLASMA TV OWNER'S MANUAL

LCD TV MODELS

26LC4* 26LC5*
32LC4* 32LC5*
37LC4* 37LC5*
42LC4* 42LC5*
26LC3*

PLASMA TV MODELS

42PC5*
42PC5RV*
50PC5*

Please read this manual carefully before operating your set.
Retain it for future reference.

Record model number and serial number of the set.
See the label attached on the back cover and quote
this information to your dealer when you require service.

ACCESSORIES

Ensure that the following accessories are included with your TV. If an accessory is missing, please contact the dealer where you purchased the product.

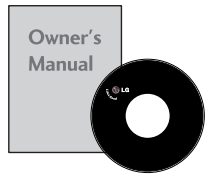

Owner's Manual



Batteries

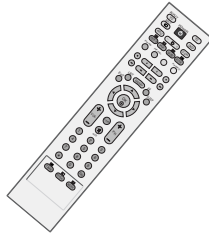

Remote Control

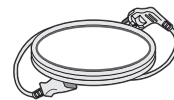

Power Cord

Plasma TV models

This feature is not available for all models.



2-Wall brackets



2-eye-bolts



Polishing Cloth
Polish the screen with the cloth
This feature is not available
for all models.

**Slightly wipe stained spot on the exterior only with the cleansing cloths for the product exterior or if there is stain or fingerprint on surface of the exterior.*

Do not wipe roughly when removing stain. Please be cautious of that excessive power may cause scratch or discoloration.

LCD TV models

This feature is not available for all models.



2- TV Brackets
2- Wall Brackets



2-bolts



Twister Holder
Arrange the wires with
the twister holder.

26", 32", 37" only



4-bolts for stand assembly
Refer to p. 8

**26LC4*, 32LC4*, 37LC4*,
42LC4*, 26LC5*, 32LC5*,
37LC5*, 42LC5* only**



Cable
Management

26LC3R* only



Cable Management

CONTENTS

ACCESSORIES..... 1

PREPARATION

Front Panel Controls.....	4
Back Panel Information	6
Stand Installation.....	8
Attaching the TV to a Wall	9
Back Cover for Wire Arrangement	10
Desktop Pedestal Installation.....	12
Wall Mount: Horizontal installation	13
Antenna Connection	14

EXTERNAL EQUIPMENT SETUP

HD Receiver Setup	15
DVD Setup.....	18
VCR Setup.....	21
Other A/V Source Setup	24
External Stereo.....	25
PC Setup.....	26
- Screen Setup for PC Mode	28

WATCHING TV / PROGRAMME CONTROL

Remote Control Key Functions.....	32
Turning on the TV.....	34
Programme Selection	34
Volume Adjustment.....	34
On Screen Menu Selection and Adjustment	35
Auto Programme Tuning.....	36
Manual Programme Tuning.....	37
Fine Tuning.....	38
Assigning a Station Name.....	39
Programme Edit	40
Favourite Programme	41
Calling the Programme Table.....	42
Key lock	43
 SIMPLINK	44

PICTURE CONTROL

Picture Size (Aspect Ratio)Control.....	46
Preset Picture Settings	
- Picture Mode-Preset	48
- Auto Colour Tone Control(Warm/Medium/Cool)..	49
Manual Picture Adjustment	
- Picture Mode-User Option	50
- Colour Tone - User Option	51
XD - Picture Improvement Technology.....	52
XD Demo	53
Advanced - Cinema.....	54
Advanced - Black(Darkness) Level.....	55
Picture Reset.....	56
Image Sticking Minimization(ISM) Method	57
Low-Power Picture Mode.....	58

SOUND & LANGUAGE CONTROL

Auto Volume Leveler.....	59
Preset Sound Settings - Sound Mode.....	60
Sound Setting Adjustment - User Mode	61
Balance	62
TV Speakers On/Off Setup	63
I/II	
- Stereo/Dual Reception.....	64
- NICAM Reception.....	65
- Speaker Sound Output Selection	65
On-Screen Menu Language /Country Selection.....	66

TIME SETTING

Clock Setup.....	67
Auto On/Off Timer Setting.....	68
Sleep Timer Setting	69
Auto Shut-off Setting	70

TELETEXT

Switch On/Off.....	71
SIMPLE Text	71
TOP Text	72
FASTEXT	72
Special Teletext Functions.....	73

APPENDIX

Troubleshooting.....	74
Maintenance	76
Product Specifications	77
Programming the Remote Control	79

PREPARATION

FRONT PANEL CONTROLS

- This is a simplified representation of the front panel. Here shown may be somewhat different from your TV.
- If your product has a protection film attached, remove the film and then wipe the product with a polishing cloth.

Plasma TV Models

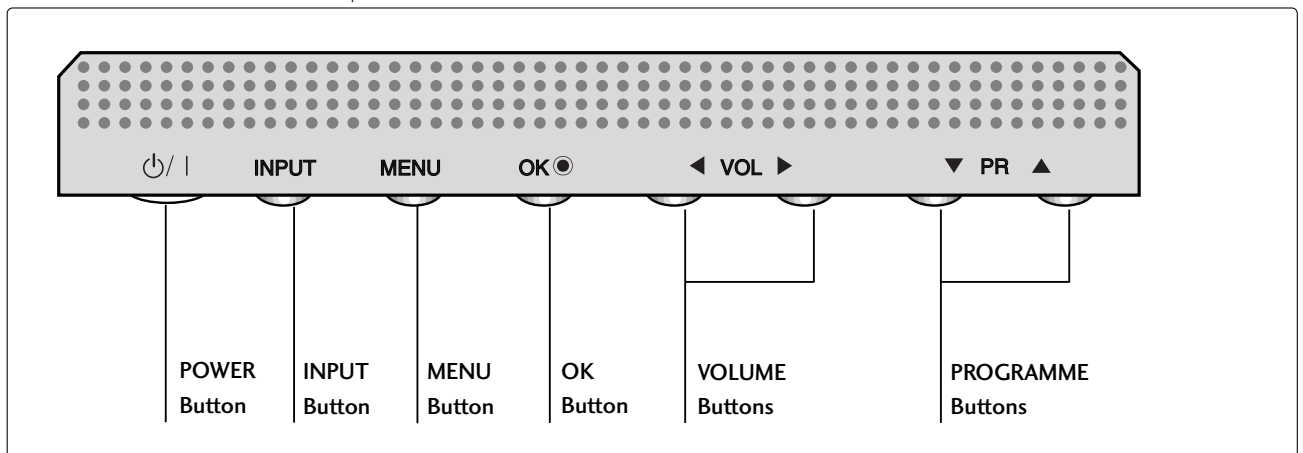
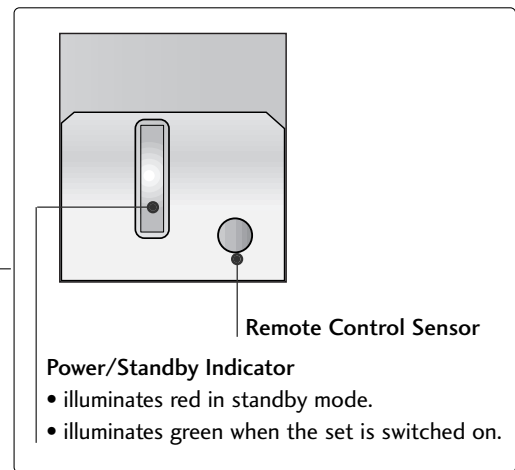

LCD TV Models

26LC4*, 32LC4*, 37LC4*, 42LC4*, 26LC5*, 32LC5*,
37LC5*, 42LC5*

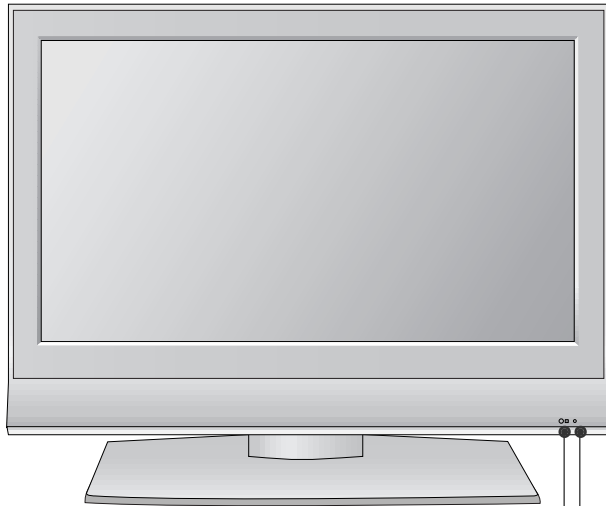

Remote Control Sensor

Power/Standby Indicator

- illuminates red in standby mode.
- illuminates green when the set is switched on.

26LC3R*

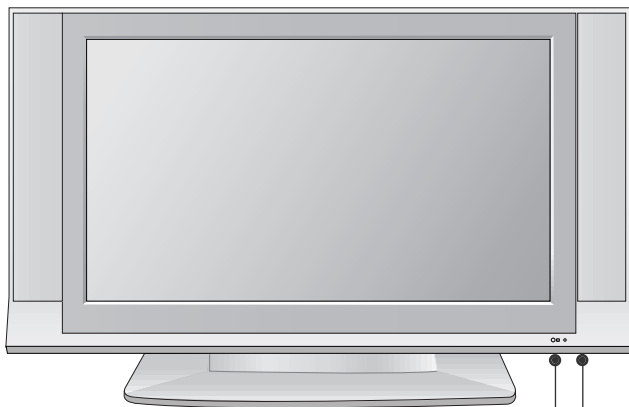

Remote Control Sensor

Power/Standby Indicator

- illuminates red in standby mode.
- illuminates green when the set is switched on.

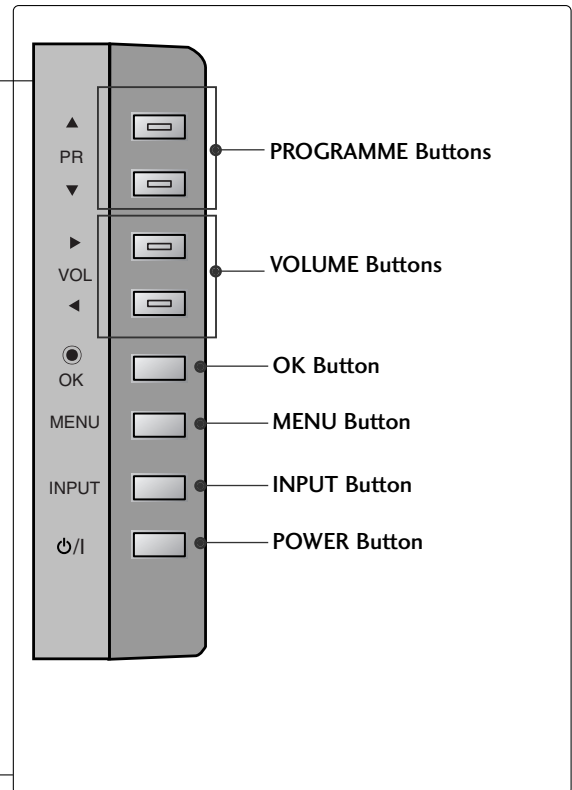

PREPARATION

BACK PANEL INFORMATION

■ This is a simplified representation of the back panel. Here shown may be somewhat different from your TV.

Plasma TV Models

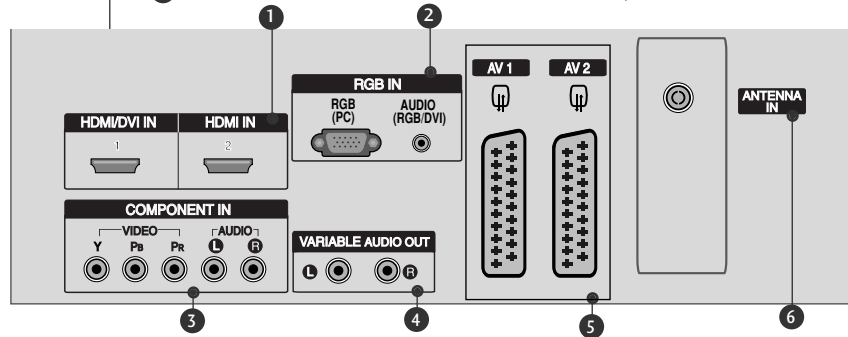
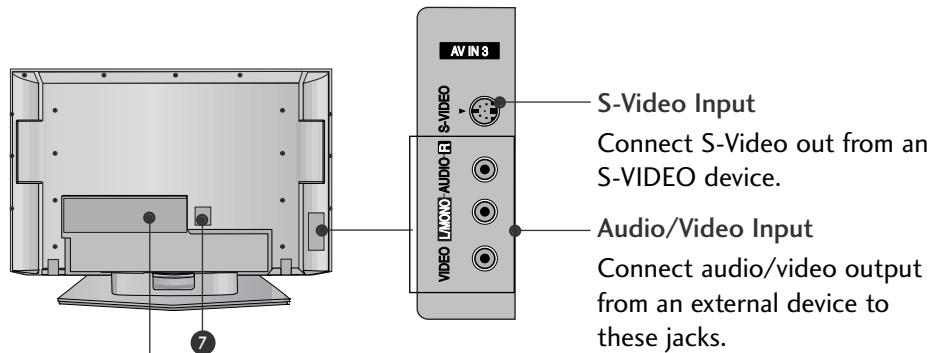

42PC5RVC

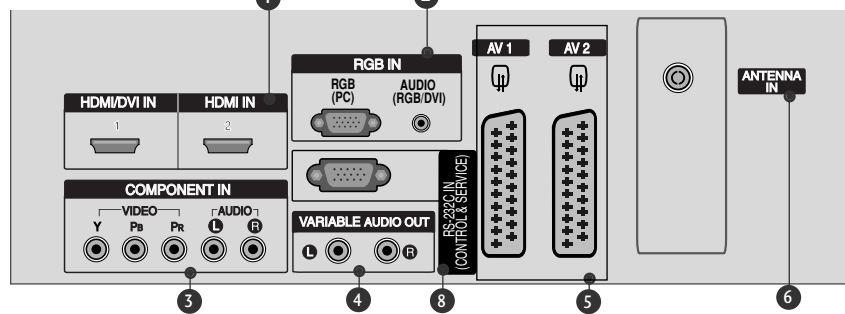

- 1 HDMI Input**
Connect a HDMI signal to HDMI IN.
Or DVI(VIDEO)signal to HDMI/DVI port with DVI to HDMI cable.
- 2 RGB/Audio Input**
Connect the monitor output from a PCto the appropriate input port.
- 3 Component Input**
Connect a component video/audio device to these jacks.
- 4 Variable Audio Output**
Connect an external amplifier or add a subwoofer to your surround sound system.
- 5 Euro Scart Socket (AV1/AV2)**
Connect scart socket input or output from an external device to these jacks.
- 6 Antenna Input**
Connect over-the-air signals to this jack.
- 7 Power Cord Socket**
This TV operates on an AC power. The voltage is indicated on the Specifications page. Never attempt to operate the TV on DC power.
- 8 RS-232C Input(CONTROL&SERVICE)Port**
Connect the serial port of the control devices to the RS-232C jack.

LCD TV Models

26LC4*, 32LC4*, 37LC4*,
42LC4*, 26LC5*, 32LC5*,
37LC5*, 42LC5*

26LC3R*

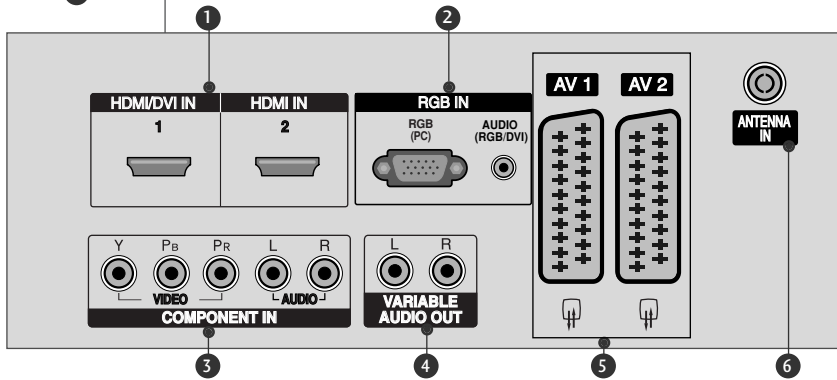
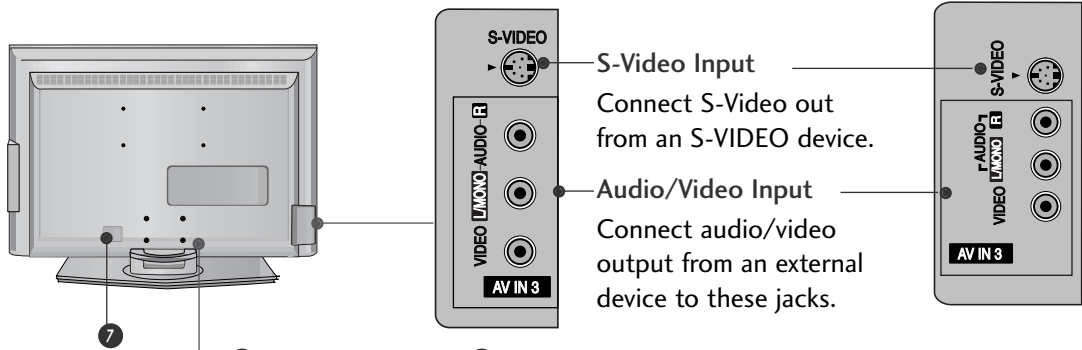

26LC51C
32LC52C

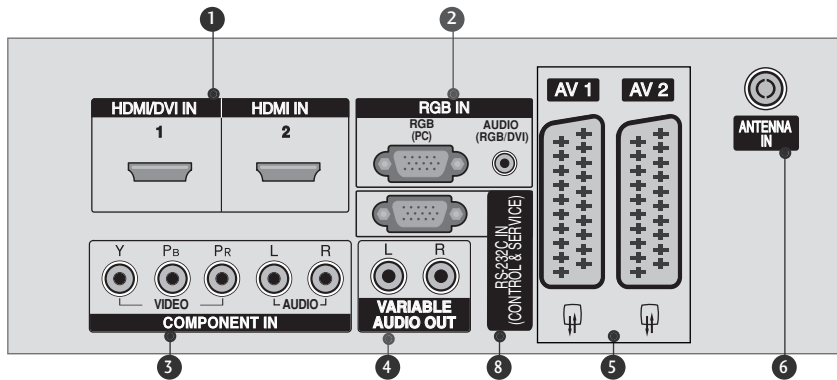

- 1 **HDMI Input**
Connect a HDMI signal to HDMI IN.
Or DVI(VIDEO)signal to HDMI/DVI port with DVI to HDMI cable.
- 2 **RGB/Audio Input**
Connect the monitor output from a PC to the appropriate input port.
- 3 **Component Input**
Connect a component video/audio device to these jacks.
- 4 **Variable Audio Output**
Connect an external amplifier or add a subwoofer to your surround sound system.
- 5 **Euro Scart Socket (AV1/AV2)**
Connect scart socket input or output from an external device to these jacks.
- 6 **Antenna Input**
Connect over-the-air signals to this jack.
- 7 **Power Cord Socket**
This TV operates on an AC power. The voltage is indicated on the Specifications page. Never attempt to operate the TV on DC power.
- 8 **RS-232C Input(CONTROL&SERVICE)Port**
Connect the serial port of the control devices to the RS-232C jack.

PREPARATION

STAND INSTALLATION (Only 26, 32, 37 inch LCD TV models)

- 1 Carefully place the product screen side down on a cushioned surface that will protect product and screen from damage.

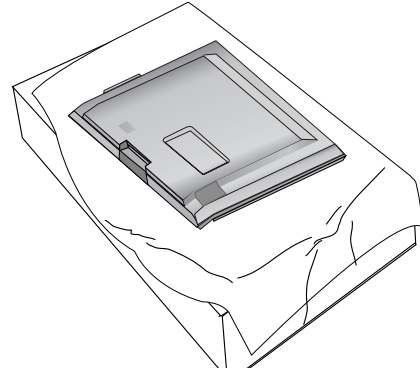

- 2 Assemble the product stand with the product as shown.

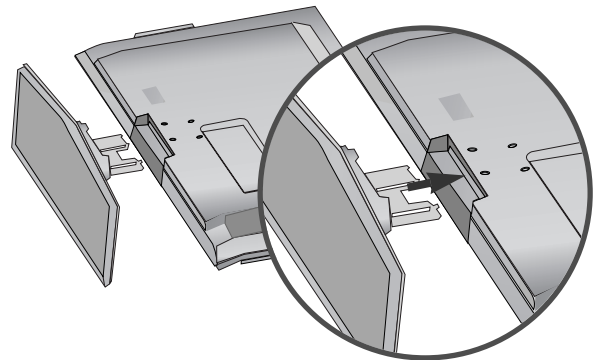

- 3 Install the 4 bolts securely, in the back of the product in the holes provided.

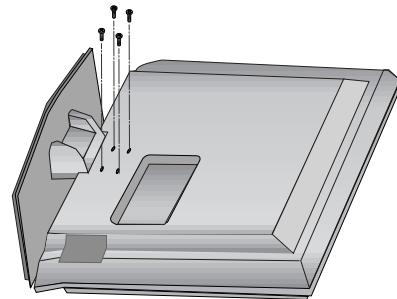

ATTACHING THE TV TO A WALL

- This feature is not available for all models.
- Set it up close to the wall so the product doesn't fall over when it is pushed backwards.
- The instructions shown below is a safer way to set up the product, which is to fix it on the wall so the product doesn't fall over when it is pulled in the forward direction. It will prevent the product from falling forward and hurting people. It will also prevent the product from damage caused by fall. Please make sure that children don't climb on or hang from the product.

Plasma TV models

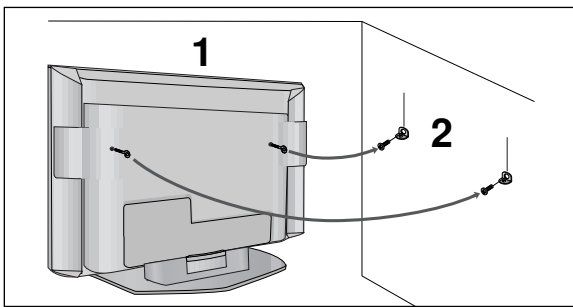

LCD TV models

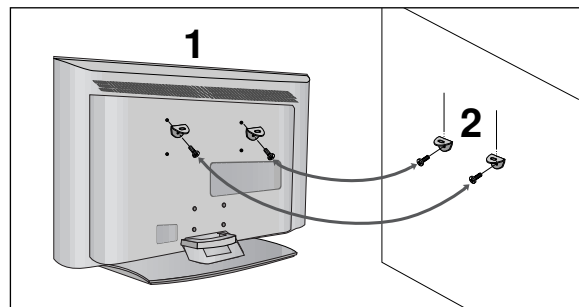

- 1 Use the eye-bolts or TV brackets/bolts to fix the product to the wall as shown in the picture.
(If your product has the bolts in the eye-bolts position before inserting the eye-bolts, loosen the bolts.)
* Insert the eye-bolts or TV brackets/bolts and tighten them securely in the upper holes.

- 2 Secure the wall brackets with the bolts (not provided as parts of the product, must purchase separately) on the wall. Match the height of the bracket that is mounted on the wall.

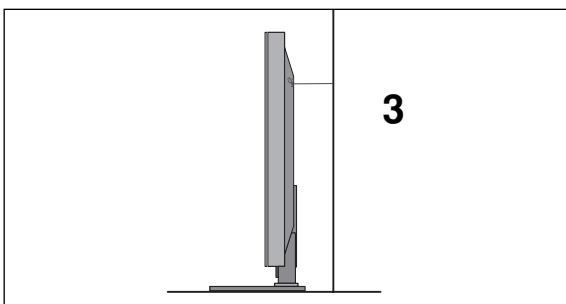

- 3 Use a sturdy rope (not provided as parts of the product, must purchase separately) to tie the product. It is safer to tie the rope so it becomes horizontal between the wall and the product.

! NOTE

- ▶ When moving the product to another place undo the ropes first.
- ▶ Use a product holder or a cabinet that is big and strong enough for the size and weight of the product.
- ▶ To use the product safely make sure that the height of the bracket that is mounted on the wall is same as that of the product.

PREPARATION

BACK COVER FOR WIRE ARRANGEMENT

Plasma TV models

- 1 Hold the **CABLE MANAGEMENT** with hands and push it as shown.

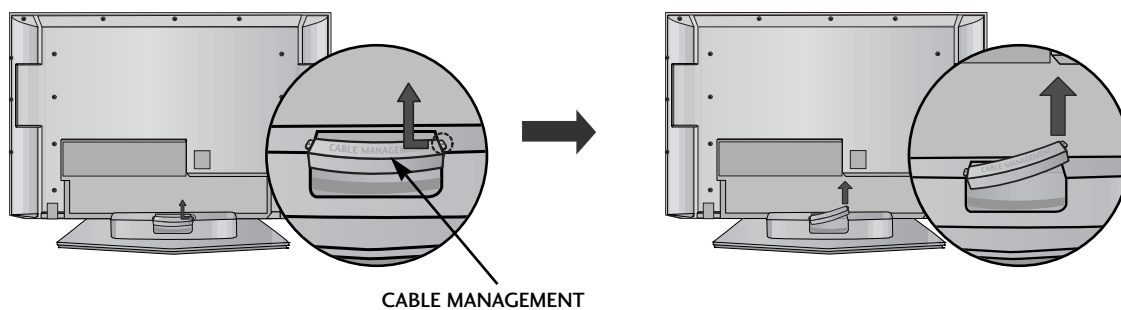

- 2 Connect the cables as necessary.

To connect an additional equipment, see the **External equipment Setup** section.

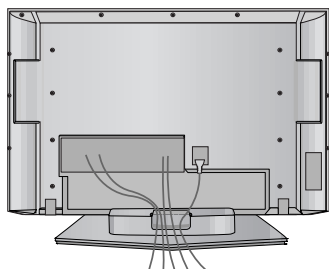

- 3 Reinstall the **CABLE MANAGEMENT** as shown.

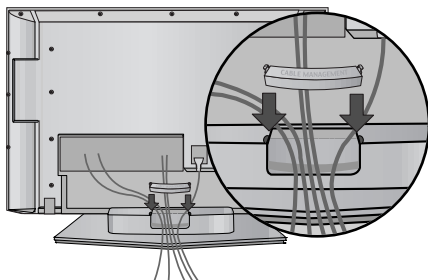

LCD TV models

- 1 Connect the cables as necessary.

To connect an additional equipment, see the **External equipment Setup** section.

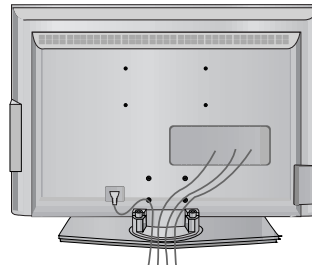

- 2 Install the **CABLE MANAGEMENT** as shown.

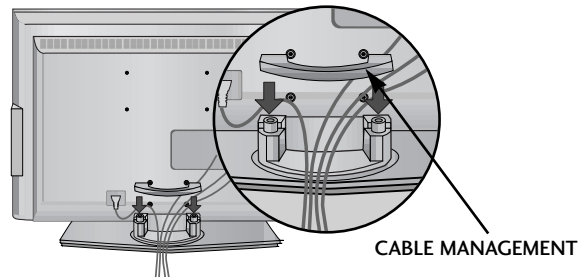

- 3 Bundle the cables using the supplied twister holder.
(This feature is not available for all models.)

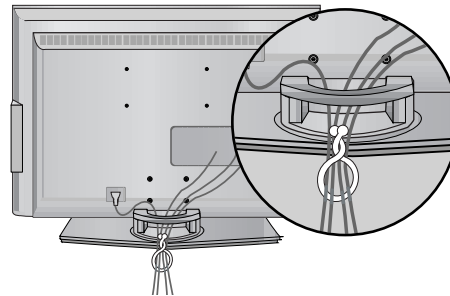

How to remove the cable management

Hold the **CABLE MANAGEMENT** with both hands and pull it upward.

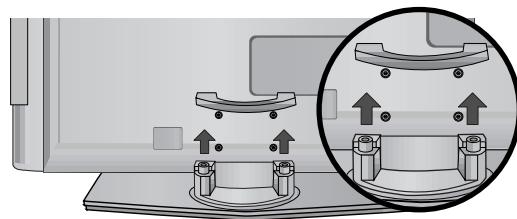

! NOTE

- ▶ Do not hold the **CABLE MANAGEMENT** when moving the product.
- If the product is dropped, you may be injured or the product may be broken.

PREPARATION

- The TV can be installed in various ways such as on a wall, or on a desktop etc.
- The TV is designed to be mounted horizontally.

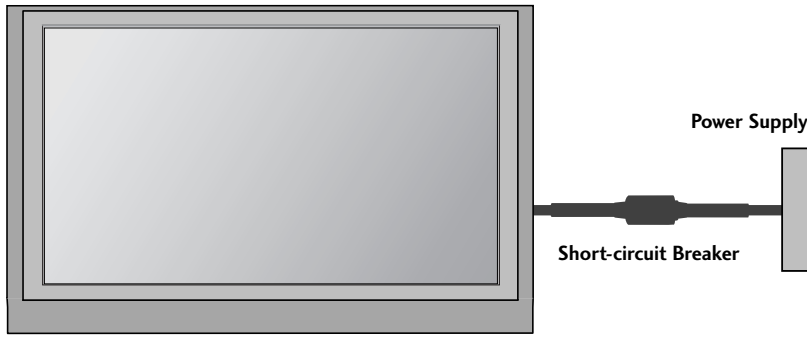

GROUNDING

Ensure that you connect the earth ground wire to prevent possible electric shock. If grounding methods are not possible, have a qualified electrician install a separate circuit breaker.

Do not try to ground the unit by connecting it to telephone wires, lightening rods, or gas pipes.

DESKTOP PEDESTAL INSTALLATION

For proper ventilation, allow a clearance of 4 inches on each side from the wall.

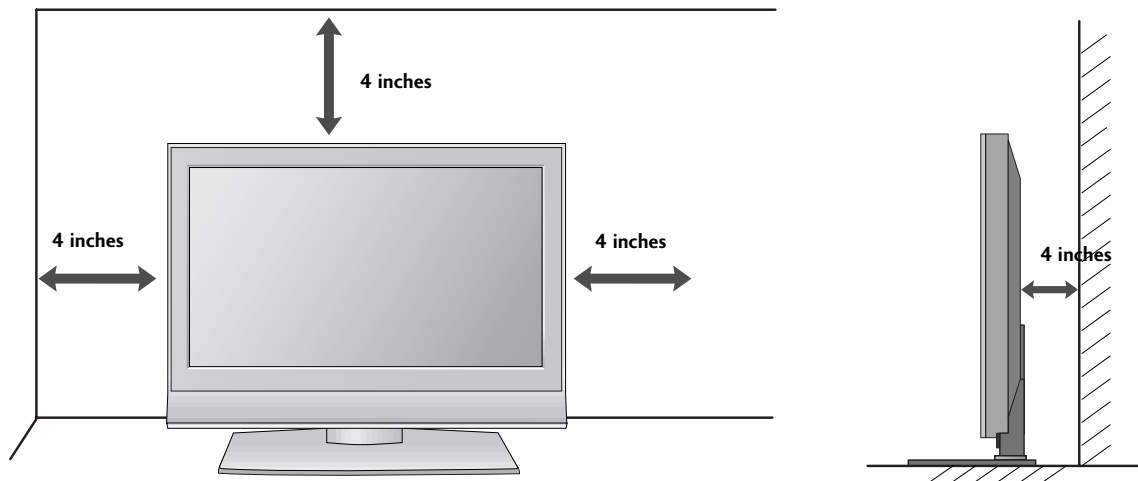

WALL MOUNT: HORIZONTAL INSTALLATION

For proper ventilation, allow a clearance of 4" on each side and from the wall. Detailed installation instructions are available from your dealer, see the optional Tilt Wall Mounting Bracket Installation and Setup Guide.

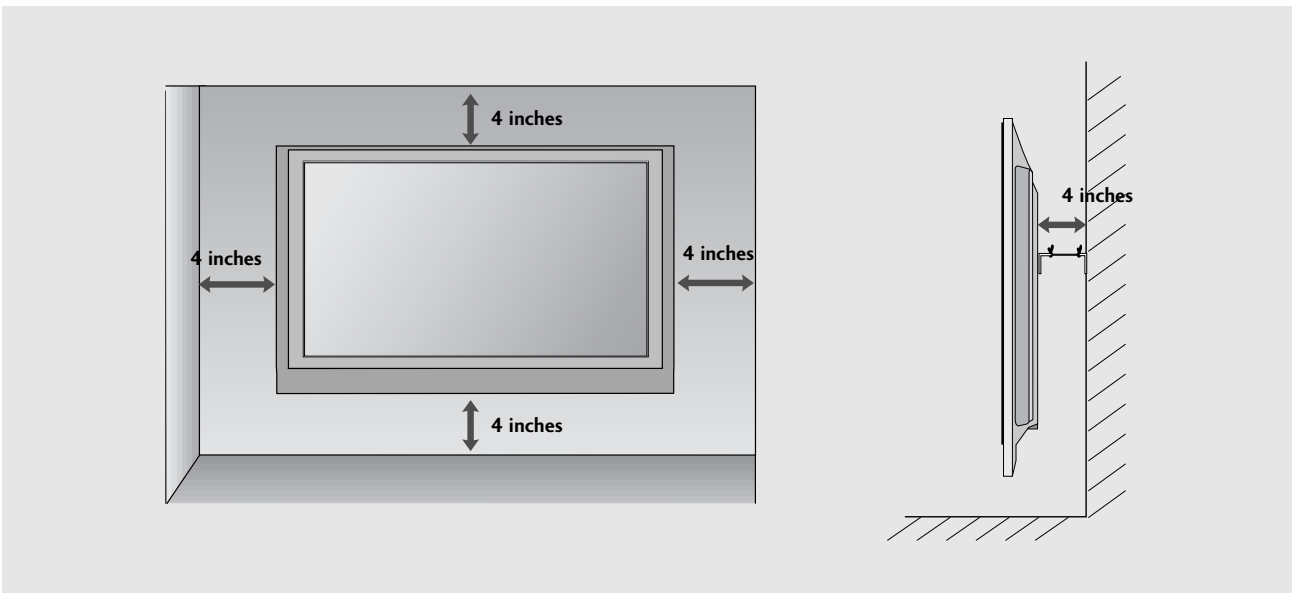
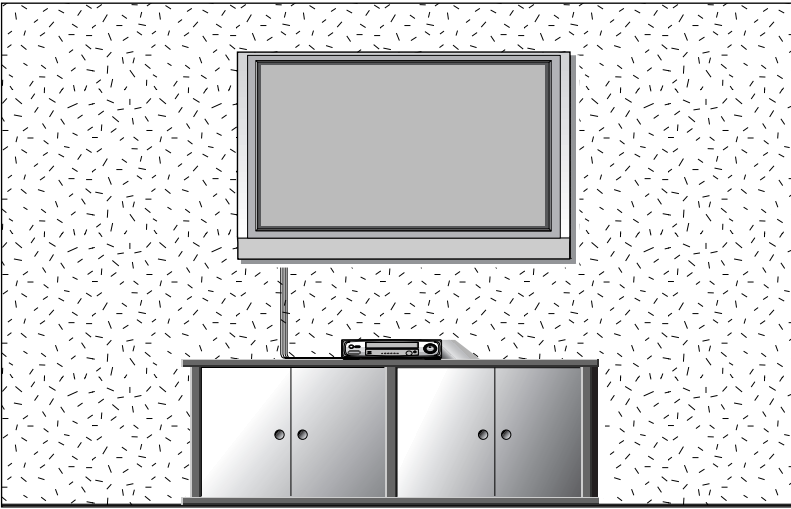

PREPARATION

- To prevent the equipment damage, never plug in any power cords until you have finished connecting all equipment.

ANTENNA CONNECTION

- For optimum picture quality, adjust antenna direction.
- An antenna cable and converter are not supplied.

PREPARATION

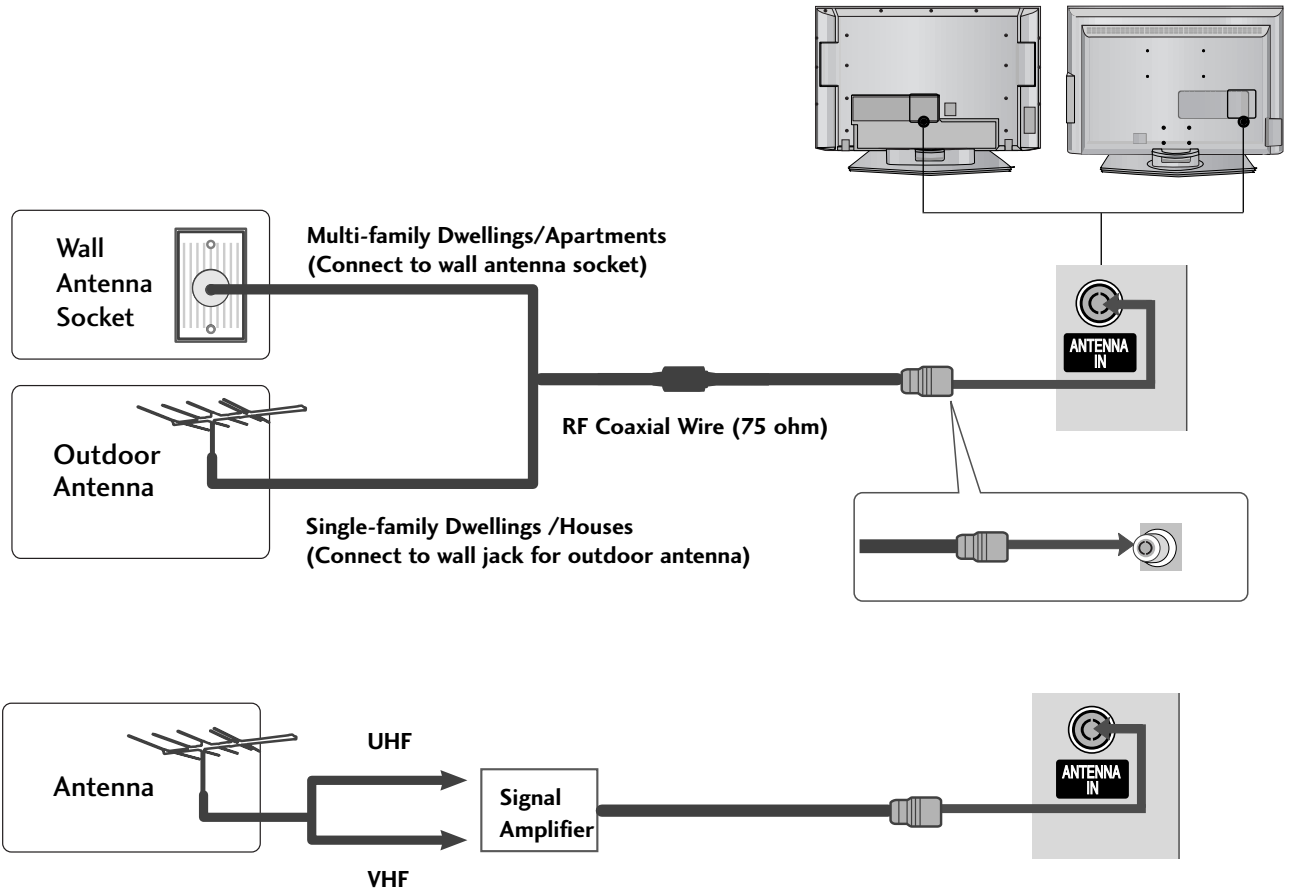

- In poor signal areas, to get better picture quality, install a signal amplifier to the antenna as shown above.
- If signal needs to be split for two TVs, use an antenna signal splitter for connection.

EXTERNAL EQUIPMENT SETUP

- To prevent the equipment damage, never plug in any power cords until you have finished connecting all equipment.
- This part of EXTERNAL EQUIPMENT SETUP mainly use pictures for the LCD TV models.

HD RECEIVER SETUP

When connecting with a component cable

- 1 Connect the video outputs (Y, PB, PR) of the digital set top box to the **COMPONENT IN VIDEO** jacks on the set.
- 2 Connect the audio output of the digital set-top box to the **COMPONENT IN AUDIO** jacks on the set.
- 3 Turn on the digital set-top box.
(Refer to the owner's manual for the digital set-top box.)
- 4 Select **Component** input source with using the **INPUT** button on the remote control.

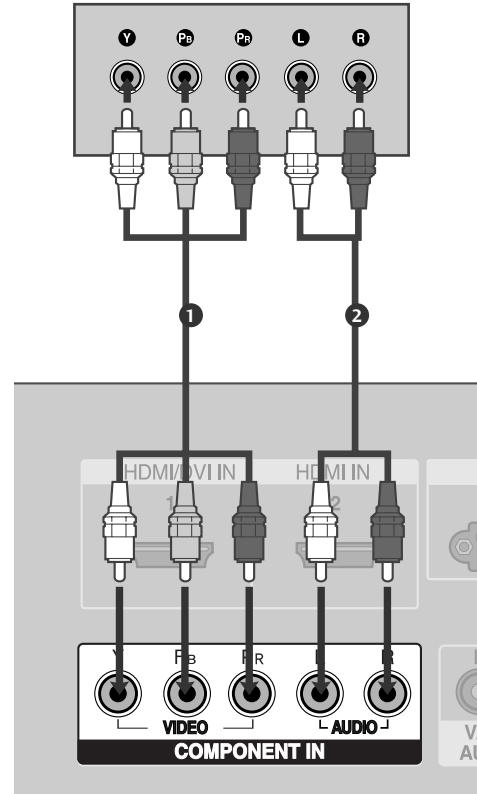

Signal	Component	HDMI1/2
480i/576i	Yes	No
480p/576p	Yes	Yes
720p/1080i	Yes	Yes
1080p	No	Yes

(except VGA Models)

EXTERNAL EQUIPMENT SETUP

When connecting with a HDMI cable

- 1 Connect the HDMI output of the digital set-top box to the **HDMI/DVI IN 1** or **HDMI IN 2** jack on the set.
- 2 Select **HDMI1** or **HDMI2** input source with using the **INPUT** button on the remote control.
- 3 Turn on the digital set-top box.
(Refer to the owner's manual for the digital set-top box.)

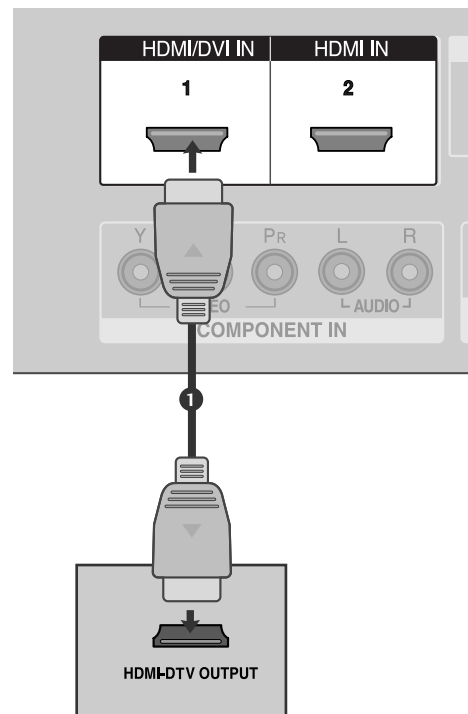

! NOTE

- ▶ TV can receive the video and audio signal simultaneously with using a HDMI cable.
- ▶ If the digital set-top box supports Auto HDMI function, the output resolution of the source device will be automatically set to 1280x720p.
- ▶ If the digital set-top box player does not support Auto HDMI, you need to set the output resolution appropriately.
To get the best picture quality, adjust the output resolution of the source device to 1280x720p.

When connecting with a HDMI to DVI cable

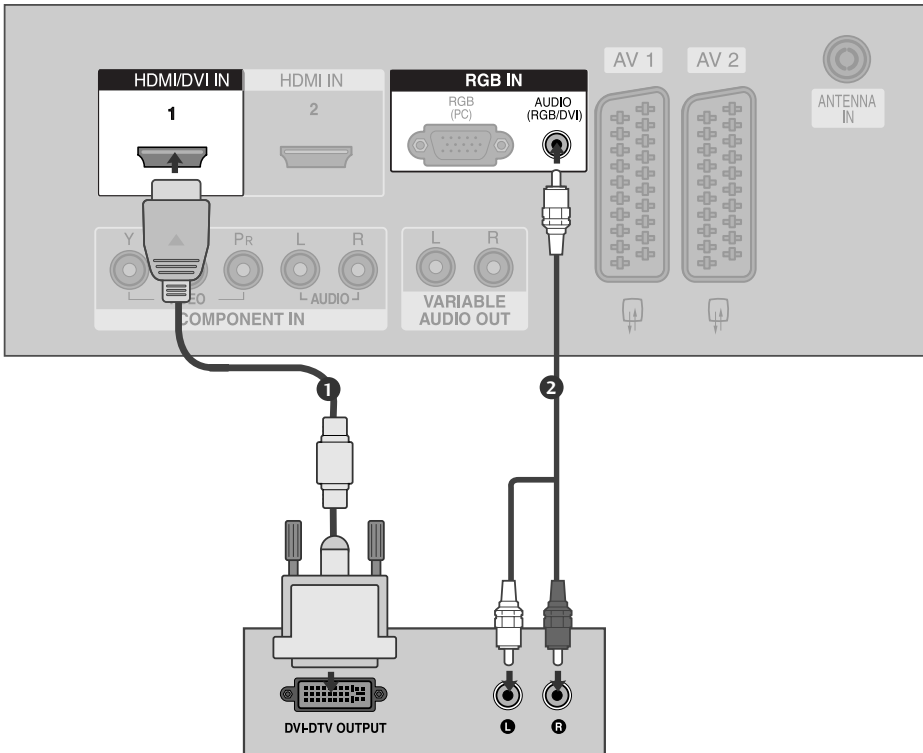

- 1 Connect the DVI output of the digital set-top box to the **HDMI/DVI IN 1** jack on the set.
- 2 Connect the audio output of the digital set-top box to the **AUDIO(RGB/DVI)** jack on the set.
- 3 Turn on the digital set-top box. (Refer to the owner's manual for the digital set-top box.)
- 4 Select **HDMI1** input source with using the **INPUT** button on the remote control.

EXTERNAL EQUIPMENT SETUP

DVD SETUP

When connecting with a component cable

- 1 Connect the video outputs (Y, PB, PR) of the DVD to the **COMPONENT IN VIDEO** jacks on the set.
- 2 Connect the audio outputs of the DVD to the **COMPONENT IN AUDIO** jacks on the set.
- 3 Turn on the DVD player, insert a DVD.
- 4 Select **Component** input source with using the **INPUT** button on the remote control.
- 5 Refer to the DVD player's manual for operating instructions.

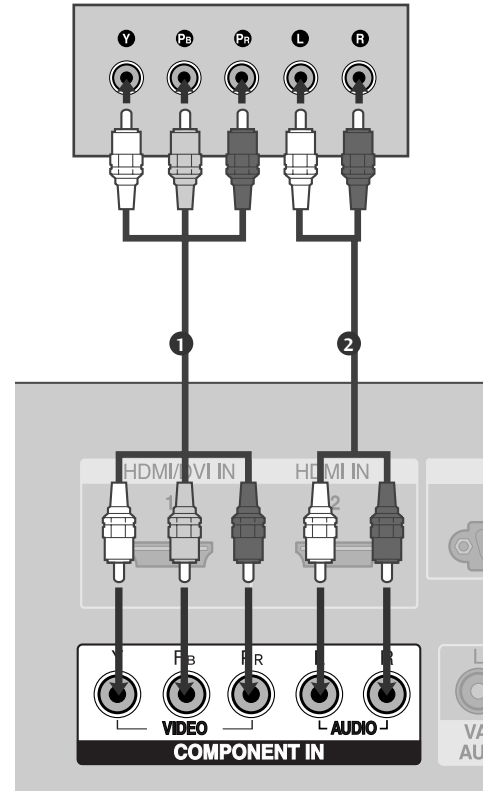

Component Input ports

To get better picture quality, connect a DVD player to the component input ports as shown below.

Component ports on the TV	Y	P _B	P _R
Video output ports on DVD player	Y	P _B	P _R
	Y	B-Y	R-Y
	Y	C _b	C _r
	Y	P _b	P _r

When connecting with a Euro Scart

- 1 Connect the Euro scart socket of the DVD to the **AV1** Euro scart socket on the set.
.....
- 2 Turn on the DVD player, insert a DVD.
.....
- 3 Select **AV1** input source with using the **INPUT** button on the remote control.
If connected to **AV2** Euro scart socket, select **AV2** input source.
.....
- 4 Refer to the DVD player's manual for operating instructions.

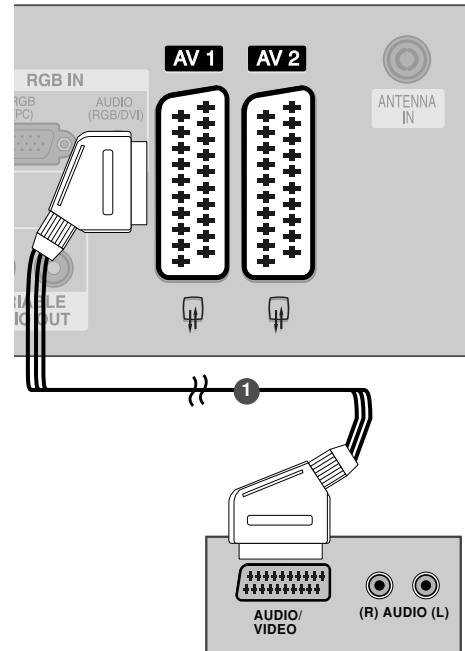

! NOTE

- ▶ Please use the shield scart cable.

When connecting with an S-Video cable

- 1 Connect the S-VIDEO output of the DVD to the **S-VIDEO** input on the set.
.....
- 2 Connect the audio outputs of the DVD to the **AUDIO** input jacks on the set.
.....
- 3 Turn on the DVD player, insert a DVD.
.....
- 4 Select **AV3** input source with using the **INPUT** button on the remote control.
.....
- 5 Refer to the DVD player's manual for operating instructions.

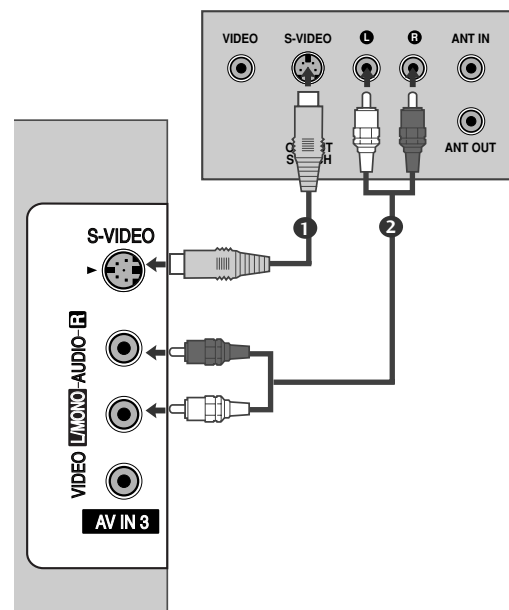

EXTERNAL EQUIPMENT SETUP

When connecting HDMI cable

- 1 Connect the HDMI output of the DVD to the **HDMI/DVI IN 1** or **HDMI IN 2** jack on the set.
- 2 Select **HDMI1** or **HDMI2** input source with using the **INPUT** button on the remote control.
- 3 Refer to the DVD player's manual for operating instructions.

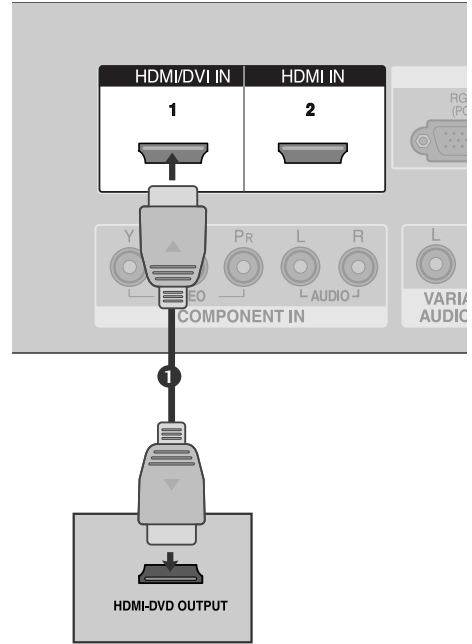

! NOTE

- ▶ TV can receive the video and audio signal simultaneously with using a HDMI cable.
- ▶ If the DVD supports Auto HDMI function, the output resolution of the source device will be automatically set to 1280x720p.
- ▶ If the DVD player does not support Auto HDMI, you need to set the DVD output resolution appropriately.
To get the best picture quality, adjust the output resolution of the source device to 1280x720p.

Supported Display Resolution (HDMI-DTV mode)

Resolution	Horizontal Frequency(KHz)	Vertical Frequency(Hz)
720x480	31.47	59.94
	31.50	60.00
720x576	31.25	50.00
1280x720	44.96	59.94
	45.00	60.00
	37.50	50.00
1920x1080i	33.72	59.94
	33.75	60.00
	28.125	50.00
(except VGA Models) 1920x1080p	67.432	59.94
	67.5	60
	56.25	50

VCR SETUP

- To avoid picture noise (interference), leave an adequate distance between the VCR and TV.
- Typically a frozen still picture from a VCR. If the 4:3 picture format is used; the fixed images on the sides of the screen may remain visible on the screen.

When connecting with an antenna

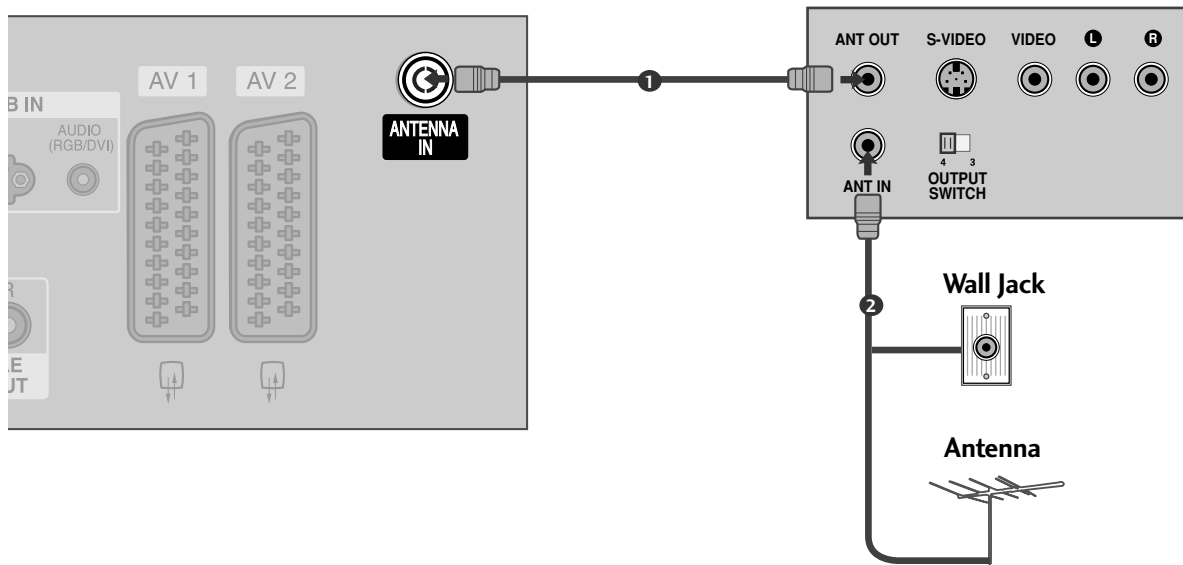

- 1** Connect the **ANT OUT** socket of the VCR to the **ANTENNA IN** socket on the set.
.....
- 2** Connect the antenna cable to the **ANT IN** socket of the VCR.
.....
- 3** Press the **PLAY** button on the VCR and match the appropriate programme between the TV and VCR for viewing.
.....

EXTERNAL EQUIPMENT SETUP

When connecting with a Euro Scart

- 1 Connect the Euro scart socket of the VCR to the **AV1** Euro scart socket on the set.
.....
- 2 Insert a video tape into the VCR and press **PLAY** on the VCR. (Refer to the VCR owner's manual.)
.....
- 3 Select **AV1** input source with using the **INPUT** button on the remote control.
If connected to **AV2** Euro scart socket, select **AV2** input source.

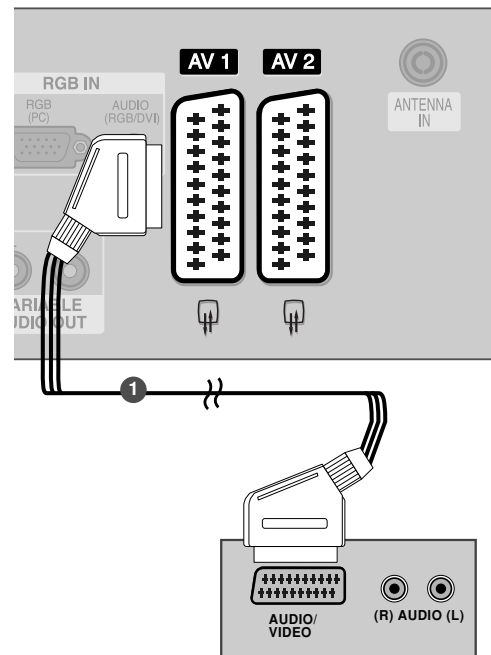

! NOTE

- ▶ If you want to use the EURO scart cable, you have to use the signal shielded Euro scart cable.

When connecting with a RCA cable

- 1 Connect the **AUDIO/VIDEO** jacks between TV and VCR. Match the jack colours (Video = yellow, Audio Left = white, and Audio Right = red)
- 2 Insert a video tape into the VCR and press **PLAY** on the VCR. (Refer to the VCR owner's manual.)
- 3 Select **AV3** input source using the **INPUT** button on the remote control.

! NOTE

- ▶ If you have a mono VCR, connect the audio cable from the VCR to the **AUDIO L/MONO** jack of the set.

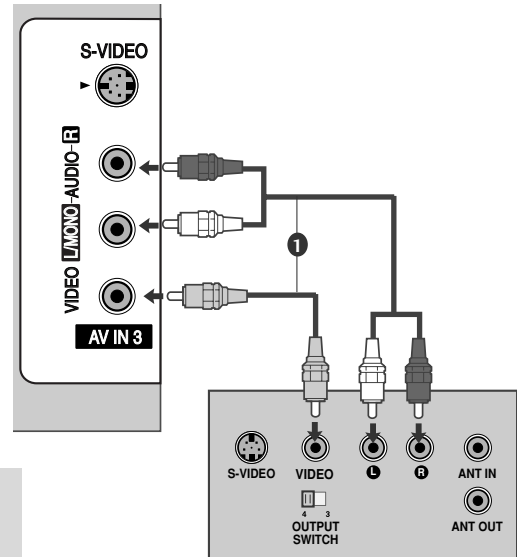

When connecting with an S-Video cable

- 1 Connect the **S-VIDEO** output of the VCR to the **S-VIDEO** input on the set. The picture quality is improved; compared to normal composite (RCA cable) input.
- 2 Connect the audio outputs of the VCR to the **AUDIO** input jacks on the set.
- 3 Insert a video tape into the VCR and press **PLAY** on the VCR. (Refer to the VCR owner's manual.)
- 4 Select **AV3** input source with using the **INPUT** button on the remote control.

! NOTE

- ▶ If both **S-VIDEO** and **VIDEO** sockets have been connected to the **S-VHS** VCR simultaneously, only the **S-VIDEO** can be received.

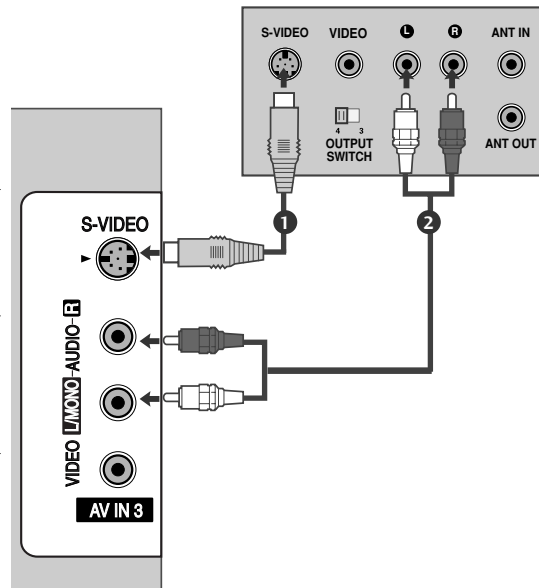

EXTERNAL EQUIPMENT SETUP

OTHER A/V SOURCE SETUP

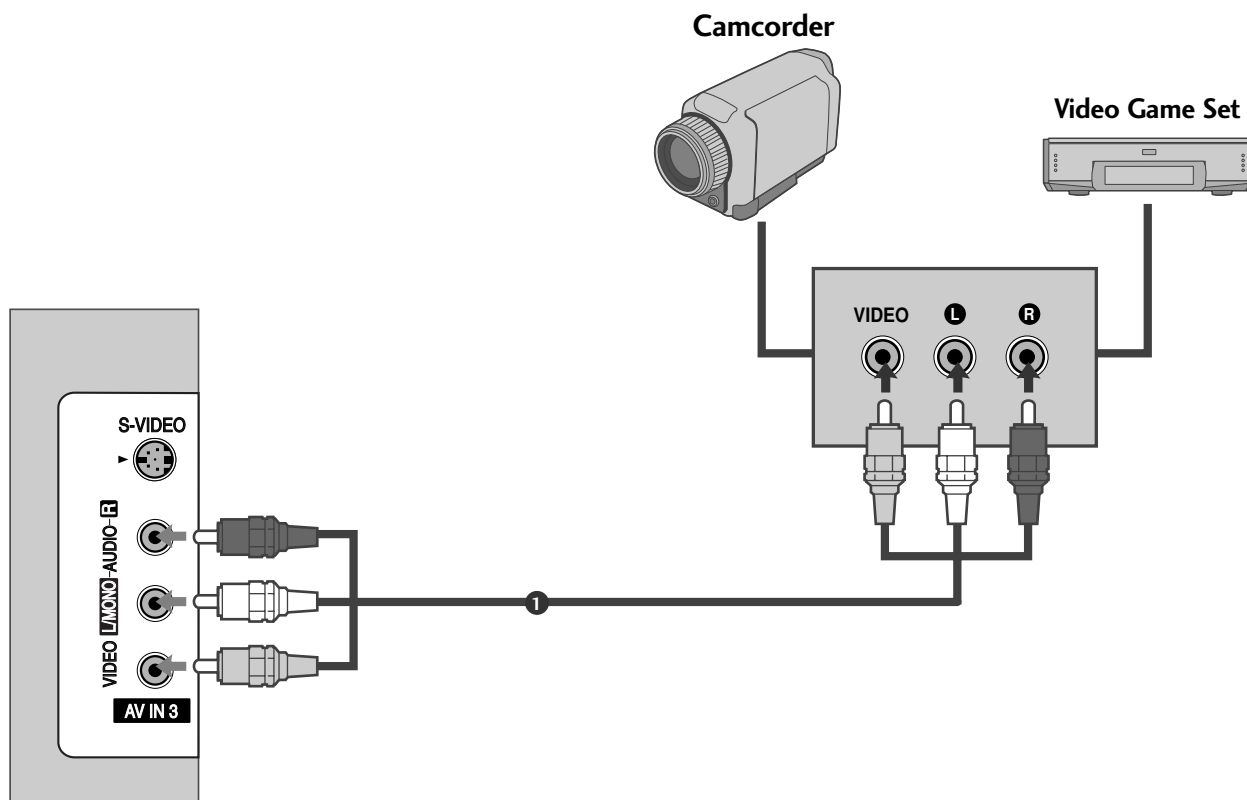

- 1 Connect the **AUDIO/VIDEO** jacks between TV and external equipment. Match the jack colours. (Video = yellow, Audio Left = white, and Audio Right = red)
- 2 Select **AV3** input source with using the **INPUT** button on the remote control.
- 3 Operate the corresponding external equipment. Refer to external equipment operating guide.

EXTERNAL STEREO

Use to connected either an external amplifier, or add a sub-woofer to your surround sound system.

- 1 Connect the input jack of the stereo amplifier to the **VARIABLE AUDIO OUT** jacks on the set.
- 2 Set up your speakers through your analog stereo amplifier, according to the instructions provided with the amplifier.

! NOTE

- ▶ When connecting with external audio equipments, such as amplifiers or speakers, please turn the TV speakers off. (▶ p.63)

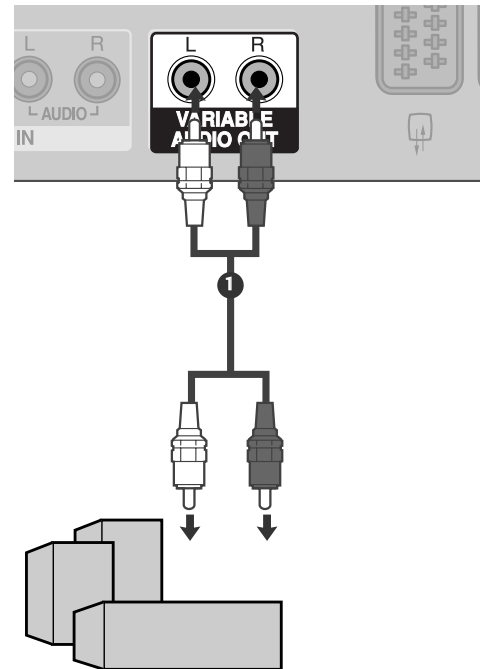

EXTERNAL EQUIPMENT SETUP

PC SETUP

This TV provides Plug and Play capability, meaning that the PC adjusts automatically to the TV's settings.

When connecting with a D-sub 15 pin cable

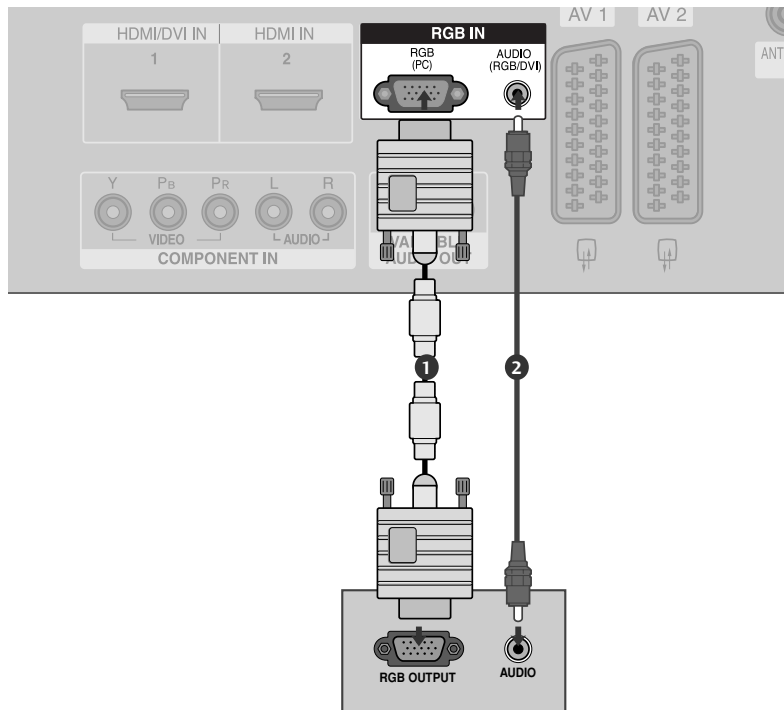

- 1 Connect the RGB output of the PC to the **RGB (PC)** jack on the set.
.....
- 2 Connect the PC audio output to the **AUDIO** jack on the set.
.....
- 3 Turn on the PC and the set.
.....
- 4 Select **RGB PC** input source with using the **INPUT** button on the remote control.

! NOTE

- ▶ To enjoy vivid picture and sound, connect a PC to the set.
- ▶ Avoid keeping a fixed image on the set's screen for a long period of time. The fixed image may become permanently imprinted on the screen; use a screen saver when possible.
- ▶ Connect PC to the RGB (PC) port of the set; change the resolution output of PC accordingly.
- ▶ There might be noise according to some resolution, vertical pattern, contrast or brightness in PC mode. Change the PC mode into another resolution or change the refresh rate into another rate or adjust the brightness and contrast on the menu until the picture is clean. If the refresh rate of the PC graphic card can not be changed, change the PC graphic card or consult it to the manufacturer of the PC graphic card.
- ▶ The synchronization input waveform for Horizontal and Vertical frequencies are separate.
- ▶ We recommend using 1366x768, 60Hz (LCD TV models) / 852x480, 60Hz (42 inch WVGA PLASMA TV models) / 1024x768, 60Hz (42 inch XGA PLASMA TV models) / 1360x768, 60Hz (50 inch PLASMA TV models) for the PC mode, they provide the best picture quality.
- ▶ If the resolution of PC is over SXGA, there will be no picture on the set.
- ▶ Connect the audio cable from the PC to the Audio input on the set. (Audio cables are not included with the set).
- ▶ When you use too long RGB-PC cable, there might be a noise on the screen. We recommend using under 5m of the cable. It provides the best picture quality.

Supported Display Resolution (RGB-PC mode)

Resolution	Horizontal Frequency(kHz)	Vertical Frequency(Hz)
640x350	31.5	70.1
720x400	31.5	70.1
640x480	31.5	59.9
848x480	31.5	60.0
852x480	31.5	60.0
800x600	37.9	60.3
1024x768	48.4	60.0
1280x768	47.8	59.9
1360x768	47.7	59.8
1366x768	47.7	59.8

! NOTE

- ▶ It's supported to 848x480, 852x480 in VGA modes. (VGA Models)
- ▶ It's supported to 1280x768, 1360x768, 1366x768 in XGA modes. (XGA Models)

EXTERNAL EQUIPMENT SETUP

Screen Setup for PC mode

Auto Configure (RGB [PC] mode only)

Automatically adjusts picture position and minimizes image shaking. After adjustment, if the image is still not correct, your set is functioning properly but needs further adjustment.

Auto configure

This function is for the automatic adjustment of the screen position, clock, and phase. The displayed image will unstable for a few seconds while the auto configuration is in progress.



1 Press the **MENU** button and then use ▲ / ▼ button to select the **Picture** menu.

2 Press the ► button and then use ▲ / ▼ button to select **Screen**.

3 Press the ► button and then use ▲ / ▼ button to select **Auto Config..**

4 Press the ► button to start **Auto Config..**

- When Auto config. has finished, OK will be shown on screen.
- If the position of the image is still not correct, try Auto adjustment again.

- If picture needs to be adjusted more after Auto adjustment in RGB (PC), you can adjust the **Manual Config..**

5 Press the **EXIT** button to return to TV viewing.

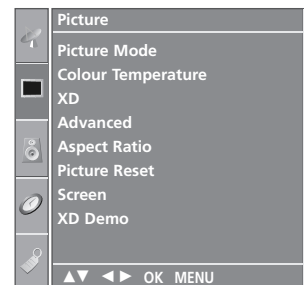

1

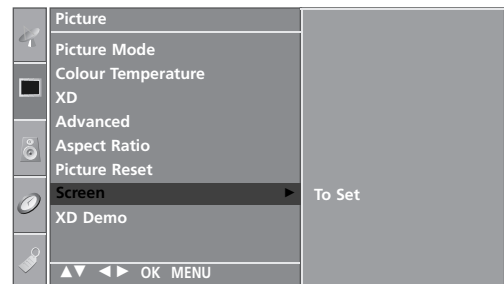

2

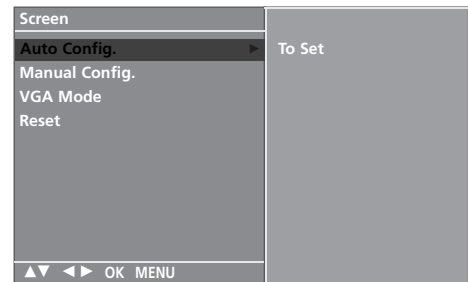

3 4

Adjustment for screen Phase, Clock, Position

If the picture isn't clear after auto adjustment and especially if characters are still trembling, adjust the picture phase manually.

To correct the screen size, adjust **Clock**.

This function works in the following mode : RGB[PC], COMPONENT (480i/480p/576i/576p/720p/1080i), HDMI (480p/576p/720p/1080i/1080p(except VGA Models)).

It's not available to use Phase, Clock function in COMPONENT (480i/480p/576i/576p/720p/1080i), HDMI (480p/576p/720p/1080i/1080p(except VGA Models)).

Clock This function is to minimize any vertical bars or stripes visible on the screen background. And the horizontal screen size will also change.

Phase This function allows you to remove any horizontal noise and clear or sharpen the image of characters.

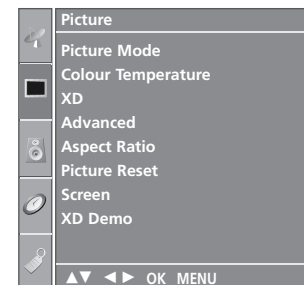

1

- 1 Press the **MENU** button and then use **▲ / ▼** button to select the **Picture** menu.

- 2 Press the **▶** button and then use **▲ / ▼** button to select **Screen**.

- 3 Press the **▶** button and then use **▲ / ▼** button to select **Manual Config..**

- 4 Press the **▶** button and then use **▲ / ▼** button to select **Phase, Clock, H-Position** or **V-Position**.

- 5 Press the **◀ / ▶** button to make appropriate adjustments.

- 6 Press the **EXIT** button to return to TV viewing.

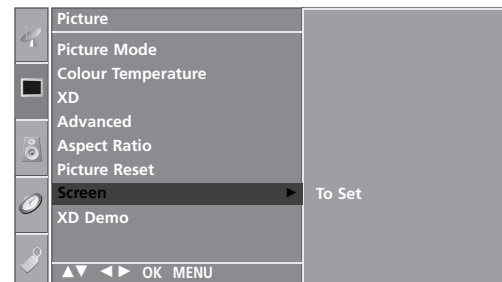

2

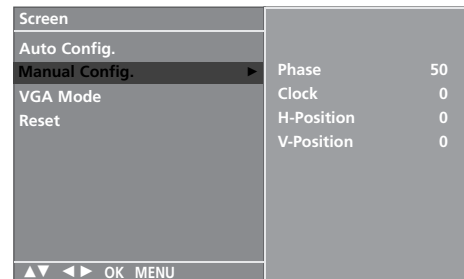

3 4 5

EXTERNAL EQUIPMENT SETUP

Selecting Wide VGA/XGA mode

To see a normal picture, match the resolution of RGB mode and selection of VGA/XGA mode.

This function works in the following mode: RGB[PC] mode.



1 Press the **MENU** button and then use ▲ / ▼ button to select the **Picture** menu.

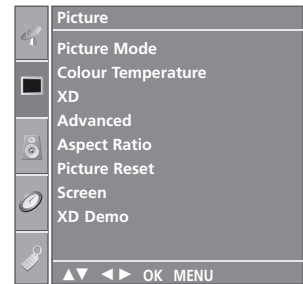

1

2 Press the ► button and then use ▲ / ▼ button to select **Screen**.

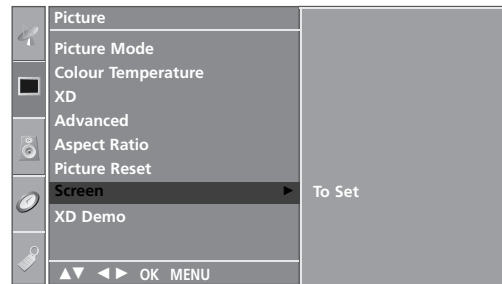

2

3 Press the ► button and then use ▲ / ▼ button to select **VGA Mode** (or **XGA Mode**).

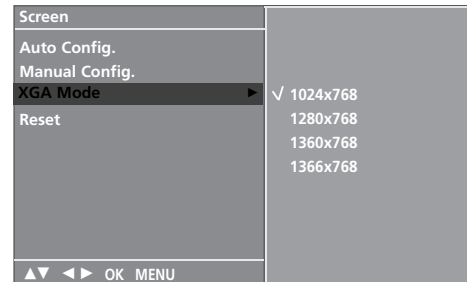

3 4

4 Press the ► button and then use ▲ / ▼ button to select the desired **VGA/XGA** resolution.

5 Press the **EXIT** button to return to TV viewing.

Initializing (Reset to original factory settings)

This function operates in current mode.
To initialize the adjusted value



- 1 Press the MENU button and then use ▲ / ▼ button to select the **Picture** menu.
- 2 Press the ► button and then use ▲ / ▼ button to select **Screen**.
- 3 Press the ► button and then use ▲ / ▼ button to select **Reset**.
- 4 Press the ► button.
- 5 Press the EXIT button to return to normal TV viewing.

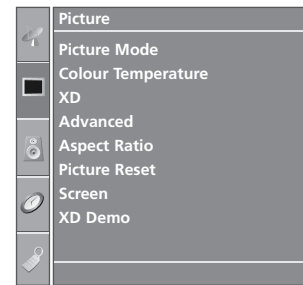

1

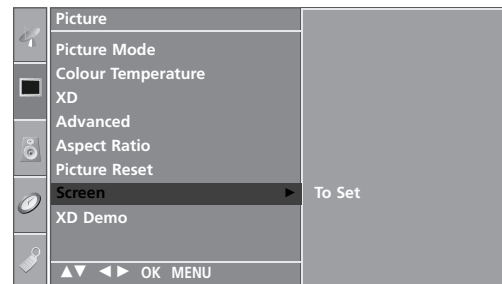

2

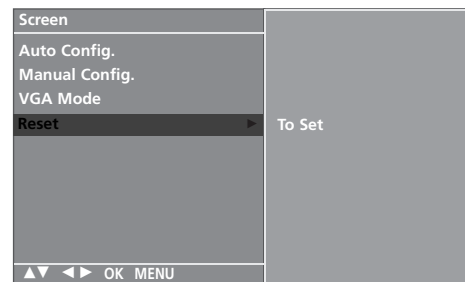

3 4

WATCHING TV / PROGRAMME CONTROL

REMOTE CONTROL KEY FUNCTIONS

When using the remote control, aim it at the remote control sensor on the TV.



POWER Switches the set on from standby or off to standby.

TV INPUT Returns to the TV viewing from any mode.
Switches the set on from standby.

INPUT If you press the button once, the input source OSD will appear on screen as shown. Press the ▲ / ▼ button and then OK button to select the desired input source (TV, AV1 , AV2, AV3, Component , RGB PC, HDMI1 or HDMI2).

RATIO Selects your desired picture format.

Brightness adjustment Adjusts screen brightness.
It returns to the default settings brightness by changing mode source.

SIMPLINK See a list of AV devices connected to TV.
When you toggle this button, the Simplink menu appears at the screen. (▶ p.44)

SLEEP Sets the sleep timer.

I/II Selects the sound output.

Coloured buttons These buttons are used for teletext (only **TELETEXT** models) or **Programme edit**.

VCR/DVD control buttons Controls some video cassette recorders or DVD players when you have already selected DVD or VCR mode button. Control connected AV devices by pressing the ▲ / ▼ / ◀ / ▶, **OK** buttons and buttons for play, stop, pause, fast reverse, fast forward, chapter skip.
(The ○ button does not provide such functions.)

EXIT Clears all on-screen displays and returns to TV viewing from any menu.

LIST Displays the programme table.

MENU Selects a menu.

Q.VIEW Returns to the previously viewed programme.

* No function

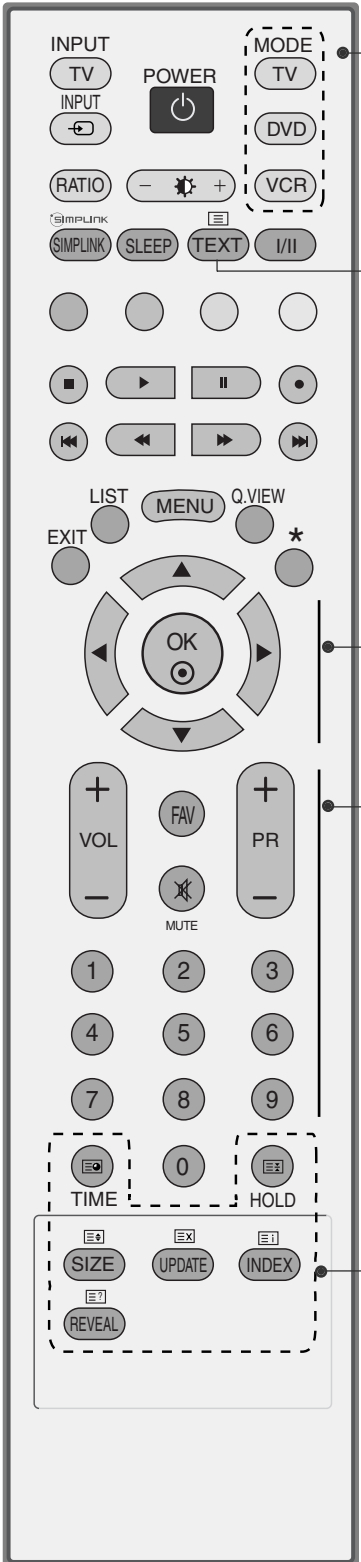

MODE Selects the remote operating modes.

1 TELETEXT BUTTONS These buttons are used for teletext. For further details, see the 'Teletext' section.

2 THUMBSTICK (Up/Down/Left Right) Allows you to navigate the on-screen menus and adjust the system settings to your preference.

OK Accepts your selection or displays the current mode.

VOLUME UP/DOWN Adjusts the volume.

FAV Displays the selected favourite programme.

MUTE Switches the sound on or off.

Programme UP/DOWN Selects a programme.

0~9 number buttons Selects a programme. Selects numbered items in a menu.

Installing Batteries

- Open the battery compartment cover on the back side and install the batteries matching correct polarity (+with +,-with -).
- Install two 1.5V AA batteries. Don't mix old or used batteries with new ones.
- Close cover.

WATCHING TV / PROGRAMME CONTROL

TURNING ON THE TV

If your TV will be turned on, you will be able to use its features.

- 1 First, connect power cord correctly.
At this moment, the TV switches to standby mode.
 - In standby mode to turn TV on, press the $\phi/1$, INPUT, PR \blacktriangle / \blacktriangledown button on the TV or press the POWER, TV, INPUT, PR +/-, NUMBER(0~9) buttons on the remote control and then the TV will switch on.

PROGRAMME SELECTION

- 1 Press the PR +/- or NUMBER buttons to select a programme number.

VOLUME ADJUSTMENT

- 1 Press the VOL +/- button to adjust the volume.
- 2 If you want to switch the sound off, press the MUTE button.
- 3 You can cancel the Mute function by pressing the MUTE, VOL +/- or I/II button.



ON SCREEN MENU SELECTION AND ADJUSTMENT

Your TV's OSD (On Screen Display) may differ slightly from what is shown in this manual. The OSD mainly use pictures for the Plasma TV models.

- 1 Press the **MENU** button and then ▲ / ▼ button to display each menu.
- 2 Press the ► button and then ▲ / ▼ button to select a menu item.
- 3 Change the setting of an item in the sub or pull-down menu with ◀ / ▶ button. You can move to the higher level menu by pressing the **OK** or **MENU** button.

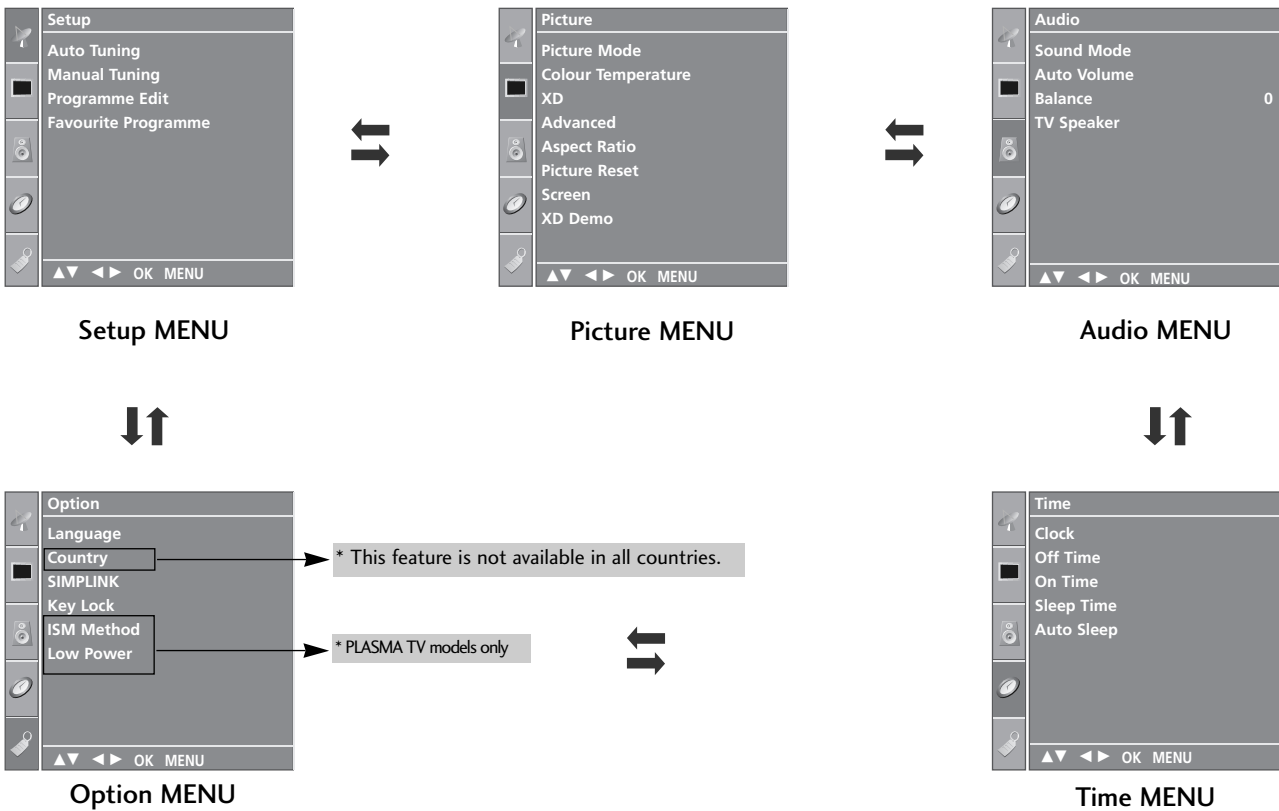

! NOTE

- a. The OSD (On Screen Display) function enables you to adjust the screen status conveniently since it provides graphical presentation.
- b. In this manual, the OSD (On Screen Display) may be different from your TV's because it is just example to help the TV operation.
- c. In the teletext mode, menus are not displayed.

WATCHING TV / PROGRAMME CONTROL

AUTO PROGRAMME TUNING

Up to 100 TV stations can be stored by programme numbers (0 to 99). Once you have preset the stations, you will be able to use the PR +/- or NUMBER buttons to scan the stations you have programmed. Stations can be tuned using automatic or manual modes.

All stations that can be received are stored by this method. It is recommended that you use auto programme during installation of this set.

1 Press the **MENU** button and then **▲ / ▼** button to select the **Setup** menu.

2 Press the **▶** button and then **▲ / ▼** button to select **Auto Tuning**.

3 Press the **▶** button and then **▲ / ▼** button to select **System**.

4 Press the **▲ / ▼** button to select a TV system menu;
BG: PAL B/G, SECAM B/G (Europe / East Europe / Asia / NewZealand / M.East / Africa / Australia)
I : PAL I/II (U.K. / Ireland / Hong Kong / South Africa)
DK: PAL D/K, SECAM D/K (East Europe / China / Africa / CIS)
L : SECAM L/L' (France)
M : (USA / Korea / Philippines) (option)

5 Press the **▲ / ▼** button to select **Storage From**.

6 Press the **◀ / ▶** button or NUMBER buttons to select the beginning programme number. If you use NUMBER buttons, any number under 10 is entered with a numeric '0' in front of it, i.e. '05' for 5.

7 Press the **▲ / ▼** button to select **Search**.

8 Press the **▶** button to begin auto tuning. All receivable stations are stored. The station name is stored for stations which broadcast VPS (Video Programme Service), PDC (Programme Delivery Control) or TELETEXT data. If no station name can be assigned to a station, the channel number is assigned and stored as C (V/UHF 01-69) or S (Cable 01-47), followed by a number.

To stop auto tuning, press the **MENU** button.

When auto tuning is completed, the Programme edit menu appears on the screen. See the Programme edit section to edit the stored programme.

9 Press the **EXIT** button to return to normal TV viewing.



1

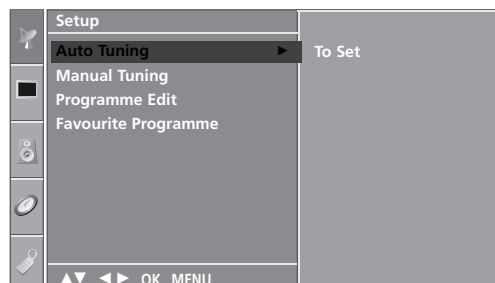

2

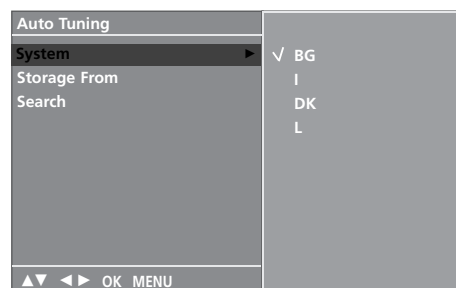

3 4 5 6 7

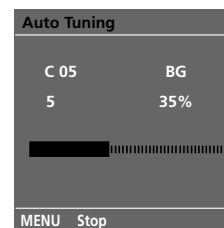

8

MANUAL PROGRAMME TUNING

Manual programme lets you manually tune and arrange the stations in whatever order you desire.



- 1 Press the **MENU** button and then **▲ / ▼** button to select the **Setup** menu.
- 2 Press the **▶** button and then **▲ / ▼** button to select **Manual Tuning**.
- 3 Press the **▶** button and then **▲ / ▼** button to select **Storage**.
- 4 Press the **◀ / ▶** button or **NUMBER** buttons to select the desired programme number (0 to 99). If you use **NUMBER** buttons, any number under 10 is entered with a numeric '0' in front of it, i.e. '05' for 5.
- 5 Press the **▲ / ▼** button to select **System**.
- 6 Press the **▲ / ▼** button to select a TV system menu;
 - BG : PAL B/G, SECAM B/G (Europe / East Europe / Asia / NewZealand / M.East / Africa / Australia)
 - I : PAL I/II (U.K. / Ireland / Hong Kong / South Africa)
 - DK : PAL D/K, SECAM D/K (East Europe / China / Africa / CIS)
 - L : SECAM L/L' (France)
 - M : (USA / Korea / Philippines) (option)
- 7 Press the **▲ / ▼** button to select **Band**.
- 8 Press the **▶** button and then **▲ / ▼** button to select **V/UHF** or **Cable**.
- 9 Press the **▲ / ▼** button to select **Channel**.
- 10 You can select the desired programme number with the **◀ / ▶** button or **NUMBER** buttons. If possible, select the programme number directly with the number buttons. Any number under 10 is entered with a numeric '0' in front of it, i.e. '05' for 5.
- 11 Press the **▲ / ▼** button to select **Search**.
- 12 Press the **◀ / ▶** button to commence searching. If a station is found the search will stop.
- 13 Press the **OK** button to store it.
- 14 To store another station, repeat steps 3 to 13.
- 15 Press the **EXIT** button to return to normal TV viewing.



1

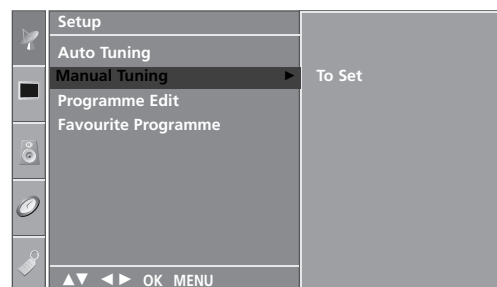

2

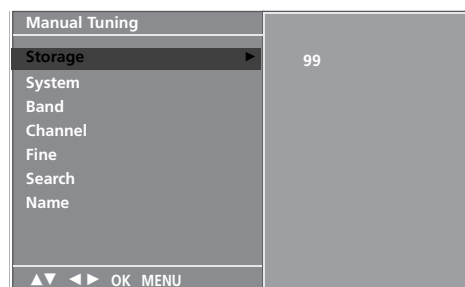

3 4 5 6 7
8 9 10 11 12

WATCHING TV / PROGRAMME CONTROL

FINE TUNING

Normally fine tuning is only necessary if reception is poor.

- 1 Press the **MENU** button and then **▲ / ▼** button to select the **Setup** menu.
- 2 Press the **▶** button and then **▲ / ▼** button to select **Manual Tuning**.
- 3 Press the **▶** button and then **▲ / ▼** button to select **Fine**.
- 4 Press the **▶** button and then **◀ / ▶** button to fine tune for the best picture and sound.
- 5 Press the **OK** button to store it.
- 6 Press the **EXIT** button to return to normal TV viewing.



1

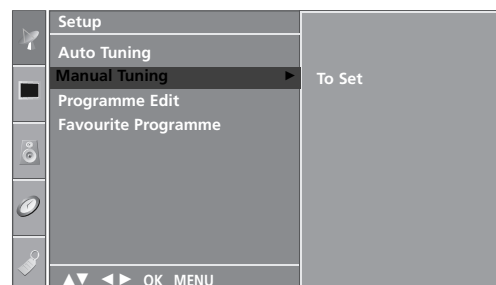

2

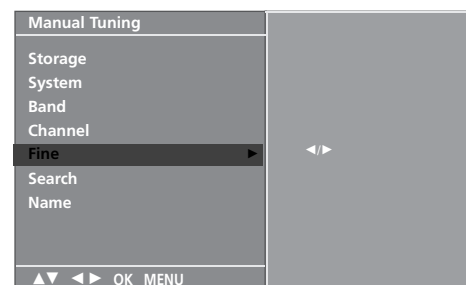

3 4 5

ASSIGNING A STATION NAME

You can assign a station name with five characters to each programme number.

- 1 Press the **MENU** button and then **▲ / ▼** button to select the **Setup** menu.

- 2 Press the **▶** button and then **▲ / ▼** button to select **Manual Tuning**.

- 3 Press the **▶** button and then **▲ / ▼** button to select **Name**.

- 4 Press the **▶** button and then **▲ / ▼** button. You can use a blank, +, -, the number **0** to **9** and the alphabet **A** to **Z**.

- 5 Press the **◀ / ▶** button to select the position and make your choice of the second character, and so on.

- 6 Press the **OK** button to store it.

- 7 Press the **EXIT** button to return to normal TV viewing.



1

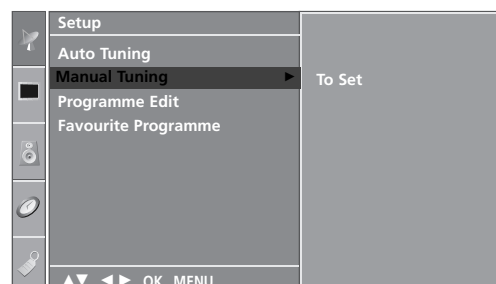

2

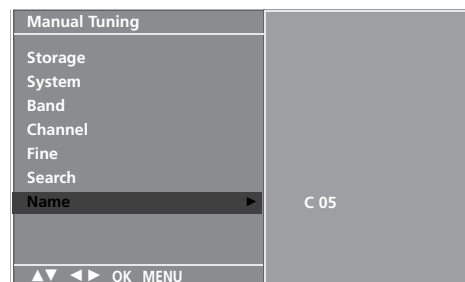

3 4 5 6

WATCHING TV / PROGRAMME CONTROL

PROGRAMME EDIT

This function enables you to delete or skip the stored programmes. Also you can move some stations to other programme numbers or copy a blank station data into the selected programme number.

1 Press the **MENU** button and then **▲ / ▼** button to select the **Setup** menu.

2 Press the **▶** button and then **▲ / ▼** button to select **Programme Edit**.

3 Press the **▶** button to display the Programme edit menu.

■ Deleting a programme

1. Select a programme to be deleted with the **▲ / ▼ / ◀ / ▶** button.
2. Press the **RED** button twice.
The selected programme is deleted, all the following programmes are shifted up one position.

■ Copying a programme

1. Select a programme to be copied with the **▲ / ▼ / ◀ / ▶** button.
2. Press the **GREEN** button.
All the following programmes are shifted down one position.

■ Moving a programme

1. Select a programme to be moved with the **▲ / ▼ / ◀ / ▶** button.
2. Press the **YELLOW** button.
3. Move the programme to the desired programme number with the **▲ / ▼ / ◀ / ▶** button.
4. Press the **YELLOW** button again to release this function.

■ Skipping a programme number

1. Select a programme number to be skipped with the **▲ / ▼ / ◀ / ▶** button.
2. Press the **BLUE** button. The skipped programme turns to blue.
3. Press the **BLUE** button again to release the skipped programme.

When a programme number is skipped it means that you will be unable to select it using the **▲ / ▼** button during normal TV viewing. If you want to select the skipped programme, directly enter the programme number with the **NUMBER** buttons or select it in the programme edit or table menu.

4 Press the **EXIT** button to return to normal TV viewing.



1

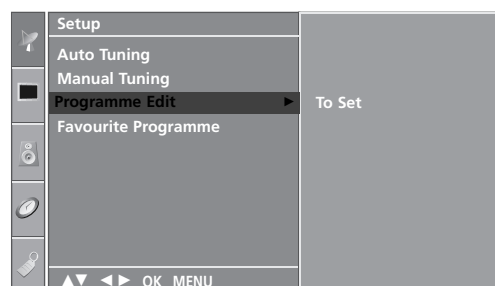

2

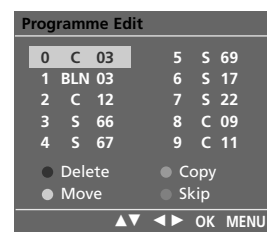

3

FAVOURITE PROGRAMME

This function lets you select your favourite programmes directly.

Repeatedly press the FAV button to select stored favourite programmes.

- 1 Press the **MENU** button and then **▲ / ▼** button to select the **Setup** menu.

- 2 Press the **▶** button and then **▲ / ▼** button to select **Favourite Programme**.

- 3 Press the **▶** button.

- 4 Press the **▲ / ▼** button to select - - - - -.

- 5 Select a desired programme with the **◀ / ▶** button or **NUMBER** buttons. Any number under 10 is entered with a numeric '0' in front of it, i.e. '05' for 5.

- 6 To store another programme, repeat steps 4 to 5. You can store up to 8 programmes.

- 7 Press the **EXIT** button to return to normal TV viewing.

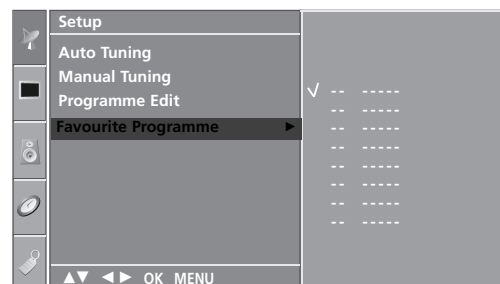
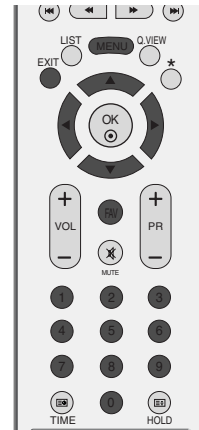

3 4 5

WATCHING TV / PROGRAMME CONTROL

CALLING THE PROGRAMME TABLE

You can check the programmes stored in the memory by displaying the programme table.

■ Displaying programme table

Press the **LIST** button to display the Programme table menu.

The programme table appears on the screen.

One programme table contains ten programmes as shown.

! NOTE

- You may find some blue programmes. They have been set up to be skipped by auto programming or in the programme edit mode.
- Some programmes with the channel number shown in the programme table indicate there is no station name assigned.

■ Selecting a programme in the programme table

Select a programme with the **▲ / ▼ / ◀ / ▶** button.

Then press the **OK** button. The set switches to the chosen programme number.

■ Paging through a programme table

There are 10 programme table pages in which contain 100 programmes. Pressing the **▲ / ▼ / ◀ / ▶** button repeatedly turns the pages.

Press the **LIST** button to return to normal TV viewing.

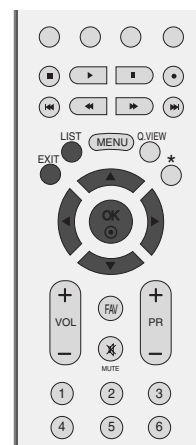

0	C	03	5	S	69
1	BLN	03	6	S	17
2	C	12	7	S	22
3	S	66	8	C	09
4	S	67	9	C	11

KEY LOCK

The TV can be set so that the remote control is needed to control it.

This feature can be used to prevent unauthorized viewing.

This set is programmed to remember which option it was last set to even if you turn the set off.



1 Press the **MENU** button and then **▲ / ▼** button to select the **Option** menu.

2 Press the **▶** button and then **▲ / ▼** button to select **Key Lock**.

3 Press the **▶** button and then **▲ / ▼** button to select **On** or **Off**.

4 Press the **EXIT** button to return to normal TV viewing.

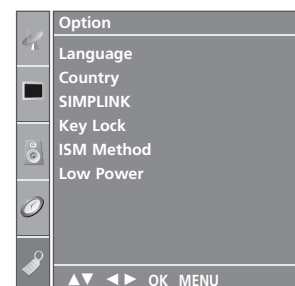

1

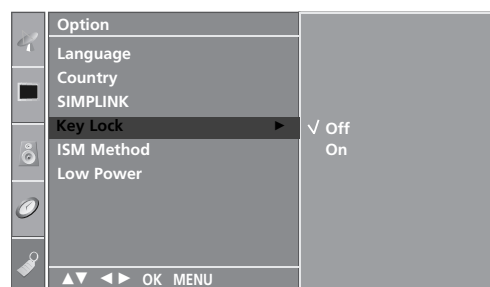

2 3

! NOTE

- ▶ In **Key Lock 'On'**, if the set is turned off, press the **⏻ / I**, **INPUT**, **PR ▲ / ▼** button on the set or **POWER**, **INPUT**, **TV**, **PR +/-** or **NUMBER** buttons on the remote control.
- ▶ With the **Key Lock On**, the display **'Key Lock On'** appears on the screen if any button on the front panel is pressed while viewing the set.

WATCHING TV / PROGRAMME CONTROL



This operates only for the devices with the SIMPLINK logo.
Please check the SIMPLINK logo.

This allows you to control and play other AV devices connected to the display through HDMI cable without additional cables and settings.

If you do not want SIMPLINK menu, select "Off".

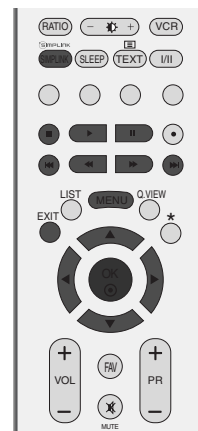

1 Press the **MENU** button and then **▲ / ▼** button to select the **Option** menu.

2 Press the **▶** button and then **▲ / ▼** button to select **SIMPLINK**.

3 Press the **▶** button and then **▲ / ▼** button to select **On** or **Off**.

4 Press the **EXIT** button to return to normal TV viewing.

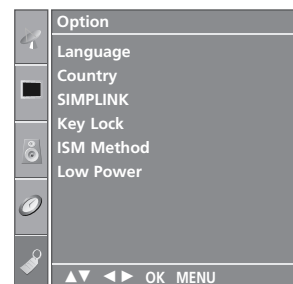

1

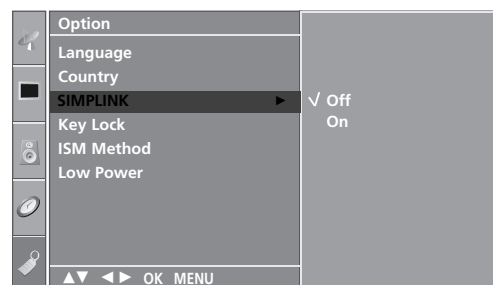

2 3

SIMPLINK Functions

Disc playback

Control connected AV devices by pressing the ▲ / ▼ / ◀ / ▶, OK buttons and buttons for play, stop, pause, fast reverse, fast forward, chapter skip. (The ⏻ button does not provide such functions)

Direct Play

After connecting AV devices to TV, you can directly control the devices and play media without additional settings.

Select AV device

Enables you to select one of AV devices connected to TV and play it.

Power off all devices

When you power off TV, all connected devices are turned off.

Switch audio-out

Offers an easy way to switch audio-out.

* A device, which is connected to TV through HDMI cable but does not support SIMPLINK, does not provide this function.

SIMPLINK Menu

Press the ▲ / ▼ / ◀ / ▶ button and then OK button to select the desired SIMPLINK source.

- ① **TV viewing** : Switch to the previous TV programme regardless of the current mode.
- ② **DISC playback** : Select and play discs. When multiple discs are available, the titles of the discs are conveniently displayed at the bottom of the screen.
- ③ **VCR playback** : Play and control the connected VCR.
- ④ **HDD Recordings playback** : Play and control recordings stored in HDD.
- ⑤ **Audio Out to Home theater/Audio Out to TV** : Select Home theater or TV speaker for Audio Out.

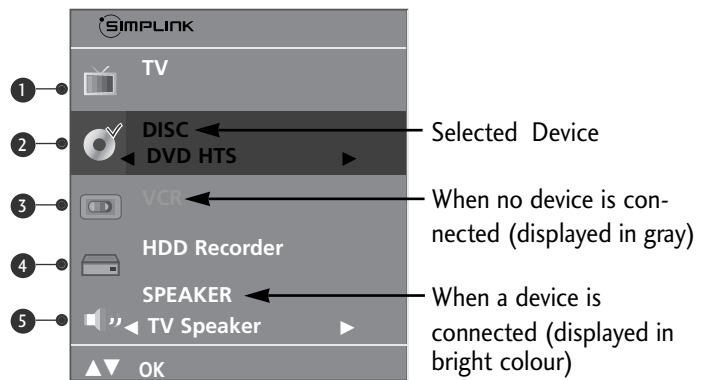

! NOTE

- ▶ Connect the HDMI/DVI IN or HDMI IN terminal of the TV to the rear terminal (HDMI terminal) of the SIMPLINK device with the HDMI cable.
- ▶ After connecting the HDMI terminal for the home theater with SIMPLINK function in the above method, connect the VARIABLE AUDIO OUT terminal on the back of the TV to the VARIABLE AUDIO IN terminal on the back of the SIMPLINK device with the VARIABLE AUDIO OUT cable.
- ▶ When operating the external device with SIMPLINK, press the TV button among the MODE button on the remote controller.
- ▶ When you switch the Input source with the INPUT button on the remote controller, you can stop the operation of device controlled by SIMPLINK.
- ▶ When you select or operate the media device with home theater function, the speaker automatically switches to home theater speaker (HT speaker).

PICTURE CONTROL

PICTURE SIZE (ASPECT RATIO)CONTROL

You can watch the screen in various picture formats; **Spectacle**, **Full**, **Original**, **4:3**, **16:9**, **14:9** and **Zoom1/2**.

If a fixed image is displayed on the screen for a long time, that fixed image may become imprinted on the screen and remain visible.

There might be uncomfortable in full mode. Then change into other mode.

You can adjust the enlarge proportion using ▲ / ▼ button.

This function works in the following signal.

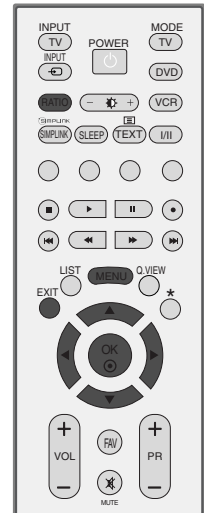

- 1 Press the **RATIO** button repeatedly to select the desired picture format. You can also adjust **Aspect Ratio** in the **Picture** menu.

• Spectacle

When your TV receives the wide screen signal, when selected it will adjust the picture horizontally, in non-linear proportion, to fill the entire screen.

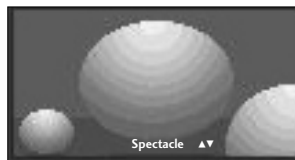

• Full

When your TV receives the wide screen signal, when selected it will adjust the picture horizontally or vertically, in a linear proportion, to fill the entire screen fully.



• Original

When your TV receives the wide screen signal, it will be automatically changed to the picture format to be sent.



• 4:3

Following selection will lead you to view a picture with an original 4:3 aspect ratio, with gray bars appearing at both the left and right sides.



- **16:9**

Following selection will lead you to adjust the picture horizontally, in a linear proportion, to fill the entire screen (useful for viewing 4:3 formatted DVDs).

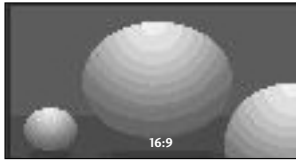

- **14:9**

You can enjoy the picture format of 14:9 or general TV programme through the 14:9 mode. The screen 14:9 is viewed just like that the screen 4:3 is magnified to the left / right.



- **Zoom1**

Following selection will lead you to view the picture without any alteration, while filling the entire screen. However, the top and bottom portions of the picture will be cropped.

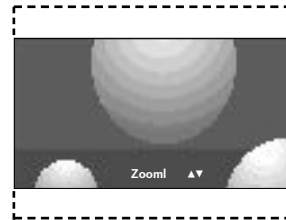

- **Zoom2**

Choose Zoom2 when you want the picture to be altered, both horizontally extended and vertically cropped. The picture taking a halfway trade off between alteration and screen coverage.

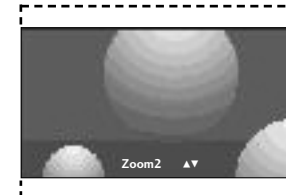

! NOTE

► You can only select **4:3**, **16:9 (Wide)** in Component, RGB, HDMI mode only.

PICTURE CONTROL

PRESET PICTURE SETTINGS

Picture Mode-Preset

- Dynamic** Select this option to display with a sharp image.
Standard The most general and natural screen display status.
Mild Select this option to display with a mild image.
User1/2 Select this option to use the user-defined setting.



1 Press the **MENU** button and then **▲ / ▼** button to select the **Picture** menu.

2 Press the **▶** button and then **▲ / ▼** button to select **Picture Mode**.

3 Press the **▶** button and then **▲ / ▼** button to select **Dynamic, Standard, Mild, User1** or **User2**.

4 Press the **EXIT** button to return to normal TV viewing.

- Picture Mode adjusts the TV for the best picture appearance. Select the preset value in the **Picture Mode** menu based on the programme category.
- Dynamic, Standard and Mild are programmed for optimum picture reproduction at the factory and can't be changed.

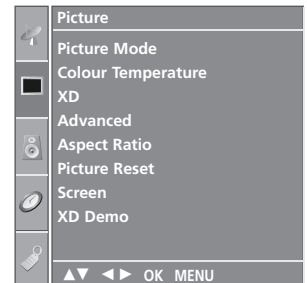

1

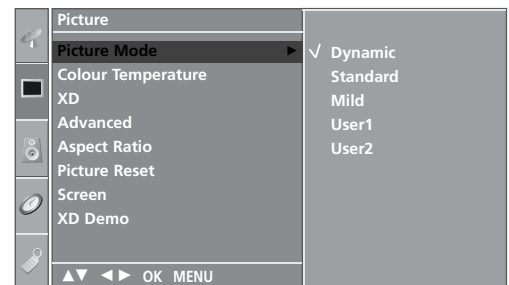

2 3

Auto Colour Tone Control(Warm/Medium/Cool)

To initialize values (reset to default settings), select the Cool option.

Choose one of three automatic colour adjustments. Set to warm to enhance hotter colours such as red, or set to cool to see less intense colours with more blue.

It's available to use this function in "User1/2" of **Picture mode** only.

- 1 Press the **MENU** button and then **▲ / ▼** button to select the **Picture** menu.
- 2 Press the **▶** button and then **▲ / ▼** button to select **Colour Temperature**.
- 3 Press the **▶** button and then **▲ / ▼** button to select either **Cool**, **Medium**, **Warm** or **User**.
- 4 Press the **EXIT** button to return to normal TV viewing.

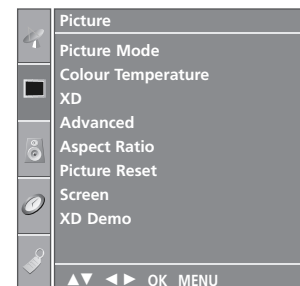

1

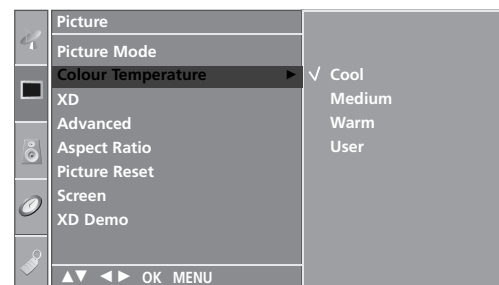

2 3

PICTURE CONTROL

MANUAL PICTURE ADJUSTMENT

Picture Mode-User Option

- Contrast** Adjusts the difference between the light and dark levels in the picture.
- Brightness** Increases or decreases amount of white in the picture.
- Colour** Adjusts intensity of all colours.
- Sharpness** Adjusts the level of crispness in the edges between the light and dark areas of the picture. The lower the level, the softer the image.
- Tint** Adjusts the balance between red and green levels.



1 Press the **MENU** button and then **▲ / ▼** button to select the **Picture** menu.

2 Press the **▶** button and then **▲ / ▼** button to select **Picture Mode**.

3 Press the **▶** button and then **▲ / ▼** button to select **User1** or **User2**.

4 Press the **▶** button and then **▲ / ▼** button to select the desired picture option (**Contrast**, **Brightness**, **Colour**, **Sharpness** and **Tint**).

5 Press the **◀ / ▶** button to make appropriate adjustments.

6 Press the **EXIT** button to return to normal TV viewing.

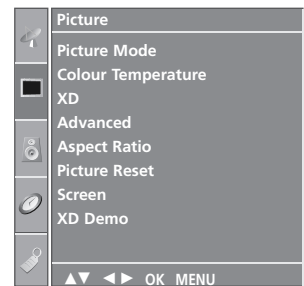

1

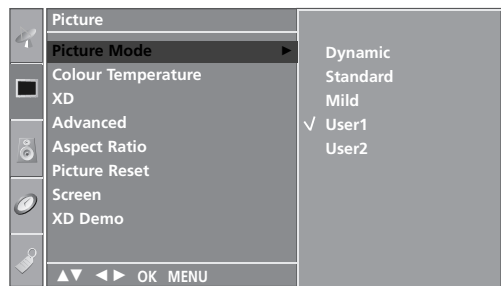

2 3

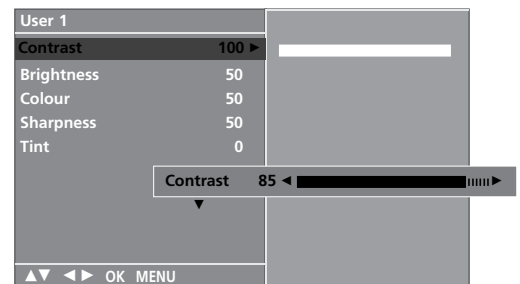

4 5

! NOTE

- ▶ You can't adjust colour, sharpness and tint in the RGB-PC mode to the levels you prefer.

Colour Tone - User Option

To adjust red, green, blue to any colour temperature you prefer.

It's available to use this function in "User1/2" of **Picture mode** only.

- 1 Press the **MENU** button and then **▲ / ▼** button to select the **Picture** menu.
- 2 Press the **▶** button and then **▲ / ▼** button to select **Colour Temperature**.
- 3 Press the **▶** button and then **▲ / ▼** button to select **User**.
- 4 Press the **▶** button and then **▲ / ▼** button to select **Red, Green** or **Blue**.
- 5 Press the **◀ / ▶** button to make appropriate adjustments.
- 6 Press the **EXIT** button to return to normal TV viewing.

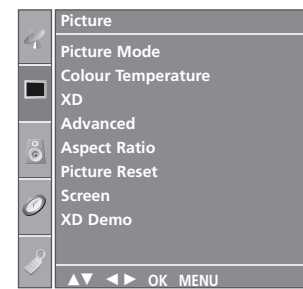
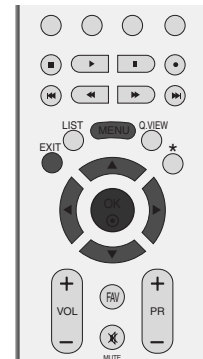

1

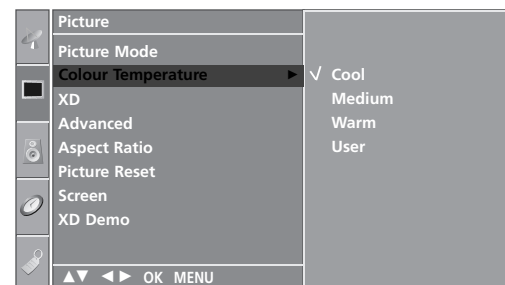

2 3

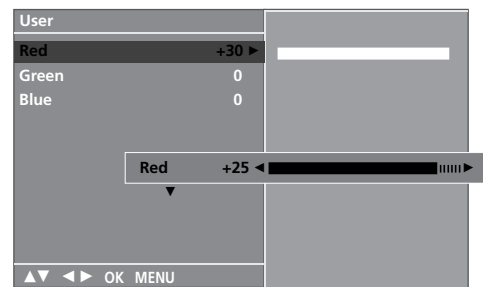

4 5

PICTURE CONTROL

XD - PICTURE IMPROVEMENT TECHNOLOGY

XD is LG electronic's unique picture improving technology to display a real HD source through an advanced digital signal processing algorithm.

It's not available to use this function in RGB-PC mode.

- 1 Press the MENU button and then ▲ / ▼ button to select the **Picture** menu.
- 2 Press the ► button and then ▲ / ▼ button to select **XD**.
- 3 Press the ► button and then ▲ / ▼ button to select **Auto** or **Manual**.
- 4 Press the EXIT button to return to TV viewing.

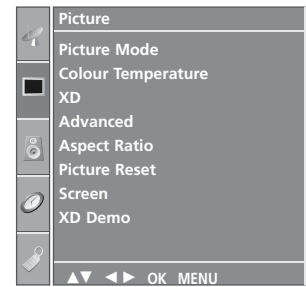

1

* Selecting the Manual

This menu is activated after selecting the **User1** or **User2** of **Picture Mode**.

- 1 Press the ► button and then ▲ / ▼ button to select **XD Contrast**, **XD Colour** or **XD NR**.
- 2 Press the ► button and then ▲ / ▼ button to select **On** or **Off**.
- 3 Press the EXIT button to return to normal TV viewing.

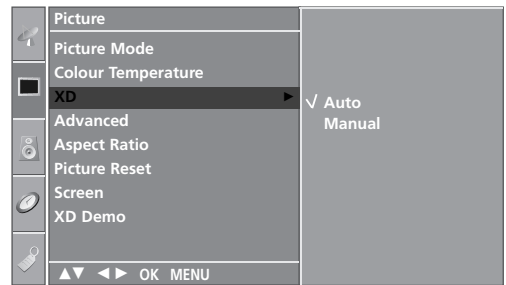

2 3

- **XD Contrast** : Optimizing the contrast automatically according to the brightness of the reflection.
- **XD Colour** : Adjusting the colours of the reflection automatically to reproduce as closely as possible to the natural colours.
- **XD NR** : Removing the noise up to the point where it does not damage the original picture. (It's not available to use this function in HDMI, Component (except 480i/576i), RGB-PC mode.)

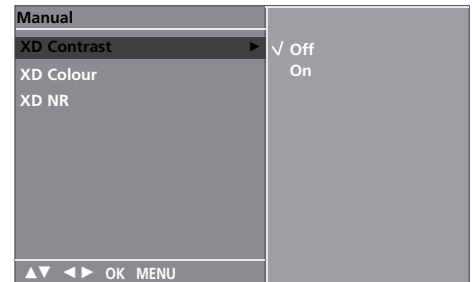

1 2

XD DEMO

Use it to see the difference between XD Demo on and XD Demo off.

It's not available to use this function in RGB[PC] mode.



1 Press the MENU button and then ▲ / ▼ button to select the **Picture** menu.

2 Press the ► button and then ▲ / ▼ button to select **XD Demo**.

3 Press the ► button to begin **XD Demo**.

4 To stop **XD Demo**, press the MENU button.

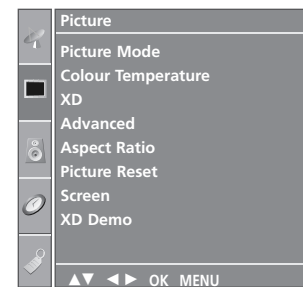

1

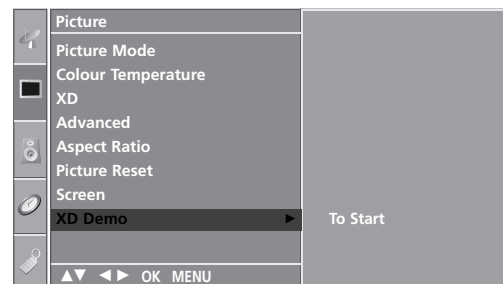

2 3

• XD Demo



PICTURE CONTROL

ADVANCED - CINEMA

Set up the TV for the best picture appearance for viewing movies.

This feature operates only in Analog TV, AV, S-video and Component 480i/576i mode.



1 Press the **MENU** button and then **▲ / ▼** button to select the **Picture** menu.

2 Press the **▶** button and then **▲ / ▼** button to select **Advanced**.

3 Press the **▶** button and then **▲ / ▼** button to select **Cinema**.

4 Press the **▶** button and then **▲ / ▼** button to select **On** or **Off**.

5 Press the **EXIT** button to return to normal TV viewing.

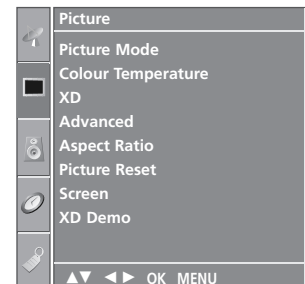

1

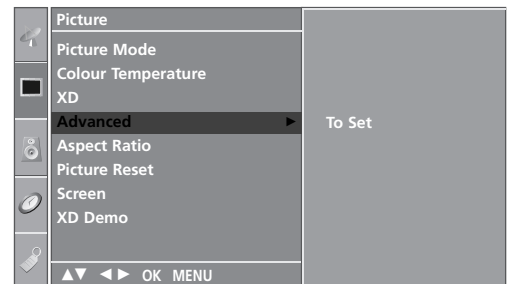

2 3

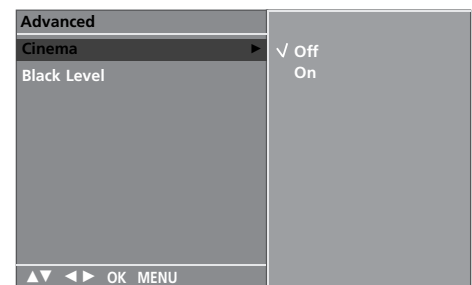

4

ADVANCED - BLACK(DARKNESS) LEVEL

When you watch the movie, this function adjusts the set to the best picture appearance. Adjusting the contrast and the brightness of the screen using the black level of the screen.

This function works in the following mode: AV (NTSC-M), S-Video (NTSC-M) or HDMI.



1 Press the **MENU** button and then **▲ / ▼** button to select the **Picture** menu.

2 Press the **▶** button and then **▲ / ▼** button to select **Advanced**.

3 Press the **▶** button and then **▲ / ▼** button to select **Black Level**.

4 Press the **▶** button and then **▲ / ▼** button to select **Low** or **High**.

- **Low** : The reflection of the screen gets darker.
- **High** : The reflection of the screen gets brighter.

5 Press the **EXIT** button to return to normal TV viewing.

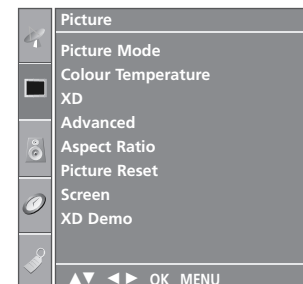

1

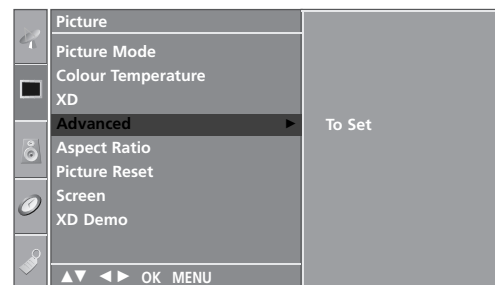

2 3

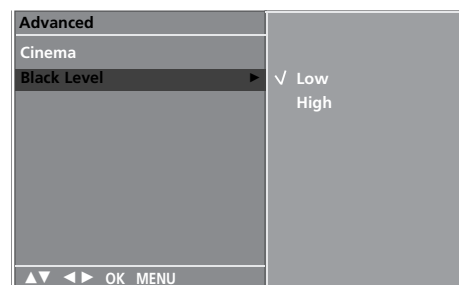

4

PICTURE CONTROL

PICTURE RESET

Returns to the default settings Picture Mode, Colour Temperature, XD, Advanced, Aspect Ratio at the factory.



- 1 Press the **MENU** button and then ▲ / ▼ button to select the **Picture** menu.
- 2 Press the ► button and then ▲ / ▼ button to select **Picture Reset**.
- 3 Press the ► button to initialize the adjusted value.
- 4 Press the **EXIT** button to return to normal TV viewing.

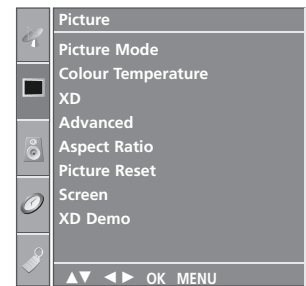

1

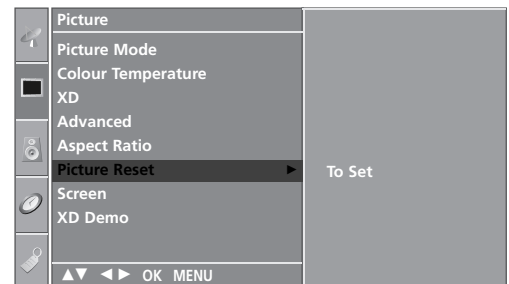

2 3

IMAGE STICKING MINIMIZATION(ISM)METHOD

A frozen or still picture from a PC/video game displayed on the screen for prolonged periods will result in a ghost image remaining even when you change the image. Avoid allowing a fixed image to remain on the set's screen for a long period of time.

It's not available to use this function in LCD models.

White Wash

White wash removes permanent images from the screen.

Note: An excessive permanent image may be impossible to clear entirely with White Wash.

Orbiter

Orbiter may help prevent ghost images. However, it is best not to allow any fixed image to remain on the screen. To avoid a permanent image on the screen, the screen will move every 2 minutes.

Inversion

This is the function to invert the panel colour of the screen. The panel colour is automatically inverted every 30 minutes.

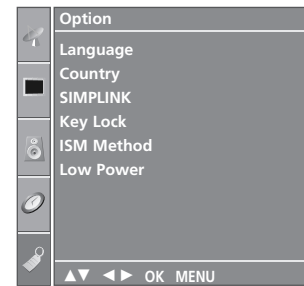

1 Press the **MENU** button and then **▲ / ▼** button to select the **Option** menu.

2 Press the **▶** button and then **▲ / ▼** button to select **ISM Method**.

3 Press the **▶** button and then **▲ / ▼** button to select either **Normal**, **White Wash**, **Orbiter** or **Inversion**. If you unnecessary to set this function, set **Normal**.

4 Press the **EXIT** button to return to normal TV viewing.

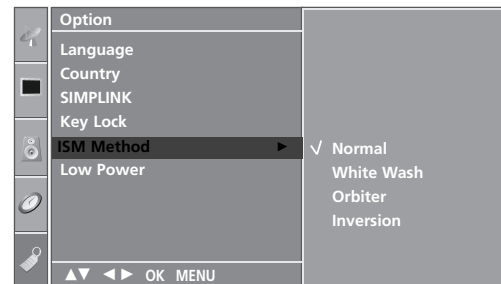

PICTURE CONTROL

LOW-POWER PICTURE MODE

This is the function to reduce the power consumption of the set.

It's not available to use this function in LCD models.



1 Press the **MENU** button and then ▲ / ▼ button to select the **Option** menu.

2 Press the ► button and then ▲ / ▼ button to select **Low Power**.

3 Press the ► button and then ▲ / ▼ button to select **On** or **Off**.

4 Press the **EXIT** button to return to normal TV viewing.

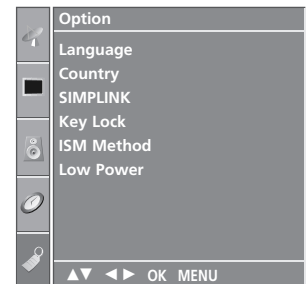

1

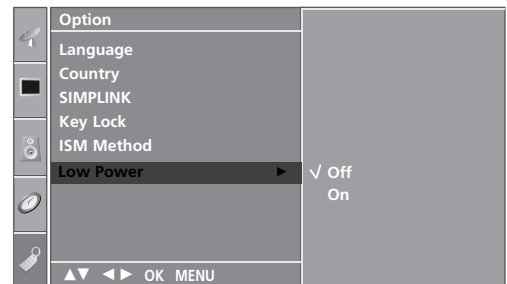

2 3

SOUND & LANGUAGE CONTROL

AUTO VOLUME LEVELER

Auto Volume automatically keeps on an equal volume level even if you change programmes.



- 1 Press the **MENU** button and then **▲ / ▼** button to select the **Audio** menu.
- 2 Press the **▶** button and then **▲ / ▼** button to select **Auto Volume**.
- 3 Press the **▶** button and then **▲ / ▼** button to select **On** or **Off**.
- 4 Press the **EXIT** button to return to normal TV viewing.

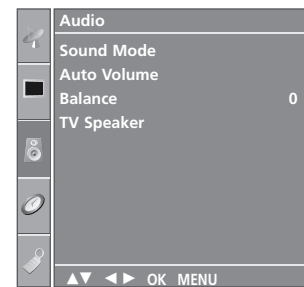

1

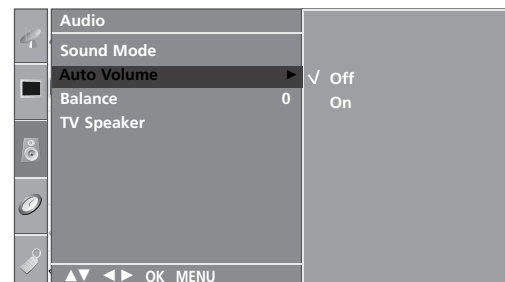

2 3

SOUND & LANGUAGE CONTROL

PRESET SOUND SETTINGS-SOUND MODE

You can select your preferred sound setting; Surround MAX, Standard, Music, Movie or Sports and you can also adjust the sound frequency of the equalizer.

Sound Mode lets you enjoy the best sound without any Special adjustment because the TV sets the appropriate sound options based on the programme content.

Surround MAX, Standard, Music, Movie, and Sports are preset for good sound quality at the factory and are not adjustable.

- Surround MAX** Select this option to sound realistic.
- Standard** The most commanding and natural audio.
- Music** Select this option to enjoy the original sound when listening to the music.
- Movie** Select this option to enjoy sublime sound.
- Sports** Select this option to watch sports broadcasting.
- User** Select this option to use the user-defined audio settings.

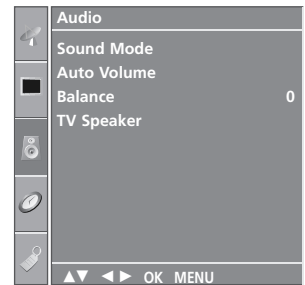

1

1 Press the **MENU** button and then **▲ / ▼** button to select the **Audio** menu.

2 Press the **▶** button and then **▲ / ▼** button to select **Sound Mode**.

3 Press the **▶** button and then **▲ / ▼** button to select **Surround MAX, Standard, Music, Movie, Sports** or **User**.

4 Press the **EXIT** button to return to normal TV viewing.

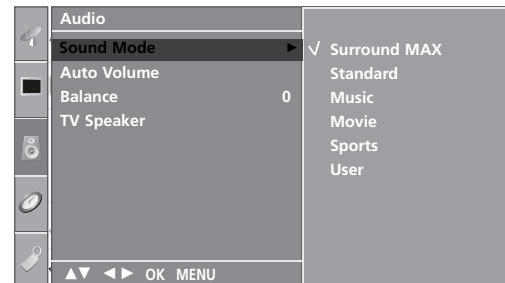

2 3

SOUND SETTING ADJUSTMENT -USER MODE

Adjust the sound equalizer.

- 1 Press the **MENU** button and then **▲ / ▼** button to select the **Audio** menu.
- 2 Press the **▶** button and then **▲ / ▼** button to select **Sound Mode**.
- 3 Press the **▶** button and then **▲ / ▼** button to select **User**.
- 4 Press the **▶** button.
- 5 Select a sound band by pressing the **◀ / ▶** button. Make appropriate sound level with the **▲ / ▼** button.
- 6 Press the **EXIT** button to return to normal TV viewing.

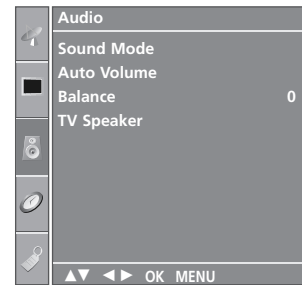

1

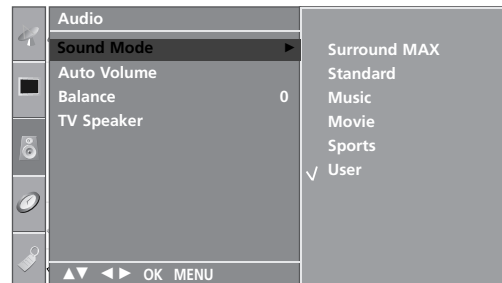

2 3 4

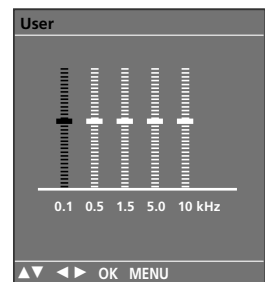

5

SOUND & LANGUAGE CONTROL

BALANCE

You can adjust the sound balance of speaker to the levels you prefer.



1 Press the **MENU** button and then ▲ / ▼ button to select the **Audio** menu.

2 Press the ► button and then ▲ / ▼ button to select **Balance**.

3 Press the ► button and then ◀ / ▶ button to make desired adjustment.

4 Press the **EXIT** button to return to normal TV viewing.

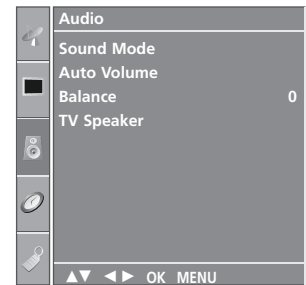

1

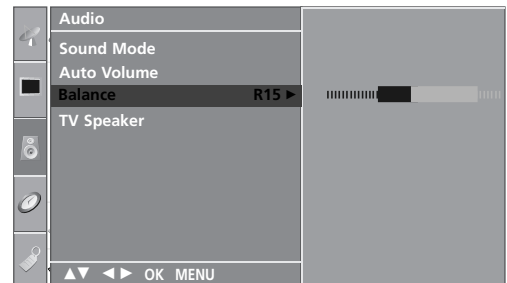

2 3

TV SPEAKERS ON/OFF SETUP

You can adjust the internal speaker status.

In AV, COMPONENT, RGB[PC] and HDMI mode, internal speaker audio can be outputted even though there is no video signal.

If you want to use your external hi-fi stereo system, turn off the internal speakers of the set.

- 1 Press the **MENU** button and then **▲ / ▼** button to select the **Audio** menu.
- 2 Press the **▶** button and then **▲ / ▼** button to select **TV Speaker**.
- 3 Press the **▶** button and then **▲ / ▼** button to select **On** or **Off**.
- 4 Press the **EXIT** button to return to normal TV viewing.

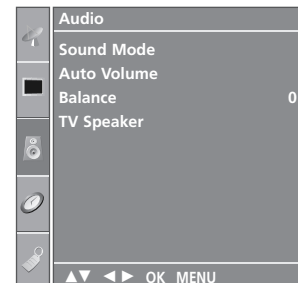

1

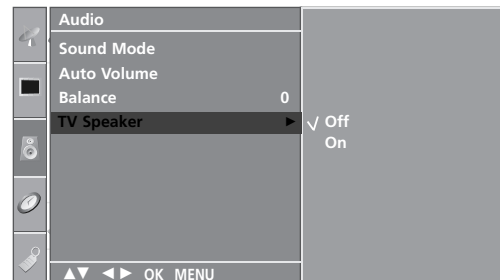

2 3

SOUND & LANGUAGE CONTROL

I/II

Stereo/Dual Reception

When a programme is selected, the sound information for the station appears after the programme number and station name disappear.

Broadcast	On Screen Display
Mono	MONO
Stereo	STEREO
Dual	DUAL I

■ Mono sound selection

If the stereo signal is weak in stereo reception, you can switch to mono by pressing the I/II button twice. In mono reception, the depth of sound is improved. To switch back to stereo, press the I/II button twice again.

■ Language selection for dual language broadcast

If a programme received two languages (dual language), you can switch to **DUAL I**, **DUAL II** or **DUAL I+II** by pressing the I/II button repeatedly.

- DUAL I** Sends the primary broadcast language to the loudspeakers.
- DUAL II** Sends the secondary broadcast language to the loudspeakers.
- DUAL I+II** Sends a separate language to each loudspeaker.

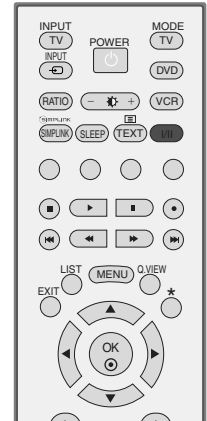

NICAM Reception

If the set is equipped with the receiver for NICAM reception, the high quality NICAM (Near Instantaneous Companding Audio Multiplex) digital sound can be received.

Sound output can be selected according to the type of received broadcast as follows by pressing the I/II button repeatedly.

-
- 1 When **NICAM mono** is received, you can select **NICAM MONO** or **FM MONO**.
-
- 2 When **NICAM stereo** is received, you can select **NICAM STEREO** or **FM MONO**.
If the stereo signal is weak, switch to **FM MONO**.
-
- 3 When **NICAM dual** is received, you can select **NICAM DUAL I**, **NICAM DUAL II** or **NICAM DUAL I+II** or **MONO**.
-

Speaker Sound Output Selection

In AV, S-Video, Component, RGB and HDMI mode, you can select output sound for the left and right loudspeakers.

Repeatedly press the I/II button to select the sound output.

L+R: Audio signal from audio L input is sent to the left loud speaker and audio signal from audio R input is sent to the right loudspeakers.

L+L: Audio signal from audio L input is sent to left and right loudspeakers.

R+R: Audio signal from audio R input is sent to left and right loudspeakers.

SOUND & LANGUAGE CONTROL

ON-SCREEN MENU LANGUAGE / COUNTRY SELECTION

This feature is not available in all countries.

Installation guide menu appears on TV screen when it is turned on for the first time.

- 1 Press the ▲ / ▼ / ◀ / ▶ button and then, **OK** button to select your desired language.
- 2 Press the ▲ / ▼ / ◀ / ▶ button and then, **OK** button to select your country.

* If you want to change Language/ Country selection

- 1 Press the **MENU** button and then use ▲ / ▼ button to select the **Option** menu.
- 2 Press the ▶ button and then use ▲ / ▼ button to select **Language**.
The menus can be shown on the screen in the selected language.
Or, Press the ▶ button and then use ▲ / ▼ button to select **Country**.
- 3 Press the ▶ button and then use ▲ / ▼ button to select your desired language or country.
- 4 Press the **OK** button.
- 5 Press the **EXIT** button to return to normal TV viewing.

! NOTE

- ▶ If you don't finish set up **Installation Guide** by pressing **EXIT** button or time out of OSD (On Screen Display) display, it will continuously appear until completing set up whenever the set is turned on.
- ▶ If you select wrong local country, the teletext may not appear correctly on the screen and some problem may happen during teletext operation.



TIME SETTING

CLOCK SETUP

You must set the time correctly before using on/off time function.

If current time setting is erased by a power failure or the set is unplugged, reset the clock.

- 1 Press the **MENU** button and then **▲ / ▼** button to select the **Time** menu.
- 2 Press the **▶** button and then **▲ / ▼** button to select **Clock**.
- 3 Press the **▶** button and then **▲ / ▼** button to set the hour.
- 4 Press the **▶** button and then **▲ / ▼** button to set the minute.
- 5 Press the **EXIT** button to return to normal TV viewing.

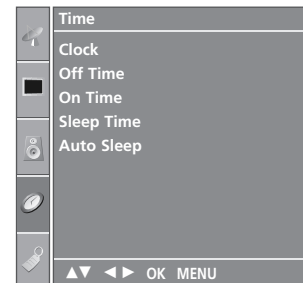

1

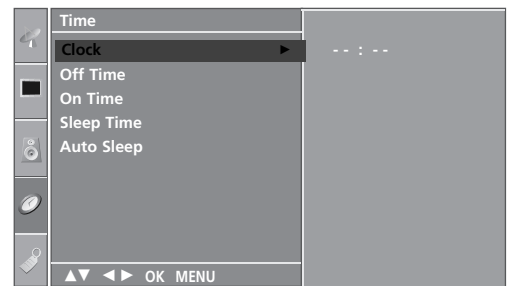

2 3 4

TIME SETTING

AUTO ON/OFF TIMER SETTING

The Off time automatically switches the set to standby at the preset time.

Two hours after the set is switched on by the on time function it will automatically switch back to standby mode unless a button has been pressed.

Once the on time/off time is set, these functions operate daily at the preset time.

Off time function overrides On time function if they are set both to the same time.

The set must be in standby mode for the On timer to work.



1 Press the **MENU** button and then **▲ / ▼** button to select the **Time** menu.

2 Press the **▶** button and then **▲ / ▼** button to select **Off Time/On Time**.

3 Press the **▶** button and then **▲ / ▼** button to select **On**.
 • To cancel **On/Off Time** function, select **Off**.

4 Press the **▶** button and then **▲ / ▼** button to set the hour.

5 Press the **▶** button and then **▲ / ▼** button to set the minutes.

6 **For only On Time function**
 • **Programme:** Press the **▶** button and then **▲ / ▼** button to select the programme.
 • **Volume:** Press the **▶** button and then **▲ / ▼** button to adjust volume level at turn-on.

7 Press the **EXIT** button to return to normal TV viewing.

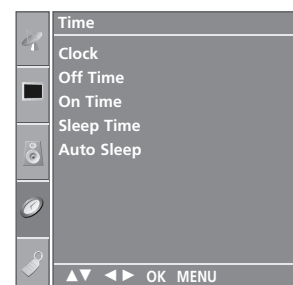

1

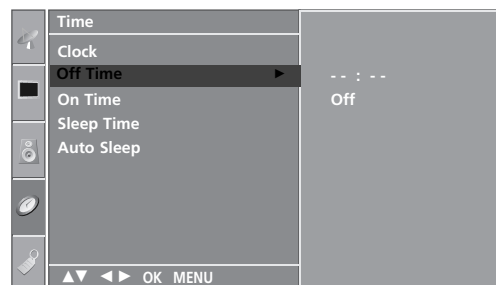

2 3 4 5

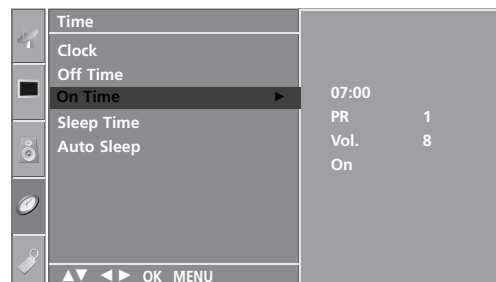

2 3 4 5 6

SLEEP TIMER SETTING

You don't have to remember to switch the set off before you go to sleep. The sleep timer automatically switches the set to standby after the preset time has elapsed.

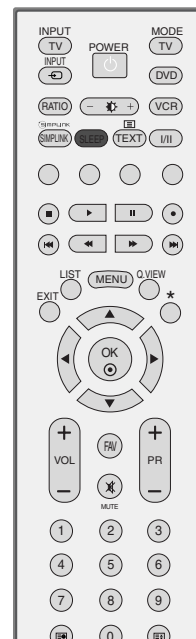

- 1 Press the **SLEEP** button repeatedly to select the number of minutes. The display '⌚ z^z - - -' will appear on the screen, followed by 10, 20, 30, 60, 90, 120, 180 and 240.
- 2 When the number of minutes you want is displayed on the screen, the timer begins to count down from the number of minutes selected.

■ You can also set up the Sleep Time in the **Time** menu.

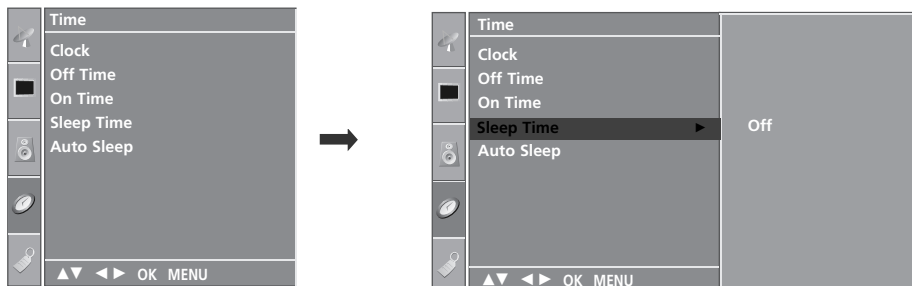

! NOTE

- ▶ To view the remaining sleep time, press the **SLEEP** button once.
- ▶ To cancel the sleep time, repeatedly press the **SLEEP** button until the display '⌚ z^z - - -' appears.
- ▶ When you switch the set off, the set releases the preset sleep time.

TIME SETTING

AUTO SHUT-OFF SETTING

If set to on and there is no input signal, the TV turns off automatically after 10 minutes.



1 Press the **MENU** button and then ▲ / ▼ button to select the **Time** menu.

2 Press the ► button and then ▲ / ▼ button to select **Auto Sleep**.

3 Press the ► button and then ▲ / ▼ button to select **On** or **Off**.

4 Press the **EXIT** button to return to normal TV viewing.

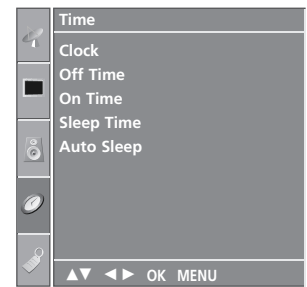

1

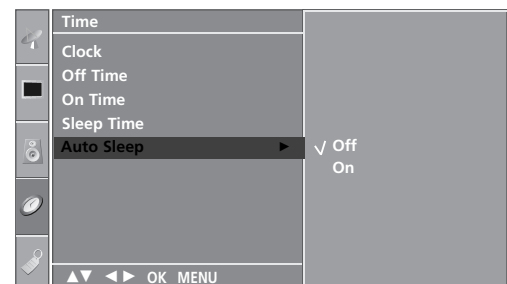

2 3

TELETEXT

This feature is not available in all countries.

Teletext is a free service broadcast by most TV stations which gives up-to-the-minute information on news, weather, television programmes, share prices and many other topics.

The teletext decoder of this TV can support the SIMPLE, TOP and FASTEXT systems. SIMPLE (standard teletext) consists of a number of pages which are selected by directly entering the corresponding page number. TOP and FASTEXT are more modern methods allowing quick and easy selection of teletext information.

SWITCH ON/OFF

Press the **TEXT** button to switch to teletext. The initial page or last page appears on the screen.

Two page numbers, TV station name, date and time are displayed on the screen headline. The first page number indicates your selection, while the second shows the current page displayed.

Press the **TEXT** or **EXIT** button to switch off teletext. The previous mode reappears.

SIMPLE TEXT

■ Page selection

- 1 Enter the desired page number as a three digit number with the NUMBER buttons. If during selection you press a wrong number, you must complete the three digit number and then re-enter the correct page number.
- 2 The PR+/- button can be used to select the preceding or following page.

TOP TEXT

The user guide displays four fields-red, green, yellow and blue at the bottom of the screen. The yellow field denotes the next group and the blue field indicates the next block.

■ Block / group / page selection

- ① With the blue button you can progress from block to block.
- ② Use the yellow button to proceed to the next group with automatic overflow to the next block.
- ③ With the green button you can proceed to the next existing page with automatic overflow to the next group. Alternatively the **PR+** button can be used.
- ④ The red button permits to return to previous selection. Alternatively the **PR-** button can be used.

■ Direct page selection

Corresponding to the SIMPLE teletext mode, you can select a page by entering it as a three digit number using the NUMBER buttons in TOP mode.

FASTEXT

The teletext pages are colour coded along the bottom of the screen and are selected by pressing the corresponding coloured button.

■ Page selection

- ① Press the  button to select the index page.
- ② You can select the pages which are colour coded along the bottom line with the same coloured buttons.
- ③ Corresponding to the SIMPLE teletext mode, you can select a page by entering its three digit page number with the NUMBER buttons in FASTEXT mode.
- ④ The **PR+/-** button can be used to select the preceding or following page.

SPECIAL TELETEXT FUNCTIONS



■ REVEAL

Press this button to display concealed information, such as solutions of riddles or puzzles.
Press this button again to remove the information from the display.



■ SIZE

Selects double height text.
Press this button to enlarge the top half of the page.
Press this button again to enlarge the bottom half of the page.
Press this button again to return to the normal display.



■ UPDATE

Displays the TV picture on the screen while waiting for the new teletext page. The display will appear at the top left hand corner of the screen. When the updated page is available then display will change to the page number.
Press this button to view the updated teletext page.



■ TIME

When viewing a TV programme, press this button to display the time at the top right hand corner of the screen.
Press this button again to remove the display. In the teletext mode, press this button to select a sub page number. The sub page number is displayed at the bottom of the screen. To hold or change the sub page, press the RED/GREEN, **PR+/-** or NUMBER buttons.
Press again to exit this function.



■ HOLD

Stops the automatic page change which will occur if a teletext page consists of 2 or more sub pages. The number of sub pages and the sub page displayed is, usually, shown on the screen below the time. When this button is pressed the stop symbol is displayed at the top left-hand corner of the screen and the automatic page change is inhibited. To continue press this button again.

APPENDIX

TROUBLESHOOTING

The operation does not work normally.

The remote control doesn't work

- Check to see if there is any object between the product and the remote control causing obstruction.
- Are batteries installed with correct polarity (+ to +, - to -)?
- Correct remote operating mode set: TV, VCR etc.?
- Install new batteries.

Power is suddenly turned off

- Is the sleep time set?
- Check the power control settings. Power interrupted
- No broadcast on station tuned with Auto off activated.

The video function does not work.

No picture & No sound

- Check whether the product is turned on.
- Try another channel. The problem may be with the broadcast.
- Is the power cord inserted into wall power outlet?
- Check your antenna direction and/or location.
- Test the wall power outlet, plug another product's power cord into the outlet where the product's power cord was plugged in.

Picture appears slowly after switching on

- This is normal, the image is muted during the product startup process. Please contact your service center, if the picture has not appeared after five minutes.

No or poor colour or poor picture

- Adjust Colour in menu option.
- Keep a sufficient distance between the product and the VCR.
- Try another channel. The problem may be with the broadcast.
- Are the video cables installed properly?
- Activate any function to restore the brightness of the picture.

Horizontal/vertical bars or picture shaking

- Check for local interference such as an electrical appliance or power tool.

Poor reception on some channels

- Station or cable product experiencing problems, tune to another station.
- Station signal is weak, reorient antenna to receive weaker station.
- Check for sources of possible interference.

Lines or streaks in pictures

- Check antenna (Change the direction of the antenna).

The audio function does not work.

Picture OK & No sound	<ul style="list-style-type: none">■ Press the VOL+/- (or Volume) button.■ Sound muted? Press MUTE button.■ Try another channel. The problem may be with the broadcast.■ Are the audio cables installed properly?
No output from one of the speakers	<ul style="list-style-type: none">■ Adjust Balance in menu option.
Unusual sound from inside the product	<ul style="list-style-type: none">■ A change in ambient humidity or temperature may result in an unusual noise when the product is turned on or off and does not indicate a fault with the product.

There is a problem in PC mode. (Only PC mode applied)

The signal is out of range.	<ul style="list-style-type: none">■ Adjust resolution, horizontal frequency, or vertical frequency.■ Check the input source.
Vertical bar or stripe on background & Horizontal Noise & Incorrect position	<ul style="list-style-type: none">■ Work the Auto configure or adjust clock, phase, or H/V position.
Screen colour is unstable or single colour	<ul style="list-style-type: none">■ Check the signal cable.■ Reinstall the PC video card.

APPENDIX

MAINTENANCE

Early malfunctions can be prevented. Careful and regular cleaning can extend the amount of time you will have your new TV. Be sure to turn the power off and unplug the power cord before you begin any cleaning.

Cleaning the Screen

- 1 Here's a great way to keep the dust off your screen for a while. Wet a soft cloth in a mixture of lukewarm water and a little fabric softener or dish washing detergent. Wring the cloth until it's almost dry, and then use it to wipe the screen.
- 2 Make sure the excess water is off the screen, and then let it air-dry before you turn on your TV.

Cleaning the Cabinet

- To remove dirt or dust, wipe the cabinet with a soft, dry, lint-free cloth.
- Please be sure not to use a wet cloth.

Extended Absence

CAUTION

- ▶ If you expect to leave your TV dormant for a long time (such as a vacation), it's a good idea to unplug the power cord to protect against possible damage from lightning or power surges.

PRODUCT SPECIFICATIONS

MODELS		26LC41*	32LC41*/32LC43* 32LC44*	37LC41*/37LC43*	42LC41*/42LC43*
		26LC41-ZA	32LC41-ZA/32LC43-ZE 32LC43-ZA/32LC44-ZB	37LC41-ZA 37LC43-ZA	42LC41-ZA 42LC43-ZA
Dimensions (Width x Height x Depth)	with stand	676.4 x 529.2x 221.0 mm 26.6 x 20.8 x 8.7 inches	806.4 x 606.1 x 249.0 mm 31.8 x 23.9 x 9.8 inches	926.6 x 697.6x 280.4mm 36.5x 27.5 x 11.0 inches	1032.7 x 750.0 x 287.6 mm 40.7x 29.5 x 11.3 inches
	without stand	676.4 x 474.3 x 85.0 mm 26.6 x 18.7 x 3.3 inches	806.4 x 548.4 x 80.5 mm 31.8 x 21.6x 3.2 inches	926.6 x 635.6 x 88.0mm 36.5x 25.0 x 3.5 inches	1032.7 x 685.5 x 88.5 mm 40.7 x 27.0 x 3.5 inches
Weight	with stand	10.1kg / 22.3 lbs	13.9 kg / 30.7 lbs	20.0 kg / 44.1 lbs	24.5 kg / 54.0 lbs
	without stand	9.1kg / 20.1 lbs	11.3 kg / 24.9 lbs	16.3 kg / 35.9 lbs	20 kg / 44.1 lbs
Power requirement Power Consumption		AC100-240V~ 50/60Hz 1.3A 130W	AC100-240V~ 50/60Hz 1.5A 150W	AC100-240V~ 50/60Hz 1.8A 170W	AC100-240V~ 50/60Hz 2.2A 200W
MODELS		26LC5*	32LC5*	37LC5*	42LC5*
		26LC51-ZA 26LC51 C-ZA	32LC51-ZA/32LC52-ZC 32LC52C-ZC 32LC53-ZA/32LC54-ZD	37LC51-ZA 37LC53-ZA	42LC51-ZA 42LC53-ZA 42LC54-ZD
Dimensions (Width x Height x Depth)	with stand	676.6 x 531.0x 221.0 mm 26.6 x 20.9 x 8.7 inches	806.6 x 606.5 x 249 mm 31.8 x 23.9 x 9.8 inches	927 x 692.8x 280.5mm 36.5x 27.3 x 11.1 inches	1033.4 x 750.0 x 287.6 mm 40.7x 29.5 x 11.3 inches
	without stand	676.6 x 478.7 x 84.0 mm 26.6 x 18.9 x 3.3 inches	806.6 x 552.3 x 79 mm 31.8 x 21.8x 3.1 inches	927 x 630 x 88.0mm 36.5x 24.8 x 3.5 inches	1033.4 x 686.8 x 88.5mm 40.7 x 27.0x 3.5inches
Weight	with stand	10.4kg / 22.9 lbs	13.7kg / 30.2 lbs	20.0 kg / 44.1 lbs	24.9 kg / 54.9 lbs
	without stand	9.0kg / 19.9 lbs	11.2kg / 24.7 lbs	16.0 kg / 35.3 lbs	20.4 kg / 45.0 lbs
Power requirement Power Consumption		AC100-240V~ 50/60Hz 1.3A 130W	AC100-240V~ 50/60Hz 1.5A 150W	AC100-240V~ 50/60Hz 1.8A 170W	AC100-240V~ 50/60Hz 2.2A 200W
Television System Program Coverage External Antenna Impedance		PAL/SECAM B/G/D/K, PAL I/II, SECAM L/L' VHF: E2 ~ E12, UHF: E21 ~ E69, CATV: S1 ~ S20, HYPER: S21 ~ S47 75 Ω			
Environment condition	Operating Temperature	0 ~ 40°C / 32 ~ 104°F			
	Operating Humidity	Less than 80%			
	Storage Temperature	-20 ~ 60°C / -4 ~ 140°F			
	Storage Humidity	Less than 85%			

■ The specifications shown above may be changed without prior notice for quality improvement.

APPENDIX

PRODUCT SPECIFICATIONS

MODELS		26LC42*	32LC42*	37LC42*	42LC42*
		26LC42-ZC	32LC42-ZC	37LC42-ZC	42LC42-ZC
Dimensions (Width x Height x Depth)	with stand	676.4 x 529.2x 228.9 mm 26.6 x 20.9 x 9.0 inches	806.8 x 605.6 x 260.5 mm 31.8 x 23.9 x 10.3 inches	926.6 x 697.6x 280.4mm 36.5x 27.5 x 11.1 inches	1032.7 x 750.0 x 300.2 mm 40.7x 29.6 x 11.8 inches
	without stand	676.4 x 474.3 x 85.0 mm 26.6 x 18.7 x 3.4 inches	806.8 x 605.5 x 79 mm 31.8 x 23.9x 3.1 inches	926.6 x 635.6 x 88.0mm 36.5x 25.0 x 3.5 inches	1032.7 x 685.5 x 88.5mm 40.7 x 27.0x 3.5inches
Weight	with stand	9.62kg / 21.2 lbs	14.4kg / 31.8 lbs	20.0 kg / 44.1 lbs	24.5 kg / 54.0 lbs
	without stand	8.62kg / 19.0 lbs	11.74kg / 25.9 lbs	16.3 kg / 36.0 lbs	20 kg / 44.1 lbs
Power requirement		AC100-240V~ 50/60Hz 1.3A	AC100-240V~ 50/60Hz 1.5A	AC100-240V~ 50/60Hz 1.8A	AC100-240V~ 50/60Hz 2.2A
Power Consumption		130W	150W	170W	200W
MODELS		42PC5*	42PC5RV*	50PC5*	26LC3*
		42PC51-ZB 42PC52-ZD	42PC5RV-ZD 42PC5RVC-ZD	50PC51-ZB 50PC52-ZD	26LC3RA-ZA
Dimensions (Width x Height x Depth)	with stand	1048.0 x 766.0 x 310.0 mm 41.3 x 30.2 x 12.2 inches	1048.0 x 766.0 x 310.0 mm 41.3 x 30.2 x 12.2 inches	1242.0 x 887.6 x 370.0mm 48.9 x 34.9 x 14.6 inches	680.0 x 550.0 x 235.0 mm 26.8 x 21.7 x 9.3 inches
	without stand	1048.0 x 713.0 x 83.5 mm 41.3 x 28.1 x 3.3 inches	1048.0 x 713.0 x 83.5 mm 41.3 x 28.1 x 3.3 inches	1242.0 x 827.2 x 88.0 mm 48.9 x 32.6 x 3.5 inches	680.0x 436.6 x 119.4 mm 26.8 x 17.2 x 4.7 inches
Weight	with stand	28.0 kg / 61.7 lbs	28.0 kg / 61.7 lbs	39.3 kg / 86.6 lbs	12.4 kg / 27.3 lbs
	without stand	24.6kg / 54.2 lbs	24.6kg / 54.2 lbs	34.6kg / 76.2 lbs	11.5 kg / 25.3 lbs
Power requirement		AC100-240V~ 50/60Hz 3.5A	AC100-240V~ 50/60Hz 3A	AC100-240V~ 50/60Hz 5.0A	AC100-240V~ 50/60Hz 1.3A
Power Consumption		310W	260W	450W	130W
Television System		PAL/SECAM B/G/D/K, PAL I/II, SECAM L/L'			
Program Coverage		VHF: E2 ~ E12, UHF: E21 ~ E69, CATV: S1 ~ S20, HYPER: S21 ~ S47			
External Antenna Impedance		75 Ω			
Environment condition	Operating Temperature	0 ~ 40°C / 32 ~ 104°F			
	Operating Humidity	Less than 80%			
	Storage Temperature	-20 ~ 60°C / -4 ~ 140°F			
	Storage Humidity	Less than 85%			

■ The specifications shown above may be changed without prior notice for quality improvement.

PROGRAMMING THE REMOTE CONTROL

The remote is a multi-brand or a universal remote. It can be programmed to operate most remote-controllable devices of other manufacturers.

Note that the remote may not control all models of other brands.

Programming a code into a remote mode

- 1** Test your remote control.
To find out whether your remote control can operate the component without programming, turn on the component such as a VCR and press the corresponding mode button (such as a **DVD** or **VCR**) on the remote control, while pointing at the component. Test the **POWER** and **PR + / -** buttons to see if the component responds properly. If not, the remote requires programming to operate the device.
- 2** Turn on the component to be programmed, then press the corresponding mode button (such as a **DVD** or **VCR**) on the remote control. The remote control button of desired device is lighted.
- 3** Press the **MENU** and **MUTE** buttons simultaneously, the remote control is ready to be programmed for the code.
- 4** Enter a code number using the number buttons on the remote control. Programming code numbers for the corresponding component can be found on the following pages. Again, if the code is correct, the device will turn off.
- 5** Press the **MENU** button to store the code.
- 6** Test the remote control functions to see if the component responds properly. If not, repeat from step 2.

APPENDIX

Programming code

VCR

Brand	Codes	Brand	Codes	Brand	Codes
AIWA	034	MAGNAVOX	031 033 034 041	SAMSUNG	032 040 102 104
AKAI	016 043 046 124		067 068		105 107 109 112
	125 146	MARANTZ	012 031 033 067		113 115 120 122
AMPRO	072		069		125
ANAM	031 033 103	MARTA	101	SANSUI	022 043 048 135
AUDIO DYNAMICS	012 023 039 043	MATSUI	027 030	SANYO	003 007 010 014
BROKSONIC	035 037 129	MEI	031 033		102 134
CANON	028 031 033	MEMOREX	003 010 014 031	SCOTT	017 037 112 129
CAPEHART	108		033 034 053 072		131
CRAIG	003 040 135		101 102 134 139	SEARS	003 008 009 010
CURTIS MATHES	031 033 041	MGA	045 046 059		013 014 017 020
DAEWOO	005 007 010 064	MINOLTA	013 020		031 042 073 081
	065 108 110 111	MITSUBISHI	013 020 045 046	SHARP	031 054 149
	112 116 117 119		049 051 059 061	SHINTOM	024
DAYTRON	108		151	SONY	003 009 031 052
DBX	012 023 039 043	MTC	034 040		056 057 058 076
DYNATECH	034 053	MULTITECH	024 034		077 078 149
ELECTROHOME	059	NEC	012 023 039 043	SOUNDESIGN	034
EMERSON	006 017 025 027		048	STS	013
	029 031 034 035	NORDMENDE	043	SYLVANIA	031 033 034 059
	036 037 046 101	OPTONICA	053 054		067
	129 131 138 153	PANASONIC	066 070 074 083	SYMPHONIC	034
FISHER	003 008 009 010		133 140 145	TANDY	010 034
FUNAI	034	PENTAX	013 020 031 033	TATUNG	039 043
GE	031 033 063 072		063	TEAC	034 039 043
	107 109 144 147	PHILCO	031 034 067	TECHNICS	031 033 070
GO VIDEO	132 136	PHILIPS	031 033 034 054	TEKNIKA	019 031 033 034
HARMAN KARDON	012 045		067 071 101		101
HITACHI	004 018 026 034	PILOT	101	THOMAS	034
	043 063 137 150	PIONEER	013 021 048	TMK	006
INSTANTREPLAY	031 033	PORTLAND	108	TOSHIBA	008 013 042 047
JCL	031 033	PULSAR	072		059 082 112 131
JCPENNY	012 013 015 033	QUARTZ	011 014	TOTEVISION	040 101
	040 066 101	QUASAR	033 066 075 145	UNITECH	040
JENSEN	043	RCA	013 020 033 034	VECTOR RESEARCH	012
JVC	012 031 033 043		040 041 062 063	VICTOR	048
	048 050 055 060		107 109 140 144	VIDEO CONCEPTS	012 034 046
	130 150 152		145 147	VIDEOSONIC	040
KENWOOD	014 034 039 043	REALISTIC	003 008 010 014	WARDS	003 013 017 024
	047 048		031 033 034 040		031 033 034 040
LG (GOLDSTAR)	001 012 013 020		053 054 101		053 054 131
	101 106 114 123	RICO	058	YAMAHA	012 034 039 043
LLOYD	034	RUNCO	148	ZENITH	034 048 056
LXI	003 009 013 014	SALORA	014		058 072 080 101
	017 034 101 106				
MAGIN	040				

DVD

Brand	Codes	Brand	Codes	Brand	Codes
APEX DIGITAL	022	mitsubishi	002	RCA	005 006
DENON	020 014	NAD	023	SAMSUNG	011 015
GE	005 006	ONKYO	008 017	SONY	007
HARMAN KARDON	027	PANASONIC	003 009	THOMPSON	005 006
JVC	012	PHILIPS	013	TOSHIBA	019 008
LG	001 010 016 025	PIONEER	004 026	YAMAHA	009 018
MAGNAVOX	013	PROCEED	021	ZENITH	010 016 025
MARANTZ	024	PROSCAN	005 006		

APPENDIX

- Here shown may be somewhat different from your TV.

EXTERNAL CONTROL THROUGH RS-232C (This feature is not available for all models.)

Connect the RS-232C input jack to an external control device (such as a computer or an A/V control system) and control the TV's functions externally.

Connect the serial port of the control device to the RS-232C jack on the TV back panel. RS-232C connection cables are not supplied with the TV.

RS-232C Setup

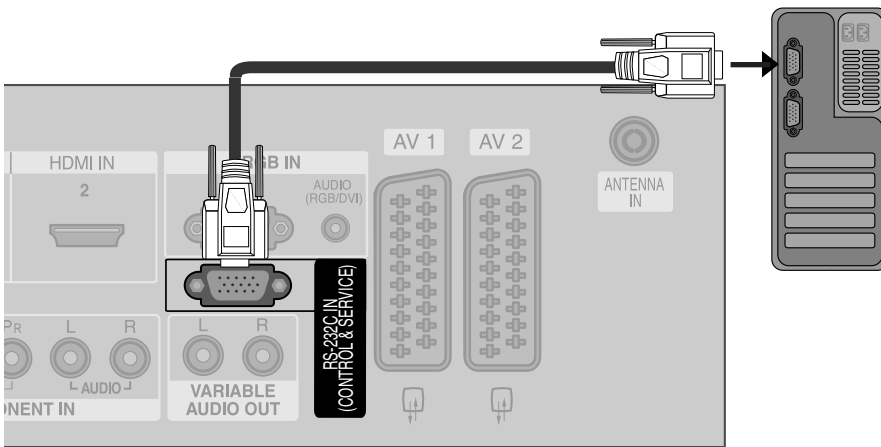

Type of Connector; D-Sub 9-Pin Male

No.	Pin Name
1	No connection
2	RXD (Receive data)
3	TXD (Transmit data)
4	DTR (DTE side ready)
5	GND
6	DSR (DCE side ready)
7	RTS (Ready to send)
8	CTS (Clear to send)
9	No Connection

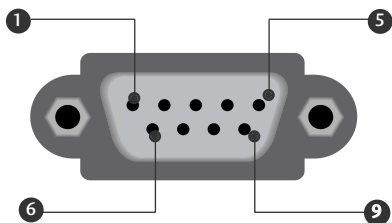

APPENDIX

RS-232C Configurations

7-Wire Configurations (Standard RS-232C cable)

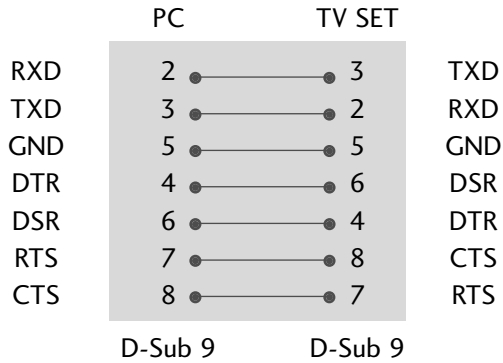

3-Wire Configurations(Not standard)

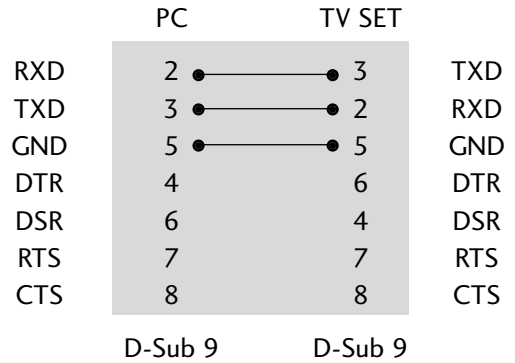

Communication Parameters

- Baud rate : 9600 bps (UART)
- Data length : 8 bits
- Parity : None
- Stop bit : 1 bit
- Communication code : ASCII code
- Use a crossed (reverse) cable.

Command Reference List

	COMMAND1	COMMAND2	DATA (Hexadecimal)		COMMAND1	COMMAND2	DATA (Hexadecimal)
01. Power	k	a	0 ~ 1	13. Balance	k	t	0 ~ 64
02. Aspect Ratio	k	c	*	14. Colour Temperature	k	u	0 ~ 3
03. Screen Mute	k	d	0 ~ 1	15. Red Adjustment	k	v	0 ~ 3C (or 50)
04. Volume Mute	k	e	0 ~ 1	16. Green Adjustment	k	w	0 ~ 3C (or 50)
05. Volume Control	k	f	0 ~ 64	17. Blue Adjustment	k	\$	0 ~ 3C (or 50)
06. Contrast	k	g	0 ~ 64	18. Abnormal Status	k	z	FF
07. Brightness	k	h	0 ~ 64	19. ISM Method	j	p	0 ~ 3
08. Colour	k	i	0 ~ 64	20. Low Power	j	q	0 ~ 1
09. Tint	k	j	0 ~ 64	21. Orbiter Time Setting	j	r	1 ~ FE
10. Sharpness	k	k	0 ~ 64	22. Orbiter Pixel Setting	j	s	1 ~ 3
11. OSD Select	k	l	0 ~ 1	23. Auto Configure	j	u	1
12. Remote Control lock mode	k	m	0 ~ 1	24. Programme selection	m	a	*
				25. Send IR Code	m	c	Key Code
				26. Input select	x	b	*

Transmission / Receiving Protocol

Transmission

[Command1][Command2][][Set ID][][Data][Cr]

[Command 1] : First command to control the set.(j,k,mor x)

[Command 2] : Second command to control the set.

[Set ID] : You can adjust the selDtochoosedesired TV ID number in Setup menu. Adjustment range is 1 ~ 99. When selecting Set ID '0', every connected the TV is controlled. Set ID is indicated as decimal (1 ~ 99) on menu and as Hexa decimal (0x0 ~ 0x63) on transmission/receiving protocol.

[DATA] : To transmit command data.

Transmit 'FF' data to read status of comand.

[Cr] : Carriage Return

ASCII code '0x0D'

[] : ASCII code 'space (0x20)'

OK Acknowledgement

[Command2][][Set ID][][OK][Data][x]

The TV transmits ACK (acknowledgement) based on this format when receiving normal data. At this time, if the data is data read mode, it indicates present status data. If the data is data write mode, it returns the data of the PC computer.

Error Acknowledgement

[Command2][][Set ID][][NG][Data][x]

The TV transmits ACK (acknowledgement) based on this format when receiving abnormal data from non-viable functions or communication errors.

Data1: Illegal Code

Data2: Not supported function

Data3: Wait more time

APPENDIX

01. Power (Command2:a)

To control Power On/Off of the TV.

Transmission [k][a][][Set ID][][Data][Cr]

Data 0 : Power Off Data 1 : Power On

Acknowledgement [a][][Set ID][][OK][Data][x]

To show Power On/Off.

Transmission [k][a][][Set ID][][FF][Cr]

Acknowledgement [a][][Set ID][][OK][Data][x]

- * In a like manner, if other functions transmit 'FF' data based on this format, Acknowledgement data feedback presents status about each function.
- * To change the Power on input the transmission more than twice.

02. Aspect Ratio (Command2:c)

To adjust the screen format.

You can also adjust the screen format using the RATIO button on remote control or in the Picture menu.

Transmission [k][c][][Set ID][][Data][Cr]

Data 1: Normal screen (4:3) Data 5: Full screen (Zoom2)
Data 2: Wide screen (16:9) Data 6: Original
Data 3: Spectacle Data 7: Wide screen (14:9)
Data 4: Full screen (Zoom1) Data 8: Full (Option)

Acknowledgement [c][][Set ID][][OK][Data][x]

- * Using the RGB-PC or Component input, you select either 16:9 or 4:3 screen aspect ratio.

03. Screen Mute (Command2:d)

To select screen mute on/off.

Transmission [k][d][][Set ID][][Data][Cr]

Data 0 : Screen mute off (Picture on)
Data 1 : Screen mute on (Picture off)

Acknowledgement [d][][Set ID][][OK][Data][x]

04. Volume Mute (Command2:e)

To control volume mute on/off.

You can also adjust mute using the MUTE button on remote control.

Transmission [k][e][][Set ID][][Data][Cr]

Data 0 : Volume mute on (Volume off)
Data 1 : Volume mute off (Volume on)

Acknowledgement [e][][Set ID][][OK][Data][x]

05. Volume Control (Command2:f)

To adjust volume.

You can also adjust volume with the volume buttons on remote control.

Transmission [k][f][][Set ID][][Data][Cr]

Data Min : 0 ~ Max : 64

Refer to 'Real data mapping 1' : See page 6.

Acknowledgement [f][][Set ID][][OK][Data][x]

06. Contrast (Command2:g)

To adjust screen contrast.

You can also adjust contrast in the Picture menu.

Transmission [k][g][][Set ID][][Data][Cr]

Data Min : 0 ~ Max : 64

Refer to 'Real data mapping 1' : See page 6.

Acknowledgement [g][][Set ID][][OK][Data][x]

07. Brightness (Command2:h)

To adjust screen brightness.

You can also adjust brightness in the Picture menu.

Transmission [k][h][][Set ID][][Data][Cr]

Data Min : 0 ~ Max : 64

Refer to 'Real data mapping 1' : See page 6.

Acknowledgement [h][][Set ID][][OK][Data][x]

08. Colour (Command2:i)

To adjust the screen colour.

You can also adjust colour in the Picture menu.

Transmission [k][i][][Set ID][][Data][Cr]

Data Min : 0 ~ Max : 64

Refer to 'Real data mapping 1' : See page 6.

Acknowledgement [i][][Set ID][][OK][Data][x]

09. Tint (Command2:j)

To adjust the screen tint.

You can also adjust tint in the Picture menu.

Transmission [k][j][][Set ID][][Data][Cr]

Data Red : 0 ~ Green : 64

Refer to 'Real data mapping 1' : See page 6.

Acknowledgement [j][][Set ID][][OK][Data][x]

10. Sharpness (Command2:k)

To adjust the screen sharpness.

You can also adjust sharpness in the Picture menu.

Transmission [k][k][][Set ID][][Data][Cr]

Data Min: 0 ~ Max: 64

Refer to 'Real data mapping 1'. See page 6.

Acknowledgement [k][][Set ID][][OK][Data][x]

11. OSD Select (Command2:l)

To select OSD (On Screen Display) on/off when controlling remotely.

Transmission [k][l][][Set ID][][Data][Cr]

Data 0: OSD off

Data 1: OSD on

Acknowledgement [l][][Set ID][][OK][Data][x]

12. Remote Control Lock Mode (Command2:m)

To lock the remote control and the front panel controls on the set.

Transmission [k][m][][Set ID][][Data][Cr]

Data 0: Lock off

Data 1: Lock on

Acknowledgement [m][][Set ID][][OK][Data][x]

If you're not using the remote control and front panel controls on the TV, use this mode. When main power is on/off, remote control lock is released.

13. Balance (Command2:t)

To adjust balance.

You can also adjust balance in the Sound menu.

Transmission [k][t][][Set ID][][Data][Cr]

Data Min: 0 ~ Max: 64

Refer to 'Real data mapping 1'. See page 6.

Acknowledgement [t][][Set ID][][OK][Data][x]

14. Color Temperature (Command2:u)

To adjust color temperature.

You can also adjust Colour Temperature in the Picture menu.

Transmission [k][u][][Set ID][][Data][Cr]

Data 0: Cool 1: Medium 2: Warm 3: User

Acknowledgement [u][][Set ID][][OK][Data][x]

15. Red Adjustment (Command2:v)

To adjust red in colour temperature.

Transmission [k][v][][Set ID][][Data][Cr]

Data Min: 0 ~ Max: 3C (or 50)

Refer to 'Real data mapping 2'. See page 6.

Acknowledgement [v][][Set ID][][OK][Data][x]

16. Green Adjustment (Command2:w)

To adjust green in colour temperature.

Transmission [k][w][][Set ID][][Data][Cr]

Data Min: 0 ~ Max: 3C (or 50)

Refer to 'Real data mapping 2'. See page 6.

Acknowledgement [w][][Set ID][][OK][Data][x]

17. Blue Adjustment (Command2:\$)

To adjust blue in colour temperature.

Transmission [k][\$][][Set ID][][Data][Cr]

Data Min: 0 ~ Max: 3C (or 50)

Refer to 'Real data mapping 2'. See page 6.

Acknowledgement [\$][][Set ID][][OK][Data][x]

APPENDIX

18. Abnormal State (Command2:z)

To recognize an abnormal state.

This feature is not available for all models.

Transmission [k][z][][Set ID][][FF][][Cr]

Data FF: Read

Acknowledgement [z][][Set ID][][OK][Data][x]

Data 0: Normal (Power on and signal exist)

Data 1: No signal (Power on)

Data 2: Turn the TV off by remote control

Data 3: Turn the TV off by sleep time function

Data 4: Turn the TV off by RS-232C function

Data 5: 5V down

Data 6: AC down

Data 7: Turn the TV off by Fan Alarm function (option)

Data 8: Turn the TV off by Off time function

Data 9: Turn the TV off by Auto sleep function

* This function is "read only".

19. ISM Method (Command1:j, Command2:p)

To control the ISM method. You can also adjust ISM Method in Option menu.

This feature is not available for all models.

Transmission [j][p][][Set ID][][Data][Cr]

Data 0: Normal Mode Data 1: White Wash

Data2: Orbiter Data3: Inversion

Acknowledgement [p][][Set ID][][OK][Data][x]

20. Low Power (Command1:j, Command2:q)

To reduce the power consumption of the monitor. You can also adjust Low Power in Option menu.

This feature is not available for all models.

Transmission [j][q][][Set ID][][Data][][Cr]

Data 0: Off Data 1: On

Acknowledgement [q][][Set ID][][OK][Data][x]

21. Orbiter Time Setting (Command1:j, Command2:r)

To adjust orbiter operation time term.

This feature is not available for all models.

Transmission [j][r][][Set ID][][Data][][Cr]

Data Min: 1 ~ Max: FE

Refer to 'Real data mapping 1'.

Acknowledgement [r][][Set ID][][OK][Data][x]

22. Orbiter Pixel Setting (Command1:j, Command2:s)

To adjust pixel number in orbiter function.

This feature is not available for all models.

Transmission [j][s][][Set ID][][Data][Cr]

Data Min: 1 ~ Max: 3

Refer to 'Real data mapping 1'.

Acknowledgement [s][][Set ID][][OK][Data][x]

23. Auto Configure (Command1:j, Command2:u)

To adjust picture position and minimize image shaking automatically. It works only in RGB (PC) mode.

Transmission [j][u][][Set ID][][Data][Cr]

Data 1: To set

Acknowledgement [u][][Set ID][][OK][Data][x]

24. Programme selection (Command1:m, Command2:a)

To select a programme for the main picture.

Transmission [m][a][][Set ID][][Data0][][Data1][][Data2][Cr]

Data 0: Min: 0 ~ Max: 63 (0 ~ C7, 200 Pr is on)

Refer to 'Real data mapping 1'.

Data 1: Don't care

Data 2: 0 : Main

1 : Sub(option)

Acknowledgement [a][][Set ID][][OK][Data0][x]

* Real data mapping 1

0 : Step 0
 ⋮
 A : Step 10 (Set ID 10)
 ⋮
 F : Step 15 (Set ID 15)
 10 : Step 16 (Set ID 16)
 ⋮
 64 : Step 100
 ⋮
 6E : Step 110
 ⋮
 73 : Step 115
 74 : Step 116
 ⋮
 C7 : Step 199
 ⋮
 FE : Step 254
 FF : Step 255

* Real data mapping 2

0 : -40
 1 : -39
 2 : -38
 ⋮
 28 : 0
 ⋮
 4E : +38
 4F : +39
 50 : +40

25. Key (Command1:m, Command2:c)

To send IR remote key code.

Transmission [m][c][][Set ID][][Data][Cr]

Data: Key code - Refer to page 9

Acknowledgement [c][][Set ID][][OK][Data][x]

26. Input select (Command1:x, Command2:b)

To select input source for TV

Transmission [x][b][][Set ID][][Data][Cr]

Data: Structure

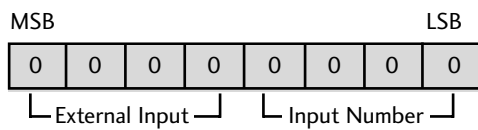

External Input				Data
0	0	0	1	Analog
0	0	1	0	AV
0	1	0	0	Component
0	1	1	0	RGB-PC
1	0	0	1	HDMI

Input Number				Data
0	0	0	0	Input1
0	0	0	1	Input2
0	0	1	0	Input3
0	0	1	1	Input4
0	1	0	0	Input5
0	1	0	1	Input6

Acknowledgement [b][][Set ID][][OK][Data][x]

APPENDIX

IR CODES

1. How to Connect

- Connect your wired remote control to the Remote Control port on the TV.

2. Remote Control IR Codes

■ Output waveform

Single pulse, modulated with 37.917KHz signal at 455KHz

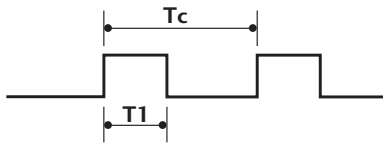

Carrier frequency
 $FCAR = 1/TC = fOSC/12$
 Duty ratio = $T1/TC = 1/3$

■ Configuration of frame

1st frame

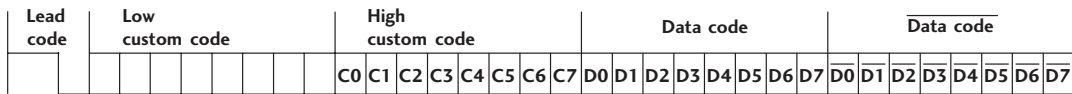

Repeat frame

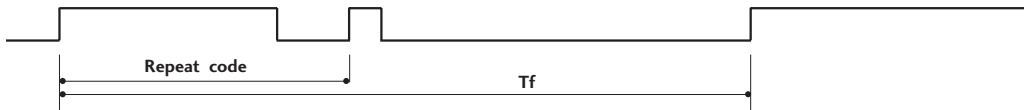

■ Lead code



■ Repeat code

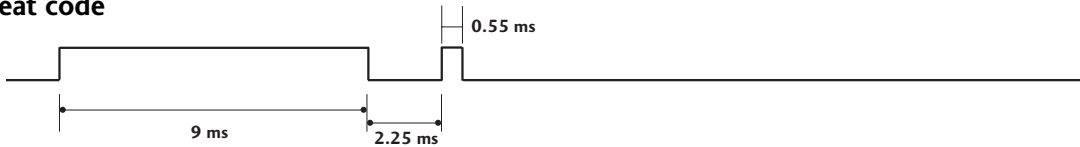

■ Bit description

Bit "0"

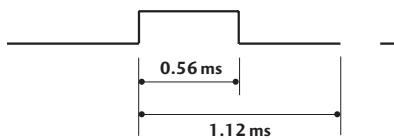

Bit "1"

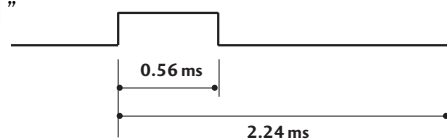

■ Frame interval: Tf

The waveform is transmitted as long as a key is depressed.

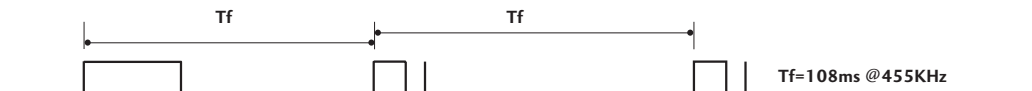

REMOTE CONTROL IR CODES

Code (Hexa)	Function	Note	Code (Hexa)	Function	Note
0F	TV	R/C Button	02	VOL +	R/C Button
0B	INPUT	R/C Button	03	VOL -	R/C Button
08	POWER	R/C Button (Power On/Off)	00	PR +	R/C Button
7E	SIMPLINK	R/C Button	01	PR -	R/C Button
0E	SLEEP	R/C Button	09	MUTE	R/C Button
20	TEXT	R/C Button	53	LIST	R/C Button
0A	I/II	R/C Button	10 ~ 19	Number Key 0 ~ 9	R/C Button
43	MENU	R/C Button	1A	Q.VIEW	R/C Button
79	RATIO	R/C Button	64	SIZE	R/C Button
5B	EXIT	R/C Button	70	INDEX	R/C Button
07	◀	R/C Button	26	TIME	R/C Button
06	▶	R/C Button	2A	REVEAL	R/C Button
40	▲	R/C Button	E0	☀ +	R/C Button
41	▼	R/C Button	E1	☀ -	R/C Button
44	OK	R/C Button	B0	▶	R/C Button
1E	FAV	R/C Button	B1	■	R/C Button
62	UPDATE	R/C Button	B2	⏮	R/C Button
65	HOLD	R/C Button	B3	⏭	R/C Button
72	RED	R/C Button	BD	●	R/C Button
71	GREEN	R/C Button	8F	⏪	R/C Button
63	YELLOW	R/C Button	8E	⏩	R/C Button
61	BLUE	R/C Button	BA	⏸	R/C Button

LG Electronics Inc.