



LG Electronics Inc.

LCD TV | PLASMA TV OWNER'S MANUAL

LCD TV MODELS	PLASMA TV MODEL
42LY3RF	60PY3RF
47LY3RF	

Please read this manual carefully and completely before operating your set. Retain it for future reference. Record model number and serial number of the set. See the label attached on the back cover and quote this information to your dealer when you require service.



WARNING

IMPORTANT SAFETY INSTRUCTIONS

Important safety instructions shall be provided with each apparatus. This information shall be given in a separate booklet or sheet, or be located before any operating instructions in an instruction for installation for use and supplied with the apparatus.

This information shall be given in a language acceptable to the country where the apparatus is intended to be used.

The important safety instructions shall be entitled “Important Safety Instructions”. The following safety instructions shall be included where applicable, and, when used, shall be verbatim as follows. Additional safety information may be included by adding statements after the end of the following safety instruction list. At the manufacturer’s option, a picture or drawing that illustrates the intent of a specific safety instruction may be placed immediately adjacent to that safety instruction :

Read these instructions.
Keep these instructions.
Heed all warnings.
Follow all instructions.



- 1 Do not use this apparatus near water.

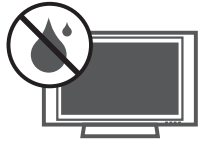

- 2 Clean only with dry cloth.



- 3 Do not block any ventilation openings. Install in accordance with the manufacturer’s instructions.



- 4 Do not install near any heat sources such as radiators, heat registers, stoves, or other apparatus (including amplifiers) that produce heat.



- 5 Do not defeat the safety purpose of the polarized or grounding-type plug. A polarized plug has two blades with one wider than the other. A grounding type plug has two blades and a third grounding prong. The wide blade or the third prong are provided for your safety. If the provided plug does not fit into your outlet, consult an electrician for replacement of the obsolete outlet.



WARNING

IMPORTANT SAFETY INSTRUCTIONS

- 6 Protect the power cord from being walked on or pinched particularly at plugs, convenience receptacles, and the point where they exit from the apparatus.



- 7 Only use attachments/accessories specified by the manufacturer.



- 8 Unplug this apparatus when unused for long periods of time.

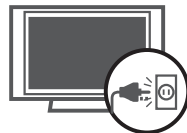

- 9 Use only with the cart, stand, tripod, bracket, or table specified by the manufacturer, or sold with the apparatus. When a cart is used, use caution when moving the cart/apparatus combination to avoid injury from tip-over.



- 10 Never touch this apparatus or antenna during a thunder or lightning storm.

- 11 Do not allow an impact shock or any objects to fall into the product, and do not drop onto the screen with something. (You may be injured or the product can be damaged.)

- 12 Refer all servicing to qualified service personnel. Servicing is required when the apparatus has been damaged in any way, such as power-supply cord or plug is damaged, liquid has been spilled or objects have fallen into the apparatus, the apparatus has been exposed to rain or moisture, does not operate normally, or has been dropped.



WARNING

- 13** CAUTION concerning the Power Cord :
Most appliances recommend they be placed upon a dedicated circuit; that is, a single outlet circuit which powers only that appliance and has no additional outlets or branch circuits. Check the specification page of this owner's manual to be certain.

Do not overload wall outlets. Overloaded wall outlets, loose or damaged wall outlets, extension cords, frayed power cords, or damaged or cracked wire insulation are dangerous. Any of these conditions could result in electric shock or fire. Periodically examine the cord of your appliance, and if its appearance indicates damage or deterioration, unplug it, discontinue use of the appliance, and have the cord replaced with an exact replacement part by an authorized servicer. Protect the power cord from physical or mechanical abuse, such as being twisted, kinked, pinched, closed in a door, or walked upon. Pay particular attention to plugs, wall outlets, and the point where the cord exits the appliance.



- 14** Outdoor Use Marking :
WARNING - To Reduce The Risk Of Fire Or Electric Shock, Do Not Expose This Appliance To Rain Or Moisture



- 15** Wet Location Marking : Apparatus shall not be exposed to dripping or splashing and no objects filled with liquids, such as vases, shall be placed on or over apparatus.



- 16** GROUNDING

Ensure that you connect the earth ground wire to prevent possible electric shock. If grounding methods are not possible, have a qualified electrician install a separate circuit breaker.

Do not try to ground the unit by connecting it to telephone wires, lightning rods, or gas pipes.

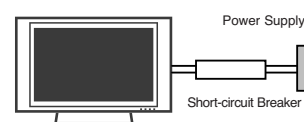

- 17** DISCONNECTING DEVICE FROM MAINS
Main plug is the disconnecting device. The plug must remain readily operable.

CONTENTS

WARNING	1
FEATURES OF THIS TV	6

PREPARATION

Accessories	7
Front Panel Controls	8
Back Panel Information	10
Back Cover for Wire Arrangement	12
Attaching the TV to a Wall	14
Not Using The Desk-Type Stand	15
Swivel Function	15
Antenna or Cable Connection	17

EXTERNAL EQUIPMENT SETUP

HD Receiver Setup	18
DVD Setup	20
VCR Setup	22
Other A/V Source Setup	24
PC Setup	25
Screen Setup for PC Mode	28
AV Out Setup	32
External Stereo	32

WATCHING TV / SETUP CONTROL

Turning on TV	33
Remote Control Functions	34
On-Screen Menus Selection and Adjustment ..	36
Channel Setup	37
- Auto tuning: Channel Search	37
- Manual tuning: Adding/Deleting Channels ..	38
SIMPLINK	39
Input Label	41
Fine tuning Adjustment	42
Booster	43
Favorite Channels Setup	44

PICTURE CONTROL

PIP/Double Window	45
- Watching PIP/Double Window	45
- TV Program Selection for PIP	45
- Selecting an Input Signal Source for the PIP/Double Window	46
- Sub Picture Size Adjustment (PIP mode only)	46
- Moving the Sub Picture (PIP mode only) ..	46
- Swapping the PIP/Double window	46
Picture Mode Control	47
Manual Picture Control (Picture mode-User option) ..	48
Color Temperature Control	49
Manual Color Temperature Control (User option)	50
XD	51
Advanced - Cinema Mode Setup	52
Advanced - Black Level	53
Aspect Ratio Control	54
Picture Reset	55
XD Demo	56

AUDIO CONTROL

Sound Mode Control	57
Sound Control Adjustment (User option)	58
Auto Volume Leveler	59
Balance Adjustment	60
TV Speakers On/Off Setup	61
Stereo/SAP Broadcast Setup	62

TIME SETTING

Clock Setup	63
On/Off Time Setup	64
Sleep Time	65
Auto Sleep	66

OPTION CONTROL

On Screen Menus Language Selection	67
Key Lock	68
Closed Captions	69
ISM (Image Sticking Minimization) Method .	70
Low Power	71
Index	72

APPENDIX

Troubleshooting Checklist	73
Maintenance	75
Product Specifications	76
Programming the Remote Control	78
Programming Codes	78
IR Codes	80
External Control Device Setup	82

FEATURES OF THIS TV

What is a Plasma TV ?

Using plasma is the best way to achieve flat panel displays with excellent image quality and large screen sizes that are easily viewable. The Plasma TV can be thought of as a descendant of the neon lamp and or a series of fluorescent lamps.

How does it work?

Plasma TV is an array of cells, known as pixels, which are comprised of three sub-pixels, corresponding to the colors red, green, and blue. Gas in a plasma state is used to react with phosphors in each sub-pixel to produce colored light (red, green, or blue). These phosphors are the same types used in Cathode Ray Tube (CRT) devices such as televisions and common computer monitors.

Plasma TV offers a rich, dynamic display because each sub-pixel is individually controlled by advanced electronics to produce over 16 million different colors. This means that you get perfect images that are easily viewable in a display that is fewer than five inches thick.

160° - Wide angle range of vision

Your flat panel plasma screen offers an exceptionally broad viewing angle of over 160 degrees. This means that the display is clear and visible to viewers anywhere in the room.

Wide Screen

The wide screen offers a theater-like experience in your own home.

Multimedia

Connect your plasma display to a PC and use it for conferencing, games, and Internet browsing. The Picture-in-Picture feature allows you to view your PC and video images simultaneously.

Versatile

The light weight and thin size makes it easy to install your plasma display in a variety of locations where conventional TVs do not fit.

The Plasma TV Manufacturing Process: a few minute colored dots may be present on the Plasma TV screen

The Plasma TV is composed of 0.9 to 2.2 million cells. A few cell defects will normally occur in the Plasma TV manufacturing process. Several tiny, minute colored dots visible on the screen should be acceptable. This also occurs in other Plasma TV manufacturers' products. The tiny dots appearing does not mean that this Plasma TV is defective. Thus a few cell defects are not sufficient cause for the Plasma TV to be exchanged or returned. Our production technology minimizes these cell defects during the manufacture and operation of this product.

FOR LCD TV

If the TV feels cold to the touch, there may be a small "flicker" when it is turned on. This is normal, there is nothing wrong with TV.

Some minute dot defects may be visible on the screen, appearing as tiny red, green, or blue spots. However, they have no adverse effect on the monitor's performance.

Avoid touching the LCD screen or holding your finger(s) against it for long periods of time. Doing so may produce some temporary distortion effects on the screen.

On Disposal

- a. The fluorescent lamp used in this product contains a small amount of mercury.
- b. Do not dispose of this product with general household waste.
- c. Disposal of this product must be carried out in accordance to the regulations of your local authority.

PREPARATION

ACCESSORIES

Ensure that the following accessories are included with your product. If an accessory is missing, please contact the dealer where you purchased the product.

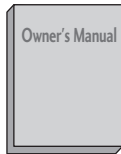

Owner's Manual

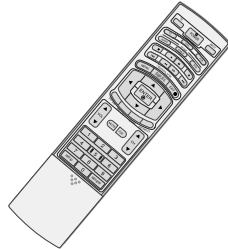

Remote Control



Power Cord

* This feature is not available for all models.

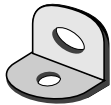

2- TV Brackets
2- Wall Brackets

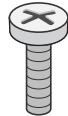

2-bolts

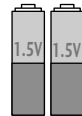

Batteries



RF Adapter

You must connect it to the antenna wire after fixing in Antenna Input. This adapter is only supplied in Argentina.

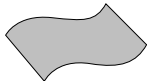

Polishing Cloth
Polish the screen with the cloth.

* Slightly wipe stained spot on the exterior only with the polishing cloth for the product exterior if there is stain or fingerprint on surface of the exterior.

* Do not wipe roughly when removing stain. Please be cautions of that excessive power may cause scratch or discoloration.

For LCD TV models



Cable Management



Twist Holder

Arrange the wires with the twist holder.
(This feature is not available for all models.)

For PLASMA TV models

(Refer to p. 15)

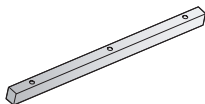

Additional Cover



3 - Bolts



2 - Rubber

PREPARATION

FRONT PANEL CONTROLS

- This is a simplified representation of the front panel. Here shown may be somewhat different from your TV.
- If your TV has the protection film, wipe the stand with polishing cloth after removing the protection film attached to the stand.

<60PY3RF>

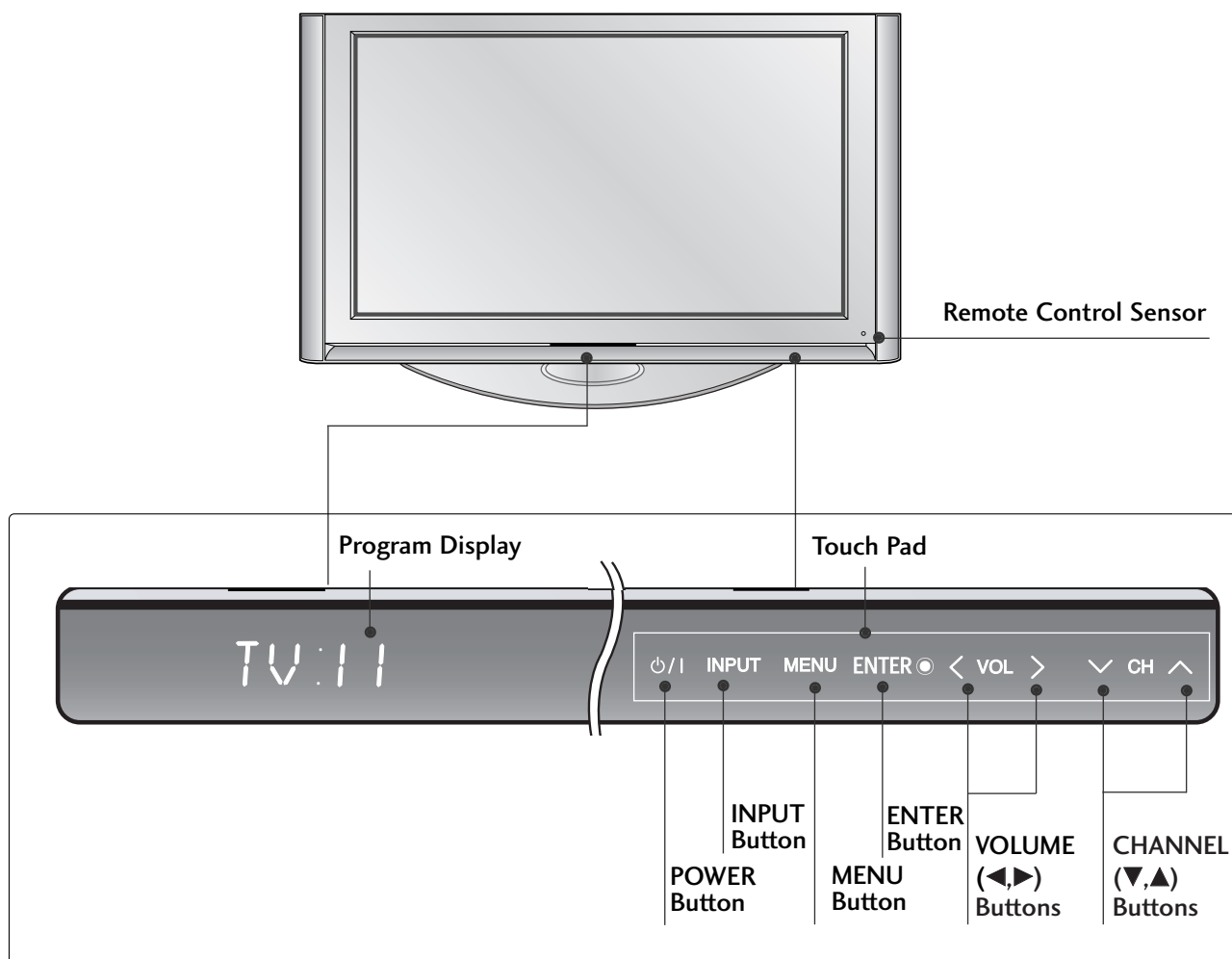

<42/47LY3RF>

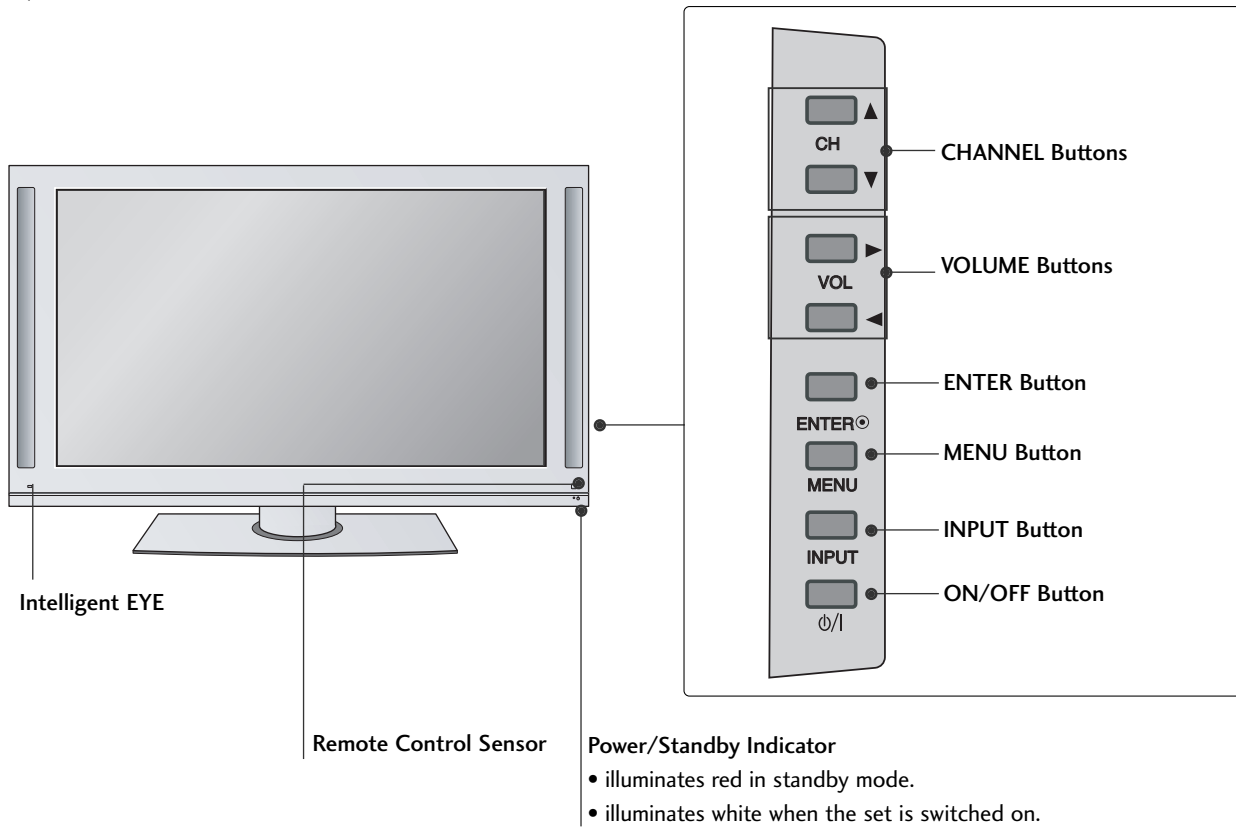

BACK PANEL INFORMATION

<60PY3RF>

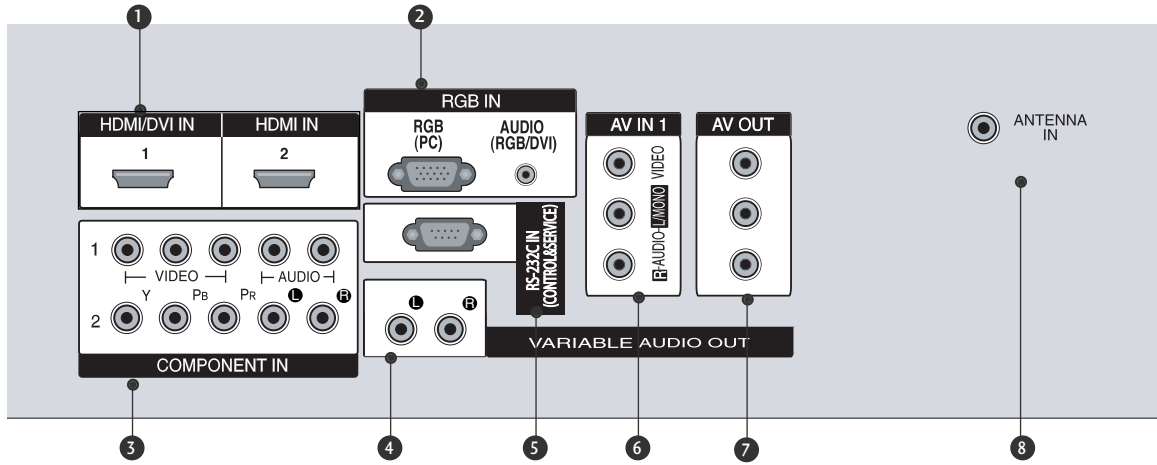
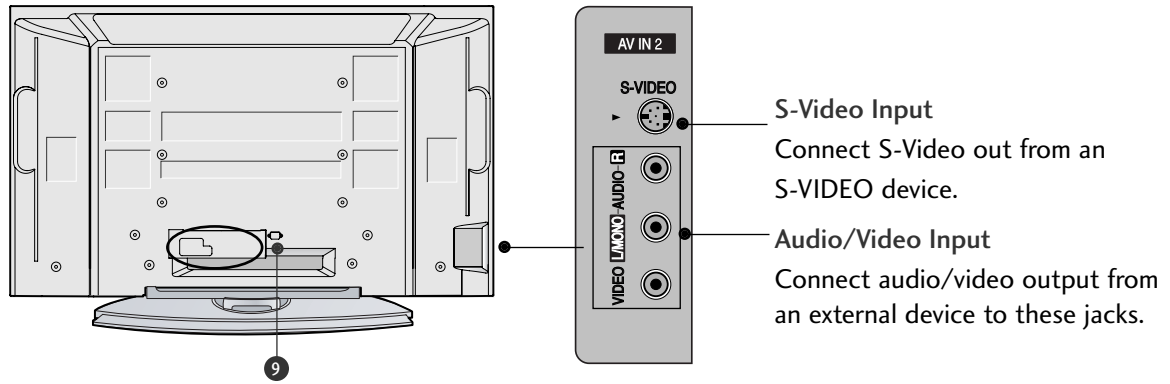

<42/47LY3RF>

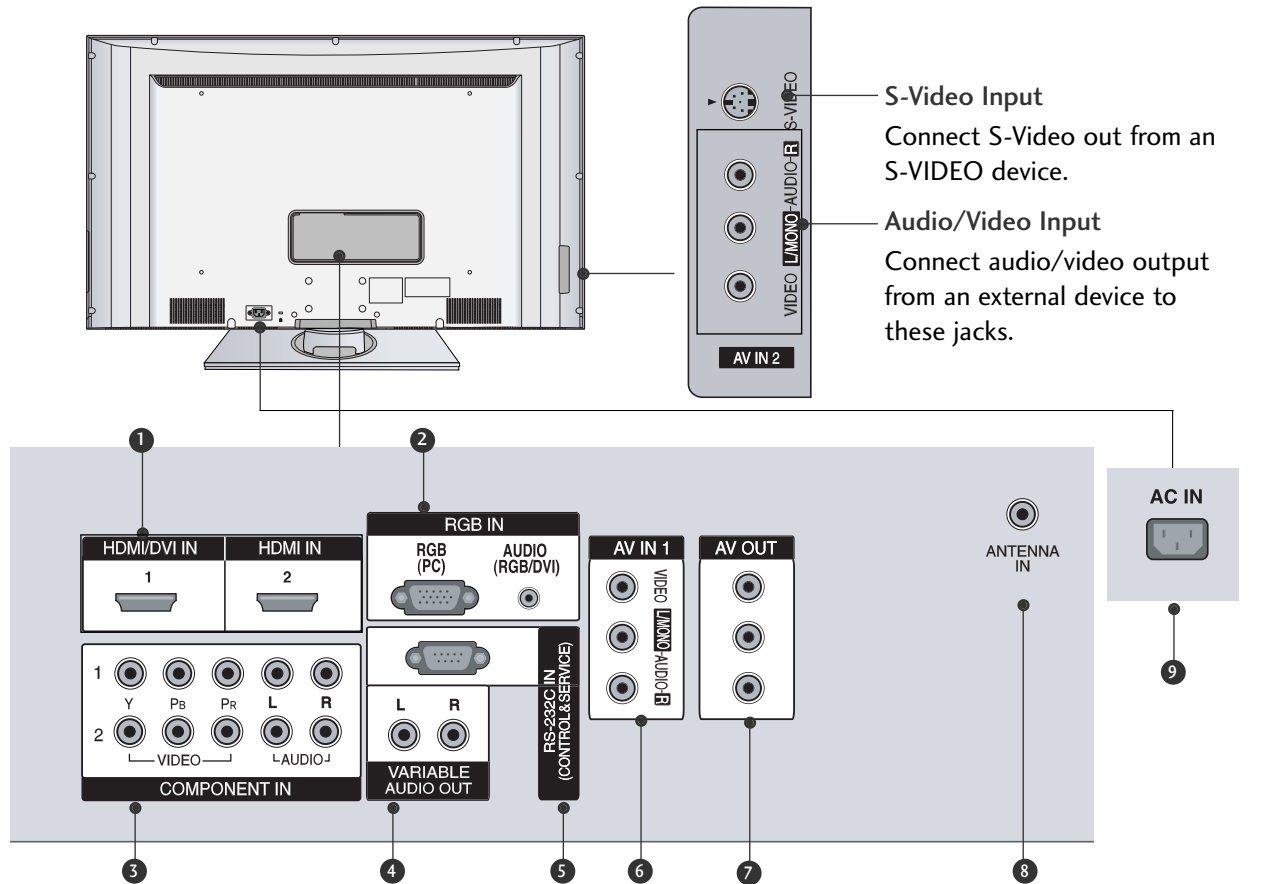

- 1** HDMI/DVI, HDMI Input
 Connect a HDMI signal to HDMI IN.
 Or DVI(VIDEO)signal to HDMI/DVI port with DVI to HDMI cable.
- 2** RGB/Audio Input
 Connect the monitor output from a PC(only Audio) to the appropriate input port.
- 3** Component Input 1/2
 Connect a component video/audio device to these jacks.
- 4** Variable Audio Output
 Connect an external amplifier or add a subwoofer to your surround sound system.
- 5** RS-232C INPUT(CONTROL/SERVICE)PORT
 Connect the serial port of the control devices to the RS-232C jack.
- 6** AV IN 1
 Connect audio/video output from an external device to these jacks.
- 7** AV OUT
 Connect a second TV or Monitor.
- 8** Antenna In
 Connect over-the-air signals to this jack.
- 9** Power Cord Socket
 This TV operates on an AC power. The voltage is indicated on the Specifications page. Never attempt to operate the TV on DC power.

BACK COVER FOR WIRE ARRANGEMENT

<60PY3RF>

- 1 Hold the **CABLE MANAGEMENT** with both hands and pull it as shown.

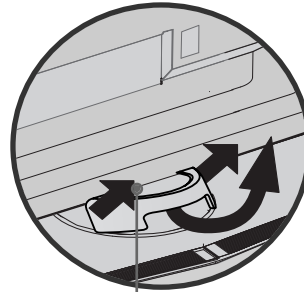
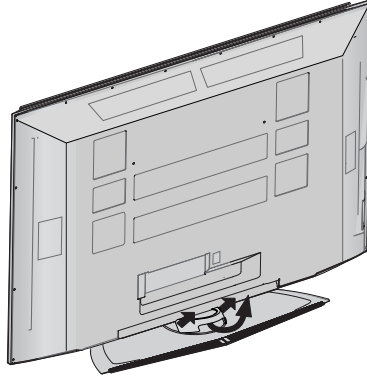

45°

CABLE MANAGEMENT

- 2 Connect the cables as necessary.
To connect an additional equipment, see the **External equipment Connections** section.

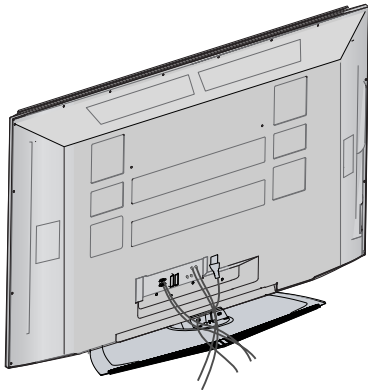

- 3 Install the **CABLE MANAGEMENT** as shown.

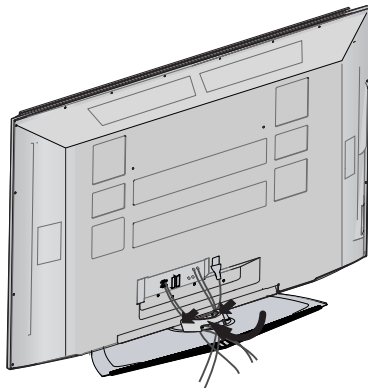

<42/47LY3RF>

- 1 Connect the cables as necessary.

To connect an additional equipment, see the **External equipment Connections** section.

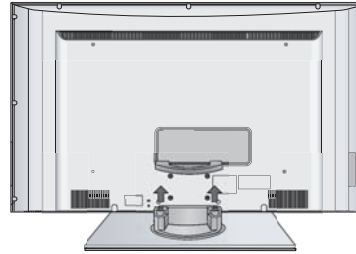

- 2 Install the **CABLE MANAGEMENT** as shown.

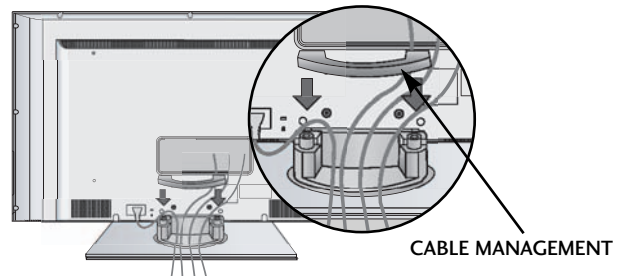

- 3 Bundle the cables using the supplied twister holder. (This feature is not available for all models.)

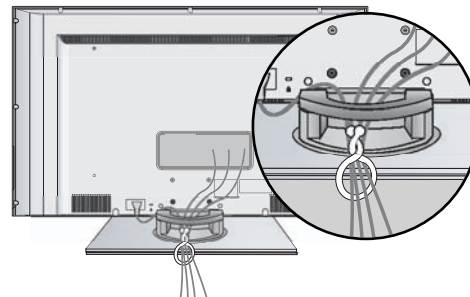

How to remove the cable management

Hold the **CABLE MANAGEMENT** with both hands and pull it upward.

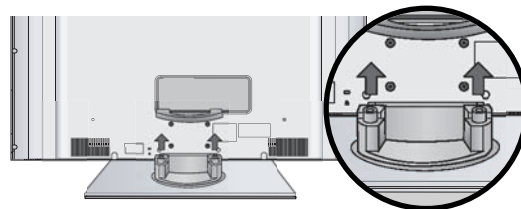

! NOTE

- ▶ Do not hold the **CABLE MANAGEMENT** when moving the product.
- If the product is dropped, you may be injured or the product may be broken.

PREPARATION

ATTACHING THE TV TO A WALL

* This feature is not available for all models.

- Set it up close to the wall so the product doesn't fall over when it is pushed backwards.
- The instructions shown below is a safer way to set up the product, which is to fix it on the wall so the product doesn't fall over when it is pulled in the forward direction. It will prevent the product from falling for-ward and hurting people. It will also prevent the product from damage caused by fall. Please make sure that children don't climb on or hang from the product.

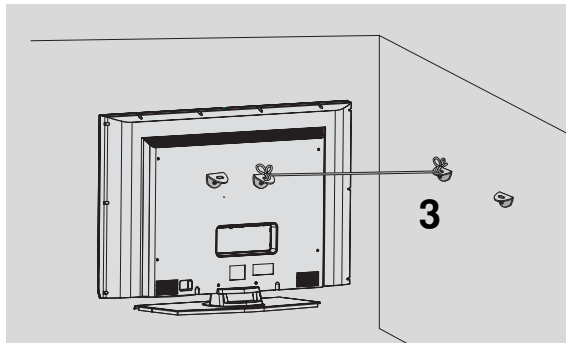
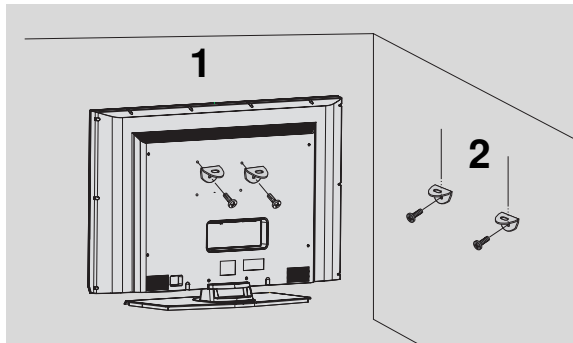

- 1** Use the eye-bolts or TV brackets/bolts to fix the product to the wall as shown in the picture.
(If your product has the bolts in the eye-bolts position before inserting the eye-bolts, loosen the bolts.)
* Insert the eye-bolts or TV brackets/bolts and tighten them securely in the upper holes.
- 2** Secure the wall brackets with the bolts (not provided as parts of the product, must purchase separately) on the wall. Match the height of the bracket that is mounted on the wall.

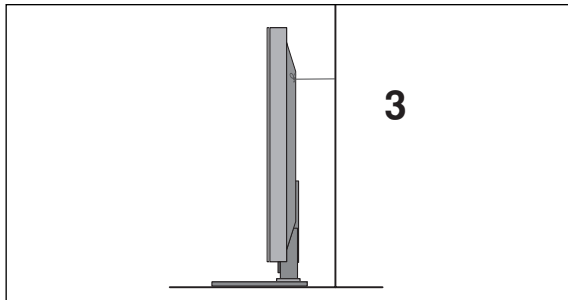

- 3** Use a sturdy rope (not provided as parts of the product, must purchase separately) to tie the product. It is safer to tie the rope so it becomes horizontal between the wall and the product.

! NOTE

- ▶ When moving the product to another place undo the ropes first.
- ▶ Use a product holder or a cabinet that is big and strong enough for the size and weight of the product.
- ▶ To use the product safely make sure that the height of the bracket that is mounted on the wall is same as that of the product.

NOT USING THE DESK-TYPE STAND (Only 60PY3RF model)

- It is applied to when installing only the 60PY3RF model as wall-type.

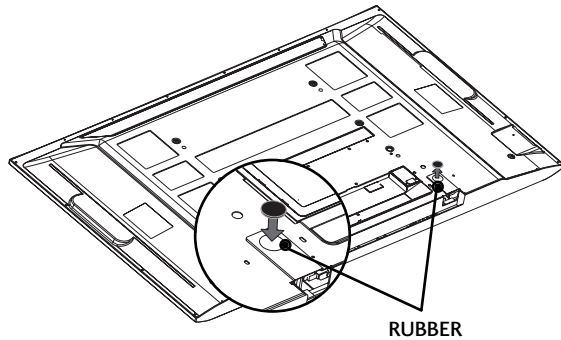

When not using the desk-type stand, install the supplied desk-type stand fixture protection rubber caps as shown at the figure.

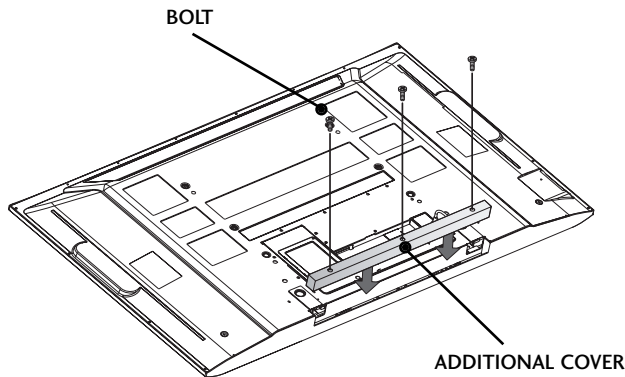

To prevent the foreign materials from entering the desk-type stand fixture, fix the desk-type stand fixture protection cover (additional cover) by using the supplied bolts as shown at the figure.

SWIVEL FUNCTION

- After installing the TV, you can adjust the the TV set manually turning it to the left or right direction by 20 degrees to suit your viewing position.

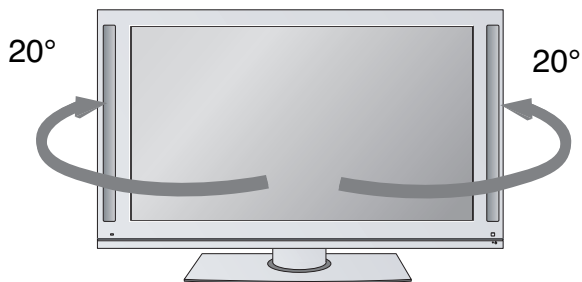

! NOTE (Only 60PY3RF model)

- Before adjusting the angle, you must remove the cable management and loosen (to the left) the shaft bolt on the middle of stand's back. And when stand be level with TV, you must close (to the right) the shaft bolt to set the hole.



PREPARATION

- The TV can be installed in various ways such as on a wall, or on a desktop etc.
- The TV is designed to be mounted horizontally.

GROUNDING

Ensure that you connect the earth ground wire to prevent possible electric shock. If grounding methods are not possible, have a qualified electrician install a separate circuit breaker. Do not try to ground the unit by connecting it to telephone wires, lightening rods, or gas pipes.

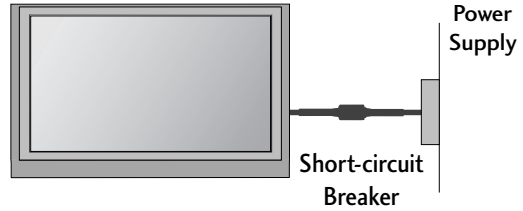

Desktop Pedestal Installation

For proper ventilation, allow a clearance of 4" on each side and from the wall.

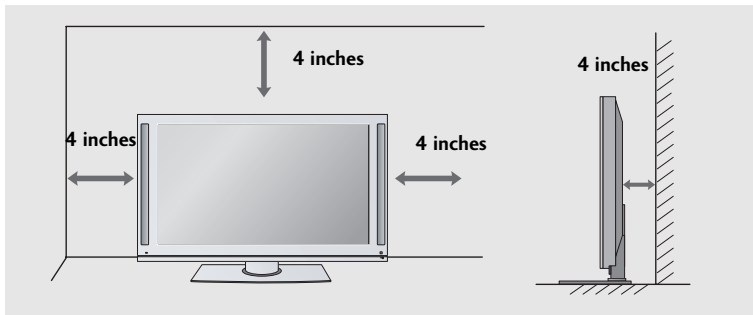

Wall Mount: Horizontal installation

For proper ventilation, allow a clearance of 4" on each side and from the wall. Detailed installation instructions are available from your dealer, see the optional Tilt Wall Mounting Bracket Installation and Setup Guide.

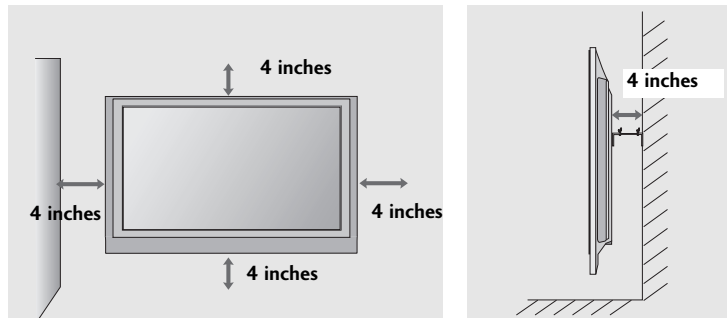

ANTENNA OR CABLE CONNECTION

Wall Antenna Socket or Outdoor Antenna without a Cable Box Connections.
For optimum picture quality, adjust antenna direction if needed.

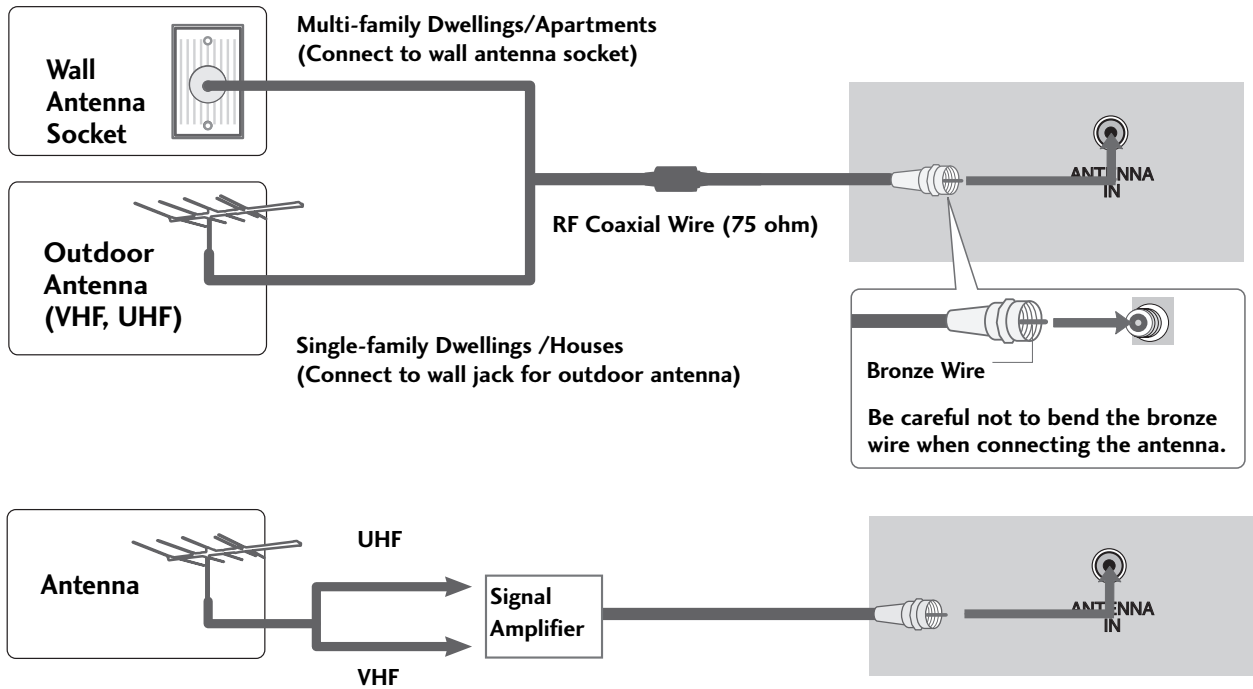

- To improve the picture quality in a poor signal area, please purchase a signal amplifier and install properly.
- If the antenna needs to be split for two TV's, install a 2-Way Signal Splitter.
- If the antenna is not installed properly, contact your dealer for assistance.

NOTE

- ▶ The TV will let you know when the analog and cable scans are complete.

EXTERNAL EQUIPMENT SETUP

HD RECEIVER SETUP

When connecting with a component cable

1. How to connect

- 1 Connect the video outputs (Y, PB, PR) of the digital set top box to the **COMPONENT IN VIDEO 1** jacks on the set. Match the jack colors (Y = green, PB = blue, and PR = red).
- 2 Connect the audio output of the digital set-top box to the **COMPONENT IN AUDIO 1** jacks on the set.

2. How to use

- Turn on the digital set-top box.
(Refer to the owner's manual for the digital set-top box.)
- Select **Component 1** input source with using the **INPUT** button on the remote control.
- If connected to **COMPONENT IN 2** input, select **Component 2** input source.

Signal	Component 1/2	HDMI1/DVI, HDMI2
480i	Yes	No
480p/720p	Yes	Yes
1080i/1080p	Yes	Yes

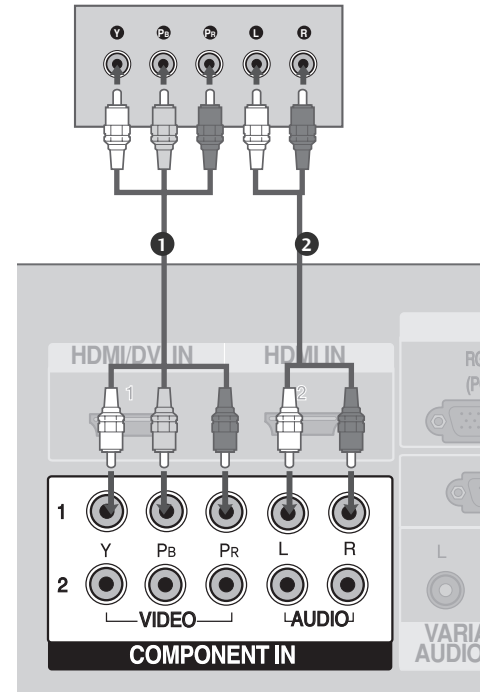

When connecting with a HDMI cable

1. How to connect

- 1 Connect the digital set-top box to **HDMI/DVI IN 1** or **2** jack on the set.
- 2 No separated audio connection is necessary.

2. How to use

- Turn on the digital set-top box.
(Refer to the owner's manual for the digital set-top box.)
- Select **HDMI1/DVI** or **HDMI2** input source with using the **INPUT** button on the remote control.

! NOTE

- ▶ If the digital set-top box supports Auto HDMI function, the output resolution of the source device will be automatically set to 1280x720p.
- ▶ If the digital set-top box player does not support Auto HDMI, you need to set the output resolution appropriately.
To get the best picture quality, adjust the output resolution of the source device to 1920x1080i/1080p.

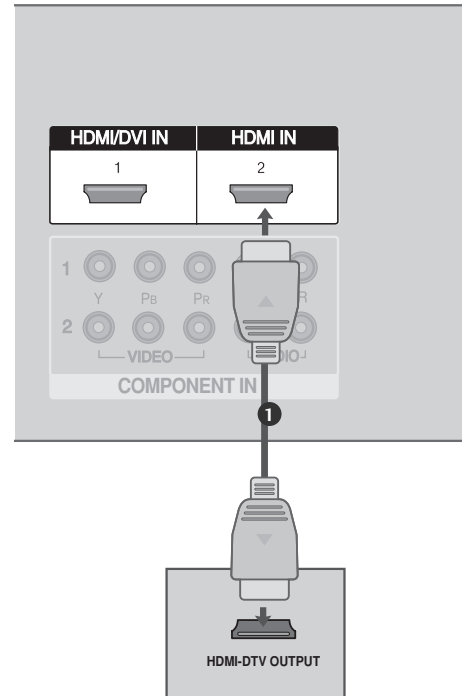

When connecting with a HDMI to DVI cable

1. How to connect

- 1 Connect the DVI output of the digital set-top box to the **HDMI/DVI IN 1** jack on the set.
- 2 Connect the audio output of the digital set-top box to the **AUDIO(RGB/DVI)** jack on the set.

2. How to use

- Turn on the digital set-top box. (Refer to the owner's manual for the digital set-top box.)
- Select **HDMI1/DVI** input source with using the **INPUT** button on the remote control.

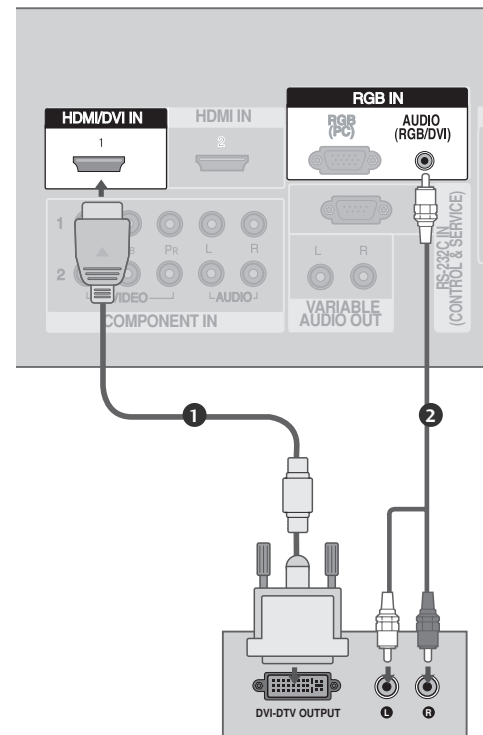

EXTERNAL EQUIPMENT SETUP

DVD SETUP

When connecting with a component cable

1. How to connect

- 1** Connect the video outputs (Y, PB, PR) of the DVD to the **COMPONENT IN VIDEO1** jacks on the set.
 Match the jack colors
 (Y = green, PB = blue, and PR = red).

- 2** Connect the audio outputs of the DVD to the **COMPONENT IN AUDIO1** jacks on the set.

2. How to use

- Turn on the DVD player, insert a DVD.
- Select **Component 1** input source with using the **INPUT** button on the remote control.
- If connected to **COMPONENT IN 2** input, select **Component 2** input source.
- Refer to the DVD player's manual for operating instructions.

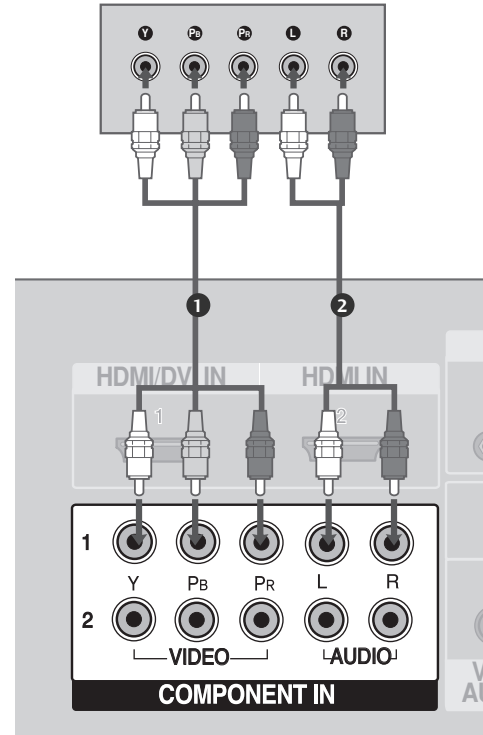

Component Input ports

To get better picture quality, connect a DVD player to the component input ports as shown below.

Component ports on the TV	Y	P _B	P _R
Video output ports on DVD player	Y	P _B	P _R
	Y	B-Y	R-Y
	Y	C _b	C _r
	Y	P _b	P _r

When connecting with an S-Video cable

1. How to connect

- 1 Connect the S-VIDEO output of the DVD to the S-VIDEO input on the set.
- 2 Connect the audio outputs of the DVD to the **AUDIO** input jacks on the set.

2. How to use

- Turn on the DVD player, insert a DVD.
- Select **AV1** input source with using the **INPUT** button on the remote control.
- If connected to **AV IN2**, select **AV2** input source.
- Refer to the DVD player's manual for operating instructions.

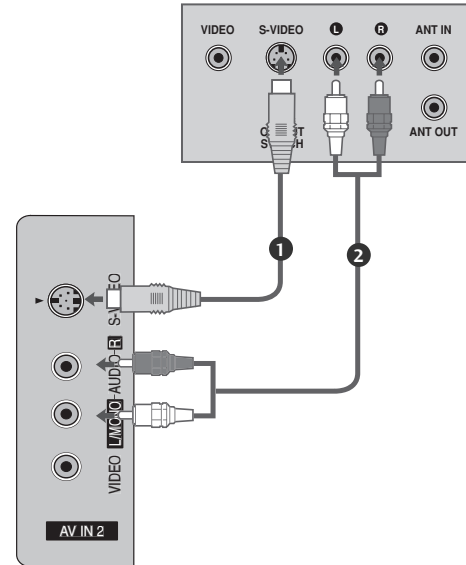

When connecting HDMI cable

1. How to connect

- 1 Connect the HDMI output of the DVD to the **HDMI/DVI IN 1** or **2** jack on the set.
- 2 No separated audio connection is necessary.

2. How to use

- Select **HDMI1/DVI** or **HDMI2** input source with using the **INPUT** button on the remote control.
- Refer to the DVD player's manual for operating instructions.

! NOTE

- ▶ If the DVD supports Auto HDMI function, the DVD output resolution will be automatically set to 1280x720p.
- ▶ If the DVD does not support Auto HDMI, you need to set the output resolution appropriately.
To get the best picture quality, adjust the output resolution of the DVD to 1920x1080i/1080p.

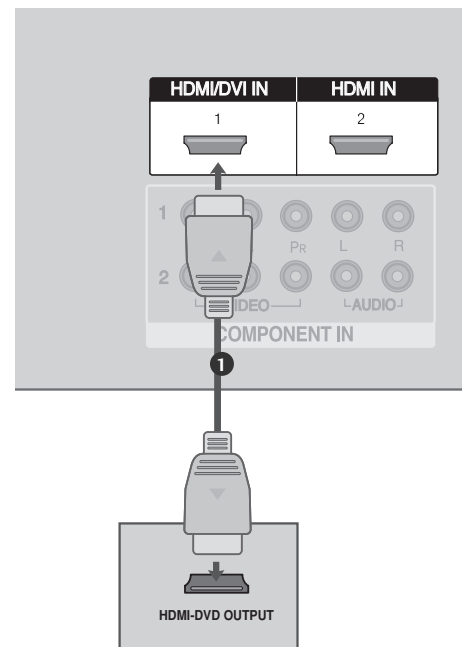

EXTERNAL EQUIPMENT SETUP

VCR SETUP

- To avoid picture noise (interference), leave an adequate distance between the VCR and TV.
- If the 4:3 picture format is used; the fixed images on the sides of the screen may remain visible on the screen. This phenomenon is common to all manufactures and in consequence the manufactures warranty does not cover the product bearing this phenomenon.

When connecting with an antenna

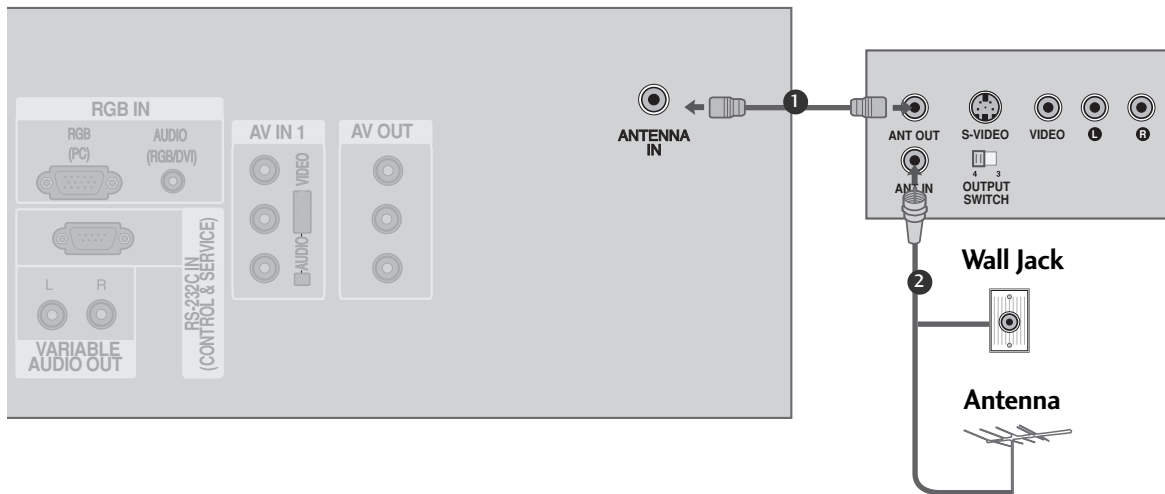

1. How to connect

- 1 Connect the RF antenna out socket of the VCR to the **Antenna** socket on the set.
- 2 Connect the antenna cable to the RF antenna in socket of the VCR.

2. How to use

- Set VCR output switch to 3 or 4 and then tune TV to the same channel number.
- Insert a video tape into the VCR and press PLAY on the VCR. (Refer to the VCR owner's manual.)

When connecting with a RCA cable

1. How to connect

- 1 Connect the **AUDIO/VIDEO** jacks between TV and VCR. Match the jack colors (Video = yellow, Audio Left = white, and Audio Right = red)

2. How to use

- Insert a video tape into the VCR and press **PLAY** on the VCR. (Refer to the VCR owner's manual.)
- Select **AV1** input source with using the **INPUT** button on the remote control.
- If connected to **AV IN2**, select **AV2** input source.

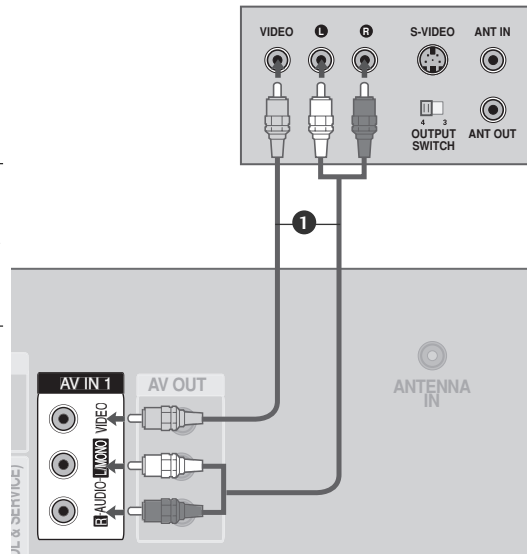

! NOTE

- ▶ If you have a mono VCR, connect the audio cable from the VCR to the **AUDIO L/MONO** jack of the set.

When connecting with an S-Video cable

1. How to connect

- 1 Connect the **S-VIDEO** output of the VCR to the **S-VIDEO** input on the set.
- 2 Connect the audio outputs of the VCR to the **AUDIO** input jacks on the set.

2. How to use

- Insert a video tape into the VCR and press **PLAY** on the VCR. (Refer to the VCR owner's manual.)
- Select **AV1** input source with using the **INPUT** button on the remote control.
- If connected to **AV IN2**, select **AV2** input source.

! NOTE

- ▶ The picture quality is improved: compared to normal composite (RCA cable) input.

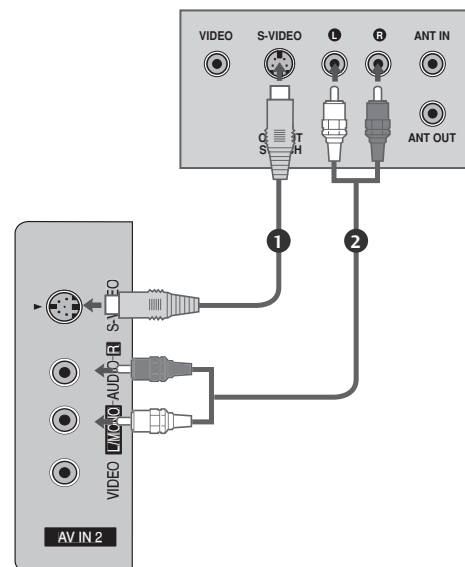

! CAUTION

- ▶ Do not connect to both Video and S-Video at the same time. In the event that you connect both Video and the S-Video cables, only the S-Video will work.

EXTERNAL EQUIPMENT SETUP

OTHER A/V SOURCE SETUP

1. How to connect

- 1 Connect the **AUDIO/VIDEO** jacks between TV and external equipment. Match the jack colors. (Video = yellow, Audio Left = white, and Audio Right = red)

2. How to use

- Select **AV1** input source with using the **INPUT** button on the remote control.
- If connected to **AV IN2** input, select **AV2** input source.
- Operate the corresponding external equipment.

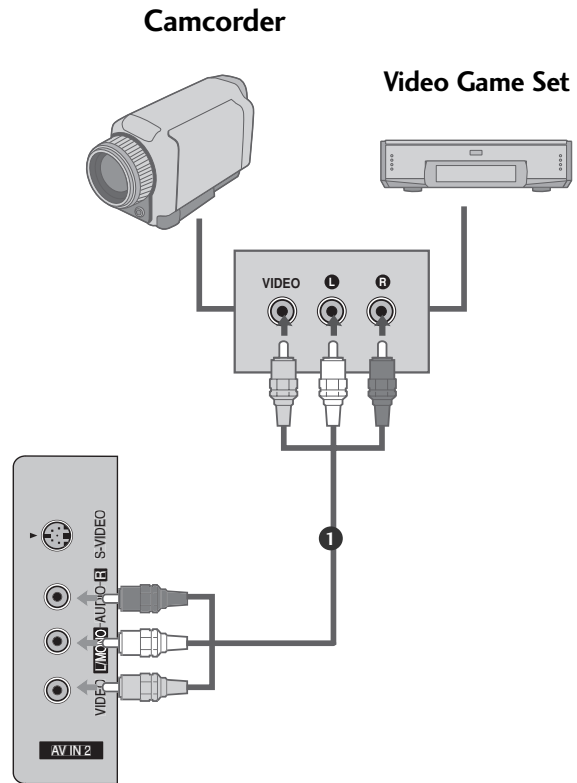

PC SETUP

This TV provides Plug and Play capability, meaning that the PC adjusts automatically to the TV's settings.

When connecting with a D-sub 15 pin cable

1. How to connect

- 1 Connect the RGB output of the PC to the **RGB(PC)** jack on the set.
- 2 Connect the PC audio output to the **AUDIO (RGB/DVI)** jack on the set.

2. How to use

- Turn on the PC and the set.
- Select **RGB-PC** input source with using the **INPUT** button on the remote control.

! NOTE

- ▶ Check the image on your TV. There may be noise associated with the resolution, vertical pattern, contrast or brightness in PC mode. If noise is present, change the PC output to another resolution, change the refresh rate to another rate or adjust the brightness and contrast on the **VIDEO** menu until the picture is clear. If the refresh rate of the PC graphic card can not be changed, change the PC graphic card or consult the manufacturer of the PC graphic card.

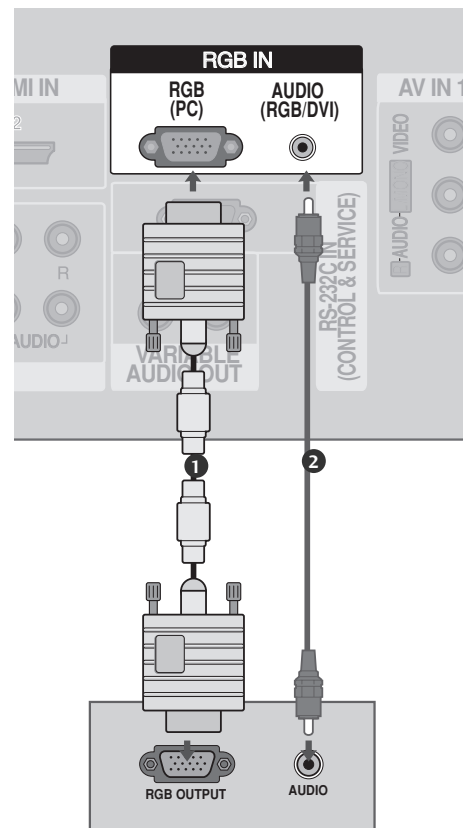

EXTERNAL EQUIPMENT SETUP

When connecting HDMI to DVI cable

1. How to connect

- 1 Connect the DVI output of the PC to the **HDMI/DVI IN 1** jack on the set.
- 2 Connect the PC audio output to the **AUDIO (RGB/DVI)** jack on the set.

2. How to use

- Turn on the PC and the set
- Select **HDMI1/DVI** input source with using the **INPUT** button on the remote control.

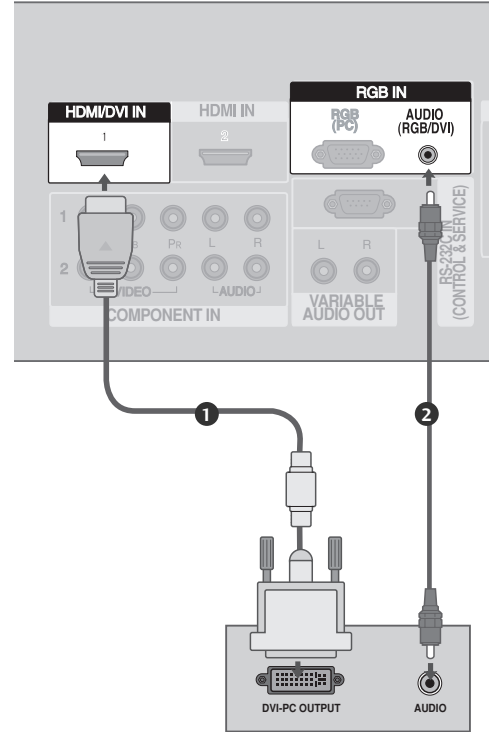

! NOTE

- ▶ HDMI2 source does not support DVI source.
- ▶ If the PC has a DVI output and no HDMI output, a separated audio connection is necessary.

Supported Display Resolution (RGB[PC]/HDMI[PC] mode)

Resolution	Horizontal Frequency(KHz)	Vertical Frequency(Hz)
720x400	31.469	70.080
640x480	31.469	59.940
800x600	37.879	60.310
1024x768	48.363	60.000
1360x768	47.720	59.799
1280x1024	63.668	59.895
1400x1050	65.317	59.978
1600x1200	74.537	59.869
1920x1080	66.587	59.934

! NOTE

- ▶ To get the best picture quality, adjust the PC graphics card to 1920x1080, 60Hz.
- ▶ Depending on the graphics card, DOS mode may not work if a HDMI to DVI Cable is in use.
- ▶ When Source Devices connected with HDMI Input, output TV SET Resolution (480p, 720p, 1080i) and TV SET Display fit EIA/CEA-861-B Specification to Screen. If not, refer to the Manual of HDMI Source Devices or contact your service center.
- ▶ If the HDMI Source Device is not connected to the Cable or if there is a poor cable connection, "No signal" is displayed in the HDMI Input. In this case, that Video Resolution is not supported.
- ▶ Avoid keeping a fixed image on the screen for a long period of time. The fixed image may become permanently imprinted on the screen.
- ▶ The synchronization input form for Horizontal and Vertical frequencies is separate.
- ▶ When you use too long RGB-PC cable, there might be a noise on the screen. We recommend using under 5m of the cable. It provides the best picture quality.

EXTERNAL EQUIPMENT SETUP

SCREEN SETUP FOR PC MODE

Auto Configure (RGB [PC] mode only)

Automatically adjusts picture position and minimizes image shaking.

Although the image is still not correct, your set is functioning properly but needs further adjustment.

Auto configure

This function is for the automatic adjustment of the screen position, clock, and phase. The displayed image will be unstable for a few seconds while the auto configuration is in progress.

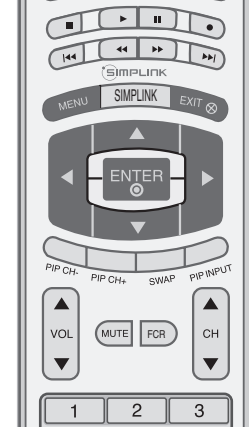

- 1 Press the **MENU** button and then use **▲ / ▼** button to select the **PICTURE** menu.
- 2 Press the **▶** button and then use **▲ / ▼** button to select **Screen**.
- 3 Press the **▶** button and then use **▲ / ▼** button to select **Auto config.**.
- 4 Press the **▶** button to start **Auto config.**
 - When **Auto config.** has finished, **OK** will be shown on screen.
 - If the position of the image is still not correct, try **Auto adjustment** again.
- 5 If picture needs to be adjusted more after **Auto adjustment** in **RGB (PC)**, you can adjust the **Manual config.**.
- 6 Press the **EXIT** button to return to TV viewing or press the **MENU** button to return to the previous menu.

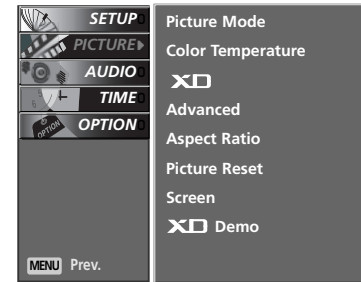

1

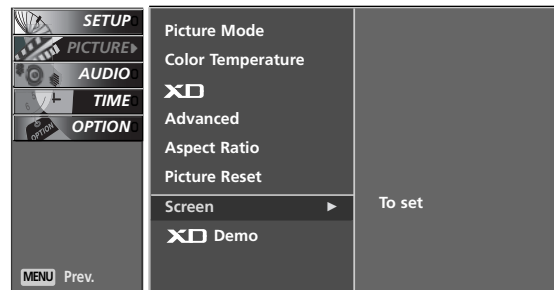

2

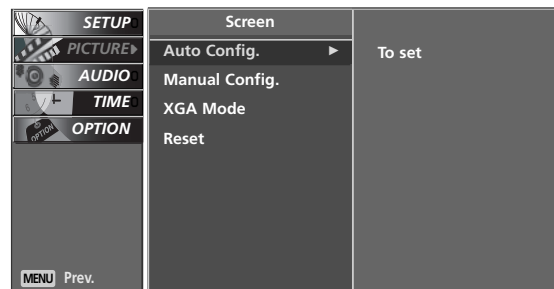

3 4

Adjustment for screen Phase, Clock, Position

If the picture isn't clear after auto adjustment and especially if characters are still trembling, adjust the picture phase manually.

To correct the screen size, adjust Clock.

This function works in the following mode : RGB[PC], COMPONENT (480i/480p/720p/1080i/1080p), HDMI (480p/720p/1080i/1080p).

It's not available to use Phase, Clock function in COMPONENT (480i/480p/720p/1080i/1080p), HDMI (480p/720p/1080i/1080p).

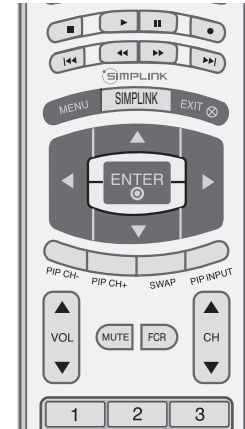

Clock This function is to minimize any vertical bars or stripes visible on the screen background. And the horizontal screen size will also change.

Phase This function allows you to remove any horizontal noise and clear or sharpen the image of characters.

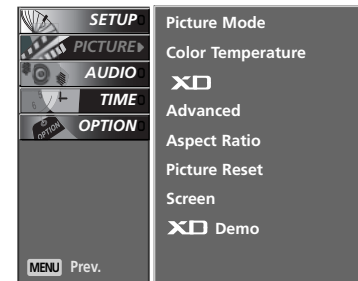

1

- 1 Press the **MENU** button and then use ▲ / ▼ button to select the **PICTURE** menu.
- 2 Press the ► button and then use ▲ / ▼ button to select **Screen**.
- 3 Press the ► button and then use ▲ / ▼ button to select **Manual config.**
- 4 Press the ► button and then use ▲ / ▼ button to select **Phase, Clock, H-position or V-position**.
- 5 Press the ◀ / ▶ button to make appropriate adjustments.
- 6 Press the **EXIT** button to return to TV viewing or press the **MENU** button to return to the previous menu.

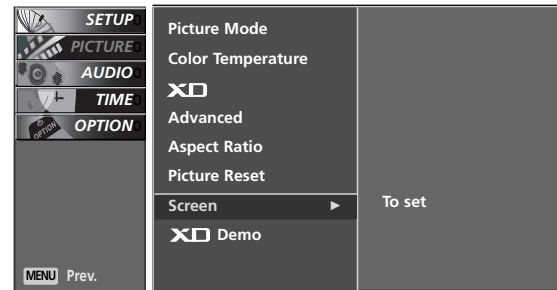

2

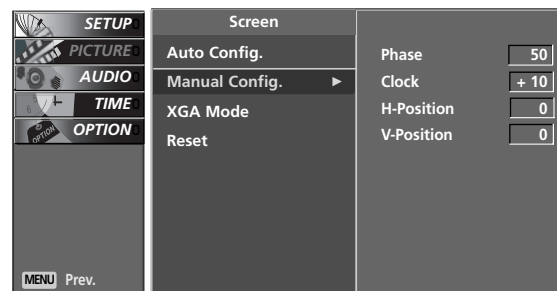

3 4

EXTERNAL EQUIPMENT SETUP

Selecting Wide XGA/UXGA mode

To see a normal picture, match the resolution of RGB mode and selection of XGA/UXGA mode.

This function works in the following mode: RGB[PC] mode.

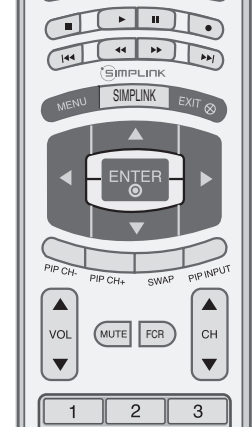

- 1 Press the **MENU** button and then use **▲ / ▼** button to select the **PICTURE** menu.

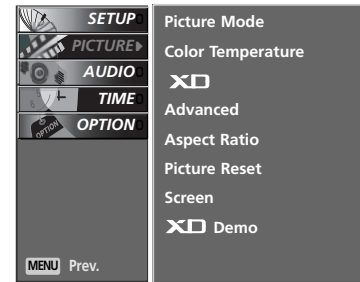

1

- 2 Press the **▶** button and then use **▲ / ▼** button to select **Screen**.

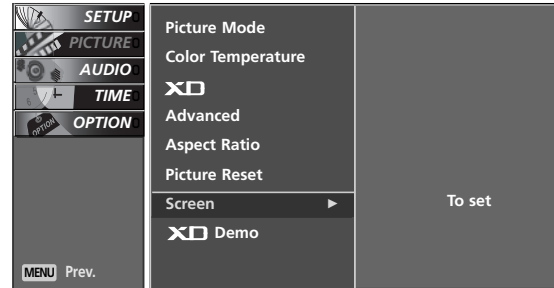

2

- 3 Press the **▶** button and then use **▲ / ▼** button to select **XGA Mode (or UXGA Mode)**.

- 4 Press the **▶** button and then use **▲ / ▼** button to select the desired **XGA/UXGA resolution**.

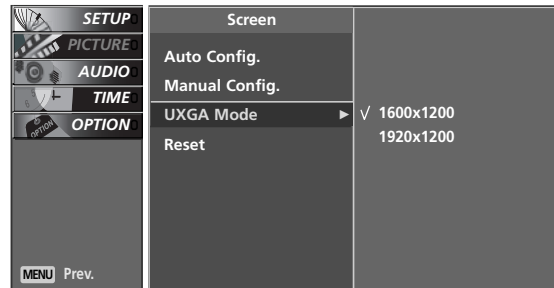

3 4

- 5 Press the **EXIT** button to return to TV viewing or press the **MENU** button to return to the previous menu.

Initializing (Reset to original factory settings)

This function operates in current mode.
To initialize the adjusted value.

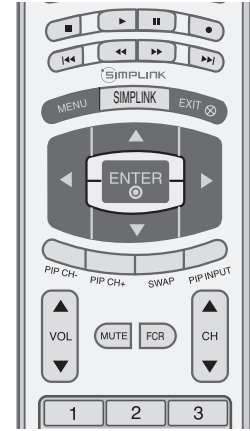

- 1 Press the **MENU** button and then use ▲ / ▼ button to select the **PICTURE** menu.
- 2 Press the ► button and then use ▲ / ▼ button to select **Screen**.
- 3 Press the ► button and then use ▲ / ▼ button to select **Reset**.
- 4 Press the ► button.

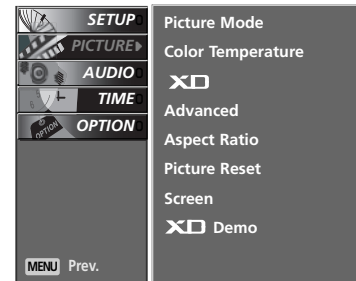

1

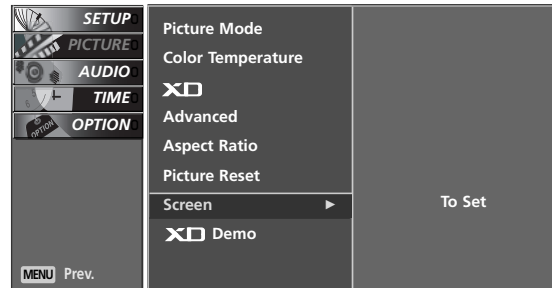

2

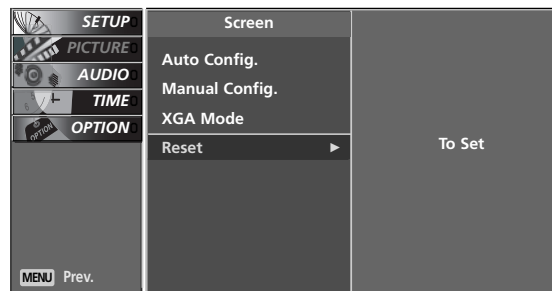

3 4

EXTERNAL EQUIPMENT SETUP

AV OUT SETUP

The TV has a special signal output capability which allows you to hook up the second TV or monitor.

1. How to connect

- 1 Connect the second TV or monitor to the TV's **AV OUT** jacks.
- 2 See the Operating Manual of the second TV or monitor for further details regarding that device's input settings.

! NOTE

- ▶ Component, RGB, HDMI input sources cannot be used for AV out.
- ▶ We recommend to use the AV OUT jacks for VCR recording.

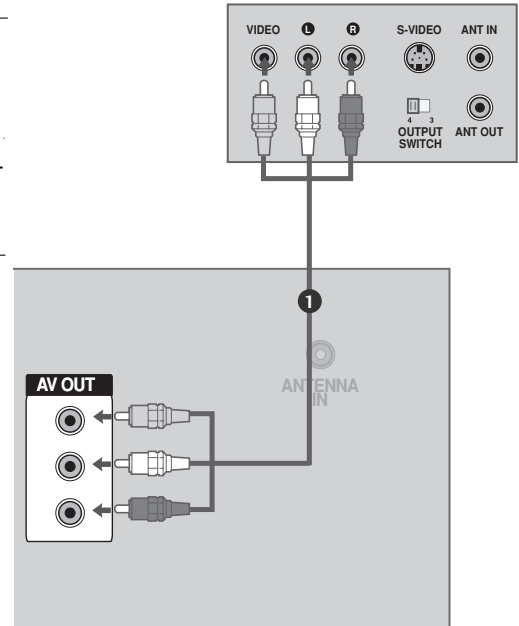

EXTERNAL STEREO

Use to connected either an external amplifier, or add a sub-woofer to your surround sound system.

1. How to connect

- 1 Connect the input jack of the stereos amplifier to the **VARIABLE AUDIO OUT** jacks on the set.
- 2 Set up your speakers through your analog stereo amplifier, according to the instructions provided with the amplifier.

! NOTE

- ▶ When connecting with external audio equipments, such as amplifiers or speakers, please turn the TV speakers off. (▶ p.61)

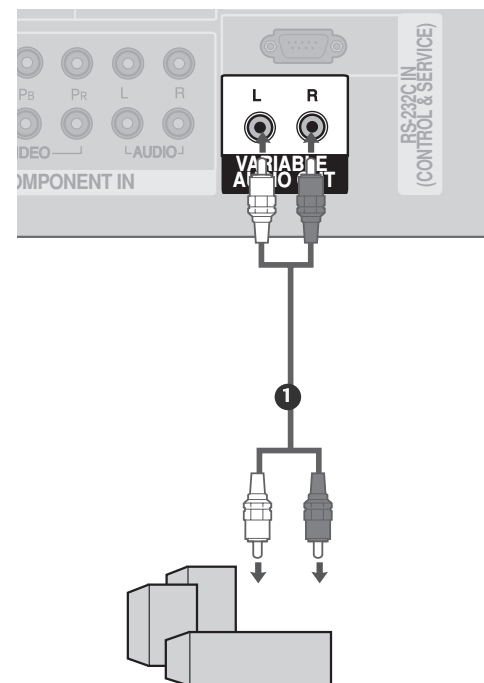

WATCHING TV /SETUP CONTROL

TURNING ON THE TV

If your TV will be turned on, you will be able to use its features.

Turning on the TV

- 1 First, connect power cord correctly.
At this moment, the TV switches to standby mode.
 - In standby mode to turn TV on, press the O/I , **INPUT**, **CH \blacktriangle / \blacktriangledown** button on the TV or press the **POWER**, **TV**, **INPUT**, **CH \blacktriangle / \blacktriangledown** , **Number(0~9)** button on the remote control and then the TV will switch on.

Volume Adjustment

- 1 Press the **VOL \blacktriangle / \blacktriangledown** button to adjust the volume.
- 2 If you want to switch the sound off, press the **MUTE** button.
- 3 You can cancel this function by pressing the **MUTE**, **VOL \blacktriangle / \blacktriangledown** or **MTS** button.

Channel Adjustment

- 1 Press the **CH \blacktriangle / \blacktriangledown** or **NUMBER** button to select a channel number.



! NOTE

- ▶ If you intend to be away on vacation, disconnect the power plug from wall power outlet.

WATCHING TV /SETUP CONTROL

REMOTE CONTROL FUNCTIONS

When using the remote control, aim it at the remote control sensor on the TV.

- MODE** Select the remote operating mode: TV, DVD, VCR, AUDIO, CABLE, STB
- VCR/DVD control buttons** Controls some video cassette recorders or DVD players when you have already selected DVD or VCR mode button.
- MENU** Selects a menu.
- SIMPLINK** See a list of AV devices connected to TV. When you toggle this button, the Simplink menu appears at the screen. (▶ p.39)
- EXIT** Clears all on-screen displays and returns to TV viewing from any menu.
- THUMBSTICK** Allows you to navigate the on-screen menus and adjust the system settings to your preference. (Up/Down/Left Right/ENTER)
- PIP CH - /+** Selects a program for the sub picture.
- SWAP** Exchanges the main/sub images in PIP/DW mode.
- PIP INPUT** Selects the input source for the sub picture in PIP/Twin picture mode.
- VOLUME UP /DOWN** Increases/decreases the sound level.
- MUTE** Switches the sound on or off.
- FCR** Selects a favorite channel.
- CHANNEL UP/DOWN** Selects a channels.
- NUMBER button** Selects a channels. Selects numbered items in a menu.
- RATIO** Selects your desired picture format.
- REVIEW** Returns to the previously viewed channel.

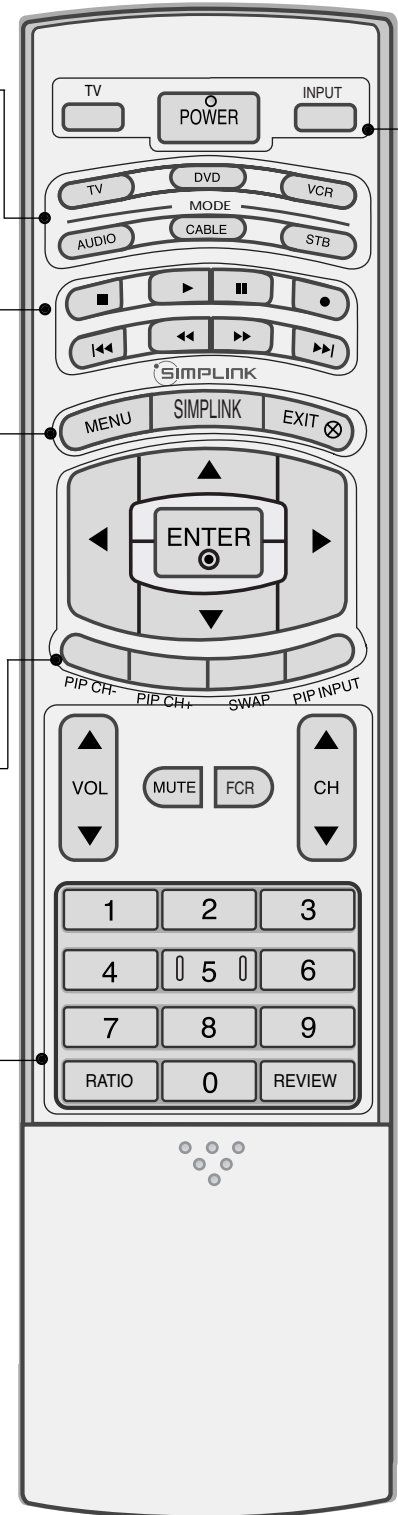

TV Returns to the TV mode.

POWER Turns your TV or any other programmed equipment on or off, depending on mode.

INPUT If you press the button once, the input source OSD will appear on screen as shown.
Press the ▲ / ▼ button and then ENTER button to select the desired input source (TV, AV1, AV2, Component1/2, RGB, HDMI1/DVI or HDMI2).

Inside the Sliding Cover

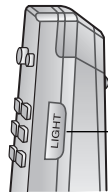
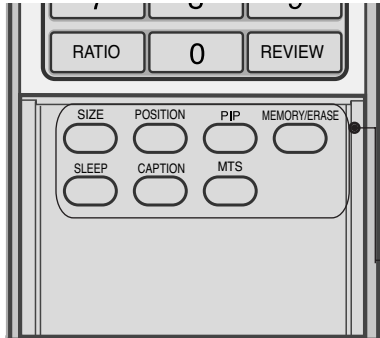

SIZE Adjusts the sub picture size.

POSITION Moves the sub picture.

PIP Switches the sub picture PIP, DW mode.

MEMORY/ERASE Memorizes or erases selected channel.

SLEEP Sets the sleep timer.

CAPTION Selects CAPTION mode.

MTS Selects the MTS sound: **Mono, Stereo,** or **SAP.**

LIGHT (option) Illuminates the remote control buttons of selected mode.

Installing Batteries

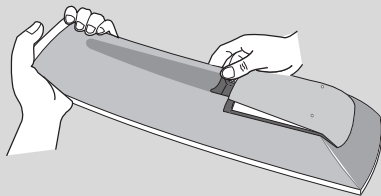

- Open the battery compartment cover on the back side and install the batteries matching correct polarity (+with +,-with -).
- Install two 1.5V AA batteries. Don't mix old or used batteries with new ones.
- Close cover.

Remote control effective range

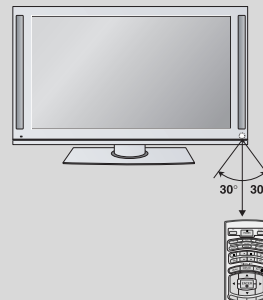

- Use a remote control up to 7 meters distance and 30 degree (left/right) within the receiving unit scope.
- Dispose of used batteries in a recycle bin to preserve environment.

WATCHING TV /SETUP CONTROL

ON SCREEN MENUS SELECTION AND ADJUSTMENT

Your TV's OSD (On Screen Display) may differ slightly from what is shown in this manual.

- 1 Press the **MENU** button and then use **▲** or **▼** button to select the each menu.

- 2 Press the **▶** button and then use **▲ ▼ ◀ ▶** button to display the available menus.

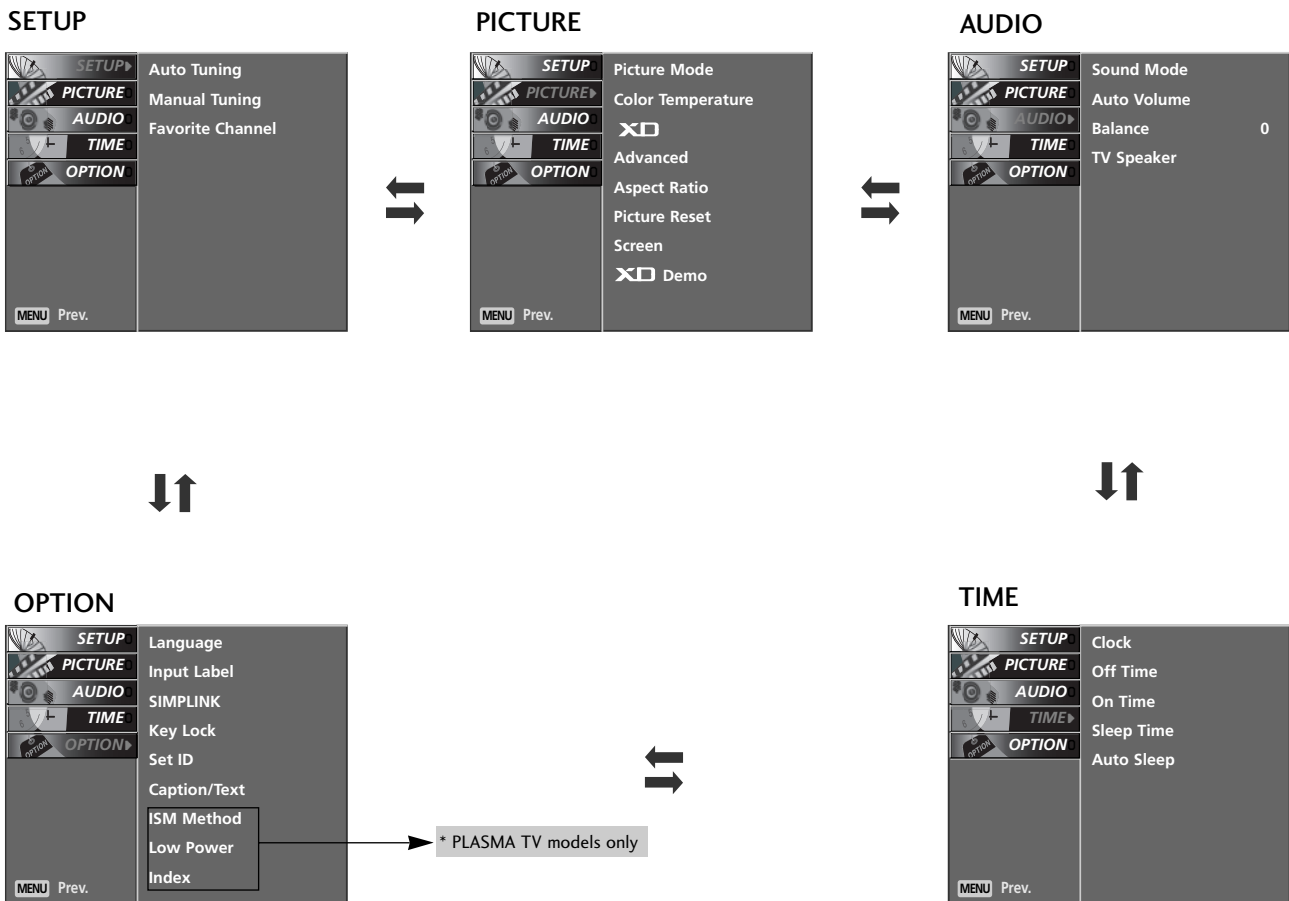

CHANNEL SETUP

AUTO TUNING: CHANNEL SEARCH

Auto Tuning should be used to memorize all the active channels in your area before you are able to use the TV.

There are two ways of storing channels in the TV's memory. You can use either.

One is called **AUTO TUNING** and the other is called **MANUAL TUNING**.

In **AUTO TUNING** mode, the TV will memorize the channels in ascending numerical order. If there are additional channels you want to add or delete, you can manually add or delete those channels with **Manual Tuning**.

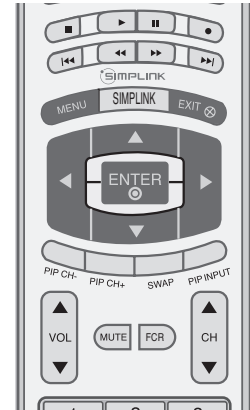

- Redo Auto Tuning if the TV is ever moved to another location.
- Auto Tuning will search for channels only through the Antenna jack.

1 Press the **MENU** button and then use **▲** or **▼** button to select the **SETUP** menu.

2 Press the **▶** button and then use **▲** or **▼** button to select **Auto Tuning**.

3 Press the **▶** button. **Auto Tuning** starts the channel search.

4 If you want to stop auto programming, press the **ENTER** button.
Only the channels found up to at that time are memorized.

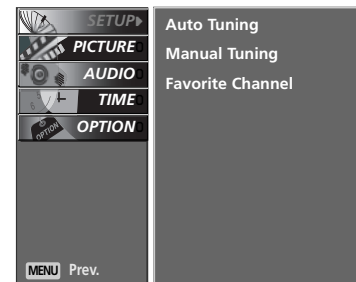

1

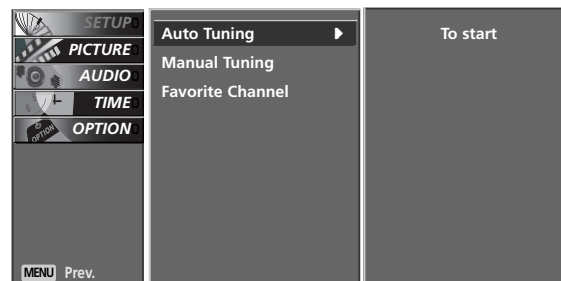

2 3

WATCHING TV /SETUP CONTROL

MANUAL TUNING : ADDING/DELETING CHANNELS

You can add or delete channels from the channel scan manually.

- 1 Use the **CH▲/▼** or **NUMBER** buttons to select the channel number you want to add or delete.
- 2 Press the **MEMORY/ERASE** button.
- 3 Press the **MEMORY/ERASE** button to select **Memory** or **Erase**.
- 4 Press the **ENTER** button.



- You can also use the **SETUP** menu to adjust **Manual Tuning**.

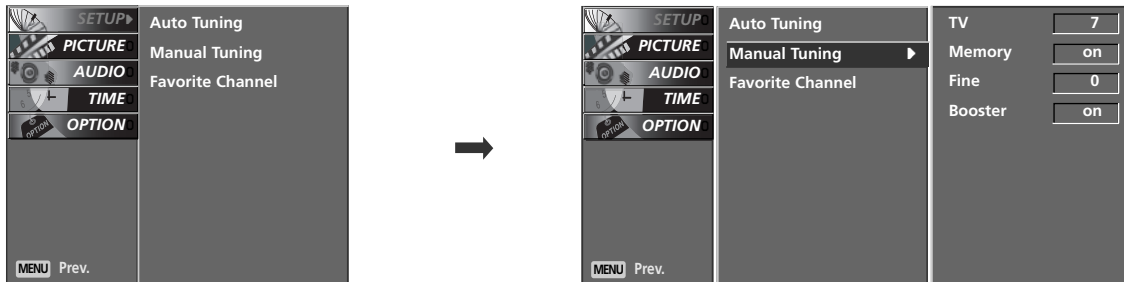



This operates only for the devices with the  logo.

Please check the  logo.

This allows you to control and play other AV devices connected to the display through HDMI cable without additional cables and settings.

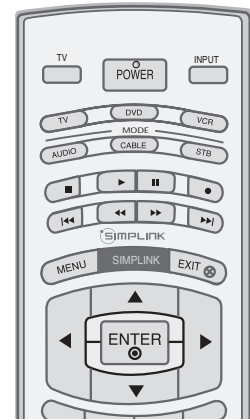

1 Press the **MENU** button and then use **▲** or **▼** button to select the **OPTION** menu.

2 Press the **▶** button and then use **▲** or **▼** button to select **SIMPLINK**.

3 Press the **▶** button and then use **▲** or **▼** button to select **On** or **Off**.

4 Press the **EXIT** button to return to TV viewing or press the **MENU** button to return to the previous menu.



1

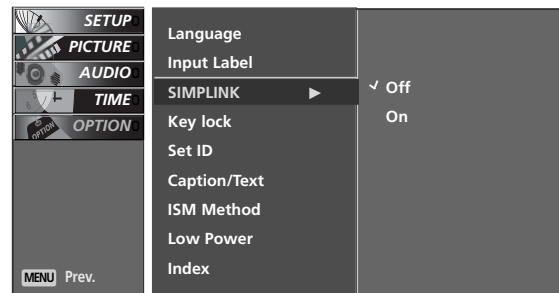

2 3

! NOTE

- ▶ Connect the HDMI/DVI IN 1 or 2 terminal of the TV to the rear terminal (HDMI output) of the Simplink device with the HDMI cable.
- ▶ After connecting the HDMI terminal for the home theater with simplink function in the above method, connect the VARIABLE AUDIO OUT terminal on the back of the TV to the VARIABLE AUDIO IN terminal on the back of the simplink device with the VARIABLE AUDIO OUT cable.
- ▶ When operating the external device with Simplink, press the TV button among the MODE button on the remote control.
- ▶ When you switch the Input source with the INPUT button on the remote control, you can stop the operation of device worked by Simplink.
- ▶ When you select or operate the media device with home theater function, the speaker automatically switches to home theater speaker (HT speaker).

WATCHING TV /SETUP CONTROL

WATCHING TV / SETUP CONTROL

SIMPLINK Functions























Direct Play

After connecting AV devices to TV, you can directly control the devices and play media without additional settings.

Select AV device

Enables you to select one of AV devices connected to TV and play it.

Disc playback

Control connected AV devices by pressing the , , , , , , , , , , , , , , , , , , , **ENTER** buttons and buttons , , , , **ENTER** buttons and buttons for play, stop, pause, fast reverse, fast forward, chapter skip.

Power off all devices

When you power off TV, all connected devices are turned off.

Switch audio-out

Offers an easy way to switch audio-out.

(A device, which is connected to TV through HDMI cable but does not support Simplink, does not provide this function)

Note: To operate SIMPLINK, the HDMI cable over 1.2 version with *CEC function should be used. (*CEC: Consumer Electronics Control)
Version 1.2 is the cable connected to No. 13 Pin and is the line to exchange information between units.

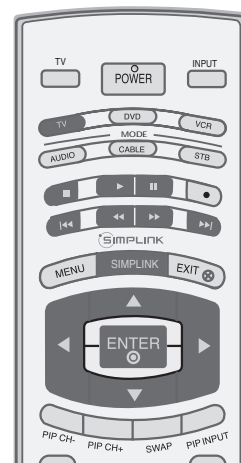

SIMPLINK Menu

- 1 **TV viewing** : Switch to the previous TV channel regardless of the current mode.
- 2 **DISC playback** : Select and play discs. When multiple discs are available, the titles of the discs are conveniently displayed at the bottom of the screen.
- 3 **VCR playback** : Play and control the connected VCR.
- 4 **HDD Recordings playback** : Play and control recordings stored in HDD.
- 5 **Audio Out to HT speaker/Audio Out to TV** : Select HT speaker or TV speaker for Audio Out.



- ▶ Selected Device
- ▶ When no device is connected (displayed in gray)
- ▶ When a device is connected (displayed in bright color)

INPUT LABEL

This function is to set the connection between the device and the source.

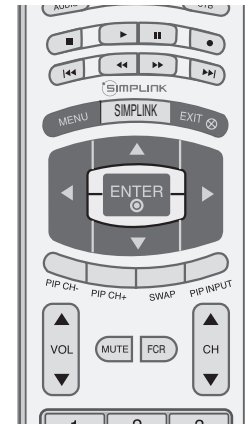

1 Press the **MENU** button and then use ▲ or ▼ button to select the **OPTION** menu.

2 Press the ► button and then use ▲ or ▼ button to select **Input Label**.

3 Press the ► button and then use ▲ or ▼ button to select the source: AV1, AV2, Component1, Component2, RGB, HDMI1/DVI or HDMI2.

4 Press the ► button and then use ▲ or ▼ button to select the label.

5 Press the **EXIT** button to return to TV viewing or press the **MENU** button to return to the previous menu.



1 2

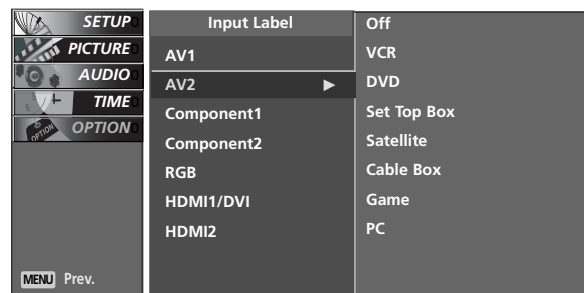

3 4

WATCHING TV /SETUP CONTROL

FINE TUNING ADJUSTMENT

Normally fine tuning is only necessary if reception is poor.

To remove fine tuning from a channel, reprogram the finely-tuned channel with Auto program or Manual Program.

If a finely-tuned channel is memorized, the color of the channel number changes to yellow.

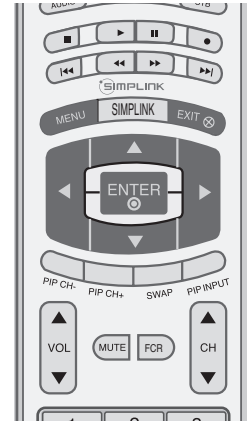

1 Press the **MENU** button and then use **▲** or **▼** button to select the **SETUP** menu.

2 Press the **▶** button and then use **▲** or **▼** button to select **Manual Tuning**.

3 Press the **▶** button and then use **▲** or **▼** button to select **Fine**.

4 Press the **◀** or **▶** button to adjust the picture to your preference.

5 Press the **ENTER** button to store it.

6 Press the **EXIT** button to return to TV viewing or press the **MENU** button to return to the previous menu.

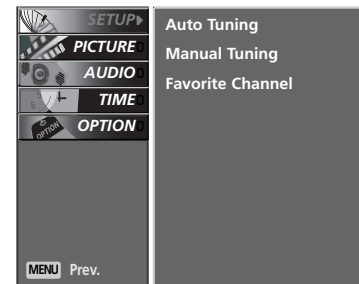

1

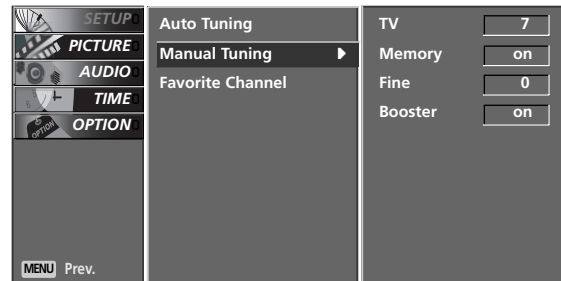

2

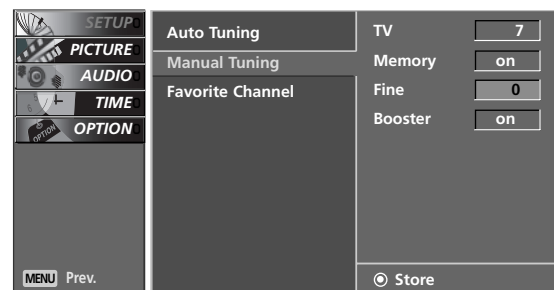

3 4

BOOSTER

If the reception is poor at the fringe area of TV signal, select **Booster** to on.

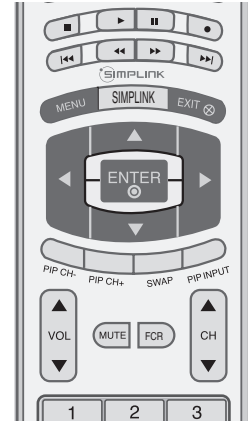

1 Press the **MENU** button and then use ▲ or ▼ button to select the **SETUP** menu.

2 Press the ► button and then use ▲ or ▼ button to select **Manual program**.

3 Press the ► button and then use ▲ or ▼ button to select **Booster**.

4 Press the ◀ or ▶ button to select **On** or **Off**.

5 Press the **ENTER** button to store it.

6 Press the **EXIT** button to return to TV viewing or press the **MENU** button to return to the previous menu.

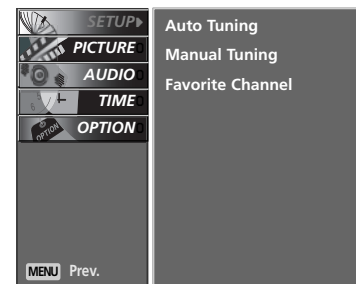

1

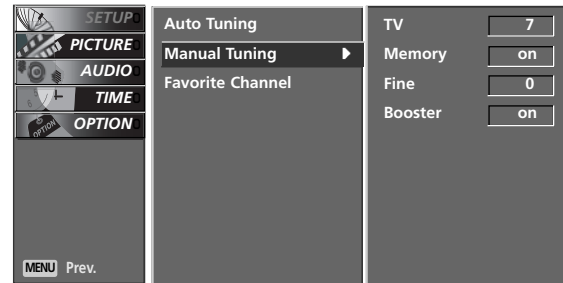

2



3 4

WATCHING TV /SETUP CONTROL

FAVORITE CHANNELS SETUP

Favorite Channels is a convenient feature that lets you quickly scan up to 8 channels of your choice without having to wait for the TV to scan through all the in-between channels.

To tune to a favorite channel, press the **FCR** (Favorite Channel Review) button repeatedly. The 8 favorite channels appear on the screen in numerical order.

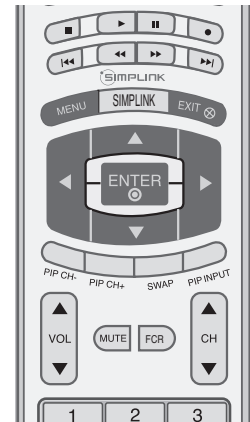

1 Press the **MENU** button and then use ▲ or ▼ button to select the **SETUP** menu.

2 Press the ► button and then use ▲ or ▼ button to select **Favorite Channel**.

3 Press the ► button and then use ▲ or ▼ button to select the first favorite program position.

4 Use the ◀ or ▶ button to set the desired channel number for first favorite program.

5 Press the **EXIT** button to return to normal TV viewing.

6 Repeat steps 3 to 5 to memorize other favorite programs.

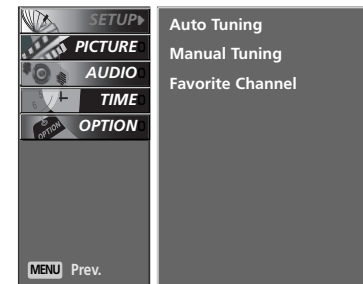

1

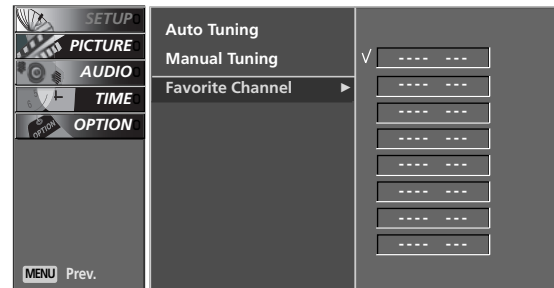

2 3 4 5

PICTURE CONTROL

PIP / DOUBLE WINDOW

PIP lets you view 2 different inputs (sources) on your TV screen at the same time. One source will be large, and the other source will show a smaller inset image. Double Window mode splits the screen into two images, allowing two picture sources to be shown on the TV screen at the same time. Each source is given half the screen.

Watching PIP/Double Window

Press the **PIP** button to access the sub picture. Each press of PIP changes the PIP options as shown below.

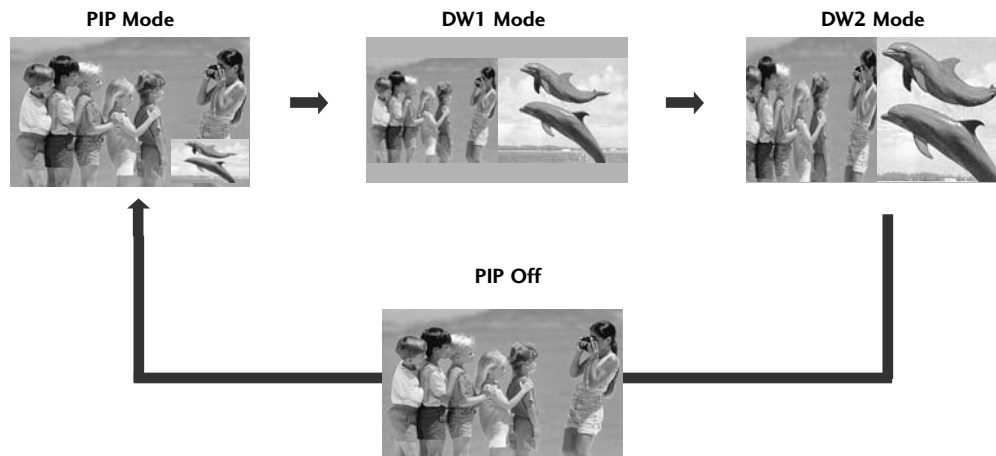

TV Program Selection for PIP

- 1 Use the **PIP CH +/-** button to select a channel for the sub picture. The selected channel number is displayed just below the input source of main picture.

PICTURE CONTROL

Selecting an Input Signal Source for the PIP/Double Window

Use the **PIP INPUT** button to select the input source for the sub picture.
Each press of **PIP INPUT** button changes the PIP source.

Main Picture Source	Available Sub Picture Sources
	PIP/DW
TV	All
AV1	All (Except AV1)
AV2	All (Except AV2)
Component1	All (Except Component1)
Component2	All (Except Component2)
RGB	All (Except RGB)
HDMI1/DVI	All (Except HDMI1/DVI, HDMI2)
HDMI2	All (Except HDMI1/DVI, HDMI2)

Sub Picture Size Adjustment (PIP mode only)

Press the **SIZE** button to adjust the sub picture size.

With **SIZE** button in PIP mode, sub picture is adjusted.

Moving the Sub Picture (PIP mode only)

Press the **POSITION** button.

Repeatedly press the **POSITION** button then sub picture moves.

Swapping the PIP/Double window

Repeatedly, use the **SWAP** button to switch the main and sub pictures.

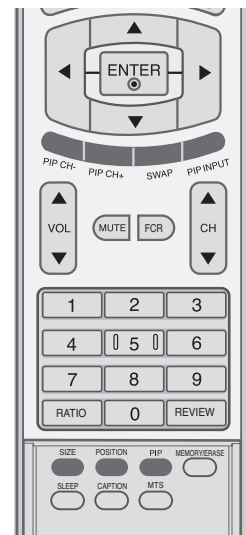

PICTURE MODE CONTROL

Picture Mode adjusts the TV for the best picture appearance. Select the preset value in the Picture Mode menu based on the program category.

Intelligent Eye (LCD TV models only), **Dynamic**, **Standard**, **Mild** Settings are preset for optimum picture quality at the factory and are not adjustable.

In the **User1** and **User2** modes only, you can directly adjust the contrast, brightness, color, sharpness, tint.

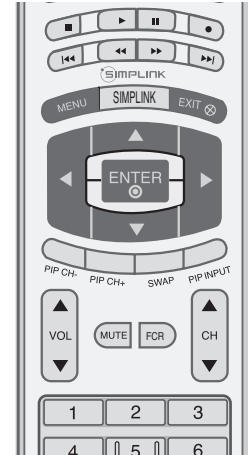

- 1 Press the **MENU** button and then use ▲ or ▼ button to select the **PICTURE** menu.
- 2 Press the ► button and then use ▲ or ▼ button to select **Picture Mode**.
- 3 Press the ► button and then use ▲ or ▼ button to select **Intelligent Eye** (LCD TV models only), **Dynamic**, **Standard**, **Mild**, **User1** or **User2**.
- 4 Press the **EXIT** button to return to TV viewing or press the **MENU** button to return to the previous menu.

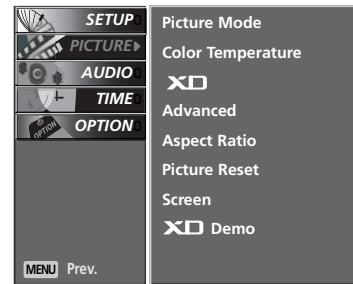

1

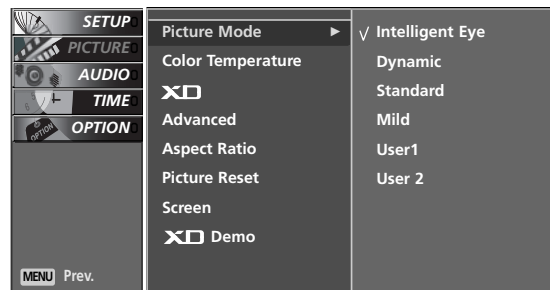

2 3

PICTURE CONTROL

MANUAL PICTURE CONTROL (PICTURE MODE-USER OPTION)

Adjust the picture appearance to suit your preference and viewing situations.

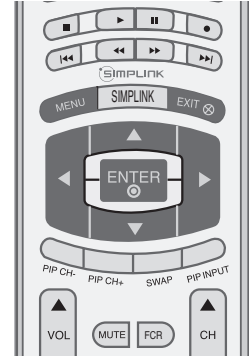

PICTURE CONTROL

1 Press the **MENU** button and then use **▲** or **▼** button to select the **PICTURE** menu.

2 Press the **▶** button and then use **▲** or **▼** button to select **Picture Mode**.

3 Press the **▶** button and then use **▲** or **▼** button to select **User 1** or **User 2**.

4 Press the **▶** button and then use **▲** or **▼** button to select the desired picture option (**Contrast**, **Brightness**, **Color**, **Sharpness**, and **Tint**).

5 Press the **▶** button and then use **◀** or **▶** button to make appropriate adjustments.

6 Press the **EXIT** button to return to TV viewing or press the **MENU** button to return to the previous menu.

! NOTE

- ▶ In RGB/HDMI-PC mode, you can't adjust color, sharpness and tint to the levels you prefer.

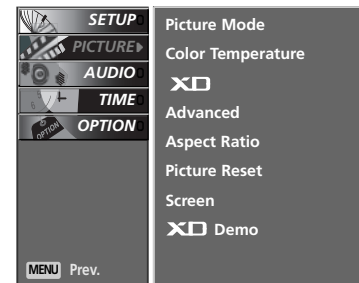

1

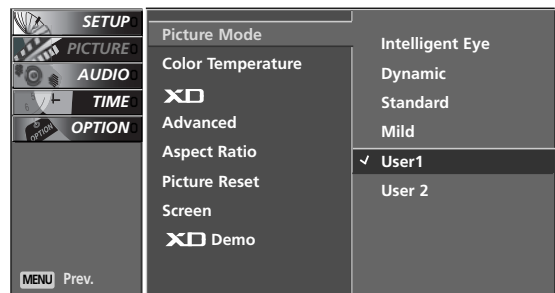

2 3

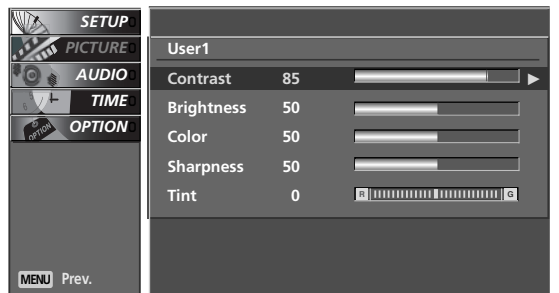

4



5

COLOR TEMPERATURE CONTROL

Choose one of three automatic color adjustments. Set to warm to enhance hotter colors such as red, or set to cool to see less intense colors with more blue.

This menu is activated after selecting the User 1 or User 2 of Picture Mode.

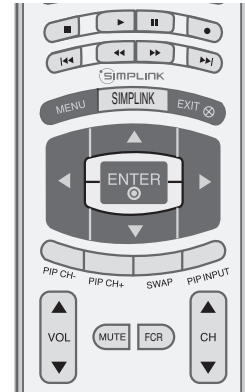

1 Press the **MENU** button and then use ▲ or ▼ button to select the **PICTURE** menu.

2 Press the ► button and then use ▲ or ▼ button to select **Color Temperature**.

3 Press the ► button and then use ▲ or ▼ button to select either **Cool, Medium, Warm** or **User**.

4 Press the **EXIT** button to return to TV viewing or press the **MENU** button to return to the previous menu.

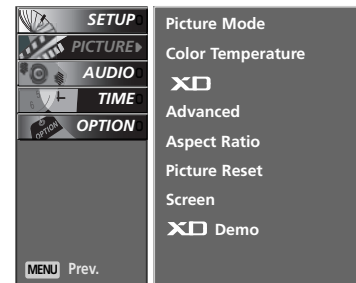

1

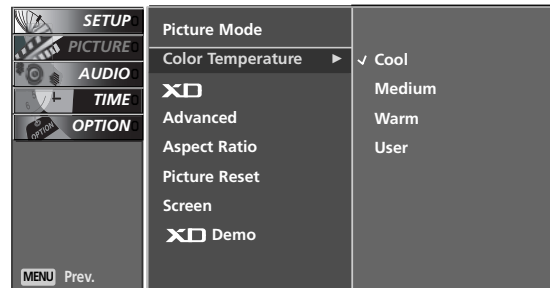

2 3

PICTURE CONTROL

MANUAL COLOR TEMPERATURE CONTROL (USER OPTION)

You can also adjust the detailed settings (Red, Green, Blue) by selecting the **user** menu.

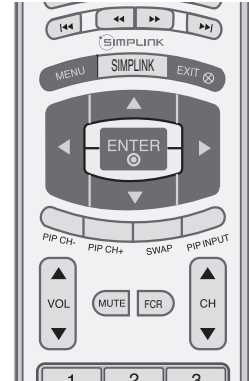

1 Press the **MENU** button and then use ▲ or ▼ button to select the **PICTURE** menu.

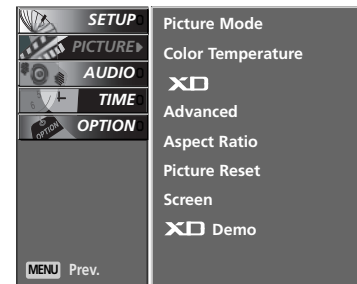

2 Press the ► button and then use ▲ or ▼ button to select **Color Temperature**.

3 Press the ► button and then use ▲ or ▼ button to select **User**.

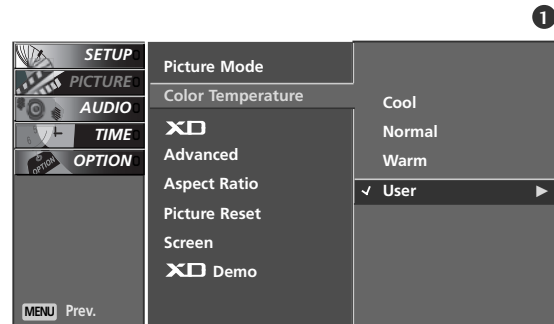

4 Press the ► button and then use ▲ or ▼ button to select **Red, Green, or Blue**.

5 Press the ► button and then use ◀ or ▶ button to make appropriate adjustments.

- The adjustment range of **Red, Green, or Blue** is -40 ~ 40.

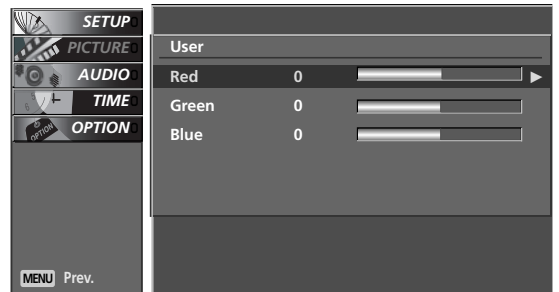

6 Press the **EXIT** button to return to TV viewing or press the **MENU** button to return to the previous menu.

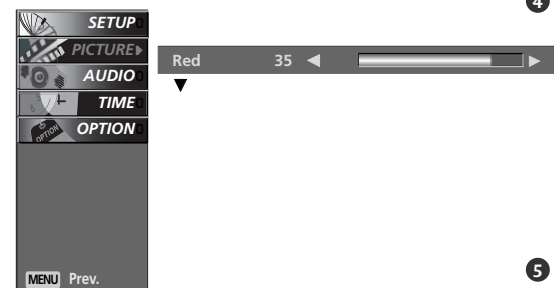

XD

XD is LG Electronic's unique picture improving technology to display a real HD source through an advanced digital signal processing algorithm.

When selecting Picture Mode options (Intelligent Eye (LCD TV models only), Dynamic, Standard and Mild), XD is automatically changed to Auto.

When selecting Picture Mode options (User 1 and User 2), you can choose the Auto / Manual.

When selecting the Manual, you can adjust the XD Contrast, XD color and XD Noise.

It's not available to use this function in RGB/HDMI-PC mode.

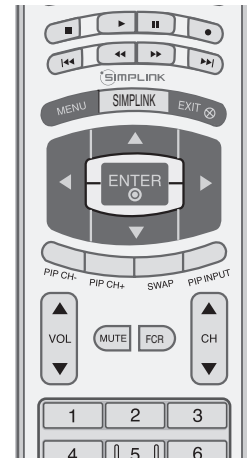

- 1 Press the **MENU** button and then use ▲ or ▼ button to select the **PICTURE** menu.
- 2 Press the ► button and then use ▲ or ▼ button to select **XD**.
- 3 Press the ► button and then use ▲ or ▼ button to select **Auto** or **Manual**.

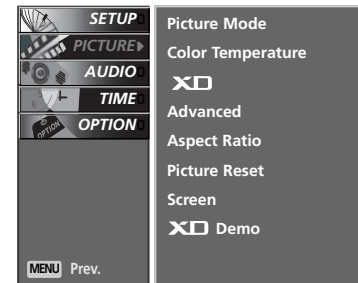

Selecting the Manual

1. Press the ► button and then use ▲ or ▼ button to select **XD Contrast**, **XD Color** or **XD NR (Noise)**, **MPEG NR**.
 - **XD Contrast**: Optimizing the contrast automatically according to the brightness of the reflection.
 - **XD Color**: Adjusting the colors of the reflection automatically to reproduce as closely as possible to the natural colors.
 - **XD NR (Noise)** : Removing the noise up to the point where it does not damage the original picture.
 - **MPEG NR** : To reduce the picture noise which may appear on the screen during watching the TV.
2. Press the ◀ or ▶ button to select **On** or **Off**.



- 4 Press the **EXIT** button to return to TV viewing or press the **MENU** button to return to the previous menu.

PICTURE CONTROL

ADVANCED-CINEMA MODE SETUP

Set up the TV for the best picture appearance for viewing movies.

When you operate Cinema (3:2 Pull-Down Mode or Cinema Correction Mode), the TV will adjust 24 fps video from movies to 30 fps video for display.

This feature operates only in Analog TV, AV and Component 480i mode.

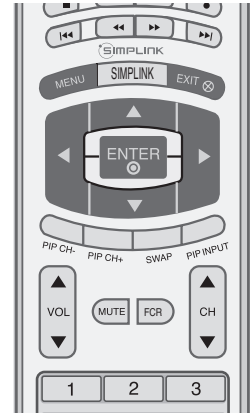

1 Press the **MENU** button and then use ▲ or ▼ button to select the **PICTURE** menu.

2 Press the ► button and then use ▲ or ▼ button to select **Advanced**.

3 Press the ► button and then use ▲ or ▼ button to select **Cinema**.

4 Press the ◀ or ▶ button to select **On** or **Off**.

5 Press the **EXIT** button to return to TV viewing or press the **MENU** button to return to the previous menu.

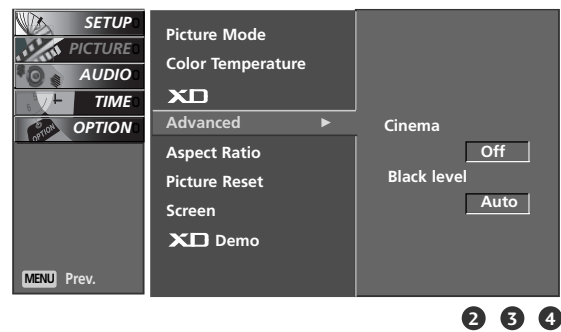
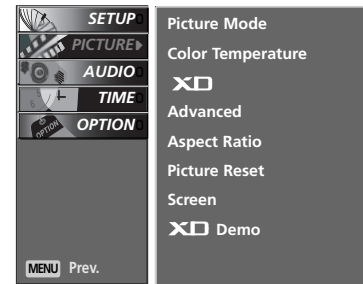

ADVANCED-BLACK LEVEL

Adjusting the contrast and the brightness of the screen using the black level of the screen.

This feature operates only in AV (composite) and HDMI mode.

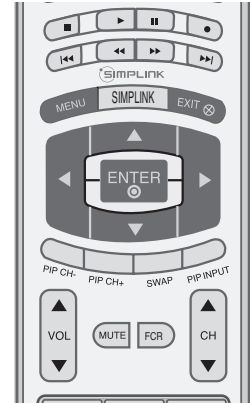

1 Press the **MENU** button and then use ▲ or ▼ button to select the **PICTURE** menu.

2 Press the ► button and then use ▲ or ▼ button to select **Advanced**.

3 Press the ► button and then use ▲ or ▼ button to select **Black Level**.

4 Press the ◀ or ▶ button to select **Low** or **High**.

- **Low**
The screen gets darker.
- **High**
The screen gets brighter.

5 Press the **EXIT** button to return to TV viewing or press the **MENU** button to return to the previous menu.

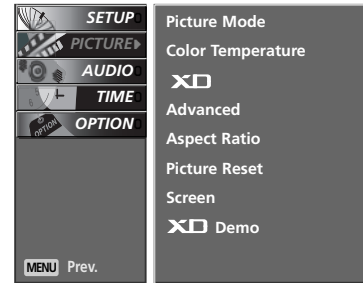

1

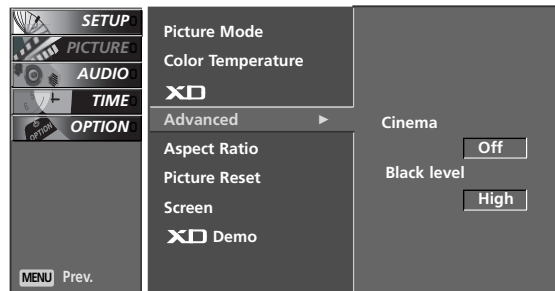

2 3 4

NOTE

- **Auto**
Realizing the black level of the screen and set it to High or Low automatically.

PICTURE CONTROL

ASPECT RATIO CONTROL

This feature lets you choose the way an analog picture with a 4:3 aspect ratio is displayed on your TV. When you receive an analog picture with a 4:3 aspect ratio on your 16:9 TV, you need to specify how the picture is to be displayed.

- RGB-PC and HDMI-PC input source use 4:3 or 16:9 aspect ratio.
- In HDMI (1080i 50Hz/60Hz, 1080p 50Hz/60Hz) mode, 1:1 Pixel is available.



NOTE

- ▶ If a fixed image is displayed on the screen for a long time, the image may become imprinted on the screen and remain visible. This phenomenon is common to all manufactures and in consequence the manufactures warranty does not cover the product bearing this phenomenon.

- 1 Press the **RATIO** button repeatedly to select the desired picture format.

You can also adjust **Aspect Ratio** in the **PICTURE** menu.

4:3

Choose 4:3 when you want to view a picture with an original 4:3 aspect ratio.

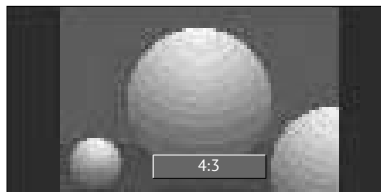

16:9

Adjust the picture horizontally, in a linear proportion to fill the entire screen.



Horizon

The screen size is, more enlarged at both sides, to create a spectacular view.

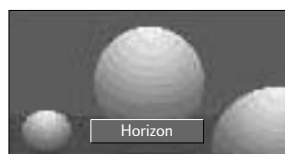

Zoom 1

Choose Zoom 1 when you want to view the picture without any alteration. However, the top and bottom portions of the picture will be cropped. You can move the Zoom1 screen using ▲ or ▼ button.

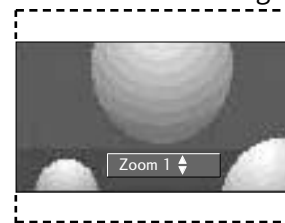

Zoom 2

Choose Zoom 2 when you want the picture to be altered, both vertically extended and cropped. The picture taking a halfway trade off between alteration and screen coverage. You can move the Zoom2 screen using ▲ or ▼ button.

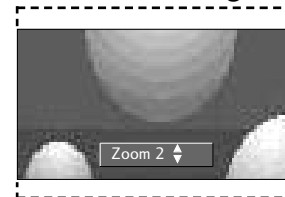

1:1 Pixel (option)

Following Selection will lead to you view the picture of best quality without loss of original picture in high resolution image.

PICTURE RESET

Use to quickly reset all the Picture menu options to their original factory preset values.

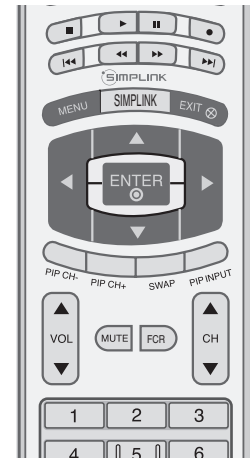

- 1 Press the **MENU** button and then use **▲** or **▼** button to select the **PICTURE** menu.
- 2 Press the **▶** button and then use **▲** or **▼** button to select **Picture Reset**.
- 3 Press the **▶** button to initialize the adjusted value.

- Returns to the default settings Picture Mode, Color Temperature, XD, Advanced at the factory.

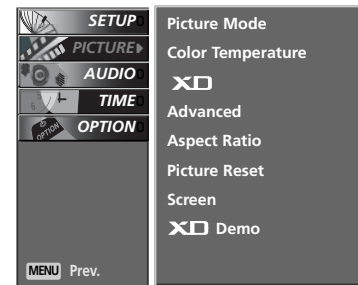

1

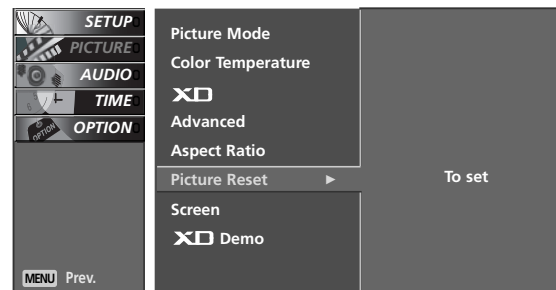

2 3

PICTURE CONTROL

XD DEMO

Use it to see the difference between XD Demo on and XD Demo off.

Note: It's not available to use this function in RGB/HDMI-PC mode.

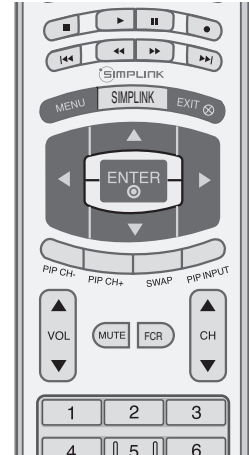

1 Press the **MENU** button and then use **▲** or **▼** button to select the **PICTURE** menu.

2 Press the **▶** button and then use **▲** or **▼** button to select **XD Demo**.

3 Press the **▶** button to begin **XD Demo**.

4 To stop **XD Demo**, press the **MENU** button.

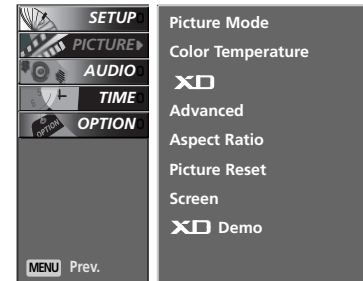

1

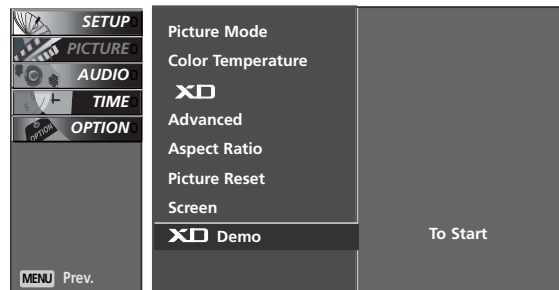

2 3

• XD Demo



AUDIO CONTROL

SOUND MODE CONTROL

Sound Mode lets you enjoy the best sound without any special adjustment because the TV sets the appropriate sound options based on the program content.

SRS TSXT, Standard, Music, Movie, and Sports are preset for good sound quality at the factory and are not adjustable.

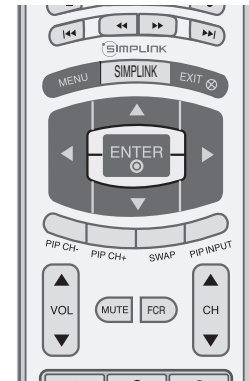

SRS TSXT Select this option to sound realistic.

Standard The most commanding and natural audio.

Music Select this option to enjoy the original sound when listening to the music.

Movie Select this option to enjoy sublime sound.

Sports Select this option to watch sports broadcasting.

User Select this option to use the user-defined audio settings.

1 Press the **MENU** button and then use ▲ or ▼ button to select the **AUDIO** menu.

2 Press the ► button and then use ▲ or ▼ button to select **Sound Mode**.

3 Press the ► button and then use ▲ or ▼ button to select **SRS TSXT, Standard, Music, Movie, Sports** or **User**.

4 Press the **EXIT** button to return to TV viewing or press the **MENU** button to return to the previous menu.

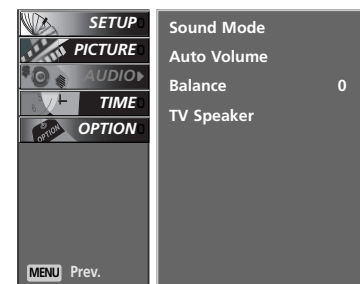

1

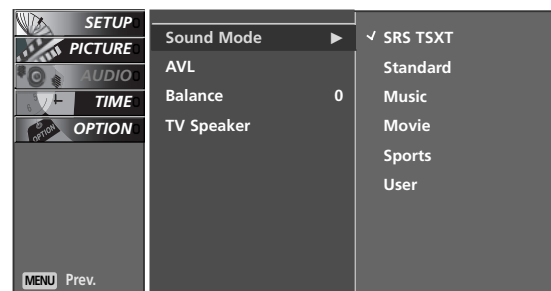

2 3

- ▶  is a trademark of SRS Labs, Inc.
- ▶ TruSurround XT technology is incorporated under license from SRS Labs, Inc.

AUDIO CONTROL

SOUND CONTROL ADJUSTMENT (USER OPTION)

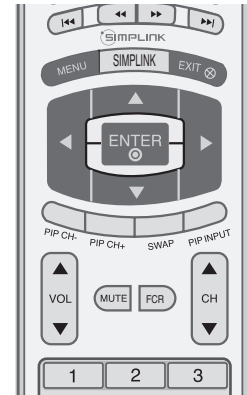

1 Press the **MENU** button and then use ▲ or ▼ button to select the **AUDIO** menu.

2 Press the ► button and then use ▲ or ▼ button to select **Sound Mode**.

3 Press the ► button and then use ▲ or ▼ button to select **User**.

4 Press the ► button.

5 Select a sound band by pressing the ▲ / ▼ button. Make appropriate sound level with the ◀ / ▶ button.

6 Press the **EXIT** button to return to TV viewing or press the **MENU** button to return to the previous menu.

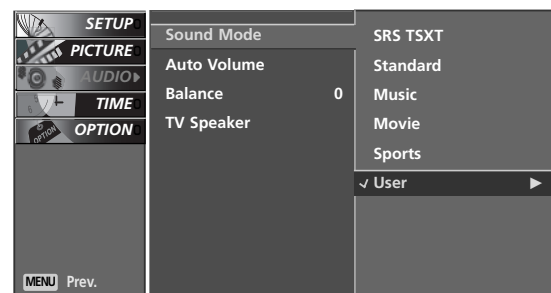

1 2 3

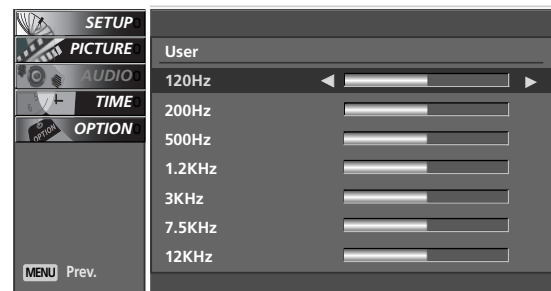

4 5

AUTO VOLUME LEVELER

Auto Volume automatically keeps on an equal volume level even if you change program.

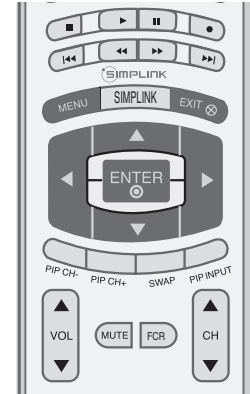

- 1 Press the **MENU** button and then use ▲ or ▼ button to select the **AUDIO** menu.
- 2 Press the ► button and then use ▲ or ▼ button to select **Auto Volume**.
- 3 Press the ► button and then use ▲ or ▼ button to select **On** or **Off**.
- 4 Press the **EXIT** button to return to TV viewing or press the **MENU** button to return to the previous menu.

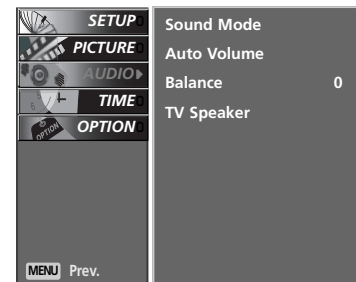

1

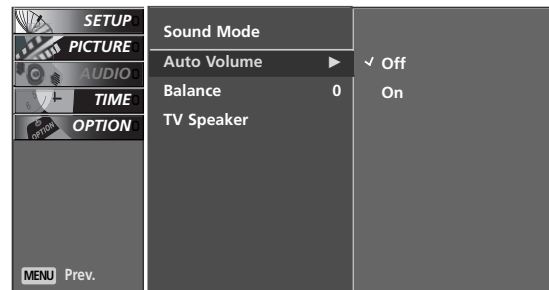

2 3

AUDIO CONTROL

BALANCE ADJUSTMENT

Adjust the left/right sound of speaker to suit your taste and room situations.

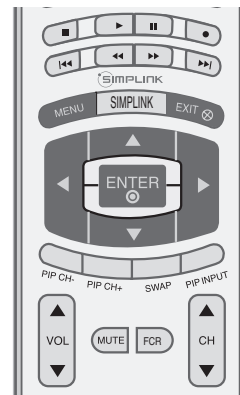

1 Press the **MENU** button and then use ▲ or ▼ button to select the **AUDIO** menu.

2 Press the ► button and then use ▲ or ▼ button to select **Balance**.

3 Press the ► button and then use ◀ or ▶ button to make desired adjustment.

4 Press the **EXIT** button to return to TV viewing or press the **MENU** button to return to the previous menu.



1

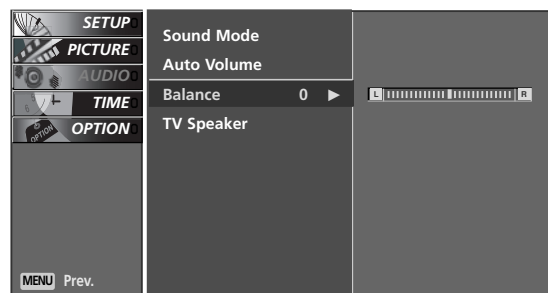

2

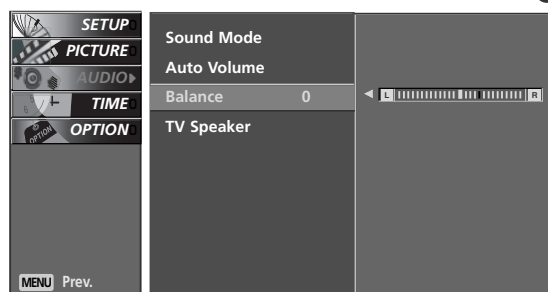

3

TV SPEAKERS ON/OFF SETUP

Turn the TV speakers off if using external audio equipment. Feature turns the TV Speakers option On or Off.

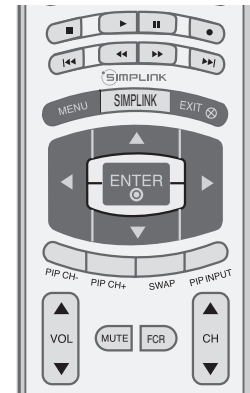

1 Press the **MENU** button and then use ▲ or ▼ button to select the **AUDIO** menu.

2 Press the ► button and then use ▲ or ▼ button to select **TV Speaker**.

3 Press the ► button and then use ▲ or ▼ button to select **On** or **Off**.

4 Press the **EXIT** button to return to TV viewing or press the **MENU** button to return to the previous menu.

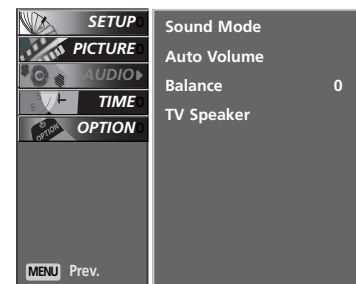

1

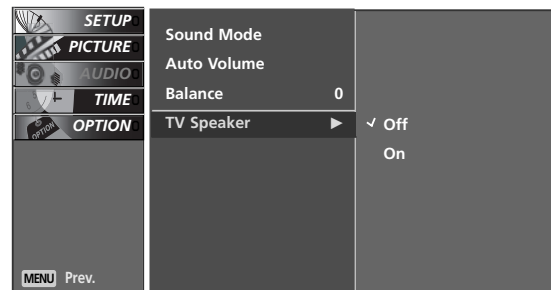

2 3

AUDIO CONTROL

STEREO/SAP BROADCASTS SETUP

The TV can receive MTS stereo programs and any SAP (Secondary Audio Program) that accompanies the stereo program; if the broadcaster transmits one additional sound signal in addition to the original one.

Mono: The primary language is heard from left and right speakers.
Signal mode is mono.

Stereo: The primary language is heard from left and right speakers.
Signal mode is stereo.

SAP: The secondary language is heard from left and right speakers in mono sound.



1 Use the **MTS** button to select your desired MTS mode in analog signal. Each time you press the **MTS** button, **Mono**, **Stereo**, or **SAP** appear in turn.

.....

2 Press the **EXIT** button to save and return to TV viewing.

! NOTE

- ▶ Select mono sound mode if the signal is not clear or in poor signal reception areas.
- ▶ **Stereo**, **SAP** modes are available only if included on the broadcast signal.

TIME SETTING

CLOCK SETUP

If the current time setting is wrong, reset the clock manually.

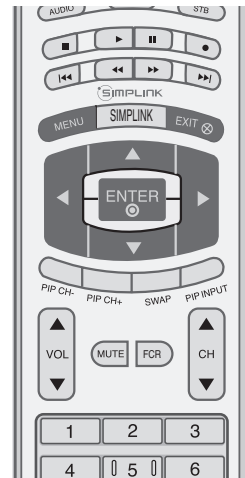

1 Press the **MENU** button and then use ▲ or ▼ button to select the **TIME** menu.

2 Press the ► button and then use ▲ or ▼ button to select **Clock**.

3 Press the ► button and then use ▲ or ▼ button to set the Year.

4 Press the ► button and then use ▲ or ▼ button to set the Time.

5 Press **EXIT** button to return to TV viewing or press **MENU** button to return to the previous menu.

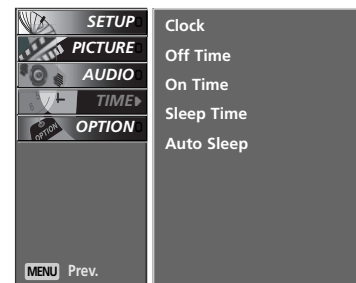

1

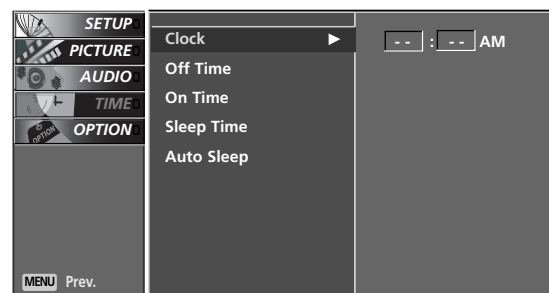

2 3 4

TIME SETTING

ON/OFF TIME SETUP

The time function operates only if the current time has been set.

The Off-Time function overrides the On-Time function if they are both set to the same time.

The TV must be in standby mode for the On-Time to work.

If you do not press any button within 2 hours after the TV turns on with the On Time function, the TV will automatically revert to standby mode.

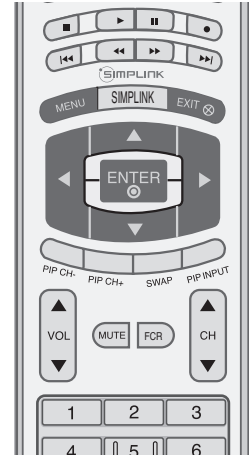

TIME SETTING

1 Press the **MENU** button and then use **▲** or **▼** button to select the **TIME** menu.

2 Press the **▶** button and then use **▲** or **▼** button to select **Off time** or **On time**.

3 Press the **▶** button and then use **▲** or **▼** button to select **On**.
 ■ To cancel the **On/Off time** function, select **Off**.

4 Press the **▶** button and then use **▲** or **▼** button to set the hour.

5 Press the **▶** button and then use **▲** or **▼** button to set the minutes.

6 **Only On time**
 Press the **▶** button and then use **▲** or **▼** to set the sound level at turn-on.
 Press the **▶** button and then use **▲** or **▼** to select the channel at turn-on.

7 Press the **EXIT** button to return to TV viewing or press the **MENU** button to return to the previous menu.

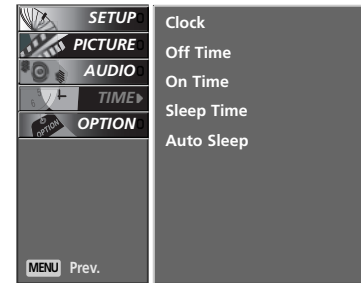

1

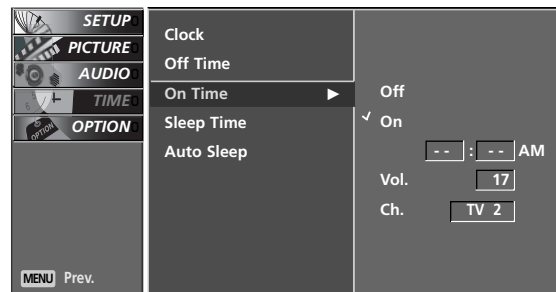

2 3 4 5 6

SLEEP TIME

The Sleep Time turns the TV off at the preset time.

Note that this setting is cleared when the TV is turned off.



- 1 Press the **SLEEP** button repeatedly to select the number of minutes. First the - - - option appears on the screen, followed by the following sleep timer options : 10, 20, 30, 60, 90, 120, 180, and 240 minutes.
- 2 When the number of minutes you want is displayed on the screen, press the **ENTER** button. The timer begins to count down from the number of minutes selected.
- 3 To check the remaining minutes before the TV turns off, press the **SLEEP** button once.
- 4 To cancel the Sleep Timer, press the **SLEEP** button repeatedly to select - - -.

TIME SETTING

AUTO SLEEP

If set to on and there is no input signal, the TV turns off automatically after 10 minutes.

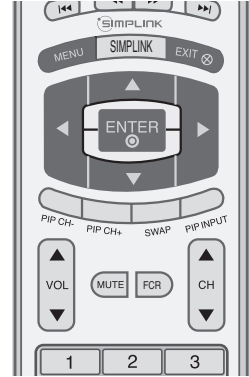

1 Press the **MENU** button and then use ▲ or ▼ button to select the **TIME** menu.

2 Press the ► button and then use ▲ or ▼ button to select **Auto Sleep**.

3 Press the ► button and then use ▲ or ▼ button to select **On** or **Off**.

4 Press **EXIT** button to return to TV viewing or press **MENU** button to return to the previous menu.

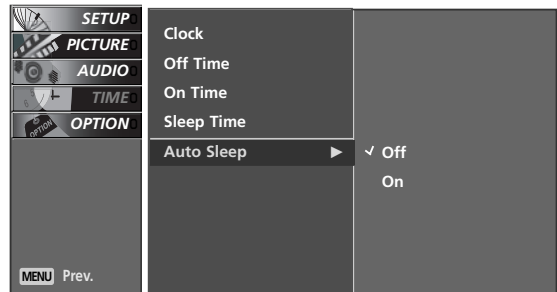
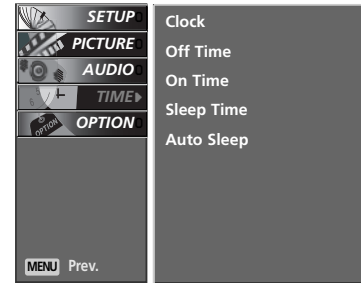

OPTION CONTROL

ON-SCREEN MENUS LANGUAGE SELECTION

The menus can be shown on the screen in the selected language.
First select your language.

1 Press the **MENU** button and then use ▲ or ▼ button to select the **OPTION** menu.

2 Press the ► button and then use ▲ or ▼ button to select **Language**.

3 Press the ► button and then use ▲ or ▼ button to select your desired language.
From this point on, the on-screen menus will be shown in the selected language.

4 Press the **EXIT** button to return to TV viewing or press the **MENU** button to return to the previous menu.

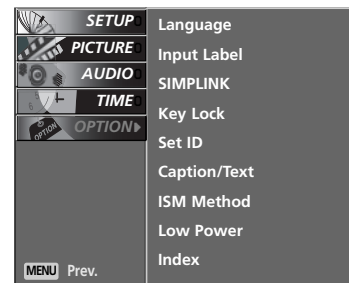

OPTION CONTROL

KEY LOCK

The TV can be set so that the remote control is needed to control it. This feature can be used to prevent unauthorized viewing by locking out the front panel controls.

This TV is programmed to remember which option it was last set to even if you turn the set off.

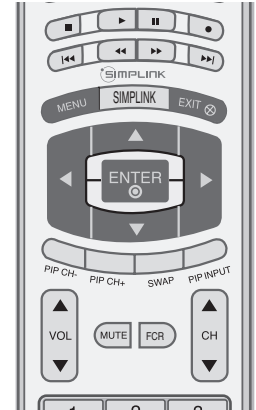

1 Press the **MENU** button and then use **▲** or **▼** button to select the **OPTION** menu.

2 Press the **▶** button and then use **▲** or **▼** button to select **Key lock**.

3 Press the **▶** button and then use **▲** or **▼** button to select **On** or **Off**.

4 Press the **EXIT** button to return to TV viewing or press the **MENU** button to return to the previous menu.

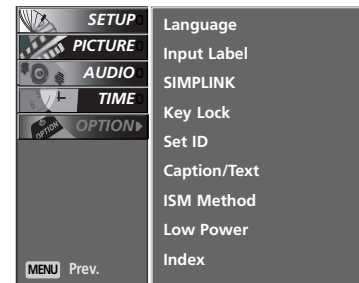

1

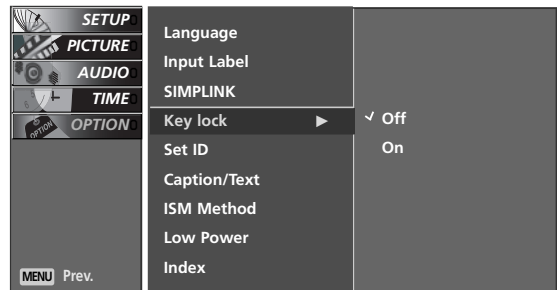

2 3

! NOTE

- ▶ In **Key lock 'On'**, if the set is turned off, press the **⏻ / I**, **INPUT**, **CH ▲ / ▼** button on the set or **POWER**, **INPUT**, **TV**, **CH ▲ / ▼** or **NUMBER** buttons on the remote control.
- ▶ With the **Key lock On**, the display **'Key Lock'** appears on the screen if any button on the front panel is pressed while viewing the set.

CLOSED CAPTIONS

Closed captioning is a process which converts the audio portion of a television program into written words which then appear as subtitles on the television screen. Closed captions allow viewers to read the dialogue and narration of television programs.

Using Closed Captions

Captions are the subtitles of the dialogue and narration of television programs. For prerecorded programs, program dialogue can be arranged into captions in advance. Its possible to caption a live program by using a process called real-time captioning, which creates captions instantly. Real-time captioning is normally done by professional reporters using a machine shorthand

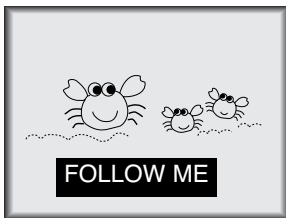

system and computer for translation into English. Captioning is an effective system for the hearing-impaired, and it can also aid in teaching language skills.

- The picture at left shows a typical caption.

Caption Tips

- Not all TV broadcasts include closed caption signals.
- Sometimes TV stations broadcast four different caption signals on the same channel. By selecting Mode1 to Mode2, you can choose which signal you view. Mode1 is usually the signal with the captions, while another mode might show demonstration or programming information.
- Your TV might not receive caption signals normally in the following situations.

1. Poor reception conditions are encountered:



• IGNITION:

Picture may flutter, drift, suffer from black spots, or horizontal streaking. Usually caused by interference from automobile ignition systems, neon lamps, electrical drills, and other electrical appliances.



• GHOSTS:

Ghosts are caused when the TV signal splits and follows two paths. One is the direct path and the other is reflected off tall buildings, hills or other objects. Changing the direction or position of the antenna may improve reception.



• SNOW:

If your receiver is located at the weak, fringe area of a TV signal, your picture may be marred by small dots. It may be necessary to install a special antenna to improve the picture.

2. An old, bad, or illegally recorded tape is being played.
3. Strong, random signals from a car or airplane interfere with the TV signal.
4. The signal from the antenna is weak.
5. The program wasn't captioned when it was produced, transmitted, or taped.

- 1 Use the **CAPTION** button repeatedly to select your caption Mode 1, Mode 2, Text1, Text2, or Off.

- 2 Press the **EXIT** button to return to TV viewing.

- You can also adjust **Caption/Text** in the **OPTION** menu.



OPTION CONTROL

ISM (IMAGE STICKING MINIMIZATION) METHOD

A frozen or still picture from a PC/video game displayed on the screen for prolonged periods will result in a ghost image remaining even when you change the image. Avoid allowing a fixed image to remain on the set's screen for a long period of time.

It's not available to use this function in LCD TV models.

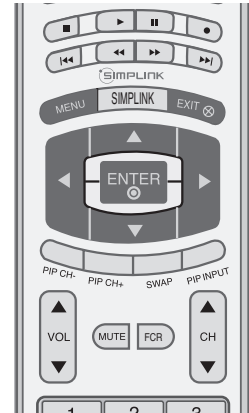

White wash

White wash removes permanent images from the screen.

Note: An excessive permanent image may be impossible to clear entirely with White Wash.

Orbiter

Orbiter may help prevent ghost images. However, it is best not to allow any fixed image to remain on the screen. To avoid a permanent image on the screen, the screen will move every 2 minutes.

Inversion

This is the function to invert the panel color of the screen. The panel color is automatically inverted every 30 minutes.

1 Press the **MENU** button and then use ▲ or ▼ button to select the **OPTION** menu.

2 Press the ► button and then use ▲ or ▼ button to select **ISM Method**.

3 Press the ► button and then use ▲ or ▼ button to select **Normal, White wash, Orbiter or Inversion**.

4 Press the **EXIT** button to return to TV viewing or press the **MENU** button to return to the previous menu.

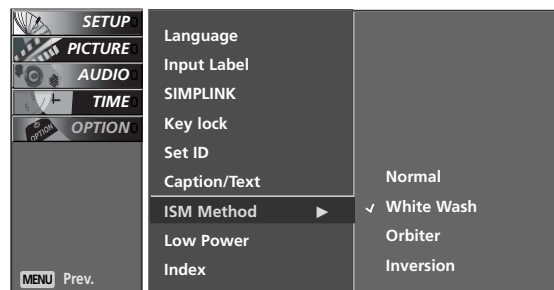

LOW POWER

This is the function to reduce the power consumption of the set.
It's not available to use this function in LCD TV models.

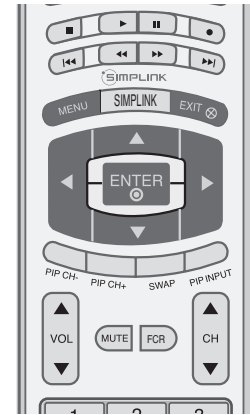

- 1 Press the **MENU** button and then use ▲ or ▼ button to select the **OPTION** menu.
- 2 Press the ► button and then use ▲ or ▼ button to select **Low power**.
- 3 Press the ► button and then use ▲ or ▼ button to select **On** or **Off**.
- 4 Press the **EXIT** button to return to TV viewing or press the **MENU** button to return to the previous menu.

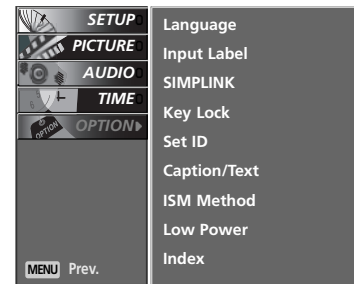

1

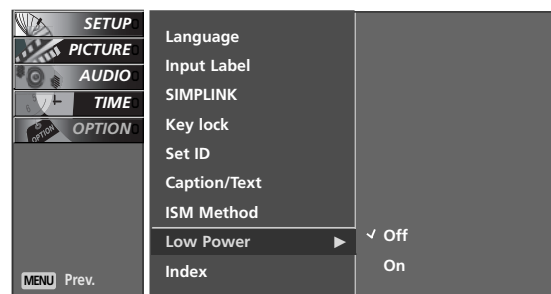

2 3

OPTION CONTROL

INDEX

Switches LED Display on or off.

It's not available to use this function in LCD TV models.

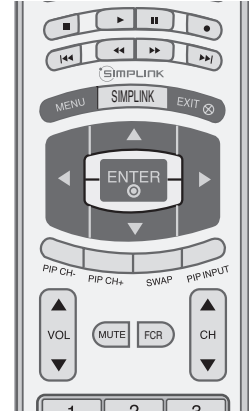

1 Press the **MENU** button and then use **▲** or **▼** button to select the **OPTION** menu.

2 Press the **▶** button and then use **▲** or **▼** button to select **Index**.

3 Press the **▶** button and then use **▲** or **▼** button to select **On** or **Off**.

4 Press the **EXIT** button to return to TV viewing or press the **MENU** button to return to the previous menu.

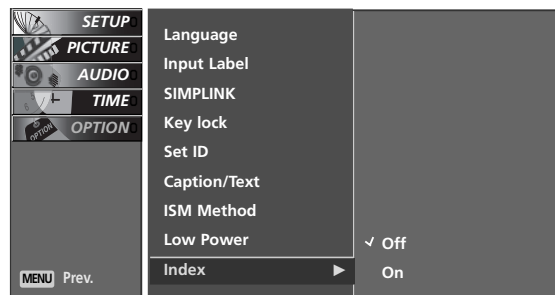
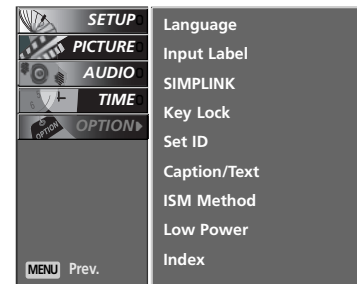

APPENDIX

TROUBLESHOOTING CHECKLIST

The operation does not work normally.	
The remote control doesn't work	<ul style="list-style-type: none">■ Check to see if there is any object between the product and the remote control causing obstruction. Ensure you are pointing the remote control directly at the TV.■ Ensure that the batteries are installed with correct polarity (+ to +, - to -).■ Ensure that the correct remote operating mode is set: TV, VCR etc.■ Install new batteries.
Power is suddenly turned off	<ul style="list-style-type: none">■ Is the sleep timer set?■ Check the power control settings. Power interrupted.■ No broadcast on station tuned with Auto off activated.

The video function does not work.	
No picture & No sound	<ul style="list-style-type: none">■ Check whether the product is turned on.■ Try another channel. The problem may be with the broadcast.■ Is the power cord inserted into wall power outlet?■ Check your antenna direction and/or location.■ Test the wall power outlet, plug another product's power cord into the outlet where the product's power cord was plugged in.
Picture appears slowly after switching on	<ul style="list-style-type: none">■ This is normal, the image is muted during the product startup process. Please contact your service center, if the picture has not appeared after five minutes.
No or poor color or poor picture	<ul style="list-style-type: none">■ Adjust Color in menu option.■ Keep a sufficient distance between the product and the VCR.■ Try another channel. The problem may be with the broadcast.■ Are the video cables installed properly?■ Activate any function to restore the brightness of the picture.
Horizontal/vertical bars or picture shaking	<ul style="list-style-type: none">■ Check for local interference such as an electrical appliance or power tool.
Poor reception on some channels	<ul style="list-style-type: none">■ Station or cable product experiencing problems, tune to another station.■ Station signal is weak, reorient antenna to receive weaker station.■ Check for sources of possible interference.
Lines or streaks in pictures	<ul style="list-style-type: none">■ Check antenna (Change the direction of the antenna).

APPENDIX

TROUBLESHOOTING CHECKLIST

The audio function does not work.	
Picture OK & No sound	<ul style="list-style-type: none">■ Press the VOL or VOLUME button.■ Sound muted? Press MUTE button.■ Try another channel. The problem may be with the broadcast.■ Are the audio cables installed properly?
No output from one of the speakers	<ul style="list-style-type: none">■ Adjust Balance in menu option.
Unusual sound from inside the product	<ul style="list-style-type: none">■ A change in ambient humidity or temperature may result in an unusual noise when the product is turned on or off and does not indicate a fault with the product.

There is a problem in PC mode. (Only PC mode applied)	
The signal is out of range.	<ul style="list-style-type: none">■ Adjust resolution, horizontal frequency, or vertical frequency.■ Check the input source.
Vertical bar or stripe on background & Horizontal Noise & Incorrect position	<ul style="list-style-type: none">■ Work the Auto configure or adjust clock, phase, or H/V position. (Option)
Screen color is unstable or single color	<ul style="list-style-type: none">■ Check the signal cable.■ Reinstall the PC video card.

MAINTENANCE

Early malfunctions can be prevented. Careful and regular cleaning can extend the amount of time you will have your new TV. Be sure to turn the power off and unplug the power cord before you begin any cleaning.

Cleaning the Screen

- 1 Here's a great way to keep the dust off your screen for a while. Wet a soft cloth in a mixture of lukewarm water and a little fabric softener or dish washing detergent. Wring the cloth until it's almost dry, and then use it to wipe the screen.
- 2 Make sure the excess water is off the screen, and then let it air-dry before you turn on your TV.

Cleaning the Cabinet

- To remove dirt or dust, wipe the cabinet with a soft, dry, lint-free cloth.
- Please be sure not to use a wet cloth.

Extended Absence

CAUTION

- ▶ If you expect to leave your TV dormant for a long time (such as a vacation), it's a good idea to unplug the power cord to protect against possible damage from lightning or power surges.

APPENDIX

PRODUCT SPECIFICATIONS

MODELS		42LY3RF (42LY3RF-MB)	47LY3RF (47LY3RF-MB)
Dimensions (Width x Height x Depth)	including stand	43.8 x 28.4 x 11.6 inches 1113.3 x 722.5 x 294.3 mm	48.7 x 31.3 x 12.8 inches 1236.9 x 795.5 x 325.5 mm
	excluding stand	43.8 x 25.8 x 3.5 inches 1113.3 x 656.5 x 88.5 mm	48.7 x 28.6 x 4.1 inches 1236.9 x 725.5 x 103.0 mm
Weight	including stand	66.1 pounds / 30.1 kg	89.3 pounds / 40.5 kg
	excluding stand	53.8 pounds / 24.4 kg	75.0 pounds / 34.0 kg
Power requirement Television System Program Coverage External Antenna Impedance		AC100-240V -50/60Hz NTSC, PAL-M/N VHF 2 ~ 13, UHF 14 ~ 69, CATV 1 ~ 125 75 ohm	
Environment condition	Operating Temperature Operating Humidity	32 ~ 104°F (0 ~ 40°C) Less than 80%	
	Storage Temperature Storage Humidity	-4 ~ 140°F (-20 ~ 60°C) Less than 85%	

- The specifications shown above may be changed without prior notice for quality improvement.

MODELS		60PY3RF (60PY3RF-MA)
Dimensions (Width x Height x Depth)	including stand	63.5 x 40.8 x 17.8 inches 1613.6 x 1036.8 x 452.0 mm
	excluding stand	63.5 x 38.2 x 3.9 inches 1613.6 x 970.0 x 116.5 mm
Weight	including stand	178.6 pounds / 81.0 kg
	excluding stand	143.3 pounds / 65.0 kg
Power requirement		AC100-240V -50/60Hz
Television System		NTSC, PAL-M/N
Program Coverage		VHF 2 ~ 13, UHF 14 ~ 69, CATV 1 ~ 125
External Antenna Impedance		75 ohm
Environment condition	Operating Temperature	32 ~ 104°F (0 ~ 40°C)
	Operating Humidity	Less than 80%
	Storage Temperature	-4 ~ 140°F (-20 ~ 60°C)
	Storage Humidity	Less than 85%

- The specifications shown above may be changed without prior notice for quality improvement.

APPENDIX

PROGRAMMING THE REMOTE CONTROL

The provided universal remote control can be programmed to operate most remote-controllable devices. Note that the remote may not control all models of other brands.

Programming a code into a remote mode

- 1 To find out whether your remote control can operate each device without programming, turn on the device (such as a VCR) and press the corresponding mode button on the remote. After that, press the **POWER** button. If the device is turned off and it responds properly the remote control need not be programmed. If not, the remote should be programmed to operate the device. The programming procedures are explained below.
- 2 Press the **MENU** and **MUTE** button continuously at the same time for two seconds; the currently selected device button is illuminated. If you don't press any button for 20 seconds, the light on the mode button will be turned off. In that case, you have to repeat from step 2.
- 3 Enter the appropriate code from the code table on the following pages. When pressing the button, the light blinks at a time. If the device turned off, the programming is successful.
- 4 Press the **MENU** button to store the code. After blinking twice, this code is stored.
- 5 Test the remote control functions to see if the device responds properly. If not, steps 2-5.

PROGRAMMING CODES

DVD

Brand	Codes	Brand	Codes	Brand	Codes
APEX DIGITAL	022	MITSUBISHI	002	RCA	005 006
DENON	020 014	NAD	023	SAMSUNG	011 015
GE	005 006	ONKYO	008 017	SONY	007
HARMAN KARDON	027	PANASONIC	003 009	THOMPSON	005 006
JVC	012	PHILIPS	013	TOSHIBA	019 008
LG	001 010 016 025	PIONEER	004 026	YAMAHA	009 018
MAGNAVOX	013	PROCEED	021	ZENITH	010 016 025
MARANTZ	024	PROSCAN	005 006		

VCRs

Brand	Codes	Brand	Codes	Brand	Codes
AIWA	034	MAGNAVOX	031 033 034 041	SAMSUNG	032 040 102 104
AKAI	016 043 046 124		067 068		105 107 109 112
	125 146	MARANTZ	012 031 033 067		113 115 120 122
AMPRO	072		069		125
ANAM	031 033 103	MARTA	101	SANSUI	022 043 048 135
AUDIO DYNAMICS	012 023 039 043	MATSUI	027 030	SANYO	003 007 010 014
BROKSONIC	035 037 129	MEI	031 033		102 134
CANON	028 031 033	MEMOREX	003 010 014 031	SCOTT	017 037 112 129
CAPEHART	108		033 034 053 072		131
CRAIG	003 040 135		101 102 134 139	SEARS	003 008 009 010
CURTIS MATHES	031 033 041	MGA	045 046 059		013 014 017 020
DAEWOO	005 007 010 064	MINOLTA	013 020		031 042 073 081
	065 108 110 111	MITSUBISHI	013 020 045 046		101
	112 116 117 119		049 051 059 061	SHARP	031 054 149
DAYTRON	108		151	SHINTOM	024
DBX	012 023 039 043	MTC	034 040	SONY	003 009 031 052
DYNATECH	034 053	MULTITECH	024 034		056 057 058 076
ELECTROHOME	059	NEC	012 023 039 043		077 078 149
EMERSON	006 017 025 027		048	SOUNDESIGN	034
	029 031 034 035	NORDMENDE	043	STS	013
	036 037 046 101	OPTONICA	053 054	SYLVANIA	031 033 034 059
	129 131 138 153	PANASONIC	066 070 074 083		067
FISHER	003 008 009 010		133 140 145	SYMPHONIC	034
FUNAI	034			TANDY	010 034
GE	031 033 063 072	PENTAX	013 020 031 033	TATUNG	039 043
	107 109 144 147		063	TEAC	034 039 043
GO VIDEO	132 136	PHILCO	031 034 067	TECHNICS	031 033 070
HARMAN KARDON	012 045	PHILIPS	031 033 034 054	TEKNIKA	019 031 033 034
HITACHI	004 018 026 034		067 071 101		101
	043 063 137 150	PILOT	101	THOMAS	034
INSTANTREPLAY	031 033	PIONEER	013 021 048	TMK	006
JCL	031 033	PORTLAND	108	TOSHIBA	008 013 042 047
JCPENNY	012 013 015 033	PULSAR	072		059 082 112 131
	040 066 101	QUARTZ	011 014	TOTEVISION	040 101
JENSEN	043	QUASAR	033 066 075 145	UNITECH	040
JVC	012 031 033 043	RCA	013 020 033 034	VECTOR RESEARCH	012
	048 050 055 060		040 041 062 063	VICTOR	048
	130 150 152		107 109 140 144	VIDEO CONCEPTS	012 034 046
KENWOOD	014 034 039 043		145 147	VIDEOSONIC	040
	047 048	REALISTIC	003 008 010 014	WARDS	003 013 017 024
LG (GOLDSTAR)	001 012 013 020		031 033 034 040		031 033 034 040
	101 106 114 123		053 054 101		053 054 131
LLOYD	034	RICO	058	YAMAHA	012 034 039 043
LXI	003 009 013 014	RUNCO	148	ZENITH	034 048 056
	017 034 101 106	SALORA	014		058 072 080 101
MAGIN	040				

APPENDIX

IR CODES

1. How to Connect

- Connect your wired remote control to the Remote Control port on the TV.

2. Remote Control IR Codes

■ Output waveform

Single pulse, modulated with 37.917KHz signal at 455KHz

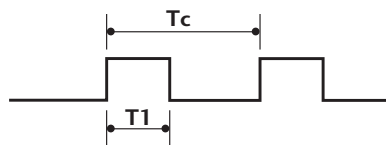

Carrier frequency
 $FCAR = 1/TC = fOSC/12$
 Duty ratio = $T1/TC = 1/3$

■ Configuration of frame

1st frame



Repeat frame

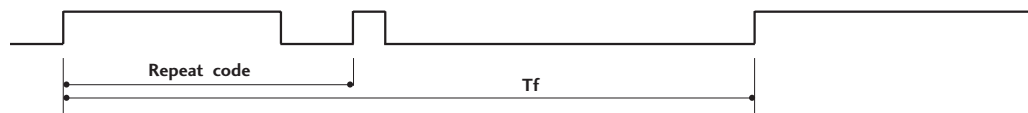

■ Lead code



■ Repeat code

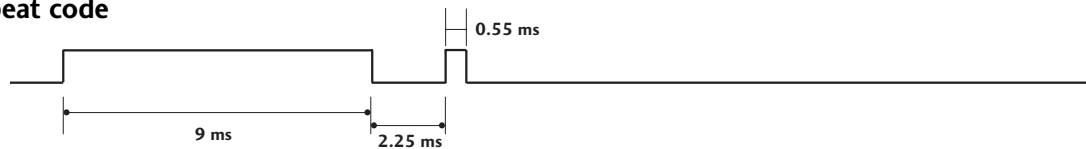

■ Bit description

Bit "0"

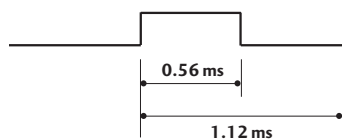

Bit "1"

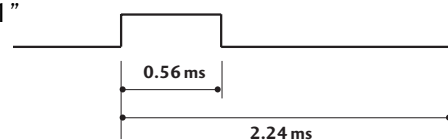

■ Frame interval: Tf

The waveform is transmitted as long as a key is depressed.

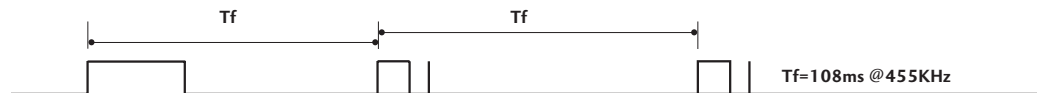

Code (Hexa)	Function	Note	Code (Hexa)	Function	Note
0F	TV	Remote control Button	44	ENTER	Remote control Button
0B	INPUT	Remote control Button	72	PIP CH-	Remote control Button
08	POWER	Remote control Button (Power On/Off)	71	PIP CH+	Remote control Button
C4	POWER ON	Discrete IR Code (Only Power On)	61	PIP INPUT	Remote control Button
C5	POWER OFF	Discrete IR Code (Only Power OFF)	02	VOL +	Remote control Button
60	PIP	Remote control Button	03	VOL -	Remote control Button
0E	SLEEP	Remote control Button	00	CH +	Remote control Button
39	Caption	Remote control Button	01	CH -	Remote control Button
0A	MTS	Remote control Button	09	MUTE	Remote control Button
43	MENU	Remote control Button	55	Memory/Erase	Remote control Button
79	RATIO	Remote control Button	10 ~ 19	Number Key 0 ~ 9	Remote control Button
5B	EXIT	Remote control Button	1E	FCR	Remote control Button
07	◀	Remote control Button	1A	REVIEW	Remote control Button
06	▶	Remote control Button	64	SIZE	Remote control Button
40	▲	Remote control Button	62	POSITION	Remote control Button
41	▼	Remote control Button	63	SWAP	Remote control Button
B0	PLAY	Remote control Button			
BA	PAUSE	Remote control Button			
B1	STOP	Remote control Button			
BD	REC	Remote control Button			
8F	REW	Remote control Button			
8E	FF	Remote control Button			
B2	GO TO PREV	Remote control Button			
B3	GO TO NEXT	Remote control Button			

APPENDIX

EXTERNAL CONTROL DEVICE SETUP

Connect the RS-232C (serial port) input jack to an external control device (such as a computer or an A/V control system) to control the product's functions externally.

Connect the serial port of the control device to the RS-232C jack on the product back panel.

Note: RS-232C connection cables are not supplied with the product.

RS-232C Setup

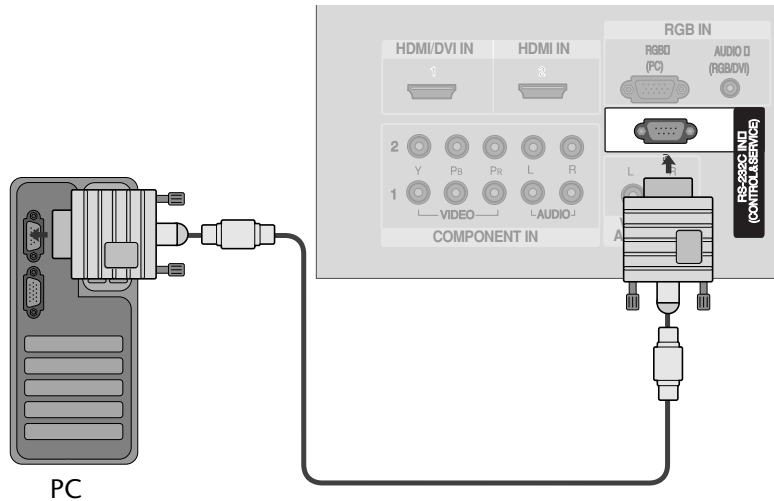

APPENDIX

Type of Connector; D-Sub 9-Pin Male

No.	Pin Name
1	No connection
2	RXD (Receive data)
3	TXD (Transmit data)
4	DTR (DTE side ready)
5	GND
6	DSR (DCE side ready)
7	RTS (Ready to send)
8	CTS (Clear to send)
9	No Connection

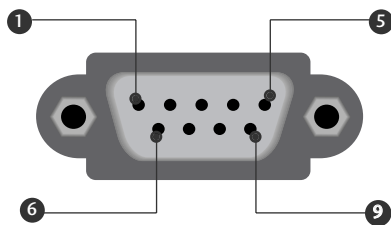

RS-232C Configurations

7-Wire Configurations (Standard RS-232C cable)

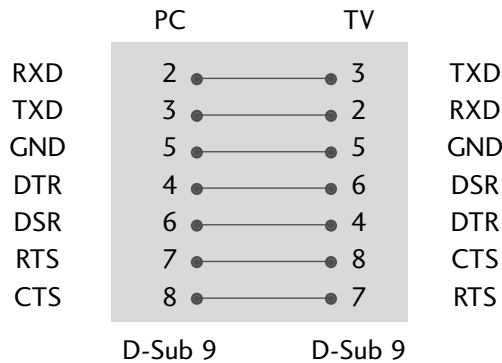

3-Wire Configurations (Not standard)

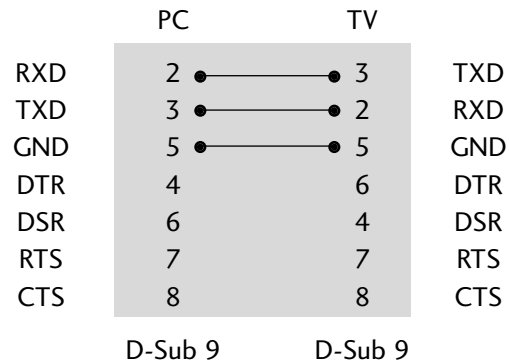

Set ID

Use this function to specify a TV ID number.
Refer to 'Real Data Mapping 1'. ► p.88.

- 1 Press the **MENU** button and then use ▲ or ▼ button to select the **OPTION** menu.
- 2 Press the ► button and then use ▲ or ▼ button to select **Set ID**.
- 3 Press the ► button and then use ◀ or ▶ button to adjust **Set ID** to choose the desired TV ID number. The adjustment range of Set ID is 1~99.
- 4 Press the **EXIT** button to return to TV viewing or press the **MENU** button to return to the previous menu.

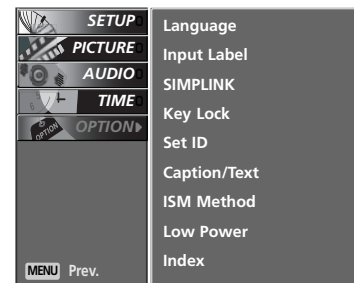

1

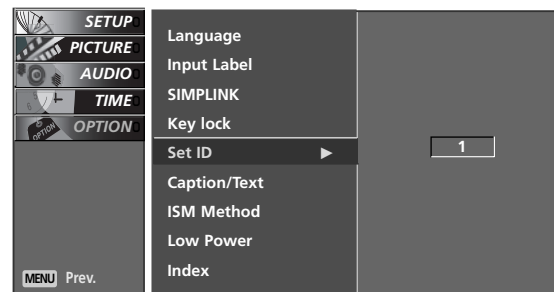

2 3

Communication Parameters

- Baud rate : 9600 bps (UART)
- Data length : 8 bits
- Parity : None
- Stop bit : 1 bit
- Communication code : ASCII code
- Use a crossed (reverse) cable.

APPENDIX

Command Reference List

	COMMAND1	COMMAND2	DATA (Hexadecimal)		COMMAND1	COMMAND2	DATA (Hexadecimal)
01. Power	k	a	0 ~ 1	15. Balance	k	t	0 ~ 64
02. Aspect Ratio	k	c	▶ P. 85	16. Color Temperature	k	u	0 ~ 3
03. Screen Mute	k	d	0 ~ 1	17. Red Adjustment	k	v	0 ~ 50
04. Volume Mute	k	e	0 ~ 1	18. Green Adjustment	k	w	0 ~ 50
05. Volume Control	k	f	0 ~ 64	19. Blue Adjustment	k	\$	0 ~ 50
06. Contrast	k	g	0 ~ 64	20. Abnormal Status	k	z	FF
07. Brightness	k	h	0 ~ 64	21. Auto Configure	j	u	1
08. Color	k	i	0 ~ 64	22. Channel Select Command	m	a	*
09. Tint	k	j	0 ~ 64	23. ISM Method (option)	k	u	0 ~ 3
10. Sharpness	k	k	0 ~ 64	24. Low Power (option)	k	u	0 ~ 1
11. OSD Select	k	l	0 ~ 1	25. Send IR Code	m	c	Key Code
12. Remote Control lock mode	k	m	0 ~ 1	26. Input select (Main)	x	b	*
13. PIP/DW	k	n	▶ P. 86	27. Input select (PIP)	x	y	*
14. PIP Position	k	q	0 ~ 3				

Transmission / Receiving Protocol

Transmission

[Command1][Command2][][Set ID][][Data][Cr]

[Command 1] : First command to control the set.(j,k,mor x)

[Command 2] : Second command to control the set.

[Set ID] : You can adjust the set ID to choose desired TV ID number in Special menu. Adjustment range is 1~99. When selecting Set ID '0', every connected the TV is controlled. Set ID is indicated as decimal (1~99) on menu and as Hexa decimal (0x0~0x63) on transmission/receiving protocol.

[DATA] : To transmit command data.

Transmit 'FF' data to read status of command.

[Cr] : Carriage Return

ASCII code '0x0D'

[] : ASCII code 'space (0x20)'

OK Acknowledgement

[Command2][][Set ID][][OK][Data][x]

The TV transmits ACK (acknowledgement) based on this format when receiving normal data. At this time, if the data is data read mode, it indicates present status data. If the data is data write mode, it returns the data of the PC computer.

Error Acknowledgement

[Command2][][Set ID][][NG][Data][x]

The TV transmits ACK (acknowledgement) based on this format when receiving abnormal data from non-viable functions or communication errors.

Data1: Illegal Code

Data2: Not supported function

Data3: Wait more time

01. Power (Command2:a)

To control Power On/Off of the TV.

Transmission [k][a][][Set ID][][Data][Cr]

Data 0 : Power Off Data 1 : Power On

Acknowledgement [a][][Set ID][][OK][Data][x]

To show Power On/Off.

Transmission [k][a][][Set ID][][FF][Cr]

Acknowledgement [a][][Set ID][][OK][Data][x]

* In a like manner, if other functions transmit 'FF' data based on this format, Acknowledgement data feedback presents status about each function.

* To change the Power on input the transmission more than twice.

02. Aspect Ratio (Command2:c) (Main picture size)

To adjust the screen format. (Main picture format)

You can also adjust the screen format using the RATIO button on remote control or in the Screen menu.

Transmission [k][c][][Set ID][][Data][Cr]

Data 1: Normal screen (4:3) Data 4: Zoom1
Data 2: Wide screen (16:9) Data 5: Zoom2
Data 3: Horizon Data 6: 1:1 Pixel (option)

Acknowledgement [c][][Set ID][][OK][Data][x]

* Using the RGB-PC, Component or HDMI input, you select either 16:9 or 4:3 screen aspect ratio.

* In HDMI (1080i 50Hz/60Hz, 1080p 50Hz/60Hz) mode, 1:1 Pixel is available.

03. Screen Mute (Command2:d)

To select screen mute on/off.

Transmission [k][d][][Set ID][][Data][Cr]

Data 0 : Screen mute off (Picture on)
Data 1 : Screen mute on (Picture off)

Acknowledgement [d][][Set ID][][OK][Data][x]

04. Volume Mute (Command2:e)

To control volume mute on/off.

You can also adjust mute using the MUTE button on remote control.

Transmission [k][e][][Set ID][][Data][Cr]

Data 0 : Volume mute on (Volume off)
Data 1 : Volume mute off (Volume on)

Acknowledgement [e][][Set ID][][OK][Data][x]

05. Volume Control (Command2:f)

To adjust volume.

You can also adjust volume with the volume buttons on remote control.

Transmission [k][f][][Set ID][][Data][Cr]

Data Min : 0 ~ Max : 64

Refer to 'Real data mapping 1': See page 88.

Acknowledgement [f][][Set ID][][OK][Data][x]

06. Contrast (Command2:g)

To adjust screen contrast.

You can also adjust contrast in the Picture menu.

Transmission [k][g][][Set ID][][Data][Cr]

Data Min : 0 ~ Max : 64

Refer to 'Real data mapping 1': See page 88.

Acknowledgement [g][][Set ID][][OK][Data][x]

07. Brightness (Command2:h)

To adjust screen brightness.

You can also adjust brightness in the Picture menu.

Transmission [k][h][][Set ID][][Data][Cr]

Data Min : 0 ~ Max : 64

Refer to 'Real data mapping 1': See page 88.

Acknowledgement [h][][Set ID][][OK][Data][x]

08. Color (Command2:i)

To adjust the screen color.

You can also adjust color in the Picture menu.

Transmission [k][i][][Set ID][][Data][Cr]

Data Min : 0 ~ Max : 64

Refer to 'Real data mapping 1': See page 88.

Acknowledgement [i][][Set ID][][OK][Data][x]

09. Tint (Command2:j)

To adjust the screen tint.

You can also adjust tint in the Picture menu.

Transmission [k][j][][Set ID][][Data][Cr]

Data Red : 0 ~ Green : 64

Refer to 'Real data mapping 1': See page 88.

Acknowledgement [j][][Set ID][][OK][Data][x]

APPENDIX

10. Sharpness (Command2:k)

To adjust the screen sharpness.

You can also adjust sharpness in the Picture menu.

Transmission [k][k][][Set ID][][Data][Cr]

Data Min: 0 ~ Max: 64

Refer to 'Real data mapping 1'. See page 88.

Acknowledgement [k][][Set ID][][OK][Data][x]

11. OSD Select (Command2:l)

To select OSD (On Screen Display) on/off when controlling remotely.

Transmission [k][l][][Set ID][][Data][Cr]

Data 0: OSD off

Data 1: OSD on

Acknowledgement [l][][Set ID][][OK][Data][x]

12. Remote Control Lock Mode (Command2:m)

To lock the remote control and the front panel controls on the set.

Transmission [k][m][][Set ID][][Data][Cr]

Data 0: Lock off

Data 1: Lock on

Acknowledgement [m][][Set ID][][OK][Data][x]

If you're not using the remote control and front panel controls on the TV, use this mode. When main power is on/off, remote control lock is released.

13. PIP / DW(Command2:n)

To control the PIP (Picture In picture)/Double window.

You can also control the PIP/Double window using the PIP button on the remote control.

Transmission [k][n][][Set ID][][Data][Cr]

Data 0: PIP/DW off

Data 1: PIP

Data 2: DW1

Data 3: DW2

Acknowledgement [n][][Set ID][][OK][Data][x]

14. PIP Position (Command2:q)

To select sub picture position for PIP.

You can also adjust the sub picture position using POSITION button on the remote control.

Transmission [k][q][][Set ID][][Data][Cr]

Data 0: Right down on screen

Data 1: Left down on screen

Data 2: Left up on screen

Data 3: Right up on screen

Acknowledgement [q][][Set ID][][OK][Data][x]

15. Balance (Command2:t)

To adjust balance.

You can also adjust balance in the Sound menu.

Transmission [k][t][][Set ID][][Data][Cr]

Data Min: 0 ~ Max: 64

Refer to 'Real data mapping 1'. See page 88.

Acknowledgement [t][][Set ID][][OK][Data][x]

16. Color Temperature (Command2:u)

To adjust color temperature.

You can also adjust Color Temperature in the Picture menu.

Transmission [k][u][][Set ID][][Data][Cr]

Data 0: Cool 1: Medium 2: Warm 3: User

Acknowledgement [u][][Set ID][][OK][Data][x]

17. Red Adjustment (Command2:v)

To adjust red in color temperature.

Transmission [k][v][][Set ID][][Data][Cr]

Data Min: 0 ~ Max: 50

Refer to 'Real data mapping 2'. See page 88.

Acknowledgement [v][][Set ID][][OK][Data][x]

18. Green Adjustment (Command2:w)

To adjust green in color temperature.

Transmission [k][w][][Set ID][][Data][Cr]

Data Min: 0 ~ Max: 50

Refer to 'Real data mapping 2'. See page 88.

Acknowledgement [w][][Set ID][][OK][Data][x]

19. Blue Adjustment (Command2:\$)

To adjust blue in color temperature.

Transmission [k][\$][][Set ID][][Data][Cr]

Data Min: 0 ~ Max: 50

Refer to 'Real data mapping 2'. See page 88.

Acknowledgement [\$][][Set ID][][OK][Data][x]

20. Abnormal State (Command2:z)

To recognize an abnormal state.

Transmission [k][z][][Set ID][][FF][][Cr]

Data FF: Read

Acknowledgement [z][][Set ID][][OK][Data][x]

Data 0: Normal (Power on and signal exist)

Data 1: No signal (Power on)

Data 2: Turn the TV off by remote control

Data 3: Turn the TV off by sleep time function

Data 4: Turn the TV off by RS-232C function

Data 5: 5V down

Data 6: AC down

Data 7: Turn the TV off by Fan Alarm function (option)

Data 8: Turn the TV off by Off time function

Data 9: Turn the TV off by Auto sleep function

Data a: Turn the TV off by AV board detect (option)

* This function is "read only".

21 . Auto Configure (Command1:j, Command2:u)

To adjust picture position and minimize image shaking automatically. It works only in RGB (PC) mode.

Transmission [j][u][][Set ID][][Data][Cr]

Data 1: To set

Acknowledgement [u][][Set ID][][OK][Data][x]

22 . Channel Select Command (Command1:m, Command2:a)

To select a channel for the main picture.

Transmission [m][a][][Set ID][][Data0][][Data1][][Data2][][Data3][][Data4][][Data5][Cr]

Data 0: NTSC air : 02 ~ 45

NTSC cable : 01, 0E ~ 7D

Data 1 ~ 4: Don't care

Data 5: High -> Main channel: 0, Sub channel: 8

Low -> Air: 0, CATV: 1

Acknowledgement [a][][Set ID][][OK][Data0][Data1][Data2][Data3][Data4][Data5][x][a][][Set ID][][NG][Data0][x]

23. ISM Method (Command1:j, Command2:p)(option)

To control the ISM method. You can also adjust ISM Method in SPECIAL menu.

This feature is not available for all models.

Transmission [j][p][][Set ID][][Data][Cr]

Data 0: Normal Mode Data 1: White Wash

Data 2: Orbiter Data 3: Inversion

Acknowledgement [p][][Set ID][][OK][Data][x]

24. Low Power (Command1:j, Command2:q)(option)

To reduce the power consumption of the monitor.

You can also adjust Low Power in SPECIAL menu.

This feature is not available for all models.

Transmission [j][q][][Set ID][][Data][][Cr]

Data 0: Off Data 1: On

Acknowledgement [q][][Set ID][][OK][Data][x]

APPENDIX

25. Send IR Code (Command1:m, Command2:c)

To send IR remote key code.

Transmission [m][c][][Set ID][][Data][Cr]

Data: Key code - Refer to page 81.

Acknowledgement [c][][Set ID][][OK][Data][x]

26. Input select (Command1:x, Command2:b)

(Main Picture Input)

To select input source for TV.

Transmission [x][b][][Set ID][][Data][Cr]

Data: Structure

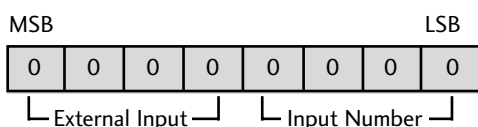

External Input				Data
0	0	0	1	Analog
0	0	1	0	AV
0	1	0	0	Component
0	1	1	0	RGB-PC
1	0	0	1	HDMI

Input Number				Data
0	0	0	0	Input1
0	0	0	1	Input2
0	0	1	0	Input3
0	0	1	1	Input4

Acknowledgement [b][][Set ID][][OK][Data][x]

27. Input select (Command1:x, Command2:y)

To adjust input source for sub picture in PIP mode.

Transmission [x][y][][Set ID][][Data][Cr]

Data: Structure

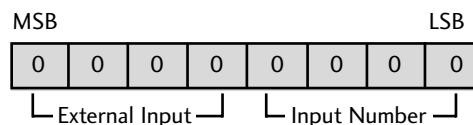

External Input				Data
0	0	0	1	Analog
0	0	1	0	AV
0	1	0	0	Component
0	1	1	0	RGB-PC
1	0	0	1	HDMI

Input Number				Data
0	0	0	0	Input1
0	0	0	1	Input2
0	0	1	0	Input3
0	0	1	1	Input4

Acknowledgement [y][][Set ID][][OK][Data][x]

* Real data mapping 1

0 : Step 0
 ⋮
 A : Step 10 (Set ID 10)
 ⋮
 F : Step 15 (Set ID 15)
 10 : Step 16 (Set ID 16)
 ⋮
 64 : Step 100
 ⋮
 6E : Step 110
 ⋮
 73 : Step 115
 74 : Step 116
 ⋮
 C7 : Step 199
 ⋮
 FE : Step 254
 FF : Step 255

* Real data mapping 2

0 : -40
 1 : -39
 2 : -38
 ⋮
 28 : 0
 ⋮
 48 : +38
 49 : +39
 50 : +40