



LAD4700R/LAD4705R/LAD4710R

ENGLISH	CAR DVD Receiver Read the manual carefully before using the unit
MACEDONIAN	Автомобилски ДВД радио-засилувач Прочитајте го прирачникот внимателно пред да го користите уредот.
BULGARIAN	Автомобилен DVD ресивър Преди да използвате уреда, прочетете внимателно това ръководство
SERBIAN	Auto DVD prijemnik Pažljivo pročitajte ovo uputstvo pre korišćenja uređaja
HUNGARIAN	Autórádió DVD-lejátszóval A készülék használata előtt gondosan olvassa el ezt a kézikönyvet.
CROATIAN	DVD receiver za automobil Prije upotrebe uređaja pažljivo pročitajte priručnik.



Safety note



CAUTION
RISK OF ELECTRIC SHOCK
DO NOT OPEN



CAUTION : TO REDUCE THE RISK OF ELECTRIC SHOCK DO NOT SPLIT COVER (OR BACK) NO USER-SERVICEABLE PARTS INSIDE. REFER SERVICING TO QUALIFIED SERVICE PERSONNEL.



The lightning flash with the arrowhead symbol, within an equilateral triangle is intended to alert the user about the presence of uninsulated dangerous voltage within the product's enclosure that may be of sufficient magnitude to constitute a risk of electric shock.



The exclamation point within an equilateral triangle is intended to alert the user to the presence of important operating and maintenance (servicing) instructions in the literature accompanying the appliance.



Always operate the vehicle in a safe manner. Do not become distracted by the vehicle while driving, and always be fully aware of all driving condition. Do not change settings, or any functions. Pull over in a safe and legal manner before attempting such operations.



Do not use for many hours at extremely low or high temperature. (-10~60°C)



To reduce the risk of electric shock, do not remove the cover or back of this product. There are no user-serviceable parts inside. Refer servicing to qualified service personnel.



To reduce the risk of fire or electric shock, do not expose this product to dripping or splashing water, rain, or moisture.



The temperature of unit's outside can be extremely high, please use the unit after proper installation in your vehicle.

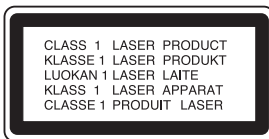

CAUTION : This product uses a Laser System.

To ensure proper use of this product, please read this owner's manual carefully and retain it for future reference. Should the unit require maintenance, contact an authorized service center.

Performing controls, adjustments, or carrying out procedures other than those specified herein may result in hazardous radiation exposure.

To prevent direct exposure to laser beam, do not try to open the enclosure. Visible laser radiation when open. DO NOT STARE INTO BEAM.



- A defective or soiled disc inserted into the unit can cause the sound to drop during playback.
- Handle the disc by holding its inner and outer edges.
- Do not touch the surface of the unlabeled side of the disc.



Do not stick paper or tape, etc. on the surface.



Do not expose the disc to direct sunlight or excessive heat.



- Clean the disc before playback. Wipe the disc from the center outward with a cleaning cloth.
- Never use solvents such as benzine or alcohol to clean the disc.

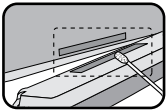

Periodically wipe the contacts on the back of the control panel with a cotton swab moistened with alcohol.

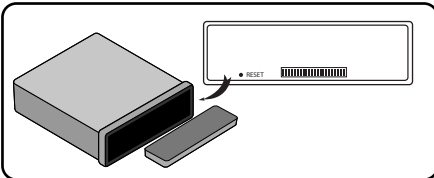

If the unit fails to operate properly, press the RESET button using a ball point pen or a similar tool.

To ensure safe driving

- To avoid the risk of accident and the potential violation of applicable laws, this unit is not for use with a video screen that is visible to the driver.
- This unit detects whether your car's parking brake is engaged or not, and prevents you from watching a DVD, VCD, PHOTO or movie file on the display connected to **FRONT VIDEO OUTPUT** while driving. When you attempt to watch a DVD, VCD, PHOTO or movie file the screen will turn black. When you park your car in a safe place and apply the parking brake, the picture appears on the screen.

Symbol Used in this Manual

A section whose title has one of the following symbols is applicable only to the disc represented by the symbol.

DVD	Video CDs	Audio CDs	MP3 files
WMA files	JPEG files	Movie files	

About the Symbol Display

When you are watching a DVD and attempt to perform an operation, it may not be performed due to the programming on the disc. When this happens, the unit indicates the button on the screen.

Region code

This unit has a region code printed on the upper part of the unit. This unit can play only DVD discs labelled as the same as the upper part of the unit or "ALL".

Notes on region code

- Most DVD discs have a globe with one or more numbers on it clearly visible on the cover. This number must match your Car DVD Receiver's region code or the disc cannot play.
- If you try to play a DVD with a different region code from your player, the message "Check Region Code" appears on the screen.

Types of Playable Discs



DVD
(12 cm disc)



Video CD (VCD)
(12 cm disc)



Audio CD
(12 cm disc)

In addition, this unit plays DVD±R, DVD±RW and CD-R or CD-RW containing audio titles, MP3, WMA, JPEG or movie files.

- Depending on the conditions of the recording equipment or the CD-R/RW (or DVD±R/±RW) disc itself, some CD-R/RW (or DVD±R/±RW) discs cannot be played on the unit.
- Do not attach any seal or label to either side (the labeled side or the recorded side) of a disc.
- Do not use irregularly shaped CDs (e.g., heart-shaped or octagonal). It may result in malfunctions.
- You have to set the disc format option to [Mastered] in order to make the discs compatible with the LG players when formatting rewritable discs.
When setting the option to Live File System, you cannot use it on LG players.
(Mastered/Live File System : Disc format system for Windows Vista)

Notes on DVDs and Video CDs

Some playback operations of DVDs and Video CDs may be intentionally programmed by software manufacturers.

This unit plays DVDs and Video CDs according to disc contents designed by the software manufacturer, therefore some playback features may not be available or other functions may be added.

TV System Selection

You must select the appropriate system mode for TV. If "NO DISC" appears in the display window, press and hold ► || on the control panel or || on remote control for more than 5 seconds to be able to select a system (AUTO, NTSC, or PAL).

When the selected system does not coincide with the system of your TV, normal colour picture may not be displayed.

AUTO : Select when the unit is connected with Multi system TV.

NTSC : Select when the unit is connected with NTSC-TV.

PAL : Select when the unit is connected with PAL-TV.

"Manufactured under license from Dolby Laboratories. "Dolby" and double-D symbol are trademarks of Dolby Laboratories"

"DVD Logo is a trademark of DVD Format/Logo Licensing Corporation"

Table of contents

Safety note	2-4
Table of contents	5
Before use	6
Control panel	7
Remote control	7-8
Installation	9
Connection diagram	9-11
Basic operation	12-14
Radio operation	15
RDS operation	16
CD/MP3/WMA operation	17-19
DISPLAY menu	19
SET UP menu	20-24
DVD/VCD operation	24-28
Photo operation	28-29
Movie operation	29-32
AUX operation	32
Troubleshooting	33
Language Code List / Area Code List	34
Reference	35
Specifications	36

NOTES ON COPYRIGHTS

It is forbidden by law to copy, broadcast, show, broadcast via cable, play in public, or rent copyrighted material without permission.

This product features the copy protection function developed by Macrovision. Copy protection signals are recorded on some discs. When playing the pictures of these discs on a unit, picture noise will appear. This product incorporates copyright protection technology that is protected by method claims of certain U.S. patents and other intellectual property rights owned by Macrovision Corporation and other rights owners. Use of this copyright protection technology must be authorized by Macrovision Corporation, and is intended for home and other limited viewing uses only unless otherwise authorized by Macrovision Corporation. Reverse engineering or disassembly is prohibited.



This product is manufactured to comply with Directive 2005/83/EEC (ANNEX I, 3.2.9), 72/245/EEC and 2006/95/EEC.

Disposal of your old appliance



1. When this crossed-out wheeled bin symbol is attached to a product, it means the product is covered by the European Directive 2002/96/EC.
2. All electrical and electronic products should be disposed of separately from the municipal waste stream via designated collection facilities appointed by the government or the local authorities.
3. The correct disposal of your old appliance will help prevent potential negative consequences for the environment and human health.
4. For more detailed information about disposal of your old appliance, please contact your city office, waste disposal service or the shop where you purchased the product.

Before use

Detaching the control panel

You can detach the control panel when leaving the car.

When detaching or attaching the control panel, be careful not to damage the connector on the back of the control panel and on the panel holder.

- 1 Press the “” button to unlock the control panel.
- 2 Push the control panel to the right.
- 3 Pull the control panel out of the unit.
- 4 Put the detached control panel into the protective case.

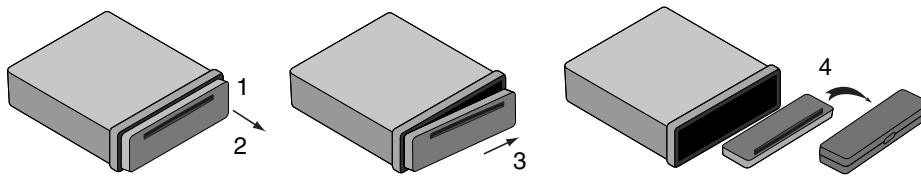

Attachable control panel

- 1 Align the left side of the panel with stopper.
- 2 Push the right side of panel into the unit until it clicks.

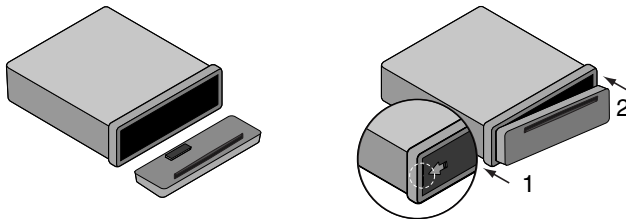

Notes

- When detaching or attaching the control panel, do not press the display or control buttons.
- The control buttons may not work properly if the control panel is not attached properly. If this occurs, gently press the control panel.
- Do not leave the control panel in any area exposed to high temperatures or direct sunlight.
- Do not drop the control panel or otherwise subject it to strong impact.
- Do not allow such volatile agents as benzene, thinner, or insecticides to come into contact with the surface of the control panel.
- Do not try to disassemble the control panel.

Control Panel

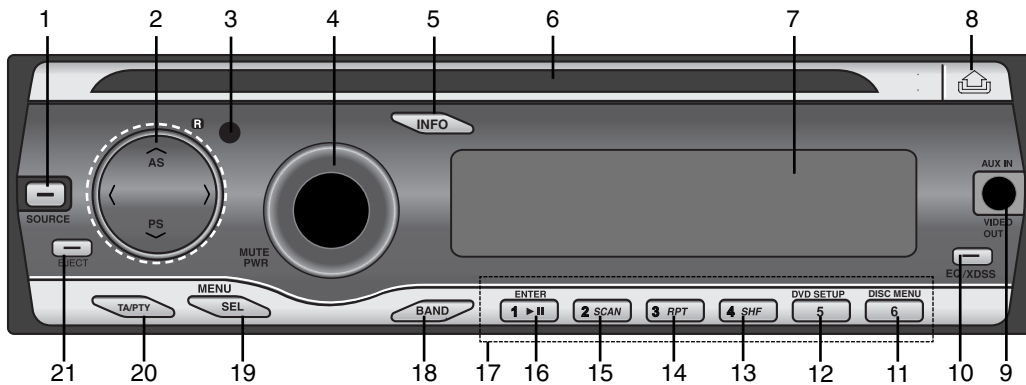

- | | | |
|-------------------------|-------------------------|--------------------------------|
| 1 [SOURCE] | 6 Disc Slot | 14 Repeat [RPT] |
| 2 • Skip / Search [◀/▶] | 7 Display Window | 15 Intro Scan [SCAN] |
| • Seek/ Tune [◀/▶] | 8 Release [⏏] | 16 • Play/Pause [▶] |
| • Auto Store [AS] | 9 • [AUX IN] | • [ENTER] |
| • Preset Scan [PS] | • [VIDEO OUT] | 17 Preset buttons [1~6] |
| • Folder Up/Down [▲/▼] | 10 • Equalizer [EQ] | 18 [BAND] |
| MP3 WMA JPEG Movie | • Extreme Dynamic Sound | 19 [MENU/SEL] |
| 3 Remote Sensor | System [XDSS] | 20 • Traffic Announcement [TA] |
| 4 • Volume knob | 11 [DISC MENU] | • Programme Type [PTY] |
| • [MUTE] | 12 [DVD SETUP] | 21 [EJECT] |
| • Power [PWR] | 13 Shuffle [SHF] | |
| 5 Information [INFO] | | |

Remote control

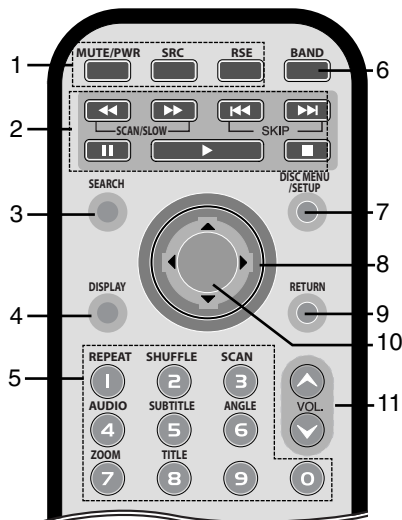

- [MUTE/POWER]**
Mutes the volume.
Switches the unit ON/OFF.
- [SRC]**
Selects a source.
- Rear Seat Entertainment [RSE]**
Plays two different sources as a main source and a secondary source.
- SCAN/SLOW ◀◀/▶▶**
Backward (Forward) search playback.
- SKIP I◀◀/▶▶I**
 - Goes to the next (previous) chapter, track or file.
 - Returns to the beginning of the current chapter, track, or file.
- PAUSE (||)**
 - Pause playback temporarily,
 - Press repeatedly for frame-by-frame playback.

- PLAY** (▶)
Starts playback.
- STOP** (■)
Stops playback.
- 3 **SEARCH**
Selects a track or file.
- 4 **DISPLAY**
Accesses On-Screen display.
- 5 **0-9 number buttons**
- Selects numbered items in the menu.
 - Selects a stored radio station frequency (1-6).
- REPEAT**
Repeats chapter, track, title or file.
- SHUFFLE** (MP3) (WMA) (ACD)
Plays tracks or files in random order.
- SCAN** (MP3) (WMA) (ACD)
Plays the first 10 seconds of all tracks or files.
- AUDIO** (DVD)
Selects audio language.
- SUBTITLE**
Selects subtitle language. (DVD)
- ANGLE** (DVD)
Selects a DVD camera angle if available.
- ZOOM** (DVD) (VCD) (JPEG)
Enlarges video image.
- TITLE** (DVD)
Displays title menu, if available.
- 6 **BAND**
- Selects three FM and MW (AM) bands.
 - Moves to any other file on a CD with the type of various file (MP3/WMA, JPEG or movie file).
- 7 **DISC MENU/SETUP** (DVD)
Accesses menu on a DVD disc.
Accesses or removes the Setup menu.
- 8 ▲/▼/◀/▶ (up/down/left/right)
Selects an item in the menu.
- 9 **RETURN**
Displays the menu of a video CD with PBC.
- 10 **ENTER**
Confirms menu selection.
- 11 **VOLUME** (UP ^ / DOWN v)
Adjusts the volume level.

Battery installation

- 1 Remove the battery holder with a sharp product like a ball point pen.
- 2 Install the battery on the battery holder.
- 3 Install the battery holder back into its original position.

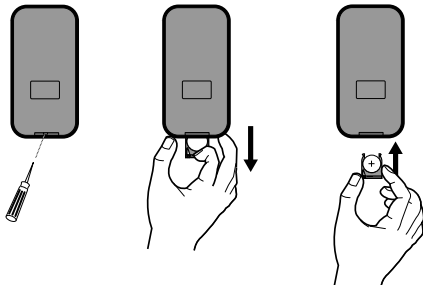

Notes

- Use only one CR2025 (3V) lithium battery.
- Remove the battery if the remote control is not used for a long period of time.
- Do not leave the product in a hot or humid place.
- Do not handle the battery with metallic tools.
- Do not store the battery with metallic materials.

Installation

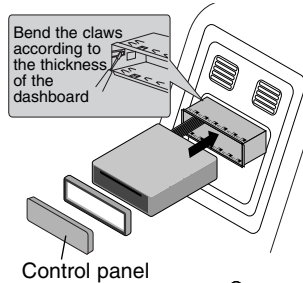

Control panel

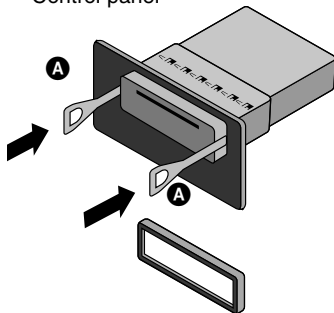

Basic Installation

Before installing, make sure that the ignition-switch is set to OFF and remove the terminal of the car battery to avoid short-circuiting.

- 1 Remove the existing receiver unit.
- 2 Make the necessary connections.
- 3 Install the installation sleeve.
- 4 Install the unit into the installation sleeve.

Removing the existing receiver unit

If there is already an installation sleeve for the receiver unit in the dashboard, it must be removed.

- 1 Remove the rear support from the unit.
- 2 Remove the control panel and trim ring from the unit.
- 3 Insert the lever **A** into the hole on one side of the unit. Perform the same operation on the other side and pull the unit out from the mounting sleeve.

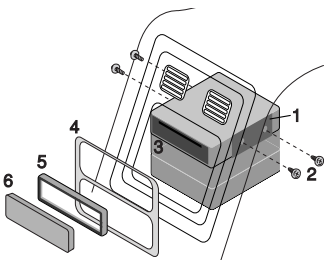

ISO-DIN Installation

- 1 Slide the unit into the ISO-DIN frame.
- 2 Fit screws removed from the old unit.
- 3 Slide the unit and frame into the dash opening.
- 4 Install the dash panel or adapter plate.
- 5 Install the trim ring to the unit.
- 6 Install the control panel to the unit.

Connection diagram

Connecting to Auxiliary equipment (Optional)

Connect the **AUDIO OUTPUT** jack of this unit to the **AUDIO INPUT** jack of the Auxiliary Equipment.

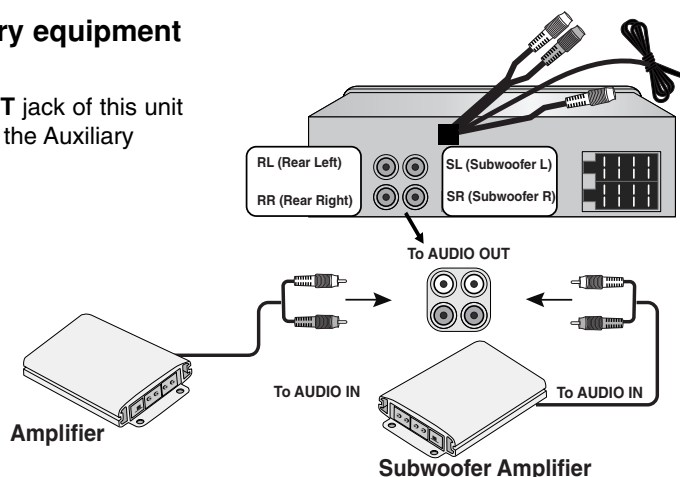

Connecting to a car

Before connecting, make sure that the ignition switch is set to OFF and remove the battery ⊖ terminal to avoid short circuits.

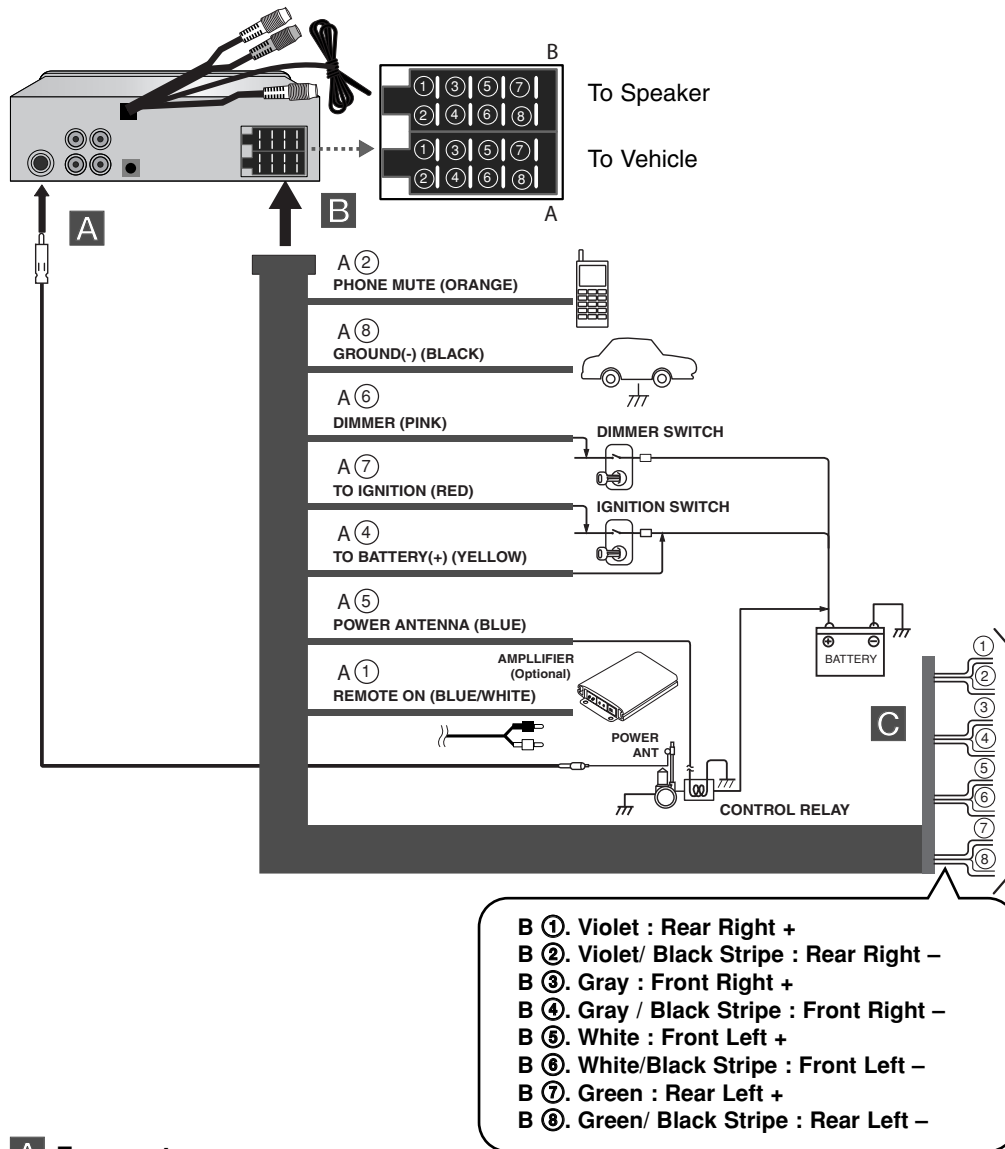

- **YELLOW:** This lead is for connection to the battery (back-up) terminal from which power is always supplied.
- **BLUE:** This lead is for the power antenna connection.
- **BLUE/WHITE:** This lead is for the remote amplifier connection.

C Speaker connections

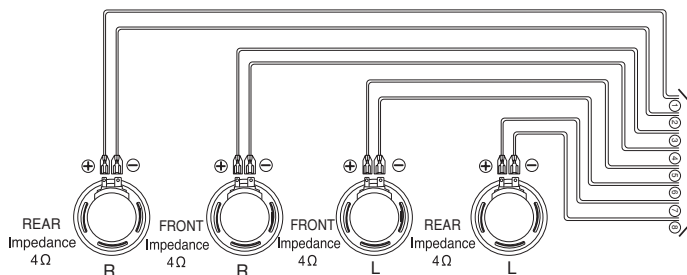

Connecting to optional equipment

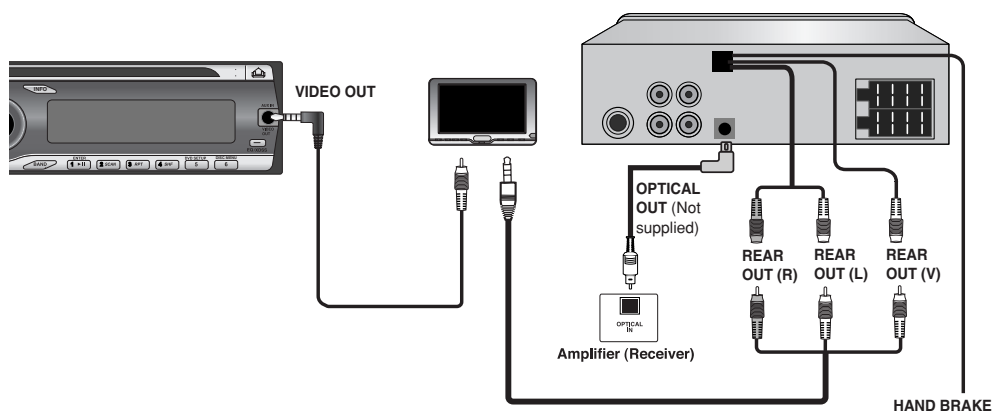

- **HAND BRAKE**
Be sure to wire the Hand Brake (Parking brake) for safety and preventing accidents.
- **REAR OUT**
Connect the **REAR OUT (R/L/V)** connector of this unit to the **AUDIO/VIDEO (AV) INPUT** connector of the monitor.
- **VIDEO OUT**
Connect the **VIDEO OUT** connector of this unit to the **VIDEO INPUT** connector of the monitor.
- **OPTICAL OUT**
Connecting to an amplifier equipped with two channel digital stereo (PCM) or to an Audio/Video receiver equipped with a multi-channel decoder (Dolby Digital™, MPEG 2 or DTS). Connect the **OPTICAL OUT** connector of this unit to the corresponding jack on your Amplifier or Receiver.

Basic operation

Turning the unit on

Press **MUTE/PWR** (**MUTE/PWR** on the remote control) or any other buttons.

✦ **Note** : When you insert the CD in the CD slot, the unit turns on.

Turning the unit off

Press and hold **MUTE/PWR** (**MUTE/PWR** on the remote control).

Inserting a disc

Insert the disc, and starts playback automatically.

Ejecting a disc

Press **EJECT**. The disc automatically ejects from the loading slot.

When the disc is ejected by pressing **EJECT** during playback, it will be loaded automatically after 10 seconds unless you remove the disc from the unit.

Selecting a source

Press **SOURCE** (**SRC** on the remote control) repeatedly to select a source.

Adjusting the volume

Rotate the **volume knob** on the control panel to adjust the sound level. Or press **VOL. ^ / V** on the remote control.

✦ **Note** : When you turn the unit off, the current volume level is automatically memorized. Whenever you turn the unit on again, it will operate at the memorized volume level.

Mute

- 1 Press **MUTE/PWR** (**MUTE/PWR** on the remote control) to cut the sound.
- 2 To cancel it, press again.

Checking the clock

You can see the clock pressing **INFO** on the control panel.

✦ **Note**

If the the RDS broadcasting with CT(Clock Time) information is received by the unit, the clock will be updated automatically in the display window. Unless, "NO CLOCK" appears in the display window.

XDSS+ (Extreme Dynamic Sound System)

Press and hold **EQ/XDSS** to reinforce treble, bass and surround effect.

XDSS+ off (No display) → XDSS+

Dual Zone mode

You can listen to the main source through the speakers, and to the secondary source through the monitor inserted into the cradle or the one connected the REAR OUT jacks.

Press **RSE** on the remote control repeatedly to select a source.

RSE ON → RSE OFF → RSE ON...

✦ **Note** : • The secondary source is only set to CD/DVD. If you set the main source to D/DVD, you cannot use the dual zone mode.

- In dual zone mode, you can not use the **PWR/MUTE**, **SRC** and **VOL. ^ / V** buttons on the remote control.

Using the EQ (Equalizer)

Press **EQ/XDSS** repeatedly. The indicator lights up in the following order.

POP → CLASSIC → ROCK → JAZZ → VOCAL → SALSA → SAMBA → USER1 → USER2 → Off (No display) → POP...

- POP : Optimized for R&B, Soul and Country music.
- CLASSIC : Optimized for orchestral music.
- ROCK : Optimized for Hard Rock and Heavy Metal music.
- JAZZ : Sweet sound with soft feeling.
- VOCAL : Powerful realism with strong sound quality.
- SALSA : Reproduces salsa music acoustics.
- SAMBA : Reproduces samba music acoustics.
- USER1 : Use the menu to set the sound level you want.
- USER2 : Use the menu to set the sound level you want.

You can adjust each sound level to your preference. Once you select a USER mode and then make an adjustment, it automatically stored for the currently selected USER mode.

Refer to the "Adjusting the sound level" as shown below.

Adjusting the sound level

- 1 Press **MENU/SEL** repeatedly to select the mode you want to adjust from volume, bass, middle, treble, balance and fader.
The indicator lights up in the following order.
VOL → BAS → MID → TRB → BAL → FAD → VOL...
- 2 Rotate the **volume knob** on the control panel to adjust the sound quality. Or press **VOLUME** ^/∨ on the remote control.

Indication	Turn right	Turn left
VOL	Increase the volume level.	Decrease the volume level.
BAS	Increase the bass level.	Decrease the bass level.
MID	Increase the middle level.	Decrease the middle level.
TRB	Increase the treble level.	Decrease the treble level.
BAL	Decrease the level of the left speaker(s).	Decrease the level of the right speaker(s).
FAD	Decrease the level of the front speaker(s).	Decrease the level of the rear speaker(s).

Note

When EQ or XDSS+ is set to "Off", you can adjust the sound level (BAS, MID, TRB) settings.

Changing the general settings

- 1 Press and hold **MENU/SEL** on the control panel so that one of menu items appears.
- 2 Press **MENU/SEL** to scroll between menus .
AF ON → REG ON → TA ALARM → PI SOUND → AUX ON → AUX 0dB → DEMO OFF → BEEP 2ND → AF ON...
- 3 Rotate the **volume knob** clockwise or unclockwise to select one of the settings. (Or press **VOLUME** ^/∨ on the remote control.)
- The settings on the display window is completed and disappeared automatically after about 6 seconds.

- **AF(Alternative frequency) ON / OFF**

When the reception quality drops, the tuner automatically changes to another station in the network, broadcasting a better reception quality, using the PI and AF codes.

AF ON : Wherever you drive, you can continue to listen to the same program without interruptions.

AF OFF : Only station name will be displayed. In case of poor reception no alternative station can be used.

- **REG (Region) ON / OFF**

REG ON : The unit switches to another station, within the same network, broadcasting the same program when the receiving signals from the current station become weak.

REG OFF : The unit switches to another station, within the same network when the receiving signals from the current station become weak. (This mode, the program may differ from the one currently received.)

- **TA(Traffic Announcement) ALARM / SEEK**

TA ALARM : When a newly tuned station has no TP information for 5 seconds, a double beep sound is output.

TA SEEK : When the newly tuned station does not receive TP information for 5 seconds, the receiver retunes to the next station.

- **PI (Programme Identification) SOUND / MUTE**

PI SOUND : If the sound of a station with different PI is heard intermittently, the receiver mutes the sound after 1 second.

PI MUTE : If the sound of a station with different PI is heard intermittently, the receiver mutes the sound right now.

- **AUX (Auxiliary) ON / OFF**

It is possible to use auxiliary equipment with this unit. Activate the auxiliary setting when using auxiliary equipment connected to this unit.

AUX ON: When using a auxiliary equipment.

AUX OFF: When not using a auxiliary equipment.

- **AUX (Auxiliary) 0dB / +6dB**

You can adjust the volume level of each source to prevent radical changes in volume when switching between sources. You can set to 0 dB or +6 dB.

If the input level of the connected component is not high enough, increase the input level properly. Without adjusting the line input level, you may be surprised at a loud sound when you change the source from the external component to another source.

- **DEMO ON / OFF**

You can change the initial indication on the display to information name (function name, EQ name, etc...) while listen to a source.

DEMO ON: Displays information name while listen to source.

DEMO OFF: Cancels the function.

- **BEEP 2ND / ALL**

Sets the beep sound every time a button is pressed.

BEEP 2ND: The beep is generated when a key is long pressed. (1 sec)

BEEP ALL: The beep is generated when any key is pressed.

Radio operation

Listening to radio stations

- 1 Press **SOURCE (SRC)** on the remote control) to select the tuner.
- 2 Press **BAND** repeatedly to select a band.
The indicator lights up in the following order. FM1 → FM2 → FM3 → MW(AM)
- 3 **Auto Search** : Press **</>** (**◀/▶** on the remote control).
When a station is received, searching stops.
Manual Search : Press and hold **</>** (**◀/▶** on the remote control) until "MANUAL" appears, and then press it repeatedly.
The frequencies move up or down step by step.

Storing and recalling broadcast frequencies

You can easily store up to 6 broadcast frequencies for later recall at the touch of a button.

- 1 Press **BAND** to select desired band you want to store.
- 2 Select the desired frequency.
- 3 Press one of preset buttons 1~6 and hold until the beep sound.
The number you have pressed will be displayed in the preset number indicator and then remain lit. The selected radio station frequency has been stored in memory.
- 4 Repeat steps 1~3 to preset other stations.
The next time, you press the same preset button, the radio station frequency is recalled from the memory.

Note

- Up to 18 FM stations, 6 for each of three FM bands and 6 MW(AM) stations can be stored in the memory.
- When a new station is stored in the preset station button, the previously preset station is automatically erased.

Auto search memory

This function lets you automatically store the 6 strongest broadcast frequencies.

- 1 Press **AS**.
The six strongest broadcast frequencies will be stored under preset buttons 1~6 in the order of their signal strength.
- 2 To cancel, press **AS**.

To scan the preset stations

Press **PS**. Each preset station appears. To cancel, press **PS**.

To tune in the preset stations

Press **BAND** to select the desired band and press the desired preset buttons 1~6.

The preset station of the preset buttons 1~6 is displayed and the preset station is received.

RDS operation

RDS display options

In normal RDS operation the display will indicate the station name. Pressing **INFO** enables you to cycle through the various data types in the following sequence:

CT → FREQUENCY → PTY → RT → PS (When PS is receiving.)

CT → PTY → RT → FREQUENCY (When PS is not received.)

- **CT** (Time controlled by the channel)
- **RT** (Radio text recognition)
- **PI** (Programme Identification)
- **AF** (Alternative Frequencies for the actual programme)
- **TP** (Traffic programme Identification)
- **PTY** (Programme type recognition)
- **PS** (Programme Service name)
- **TA** (Traffic Announcement Identification)

PTY (Programme Type) function

To select a certain program type out of the reception band, the following procedure can be used.

- 1 Press and hold **TA/PTY** to select a programme types.
- 2 After, press and hold **TA/PTY** repeatedly for selecting each mode.
Music group → Speech group → Search off
- 3 Press one of preset buttons 1~6 repeatedly.
Each time this button is pressed, the display mode changes as follows.

No	Music group	No	Speech group
1.	POP M, ROCK M	1.	NEWS, AFFAIRS, INFO
2.	EASY M, LIGHT M	2.	SPORT, EDUCATE, DRAMA
3.	CLASSICS, OTHER M	3.	CULTURE, SCIENCE, VARIED
4.	JAZZ, COUNTRY	4.	WEATHER, FINANCE, CHILDREN
5.	NATION M, OLDIES	5.	SOCIAL, RELIGION, PHONE IN
6.	FOLK M	6.	TRAVEL, LEISURE, DOCUMENT

Note

RDS is only available for FM reception.

TA (Traffic Announcement Identification) function

TA function allows the unit to switch to traffic announcement (TA) from the current source. (Another FM station, CD, or other connected components.)

To switch the TA function on or off, press **TA/PTY**.

Note

- If TP indicator lights up, TRAFFIC reception is activated.
- TA reception will not work if you are listening to an AM (MW) station.

CD/MP3/WMA operation

Playing an Audio CD and MP3/WMA disc

The unit can play MP3/WMA formatted recordings on CD-ROM, CD-R or CD-RW discs. Before playing MP3/WMA recordings, read the notes on MP3/WMA Recordings on page 35. If you change the source, CD play also stops (without ejecting the CD). Next time you select "CD" as the source, CD play starts from where playback has been stopped previously.

Insert a disc in the unit and then "READING" appears in the display window, and playback starts automatically.

- To directly play a file, press **SEARCH** on remote control and then press the track number with **0-9** number.

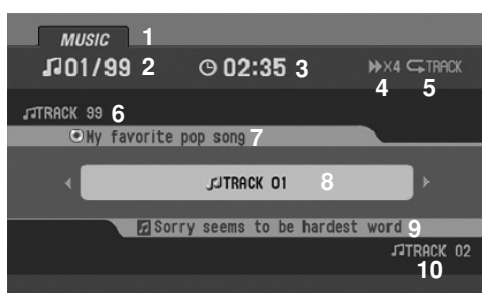

Audio CD mode



MP3/WMA mode

- | | |
|---|--|
| <ol style="list-style-type: none"> Media type indication tab
Audio CD is only displayed Music tab.
If the disc has photo or movie files, PHOTO tab and MOVIE tab is displayed. Current track number / Total track number Elapsed time Playback status (Play ►, Pause ■■, ►►X4, ►►X8, ◀◀X4, ◀◀X8) Current mode
(Repeat, Intro scan, Shuffle) Previous track name Album information in CD-TEXT Current track name | <ol style="list-style-type: none"> Title and artist information in CD-TEXT Next track name Moving to any other file
If you press BAND, you can change other mode.
(MUSIC→PHOTO→MOVIE→MUSIC...)
If there is only one type of file, "BAND" is not displayed. Previous file name MP3 WMA Current folder name MP3 WMA Current file name MP3 WMA ID3 TAG information MP3 WMA Next file name MP3 WMA |
|---|--|

Pause

- Press ► ■■ (■■ on the remote control) during playback.
- To return to playback, press ► ■■ (PLAY(►) or ■■ on the remote control).

Skip to next or previous track/file

During playback, press < or > (◀◀ or ►► on the remote control) to go to the next track/file or to return to the beginning of the current track/file.

Press briefly < (◀◀ on the remote control) within four seconds of playing time to go to the previous track/file.

Search

Press and hold </> (◀◀/▶▶ on the remote control) to select the required speed during playback and then release at the point you want.

Backward search: ◀◀X4 → ◀◀X8 → ▶, Forward search: ▶▶X4 → ▶▶X8 → ▶

Intro scan

The first 10 seconds of each tracks/files (**SCAN**) or each files in the current selected folder (■ **SCAN**) on the disc are played.

- 1 Press **SCAN**.
 - ■ **SCAN** (MP3 WMA) (or **SCAN** (ACD)) appears on the display window.
Press and hold **SCAN** for about 2 seconds during playback.
 - **SCAN** appears on the display window. (MP3 WMA)
- 2 Press **SCAN** again.
 - **SCAN** or ■ **SCAN** disappears from the display window and the intro scan is cancelled.

Repeat

The current selected tracks/files (**1 RPT**) or folder (■ **RPT**) on the disc is played repeatedly.

- 1 Press **RPT** during playback.
 - **1 RPT** appears on the display window. (ACD MP3 WMA)
- 2 Press and hold **RPT** for about 2 seconds during playback.
 - ■ **RPT** appears on the display window. (MP3 WMA)
- 3 Press **RPT** again.
 - **1 RPT** or ■ **RPT** disappears from the display window and the repeat mode is cancelled.

Shuffle

All of the tracks/files (**SHF**) or the current selected folder (■ **SHF**) on the disc is played randomly.

- 1 Press **SHF** during playback.
 - ■ **SHF** (MP3 WMA) (or **SHF** (ACD)) appears on the display window.
Press and hold **SHF** for about 2 seconds during playback.
 - **SHF** appears on the display window. (MP3 WMA)
- 2 Press **SHF** again.
 - **SHF** or ■ **SHF** disappears from the display window and the random playback is cancelled.

Note

During random playback, if you press < (I◀◀ on remote control), you won't go back to the previous track.

CD TEXT / ID3 TAG (ACD MP3 WMA)

When playing a disc containing information, you can see the CD TEXT/ID3 TAG information. In CD TEXT, information about the disc (disc title, performer and track title) is recorded.

In a ID3 TAG, information about the file (album title, performer name, song title) is recorded.

In a WMA Content, information about the file (song title, performer name) is recorded.

If there is no information, "NO TEXT" will be shown in the display window.

Press **INFO** repeatedly during MP3/WMA/CD TEXT file playback.

To skip to the next or previous folder MP3 WMA

(If there are more than two folders.)

Press **▲** (▲ on remote control) to skip to the next folder, and press **▼** (▼ on remote control) to skip to the previous folder.

Note

Time display appearing on the display part when playing VBR file may vary and there may be some difference from actual time (both progress time and VBR are displayed at the same time when playing file).

DISPLAY menu DVD VCD Movie







Displaying Disc information on-screen

You can display various information about the disc loaded on-screen.

1. Press **DISPLAY** during playback.
The displayed items differ depending on the disc type or playing status.
2. You can select an item by pressing **▲ / ▼** (▲/▼ on the remote control) and change or select the setting by pressing **</>** (◀▶ on the remote control) , **ENTER** or 0-9 number buttons.

Notes

- If any button is not pressed for a few seconds, the on-screen display disappears.
- Some discs may not provide all of the features on-screen display example shown below.

 ◀ 1/32 ▶	Title (Track):	Current title (or track) number/total number of titles (or tracks).
 1/61	Chapter:	Current chapter number/total number of chapters.
 0:00:20	Time:	Elapsed playing time.
 1 ENG  3/2 CH	Audio:	Selected audio language or channel.
 OFF	Subtitle:	Selected subtitle.
 1/1	Angle:	Selected angle/total number of angles.

SET UP menu

Initial Settings

By using the Setup menu, you can make various adjustments to items such as picture and sound. You can also set a language for the subtitles and the Setup menu, among other things. For details on each Setup menu item, see the pages 20 to 24.

- 1 Press **DVD SETUP** or press and hold **DISC MENU/SETUP** on the remote control. The Setup menu appears.
- 2 Use **▲/▼** (**▲/▼** on the remote control) to select the desired option then press **>** (**▶** on the remote control) to move to the second level.
The screen shows the current setting for the selected item as well as alternate setting(s).
- 3 Use **▲/▼** (**▲/▼** on the remote control) to select the second desired option then press **>** (**▶** on the remote control) to move to the third level.
- 4 Use **▲/▼** (**▲/▼** on the remote control) to select the desired setting then press **ENTER** to confirm your selection. Some items require additional steps.
- 5 Press **DVD SETUP (PLAY ▶)** or **RETURN** on the remote control) to exit the Setup menu. Or press and hold **DISC MENU/SETUP** on the remote control.

Note

Press **<** (**◀** on the remote control) to go back to the previous level.

LANGUAGE



Menu Language

Select a language for the Setup menu and on-screen display.

Disc Audio / Subtitle / Menu

Select the language you prefer for the audio track (disc audio), subtitles, and the disc menu.

Original : Refers to the original language in which the disc was recorded.

Other : To select another language, press numeric buttons and then **ENTER** to enter the corresponding 4-digit number according to the language code list on the page 34.

If you enter the wrong language code, input the 4-digit number and press any numeric button. When “- - -” appears on the screen, input the 4-digit number correctly.

DISPLAY



TV Aspect

16:9 :

Select when a 16:9 wide TV is connected.

4:3 Letter Box :

Select when a standard 4:3 TV is connected. Displays a wide picture with bands on the upper and lower portions of the screen.

4:3 Panscan :

Select when a standard 4:3 TV is connected. Automatically displays the wide picture on the entire screen and cuts off the portions that do not fit.

Note

In case of DivX file, TV Aspect of "4:3 Panscan" and "4:3 Letter Box" is the same.

B.L.E. (Black Level Expansion)

To select the black level of playback pictures. Set your preference and monitor's ability.

On: Expanded grey scale.

Off: Standard grey scale.

Note

The B.L.E. function works NTSC system only.

AUDIO

Each DVD disc has a variety of audio output options. Set the player's AUDIO options according to the type of audio system you use.



Dolby Digital / DTS / MPEG

Bitstream: Select "Bitstream" if you connect the Car DVD Receiver's DIGITAL OUT jack to an amplifier or other equipment with a Dolby Digital, DTS or MPEG decoder.

PCM (for Dolby Digital/ MPEG): Select when connected to a two-channel digital stereo amplifier. DVDs encoded in Dolby Digital or MPEG will be automatically downmixed to two-channel PCM audio.

Off (for DTS): If you select "Off", the DTS signal is not output through the DIGITAL OUT jack.

Dynamic Range Control (DRC)

With the DVD*1 format, you can hear a program's soundtrack in the most accurate and realistic presentation, thanks to digital audio technology. However, you may wish to compress the dynamic range of the audio output (the difference between the loudest sounds and the quietest ones). Then, you may listen to a movie at a lower volume without losing clarity of sound. Set DRC to On for this effect.

*1: Dolby Digital only

Lock (Parental Control)

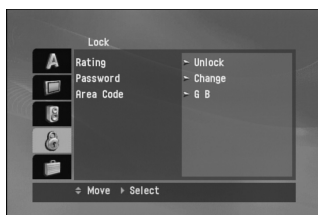

Rating

Some movies contain scenes that may not be suitable for children to view. Many of these discs contain parental control information that applies to the complete disc or to certain scenes on the disc. Movies and scenes are rated from 1 to 8, depending on the country. Some discs offer more suitable scenes as an alternative.

The parental control feature allows you to block access to scenes below the rating you input, thereby preventing your children from being able to view material you believe is unsuitable.

- 1 Select "Rating" on the Lock menu then press > (▶ on the remote control).
- 2 To access the Rating, Password and Area Code features, you must input the 4-digit security code you created. If you have not yet entered a security code you are prompted to do so.

Input a 4-digit code and press **ENTER**. Enter it again and press **ENTER** to verify.
If you make a mistake before pressing **ENTER**, press < (◀ on the remote control).

- 3 Select a rating from 1 to 8 using the ▲/▼ (▲/▼ on the remote control).

Rating 1-8

Rating one (1) has the most restrictions and rating eight (8) is the least restrictive.

Unlock

If you select unlock, parental control is not active and the disc plays in full.

4. Press **ENTER** to confirm your rating selection.

Note

If you set a rating for the player, all disc scenes with the same rating or lower are played. Higher rated scenes are not played unless an alternate scene is available on the disc. The alternative must have the same rating or a lower one. If no suitable alternative is found, playback stops. You must enter the 4-digit password or change the rating level in order to play the disc.

Password

You can enter or change password.

1. Select Password on the Lock menu and then press > (▶ on the remote control).

2. To make a new password:

Press **ENTER** when the "New" option is highlighted. Enter a new password using the numerical buttons then press **ENTER**. Enter the password again to verify.

To change the password:

Press **ENTER** when the "Change" option is highlighted. Enter a current password using the numbered buttons then press **ENTER**. Enter a new password using the numbered buttons then press **ENTER**. Enter the password again to verify.

If you forget your password

If you forget your password you can clear it using the follow steps.

1. Press **DVD SETUP** (Press and hold **DISC MENU/SETUP** on the remote control) to display the Setup menu.
2. Input the 6-digit number "210499" and the password is cleared.
3. Enter a new code as described above.

Area code

Enter the code of the area whose standards were used to rate the DVD video disc, according to the area code list on the page 34.

1. Select "Area Code" on the Lock menu then press > (▶ on the remote control).
2. Follow the step 2 as shown on the page 23 (Rating).
3. Select the first character using ▲/▼ (▲/▼ on the remote control).
4. Press **ENTER** and select the second character using ▲/▼ (▲/▼ on the remote control).
5. Press **ENTER** to confirm your area code selection.

Others

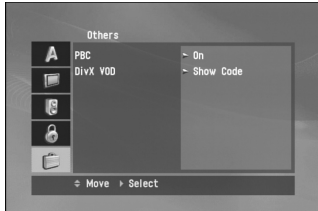

PBC

Set Playback Control (PBC) to On or Off.

On: Video CDs with PBC are played according to the PBC.

Off: Video CDs with PBC are played in the same way as Audio CDs.

DivX VOD

We provide you the DivX® VOD (Video On Demand) registration code that allows you to rent and purchase videos based on the DivX® VOD service. For more information, visit www.divx.com/vod.

- 1 Select "DivX VOD" option and then press > (▶ on the remote control).
- 2 Press **ENTER** while "Show Code" is selected and the registration code will appear. Use the registration code to purchase or rent the videos from DivX® VOD service at www.divx.com/vod. Follow the instructions and download the video onto a disc for playback on this unit.
- 3 Press **ENTER** to exit.

Note

All the downloaded videos from DivX® VOD can only be played on this unit. (Page 35)

DVD/VCD operation

Playing a DVD and Video CD

Insert a disc in the unit.

"READING" appears on the display window, and playback starts automatically.

If playback does not start, press ▶ || (PLAY▶) on the remote control).

In some cases, the disc menu might appear instead.

TIP

- **Auto reloading**

If any button is not pressed after a disc is ejected, a disc is loaded automatically in about 10 seconds.

- **If a menu screen is displayed**

The menu screen may be displayed first after loading a DVD or Video CD 2.0 which offers a menu.

DVD

Use ▲/▼/◀/▶ (▲/▼/◀/▶ on the remote control) to select the title/chapter you want to view, then press **ENTER** to start playback.

Press **DISC MENU** (DISC MENU/SETUP on the remote control) to return to the menu screen.

VCD

Use the numeric buttons to select the track you want to view.
Press **DISC MENU/SET UP** or **RETURN** on the remote control to return to the menu screen. Menu settings and operating procedures may differ. Follow the instructions on the each menu screen. You also may set PBC to On under setup. See the page 24.

✦ Notes

- If parental control is set and the disc is not within the rating settings you must input the password. (See “Lock” menu on the page 22-23).
- DVDs may have a region code. Your player does not play discs that have a different region code from your player. Refer to the main label on the upper part of the unit.

Pre-Stop

1. Press **STOP** (■) on the remote control during playback.
“■■■” appears in the display window.
2. To return to playback, if you press ► **II** (PLAY►) on the remote control) on the Pre-Stop mode, it will be played from this point you stop.

Stop

1. Press **STOP** (■) on the Pre-Stop mode.
2. To return to playback, if you press ► **II** (PLAY►) on the remote control), it will be played from the first point of the disc.

Pause

1. Press ► **II** (II on the remote control) during playback.
2. To return to playback, press ► **II** (PLAY►) on the remote control).

Still picture and frame-by-frame playback

1. Press ► **II** (II on the remote control) during playback.
The unit will now go into the PAUSE mode.
2. You can advance the picture frame-by-frame by pressing **II** repeatedly on the remote control.
3. To return normal playback, press ► **II** (PLAY►) on the remote control).

Slow motion

1. Press ► **II** (II on the remote control) during playback.
The unit will now go into the PAUSE mode.
2. Use **SCAN/SLOW** ◀◀/▶▶ on the remote control to select the required speed: ◀◀ 1/16, ◀◀ 1/8, ◀◀ 1/4, or ◀◀ 1/2 (backward), or ▶▶ 1/16, ▶▶ 1/8, ▶▶ 1/4, or ▶▶ 1/2 (forward).
With a Video CD, the Slow speed changes: ▶▶ 1/16, ▶▶ 1/8, ▶▶ 1/4 or ▶▶ 1/2 (forward).
3. To exit Slow Motion mode, press ► **II** (PLAY►) on the remote control).

✦ Note

Slow motion playback in reverse is not possible with Video CDs.

Moving to another TITLE DVD

When a disc has more than one title, you can move to another title as follows:

1. Press **DISPLAY** and then press **▲/▼** (▲/▼ on the remote control).
2. Press the appropriate numbered button (0-9) to select a title number.

Moving to another CHAPTER/TRACK

When a title on a disc has more than one chapter or a disc has more than one track, you can move to another chapter/track as follows:

- Press **</>** (**I◀▶I** on the remote control) briefly during playback to select the next chapter/track or to return to the beginning of the current chapter/track.
- Press **<** (**I◀◀** on the remote control) twice briefly to step back to the previous chapter/track.
- To go directly to any chapter during playback, press **DISPLAY** and press **▲/▼** (**▲/▼** on the remote control) to select the chapter/track icon. Then, input the chapter/track number or use **</>** (**I◀▶I** on the remote control).

Note

- For two-digit numbers, press the numbered buttons (0-9) in rapid succession.
- On a Video CD with PBC, you must set PBC to Off on the setup menu

Search

1. Press **SCAN/SLOW** (**◀▶**) briefly on the remote control during playback.
The unit will now go into SEARCH mode.
2. Press **SCAN/SLOW** (**◀▶**) repeatedly to select the required speed: **◀◀X2**, **◀◀X4**, **◀◀X8**, **◀◀X16**, **◀◀X32**, **◀◀X100** (backward) or **▶▶X2**, **▶▶X4**, **▶▶X8**, **▶▶X16**, **▶▶X32**, **▶▶X100** (forward).
With a Video CD, the Search speed changes: **◀◀X2**, **◀◀X4**, **◀◀X8**, (backward) or **▶▶X2**, **▶▶X4**, **▶▶X8**, (forward).
3. To return normal playback, press **▶ II** (**PLAY▶**) on the remote control).

Repeat

DVD Video Discs - Repeat Off/Chapter/Title

1. To repeat the currently playing chapter, press **RPT (REPEAT)** on the remote control).
The Repeat "Chapter" icon appears on TV the screen.
2. To repeat the title currently playing, press **RPT (REPEAT)** on the remote control) again.
The Repeat "Title" icon appears on the TV screen.
3. To exit the Repeat mode, press **RPT (REPEAT)** on the remote control) again.
The Repeat "Off" icon appears on the TV screen.

Video CDs - Repeat All/Track

1. To repeat the track currently playing, press **RPT (REPEAT)** on the remote control).
The Repeat "Track" icon appears on the TV screen.
2. To exit Repeat mode, press **RPT (REPEAT)** on the remote control) again.
The Repeat "All" icon appears on the TV screen.

Note

On a Video CD with PBC, you must set PBC to Off on the setup menu to use the repeat function. (See "PBC" on the page 24.)

Time search

The Time Search function allows you to start playing at any chosen time on the disc.

1. Press **DISPLAY** during playback. The on-screen display appears on the screen. The Time Search box shows the elapsed playing time of the current disc.
2. Within 10 seconds, press **▲/▼** (▲/▼ on the remote control) to select the Time Search icon in the on-screen display. The “-:-:--” appears in the Time Search box.
3. Within 10 seconds, use the number buttons to enter the required start time. Enter hours, minutes, and seconds from left to right in the box.
4. Within 10 seconds, press **ENTER** to confirm the start time. Playback starts from the selected time on the disc. If you enter an invalid time, playback will continue from the current point.

Note

On a Video CD with PBC, you must set PBC to Off on the setup menu to use the time search function. (See “PBC” on the page 24.)

Checking the contents of DVD Video discs: Menus

DVDs may offer menus that allow you to access special features. To use the disc menu, press **DISC MENU** (**DISC MENU/SET UP** on the remote control).

Or Use **▲/▼/◀/▶** (▲/▼/◀/▶ on the remote control) to highlight your selection, then press **ENTER**.

Disc menu DVD

1. Press **DISC MENU** (**DISC MENU/SET UP** on the remote control). The disc menu is displayed.
2. To remove the disc menu, press **DISC MENU** (**DISC MENU/SET UP** on the remote control) again.

Camera angle DVD

If the disc contains scenes recorded at different camera angles, you can change to a different camera angle during playback.

Press **ANGLE** repeatedly on the remote control during playback to select a desired angle.

The number of the current angle appears on the display.

Changing the audio language DVD

Press **AUDIO** repeatedly on the remote control during playback to hear a different audio language or audio track.

Changing the audio channel VCD

Press **AUDIO** repeatedly during playback to hear a different audio channel (Stereo, Left, or Right).

Subtitles DVD

Press **SUBTITLE** repeatedly on the remote control during playback to see the different subtitle languages.

Note

If the icon  appears, the feature is not available on the disc.

ZOOM

The Zoom function allows you to enlarge the video image.

Press **ZOOM** on the remote control repeatedly during playback or in the pause mode.

- DVD : 100% → 400% → 1600% → 100%..., Video CD : 100% → 400% → 100%...

You can move through the zoomed picture using ◀/▶/▲/▼ buttons.

Note

The zoom function may not work for some discs.

Photo operation

JPEG/TIFF disc compatibility with this player is limited as follows:

- Depending upon the size and the number of JPEG/TIFF files, it could take a long time for this unit to read the disc's contents. If you do not see an on-screen display after several minutes, some of the files may be too large — reduce the resolution of the JPEG/TIFF files to less than 2M pixels as 2760 x 2048 pixels and burn another disc.
- The total number of files on the disc should be less than 3000.
- Some discs may not operate due to a different recording format or the condition of disc.
- Ensure that all the selected files have the ".jpg" or ".tiff" extensions when copying into the disc.
- If the files have ".jpe" or ".jpeg" extensions, please rename them as ".jpg" file.
- File names without ".jpg" or ".Tiff" extension will not be able to be read by this unit even though the files are shown as JPEG or TIFF image files in Windows Explorer.
- Some JPEG/TIFF files may not operate due to a different encoding format or the condition of disc.

Viewing a photo file

This unit can play discs with JPEG or TIFF files.

Insert a disc in the unit "READING" appears on the display window, and slide show starts automatically.

TIPS

On a CD with MP3/WMA, JPEG and movie file, you can switch the MUSIC, PHOTO and MOVIE menu. Press **BAND**, and MUSIC, PHOTO and MOVIE word on top of the menu is highlighted. Select "PHOTO" and then press PLAY(▶) on the remote control to play the JPEG file.

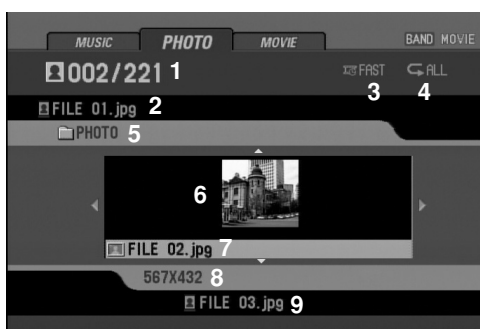

1. Current file number / Total file number
2. Previous file
3. Slide show interval time
(Slow, Normal, Fast, off)
4. Repeat mode
5. Current folder name
6. Thumbnail image
7. Current file name
8. Resolution
9. Next file name

Moving to another folder

Press **▲/▼** (▲/▼ on the remote control) to select the previous or next folder in the disc.

Moving to another file

Press **◀/▶** (◀/▶ on the remote control) to select the previous or next file in the selected folder.

Slide show interval time

Press **◀◀/▶▶** on the remote control to select the option you want to use.

It shows the slide show interval time: FAST → OFF → SLOW → NORMAL → FAST...
(FAST: 3sec, NORMAL: 8sec, SLOW: 13sec)

Repeat

Press **RPT (REPEAT)** on the remote control) to select the option you want to use.

There are two repeat mode: ALL or FOLDER.

- ALL: Plays repeatedly on the disc.
- FOLDER: Plays repeatedly on the current folder.

Viewing slide shows

On a CD with MP3/WMA, JPEG and movie file, you can switch the MUSIC, PHOTO and MOVIE menu. Press **BAND**, and MUSIC, PHOTO and MOVIE word on top of the menu is highlighted. Select "PHOTO" and then press **▶ || (PLAY▶)** or ENTER on the remote control) to play the photo file. To return to the photo menu, press **DISC MENU (STOP ■)** on the remote control.)

✦ Note

Press DISPLAY to appear or disappear the HELP-BAR during viewing the slide show.

Viewing still picture

1. Press **▶ || (||)** on the remote control) during the slide show.
The player will now go into the pause mode.
2. To return to the slide show, press **▶ || (PLAY▶)** on the remote control).

Zoom

During watching pictures, press **ZOOM** to enlarge the video image (3 steps).
You can move through the zoomed picture using **▲/▼/◀/▶** (▲/▼/◀/▶ on the remote control).
To cancel the zoom mode, press **PLAY▶** on the remote control.

✦ Note

The zoom function may not work in case that the size of file is small.

Rotating the picture

During watching pictures, press **▲/▼** (▲/▼ on the remote control) during showing a picture to rotate the picture clockwise or counter clockwise.

Movie operation

DivX disc compatibility with this player is limited as follows:

- Available resolution size of the DivX file is under 720x576 (W x H) pixel.
- The file name of the DivX subtitle is available by 25 characters.
- If the number of the screen frame is over 30 per 1 second, this unit may not operate normally.
- If the video and audio structure of recorded file are not interleaved, either video or audio is outputted.

- Playable Subtitle format : SubRip(*.srt), SAMI(*.smi), SubStation Alpha(*.ssa), MicroDVD(*.sub), SubViewer, 2.0(*.sub), TMPlayer(*.txt), DVD Subtitle System(*.txt), Advanced Substation Alpah(*.ass)
- Playable Codec format : DivX3.x, DivX4.x, DivX5.x (*.avi, *.divx, *.div), MP4S (*.asf), Xvid (*.avi, *.xvid)
- Playable Audio format : "Dolby Digital", "MP3"
- Sampling frequency: 48 kHz (Dolby Digital (AC-3)), within 8 - 48 kHz (MP3)
- Bit rate: 64-640 kbps (Dolby Digital (AC-3)), within 8 - 320 kbps (MP3)

Playing a movie file

This unit can play discs with movie files.

Insert a disc in the unit “READING” appears on the display window, and playback starts automatically.

TIPS

On a CD with MP3/WMA, JPEG and movie file, you can switch the MUSIC, PHOTO and MOVIE menu. Press **BAND**, and MUSIC, PHOTO and MOVIE word on top of the menu is highlighted. Select “MOVIE” and then press PLAY(▶) on the remote control to play the movie file.

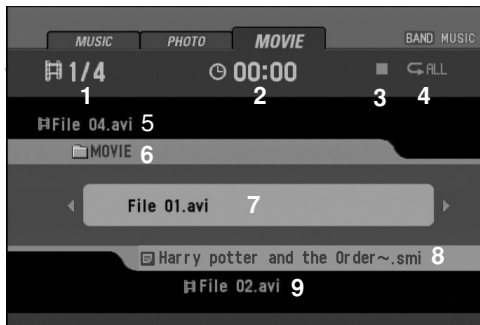

1. Current file number / Total file number
2. Elapsed time
3. Playback status
(Pre-stop ■■■, stop ■)
4. Repeat mode
5. Previous file name
6. Current folder name
7. Current file name
8. Subtitle file name
9. Next file name

Pre-Stop

1. Press **STOP** (■) on the remote control during playback.
“■■■” appears in the display window and the movie menu appears on the screen.
2. To return to playback, if you press ▶ ■■ (PLAY▶) on the remote control) on the Pre-Stop mode, it will be played from this point you stop.

Stop

1. Press **STOP** (■) on the Pre-Stop mode.
2. To return to playback, if you press ▶ ■■ (PLAY▶) on the remote control), it will be played from the first point of the current file.

Pause

1. Press ▶ ■■ (■■ on the remote control) during playback.
2. To return to playback, press ▶ ■■ (PLAY▶) on the remote control).

Still picture and frame-by-frame playback

1. Press **▶ || (||)** on the remote control) during playback.
The unit will now go into the PAUSE mode.
2. You can advance the picture frame-by-frame by pressing **||** repeatedly on the remote control.
3. To return normal playback, press **▶ || (PLAY▶)** on the remote control).

Slow motion

1. Press **▶ || (||)** on the remote control) during playback.
The unit will now go into the PAUSE mode.
2. Use **▶▶** on the remote control to select the required speed: **▶▶ 1/16**, **▶▶ 1/8**, **▶▶ 1/4**, or **▶▶ 1/2** (forward).
3. To exit Slow Motion mode, press **▶ || (PLAY▶)** on the remote control).

Note

Slow motion playback in reverse is not possible with movie file.

Search

1. Press **SCAN/SLOW ◀▶** on the remote control during playback.
The unit will now go into SEARCH mode.
2. Press **◀▶** repeatedly on the remote control to select the required speed:
◀◀X2, **◀◀X4**, **◀◀X16**, **◀◀X32** (backward) or **▶▶X2**, **▶▶X4**, **▶▶X16**, **▶▶X32** (forward).
3. To return normal playback, press **▶ || (PLAY▶)** on the remote control).

Skip

- Press **</> (I◀▶I)** on the remote control) during playback to go to the next chapter/track or to return to the beginning of the current chapter/track.
- Press **< (I◀◀)** on the remote control) within four seconds of playing time to go to the previous chapter/track.
- To go directly to any file on the movie menu, press **SEARCH** and then press the track number you want with numeric buttons (0-9).

Repeat

All files or the folder on the disc is played repeatedly.

The default settings is "All".

- To repeat all files of the disc, press **RPT (REPEAT)** on the remote control) again during playback.
The "All" icon appears on the TV screen.
- To repeat the current file, press **RPT (REPEAT)** on the remote control) once again during playback.
The "File" icon appears on the TV screen.

Time search

The Time Search function allows you to start playing at any chosen time on the file.

1. Press **DISPLAY** during playback. The on-screen display appears on the screen.
The Time Search box shows the elapsed playing time of the current disc.
2. Within 10 seconds, press **▲/▼** (▲/▼ on the remote control) to select the Time Search icon in the on-screen display.
The “:--:--” appears in the Time Search box.
3. Within 10 seconds, use the number buttons to enter the required start time. Enter hours, minutes, and seconds from left to right in the box.
4. Within 10 seconds, press **ENTER** to confirm the start time.
Playback starts from the selected time on the file. If you enter an invalid time, playback will continue from the current point.

Changing the audio language

Press **AUDIO** repeatedly on the remote control during playback to hear a different audio language or audio track.

Subtitles

Press **SUBTITLE** repeatedly on the remote control during playback to see the different subtitle languages.

Note

If the icon  appears, the feature is not available on the file.

Notice for displaying the DivX subtitle

If the subtitle does not display properly during playback, press and hold **SUBTITLE** for about 3 seconds then press **SUBTITLE** to select another language code until the subtitle is displayed properly.

Note

If the subtitle setup menu does not have the DivX subtitle language that you are going to play, the subtitle language may not be displayed properly.

AUX operation

Playing an auxiliary equipment

1. Connect the **AUX IN** connector of this unit to the **LINE OUT** connector of the auxiliary equipment using the corresponding cable.

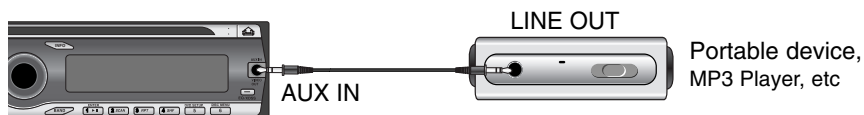

2. Press **SOURCE (SRC)** on the remote control until “AUX IN” appears on the display window.
3. Turn on the connected Auxiliary Equipment and start playing the source.
4. Adjust the volume.

Troubleshooting

Sy : Symptom , **Ca** : Cause, **Co** : Correction

Sy **Power doesn't turn on. / The unit doesn't operate.**

- Ca** Leads and connector are not properly connected.
- Co** Confirm once more that all connections are correct.
- Ca** The fuse is blown.
- Co** Rectify the problem that caused the fuse to blow, and then replace it. Be very sure to install the correct fuse with the same rate.
- Ca** Noise and other factors are causing the built-in microprocessor to operate incorrectly.
- Co** Turn the unit off and then on.

Sy **The unit does not operate correctly even when the appropriate remote control buttons are pressed.**

- Ca** Battery power is low.
- Co** Load new battery.
- Ca** Some operations with certain discs are prohibited.
- Co** Check with another disc.

Sy **Playback is not possible.**

- Ca** The disc is dirty.
- Co** Clean disc.
- Ca** The loaded disc is of a type this unit cannot play.
- Co** Check what type the disc.

Sy **No sound is heard. / The volume level will not rise.**

- Ca** Cables are not connected correctly.
- Co** Connect the cables correctly.

Sy **There's no picture.**

- Ca** The parking brake cord is not connected.
- Co** Connect a parking brake cord, and apply the parking brake.

Sy **The icon  is displayed, and operation is not possible.**

- Ca** The operation is prohibited for the disc.
- Co** This operation is not possible.
- Ca** The operation is not compatible with the disc's organization.
- Co** This operation is not possible.

Sy **The picture stops (pauses) and the unit cannot be operated.**

- Ca** Reading of data has become impossible during playback.
- Co** After pressing  once, start playback once more.

Sy **There's no sound.**

- Ca** The volume level is low.
- Co** Adjust the volume.

Sy **There's audio and video skipping.**

- Ca** This unit is not firmly secured.
- Co** Secure this unit firmly.

Sy **The picture is stretched, the aspect is incorrect**

- Ca** The aspect setting is incorrect for the display.
- Co** Select the appropriate setting for your display.

Language Code List

Enter the appropriate code number for the initial settings “Disc Audio”, “Disc Subtitle” and/or “Disc Menu” (See page 20).

Language	Code	Language	Code	Language	Code	Language	Code
Abkhazian	6566	Fiji	7074	Lingala	7678	Singhalese	8373
Afar	6565	Finnish	7073	Lithuanian	7684	Slovak	8375
Afrikaans	6570	French	7082	Macedonian	7775	Slovenian	8376
Albanian	8381	Frisian	7089	Malagasy	7771	Somali	8379
Ameharic	6577	Galician	7176	Malay	7783	Spanish	6983
Arabic	6582	Georgian	7565	Malayalam	7776	Sudanese	8385
Armenian	7289	German	6869	Maltese	7784	Swahili	8387
Assamese	6583	Greek	6976	Maori	7773	Swedish	8386
Aymara	6588	Greenlandic	7576	Marathi	7782	Tagalog	8476
Azerbaijani	6590	Guarani	7178	Moldavian	7779	Tajik	8471
Bashkir	6665	Gujarati	7185	Mongolian	7778	Tamil	8465
Basque	6985	Hausa	7265	Nauru	7865	Tatar	8484
Bengali; Bangla	6678	Hebrew	7387	Nepali	7869	Telugu	8469
Bhutani	6890	Hindi	7273	Norwegian	7879	Thai	8472
Bihari	6672	Hungarian	7285	Oriya	7982	Tibetan	6679
Breton	6682	Icelandic	7383	Panjabi	8065	Tigrinya	8473
Bulgarian	6671	Indonesian	7378	Pashto, Pushto	8083	Tonga	8479
Burmese	7789	Interlingua	7365	Persian	7065	Turkish	8482
Byelorussian	6669	Irish	7165	Polish	8076	Turkmen	8475
Cambodian	7577	Italian	7384	Portuguese	8084	Twi	8487
Catalan	6765	Japanese	7465	Quechua	8185	Ukrainian	8575
Chinese	9072	Javanese	7487	Rhaeto-Romance	8277	Urdu	8582
Corsican	6779	Kannada	7578	Rumanian	8279	Uzbek	8590
Croatian	7282	Kashmiri	7583	Russian	8285	Vietnamese	8673
Czech	6783	Kazakh	7575	Samoan	8377	Volapük	8679
Danish	6865	Kirghiz	7589	Sanskrit	8365	Welsh	6789
Dutch	7876	Korean	7579	Scots Gaelic	7168	Wolof	8779
English	6978	Kurdish	7585	Serbian	8382	Xhosa	8872
Esperanto	6979	Laothian	7679	Serbo-Croatian	8372	Yiddish	7473
Estonian	6984	Latin	7665	Shona	8378	Yoruba	8979
Faroese	7079	Latvian, Lettish	7686	Sindhi	8368	Zulu	9085

Area Code List

Enter the appropriate code number for the initial setting “Area Code” (See page 23).

Area	Code	Area	Code	Area	Code	Area	Code
Afghanistan	AF	Ethiopia	ET	Malaysia	MY	Saudi Arabia	SA
Argentina	AR	Fiji	FJ	Maldives	MV	Senegal	SN
Australia	AU	Finland	FI	Mexico	MX	Singapore	SG
Austria	AT	France	FR	Monaco	MC	Slovak Republic	SK
Belgium	BE	Germany	DE	Mongolia	MN	Slovenia	SI
Bhutan	BT	Great Britain	GB	Morocco	MA	South Africa	ZA
Bolivia	BO	Greece	GR	Nepal	NP	South Korea	KR
Brazil	BR	Greenland	GL	Netherlands	NL	Spain	ES
Cambodia	KH	Heard and McDonald Islands	HM	Netherlands Antilles	AN	Sri Lanka	LK
Canada	CA	Hong Kong	HK	New Zealand	NZ	Sweden	SE
Chile	CL	Hungary	HU	Nigeria	NG	Switzerland	CH
China	CN	India	IN	Norway	NO	Taiwan	TW
Colombia	CO	Indonesia	ID	Oman	OM	Thailand	TH
Congo	CG	Israel	IL	Pakistan	PK	Turkey	TR
Costa Rica	CR	Italy	IT	Panama	PA	Uganda	UG
Croatia	HR	Jamaica	JM	Paraguay	PY	Ukraine	UA
Czech Republic	CZ	Japan	JP	Philippines	PH	United States	US
Denmark	DK	Kenya	KE	Poland	PL	Uruguay	UY
Ecuador	EC	Kuwait	KW	Portugal	PT	Uzbekistan	UZ
Egypt	EG	Libya	LY	Romania	RO	Vietnam	VN
El Salvador	SV	Luxembourg	LU	Russian Federation	RU	Zimbabwe	ZW

Reference

Playing DivX® VOD content

Some DivX® VOD (video on demand) content may only be playable a fixed number of times.

When you load a disc containing this type of DivX® VOD content, the remaining number of plays is shown on-screen and you then have the option of playing the disc (thereby using up one of the remaining plays), or stopping. If you load a disc that contains expired DivX® VOD content (for example, content that has zero remaining plays), **Rental expired** is displayed.

- If your DivX® VOD content allows an unlimited number of plays, then you may load the disc into your player and play the content as often as you like, and no message will be displayed.
- In order to play DivX® VOD content on this unit, you first need to register the unit with your DivX® VOD content provider. About your registration, refer to www.divx.com/vod.
- DivX® VOD content is protected by a DRM (Digital Rights Management) system. This restricts playback of content to specific, registered devices.

MP3/WMA Disc compatibility with this unit is limited as follows:

1. Sampling Frequency / 8 - 48kHz (MP3) 22.05 - 48kHz (WMA)
2. Bit rate / within 8 - 320kbps (include VBR) (MP3) 32 - 320kbps (WMA)
3. CD-R/CD-RW file system should be "ISO 9660".
4. If you record MP3/WMA files using software which cannot create a FILE SYSTEM, for example "Direct-CD" etc., it will not be possible to playback MP3/WMA files. We recommend that you use "Easy-CD Creator" which creates an ISO9660 file system.
5. The total number of files or folders on the disc should be less than 99 (Audio CD), 3000 (MP3/WMA) and 251 (FOLDER).

Customers should also note that permission is required in order to download MP3/WMA files and music from the Internet. Our company has no right to grant such permission. Permission should always be sought from the copyright owner.

Specifications

GENERAL

Output Power	.50W x 4CH (Max.)
Power Source	.DC 12V
Speaker impedance	.4 Ω
Ground System	.Negative
Dimensions (W x H x D)	.178 x 50 x 197.2 mm (Without Front Panel)
Net Weight	.1.7 kg

CD/DVD/VCD SECTION

Frequency Response	.20 Hz-20 kHz
S/N Ratio	.85 dB
Distortion	.0.07 %

RADIO SECTION

FM

Frequency Range	.87.5-108.0 MHz
S/N Ratio	.53 dB
Distortion	.0.7 % (60dB μ), 1.0% (100dB μ)
Usable Sensitivity	.12 dB μ V

MW (AM)

Frequency Range	.522-1620 kHz
S/N Ratio	.45 dB
Distortion	.1.0 % (74dB μ), 1.5% (100dB μ)
Usable Sensitivity	.28 dB μ V

AUX SECTION

Frequency Response	.20 Hz-20 kHz
S/N Ratio	.80 dB
Distortion	.0.07 %
Max Input Level (1kHz)	.1.2 V (35 K Ω)