



LCD TV | PLASMA TV OWNER'S MANUAL

LCD TV MODELS

32LC2R*
37LC2R*
42LC2R*
32HIZ20
37HIZ20
42HIZ20
32HIZ22
37HIZ22
42HIZ22

PLASMA TV MODELS

42PC1R*
42PC3R*
50PC1R*

Please read Information Manual included together before reading this manual and operating your set.

Retain it for future reference.

Record model number and serial number of the set.

See the label attached on the back cover and quote this information to your dealer when you require service.

P/NO: 38289U0025U (0712-REV01)

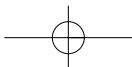
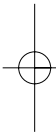
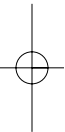
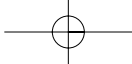

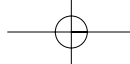

ACCESSORIES

Ensure that the following accessories are included with your TV. If an accessory is missing, please contact the dealer where you purchased the product.

ACCESSORIES

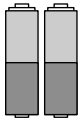

Batteries



Remote Control



Power Cord

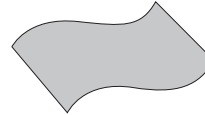

Polishing Cloth
Polish the screen with the cloth
(Option)

* Slightly wipe stained spot on the exterior only with the cleansing cloths for the product exterior if there is stain or fingerprint on surface of the exterior. Do not wipe roughly when removing stain. Please be cautious of that excessive power may cause scratch or discoloration.

For 42PC1R*, 50PC1R*, 42PC3R*



2-Wall brackets



2-eye-bolts



2-bolts for stand assembly
(Refer p.11)

This feature is not available for all models.

For 32/37/42LC2R*, 37HIZ20, 42HIZ20, 37HIZ20, 42HIZ20, 32HIZ22, 37HIZ22, 42HIZ22



2-TV brackets
2-Wall brackets



Twister Holder
Arrange the wires with the twister holder.



Cable Management



2-bolts

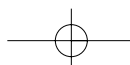

CONTENTS

CONTENTS

ACCESSORIES1

INTRODUCTION

Controls / Connection Options 4-8
 Remote Control Key Functions/
 Installing Batteries 9-10

INSTALLATION

Unfolding The Base Stand11
 Basic Connection /
 How to Remove the Cable Management12-13
 How to join the product assembly to the wall
 to protect the set tumbling14
 Stand Installation15

CONNECTIONS & SETUP

Antenna Connection16
 VCR Setup17-18
 External Equipment Connections19
 DVD Setup20-21
 STB(SET-TOP BOX) Setup22-23
 PC Setup24-26
 TURNING THE TV ON27

SPECIAL FUNCTIONS

PIP (Picture-In-Picture) / Double Window / POP

Watching PIP/Double Window/POP28
 Programme Selection for Sub Picture28
 Input Source Selection for Sub Picture29
 Sub Picture Size Adjustment (PIP mode only)29
 Moving the Sub Picture (PIP mode only) . . .29
 Adjusting PIP Transparency (PIP mode only) 29
 Swapping between main and sub pictures . . .30
 POP
 (Picture-out-of-Picture: Programme Scan) . . .30

Teletext

Teletext Language Selection(Option) 31
 Switch on/off 31
 SIMPLE Text 31
 TOP Text 32
 FASTEXT 32
 Special Teletext Functions33

TV MENU

On Screen Menus Selection and Adjustment34

Setting up TV stations

Auto programme tuning35
 Manual programme tuning36
 Fine tuning37
 Assigning a station name38
 Booster (Option)39
 Programme edit40
 Favourite programme41
 Calling the programme table42

Picture Menu

PSM (Picture Status Memory)43
 Picture Adjustment (PSM-User option)44
 CSM (Colour Status Memory)45
 Manual Colour Temperature Control
 (CSM - User option)46
XD Function47
 Advanced48
 Reset49

Sound Menu

SSM (Sound Status Memory)50
 Sound Frequency Adjustment
 (SSM - User option)51
 AVL (Auto Volume Leveler)52
 Balance Adjustment52
 Speaker53
 Stereo/Dual Reception54
 NICAM Reception55
 Speaker Sound Output Selection55

Time Menu

Clock Setup56
 On/Off Time57
 Auto Sleep58
 Sleep Timer59

Special Menu

Child Lock60
 ISM (Image Sticking Minimization)
 Method (Option)61
 Low Power (Option)62
 XD Demo62

TV MENU

Screen Menu

Auto Configure (RGB [PC] mode only)	63
Manual Configure	64
Setting the Picture Format	65-66
Selecting Wide VGA/XGA mode	67
Initializing (Reset to original factory settings)	67

APPENDIX

External Control Device Setup	68-74
IR Codes	75
Remote control IR codes	76
Programming the Remote	77
Programming code	78-79
Troubleshooting Checklist	80-81
Maintenance	82
Product Specifications	83-84

INTRODUCTION

CONTROLS

This is the front panel of models 42/50PC1R* TVs.

- This is a simplified representation of a front panel. Here shown may be somewhat different from your TV.

Front Panel Controls

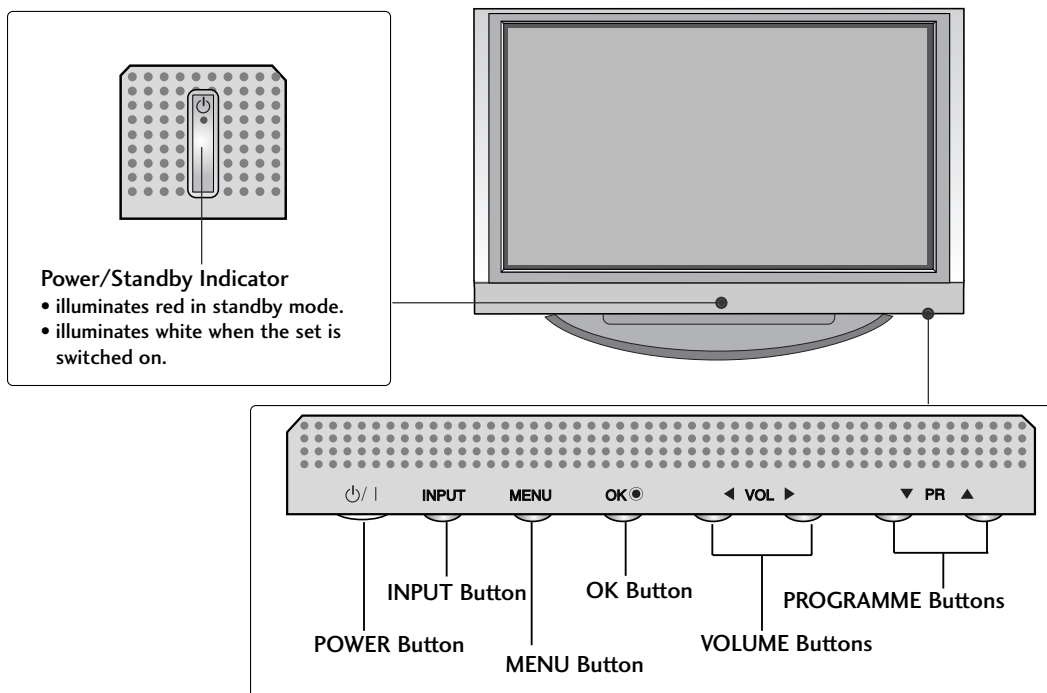

This is the front panel of models 42PC3R* TVs.

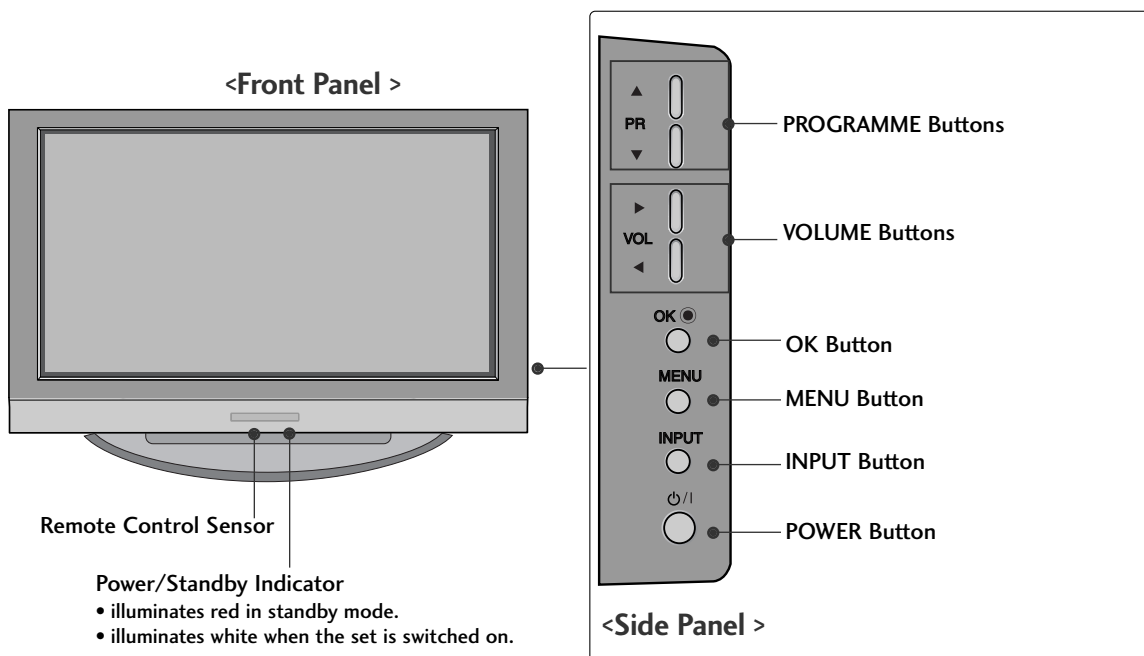

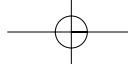

CONNECTION OPTION

This is the back panel of models 42PC1R*, 50PC1R*, 42PC3R* TVs.

Back Connection Panel

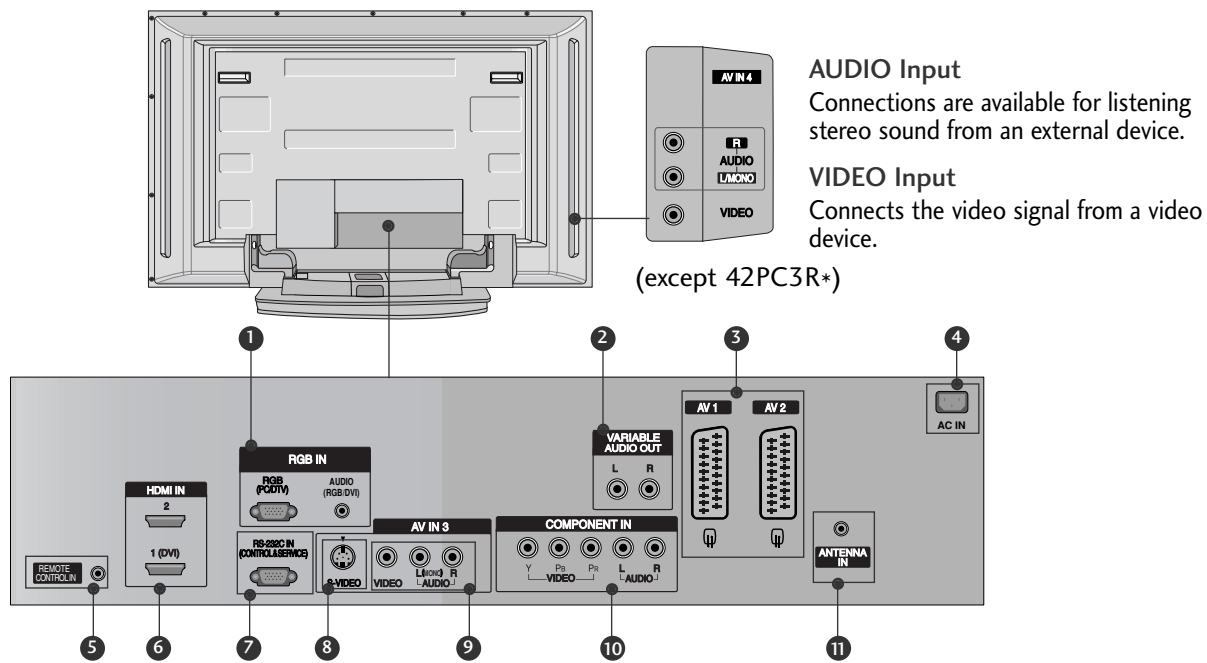

- 1** RGB/Audio Input
Connect the monitor output from a PC/DTV to the appropriate input port.
- 2** Variable Audio Output
Connect an external amplifier or add a sub-woofer to your surround sound system.
- 3** Euro Scart Socket (AV1/AV2)
Connect scart socket input or output from an external device to these jacks.
- 4** Power Cord Socket
This TV operates on an AC power. The voltage is indicated on the Specifications page. Never attempt to operate the TV on DC power.
- 5** Remote Control Port
- 6** HDMI Input
Connect a HDMI signal to HDMI IN. Connect DVI(VIDEO) signal to HDMI/DVI port with DVI to HDMI cable.
- 7** RS-232C Input(CONTROL&SERVICE)Port
Connect the serial port of the control devices to the RS-232C jack.
- 8** S-Video Input
Connect S-Video out from an S-VIDEO device.
- 9** Audio/Video Input
Connect audio/video output from an external device to these jacks.
- 10** Component Input
Connect a component video/audio device to these jacks.
- 11** Antenna Input

INTRODUCTION

CONTROLS

This is the front panel of models 32/37/42LC2R*, 37HIZ20, 42HIZ20, 37HIZ22, 42HIZ22 TVs.

■ This is a simplified representation of a front panel. Here shown may be somewhat different from your TV.

INTRODUCTION

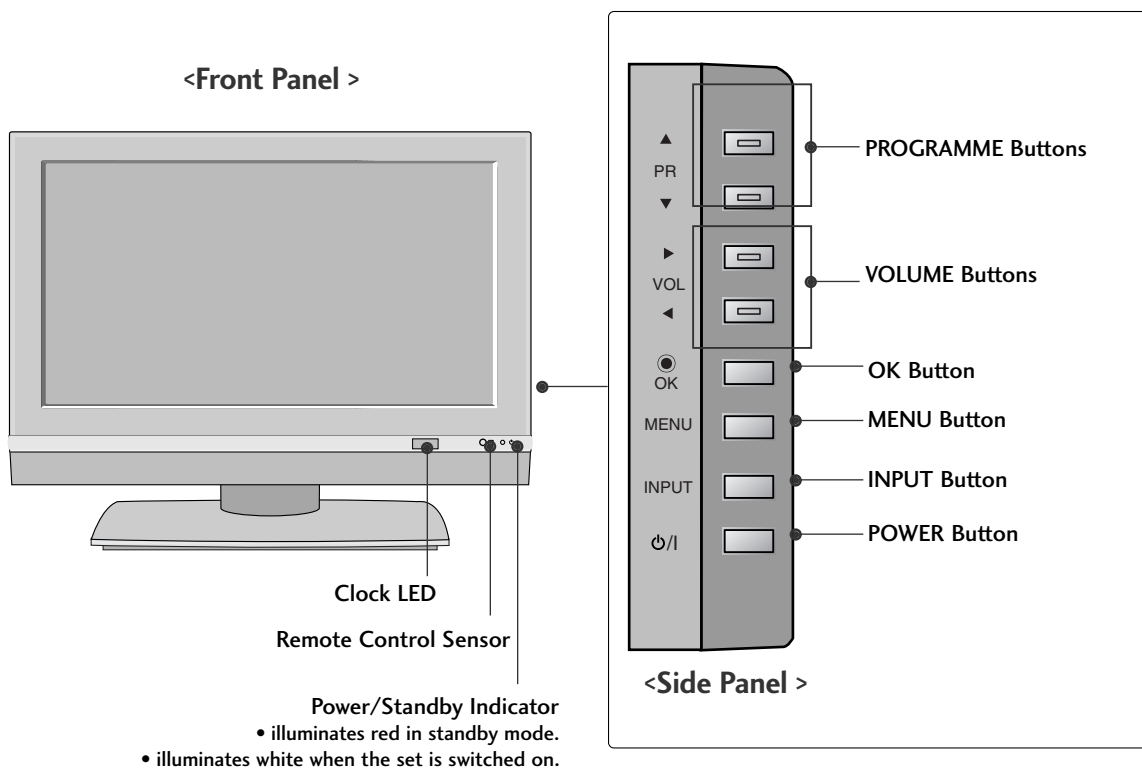

CONNECTION OPTION

This is the back panel of models 32/37/42LC2R*, 37HIZ20,42HIZ20 TVs.

Back Connection Panel

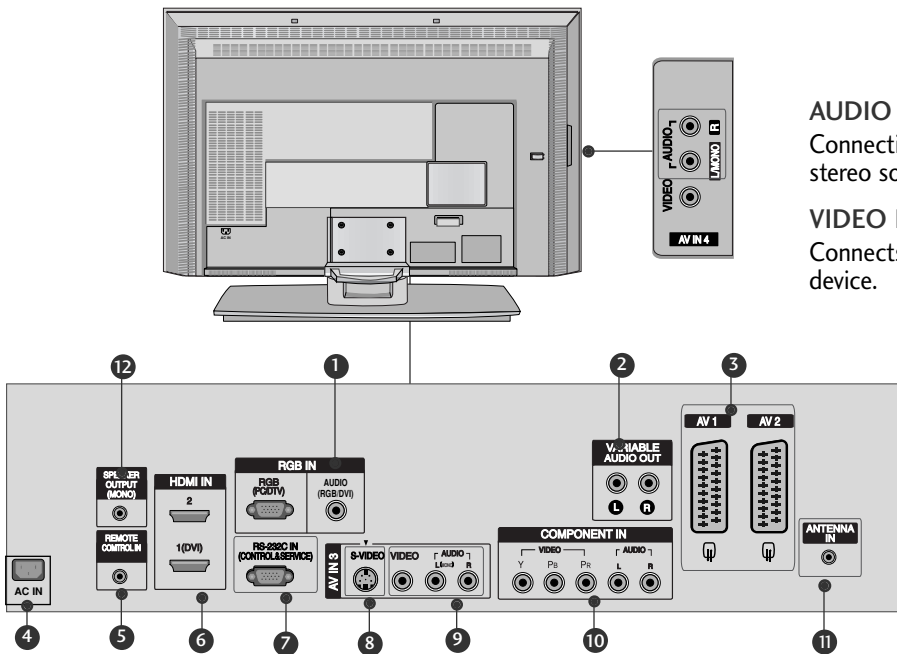

AUDIO Input
Connections are available for listening stereo sound from an external device.

VIDEO Input
Connects the video signal from a video device.

INTRODUCTION

- 1** **RGB/Audio Input**
Connect the monitor output from a PC/DTV to the appropriate input port.
- 2** **Variable Audio Output**
Connect an external amplifier or add a sub-woofer to your surround sound system.
- 3** **Euro Scart Socket (AV1/AV2)**
Connect scart socket input or output from an external device to these jacks.
- 4** **Power Cord Socket**
This TV operates on an AC power. The voltage is indicated on the Specifications page. Never attempt to operate the TV on DC power.
- 5** **Remote Control Port**
- 6** **HDMI Input**
Connect a HDMI signal to HDMI IN. Connect DVI(VIDEO) signal to HDMI/DVI port with DVI to HDMI cable.
- 7** **RS-232C Input(CONTROL&SERVICE)Port**
Connect the serial port of the control devices to the RS-232C jack.
- 8** **S-Video Input**
Connect S-Video out from an S-VIDEO device.
- 9** **Audio/Video Input**
Connect audio/video output from an external device to these jacks.
- 10** **Component Input**
Connect a component video/audio device to these jacks.
- 11** **Antenna Input**
- 12** **SPEAKER OUTPUT (MONO)**
The phone socket for a Hi-Fi amplifier system is on this jacks.

INTRODUCTION

CONNECTION OPTION

This is the back panel of models 32HIZ22, 37HIZ22, 42HIZ22 TVs.

Back Connection Panel

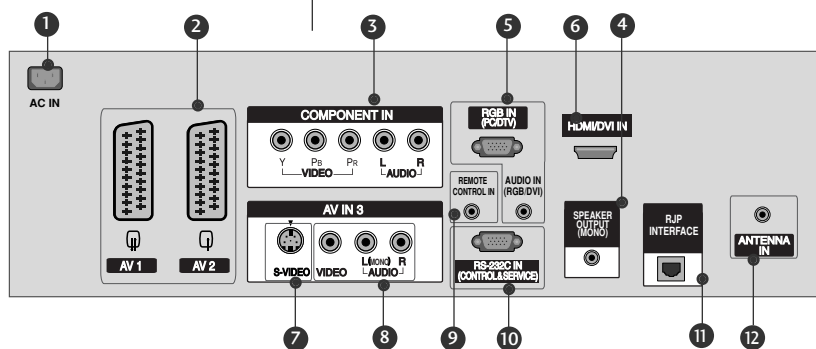
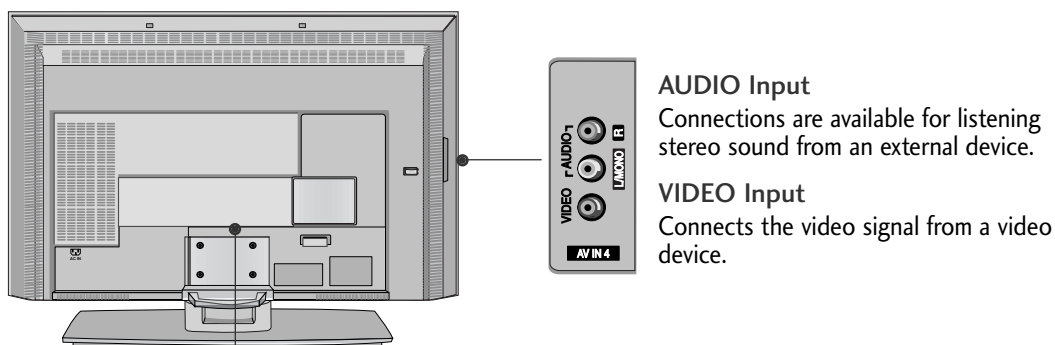

- 1** **Power Cord Socket**
This TV operates on an AC power. The voltage is indicated on the Specifications page. Never attempt to operate the TV on DC power.
- 2** **Euro Scart Socket (AV1/AV2)**
Connect scart socket input or output from an external device to these jacks.
- 3** **Component Input**
Connect a component video/audio device to these jacks.
- 4** **Speaker out (Mono)**
The phone socket for a Hi-Fi amplifier system is on this jacks.
- 5** **RGB/Audio Input**
Connect the monitor output from a PC/DTV to the appropriate input port.
- 6** **HDMI Input**
Connect a HDMI signal to HDMI IN(or HDMI/DVI IN). Connect DVI(VIDEO) signal to HDMI/DVI(or HDMI/DVI IN) port with DVI to HDMI cable.
- 7** **S-Video Input**
Connect S-Video out from an S-VIDEO device.
- 8** **Audio/Video Input**
Connect audio/video output from an external device to these jacks.
- 9** **Remote Control Port**
- 10** **RS-232C Input (CONTROL&SERVICE) Port**
Connect the serial port of the control devices to the RS-232C jack.
- 11** **RJP Input (Available for 32/37/42HIZ22)**
Connect control line (RJ45) for RJP(Remote Jack pack)
- 12** **Antenna Input**
Connect over-the-air signals to this jack.

REMOTE CONTROL KEY FUNCTIONS

POWER Switches the set on from standby or off to standby.

TV INPUT Returns from **AV1, AV2, S-Video2, AV3, AV4**(except 42PC3R*), **Component, RGB, HDMI1/DVI** or **HDMI 2** (or **HDMI/DVI IN**) to the TV mode. Switches the set on from standby.

INPUT If you press the button once, the input source OSD will appear on screen as shown. Press the **▲ / ▼** button and then **OK** button to select the desired input source (**TV, AV1, AV2, S-Video2, AV3, AV4**(except 42PC3R*), **Component, RGB, HDMI1/DVI** or **HDMI 2** (or **HDMI/DVI IN**)).

ARC Selects your desired picture format.

Brightness adjustment Adjusts screen brightness. It returns to the default settings brightness by changing mode source.

PIP Switches the sub picture PIP, DW, POP or off mode.

SIZE Adjusts the sub picture size.

POSITION Moves the sub picture.

PIP PR - / + Selects a programme for the sub picture.

SWAP Exchanges the main/sub images in PIP/Doubel window mode.

PIP INPUT Selects the input source for the sub picture in PIP/Doubel window mode.

Coloured buttons These buttons are used for teletext (only **TELETEXT** models) or **Programme edit**.

VCR/DVD control buttons Controls some video cassette recorders or DVD players when you have already selected DVD or VCR mode button.

EXIT Clears all on-screen displays and returns to TV viewing from any menu.

LIST Displays the programme table.

MENU Selects a menu.

I/II Selects the sound output.

SLEEP Sets the sleep timer.

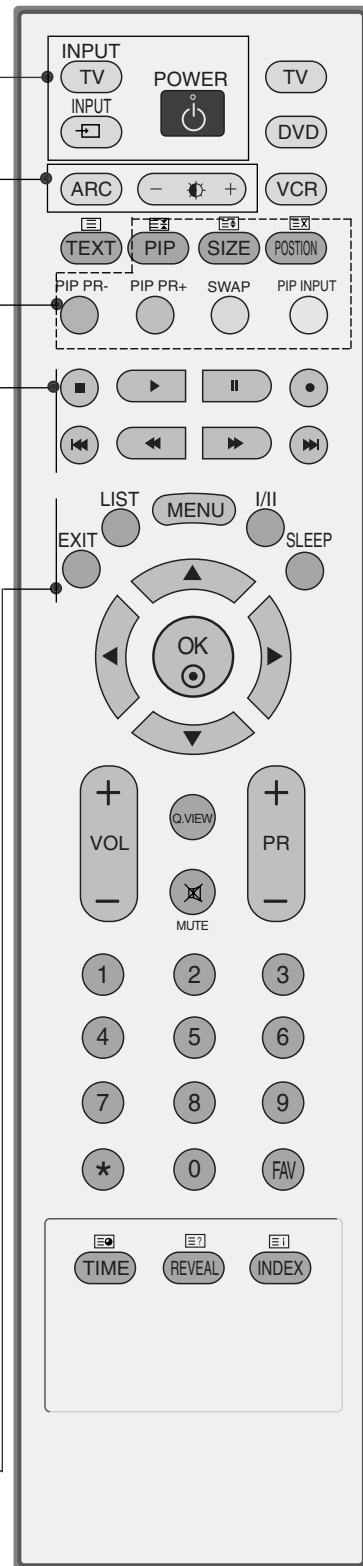

INTRODUCTION

REMOTE CONTROL KEY FUNCTIONS

INTRODUCTION

- MODE** Selects the remote operating modes.

- 1 TELETEXT BUTTONS** These buttons are used for teletext. For further details, see the 'Teletext' section.

- THUMBSTICK** (Up/Down/Left/Right) Allows you to navigate the on-screen menus and adjust the system settings to your preference.
 - OK** Accepts your selection or displays the current mode.

- VOLUME UP /DOWN** Adjusts the volume.
 - Q.VIEW** Returns to the previously viewed programme.
 - MUTE** Switches the sound on or off.
 - Programme UP/DOWN** Selects available programmes.
 - 0~9 number button** Selects a programme. Selects numbered items in a menu.
 - FAV** Displays the selected favourite programme.
 - * No function

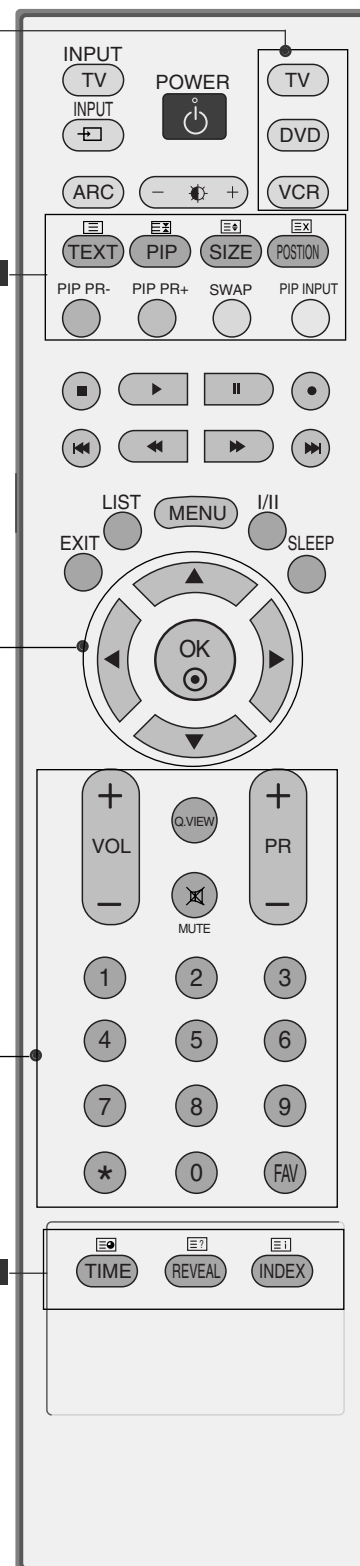

INSTALLING BATTERIES

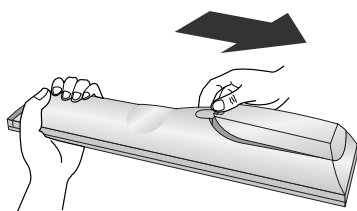

- Open the battery compartment cover on the back side and insert the batteries with correct polarity.
- Install two 1.5V alkaline batteries of AA type. Don't mix used batteries with new batteries.

INSTALLATION

UNFOLDING THE BASE STAND (42PC1R*, 42PC3R*)

- This feature is not available for all models.

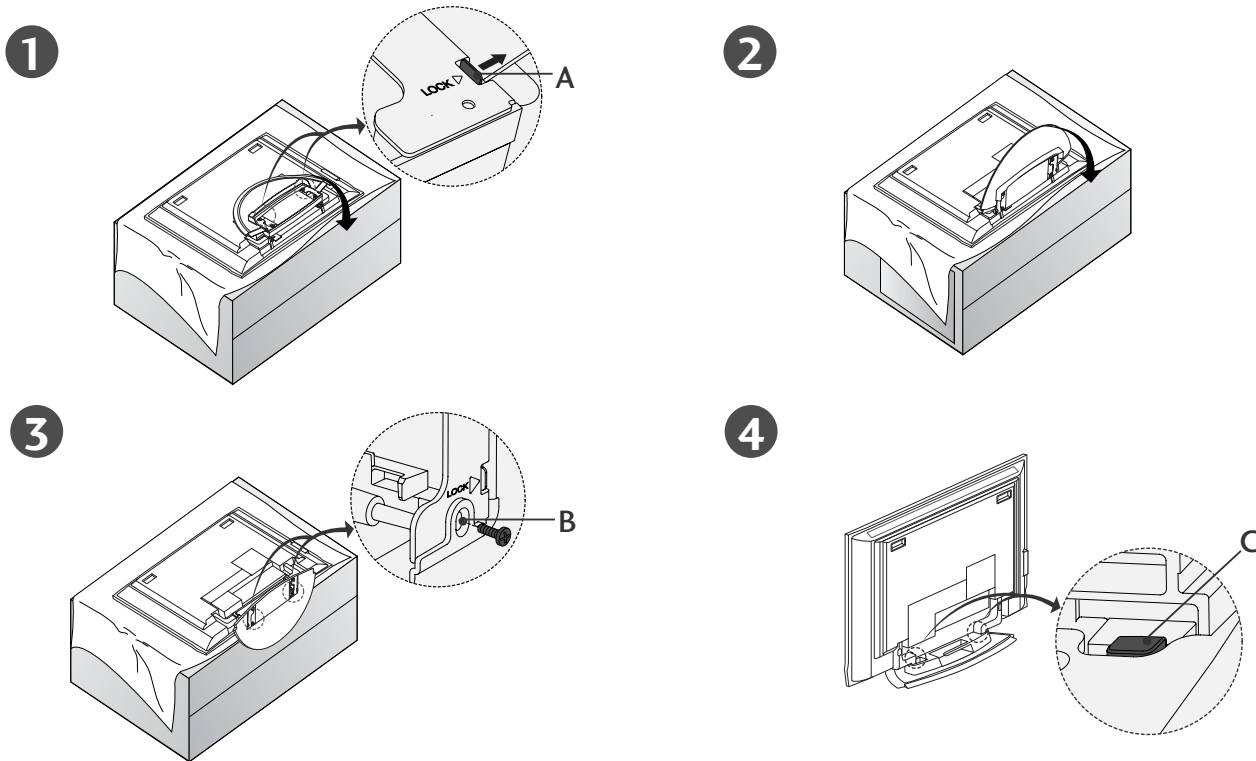

- Place the set with the screen facing down on a cushion or soft cloth as shown in Figure 1. Before unfolding the stand, please make sure two locks (A) on the bottom of the stand push outward.
- Pull the stand out as shown above in Figures 2 ~ 3. After unfolding the stand, please insert and tighten the screws in the holes (B) on the bottom of the stand.
- When connecting cables to the set, do not disengage the lock (C). This may cause the set to fall, causing serious bodily injury and serious damage to the set.

NOTE

Figures shown here may be slightly different from your set.

When closing the stand for storage

First remove the screws in the holes (B) on the bottom of the stand. And then pull two Hooks (D) of the stand bottom and fold the stand into the back of the set.

After folding, push two Locks (A) of the stand bottom outward.

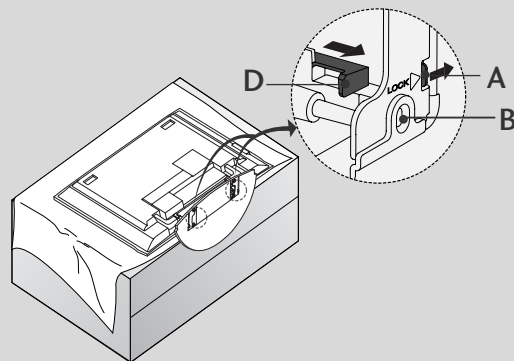

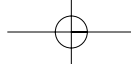

INSTALLATION

BASIC CONNECTION (PDP TV models)

- These models have two cable arrangement methods according to the stand type.

Stand type 1

Arrange the cables as shown picture.

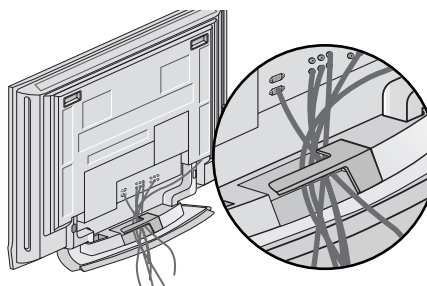

INSTALLATION

Stand type 2

- 1** Hold the **CABLE MANAGEMENT** with both hands and push it as shown.

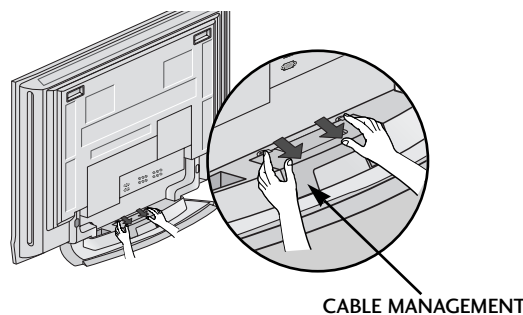

- 2** Connect the cables as necessary.
To connect an additional equipment, see the **External equipment Connections** section.

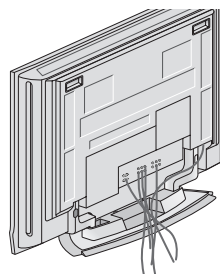

- 3** Reinstall the **CABLE MANAGEMENT** as shown.

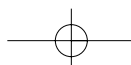
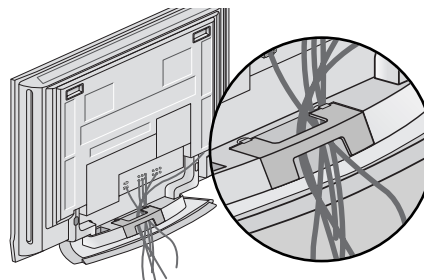

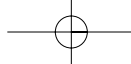

BASIC CONNECTION (LCD TV models)

- 1 Connect the cables as necessary. After connecting the cables neatly, arrange the cables to the Cable Holder.

To connect an additional equipment, see the **External equipment Connections** section.

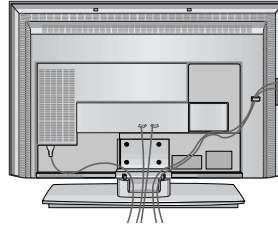

- 2 Install the **CABLE MANAGEMENT** as shown.

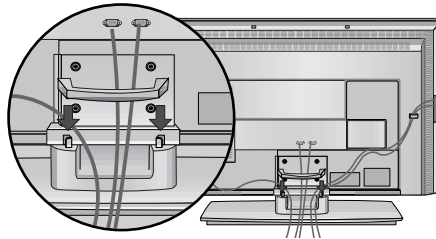

- 3 Bundle the cables using the supplied twister holder.

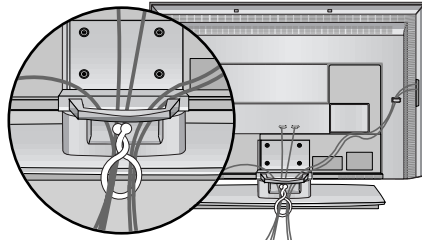

HOW TO REMOVE THE CABLE MANAGEMENT (LCD TV models)

Hold the **CABLE MANAGEMENT** with both hands and pull it upward.

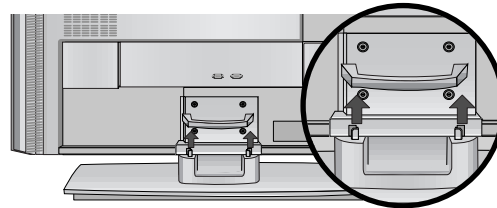

! NOTE

- ▶ Do not hold the **CABLE MANAGEMENT** when moving the product. If the product is dropped, you may be injured or the product may be broken.

SWIVEL STAND

- This feature is not available for all models.

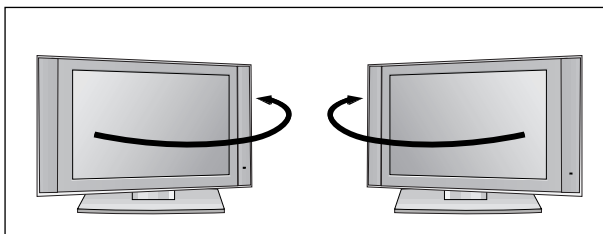

- The TV can be conveniently swiveled on its stand 30° to the left or right to provide the optimum viewing angle.

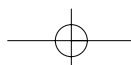
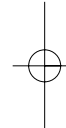
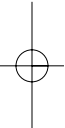

INSTALLATION

HOW TO JOIN THE PRODUCT ASSEMBLY TO THE WALL TO PROTECT THE SET TUMBLING

- Set it up close to the wall so the product doesn't fall over when it is pushed backwards.
- The instructions shown below is a safer way to set up the product, which is to fix it on the wall so the product doesn't fall over when it is pulled in the forward direction. It will prevent the product from falling forward and hurting people. It will also prevent the product from damage caused by fall. Please make sure that children don't climb on or hang from the product.

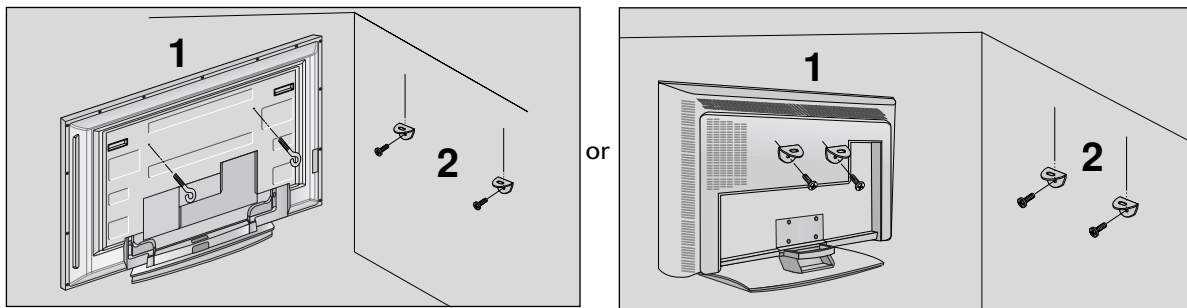

- 1 Use the eye-bolts or TV brackets/bolts to fix the product to the wall as shown in the picture.
(If your product has the bolts in the eye-bolts position before inserting the eye-bolts, loosen the bolts.)
* Insert the eye-bolts or TV brackets/bolts and tighten them securely in the upper holes.

- 2 Secure the wall brackets with the bolts (not provided as parts of the product, must purchase separately) on the wall. Match the height of the bracket that is mounted on the wall.

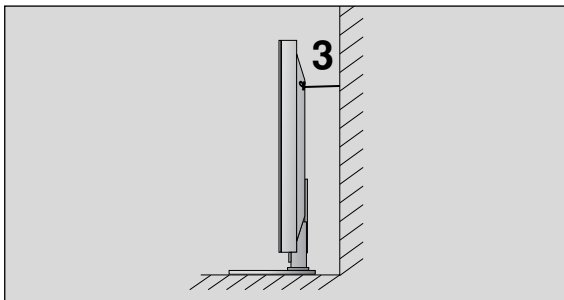

- 3 Use a sturdy rope (not provided as parts of the product, must purchase separately) to tie the product. It is safer to tie the rope so it becomes horizontal between the wall and the product.

NOTE

- ▶ When moving the product to another place undo the ropes first.
- ▶ Use a product holder or a cabinet that is big and strong enough for the size and weight of the product.
- ▶ To use the product safely make sure that the height of the bracket that is mounted on the wall is same as that of the product.

STAND INSTALLATION

- The TV can be installed in various ways such as on a wall, or on a desktop etc.
- The TV is designed to be mounted horizontally.

GROUNDING

Ensure that you connect the earth ground wire to prevent possible electric shock. If grounding methods are not possible, have a qualified electrician install a separate circuit breaker. Do not try to ground the unit by connecting it to telephone wires, lightening rods, or gas pipes.

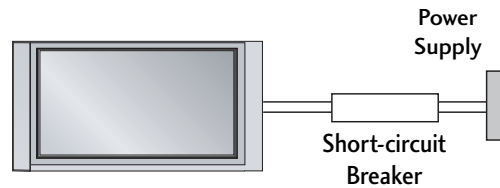

Desktop Pedestal Installation

For proper ventilation, allow a clearance of 4" on each side and from the wall.

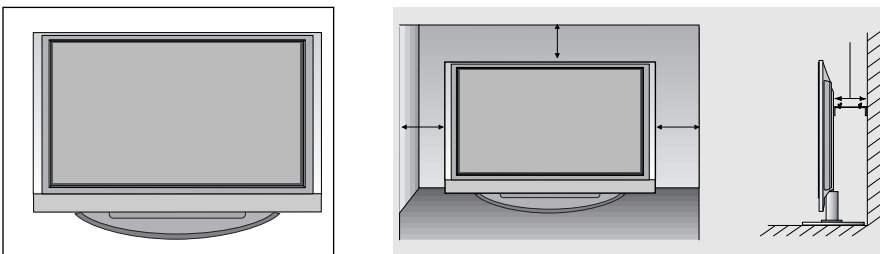

Wall Mount: Horizontal installation

For proper ventilation, allow a clearance of 4" on each side and from the wall. Detailed installation instructions are available from your dealer, see the optional Tilt Wall Mounting Bracket Installation and Setup Guide.

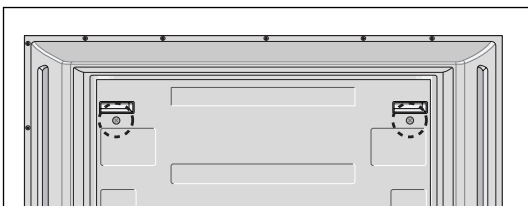
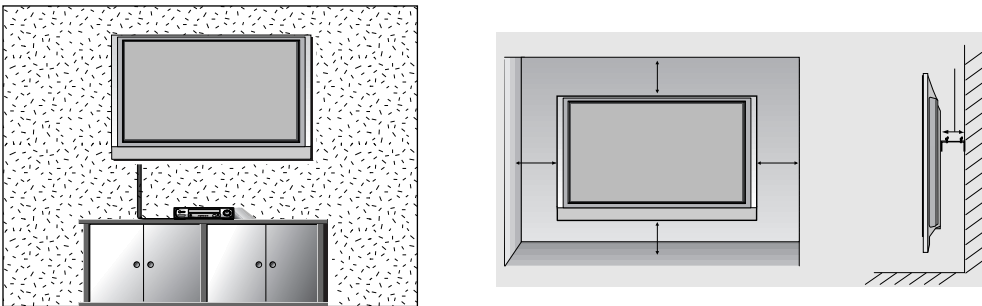

<Only 42PC1R*, 42PC3R*>

Remove two screws of the backside of the set before installing the wall mounting bracket.

CONNECTIONS & SETUP

- To prevent the equipment damage, never plug in any power cords until you have finished connecting all equipment.

ANTENNA CONNECTION

- For optimum picture quality, adjust antenna direction.
- An antenna cable and converter are not supplied.

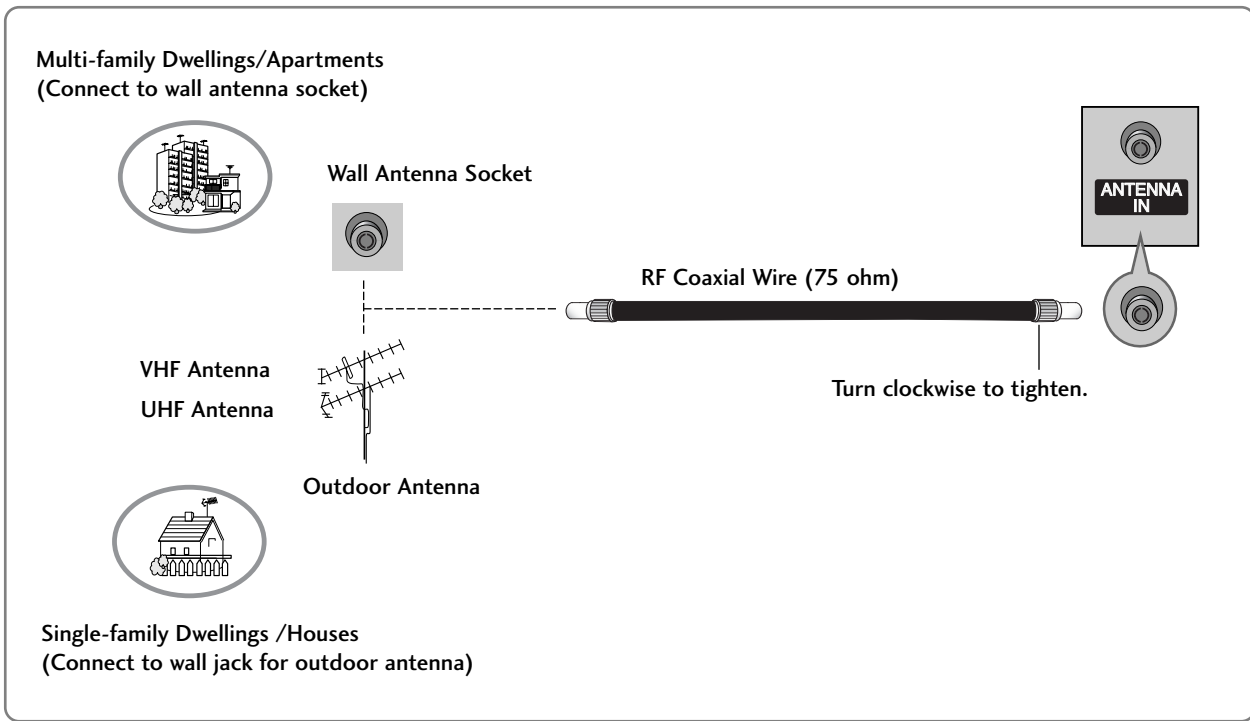

- In poor signal areas, to get better picture quality, install a signal amplifier to the antenna as shown to the right.
- If signal needs to be split for two TVs, use an antenna signal splitter for connection.

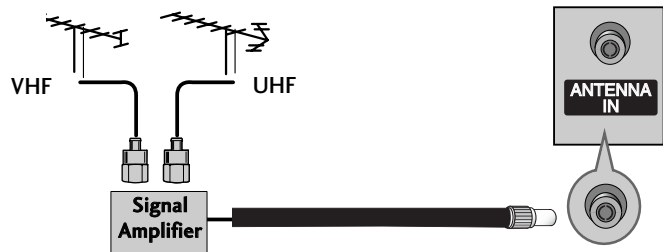

VCR SETUP

- To avoid picture noise (interference), leave an adequate distance between the VCR and TV.
- Typically a frozen still picture from a VCR. If the 4:3 picture format is used; the fixed images on the sides of the screen may remain visible on the screen.

When connecting with an antenna

- 1 Connect the **ANT OUT** socket of the VCR to the **ANTENNA IN** socket on the set.
- 2 Connect the antenna cable to the **ANT IN** antenna socket of the VCR.
- 3 Press the **PLAY** button on the VCR and match the appropriate programme between the TV and VCR for viewing.

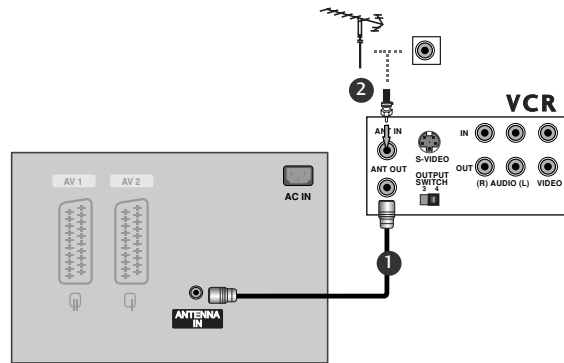

When connecting with a RCA cable

- 1 Connect the **AUDIO/VIDEO** jacks between TV and VCR. Match the jack colors (Video = yellow, Audio Left = white, and Audio Right = red)
- 2 Insert a video tape into the VCR and press **PLAY** on the VCR. (Refer to the VCR owner's manual.)
- 3 Select **AV3** input source using the **INPUT** button on the remote control.
 - If connected to **AV IN4**, select **AV4** input source. (except 42PC3R*)

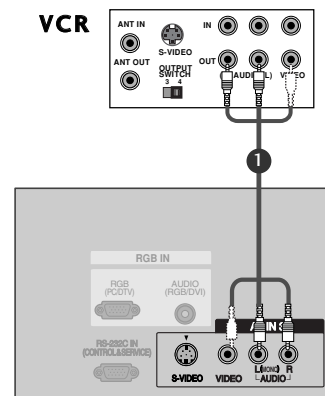

! NOTE

- ▶ If you have a mono VCR, connect the audio cable from the VCR to the **AUDIO L/MONO** jack of the set.

CONNECTIONS & SETUP

VCR SETUP

When connecting with a Euro Scart

- 1 Connect the Euro scart socket of the VCR to the **AV1** Euro scart socket on the set.
- 2 Insert a video tape into the VCR and press **PLAY** on the VCR. (Refer to the VCR owner's manual.)
- 3 Select **AV1** input source with using the **INPUT** button on the remote control.
- If connected to **AV2** Euro scart socket, select **AV2** input source.

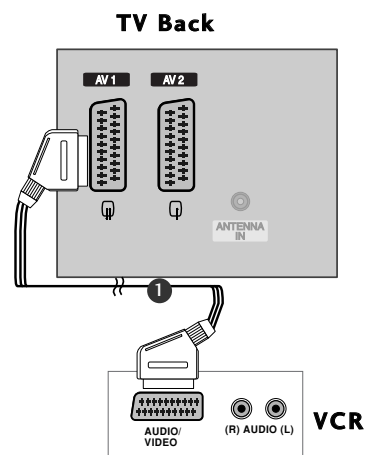

NOTE

- ▶ If the S-VIDEO(Y/C) signal is received through the Euro scart socket 2 (AV2), you must change to the S-Video2 mode.
- ▶ If you want to use the EURO scart cable, you have to use the signal shielded Euro scart cable.

When connecting with an S-Video cable

- 1 Connect the S-VIDEO output of the VCR to the **S-Video** input on the set. The picture quality is improved; compared to normal composite (RCA cable) input.
- 2 Connect the audio outputs of the VCR to the **AUDIO** input jacks on the set.
- 3 Insert a video tape into the VCR and press **PLAY** on the VCR. (Refer to the VCR owner's manual.)
- 4 Select **AV3** input source with using the **INPUT** button on the remote control.

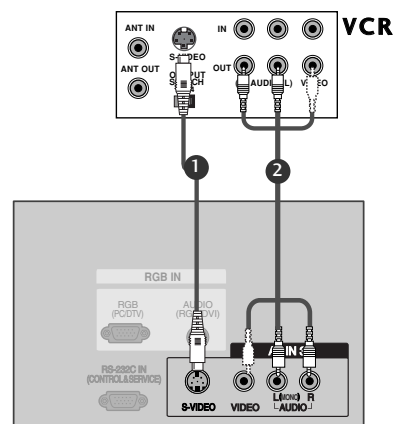

NOTE

- ▶ If both S-Video and VIDEO sockets have been connected to the S-VHS VCR simultaneously, only the S-Video can be received.

EXTERNAL EQUIPMENT CONNECTIONS

- 1 Connect the **AUDIO/VIDEO** jacks between TV and external equipment. Match the jack colors (Video = yellow, Audio Left = white, and Audio Right = red).
- 2 Select **AV4** input source with using the **INPUT** button on the remote control(except 42PC3R*).
- If connected to **AV IN3** input, select **AV3** input source.
- 3 Operate the corresponding external equipment. Refer to external equipment operating guide.

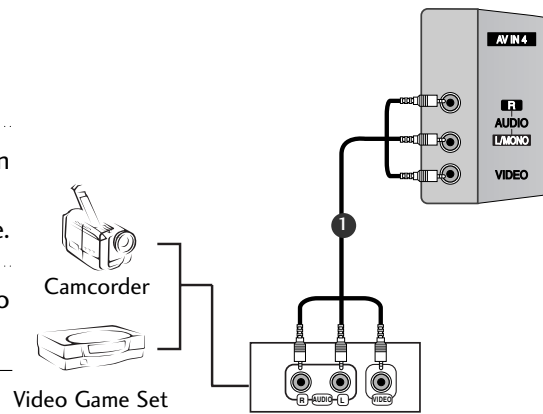

CONNECTIONS & SETUP

DVD SETUP

When connecting with a component cable

- 1 Connect the video outputs (Y, PB, PR) of the DVD to the **COMPONENT IN VIDEO** jacks on the set.
- 2 Connect the audio outputs of the DVD to the **COMPONENT IN AUDIO** jacks on the set.
- 3 Turn on the DVD player, insert a DVD.
- 4 Select **Component** input source with using the **INPUT** button on the remote control.
- 5 Refer to the DVD player's manual for operating instructions.

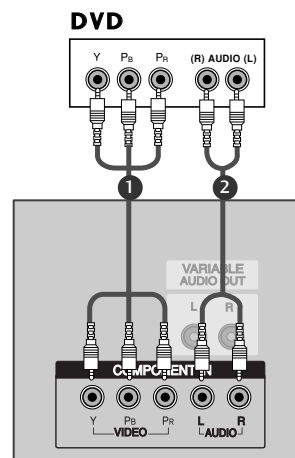

NOTE

▶ Component Input ports

To get better picture quality, connect a DVD player to the component input ports as shown below.

Component ports on the TV	Y	Pb	Pr
Video output ports on DVD player	Y	Pb	Pr
	Y	B-Y	R-Y
	Y	Cb	Cr
	Y	PB	PR

When connecting with a Euro Scart

- 1 Connect the Euro scart socket of the DVD to the AV1 Euro scart socket on the set.
- 2 Turn on the DVD player, insert a DVD.
- 3 Select AV1 input source with using the **INPUT** button on the remote control.
- If connected to **AV2** Euro scart socket, select **AV2** input source.

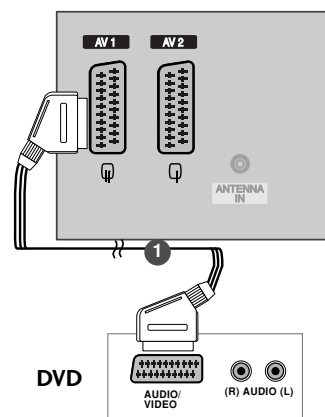

NOTE

- ▶ Please use the shield scart cable.

When connecting with a S-Video cable

- 1 Connect the S-VIDEO output of the DVD to the **S-Video** input on the set.
- 2 Connect the audio outputs of the DVD to the **AUDIO** input jacks on the set.
- 3 Turn on the DVD player, insert a DVD.
- 4 Select **AV3** input source with using the **INPUT** button on the remote control.
- 5 Refer to the DVD player's manual for operating instructions.

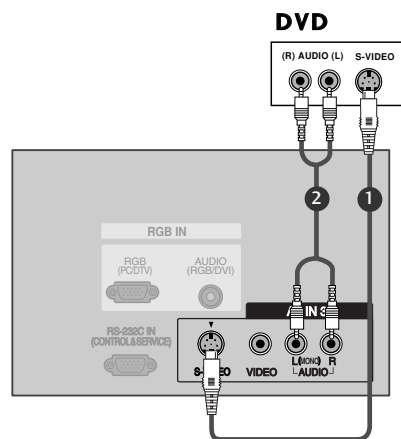

When connecting with a HDMI cable

- 1 Connect the HDMI output of the DVD to the **HDMI (or HDMI/DVI) IN** jack on the set.
- 2 Select **HDMI1 /DVI** or **HDMI2 (or HDMI/DVI)** input source with using the **INPUT** button on the remote control.
- 3 Refer to the DVD player's manual for operating instructions.

32/37/42HIZ22

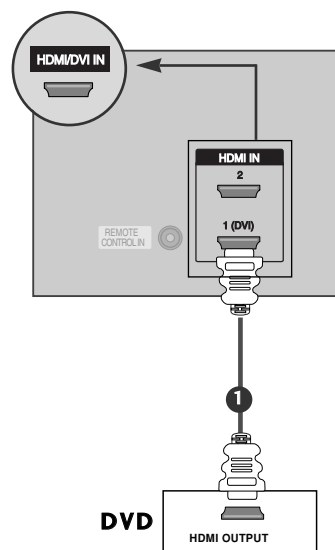

! NOTE

- ▶ TV can receive the video and audio signal simultaneously with using a HDMI cable.
- ▶ If the DVD supports Auto HDMI function, the DVD output resolution will be automatically set to 1280x720p.
- ▶ If the DVD does not support Auto HDMI, you need to set the output resolution appropriately. To get the best picture quality, adjust the output resolution of the DVD to 1280x720p.

CONNECTIONS & SETUP

STB(SET-TOP BOX) SETUP

When connecting with a component cable

- 1 Connect the video outputs (Y, PB, PR) of the digital set-top box to the **COMPONENT IN VIDEO** jacks on the set.
- 2 Connect the audio output of the digital set-top box to the **COMPONENT IN AUDIO** jacks on the set.
- 3 Turn on the digital set-top box. (Refer to the owner's manual for the digital set-top box.)
- 4 Select **Component** input source with using the **INPUT** button on the remote control.

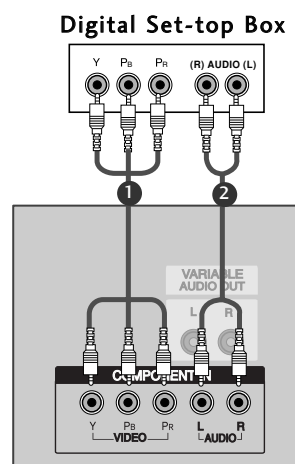

NOTE

Signal	Component	RGB-DTV	HDMI1/DVI (DTV)	HDMI2 (DTV)
480i/576i	Yes	No	No	No
480p/576p/720p/1080i	Yes	Yes	Yes	Yes

When connecting with a HDMI to DVI cable

- 1 Connect the DVI output of the digital set-top box to the **HDMI1 (DVI) (or HDMI/DVI) IN** jack on the set.
- 2 Connect the audio outputs of the set-top box to the **AUDIO (RGB/DVI)** jack on the set.
- 3 Turn on the digital set-top box. (Refer to the owner's manual for the digital set-top box.)
- 4 Select **HDMI1 /DVI (or HDMI/DVI)** input source with using the **INPUT** button on the remote control.

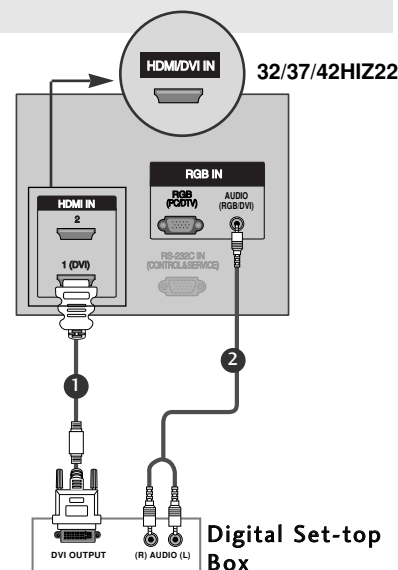

NOTE

- ▶ If the digital set-top box has a DVI output and no HDMI output, a separated audio connection is necessary.
- ▶ If the digital set-top box supports Auto DVI function, the output resolution of the digital set-top box will be automatically set to 1280x720p.
- ▶ If the digital set-top box does not support Auto DVI, you need to set the output resolution appropriately. To get the best picture quality, adjust the output resolution of the digital set-top box to 1280x720p.

When connecting with a D-sub 15 pin cable

- 1 Connect the RGB output of the digital set-top box to the **RGB IN (PC/DTV)** jack on the set.
- 2 Connect the audio outputs of the set-top box to the **AUDIO (RGB/DVI)** jack on the set.
- 3 Turn on the digital set-top box. (Refer to the owner's manual for the digital set-top box.)
- 4 Select **RGB-DTV** input source with using the **INPUT** button on the remote control.

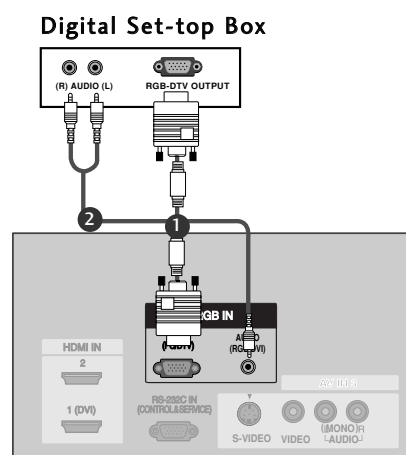

When connecting with a HDMI cable

- 1 Connect the HDMI output of the digital set-top box to the **HDMI (or HDMI/DVI) IN** jack on the set.
- 2 Select **HDMI1 /DVI** or **HDMI2 (or HDMI/DVI)** input source with using the **INPUT** button on the remote control.
- 3 Turn on the digital set-top box. (Refer to the owner's manual for the digital set-top box.)

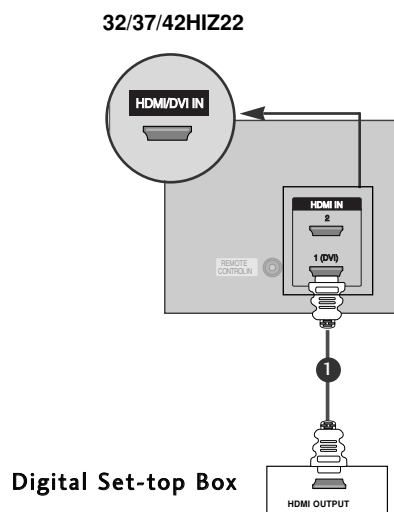

! NOTE

- ▶ TV can receive the video and audio signal simultaneously with using a HDMI cable.
- ▶ If the digital set-top box supports Auto HDMI function, output resolution of the digital set-top box will be automatically set to 1280x720p.
- ▶ If the digital set-top box does not support Auto HDMI, you need to set the output resolution appropriately. To get the best picture quality, adjust the output resolution of the digital set-top box to 1280x720p.

CONNECTIONS & SETUP

PC SETUP

- This TV provides Plug and Play capability, meaning that the PC adjusts automatically to the TV's settings.

When connecting with a D-sub 15 pin cable

- 1 Connect the RGB output of the PC to the **RGB IN (PC/DTV)** jack on the set.
- 2 Connect the audio outputs of the PC to the **AUDIO (RGB/DVI)** jack on the set.
- 3 Turn on the PC and the set.
- 4 Select **RGB-PC** input source with using the **INPUT** button on the remote control.

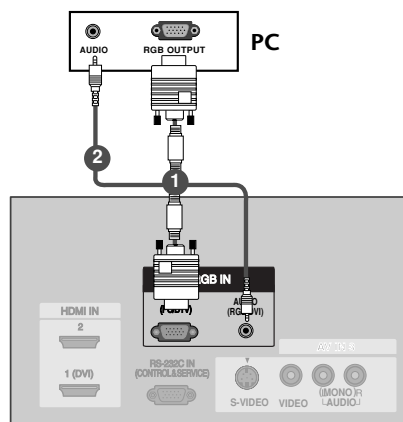

When connecting with a HDMI to DVI cable

- 1 Connect the DVI output of the PC to the **HDMI1 (DVI) (or HDMI/DVI) IN** jack on the set.
- 2 Connect the audio outputs of the PC to the **AUDIO (RGB/DVI)** jack on the set.
- 3 Turn on the PC and the set.
- 4 Select **HDMI1/DVI (or HDMI/DVI)** input source with using the **INPUT** button on the remote control.

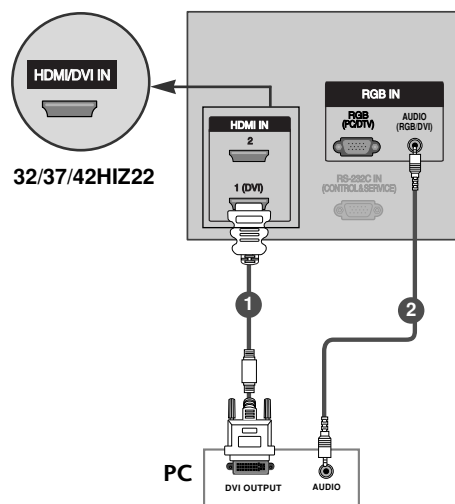

! NOTE

- ▶ If the PC has a DVI output and no HDMI output, a separated audio connection is necessary.
- ▶ If the PC does not support Auto DVI, you need to set the output resolution appropriately. To get the best picture quality, adjust the output resolution of PC graphics card's output resolution to 1024x768, 60Hz.

! NOTE

- ▶ To enjoy vivid picture and sound, connect a PC to the set.
- ▶ Avoid keeping a fixed image on the set's screen for a long period of time. The fixed image may become permanently imprinted on the screen; use a screen saver when possible.
- ▶ Connect PC to the RGB (PC/DTV) or HDMI IN port of the set; change the resolution output of PC accordingly.
- ▶ There might be noise according to some resolution, vertical pattern, contrast or brightness in PC mode. Change the PC mode into another resolution or change the refresh rate into another rate or adjust the brightness and contrast on the menu until the picture is clean. If the refresh rate of the PC graphic card can not be changed, change the PC graphic card or consult it to the manufacturer of the PC graphic card.
- ▶ The synchronization input waveform for Horizontal and Vertical frequencies are separate.
- ▶ In 42PC1R/42PC3R/50PC1R models, we recommend using 1024x768, 60Hz for the PC mode, they provide the best picture quality.
- ▶ We recommend using 1366*768, 60Hz (32/37/42LC2R*, 37HIZ20, 42HIZ20, 32HIZ22, 37HIZ22, 42HIZ22) for the PC mode, they provide the best picture quality.
- ▶ If the resolution of PC is over UXGA, there will be no picture on the set.
- ▶ Connect the signal cable from the monitor output port of the PC to the RGB (PC/DTV) port of the set or the signal cable from the HDMI output port of the PC to the HDMI IN port on the set.
- ▶ Connect the audio cable from the PC to the Audio input on the set. (Audio cables are not included with the set).
- ▶ If using a sound card, adjust PC sound as required.
- ▶ This set uses a VESA Plug and Play Solution. The set provides EDID data to the PC system with a DDC protocol. The PC adjusts automatically when using this set.
- ▶ DDC protocol is preset for RGB (Analog RGB), HDMI (Digital RGB) mode.
- ▶ If required, adjust the settings for Plug and Play functionally.
- ▶ If graphic card on the PC does not output analog and digital RGB simultaneously, connect only one of either RGB (PC/DTV) or HDMI IN to display the PC on the set.
- ▶ If graphic card on the PC does output analog and digital RGB simultaneously, set the set to either RGB or HDMI; (the other mode is set to Plug and Play automatically by the set.)
- ▶ DOS mode may not work depending on video card if you use a HDMI to DVI cable.
- ▶ When you use too long RGB-PC cable, there might be a noise on the screen. We recommend using under 5m of the cable. It provides the best picture quality.

CONNECTIONS & SETUP

Supported Display Resolution
 (FOR 32/37/42LC2R* 37HIZ20,42HIZ20,
 32HIZ22,37HIZ22,42HIZ22) **RGB[PC] / HDMI[PC] mode**

Resolution	Horizontal Frequency(KHz)	Vertical Frequency(Hz)
720x400	31.469	70.08
640x480	31.469 37.500	59.94 75.00
800x600	37.879 46.875	60.31 75.00
832x624	49.725	74.55
1024x768	48.363 56.476 60.023	60.00 70.06 75.02
1280x768	47.693	59.99
1360x768	47.700	60.00
1366x768	47.700	60.00

Supported Display Resolution
 (FOR 42PC1R*, 42PC3R*, 50PC1R*)
RGB[PC] / HDMI[PC] mode

Resolution	Horizontal Frequency(KHz)	Vertical Frequency(Hz)
640x350	31.468	70.09
720x400	31.469	70.08
640x480	31.469 35.00 37.861 37.500	59.94 66.66 72.80 75.00
848x480	31.5 37.799 39.375	60.00 70.00 75.00
852x480	31.5 37.799 39.975	60.00 70.00 75.00
832x624	49.725	74.55
800x600	37.897 48.077 46.875	60.31 72.18 75.00
1024x768	48.363 56.476 60.023	60.00 70.06 75.02
1280x1024	63.981	60.02
1280x768	47.693 60.091	59.99 74.93
1360x768	47.700 59.625	60.00 75.02
1366x768	47.700 59.625	60.00 75.02

CONNECTIONS & SETUP

TURNING THE TV ON

If your TV will be turned on, you will be able to use its features.

Turing on the TV

- 1 First, connect power cord correctly.
At this moment, the TV switches to standby mode.
 - In standby mode to turn TV on, press the $\phi/|$, **INPUT**, **PR** \blacktriangle / \blacktriangledown button on the TV or press the **POWER**, **TV**, **INPUT**, **PR** +/-, **Number(0~9)** button on the remote control and then the TV will switch on.

Volume Adjustment

- 1 Press the **VOL +/-** button to adjust the volume.
- 2 If you want to switch the sound off, press the **MUTE** button.
- 3 You can cancel this function by pressing the **MUTE**, **VOL +/-** or **I/II** button.

Programme selection

- 1 Press the **PR +/-** or **NUMBER** button to select a programme number.

On-Screen Menu Language Selection (option)

- The menus can be shown on the screen in the selected language. First select your language.

- 1 Press the **MENU** button and then use \blacktriangle / \blacktriangledown button to select the **SPECIAL** menu.
- 2 Press the \blacktriangleright button and then use \blacktriangle / \blacktriangledown button to select **Language**.
- 3 Press the \blacktriangleright button and then use \blacktriangle / \blacktriangledown button to select your desired language. From this point on, the on-screen menus will be shown in the language of your choice.
- 4 Press the **EXIT** button to return to normal TV viewing.

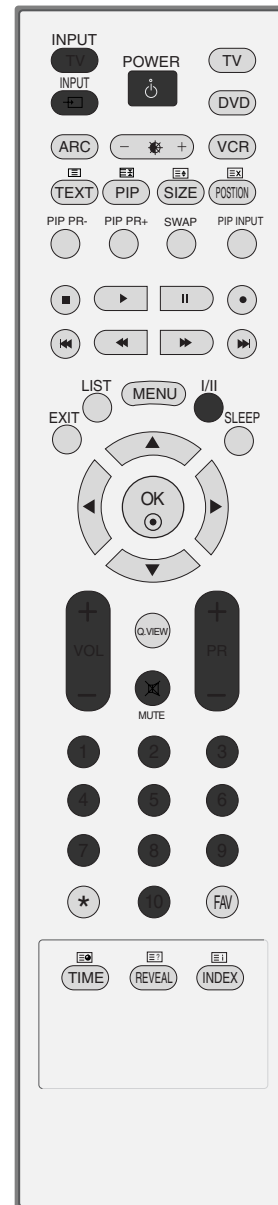

NOTE

- ▶ If you intend to be away on vacation, disconnect the power plug from wall power outlet.

SPECIAL FUNCTIONS

PIP (PICTURE-IN-PICTURE) / DOUBLE WINDOW / POP

PIP lets you view 2 different inputs (sources) on your TV screen at the same time. One source will be large, and the other source will show a smaller inset image.

Double window mode splits the screen into 2, allowing 2 picture sources to be shown on the TV screen at the same time. Each source is given half the screen.

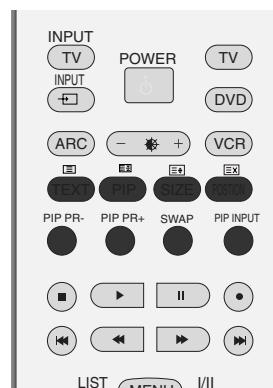

Watching PIP/Double Window/POP

Press the **PIP** button to access the sub picture. Each press of PIP changes the PIP options as shown below.

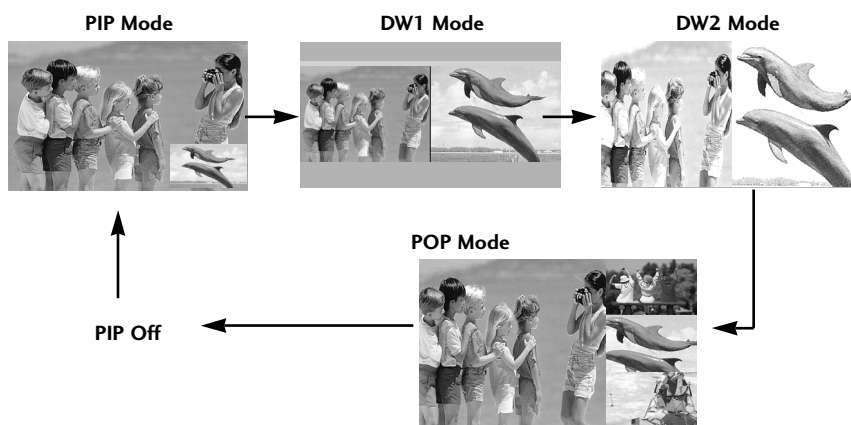

Programme Selection for Sub Picture

Press the **PIP PR +/-** button to select a programme for the sub picture.
The sub picture programme selection is not available in TV mode for main and sub picture simultaneously.

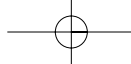

Input Source Selection for Sub Picture

Press the **PIP INPUT** button to select the input source for the sub picture. Each press of **PIP INPUT** button is pressed, each input source for the sub picture is displayed as shown below.

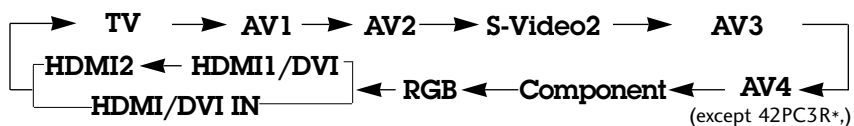

Sub Picture Size Adjustment (PIP mode only)

Repeatedly press the **SIZE** button to select the desired sub picture size.

Moving the Sub Picture (PIP mode only)

Press the **POSITION** button repeatedly until desired position is achieved. The sub picture moves clockwise.

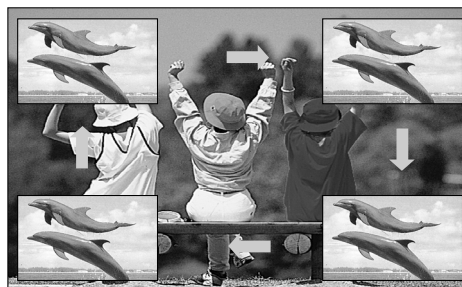

Adjusting PIP Transparency (PIP mode only)

- 1 Press the **MENU** button and then **▲ / ▼** button to select the **SCREEN** menu.
- 2 Press the **▶** button and then **▲ / ▼** button to select **PIP Transparency**.
- 3 Press the **▶** button and then **◀ / ▶** button to adjust **PIP Transparency**.
- 4 Press the **EXIT** button to return to normal TV viewing.

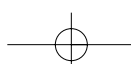

SPECIAL FUNCTIONS

PIP (PICTURE-IN-PICTURE)/DOUBLE WINDOW/POP

Swapping between main and sub pictures

Press the **SWAP** button to exchange the main and sub pictures.



POP (Picture-out-of-Picture: Programme Scan)

Use POP to search the programmes of all the memorized channels one-by-one on the 3 POP screen display, (while the main picture source remains the current channel). The pictures of all the programmed channels are searched with the 3 POP screen. When watching TV for main picture, same TV programme for sub pictures are scanned.



TELETEXT

Teletext (or TOPtext) is an optional function, therefore only a set with the teletext system can receive the teletext broadcast.

Teletext is a free service broadcast by most TV stations which gives up-to-the-minute information on news, weather, television programmes, share prices and many other topics.

The teletext decoder of this TV can support the SIMPLE, TOP and FASTEXT systems. SIMPLE (standard teletext) consists of a number of pages which are selected by directly entering the corresponding page number. TOP and FASTEXT are more modern methods allowing quick and easy selection of teletext information.

Teletext Language Selection (option)

- ① Press the **MENU** button and then use **▲ / ▼** button to select the **SPECIAL** menu.
- ② Press the **▶** button and then use **▲ / ▼** button to select **Language**.
- ③ Press the **▶** button and then use **▶** button to select **Teletext**.
- ④ Press the **▲ / ▼** button to select the required language.
- ⑤ Repeatedly press the **MENU** button to return to normal TV viewing.

! NOTE

- a. Please select your local teletext language.
- b. If you don't, the teletext may not appear correctly on the screen.
- c. This feature is not available in all countries.

Switch on/off

Press the **TEXT** button to switch to teletext. The initial page or last page appears on the screen.

Two page numbers, TV station name, date and time are displayed on the screen headline. The first page number indicates your selection, while the second shows the current page displayed.

Press the **TEXT** or **EXIT** button to switch off teletext. The previous mode reappears.

SIMPLE Text

■ Page selection

- ① Enter the desired page number as a three digit number with the **NUMBER** buttons. If during selection you press a wrong number, you must complete the three digit number and then re-enter the correct page number.
- ② The **PR+/-** button can be used to select the preceding or following page.

SPECIAL FUNCTIONS

TELETEXT

TOP Text

The user guide displays four fields-red, green, yellow and blue at the bottom of the screen. The yellow field denotes the next group and the blue field indicates the next block.

■ Block / group / page selection

1. With the blue button you can progress from block to block.
2. Use the yellow button to proceed to the next group with automatic overflow to the next block.
3. With the green button you can proceed to the next existing page with automatic overflow to the next group. Alternatively the **PR+** button can be used.
4. The red button permits to return to previous selection. Alternatively the **PR-** button can be used.

■ Direct page selection

Corresponding to the SIMPLE teletext mode, you can select a page by entering it as a three digit number using the NUMBER buttons in TOP mode.

FASTEXT

The teletext pages are colour coded along the bottom of the screen and are selected by pressing the corresponding coloured button.

■ Page selection

1. Press the  INDEX button to select the index page.
2. You can select the pages which are colour coded along the bottom line with the same coloured buttons.
3. Corresponding to the SIMPLE teletext mode, you can select a page by entering its three digit page number with the NUMBER buttons in FASTEXT mode.
4. The **PR+/-** button can be used to select the preceding or following page.

Special Teletext Functions



■ REVEAL

Press this button to display concealed information, such as solutions of riddles or puzzles.
Press this button again to remove the information from the display.



■ SIZE

Selects double height text.
Press this button to enlarge the top half of the page.
Press this button again to enlarge the bottom half of the page.
Press this button again to return to the normal display.



■ UPDATE

Displays the TV picture on the screen while waiting for the new teletext page. The display will appear at the top left hand corner of the screen. When the updated page is available then display will change to the page number.
Press this button to view the updated teletext page.



■ TIME

When viewing a TV programme, press this button to display the time at the top right hand corner of the screen.
Press this button again to remove the display. In the teletext mode, press this button to select a sub page number. The sub page number is displayed at the bottom of the screen. To hold or change the sub page, press the RED/GREEN, ◀ / ▶ or NUMBER buttons.
Press again to exit this function.



■ HOLD

Stops the automatic page change which will occur if a teletext page consists of 2 or more sub pages. The number of sub pages and the sub page displayed is, usually, shown on the screen below the time. When this button is pressed the stop symbol is displayed at the top left-hand corner of the screen and the automatic page change is inhibited.
To continue press this button again.

TV MENU

ON SCREEN MENUS SELECTION AND ADJUSTMENT

Your TV's OSD (On Screen Display) may differ slightly from what is shown in this manual.

- 1 Press the **MENU** button and then **▲ / ▼** button to display each menu.
- 2 Press the **▶** button and then **▲ / ▼** button to select a menu item.
- 3 Change the setting of an item in the sub or pull-down menu with **◀ / ▶** button. You can move to the higher level menu by pressing the **OK** or **MENU** button.

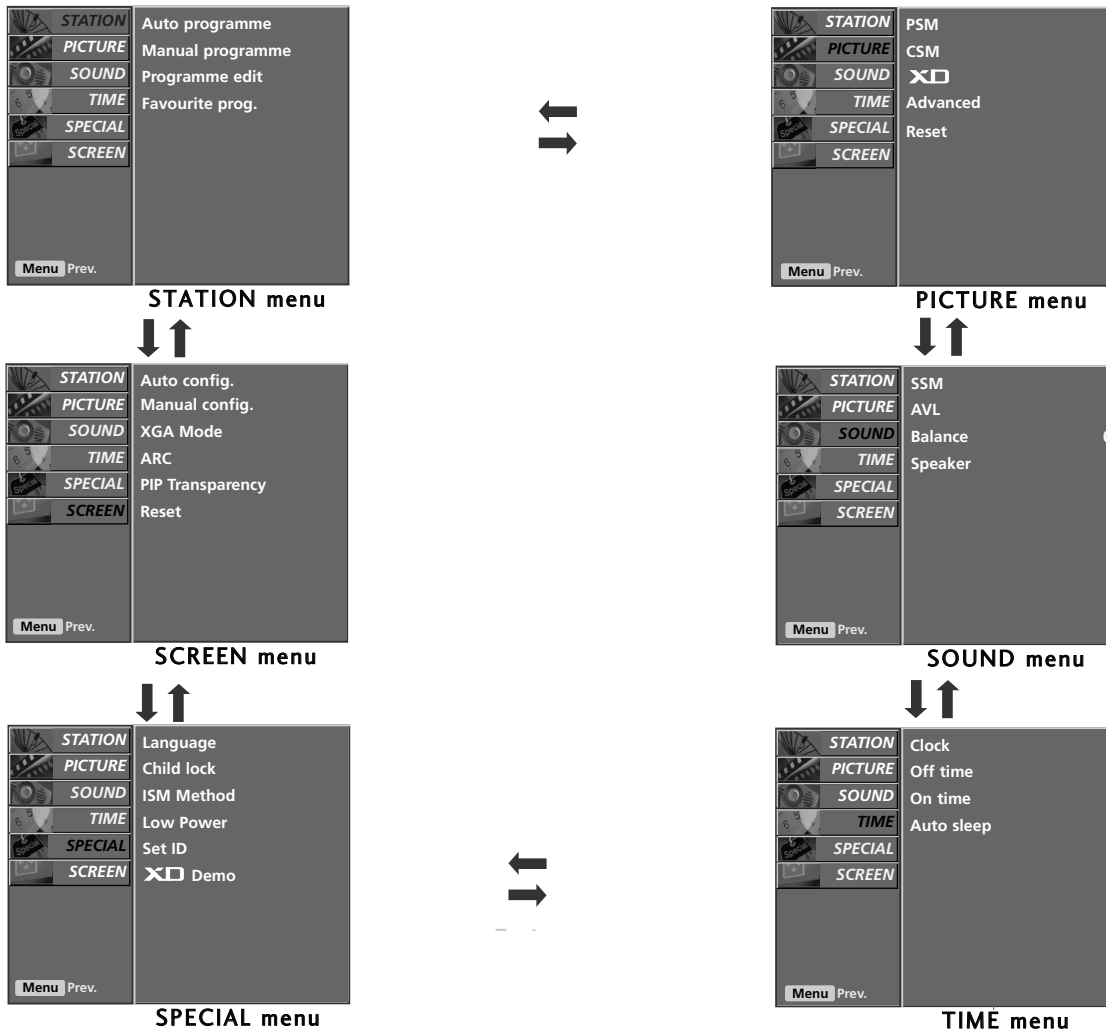

! NOTE

- a. The OSD (On Screen Display) function enables you to adjust the screen status conveniently since it provides graphical presentation.
- b. In this manual, the OSD (On Screen Display) may be different from your TV's because it is just example to help the TV operation.
(The OSD mainly use pictures for the 42PC1R*, 42PC3R*, 50PC1R*.)
- c. In the teletext mode, menus are not displayed.
- d. In some models, **XGA** will display on the **SCREEN** menu.
- e. It's not available to use **ISM Method** and **Low Power** in LCD TV models.

TV MENU | Setting up TV stations

AUTO PROGRAMME TUNING

Up to 100 TV stations can be stored by programme numbers (0 to 99). Once you have preset the stations, you will be able to use the PR +/- or NUMBER buttons to scan the stations you have programmed.

Stations can be tuned using automatic or manual modes.

All stations that can be received are stored by this method. It is recommended that you use auto programme during installation of this set.



- 1 Press the **MENU** button and then **▲ / ▼** button to select the **STATION** menu.
- 2 Press the **▶** button and then **▲ / ▼** button to select **Auto programme**.
- 3 Press the **▶** button and then **▲ / ▼** button to select **System**.
- 4 Press the **◀ / ▶** button to select a TV system menu;
 - L** : SECAM L/L' (France)
 - BG** : PAL B/G, SECAM B/G (Europe / East Europe / Asia / New Zealand / M.East / Africa / Australia)
 - I** : PAL I/II (U.K. / Ireland / Hong Kong / South Africa)
 - DK** : PAL D/K, SECAM D/K (East Europe / China / Africa / CIS)
 - M** : (USA / Korea / Philippines) (option)
- 5 Press the **▲ / ▼** button to select **Storage from**.
- 6 Press the **◀ / ▶** button or NUMBER buttons to select the beginning programme number. If you use NUMBER buttons, any number under 10 is entered with a numeric '0' in front of it, i.e. '05' for 5.
- 7 Press the **▲ / ▼** button to select **Start**.
- 8 Press the **▶** button to begin auto programming. All receivable stations are stored. The station name is stored for stations which broadcast VPS (Video Programme Service), PDC (Programme Delivery Control) or TELETXT data. If no station name can be assigned to a station, the channel number is assigned and stored as **C** (V/UHF 01 -69) or **S** (Cable 01 -47), followed by a number.

To stop auto programming, press the **MENU** button. When auto programming is completed, the Programme edit menu appears on the screen. See the Programme edit section to edit the stored programme.
- 9 Press the **EXIT** button to return to normal TV viewing.



1

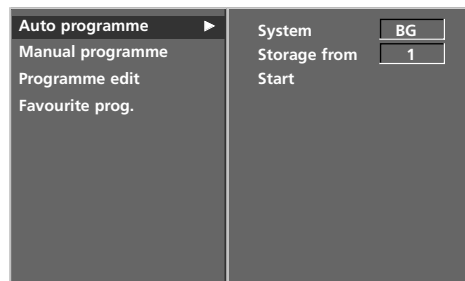

2 ~ 7

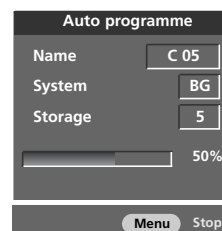

8

TV MENU

TV MENU | Setting up TV stations

MANUAL PROGRAMME TUNING

Manual programme lets you manually tune and arrange the stations in whatever order you desire.



- 1 Press the **MENU** button and then **▲ / ▼** button to select the **STATION** menu.
- 2 Press the **▶** button and then **▲ / ▼** button to select **Manual programme**.
- 3 Press the **▶** button and then **▲ / ▼** button to select **Storage**.
- 4 Press the **◀ / ▶** button or **NUMBER** buttons to select the desired programme number (0 to 99). If you use **NUMBER** buttons, any number under 10 is entered with a numeric '0' in front of it, i.e. '05' for 5.
- 5 Press the **▲ / ▼** button to select **System**.
- 6 Press the **◀ / ▶** button to select a TV system menu;
 - L** : SECAM L/L' (France)
 - BG** : PAL B/G, SECAM B/G (Europe / East Europe / Asia / New Zealand / M.East / Africa / Australia)
 - I** : PAL I/II (U.K. / Ireland / Hong Kong / South Africa)
 - DK** : PAL D/K, SECAM D/K (East Europe / China / Africa / CIS)
 - M** : (USA / Korea / Philippines) (option)
- 7 Press the **▲ / ▼** button to select **Band**.
- 8 Press the **◀ / ▶** button to select **V/UHF** or **Cable**.
- 9 Press the **▲ / ▼** button to select **Channel**.
- 10 You can select the desired programme number with the **◀ / ▶** button or number buttons. If possible, select the programme number directly with the number buttons. Any number under 10 is entered with a numeric '0' in front of it, i.e. '05' for 5.
- 11 Press the **▲ / ▼** button to select **Search**.
- 12 Press the **◀ / ▶** button to commence searching. If a station is found the search will stop.
- 13 Press the **OK** button to store it.
- 14 To store another station, repeat steps 3 to 13.
- 15 Press the **EXIT** button to return to normal TV viewing.



1

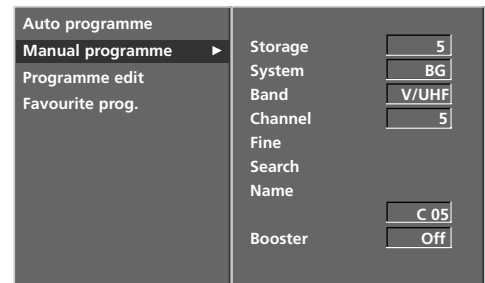

2 ~ 12

FINE TUNING

Normally fine tuning is only necessary if reception is poor.

- 1 Press the **MENU** button and then **▲ / ▼** button to select the **STATION** menu.
- 2 Press the **▶** button and then **▲ / ▼** button to select **Manual programme**.
- 3 Press the **▶** button and then **▲ / ▼** button to select **Fine**.
- 4 Press the **◀ / ▶** button to to fine tune for the best picture and sound.
- 5 Press the **OK** button to store it.
- 6 Press the **EXIT** button to return to normal TV viewing.

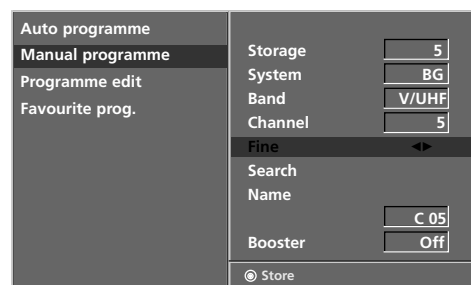

2 ~ 5

TV MENU

TV MENU | Setting up TV stations

ASSIGNING A STATION NAME

You can assign a station name with five characters to each programme number.



- 1 Press the **MENU** button and then **▲ / ▼** button to select the **STATION** menu.
- 2 Press the **▶** button and then **▲ / ▼** button to select **Manual programme**.
- 3 Press the **▶** button and then **▲ / ▼** button to select **Name**.
- 4 Press the **▶** button and then **▲ / ▼** button. You can use a blank, **+**, **-**, the number **0** to **9** and the alphabet **A** to **Z**.
- 5 Press the **◀ / ▶** button to select the position and make your choice of the second character, and so on.
- 6 Press the **OK** button to store it.
- 7 Press the **EXIT** button to return to normal TV viewing.



1

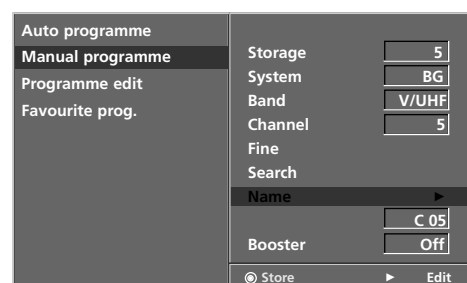

2 ~ 6

BOOSTER (Option)

In some models, **Booster** is an optional function. Only a set with **Booster** can perform this function.

If the reception is poor at the fringe area of TV signal, select **Booster** to **On**.



1 Press the **MENU** button and then **▲ / ▼** button to select the **STATION** menu.

2 Press the **▶** button and then use **▲ / ▼** button to select **Booster**.

3 Press the **▶** button and then use **◀ / ▶** button to select **On** or **Off**.

4 Press the **EXIT** button to return to normal TV viewing.



1

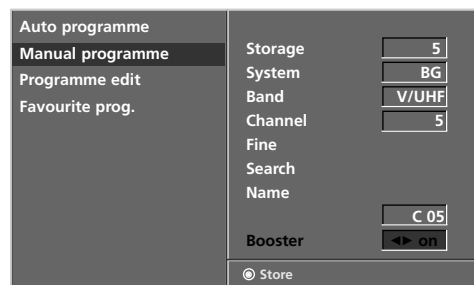

2 3

TV MENU

TV MENU | Setting up TV stations

PROGRAMME EDIT

This function enables you to delete or skip the stored programmes. Also you can move some stations to other programme numbers or copy a blank station data into the selected programme number.



- 1 Press the **MENU** button and then **▲ / ▼** button to select the **STATION** menu.
- 2 Press the **▶** button and then **▲ / ▼** button to select **Programme edit**.
- 3 Press the **▶** button to display the Programme edit menu.

■ Deleting a programme

1. Select a programme to be deleted with the **▲ / ▼ / ◀ / ▶** button.
2. Press the **RED** button twice.
The selected programme is deleted, all the following programmes are shifted up one position.

■ Copying a programme

1. Select a programme to be copied with the **▲ / ▼ / ◀ / ▶** button.
2. Press the **GREEN** button.
All the following programmes are shifted down one position.

■ Moving a programme

1. Select a programme to be moved with the **▲ / ▼ / ◀ / ▶** button.
2. Press the **YELLOW** button.
3. Move the programme to the desired programme number with the **▲ / ▼ / ◀ / ▶** button.
4. Press the **YELLOW** button again to release this function.

■ Skipping a programme number

1. Select a programme number to be skipped with the **▲ / ▼ / ◀ / ▶** button.
2. Press the **BLUE** button. The skipped programme turns to blue.
3. Press the **BLUE** button again to release the skipped programme.
When a programme number is skipped it means that you will be unable to select it using the **▲ / ▼** button during normal TV viewing. If you want to select the skipped programme, directly enter the programme number with the **NUMBER** buttons or select it in the programme edit or table menu.

- 4 Press the **EXIT** button to return to normal TV viewing.



1



2

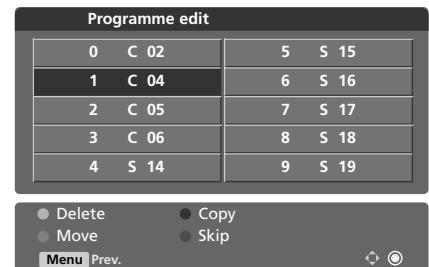

3

FAVOURITE PROGRAMME

This function lets you select your favourite programmes directly.

Repeatedly press the **FAV** button to select stored favourite programmes.



- 1 Press the **MENU** button and then **▲ / ▼** button to select the **STATION** menu.
- 2 Press the **▶** button and then **▲ / ▼** button to select **Favourite prog.**
- 3 Press the **▶** button.
- 4 Press the **▲ / ▼** button to select - - - - -.
- 5 Select a desired programme with the **◀ / ▶** button or **NUMBER** buttons. Any number under 10 is entered with a numeric '0' in front of it, i.e. '05' for 5.
- 6 To store another programme, repeat steps 4 to 5. You can store up to 8 programmes.
- 7 Press the **EXIT** button to return to normal TV viewing.

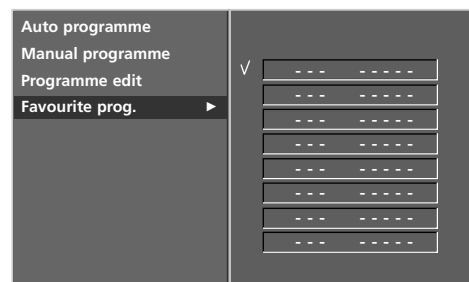

2 ~ 5

TV MENU

TV MENU | Setting up TV stations

CALLING THE PROGRAMME TABLE

You can check the programmes stored in the memory by displaying the programme table.

■ Displaying programme table

Press the **LIST** button to display the Programme table menu.

The programme table appears on the screen.

One programme table contains ten programmes as below.

! NOTE

- a. You may find some blue programmes. They have been set up to be skipped by auto programming or in the programme edit mode.
- b. Some programmes with the channel number shown in the programme table indicate there is no station name assigned.

■ Selecting a programme in the programme table

Select a programme with the **▲ / ▼ / ◀ / ▶** button.

Then press the **OK** button. The set switches to the chosen programme number.

■ Paging through a programme table

There are 10 programme table pages in which contain 100 programmes.

Pressing the **▲ / ▼ / ◀ / ▶** button repeatedly turns the pages.

Press the **LIST** button to return to normal TV viewing.



0	C 02	5	S 15
1	C 04	6	S 16
2	C 05	7	S 17
3	C 06	8	S 18
4	S 14	9	S 19

TV MENU | Picture Menu

PSM (Picture Status Memory)

- Dynamic** Select this option to display with a sharp image.
- Standard** The most general and natural screen display status.
- Mild** Select this option to display with a mild image.
- User 1/2** Select this option to use the user-defined setting.



1 Press the **MENU** button and then **▲ / ▼** button to select the **PICTURE** menu.

2 Press the **▶** button and then **▲ / ▼** button to select **PSM**.

3 Press the **▶** button and then **▲ / ▼** button to select **Dynamic, Standard, Mild, User 1, or User 2**.

4 Press the **EXIT** button to return to normal TV viewing.

- PSM adjusts the TV for the best picture appearance. Select the preset value in the PSM menu based on the programme category.
- When adjusting User options (contrast, brightness, colour, and sharpness, tint) manually, PSM automatically changes to **User**.
- **Dynamic, Standard** and **Mild**, are programmed for optimum picture reproduction at the factory and cannot be changed.

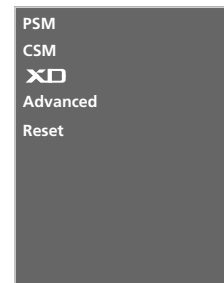

TV MENU | Picture Menu

PICTURE ADJUSTMENT (PSM-User option)

- Contrast** Adjusts the difference between the light and dark levels in the picture.
- Brightness** Increases or decreases amount of white in the your picture.
- Colour** Adjusts intensity of all colours.
- Sharpness** Adjusts the level of crispness in the edges between the light and dark areas of the picture. The lower the level, the softer the image.
- Tint** Adjusts the balance between red and green levels.



- 1 Press the **MENU** button and then **▲ / ▼** button to select the **PICTURE** menu.
- 2 Press the **▶** button and then **▲ / ▼** button to select **PSM**.
- 3 Press the **▶** button and then **▲ / ▼** button to select **User 1**, or **User 2**.
- 4 Press the **▶** button and then **▲ / ▼** button to select the desired picture option (**Contrast**, **Brightness**, **Colour**, **Sharpness**, or **Tint**).
- 5 Press the **◀ / ▶** button to make appropriate adjustments.
- 6 Press the **EXIT** button to return to normal TV viewing.

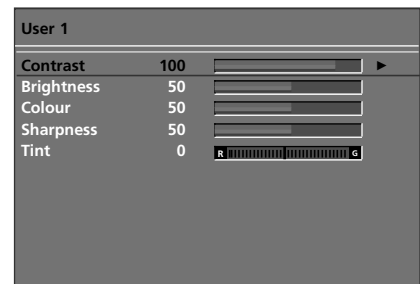
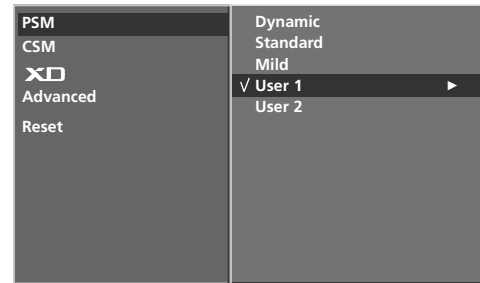

! NOTE

You can't adjust, colour, sparpness and tint in the RGB-PC, HDMI-PC mode to the levels you prefer.

CSM (Colour Status Memory)

To initialize values (reset to default settings), select the **Normal** option.

Choose one of three automatic colour adjustments. Set to warm to enhance hotter colours such as red, or set to cool to see less intense colours with more blue.



- 1 Press the **MENU** button and then ▲ / ▼ button to select the **PICTURE** menu.
- 2 Press the ► button and then ▲ / ▼ button to select **CSM**.
- 3 Press the ► button and then ▲ / ▼ button to select either **Cool**, **Normal**, **Warm**, or **User**.
- 4 Press the **EXIT** button to return to normal TV viewing.

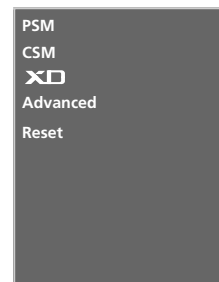

1

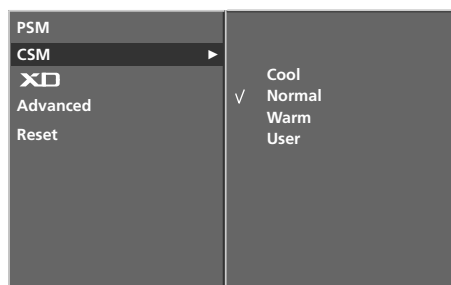

2 3

TV MENU

TV MENU | Picture Menu

MANUAL COLOUR TEMPERATURE CONTROL (CSM - User Option)

You can adjust red, green, blue to any colour temperature you prefer.



- 1 Press the **MENU** button and then ▲ / ▼ button to select the **PICTURE** menu.
- 2 Press the ► button and then ▲ / ▼ button to select **CSM**.
- 3 Press the ► button and then ▲ / ▼ button to select **User**.
- 4 Press the ► button and then ▲ / ▼ button to select **Red, Green, or Blue**.
- 5 Press the ◀ / ▶ button to make appropriate adjustments.
- 6 Press the **EXIT** button to return to normal TV viewing.

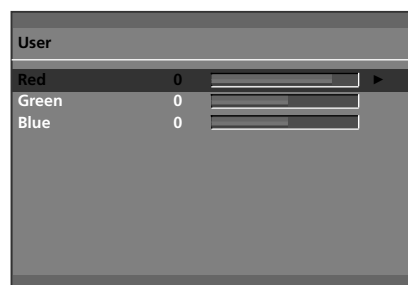

3 ~ 5

XD FUNCTION

XD is LG electronic's unique picture improving technology to display a real HD source through an advanced digital signal processing algorithm.

This menu is activated after selecting the **User1** or **User2** of **PSM**.



- 1 Press the **MENU** button and then **▲ / ▼** button to select the **PICTURE** menu.
- 2 Press the **▶** button and then **▲ / ▼** button to select **XD**.
- 3 Press the **▶** button and then **▲ / ▼** button to select **Manual**.
- 4 Press the **▶** button and then **▲ / ▼** button to select **XD Contrast**, **XD Colour**, **XD NR** or **MPEG NR**.
- 5 Press the **◀ / ▶** button to make appropriate adjustments.
- 6 Press the **EXIT** button to return to normal TV viewing.

- **XD Contrast** : Optimizing the contrast auto-matically according to the brightness of the reflection.
- **XD Color** : Adjusting the colors of the reflection auto-matically to reproduce as closely as possible to the natural colors.
- **XD NR** : Removing the noise up to the point where it does not damage the original picture.
- **MPEG NR** :To reduce the picture noise which may appear on the screen during watching the TV.



1

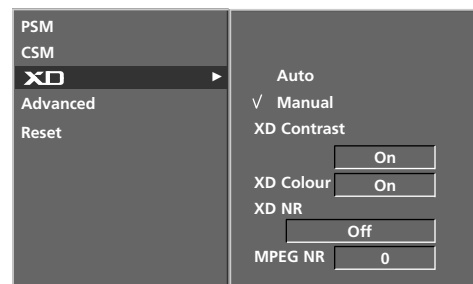

2 3

TV MENU

TV MENU | Picture Menu

ADVANCED

When you watch the movie, this function adjusts the set to the best picture appearance. Adjusting the contrast and the brightness of the screen using the black level of the screen.

Cinema- function works in the following mode:
TV, AV1, AV2, S-Video2, AV3, AV4(Optional) or Component 480i/576i.

Black Level- function works in the following mode:
AV(NTSC), HDMI[PC/DTV].



- 1 Press the **MENU** button and then **▲ / ▼** button to select the **PICTURE** menu.

- 2 Press the **▶** button and then **▲ / ▼** button to select **Advanced**.

- 3 Press the **▶** button and then **▲ / ▼** button to select **Cinema** or **Black Level**.

- 4 Press the **◀ / ▶** button to select **On, Off, Low** or **high**.
 - **Auto** : Realizing the black level of the screen and set it to High or Low automatically.
 - **Low** : The reflection of the screen gets darker.
 - **High** : The reflection of the screen gets brighter.

- 5 Press the **EXIT** button to return to normal TV viewing.

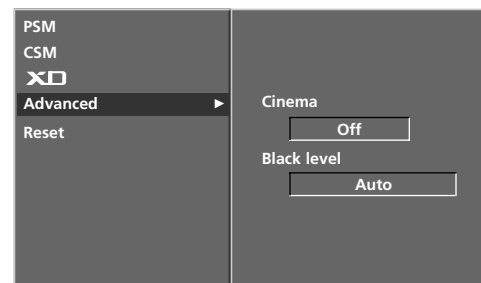
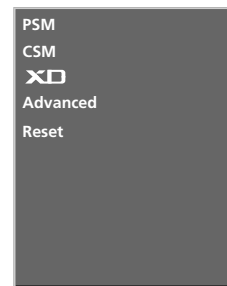

RESET

- 1 Press the **MENU** button and then ▲ / ▼ button to select the **PICTURE** menu.
- 2 Press the ► button and then ▲ / ▼ button to select **Reset**.
- 3 Press the ► button to initialize the adjusted value.
 - Returns to the default settings PSM, CSM, XD, Advanced at the factory.



1

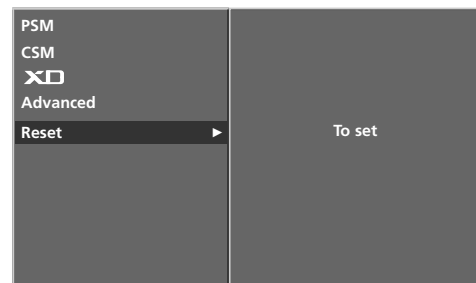

2 3

TV MENU

TV MENU | Sound Menu

SSM (Sound Status Memory)

You can select your preferred sound setting; Surround MAX, Flat, Music, Movie or Sports and you can also adjust the sound frequency of the equalizer.

SSM lets you enjoy the best sound without any special adjustment because the TV sets the appropriate sound options based on the programme content.

When adjusting sound equalizer manually, SSM automatically switches **User**.

Surround MAX, Flat, Music, Movie and Sports are preset for good sound quality at the factory and are not adjustable.

- Surround MAX** Select this option to sound realistic.
- Flat** The most commanding and natural audio.
- Music** Select this option to enjoy the original sound when listening to the music.
- Movie** Select this option to enjoy sublime sound.
- Sports** Select this option to watch sports broadcasting.
- User** Select this option to use the user-defined audio settings.

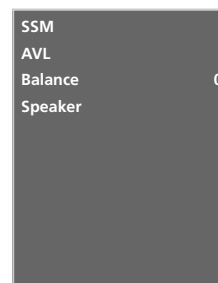

1

- 1 Press the **MENU** button and then **▲ / ▼** button to select the **SOUND** menu.
- 2 Press the **▶** button and then **▲ / ▼** button to select **SSM**.
- 3 Press the **▶** button and then **▲ / ▼** button to select **Surround MAX, Flat, Music, Movie, Sports, or User**.
- 4 Press the **EXIT** button to return to normal TV viewing.

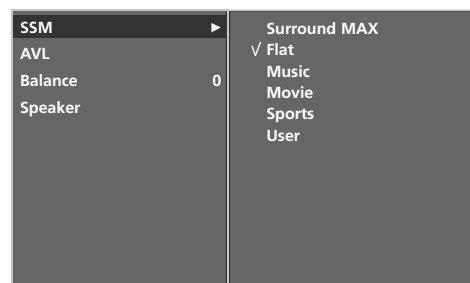

2 3

SOUND FREQUENCY ADJUSTMENT (SSM - User option)

Adjust the sound equalizer.

- 1 Press the **MENU** button and then **▲ / ▼** button to select the **SOUND** menu.
- 2 Press the **▶** button and then **▲ / ▼** button to select **SSM**.
- 3 Press the **▶** button and then **▲ / ▼** button to select **User**.
- 4 Press the **▶** button.
- 5 Select a sound band by pressing the **▲ / ▼** button.
Make appropriate sound level with the **◀ / ▶** button.
- 6 Press the **EXIT** button to return to normal TV viewing.

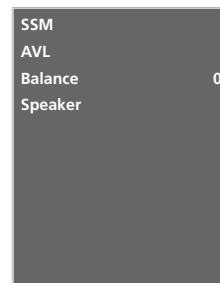

1

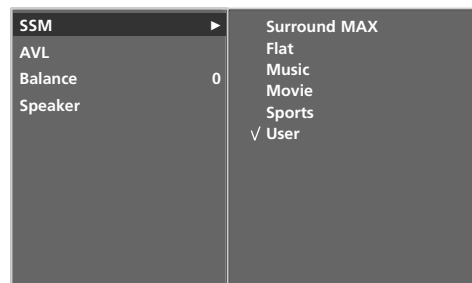

2 ~ 4

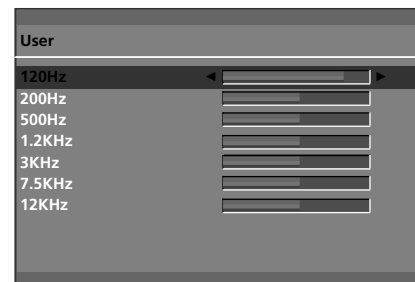

5

TV MENU

TV MENU | Sound Menu

AVL (Auto Volume Leveler)

AVL automatically keeps on an equal volume level even if you change programmes.



- 1 Press the **MENU** button and then ▲ / ▼ button to select the **SOUND** menu.
- 2 Press the ► button and then ▲ / ▼ button to select **AVL**.
- 3 Press the ► button and then ▲ / ▼ button to select **On** or **Off**.
- 4 Press the **EXIT** button to return to normal TV viewing.

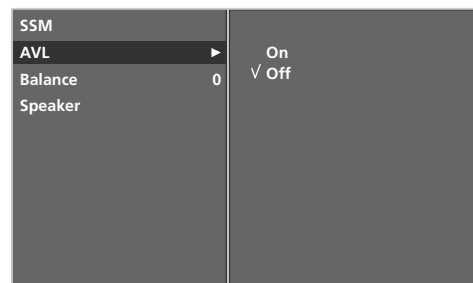
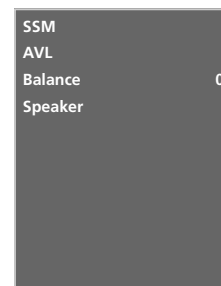

BALANCE ADJUSTMENT

You can adjust the sound balance of speaker to the levels you prefer.

- 1 Press the **MENU** button and then ▲ / ▼ button to select the **SOUND** menu.
- 2 Press the ► button and then ▲ / ▼ button to select **Balance**.
- 3 Press the ► button and then ◀ / ▶ button to make desired adjustment.
- 4 Press the **EXIT** button to return to normal TV viewing.

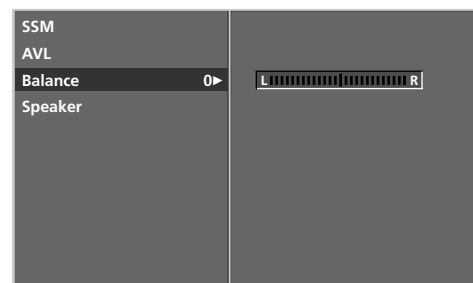

SPEAKER

You can adjust the internal speaker status.

In AV1, AV2, S-Video2, AV3, AV4(Option), COMPONENT, RGB and HDMI1/DVI with HDMI to DVI cable, TV speaker and/or variable audio can be outputted even though there is no video signal.

If you want to use your external hi-fi stereo system, turn off the internal speakers of the set.



- 1 Press the **MENU** button and then ▲ / ▼ button to select the **SOUND** menu.
- 2 Press the ► button and then ▲ / ▼ button to select **Speaker**.
- 3 Press the ► button and then ▲ / ▼ button to select **On** or **Off**.
- 4 Press the **EXIT** button to return to normal TV viewing.

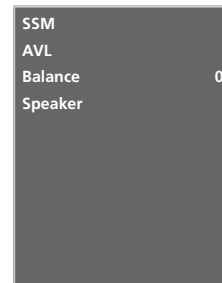

1

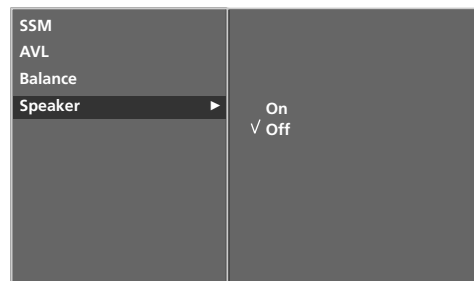

2 3

TV MENU

TV MENU | Sound Menu

STEREO/DUAL RECEPTION

When a programme is selected, the sound information for the station appears after the programme number and station name disappear.

- DUAL I** Sends the primary broadcast language to the loudspeakers.
- DUAL II** Sends the secondary broadcast language to the loudspeakers.
- DUAL I+II** Sends a separate language to each loudspeaker.

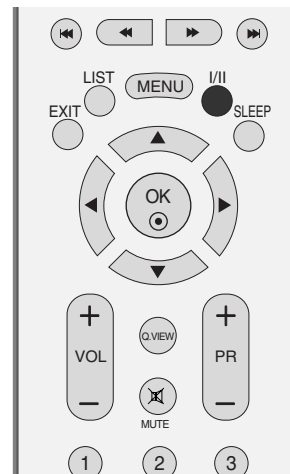

Broadcast	On Screen Display
Mono	MONO
Stereo	STEREO
Dual	DUAL I

■ **Mono sound selection**

If the stereo signal is weak in stereo reception, you can switch to mono by pressing the **I/II** button twice. In mono reception, the depth of sound is improved. To switch back to stereo, press the **I/II** button twice again.

■ **Language selection for dual language broadcast**

If a programme received two languages (dual language), you can switch to **DUAL I**, **DUAL II** or **DUAL I+II** by pressing the **I/II** button repeatedly.

NICAM RECEPTION

If the set is equipped with the receiver for NICAM reception, the high quality NICAM (Near Instantaneous Companding Audio Multiplex) digital sound can be received.

Sound output can be selected according to the type of received broadcast as follows by pressing the **I/II** button repeatedly.

-
- 1 When NICAM mono is received, you can select **NICAM MONO** or FM MONO.
 - 2 When NICAM stereo is received, you can select **NICAM STEREO** or FM MONO.
If the stereo signal is weak, switch to FM mono.
 - 3 When NICAM dual is received, you can select **NICAM DUAL I**, **NICAM DUAL II** or **NICAM DUAL I+II** or **MONO**.
-

SPEAKER SOUND OUTPUT SELECTION

In AV1, AV2, S-Video2, AV3, AV4(Option), Component, RGB, HDMI1/DVI or HDMI 2 mode, you can select output sound for the left and right loudspeakers.

Repeatedly press the **I/II** button to select the sound output.

L+R: Audio signal from audio L input is sent to the left loud speaker and audio signal from audio R input is sent to the right loud speaker.

L+L: Audio signal from audio L input is sent to left and right loud speakers.

R+R: Audio signal from audio R input is sent to left and right loud speakers.

TV MENU | Time Menu

CLOCK SETUP

You must set the time correctly before using on/off time function.

If current time setting is erased by a power failure or the set is unplugged, reset the clock.



- 1 Press the **MENU** button and then ▲ / ▼ button to select the **TIME** menu.

- 2 Press the ► button and then ▲ / ▼ button to select **Clock**.

- 3 Press the ► button and then ▲ / ▼ button to set the hour.

- 4 Press the ► button and then ▲ / ▼ button to set the minutes.

- 5 Press the **EXIT** button to return to normal TV viewing.

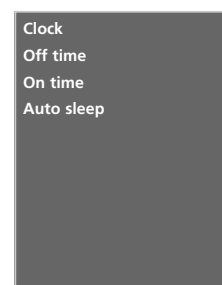

1



2 ~ 4

ON/OFF TIME

The Off time automatically switches the set to standby at the preset time.

Two hours after the set is switched on by the on time function it will automatically switch back to standby mode unless a button has been pressed.

Once the on time/off time is set, these functions operate daily at the preset time.

Off time function overrides On timer function if they are set both to the same time.

The set must be in standby mode for the On timer to work.



- 1 Press the **MENU** button and then ▲ / ▼ button to select the **TIME** menu.

- 2 Press the ► button and then ▲ / ▼ button to select **Off time/On time**.

- 3 Press the ► button and then ▲ / ▼ button to select **On**.
 - To cancel **On/Off timer** function, select **Off**.

- 4 Press the ► button and then ▲ / ▼ button to set the hour.

- 5 Press the ► button and then ▲ / ▼ button to set the minutes.

- 6 **For only On timer function**
 - **Programme:** Press the ► button and then ▲ / ▼ button to select the programme.
 - **Volume:** Press the ► button and then ▲ / ▼ button to adjust volume level at turn-on.

- 7 Press the **EXIT** button to return to normal TV viewing.

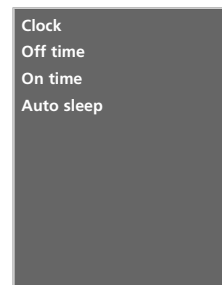

1



2 3

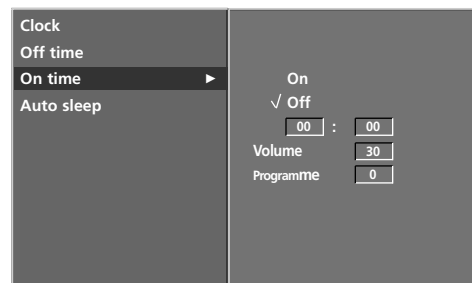

4 ~ 6

TV MENU

TV MENU | Time Menu

AUTO SLEEP

If set to on and there is no input signal, the TV turns off automatically after 10 minutes.



- 1 Press the **MENU** button and then ▲ / ▼ button to select the **TIME** menu.
- 2 Press the ► button and then ▲ / ▼ button to select **Auto sleep**.
- 3 Press the ► button and then ▲ / ▼ button to select **On** or **Off**.
- 4 Press the **EXIT** button to return to normal TV viewing.

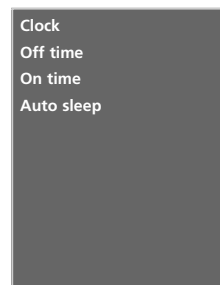

1



2 3

SLEEP TIMER

You don't have to remember to switch the set off before you go to sleep.

The sleep timer automatically switches the set to standby after the preset time has elapsed.

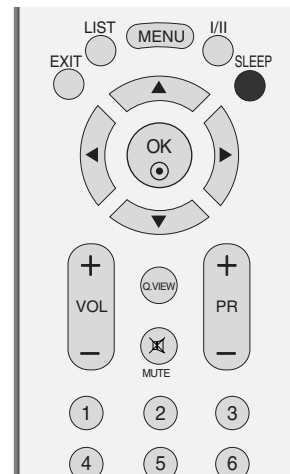

- 1 Press the **SLEEP** button repeatedly to select the number of minutes. The display '🕒 z z - - -Min' will appear on the screen, followed by 10, 20, 30, 60, 90, 120, 180 and 240.

- When the number of minutes you want is displayed on the screen, the timer begins to count down from the number of minutes selected.
- To view the remaining sleep time, press the **SLEEP** button once.
- To cancel the sleep time, repeatedly press the **SLEEP** button until the display '🕒 z z - - -Min' appears.
- When you switch the set off, the set releases the preset sleep time.

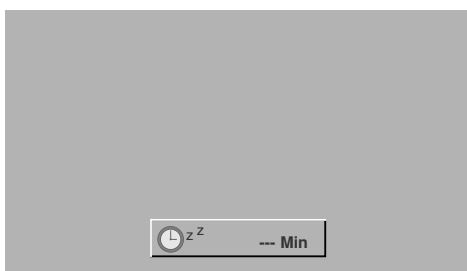

TV MENU | Special Menu

CHILD LOCK

The TV can be set so that the remote control is needed to control it.
 This feature can be used to prevent unauthorized viewing.
 This set is programmed to remember which option it was last set to even if you turn the set off.



- 1 Press the **MENU** button and then ▲ / ▼ button to select the **SPECIAL** menu.
- 2 Press the ► button and then ▲ / ▼ button to select **Child lock**.
- 3 Press the ► button and then ▲ / ▼ button to select **On** or **Off**.
- 4 Press the **EXIT** button to return to normal TV viewing.



1



2 3

NOTE

- In **Child lock 'On'**, if the set is turned off, press the **⏻/I, INPUT, PR ▲ / ▼** button on the set or **POWER, INPUT, TV, PR +/-** or **NUMBER** buttons on the remote control.
- With the **Child lock On**, the display '⚠ **Child lock on**' appears on the screen if any button on the front panel is pressed while viewing the set.

ISM (Image Sticking Minimization) METHOD (Option)

A frozen or still picture from a PC/video game displayed on the screen for prolonged periods will result in a ghost image remaining even when you change the image. Avoid allowing a fixed image to remain on the set's screen for a long period of time.

It's not available to use this function in LCD TV models.

White wash

White wash removes permanent images from the screen.

Note: An excessive permanent image may be impossible to clear entirely with White Wash.

Orbiter

Orbiter may help prevent ghost images. However, it is best not to allow any fixed image to remain on the screen. To avoid a permanent image on the screen, the screen will move every 2 minutes.

Inversion

This is the function to invert the panel color of the screen. The panel color is automatically inverted every 30 minutes.



- 1 Press the **MENU** button and then **▲ / ▼** button to select the **SPECIAL** menu.
- 2 Press the **▶** button and then **▲ / ▼** button to select **ISM Method**.
- 3 Press the **▶** button and then **▲ / ▼** button to select either **Normal**, **White wash**, **Orbiter** or **Inversion**. If you unnecessary to set this function, set **Normal**.
- 4 Press the **EXIT** button to return to normal TV viewing.

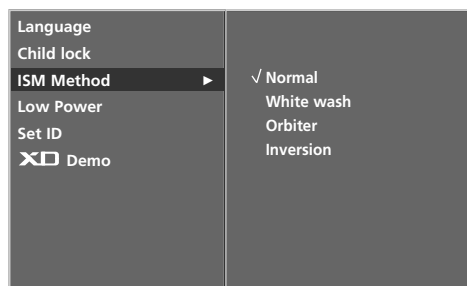
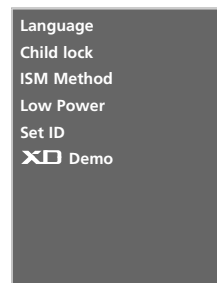

TV MENU

TV MENU | Special Menu

LOW POWER (Option)

This is the function to reduce the power consumption of the set.
It's not available to use this function in LCD TV models



- 1 Press the **MENU** button and then ▲ / ▼ button to select the **SPECIAL** menu.
- 2 Press the ► button and then ▲ / ▼ button to select **Low power**.
- 3 Press the ► button and then ▲ / ▼ button to select **On** or **Off**.
- 4 Press the **EXIT** button to return to normal TV viewing.

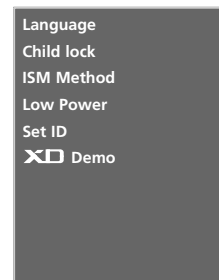

1



2 3

XD DEMO

Use it to see the difference between XD Demo on and XD Demo off.

It's not available to use this function in RGB[PC], HDMI[PC] mode.

- 1 Press the **MENU** button and then use ▲ / ▼ button to select the **SPECIAL** menu.
- 2 Press the ► button and then use ▲ / ▼ button to select **XD Demo**.
- 3 Press the ► button to begin **XD Demo**.
- 4 To stop **XD Demo**, press the **MENU** button.

* In 'Child lock Off', to stop 'XD Demo', press any button on the set.

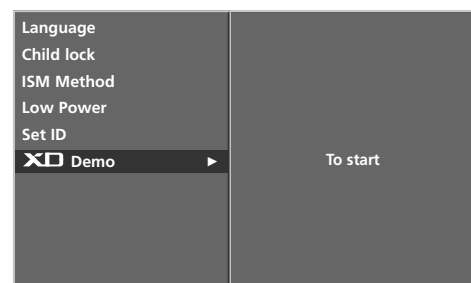

2 3

• XD Demo

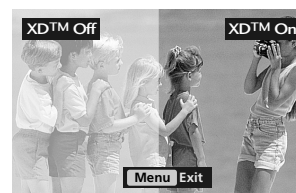

TV MENU | Screen Menu

AUTO CONFIGURE (RGB [PC] MODE ONLY)

Automatically adjusts picture position and minimizes image shaking.

Although the image is still not correct, your set is functioning properly but needs further adjustment.

The **Auto config.** functions don't need to be run for HDMI mode.

Auto configure

This function is for the automatic adjustment of the screen position, clock, and phase. The displayed image will unstable for a few seconds while the auto configuration is in progress.



1 Press the **MENU** button and then use **▲ / ▼** button to select the **SCREEN** menu.

2 Press the **▶** button and then use **▲ / ▼** button to select **Auto config.**.

3 Press the **▶** button to start **Auto config.**.

- When **Auto config.** has finished, **OK** will be shown on screen.
- If the position of the image is still not correct, try Auto adjustment again.
If picture needs to be adjusted more after Auto adjustment in RGB (PC), you can adjust the **Manual config.**.

4 Press the **EXIT** button to return to normal TV viewing.

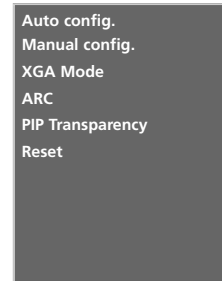

1



2 3

TV MENU

TV MENU | Screen Menu

MANUAL CONFIGURE

If the picture isn't clear after auto adjustment and especially if characters are still trembling, adjust the picture phase manually.

To correct the screen size, adjust **Clock**.

This function works in the following mode : RGB[PC].

It's not available to use Phase, Clock function in RGB[DTV], COMPONENT (480p/576p/720p/1080i), HDMI1/DVI, HDMI2(or HDMI/DVI) (480p/576p/720p/1080i) mode.

Clock This function is to minimize any vertical bars or stripes visible on the screen background. And the horizontal screen size will also change.

Phase This function allows you to remove any horizontal noise and clear or sharpen the image of characters.

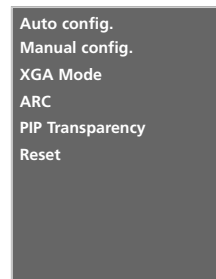

1

1 Press the **MENU** button and then use ▲ / ▼ button to select the **SCREEN** menu.

2 Press the ► button and then ▲ / ▼ button to select **Manual config.**.

3 Press the ► button and then ▲ / ▼ button to select **Phase, Clock, H-Position** or **V-Position**.

4 Press the ◀ / ▶ button to make appropriate adjustments.

5 Press the **EXIT** button to return to normal TV viewing.

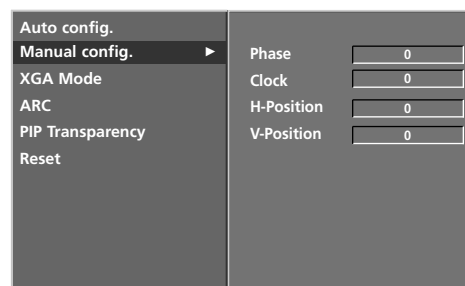

2 3 4

SETTING THE PICTURE FORMAT

You can watch the screen in various picture formats; **Spectacle**, **Full (option)**, **Original**, **4:3**, **16:9 (Wide)**, **14:9** and **Zoom1** or **Zoom2**.

If a fixed image is displayed on the screen for a long time, that fixed image may become imprinted on the screen and remain visible.

There might be uncomfortable in full mode. Then change into other mode.

You can adjust the enlarge proportion using ▲ / ▼ button.

This function works in the following signal.



- 1 Press the **MENU** button and then use ▲ / ▼ button to select the **SCREEN** menu.
- 2 Press the ► button and then use ▲ / ▼ button to select **ARC**.
- 3 Press the ► button and then use ▲ / ▼ button to select **Spectacle**, **Full(option)**, **Original**, **4:3**, **16:9**, **14:9**, **Zoom1** or **Zoom2**.

- **Spectacle**
When your TV receives the wide screen signal, when selected it will adjust the picture horizontally, in non-linear proportion, to fill the entire screen.
- **Full(option)**
When your TV receives the wide screen signal, when selected it will adjust the picture horizontally or vertically, in a linear proportion, to fill the entire screen fully.
- **Original**
When your TV receives the wide screen signal, it will be automatically changed to the picture format to be sent.
- **4:3**
Following selection will lead you to view a picture with an original 4:3 aspect ratio, with gray bars appearing at both the left and right sides.
- **16:9 (Wide)**
Following selection will lead you to adjust the picture horizontally, in a linear proportion, to fill the entire screen (useful for viewing 4:3 formatted DVDs).
- **14:9**
You can enjoy the picture format of 14:9 or general TV programme through the 14:9 mode. The screen 14:9 is viewed just like that the screen 4:3 is magnified to the left / right.

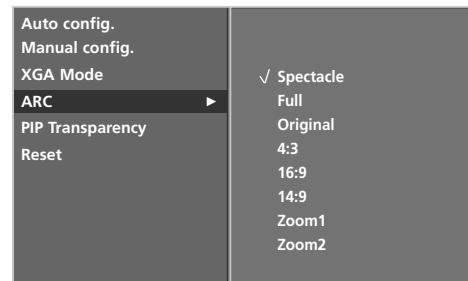
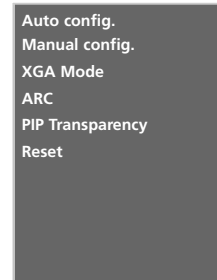

TV MENU

TV MENU | Screen Menu

SETTING THE PICTURE FORMAT

- **Zoom1**

Following selection will lead you to view the picture without any alteration, while filling the entire screen. However, the top and bottom portions of the picture will be cropped.

- **Zoom2**

Choose **Zoom2** when you want the picture to be altered, both horizontally extended and vertically cropped. The picture taking a halfway trade off between alteration and screen coverage.

-
- 4** Press the **EXIT** button to return to normal TV viewing.
-

! NOTE

- ▶ You can only select **4:3, 16:9 (Wide)** in RGB[PC], HDMI[PC] mode only.
- ▶ You can only select **4:3, 16:9 (Wide)** and **Zoom1, Zoom2** in RGB[DTV], HDMI1/DVI[DTV], HDMI2[DTV], Component mode only.

■ Scroll function (Option)

Press the **ARC** button and then use **▲ / ▼** button to move screen.

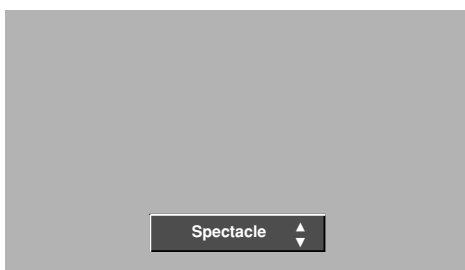

SELECTING WIDE VGA/XGA MODE

To see a normal picture, match the resolution of RGB mode and selection of VGA/XGA mode.

This function works in the following mode: RGB[PC] mode



- 1 Press the **MENU** button and then use ▲ / ▼ button to select the **SCREEN** menu.
- 2 Press the ► button and then use ▲ / ▼ button to select **XGA Mode** (or **VGA Mode**).
- 3 Press the ► button and then use ▲ / ▼ button to select the desired VGA/XGA resolution.
- 4 Press the **EXIT** button to return to normal TV viewing.

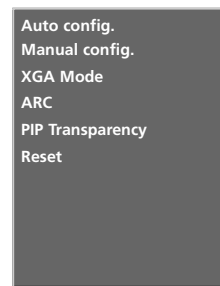

INITIALIZING (Reset to original factory settings)

2 3

This function operates in current mode.
To initialize the adjusted value

- 1 Press the **MENU** button and then ▲ / ▼ button to select the **SCREEN** menu.
- 2 Press the ► button and then ▲ / ▼ button to select **Reset**.
- 3 Press the ► button.
 - You can initialize Auto config, Manual config, Position, PIP size, PIP position, PIP Transparency.

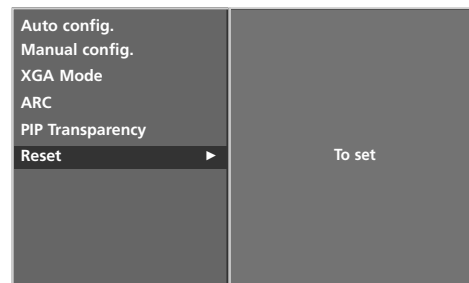

2 3

APPENDIX

EXTERNAL CONTROL DEVICE SETUP

Connect the RS-232C input jack to an external control device (such as a computer or an A/V control system) and control the Monitor's functions externally.

Connect the serial port of the control device to the RS-232C jack on the Monitor back panel. RS-232C connection cables are not supplied with the Monitor.

RS-232C Setup

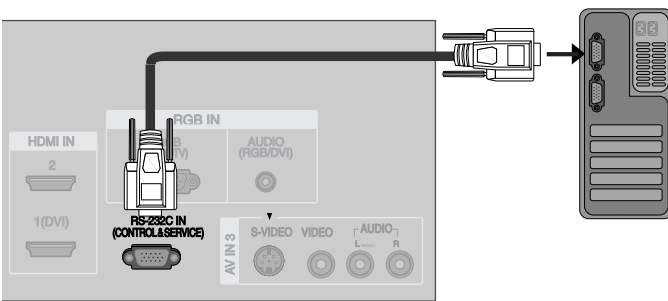

Type of Connector; D-Sub 9-Pin Male

No.	Pin Name
1	No connection
2	RXD (Receive data)
3	TXD (Transmit data)
4	DTR (DTE side ready)
5	GND
6	DSR (DCE side ready)
7	RTS (Ready to send)
8	CTS (Clear to send)
9	No Connection

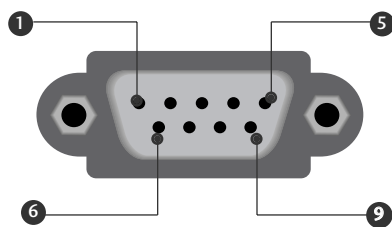

RS-232C Configurations

7-Wire Configurations (Standard RS-232C cable)

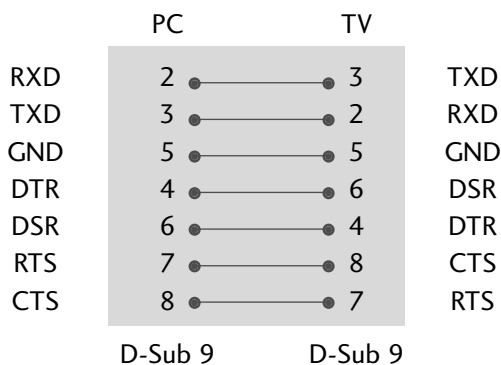

3-Wire Configurations (Not standard)

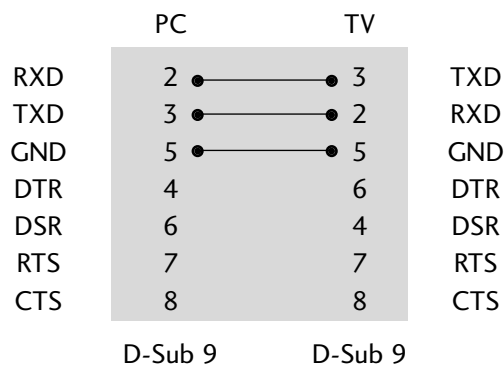

Set ID

- Use this function to specify a set ID number.
- Refer to 'Real Data Mapping 1'. See page 73.

- 1 Press the **MENU** button and then **▲ / ▼** button to select the **SPECIAL** menu.
- 2 Press the **▶** button and then use **▲ / ▼** button to select **Set ID**.
- 3 Press the **▶** button and then use **◀ / ▶** button to adjust **Set ID** to choose the desired monitor ID number.
 - The adjustment range of **Set ID** is 1 ~ 99.
- 4 Press the **EXIT** button to return to normal TV viewing.



Communication Parameters

- Baud rate : 9600 bps (UART)
- Data length : 8 bits
- Parity : None
- Stop bit : 1 bit
- Communication code : ASCII code
- Use a crossed (reverse) cable.

APPENDIX

Command Reference List

	COMMAND1	COMMAND2	DATA (Hexadecimal)		COMMAND1	COMMAND2	DATA (Hexadecimal)
01. Power	k	a	0 ~ 1	15. Balance	k	t	0 ~ 64
02. Aspect Ratio	k	c	*	16. Colour Temperature	k	u	0 ~ 3
03. Screen Mute	k	d	0 ~ 1	17. Red Adjustment	k	v	0 ~ 3C(or 50)
04. Volume Mute	k	e	0 ~ 1	18. Green Adjustment	k	w	0 ~ 3C(or 50)
05. Volume Control	k	f	0 ~ 64	19. Blue Adjustment	k	\$	0 ~ 3C(or 50)
06. Contrast	k	g	0 ~ 64	20. Abnormal Status	k	z	0 ~ a
07. Brightness	k	h	0 ~ 64	21. ISM Method	j	p	0 ~ 3
08. Colour	k	i	0 ~ 64	22. Low Power	j	q	0 ~ 1
09. Tint	k	j	0 ~ 64	23. Orbiter Time Setting	j	r	1 ~ FE
10. Sharpness	k	k	0 ~ 64	24. Orbiter Pixel Setting	j	s	1 ~ 3
11. OSD Select	k	l	0 ~ 1	25. Auto Configure	j	u	1
12. Remote Control lock mode	k	m	0 ~ 1	26. Channel Select Command	m	a	*
13. PIP/DW	k	n	*	27. Send IR Code	m	c	Key Code
14. PIP Position	k	q	0 ~ 3	28. Input select (Main)	x	b	*
				29. Input select (PIP)	x	y	*

Transmission / Receiving Protocol

Transmission

[Command1][Command2][][Set ID][][Data][Cr]

[Command 1] : First command to control the set.(j,k,mor x)

[Command 2] : Second command to control the set.

[Set ID] : You can adjust the set ID to choose desired TV ID number in Setup menu. Adjustment range is 1 ~ 99. When selecting Set ID '0', every connected the TV is controlled. Set ID is indicated as decimal (1 ~ 99) on menu and as Hexa decimal (0x0 ~ 0x63) on transmission/receiving protocol.

[DATA] : To transmit command data.

Transmit 'FF' data to read status of comand.

[Cr] : Carriage Return

ASCII code '0x0D'

[] : ASCII code 'space (0x20)'

OK Acknowledgement

[Command2][][Set ID][][OK][Data][x]

The TV transmits ACK (acknowledgement) based on this format when receiving normal data. At this time, if the data is data read mode, it indicates present status data. If the data is data write mode, it returns the data of the PC computer.

Error Acknowledgement

[Command2][][Set ID][][NG][Data][x]

The TV transmits ACK (acknowledgement) based on this format when receiving abnormal data from non-viable functions or communication errors.

Data1: Illegal Code

Data2: Not supported function

Data3: Wait more time

01. Power (Command2:a)

To control Power On/Off of the TV.

Transmission [k][a][][Set ID][][Data][Cr]

Data 0 : Power Off Data 1 : Power On

Acknowledgement [a][][Set ID][][OK][Data][x]

To show Power On/Off.

Transmission [k][a][][Set ID][][FF][Cr]

Acknowledgement [a][][Set ID][][OK][Data][x]

* In a like manner, if other functions transmit 'FF' data based on this format, Acknowledgement data feedback presents status about each function.

02. Aspect Ratio (Command2:c) (Main picture size)

To adjust the screen format. (Main picture format)

You can also adjust the screen format using the ARC (Aspect Ratio Control) button on remote control or in the SCREEN menu.

Transmission [k][c][][Set ID][][Data][Cr]

Date 1: Normal screen (4:3)	Date 5: Full screen (Zoom2)
Date 2: Wide screen (16:9)	Date 6: Original
Date 3: Spectacle	Date 7: Wide screen (14:9)
Date 4: Full screen (Zoom1)	Date 8: Full (Option)

Acknowledgement [c][][Set ID][][OK][Data][x]

* Using the PC input, you select either 16:9 or 4:3 screen aspect ratio.

03. Screen Mute (Command2:d)

To select screen mute on/off.

Transmission [k][d][][Set ID][][Data][Cr]

Data 0 : Screen mute off (Picture on)

Data 1 : Screen mute on (Picture off)

Acknowledgement [d][][Set ID][][OK][Data][x]

04. Volume Mute (Command2:e)

To control volume mute on/off.

You can also adjust mute using the MUTE button on remote control.

Transmission [k][e][][Set ID][][Data][Cr]

Data 0 : Volume mute off (Volume on)

Data 1 : Volume mute on (Volume off)

Acknowledgement [e][][Set ID][][OK][Data][x]

05. Volume Control (Command2:f)

To adjust volume.

You can also adjust volume with the volume buttons on remote control.

Transmission [k][f][][Set ID][][Data][Cr]

Data Min : 0 ~ Max : 64

Refer to 'Real data mapping 1' : See page 73

Acknowledgement [f][][Set ID][][OK][Data][x]

06. Contrast (Command2:g)

To adjust screen contrast.

You can also adjust contrast in the PICTURE menu.

Transmission [k][g][][Set ID][][Data][Cr]

Data Min : 0 ~ Max : 64

Refer to 'Real data mapping 1' : See page 73

Acknowledgement [g][][Set ID][][OK][Data][x]

07. Brightness (Command2:h)

To adjust screen brightness.

You can also adjust brightness in the PICTURE menu.

Transmission [k][h][][Set ID][][Data][Cr]

Data Min : 0 ~ Max : 64

Refer to 'Real data mapping 1' : See page 73

Acknowledgement [h][][Set ID][][OK][Data][x]

08. Colour (Command2:i)

To adjust the screen colour.

You can also adjust colour in the PICTURE menu.

Transmission [k][i][][Set ID][][Data][Cr]

Data Min : 0 ~ Max : 64

Refer to 'Real data mapping 1' : See page 73

Acknowledgement [i][][Set ID][][OK][Data][x]

09. Tint (Command2:j)

To adjust the screen tint.

You can also adjust tint in the PICTURE menu.

Transmission [k][j][][Set ID][][Data][Cr]

Data Red : 0 ~ Green : 64

Refer to 'Real data mapping 1' : See page 73

Acknowledgement [j][][Set ID][][OK][Data][x]

APPENDIX

10. Sharpness (Command2:k)

To adjust the screen sharpness.

You can also adjust sharpness in the PICTURE menu.

Transmission [k][k][][Set ID][][Data][Cr]

Data Min: 0 ~ Max: 64

Refer to 'Real data mapping 1'. See page 73

Acknowledgement [k][][Set ID][][OK][Data][x]

11. OSD Select (Command2:l)

To select OSD (On Screen Display) on/off when controlling remotely.

Transmission [k][l][][Set ID][][Data][Cr]

Data 0: OSD off

Data 1: OSD on

Acknowledgement [l][][Set ID][][OK][Data][x]

12. Remote Control Lock Mode (Command2:m)

To lock the remote control and the front panel controls on the set.

Transmission [k][m][][Set ID][][Data][Cr]

Data 0: Lock off

Data 1: Lock on

Acknowledgement [m][][Set ID][][OK][Data][x]

If you're not using the remote control and front panel controls on the TV, use this mode. When main power is on/off, remote control lock is released.

13. PIP / DW (Command2:n)

To control the PIP (Picture In picture)/DW.

You can also control the PIP/DW using the PIP button on the remote control or in the PIP/DW menu.

Transmission [k][n][][Set ID][][Data][Cr]

Data 0: PIP/DW off

Data 1: PIP

Data 2: DW 1

Data 3: DW 2

Data 5: POP

Acknowledgement [n][][Set ID][][OK][Data][x]

14. PIP Position (Command2:q)

To select sub picture position for PIP.

You can also adjust the sub picture position using POSITION button on the remote control or in the PIP/DW menu.

Transmission [k][q][][Set ID][][Data][Cr]

Data 0: Right down on screen

Data 1: Left down on screen

Data 2: Left up on screen

Data 3: Right up on screen

Acknowledgement [q][][Set ID][][OK][Data][x]

15. Balance (Command2:t)

To adjust balance.

You can also adjust balance in the SOUND menu.

Transmission [k][t][][Set ID][][Data][Cr]

Data Min: 0 ~ Max: 64

Refer to 'Real data mapping 1'. See page 73

Acknowledgement [t][][Set ID][][OK][Data][x]

16. Color Temperature (Command2:u)

To adjust color temperature.

You can also adjust CSM in the PICTURE menu.

Transmission [k][u][][Set ID][][Data][Cr]

Data 0: Normal 1: Cool 2: Warm 3: User

Acknowledgement [u][][Set ID][][OK][Data][x]

17. Red Adjustment (Command2:v)

To adjust red in colour temperature.

Transmission [k][v][][Set ID][][Data][Cr]

Data Min: 0 ~ Max: 3C(or 50)

Refer to 'Real data mapping 2'. See page 73

Acknowledgement [v][][Set ID][][OK][Data][x]

18. Green Adjustment (Command2:w)

To adjust red in colour temperature.

Transmission [k][w][][Set ID][][Data][Cr]

Data Min: 0 ~ Max: 3C(or 50)

Refer to 'Real data mapping 2'. See page 73

Acknowledgement [w][][Set ID][][OK][Data][x]

19. Blue Adjustment (Command2:\$)

To adjust red in colour temperature.

Transmission [k][\$][][Set ID][][Data][Cr]

Data Min: 0 ~ Max: 3C(or 50)

Refer to 'Real data mapping 2'. See page 73

Acknowledgement [\$][][Set ID][][OK][Data][x]

20. Abnormal State (Command2:z)

To recognize an abnormal state.

This feature is not available for all models.

Transmission [k][z][][Set ID][][FF][][Cr]

Data FF: Read

Acknowledgement [z][][Set ID][][OK][Data][x]

Data 0: Normal (Power on and signal exist)

Data 1: No signal (Power on)

Data 2: Turn the TV off by remote control

Data 3: Turn the TV off by sleep time function

Data 4: Turn the TV off by RS-232C function

Data 5: 5V down

Data 6: AC down

Data 7: Turn the TV off by Fan Alarm function (option)

Data 8: Turn the TV off by Off time function

Data 9: Turn the TV off by Auto sleep function

Data a: Turn the TV off by AV board detect

* This function is "read only".

21. ISM Method (Command1:j, Command2:p)(Option)

To control the ISM method. You can also adjust ISM Method in SPECIAL menu.

This feature is not available for all models.

Transmission [j][p][][Set ID][][Data][Cr]

Data 0: Normal Mode

Data 1: White Wash

Data2: Orbiter

Data3: Inversion

Acknowledgement [p][][Set ID][][OK][Data][x]

22. Low Power (Command1:j, Command2:q)(Option)

To reduce the power consumption of the monitor. You can also adjust Low Power in SPECIAL menu.

This feature is not available for all models.

Transmission [j][q][][Set ID][][Data][][Cr]

Data 0: Off

Data 1: On

Acknowledgement [q][][Set ID][][OK][Data][x]

23. Orbiter Time Setting (Command1:j, Command2:r)(Option)

To adjust orbiter operation time term.

This feature is not available for all models.

Transmission [j][r][][Set ID][][Data][][Cr]

Data Min: 1 ~ Max: FE

Refer to 'Real data mapping 1'. See page 73

Acknowledgement [r][][Set ID][][OK][Data][x]

24 . Orbiter Pixel Setting (Command1:j, Command2:s)(Option)

To adjust pixel number in orbiter function.

This feature is not available for all models.

Transmission [j][s][][Set ID][][Data][Cr]

Data Min: 1 ~ Max: 3

Refer to 'Real data mapping 1'. See page 73

Acknowledgement [s][][Set ID][][OK][Data][x]

25 . Auto Configure (Command1:j, Command2:u)

To adjust picture position and minimize image shaking automatically. It works only in RGB (PC) mode.

Transmission [j][u][][Set ID][][Data][Cr]

Data 1: To set

Acknowledgement [u][][Set ID][][OK][Data][x]

26 . Channel Select Command (Command1:m, Command2:a)

To select a programme for the main picture.

Transmission [m][a][][Set ID][][Data0][][Data1][][Data2][Cr]

Data 0: Min: 0 ~ Max: 3C(or 50)

Refer to 'Real data mapping 1'. See page 73

Data 1: Don't care

Data 2: 0 : Main

1 : Sub

Acknowledgement [a][][Set ID][][OK][Data0][x]

*** Real data mapping 1**

0 : Step 0
 ⋮
 A : Step 10 (Set ID 10)
 ⋮
 F : Step 15 (Set ID 15)
 10 : Step 16 (Set ID 16)
 ⋮
 64 : Step 100
 ⋮
 6E : Step 110
 ⋮
 73 : Step 115
 74 : Step 116
 ⋮
 C7 : Step 199
 ⋮
 FE : Step 254
 FF : Step 255

*** Real data mapping 2**

0 : -40
 1 : -39
 2 : -38
 ⋮
 28 : 0
 ⋮
 4E : +38
 4F : +39
 50 : +40

APPENDIX

27. Send IR Code (Command1:m, Command2:c)

To send IR remote key code.

Transmission [m][c][][Set ID][][Data][Cr]

Data: Key code - Refer to page 76

Acknowledgement [c][][Set ID][][OK][Data][x]

28. Input select (Command1:x, Command2:b)

(Main Picture Input)

To select input source for TV

Transmission [x][b][][Set ID][][Data][Cr]

Data: Structure

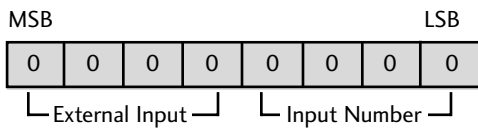

External Input				Data
0	0	0	1	Analog
0	0	1	0	AV
0	0	1	1	S-Video
0	1	0	0	Component
0	1	0	1	RGB-DTV
0	1	1	0	RGB-PC
1	0	0	1	HDMI

Input Number				Data
0	0	0	0	Input1
0	0	0	1	Input2
0	0	1	0	Input3
0	0	1	1	Input4

Acknowledgement [b][][Set ID][][OK][Data][x]

29. Input select (Command1:x, Command2:y)

To adjust input source for sub picture in PIP mode

Transmission [x][y][][Set ID][][Data][Cr]

Data: Structure

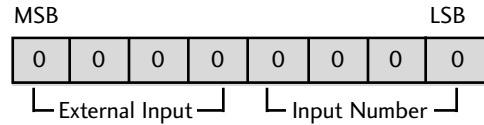

External Input				Data
0	0	0	1	Analog
0	0	1	0	AV
0	0	1	1	S-Video
0	1	0	0	Component
0	1	0	1	RGB-DTV
0	1	1	0	RGB-PC
1	0	0	1	HDMI

Input Number				Data
0	0	0	0	Input1
0	0	0	1	Input2
0	0	1	0	Input3
0	0	1	1	Input4

Acknowledgement [y][][Set ID][][OK][Data][x]

IR CODES

1. How to Connect

- Connect your wired remote control to the Remote Control port on the TV.

2. Remote Control IR Codes

■ Output waveform

Single pulse, modulated with 37.917KHz signal at 455KHz

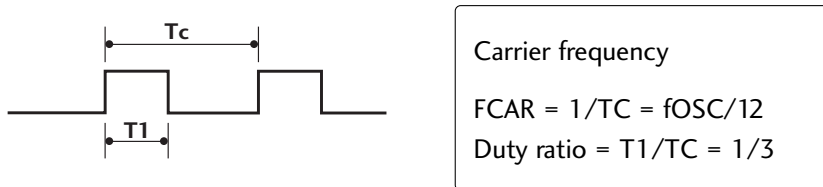

■ Configuration of frame

1st frame

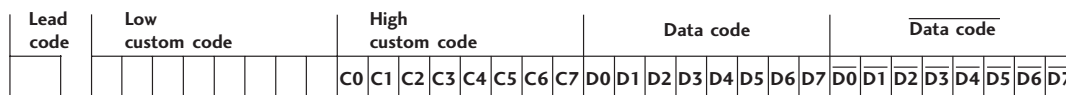

Repeat frame

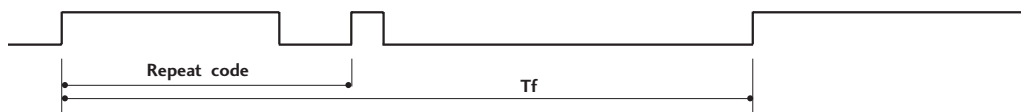

■ Lead code



■ Repeat code

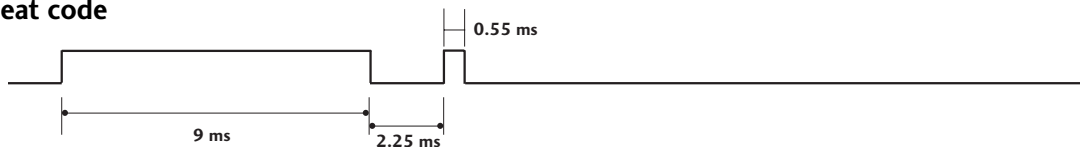

■ Bit description

Bit "0"

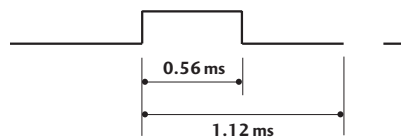

Bit "1"

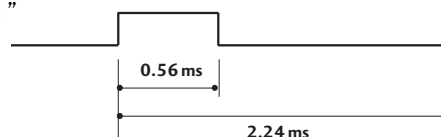

■ Frame interval: Tf

The waveform is transmitted as long as a key is depressed.

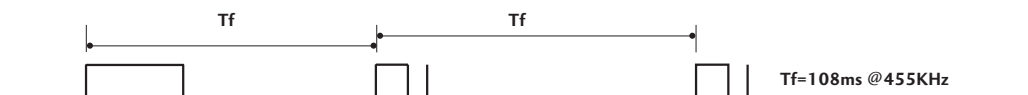

APPENDIX

REMOTE CONTROL IR CODES

Code (Hexa)	Function	Note	Code (Hexa)	Function	Note
0F	TV	R/C Button	72	RED	R/C Button
0B	INPUT	R/C Button	71	GREEN	R/C Button
08	POWER	R/C Button (Power On/Off)	63	YELLOW	R/C Button
C4	POWER ON	Discrete IR Code (Only Power On)	61	BLUE	R/C Button
C5	POWER OFF	Discrete IR Code (Only Power OFF)	02	VOL +	R/C Button
60	PIP	R/C Button	03	VOL -	R/C Button
0E	SLEEP	R/C Button	00	PR +	R/C Button
20	TEXT	R/C Button	01	PR -	R/C Button
0A	I/II	R/C Button	09	MUTE	R/C Button
43	MENU	R/C Button	53	LIST	R/C Button
79	ARC	R/C Button	10 ~ 19	Number Key 0 ~ 9	R/C Button
5B	EXIT	R/C Button	1E	FAVOURITE	R/C Button
07	◀	R/C Button	1A	Q.VIEW	R/C Button
06	▶	R/C Button	64	SIZE	R/C Button
40	▲	R/C Button	62	PIP: POSITION,	R/C Button
41	▼	R/C Button		Teletext: UPDATE	R/C Button
44	OK	R/C Button	70	INDEX	R/C Button
72	PIP PR-	R/C Button	26	TIME	R/C Button
71	PIP PR+	R/C Button	2A	REVEAL	R/C Button
63	SWAP	R/C Button	E0	☀ +	R/C Button
61	PIP INPUT	R/C Button	E1	☀ -	R/C Button

PROGRAMMING THE REMOTE

The remote is a multi-brand or a universal remote. It can be programmed to operate most remote-control-able devices of other manufacturers.

Note that the remote may not control all models of other brands.

Programming a code into a remote mode

- 1** Test your remote control.
To find out whether your remote control can operate the component without programming, turn on the component such as a VCR and press the corresponding mode button (such as a **DVD** or **VCR**) on the remote control, while pointing at the component. Test the **POWER** and **PR +/-** buttons to see if the component responds properly. If not, the remote requires programming to operate the device.
- 2** Turn on the component to be programmed, then press the corresponding mode button (such as a **DVD** or **VCR**) on the remote control. The remote control button of desired device is lighted.
- 3** Press the **MENU** and **MUTE** buttons simultaneously, the remote control is ready to be programmed for the code.
- 4** Enter a code number using the **NUMBER** buttons on the remote control. Programming code numbers for the corresponding component can be found on the following pages. Again, if the code is correct, the device will turn off.
- 5** Press the **MENU** button to store the code.
- 6** Test the remote control functions to see if the component responds properly. If not, repeat from step 2.

APPENDIX

PROGRAMMING CODE

VCRs

Brand	Codes	Brand	Codes	Brand	Codes
AIWA	034	MAGNAVOX	031 033 034 041	SAMSUNG	032 040 102 104
AKAI	016 043 046 124		067 068		105 107 109 112
	125 146	MARANTZ	012 031 033 067		113 115 120 122
AMPRO	072		069		125
ANAM	031 033 103	MARTA	101	SANSUI	022 043 048 135
AUDIO DYNAMICS	012 023 039 043	MATSUI	027 030	SANYO	003 007 010 014
BROKSONIC	035 037 129	MEI	031 033		102 134
CANON	028 031 033	MEMOREX	003 010 014 031	SCOTT	017 037 112 129
CAPEHART	108		033 034 053 072		131
CRAIG	003 040 135		101 102 134 139	SEARS	003 008 009 010
CURTIS MATHES	031 033 041	MGA	045 046 059		013 014 017 020
DAEWOO	005 007 010 064	MINOLTA	013 020		031 042 073 081
	065 108 110 111	MITSUBISHI	013 020 045 046	SHARP	031 054 149
	112 116 117 119		049 051 059 061	SHINTOM	024
DAYTRON	108		151	SONY	003 009 031 052
DBX	012 023 039 043	MTC	034 040		056 057 058 076
DYNATECH	034 053	MULTITECH	024 034		077 078 149
ELECTROHOME	059	NEC	012 023 039 043	SOUNDESIGN	034
EMERSON	006 017 025 027		048	STS	013
	029 031 034 035	NORDMENDE	043	SYLVANIA	031 033 034 059
	036 037 046 101	OPTONICA	053 054		067
	129 131 138 153	PANASONIC	066 070 074 083	SYMPHONIC	034
FISHER	003 008 009 010		133 140 145	TANDY	010 034
FUNAI	034	PENTAX	013 020 031 033	TATUNG	039 043
GE	031 033 063 072		063	TEAC	034 039 043
	107 109 144 147	PHILCO	031 034 067	TECHNICS	031 033 070
GO VIDEO	132 136	PHILIPS	031 033 034 054	TEKNIKA	019 031 033 034
HARMAN KARDON	012 045		067 071 101		101
HITACHI	004 018 026 034	PILOT	101	THOMAS	034
	043 063 137 150	PIONEER	013 021 048	TMK	006
INSTANTREPLAY	031 033	PORTLAND	108	TOSHIBA	008 013 042 047
JCL	031 033	PULSAR	072		059 082 112 131
JCPENNY	012 013 015 033	QUARTZ	011 014	TOTEVISION	040 101
	040 066 101	QUASAR	033 066 075 145	UNITECH	040
JENSEN	043	RCA	013 020 033 034	VECTOR RESEARCH	012
JVC	012 031 033 043		040 041 062 063	VICTOR	048
	048 050 055 060		107 109 140 144	VIDEO CONCEPTS	012 034 046
	130 150 152		145 147	VIDEOSONIC	040
KENWOOD	014 034 039 043	REALISTIC	003 008 010 014	WARDS	003 013 017 024
	047 048		031 033 034 040		031 033 034 040
LG (GOLDSTAR)	001 012 013 020		053 054 101		053 054 131
	101 106 114 123	RICO	058	YAMAHA	012 034 039 043
LLOYD	034	RUNCO	148	ZENITH	034 048 056
LXI	003 009 013 014	SALORA	014		058 072 080 101
	017 034 101 106				
MAGIN	040				

PROGRAMMING CODE

DVD

Brand	Codes	Brand	Codes	Brand	Codes
APEX DIGITAL	022	mitsubishi	002	RCA	005 006
DENON	020 014	NAD	023	SAMSUNG	011 015
GE	005 006	ONKYO	008 017	SONY	007
HARMAN KARDON	027	PANASONIC	003 009	THOMPSON	005 006
JVC	012	PHILIPS	013	TOSHIBA	019 008
LG	001 010 016 025	PIONEER	004 026	YAMAHA	009 018
MAGNAVOX	013	PROCEED	021	ZENITH	010 016 025
MARANTZ	024	PROSCAN	005 006		

APPENDIX

TROUBLESHOOTING CHECKLIST

The operation does not work normally.	
The remote control doesn't work	<ul style="list-style-type: none"> ■ Check to see if there is any object between the product and the remote control causing obstruction. ■ Are batteries installed with correct polarity (+ to +, - to -)? ■ Correct remote operating mode set: TV, VCR etc.? ■ Install new batteries.
Power is suddenly turned off	<ul style="list-style-type: none"> ■ Is the sleep timer set? ■ Check the power control settings. Power interrupted ■ No broadcast on station tuned with Auto off activated.

The video function does not work.	
No picture & No sound	<ul style="list-style-type: none"> ■ Check whether the product is turned on. ■ Try another channel. The problem may be with the broadcast. ■ Is the power cord inserted into wall power outlet? ■ Check your antenna direction and/or location. ■ Test the wall power outlet, plug another product's power cord into the outlet where the product's power cord was plugged in.
Picture appears slowly after switching on	<ul style="list-style-type: none"> ■ This is normal, the image is muted during the product startup process. Please contact your service center, if the picture has not appeared after five minutes.
No or poor color or poor picture	<ul style="list-style-type: none"> ■ Adjust Color in menu option. ■ Keep a sufficient distance between the product and the VCR. ■ Try another channel. The problem may be with the broadcast. ■ Are the video cables installed properly? ■ Activate any function to restore the brightness of the picture.
Horizontal/vertical bars or picture shaking	<ul style="list-style-type: none"> ■ Check for local interference such as an electrical appliance or power tool.
Poor reception on some channels	<ul style="list-style-type: none"> ■ Station or cable product experiencing problems, tune to another station. ■ Station signal is weak, reorient antenna to receive weaker station. ■ Check for sources of possible interference.
Lines or streaks in pictures	<ul style="list-style-type: none"> ■ Check antenna (Change the direction of the antenna).

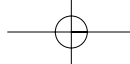

TROUBLESHOOTING CHECKLIST

The audio function does not work.	
Picture OK & No sound	<ul style="list-style-type: none"> ■ Press the VOL +/- button. ■ Sound muted? Press MUTE button. ■ Try another channel. The problem may be with the broadcast. ■ Are the audio cables installed properly?
No output from one of the speakers	<ul style="list-style-type: none"> ■ Adjust Balance in menu option.
Unusual sound from inside the product	<ul style="list-style-type: none"> ■ A change in ambient humidity or temperature may result in an unusual noise when the product is turned on or off and does not indicate a fault with the product.

There is a problem in PC mode. (Only PC mode applied)	
The signal is out of range.	<ul style="list-style-type: none"> ■ Adjust resolution, horizontal frequency, or vertical frequency. ■ Check the input source.
Vertical bar or stripe on background & Horizontal Noise & Incorrect position	<ul style="list-style-type: none"> ■ Work the Auto configure or adjust clock, phase, or H/V position.
Screen colour is unstable or single colour	<ul style="list-style-type: none"> ■ Check the signal cable. ■ Reinstall the PC video card.

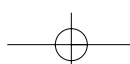

APPENDIX

MAINTENANCE

Early malfunctions can be prevented. Careful and regular cleaning can extend the amount of time you will have your new TV. Be sure to turn the power off and unplug the power cord before you begin any cleaning.

Cleaning the Screen

- 1 Here's a great way to keep the dust off your screen for a while. Wet a soft cloth in a mixture of lukewarm water and a little fabric softener or dish washing detergent. Wring the cloth until it's almost dry, and then use it to wipe the screen.
- 2 Make sure the excess water is off the screen, and then let it air-dry before you turn on your TV.

Cleaning the Cabinet

- To remove dirt or dust, wipe the cabinet with a soft, dry, lint-free cloth.
- Please be sure not to use a wet cloth.

Extended Absence

CAUTION

- ▶ If you expect to leave your TV dormant for a long time (such as a vacation), it's a good idea to unplug the power cord to protect against possible damage from lightning or power surges.

PRODUCT SPECIFICATIONS

MODELS		32LC2R* 32HIZ20 32HIZ22	37LC2R* 37HIZ20 37HIZ22	42LC2R* 42HIZ20 42HIZ22
		32LC2R-ZH 32LC2RHA-ZH	37LC2R-ZH 37LC2RHA-ZH	42LC2R-ZH 42LC2RHA-ZH
Dimensions (Width x Height x Depth)	with stand	811 x 630 x 235 mm 31.9 x 24.8 x 9.2 inches	944 x 729 x 286 mm 37.1 x 28.7 x 11.2 inches	1054 x 813 x 286 mm 41.4 x 32 x 11.2 inches
	without stand	811 x 566.8 x 123.5 mm 31.9 x 22.3 x 4.8 inches	944 x 659.3 x 129.7 mm 37.1 x 26 x 5.1 inches	1054 x 746 x 136.8 mm 41.4 x 29.3 x 5.3 inches
Weight	including stand	21.9 kg/48.2 lbs	29.5 kg/65 lbs	37.0 kg/81.5 lbs
	excluding stand	18.5 kg/40.8 lbs	24.9 kg/54.9 lbs	30.4 kg/67 lbs
Power requirement		AC100-240V- 50/60Hz 1.5A	AC100-240V- 50/60Hz 2.0A	AC100-240V- 50/60Hz 2.5A
Power Consumption		150W	190W	240W
Television System		PAL/SECAM B/G/D/K, PAL I/II, SECAM L/L'		
Program Coverage		VHF: E2 ~ E12, UHF: E21 ~ E69, CATV: S1 ~ S20, HYPER: S21 ~ S47		
External Antenna Impedance		75 ohm		
Environment condition	Operating Temperature	0 ~ 40°C / 32 ~ 104°F		
	Operating Humidity	Less than 80%		
Environment condition	Storage Temperature	-20 ~ 60°C / -4 ~ 140°F		
	Storage Humidity	Less than 85%		

■ The specifications shown above may be changed without prior notice for quality improvement.

APPENDIX

PRODUCT SPECIFICATIONS

MODELS		42PC1R*	42PC3R*	50PC1R*
		42PC1R-ZH	42PC3R-ZH	50PC1R-ZH
Dimensions (Width x Height x Depth)	with stand	1129.0 x 748.5 x 380.0 mm 44.4 x 29.4 x 14.9 inches	1129.0 x 748.5 x 333.6 mm 44.4x 29.4 x 13.1inches	1302.6 x 872 x 355.8 mm 51.2 x 34.3 x 14 inches
	without stand	1129.0 x 695.0 x 103.7 mm 44.4 x 27.3 x 4 inches	1129.0 x 695.0 x 103.7 mm 44.4x 27.3 x 4 inches	1302.6 x 810x 107.7 mm 51.2 x 31.8 x 4.2 inches
Weight	including stand	29.3 kg/64.6lbs	31.0 kg/68.4 lbs	51.5 kg/113.5 lbs
	excluding stand	25.4 kg/56.0 lbs	24.3 kg/53.4lbs	44.3 kg/97.7 lbs
Power requirement		AC100-240V~ 50/60Hz 3.5A		AC100-240V~ 50/60Hz 5.0A
Power Consumption		310W		450W
Television System		PAL/SECAM B/G/D/K, PAL I/II, SECAM L/L'		
Program Coverage		VHF: E2 ~ E12, UHF: E21 ~ E69, CATV: S1 ~ S20, HYPER: S21 ~ S47		
External Antenna Impedance		75 Ω		
Environment condition	Operating Temperature	0 ~ 40°C / 32 ~ 104°F		
	Operating Humidity	Less than 80%		
	Storage Temperature	-20 ~ 60°C / -4 ~ 140°F		
	Storage Humidity	Less than 85%		

■ The specifications shown above may be changed without prior notice for quality improvement.

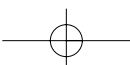
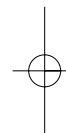
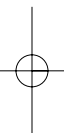
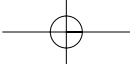

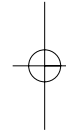
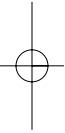
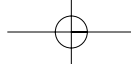

LG Electronics Inc.

