

Life's
Good



LG

REFRIGERATOR- FREEZER OWNER'S MANUAL

PLEASE
READ THIS OWNER'S MANUAL THOROUGHLY
BEFORE OPERATING AND KEEP IT HANDY
FOR REFERENCE AT ALL TIMES.

ŁODÓWKA- ZAMRAŻARKA

INSTRUKCJA UŻYTKOWNIKA

PRZED URUCHOMIENIEM ZESTAWU
PROSIMY DOKŁADNIE ZAPOZNAĆ SIĘ
Z NINIEJSZĄ INSTRUKCJĄ, I ZACHOWAĆ
JĄ DO WYKORZYSTANIA W PRZYSZŁOŚCI.

P/No. 3828JP8011V

CONTENTS

INSTALLATION	3
FEATURE CHART	4
OPERATION	5
Starting	
Temperature Control	
Ice Making	
Chilled Compartment	
Defrosting	
Deodorizer (Optional)	
SUGGESTIONS ON FOOD STORAGE	8
REVERSIBLE DOOR	9
Precaution	
How to reverse the door	
CLEANING	11
GENERAL INFORMATION	11
LAMP REPLACEMENT	12
IMPORTANT WARNINGS	12
BEFORE CALLING FOR SERVICE	13
SPECIFICATIONS	14

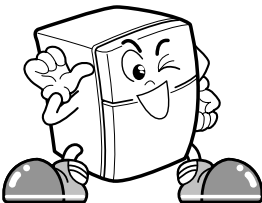

THIS REFRIGERATOR IS MANUFACTURED WITH GREAT CARE AND UTILIZES THE LATEST IN TECHNOLOGY.

WE ARE CONFIDENT THAT YOU WILL BE FULLY SATISFIED WITH ITS PERFORMANCE AND RELIABILITY.

BEFORE USING YOUR REFRIGERATOR, PLEASE READ THIS BOOKLET CAREFULLY.

IT PROVIDES EXACT INSTRUCTIONS FOR INSTALLATION, OPERATION, AND MAINTENANCE, AND ALSO SUPPLIES SOME USEFUL HINTS.

INSTALLATION

SELECT A GOOD LOCATION

1. Place your refrigerator where it is easy to use.
2. Avoid placing the refrigerator near heat sources, direct sunlight or moisture.
3. Air must circulate properly around your refrigerator to ensure efficient operation. If your refrigerator is placed in a recessed area in the wall, allow at least 10 inches (25 cm) or greater clearance above the refrigerator and 2 inches (5 cm) or more from the wall. The refrigerator should be elevated 1 inch (2.5 cm) from the floor, especially if the floor is carpeted.
4. To avoid vibrations, the refrigerator must be level. If necessary, adjust the leveling screw(s) to compensate for unevenness of the floor. To close the doors easily, the front should be slightly higher than the rear. Leveling screw(s) can be turned easily by tipping the cabinet slightly. Turn the leveling screw(s) clockwise to raise the refrigerator, counterclockwise to lower it.

NEXT

1. Wipe off all dust accumulated during shipping and clean your refrigerator thoroughly.
2. Install accessories such as the ice cube box, evaporating tray cover, etc., in their proper places. They are packed together to prevent possible damage during shipping.
3. Connect the power supply cord (or plug) to the outlet. Don't double up with other appliances on the same outlet.
4. Prior to use, let the refrigerator run for 2-3 hours. Check the flow of cold air in the freezer compartment to ensure proper cooling has taken place. Your refrigerator is now ready for use.

FEATURE CHART

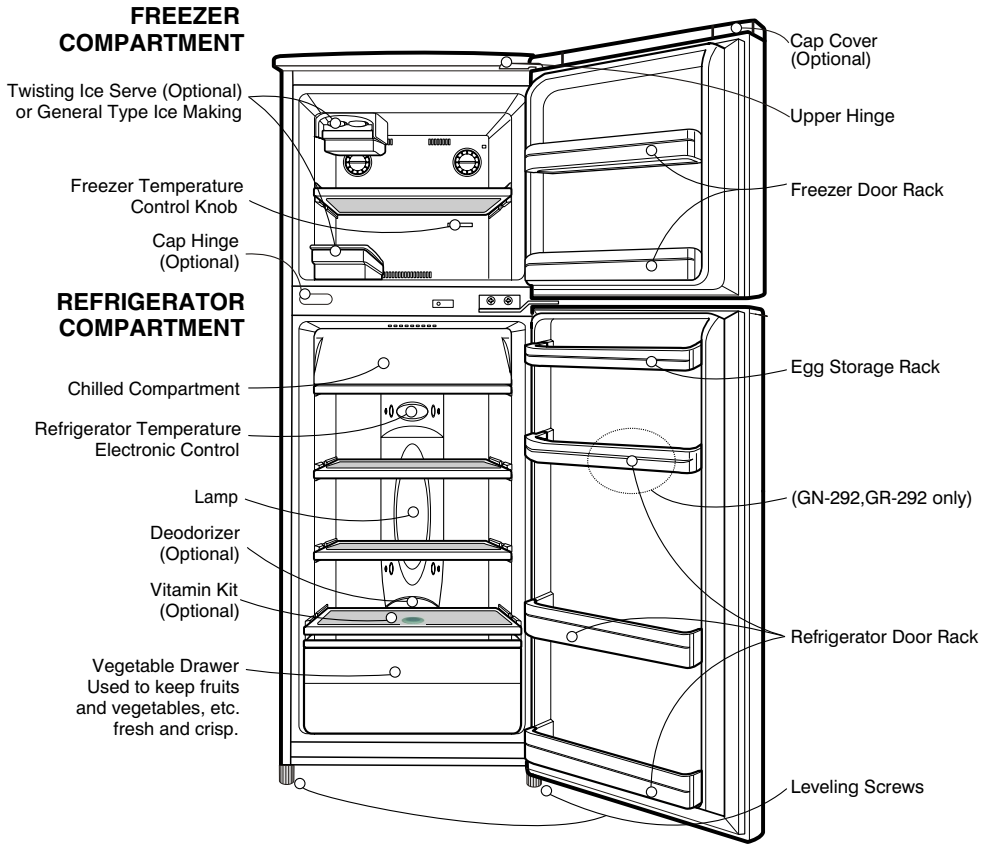

NOTE

All parts shown may not be included with every model.

OPERATION

STARTING

When your refrigerator is first installed, allow it 2-3 hours to stabilize at normal operating temperatures prior to filling it with fresh or frozen foods.

If operation is interrupted, wait 5 minutes before restarting.

TEMPERATURE CONTROL

❑ REFRIGERATOR

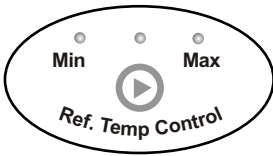

The default setting of the temperature control button for the refrigerator compartment is **NORMAL**.

You can set the refrigerator temperature using the **Refrigerator Temperature Control**.

Whenever pressing the button, the **LED** emit light.

The temperature of the compartment is highered as the **LED** luminesce from **MIN** to **MAX**.

You can select the desired set point in five (5) steps between minimum and maximum.

For the economic electricity, set the **LED** to the **MIN** position.

	Low	Medium Low	Medium	Medium High	High
Temp Control	☀-○○	☀-☀-○	○-☀-○	○-☀-☀	○○-☀
AVERAGE TEMP(°C)*	6	4.5	3	1	-1
ROOM	REFRIGERATOR				

*This temperature can change based on the freezer temperature control setting.

❑ FREEZER

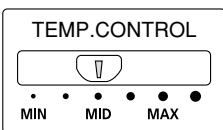

The default setting of the temperature control knob for the freezer compartment is the **MID** point.

For colder temperatures, adjust the control knob to **MAX**, and for warmer temperatures, adjust the control knob to **MIN** position.

OPERATION

ICE MAKING

Determine which type ice-making system you have.

General Type

- To make ice cubes, fill the ice tray with water and place it on the ice cube box. Then insert the ice cube box in the freezer compartment.

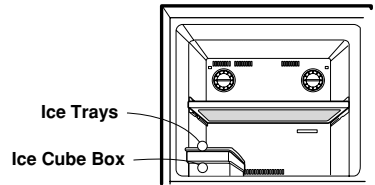

- To remove ice cubes, hold the tray at its ends and twist gently.

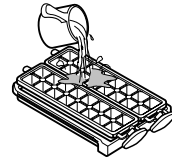

Twisting Ice Serve Type

- To make ice cubes, fill the ice tray with water and insert in its position.
- To remove ice cubes, hold the knob of the tray and turn gently. Then, ice cubes drop in the ice cube box.
- You can remove the Twisting Ice Serve to make the freezer compartment larger.
- You should remove the ice Trays and Ice Cube Box first, then pull the frame out toward the right side.

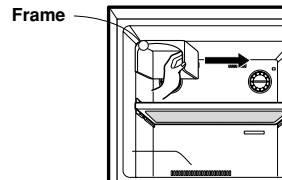
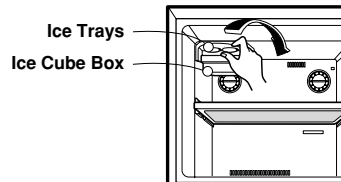

OPERATION

CHILLED COMPARTMENT

When the door is opened, the warmer air doesn't influence the fresh meat. You can keep food fresher in it.

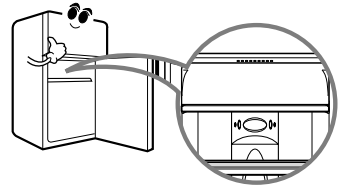

DEFROSTING

- Defrosting takes place automatically.
- The defrosted water flows down to the evaporating tray which is located in the lower back side of the refrigerator and is evaporated automatically.

DEODORIZER (OPTIONAL)

- By using a catalyst, deodorizing performance is guaranteed.
- Unpleasant odor of food in the fresh food compartment is deodorized with no harm to you and the food.

How to use

- As the catalyst is located in cooling air outlet for circulating air in fresh food compartment, there is no need to touch it.
- Do not puncture the cooling air outlet with a sharp tip because the deodorizing catalyst may be damaged.
- When storing food with a strong odor, wrap it or store it in a container with a lid because the odor may be absorbed by other foods.

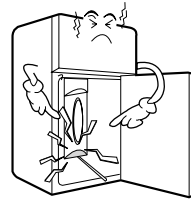
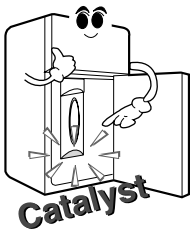

VITAMIN KIT (OPTIONAL)

It contains anti-oxidant that is able to avoid oxidation process in order to make the fruits and vegetables fresh for longer time.

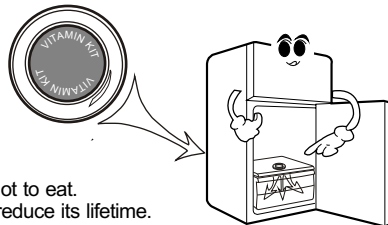

This part contains anti-oxidant substance that do not to eat. Opening and closing the door too much often can reduce its lifetime.

SUGGESTIONS ON FOOD STORAGE

STORING FOOD

- Store fresh food in the refrigerator compartment. How food is frozen and thawed is an important factor in maintaining its freshness and flavor.
- Do not store food which goes bad easily at low temperatures, such as bananas, pineapples, and melons.
- Allow hot food to cool prior to storing. Placing hot food in the refrigerator could spoil other food and lead to higher electric bills!
- When storing, cover food with vinyl wrap or store in a container with a lid. This prevents moisture from evaporating and helps food to keep its taste and nutrients.
- Do not block air vents with food. Smooth circulation of chilled air keeps refrigerator temperatures even.
- Do not open the door frequently. Opening the door lets warm air enter the refrigerator, causing temperatures to rise.

FREEZER COMPARTMENT

- Do not store bottles in the freezer compartment - they may break when frozen.
- Do not refreeze food that has been thawed. This deteriorates taste and nutrition.
- When storing frozen food like ice cream for a long period, place it on the freezer shelf, not in the door rack.
- Avoid storing any food close to the bottom area of the freezer shelf to keep efficient air circulation.

REFRIGERATOR COMPARTMENT

- Avoid placing moist food deep inside refrigerator shelves, it could freeze upon direct contact with chilled air.
- Always clean food prior to refrigeration. Vegetables and fruits should be washed and wiped, and packed food should be wiped clean to prevent adjacent food from spoiling.
- When storing eggs in their storage rack, ensure that they are fresh. Always store them in a upright position, which keeps them fresh longer.

REVERSIBLE DOOR

- Converting Door is Optional

PRECAUTION

1. The door can be reversed if required by location or user preference.
2. Before reversing the door, remove all foods and accessories (shelves, trays, bins, etc.) Which are not attached to the refrigerator.
3. Use a phillips driver, bolt driver, torque wrench, or spanner to remove or attach the bolt.
4. Be careful not to drop the refrigerator when assembling or disassembling the lower hinge and the adjustable screw assembly.
5. Don't lay the refrigerator down while working on it, as this will cause a malfunction and damage.
6. Be careful not to drop the doors when removing or replacing them.

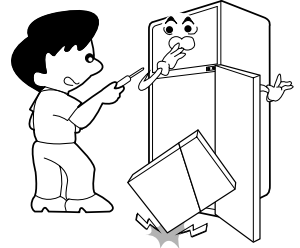

HOW TO REVERSE THE DOOR (when converting from the left-opening type to right opening type)

1 Remove the cap and upper hinge

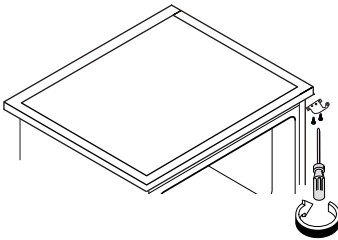

2 Remove the Freezer Door

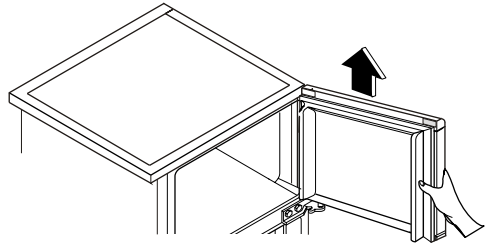

3 Remove the center hinge and the Refrigerator Door

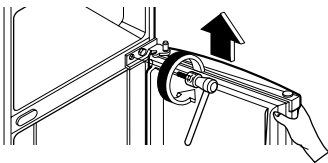

4 Remove the lower hinge

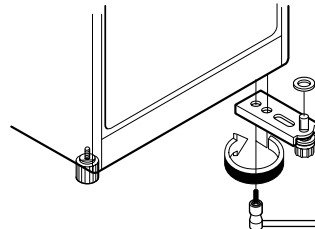

REVERSIBLE DOOR

5 Reverse the position of the adjustable screw assembly

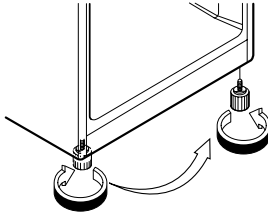

6 Assemble the lower hinge

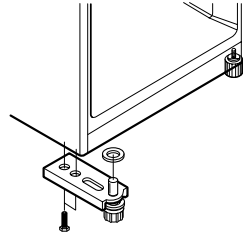

7 Move the cap and bracket to the opposite side of the refrigerator door

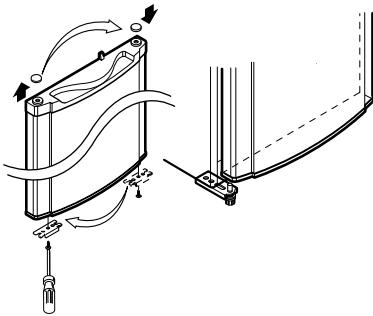

8 Move the cap to the opposite side and assemble the center hinge perpendicularly.

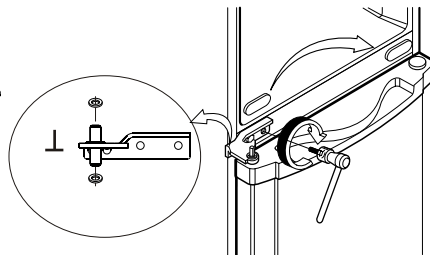

9 Assemble the door stopper for the correct side

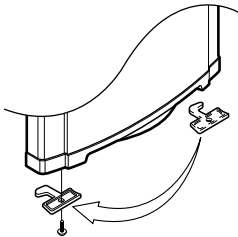

10 Move the Cap Cover to the opposite side of the freezer door

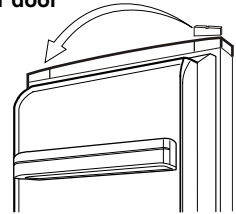

11 Reverse the pin position of the upper hinge

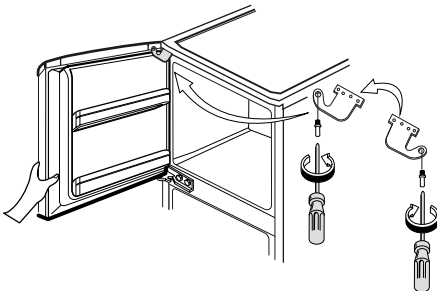

12 Assemble the screw to the top table until it is strong enough to support the freezer door. (Torque value is 5 ~ 7 kgf)

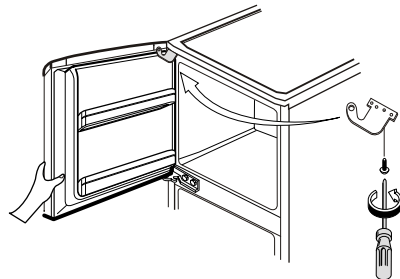

CLEANING

It is important that your refrigerator be kept clean to prevent undesirable odors. Spilled food should be wiped up immediately, since it may acidify and stain plastic surfaces if allowed to settle.

Never use metallic scouring pads, brushes, coarse abrasive cleaners, or strong alkaline solutions on any surface.

Before you clean, remember that damp objects will stick or adhere to extremely cold surfaces. Do not touch frozen surfaces with wet or damp hands.

EXTERIOR - Use a lukewarm solution of mild soap or detergent to clean the durable finish of your refrigerator. Wipe with a clean, damp cloth and then dry.

INTERIOR - Regular cleaning of the interior and interior parts is recommended. If you have the No Frost model which defrosts automatically, leave both doors open during the entire cleaning process.

Disconnect the power supply, and remove food and all compartment shelves, storage trays etc.

Wash all compartments with a baking soda solution. Rinse and dry.

INTERIOR PARTS - Wash compartment shelves, door racks, storage trays, and magnetic door seals etc. with the baking soda solution or a mild detergent and warm water. Rinse and dry.

WARNING

Always remove power cord from the wall outlet prior to cleaning in the vicinity of electrical parts (lamps, switches, controls, etc.).

Wipe up excess moisture with a sponge or cloth to prevent water or liquid from getting into any electrical part and causing an electric shock. Do not use flammable or toxic cleaning liquids.

GENERAL INFORMATION

VACATION TIME

During average length vacations, you will probably find it best to leave the refrigerator in operation. Place freezable items in freezer for longer life.

When you plan to be away for an extended period, remove all food, disconnect the power cord, clean the interior thoroughly, and leave each door OPEN to prevent odor formation.

POWER FAILURE

Most power failures are corrected in an hour or two and will not affect your refrigerator temperatures. However, you should minimize the number of door openings while the power is off. During power failures of longer duration, place a block of dry ice on top of your frozen packages.

DRY ICE WARNING

When using dry ice, provide adequate ventilation. Dry ice is frozen carbon dioxide (**CO₂**).

When it vaporizes, it can displace oxygen, causing dizziness, light-headedness, unconsciousness, and death by suffocation.

Open a window and do not breathe the vapors.

IF YOU MOVE

If you move, empty the refrigerator (freezer) completely and wash a mild solution of baking soda and water. (2 TBS soda to 1 quart water) Be sure the soda is completely dissolved to avoid scratching the inside of the refrigerator (freezer). Secure any loose items, such as racks, bins, ice trays, etc. Do not try to move a loaded refrigerator.

ANTI-CONDENSATION PIPE

The outside wall of the refrigerator cabinet may sometimes get warm, especially just after installation.

Don't be alarmed. This is due to the anti-condensation pipe, which pumps hot refrigerant to prevent sweating on the outer cabinet wall.

Anti-Condensation Pipe

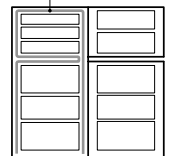

LAMP REPLACEMENT

1. Unplug the power cord from the outlet.
2. Remove refrigerator shelves.
3. To remove the lamp cover, insert a slotted driver at the one of under hole of the lamp cover and pull it out forwards.
4. Turn the lamp counterclockwise.
5. Assemble in reverse order of disassembly.
Replacement bulb must be the same specification as original.

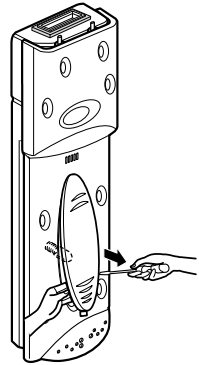

IMPORTANT WARNINGS

DO NOT USE AN EXTENSION CORD

Use this appliance on a dedicated circuit; that is, an outlet that is the only outlet on the circuit. Overloading a circuit causes low voltage, malfunction, possible damage to the equipment, and poor cooling capacity. Check your local electric code or consult a qualified electrician if you have questions.

ACCESSIBILITY SUPPLY PLUG

The refrigerator-freezer should be so positioned that the supply plug is accessible for quick disconnection if an accident happens.

SUPPLY CORD REPLACEMENT

If the supply cord is damaged, it must be replaced by the manufacturer or replacement or a similarly qualified person in order to avoid a hazard.

ABOUT GROUNDING (EARTHING)

In the event of an electric short circuit, grounding (earthing) reduces the risk of electric shock by providing an escape wire for the electric current. In order to prevent possible electric shock, this appliance must be grounded.

Improper use of the grounding plug can result in an electric shock. Consult a qualified electrician or service person if the grounding instructions are not completely understood, or if you have doubts on whether the appliance is properly grounded.

DO NOT MODIFY OR EXTEND THE POWER CORD LENGTH

It will cause electric shock or fire.

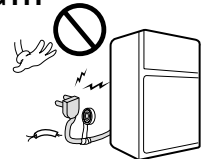

VERY DANGEROUS ATTRACTION

An empty refrigerator can be a dangerous attraction to children. Remove either gaskets, latches, lids or the entire door from your unused appliance, or take some other action to make it harmless.

This appliance must be grounded (earthed).

DON'T WAIT! DO IT NOW!

Do not store inflammable materials, explosives, or chemicals in the refrigerator.

BEFORE CALLING FOR SERVICE

SERVICE CALLS CAN OFTEN BE AVOIDED!

IF YOU FEEL YOUR REFRIGERATOR IS NOT OPERATING PROPERLY, CHECK THESE POSSIBLE CAUSES FIRST :

PROBLEM	POSSIBLE CAUSES
REFRIGERATOR DOES NOT OPERATE	<ul style="list-style-type: none"> • Has a house fuse blown or circuit breaker tripped? • Has the power cord plug been removed or loosened from the electrical wall outlet?
REFRIGERATOR OR FREEZER COMPARTMENT TEMPERATURE TOO WARM	<ul style="list-style-type: none"> • Temperature control not set on proper position. • Appliance is placed close to wall or heat source. • Warm weather-frequent door openings. • Door left open for a long time. • Large amount of foods are kept in the refrigerator.
ABNORMAL NOISE(S)	<ul style="list-style-type: none"> • Refrigerator is installed in a weak or uneven place, or leveling screw needs adjusting. • Unnecessary objects placed behind the refrigerator.
REFRIGERATOR HAS ODOR	<ul style="list-style-type: none"> • Foods with strong odors should be tightly covered or wrapped. • Interior needs cleaning.
DEW FORMS ON THE CABINET SURFACE	<ul style="list-style-type: none"> • Not unusual during periods of high humidity. • Door may have been left ajar.

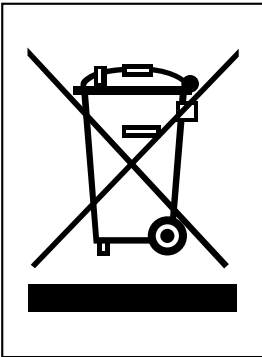

DISPOSAL OF YOUR OLD APPLIANCE

1. When this crossed-out wheeled bin symbol is attached to a product it means the product is covered by the European Directive 2002/96/EC.
2. All electrical and electronic products should be disposed of separately from the municipal waste stream via designated collection facilities appointed by the government or the local authorities.
3. The correct disposal of your old appliance will help prevent potential negative consequences for the environment and human health.
4. For more detailed information about disposal of your old appliance, please contact your city office, waste disposal service or the shop where you purchased the product.

SPECIFICATIONS

	GR-292	GR-262
Total capacity	237 ℓ	219 ℓ
Freezer capacity	61 ℓ	61 ℓ
Refrigerator capacity	176 ℓ	158 ℓ
Height	1600 mm	1520 mm
Width	540 mm	540 mm
Depth	610 mm	610 mm
Weight	49kg	46kg
Voltage,frequency	230~240V, 50Hz	230~240V, 50Hz
Freezing capacity	8.0Kg/24h	8.0Kg/24h
Energy consumption	1.19kW/24h	1.17kW/24h
Efectivity rate	B	B
Noise level	41dB	41dB
Time of keeping setting temperature in case of supply failure	11.5h	11.5h



LG Electronics Inc.