

W2_XA63_ENG_MFL41698405



MODEL : XA63 (XA63-D0U, XAS63F)

ENGLISH

Safety Precaution



CAUTION: TO REDUCE THE RISK OF ELECTRIC SHOCK DO NOT REMOVE COVER (OR BACK) NO USER-SERVICEABLE PARTS INSIDE REFER SERVICING TO QUALIFIED SERVICE PERSONNEL.



This lightning flash with arrowhead symbol within an equilateral triangle is intended to alert the user to the presence of uninsulated dangerous voltage within the product's enclosure that may be of sufficient magnitude to constitute a risk of electric shock to persons.



The exclamation point within an equilateral triangle is intended to alert the user to the presence of important operating and maintenance (servicing) instructions in the literature accompanying the product.

WARNING: TO PREVENT FIRE OR ELECTRIC SHOCK HAZARD, DO NOT EXPOSE THIS PRODUCT TO RAIN OR MOISTURE.

WARNING: Do not install this equipment in a confined space such as a book case or similar unit.

CAUTION: Do not block any ventilation openings. Install in accordance with the manufacturer's instructions.

Slots and openings in the cabinet are provided for ventilation and to ensure reliable operation of the product and to protect it from over heating. The openings should be never be blocked by placing the product on a bed, sofa, rug or other similar surface. This product should not be placed in a built-in installation such as a bookcase or rack unless proper ventilation is provided or the manufacturer's instruction has been adhered to.

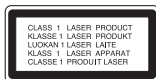

CAUTION:

This product employs a Laser System.

To ensure proper use of this product, please read this owner's manual carefully and retain it for future reference. Should the unit require maintenance, contact an authorized service center. Use of controls, adjustments or the performance of procedures other than those specified herein may result in hazardous radiation exposure.

To prevent direct exposure to laser beam, do not try to open the enclosure. Visible laser radiation when open. DO NOT STARE INTO BEAM.

CAUTION: The apparatus should not be exposed to water (dripping or splashing) and no objects filled with liquids, such as vases, should be placed on the apparatus.

CAUTION concerning the Power Cord

Most appliances recommend they be placed upon a dedicated circuit;

That is, a single outlet circuit which powers only that appliance and has no additional outlets or branch circuits. Check the specification page of this owner's manual to be certain.

Do not overload wall outlets. Overloaded wall outlets, loose or damaged wall outlets, extension cords, frayed power cords, or damaged or cracked wire insulation are dangerous. Any of these conditions could result in electric shock or fire. Periodically examine the cord of your appliance, and if its appearance indicates damage or deterioration, unplug it, discontinue use of the appliance, and have the cord replaced with an exact replacement part by an authorized servicer.

Protect the power cord from physical or mechanical abuse, such as being twisted, kinked, pinched, closed in a door, or walked upon. Pay particular attention to plugs, wall outlets, and the point where the cord exits the appliance.

To disconnect power from the mains, pull out the mains cord plug. When installing the product, ensure that the plug is easily accessible.



Disposal of your old appliance

1. When this crossed-out wheeled bin symbol is attached to a product it means the product is covered by the European Directive 2002/96/EC.
2. All electrical and electronic products should be disposed of separately from the municipal waste stream via designated collection facilities appointed by the government or the local authorities.
3. The correct disposal of your old appliance will help prevent potential negative consequences for the environment and human health.
4. For more detailed information about disposal of your old appliance, please contact your city office, waste disposal service or the shop where you purchased the product.

CE This product is manufactured to comply with EMC Directive 2004/108/EC and Low Voltage Directive 2006/95/EC.

European representative :

LG Electronics Service Europe B.V. Veluwezoom 15, 1327 AE Almere, The Netherlands (Tel : +31-036-547-8940)



There is so much your Hi-Fi system can do

Contents

About Player	4
About Remote control	5
Setting up	6
Listening to the radio	7
Listening to CDs	8
Listening to music from your portable player	8
Playing music using USB	9
Recording	9
Setting the Clock	10
Use your player as an alarm clock	10
Fall asleep while listening to your player	10
Sound quality adjustment	10
VSM (Virtual Sound Matrix)	10
About MP3/WMA	10
Troubleshooting	11
Specifications	11

The making of unauthorized copies of copy-protected material, including computer programs, files, broadcasts and sound recordings, may be an infringement of copyrights and constitute a criminal offence. This equipment should not be used for such purposes.

**Be responsible
Respect copyrights**

Before connecting, operating or adjusting this product, please read this instruction booklet carefully and completely.

About Player

DISPLAY WINDOW



Press  for longer than 3 seconds as the device is powered on, you can move into POWER SAVE MODE.

DISC TRAY

VOLUME

Control the volume when using any function.

CLOCK

For setting the clock and checking the time. (see Setting the Clock)

PHONES (Headphone jack)

Connect a headphone plug (ø3.5 mm) into the jack to listen to the sound through headphones. Connecting headphones (not supplied) will switch off the speakers.

PORT.IN

The player can be used to play the music from many types of portable player.

TIMER

With the TIMER function you can turn CD play and radio reception on or off at a desired time. (see Use your player as an alarm clock)

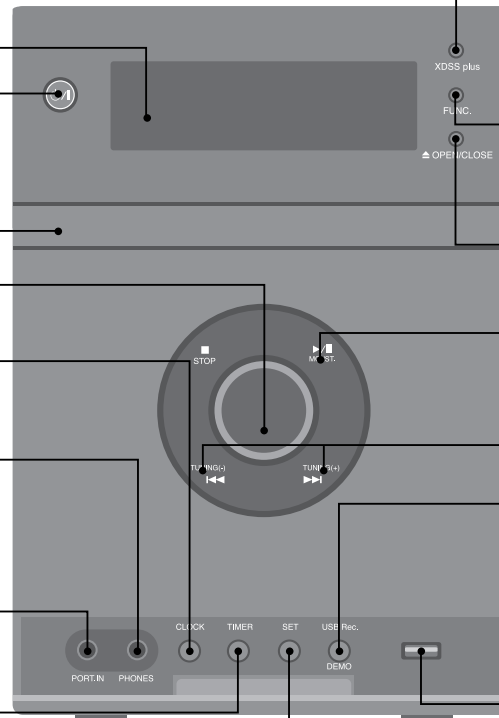

eXtreme Dynamic Sound System
Reinforce the treble, bass and surround sound effect. XDSS ON will show in the display. Press again for NORMAL.

OPTIMIZER
Optimizes compressible MP3 files so that it improves the bass sound. (XDSS ON → MP3 - OPT ON → NORMAL)

To change the functions
Change the functions among FM, AM, CD, USB, PORTABLE.

▲ OPEN/CLOSE
You can use it when inserting or removing CDs.

MO./ST.
This will change the tuner from stereo to mono and usually improve the reception.

Select the radio station

USB Rec.
Record FM, AM, Audio CD or PORTABLE source to USB.

DEMO
Press **DEMO** in power off state to demonstrate the function on display window. Press again to cancel.

USB connector
Connect a remote USB compatible player here.

SET (RDS-OPTIONAL)
Confirms the time you have selected when setting the clock. (see Setting the clock)

About Remote control

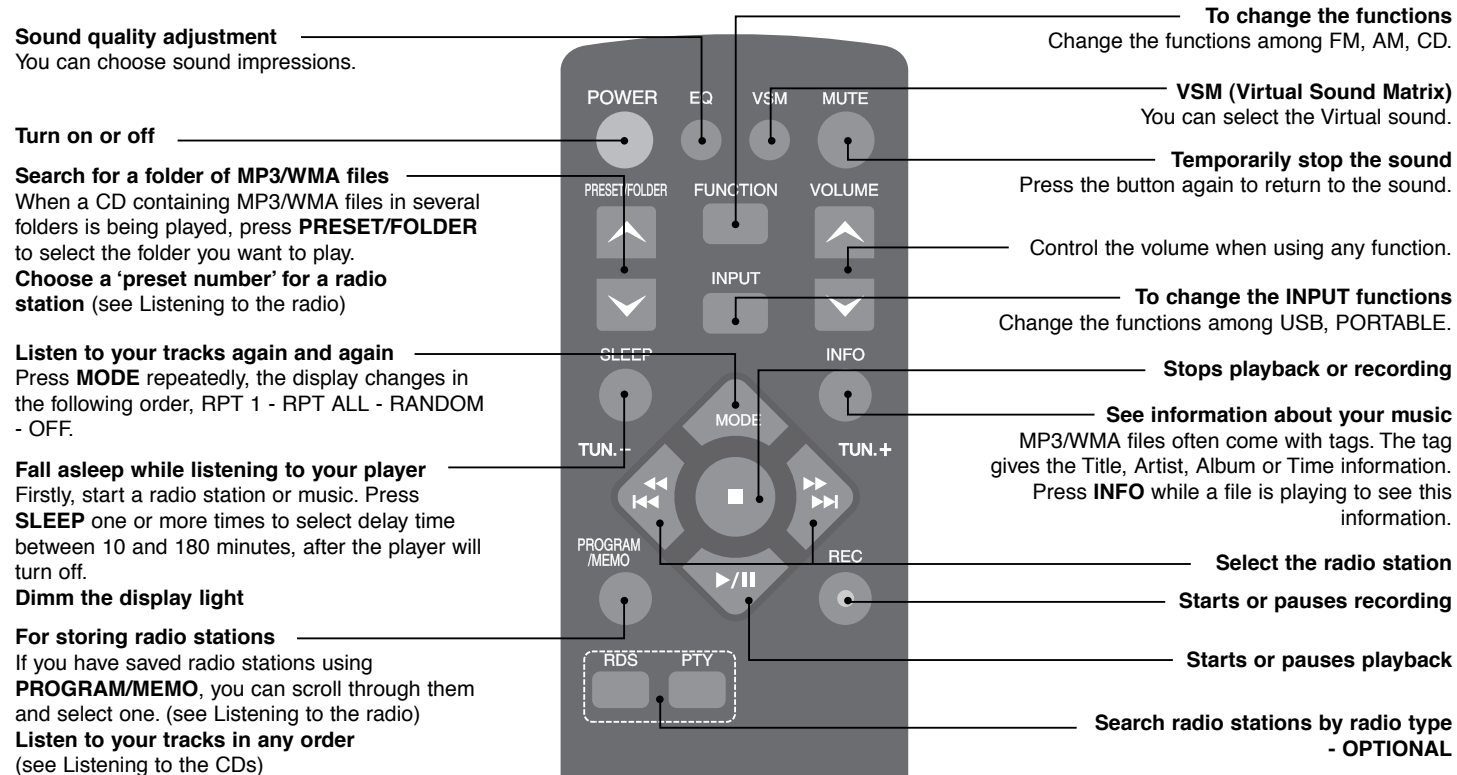

Setting up

1 Connect the speaker cables to the player

Cables from the left-hand speaker connect to the terminal marked L (left) + (plus) and - (minus). Cables from the right-hand speaker are connected to the terminal marked R (right) + (plus) and - (minus).

To connect the cable to the player, press each of the four square plastic finger pads on the rear of the player. The connector will open ready to receive a cable.

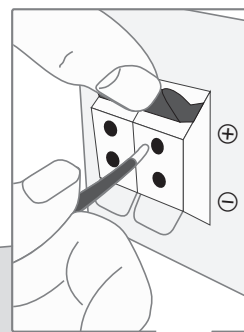

Put the battery in the remote control

Make sure that the + (plus) and - (minus) on the battery (size AAA) match those on the remote control.

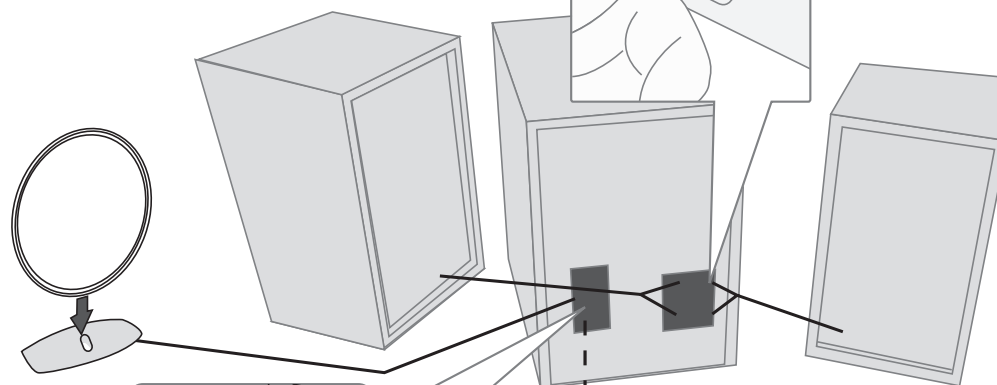
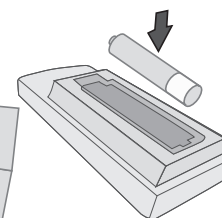

2 Fit the AM loop aerial to its stand

Connect the AM loop aerial to the player.

3 Connect the FM aerial

The reception will be at its best when the two loose ends of the aerial are in a straight line and horizontal.

4 Plug the power plug into a wall socket

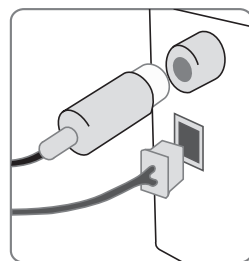

Listening to the radio

Make sure both the FM and AM aerials are connected.

	ON PLAYER	ON REMOTE
1. Select either FM or AM:	FUNC.	FUNCTION
2. Select the radio station:	TUNING (-)/ TUNING (+)	TUN.- /TUN.+
3. To 'save' a radio station: A preset number will show in the display.		PROGRAM/ MEMO
4. To select a 'saved' station:		PRESET/FOLDER
5. To confirm press: Up to 50 radio stations can be saved.		PROGRAM/ MEMO

Listening to the radio - more you can do

Look for radio stations automatically

Press **TUNING (-)/TUNING (+)** on the player or **TUN.- /TUN.+** on the remote control for more than 0.5 second. The tuner will scan automatically and stop when it finds a radio station.

Choose a 'preset number' for a radio station

Select a station you want by pressing **TUNING (-)/TUNING (+)** on the player or **TUN.- /TUN.+** on the remote control. Press **PROGRAM/MEMO**, the station flashes. Press **PRESET/FOLDER** on the remote control to select the preset number you want. Press **PROGRAM/MEMO** to save it.

Delete all the saved stations

Press and hold **PROGRAM/MEMO** on the remote control for two seconds. "ERASE ALL" shows. Press **PROGRAM/MEMO** to erase all the saved stations.

Improve poor FM reception

Press **MO./ST.** on the player or **▶/||** on the remote control. This will change the tuner from stereo to mono and usually improve the reception.

See information about your radio stations - OPTIONAL

The FM tuner is supplied with the Radio Data System (RDS) facility. This shows the letters RDS on the display, plus information about the radio station being listened to. Press **RDS** on the remote control several times to view the information.

PTY - Programme Type, such as News, Sport, Jazz.

RT - Radio Text, the name of the radio station.

CT - Time Control, the time at the location of the radio station.

PS - Programme Service name, the name of channel.

You can search the radio stations by programme type by pressing **RDS**. The display will show the last PTY in use. Press **PTY** one or more times to select your preferred programme type. Press and hold **◀◀/▶▶** (**◀◀◀◀/▶▶▶▶**). The tuner will search automatically. When a station is found the search will stop.

Listening to CDs

Audio CD and MP3/WMA CD can be played back in this player.

	ON PLAYER	ON REMOTE
1. Open the CD door:	▲ OPEN/CLOSE	
2. Insert the CD: Label facing up.		
3. Close the CD door: The display will show the total number of tracks (files).	▲ OPEN/CLOSE	
4. Select the CD function:	FUNC.	FUNCTION
5. Start the CD playing:	▶/	▶/
6. To stop a CD playing:	■	■

Listening to CDs - more you can do

Pause or restart a CD

Press ▶/|| during playback. Press this button again to resume play.

Search for a section within a track

Hold I◀◀/▶▶ on the front panel or I◀◀◀◀/▶▶▶▶ on the remote control during playback.

Speed search for tracks

Hold I◀◀/▶▶ on the front panel or I◀◀◀◀/▶▶▶▶ on the remote control. Track skips continuously in turn.

Skip to another track

Press I◀◀/▶▶ on the front panel or I◀◀◀◀/▶▶▶▶ on the remote control.

Listen to your tracks in any order

Up to 20 tracks on a CD can be listened to in the order of your choice. Insert a CD and wait for it to be read. Press **PROGRAM/MEMO** on the remote control, then use I◀◀/▶▶ (I◀◀◀◀/▶▶▶▶) to select the track. Press **PROGRAM/MEMO** again to save and select the next track. Press ▶/||. To clear your selection, press ■ twice .

Listening to music from your portable player

The player can be used to play the music from many types of portable player.

	ON PLAYER	ON REMOTE
1. Connect the portable player by plugging the unit into PORT. IN on the front of the player.		
2. Turn the power on:	⏻/	POWER
3. Select the PORTABLE function:	FUNC.	INPUT
4. Turn the portable player on and start it playing:		

Playing music using USB

The advantage of connecting your portable USB player through the system's USB port is that the portable device can be controlled from the system.

	ON PLAYER	ON REMOTE
1. Connect the portable player to the system using a USB cable (not supplied).		
2. Select the USB function: The display will show READ, followed by the number of files displayed:	FUNC.	INPUT
3. Start the USB playing:	▶/II	▶/II
4. To stop a USB playing:	■	■
5. Before disconnecting the portable USB player, change to any other function by pressing:	FUNC.	FUNCTION or INPUT
6. Remove the USB player:		

NOTES :

- Some portable devices are not compatible with this system.
- When various cards are connected to the Memory Card Reader, the first detected card is recognized.
- **Do not extract the USB device in operating.**
- A back up demands to prevent a data damage.
- If you use a USB extension cable or USB hub, the USB device might not be recognized.
- A device using NTFS file system is not supported (Only the FAT (16/32) file system is supported.).
- The USB function of this unit does not support all USB devices.
- Digital camera and mobile phones are not supported.
- This unit is not supported when the total number of files is 1000 or more.

Recording

Record FM, AM or PORTABLE source to USB

Connect USB to the player before recording.

	ON PLAYER	ON REMOTE
1. Select a mode (FM, AM or PORTABLE) in which you want to record:	FUNC.	FUNCTION or INPUT
2. Start the Recording:	USB Rec.	REC
3. To stop a Recording:	■	■

Record Audio CD source to USB

You can record one desired track or all of the music tracks in Audio CD to USB.

	ON PLAYER	ON REMOTE
1. Select the CD function:	FUNC.	FUNCTION
2. Select the track:	I◀◀/▶▶I	I◀◀◀◀/▶▶▶▶I
3. Start the Recording:	USB Rec.	REC
4. To stop a Recording:	■	■

NOTES :

- Remove USB while recording, the recorded file may not be saved.
- Press **USB Rec.** on the player or **REC** on the remote control for longer than 3 seconds, you can select bit rate. Press **I◀◀/▶▶I** (**I◀◀◀◀/▶▶▶▶I**) to select the bit rate and **USB Rec.** or **REC** again to select the recording speed. Press **I◀◀/▶▶I** (**I◀◀◀◀/▶▶▶▶I**) to select a desired recording speed and **USB Rec.** or **REC** again to finish recording.
 - 1 x speed : You can listen to music while recording it.
(FM, AM, PORTABLE or Audio CD)
 - 2 x speed (Only 96kbps, 128kbps)
- : You can just recording the music file. (Only Audio CD)

Setting the Clock

	ON PLAYER
1. Press for at least 2 seconds:	CLOCK
2. Choose from either: AM 12:00 (for an am and pm display) or 0:00 (for a 24 hour display)	◀◀/▶▶
3. Confirm your selection:	SET
4. Select the hours:	◀◀/▶▶
5. Press:	SET
6. Select the minutes:	◀◀/▶▶
7. Press:	SET

Use your player as an alarm clock

Press and hold **TIMER** on the player for two seconds. Each function, TUNER, CD, USB flashes for two seconds. Press **SET** on the player when the function you want to be woken by is showing.

If you choose TUNER you will be shown the stations you have saved as presets. Use **◀◀/▶▶** on the player to select the station you want, then press **SET**.

You will be shown the ON TIME display. This is where you set the time you want the alarm to go off. Use **◀◀/▶▶** on the player to change the hours and minutes and **SET** to save.

You will then be shown the OFF TIME display. This is where you set the time you want the function to stop. Use **◀◀/▶▶** on the player to change the hours and minutes and press **SET** to save.

Next you will be shown the volume (VOL) you want to be woken by.

Use **◀◀/▶▶** on the player to change the volume and **SET** to save. Switch the system off. The clock icon shows that the alarm is set.

When the system is turned off you can check the time the alarm is set for by pressing **TIMER**. You can also turn the alarm on and off by pressing **TIMER**. To set the alarm to go off at a different time, switch the system on and reprogramme following the same steps as initially.

Fall asleep while listening to your player

Press **SLEEP** on the remote control one or more times to select delay time between 10 and 180 minutes, after the player will turn off. Press **SLEEP** on the remote control repeatedly, the display changes in the following order, corresponding icons & dimmer ON → SLEEP 180 (dimmer ON) → SLEEP 150 (dimmer ON) → SLEEP 120 (dimmer ON) → SLEEP 90 (dimmer ON) → SLEEP 80 (dimmer ON) → SLEEP 70 (dimmer ON) → SLEEP 60 (dimmer ON) → SLEEP 50 (dimmer ON) → SLEEP 40 (dimmer ON) → SLEEP 30 (dimmer ON) → SLEEP 20 (dimmer ON) → SLEEP 10 (dimmer ON) → SLEEP OFF & (dimmer OFF).

Sound quality adjustment

You can choose sound impressions. Press **EQ** on the remote control repeatedly, the display changes in the following order, NORMAL → NATURAL → AUTO -- EQ (Only MP3/WMA file) → POP → CLASSIC → ROCK → JAZZ.

VSM (Virtual Sound Matrix)

You can select the Virtual sound. Press **VSM** on the remote control to set the virtual sound.

- ON STAGE : The sound fills Concert hall
- VIRTUAL : Realtime 3D positioned sound rendering technology with stereo sources, optimized for stereo speakers. Listeners may experience amazing virtual surround effects with their own multimedia players.

About MP3/WMA

MP3/WMA Disc compatibility with this unit is limited as follows:

- Sampling Frequency : 8 - 48 kHz (MP3), 32 - 48 kHz (WMA)
- Bit rate : 8 - 320 kbps (MP3), 48 - 320 kbps (WMA)
- CD-R physical format should be "ISO 9660"
- If you record MP3/WMA files using the software which cannot create a FILE SYSTEM, for example "Direct-CD" etc., it is impossible to playback MP3 files. We recommend that you use "Easy-CD Creator", which creates an ISO 9660 file system.
- Do not use special letters such as "/ : * ? " < >" etc.
- Even if the total number of files on the disc has more than 1000, it will only be shown up to 999.

Troubleshooting		
Symptom	Cause	Correction
General		
No power.	The power cord is not plugged in.	Plug in the power cord.
	Check whether electricity failed.	Check the condition by operating other electronic devices.
No sound.	Check whether you select right function.	Press FUNC. (FUNCTION/INPUT) and check the selected function.
CD		
The unit does not start playback.	An unplayable disc is inserted.	Insert a playable disc.
	The disc is dirty.	Clean the disc.
RADIO		
Radio stations cannot be tuned in.	The antenna is positioned or connected poorly.	Connect the antenna securely.
Remote control		
The remote control does not work properly.	The remote control is too far from the unit.	Operate the remote control within about 23 ft (7 m).
	There is an obstacle in the path of the remote control and the unit.	Remove the obstacle.
	The battery in the remote control is exhausted.	Replace the battery with new one.

Specifications	
General	
Power supply	Refer to main label.
Power consumption	Refer to main label.
Net Weight	2.9 kg
External dimensions (WxHxD)	170 x 240 x 260 mm
Operating temperature	5 °C to 35 °C
Operating humidity	5% to 85 %
Tuner	
FM Tuning Range	87.5 - 108.0 MHz or 65 - 74 MHz, 87.5 - 108.0 MHz
AM Tuning Range	522 - 1620 kHz or 520 - 1720 kHz
Amplifier	
Output Power	30 W + 30 W
T.H.D	0.5 %
Frequency Response	40 - 20000 Hz
Signal-to-noise ratio	75 dB
CD	
Frequency response	40 - 20000 Hz
Signal-to-noise ratio	75 dB
Dynamic range	75 dB
Speakers (XAS63F)	
Type	1 Way 1 Speaker
Impedance	4 Ω
Frequency Response	80 - 15000 Hz
Sound Pressure Level	85 dB/W (1m)
Rated Input Power	30 W
Max. Input Power	60 W
Net Dimensions (WxHxD)	150 x 242 x 170 mm
Net Weight (1EA)	1.55 kg

Designs and specifications are subject to change without notice.



P/NO : MFL41698405