



LCD TV | PLASMA TV OWNER'S MANUAL

LCD TV MODELS

37LF6* 37LY9*
 42LF6* 42LY9*
 47LF6* 47LY9*
 52LF6* 52LY9*
 37LF7*
 42LF7*

PLASMA TV MODELS

50PF9*
 60PF9*

Please read this manual carefully before operating your set.
 Retain it for future reference.
 Record model number and serial number of the set.
 See the label attached on the back cover and quote this information to your dealer when you require service.



Trade Mark of the DVB Digital Video
 Broadcasting Project (1991 to 1996)

ID Number(s):	4560: 37LY95	4536: 47LF65
	4534: 42LY95	4604: 37LY96
	4558: 47LY95	4606: 47LY96
	4537: 42LF65	4608: 37LF66
	4605: 42LY96	4610: 47LF66
	4607: 52LY96	4612: 52LF66
	4609: 42LF66	4614: 50PF96
	4611: 52LF65	4724: 37LF75
	4725: 42LF75	4911: 42LY99
	4615: 60PF96	4965: 50PF95 (50PF95-ZJ)
	4551: 60PF95	4613: 50PF95 (50PF95-ZA)
	4535: 37LF65	5110: 37LF76
		5111: 42LF76



ACCESSORIES

Ensure that the following accessories are included with your TV. If an accessory is missing, please contact the dealer where you purchased the product.

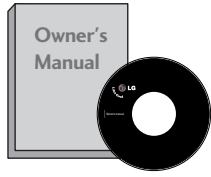

Owner's Manual



Power Cord



Batteries

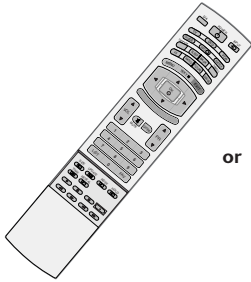

or

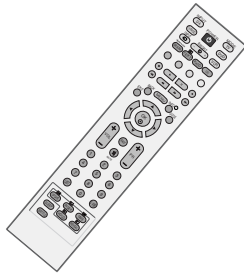

Remote Control

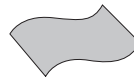

Polishing Cloth
Polish the screen with the cloth.

Slightly wipe stained spot on the exterior only with the cleansing cloths for the product exterior if there is stain or fingerprint on surface of the exterior.

Do not wipe roughly when removing stain. Please be cautious of that excessive power may cause scratch or discoloration.

Plasma TV models

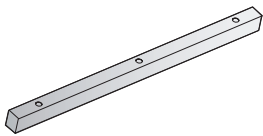

One desk-type stand fixture protection cover
Refer to p. 15



3-bolts
Refer to p. 15

50PF9* only

■ This feature is not available for all models.



2-Wall brackets



2-eye-bolts

60PF9* only

■ This feature is not available for all models.



2-TV Brackets
2-Wall Brackets



2-bolts



Two rubber caps
Refer to p. 15

LCD TV models

■ This feature is not available for all models.



2-TV Brackets
2-Wall Brackets



2-bolts



Twister Holder
Arrange the wires with the twister holder.



or



Cable Management

37" only



4-bolts for stand assembly
Refer to p. 10

37LF7* only



1-screw for stand fixing
Refer to p. 10

CONTENTS

ACCESSORIES 1

PREPARATION

Front Panel Controls.....	4
Back Panel Information.....	7
Stand installation.....	10
ATTACHING THE TV TO A DESK.....	10
Attaching the TV to a wall.....	11
Back Cover for Wire Arrangement.....	12
Desktop Pedestal Installation.....	15
Wall Mount: Horizontal installation.....	15
Antenna Connection.....	16

EXTERNAL EQUIPMENT SETUP

HD Receiver Setup.....	17
DVD Setup.....	20
Insertion of CI module.....	22
VCR Setup.....	23
Digital Audio Out Setup.....	25
Other A/V Source Setup.....	26
PC Setup.....	27
- Screen Setup for PC Mode.....	30

WATCHING TV / PROGRAMME CONTROL

Remote Control Key Functions.....	34
Turning on the TV.....	38
Programme Selection.....	39
Volume Adjustment.....	39
On Screen Menus Selection and Adjustment.....	40
Auto Programme Tuning (In Digital Mode).....	41
Manual Programme Tuning (In Digital Mode).....	42
Programme Edit (In Digital Mode).....	43
5V antenna Power (In Digital Mode only).....	45
Software Update (In Digital Mode only).....	46
Diagnostics (In Digital Mode only).....	47
CI Information (In Digital Mode only).....	48
Auto Programme Tuning (In Analogue Mode).....	49
Manual Programme Tuning (In Analogue Mode).....	50

Fine Tuning (In Analogue Mode).....	51
Assigning a Station Name (In Analogue Mode).....	51
Programme Edit (In Analogue Mode).....	52
Calling the Programme Table.....	54
Input Source Selection.....	55
Index.....	55
SIMPLINK.....	56

PICTURE CONTROL

EPG (Electronic programme guide) (In Digital Mode)	
- Switch on/off EPG.....	58
- Select a programme.....	58
- Button function in NOW/NEXT guide mode.....	59
- Button function in 8 days guide mode.....	59
- Button function in date change mode.....	59
- Button function in extended description box.....	60
- Button function in record/remind setting mode.....	60
- Button function in timer list mode.....	60
Picture Size (Aspect Ratio) Control.....	61
Preset Picture Settings	
- Picture Mode-Preset.....	63
- Auto Colour Tone Control (Warm/Medium/Cool).....	64
Manual Picture Adjustment	
- Picture Mode-User option.....	65
- Colour Tone - User option.....	66
XD - Picture Improvement Technology.....	67
XD Demo.....	68
TruMotion Demo.....	68
Advanced - Cinema.....	69
Advanced - TruMotion.....	69
Advanced - Black(Darkness) Level.....	70
Picture Reset.....	71
Image Sticking Minimization(ISM) Method.....	72
Low-Power Picture Mode.....	73

SOUND & LANGUAGE CONTROL

Auto Volume Leveler	74
Preset Sound Settings - Sound Mode	75
Sound Setting Adjustment - User Mode	76
Balance	77
TV Speakers On/ Off Setup	78
Selecting digital audio out	79
I/II	
- Stereo/Dual Reception (In Analogue Mode Only)	80
- NICAM Reception (In Analogue Mode Only)	81
- Speaker Sound Output Selection	81
On-Screen Menu Language/Country Selection	82
Language selection (In Digital Mode only)	83

TIME SETTING

Clock Setup	84
Auto On/ Off Timer Setting	85
Auto Shut-off Setting	86
Time Zone Setup	87
Sleep Timer Setting	87

PARENTAL CONTROL / RATINGS

Set Password & Lock System	88
Parental Control	89

TELETEXT

Switch on/off	90
SIMPLE Text	90
TOP Text	90
FASTEXT	91
Special Teletext Functions	91

DIGITAL TELETEXT

Teletext within Digital Service	92
Teletext in Digital Service	92

APPENDIX

Troubleshooting	93
Maintenance	95
Product Specifications	96
Programming the Remote Control	98
IR Codes	102
External Control Device Setup	104

PREPARATION

FRONT PANEL CONTROLS

- This is a simplified representation of the front panel. Here shown may be somewhat different from your TV.
- If your product has a protection film attached, remove the film and then wipe the product with a polishing cloth.

Plasma TV Models: 50PF9*, 60PF9*

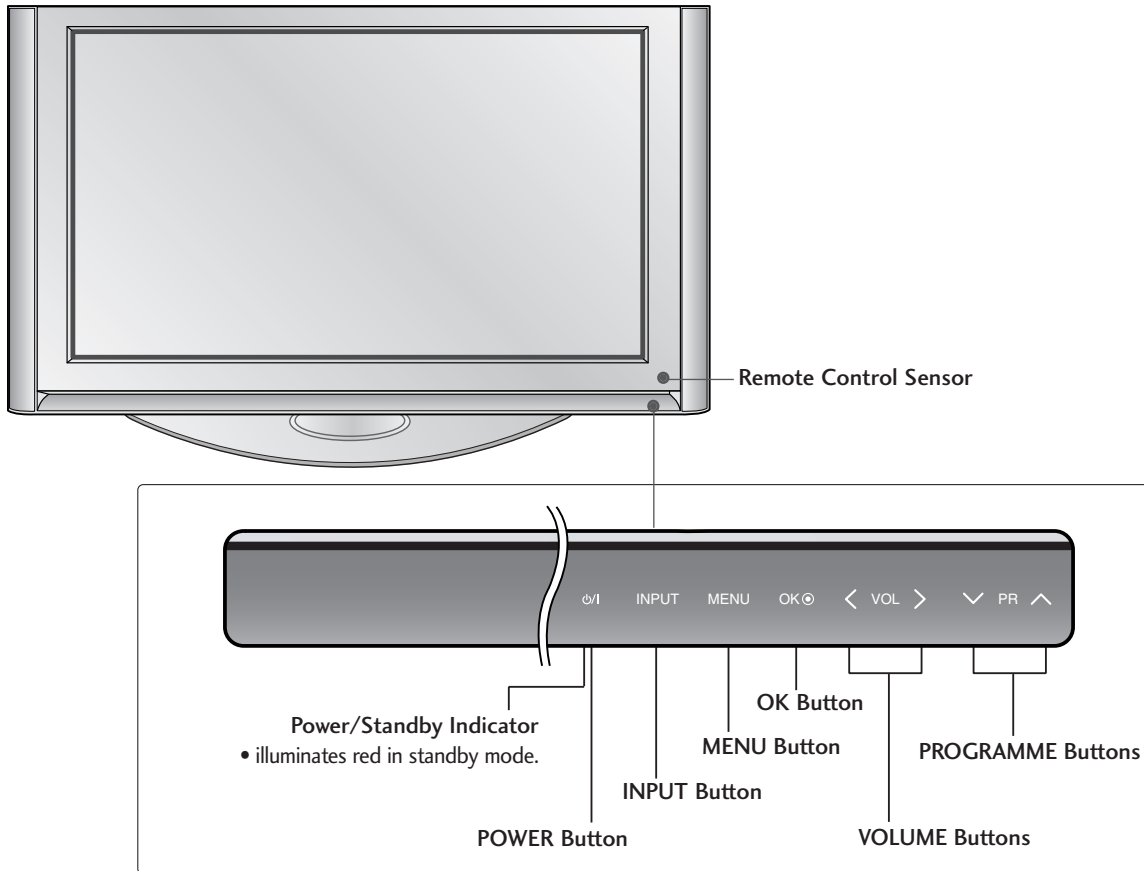

SWIVEL STAND (Only PLASMA TV MODELS)

After installing the TV, you can adjust the TV set manually to the left or right direction by 20 degrees to suit your viewing position.

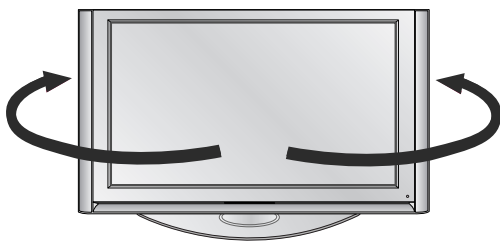

NOTE

- ▶ Before adjusting the angle, you must remove the cable management and loosen (to the left) the shaft bolt on the middle of stand's back. And when stand be level with TV, you must close (to the right) the shaft bolt to set the hole.

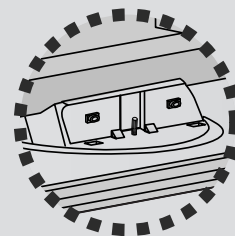

LCD TV Models: 37LF6*, 42LF6*, 47LF6*, 52LF6*

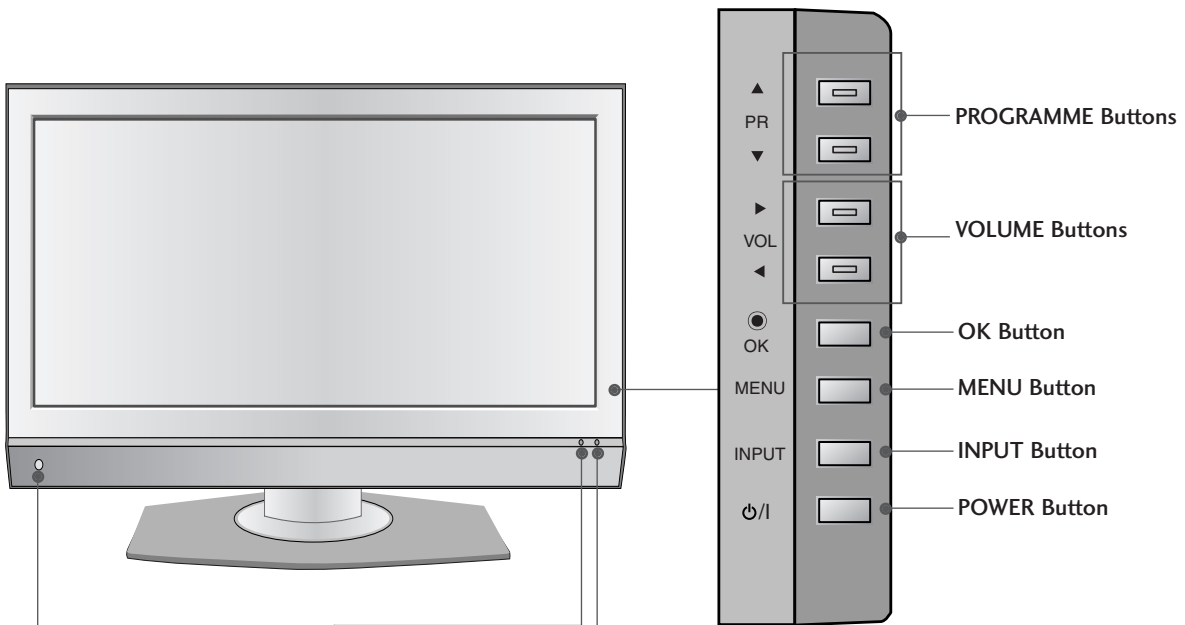

Intelligent Eye
Adjusts picture according to the surrounding conditions.

Remote Control Sensor

Power/Standby Indicator

- illuminates red in standby mode.
- illuminates green when the set is switched on.

PREPARATION

LCD TV Models: 37LY9*, 42LY9*, 47LY9*, 52LY9*

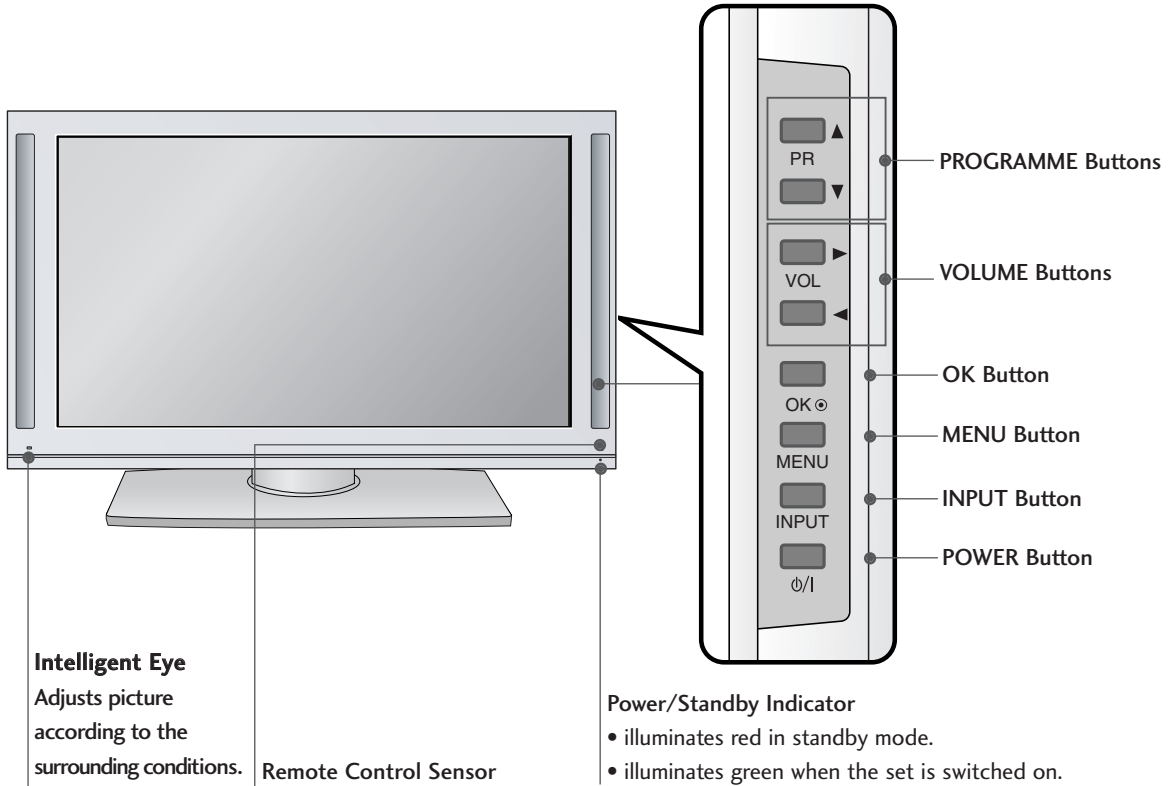

LCD TV Models: 37/42LF7*

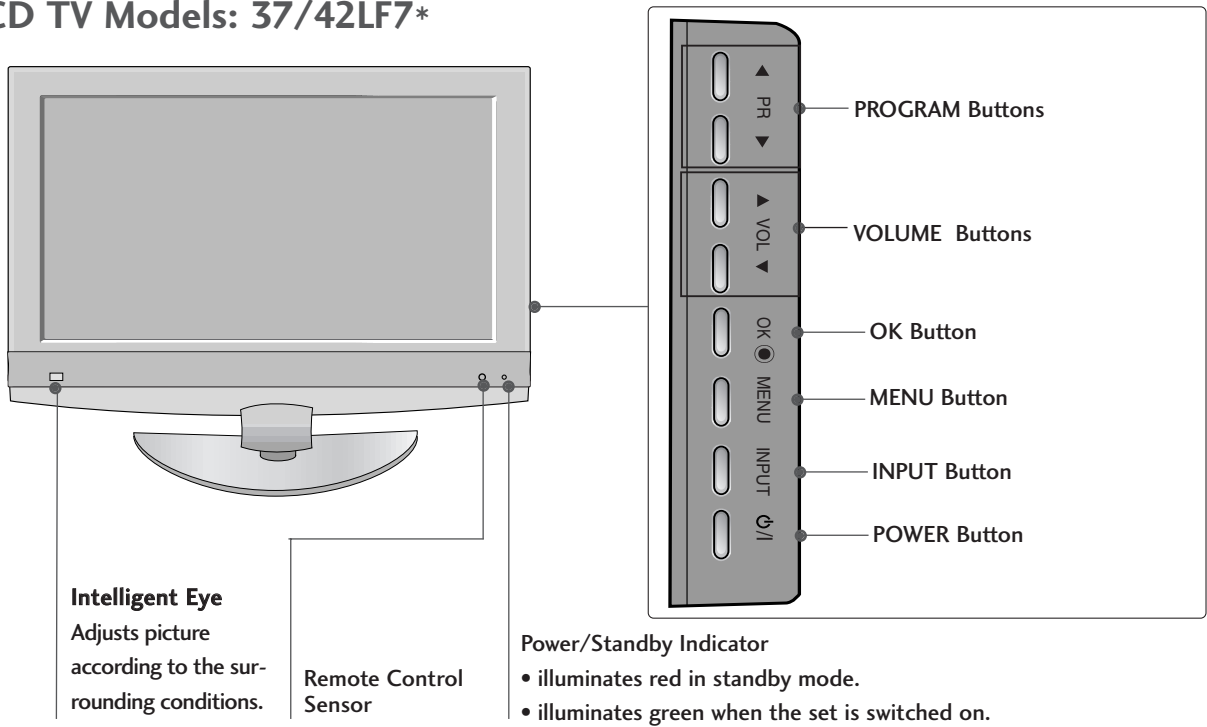

BACK PANEL INFORMATION

■ This is a simplified representation of the back panel. Here shown may be somewhat different from your TV.

Plasma TV Models

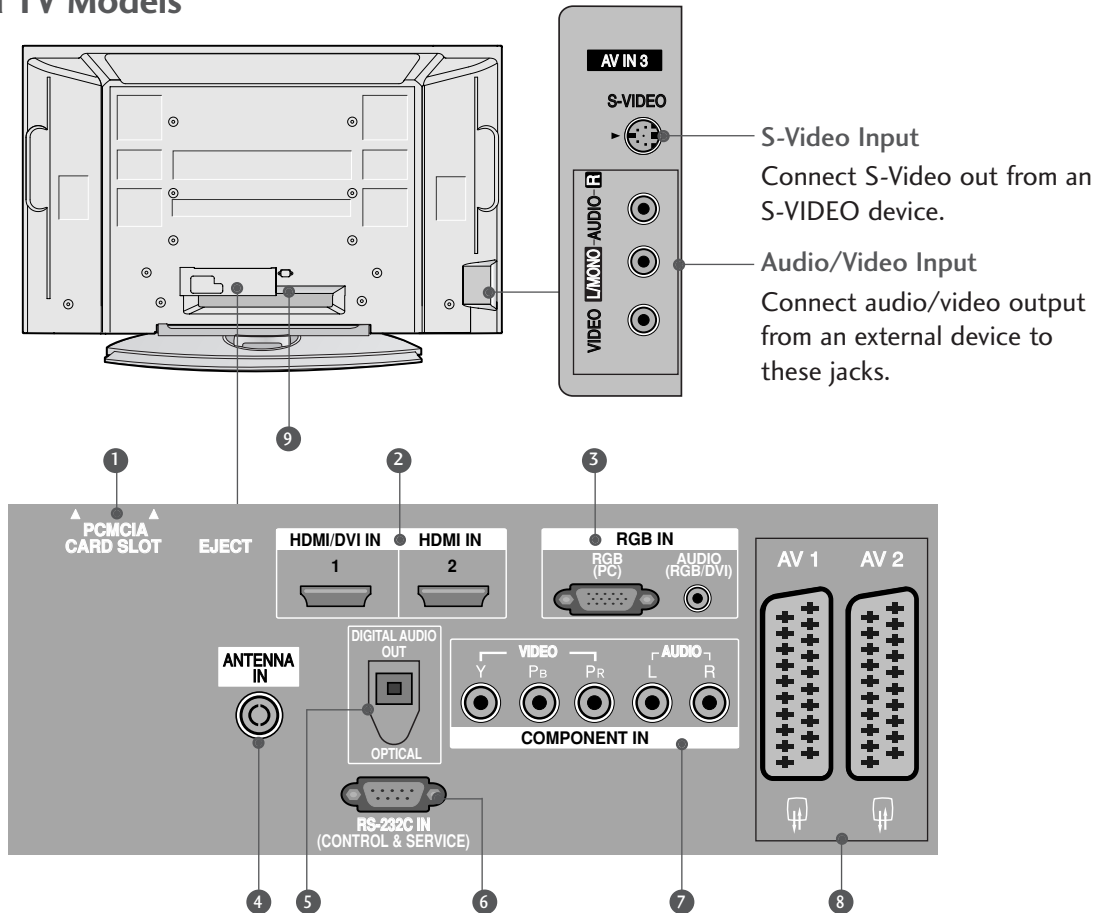

- 1 PCMCIA (Personal Computer Memory Card International Association) Card Slot
(This feature is not available in all countries.)
- 2 HDMI Input
Connect a HDMI signal to HDMI IN.
Or DVI(VIDEO)signal to HDMI/DVI port with DVI to HDMI cable.
- 3 RGB/DVI Audio Input
Connect the monitor output from a PC to the appropriate input port.
- 4 Antenna Input
Connect over-the-air signals to this jack.
- 5 DIGITAL AUDIO OUT OPTICAL
Connect digital audio from various types of equipment.
Note: In standby mode, these ports do not work.
- 6 RS-232C IN (CONTROL & SERVICE) PORT
Connect to the RS-232C port on a PC.
- 7 Component Input
Connect a component video/audio device to these jacks.
- 8 Euro Scart Socket (AV1/AV2)
Connect scart socket input or output from an external device to these jacks.
- 9 Power Cord Socket
This TV operates on an AC power. The voltage is indicated on the Specifications page. Never attempt to operate the TV on DC power.

PREPARATION

LCD TV Models (Except 37/42LF7*)

PREPARATION

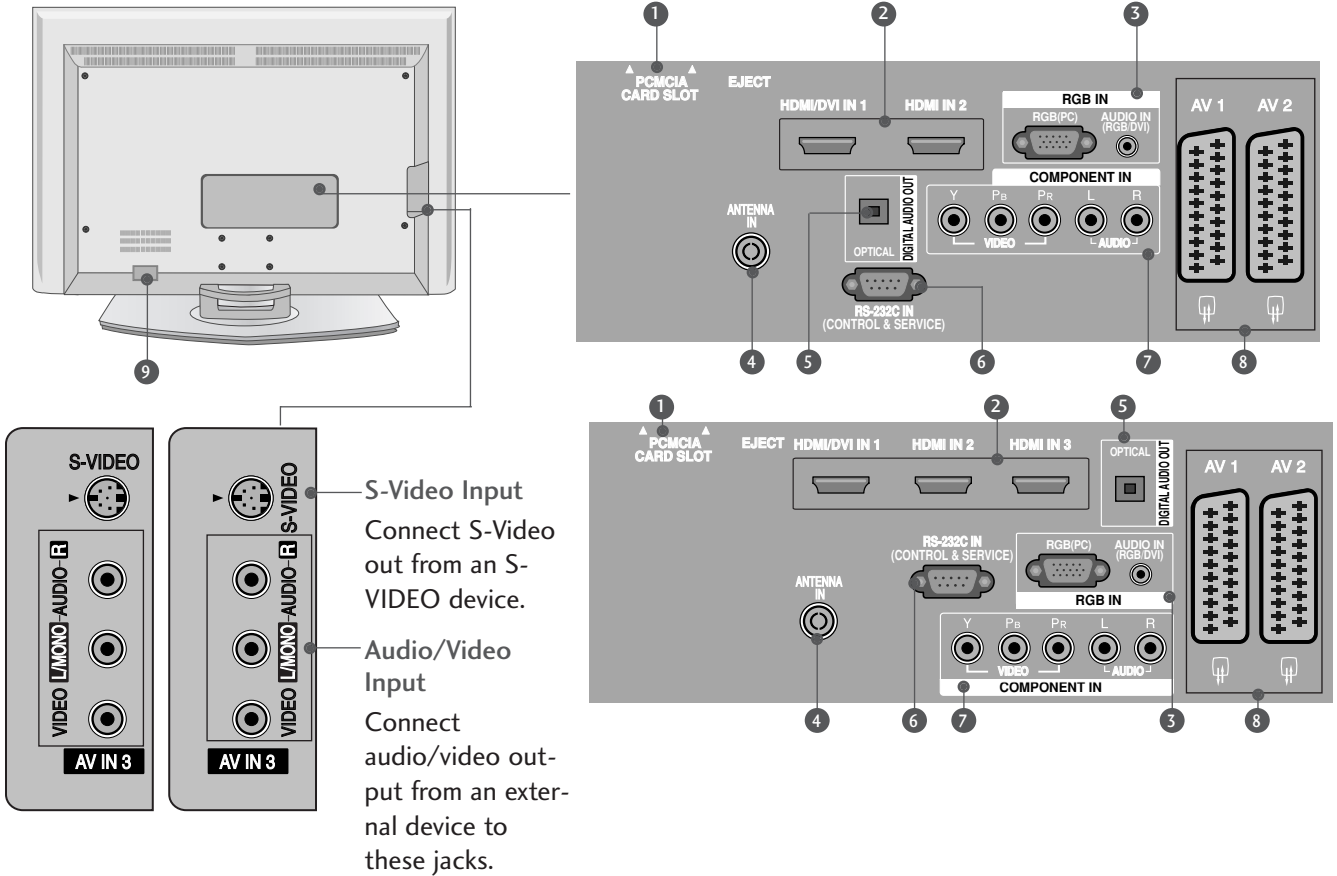

- ❶ PCMCIA (Personal Computer Memory Card International Association) Card Slot
(This feature is not available in all countries.)
- ❷ HDMI Input
Connect a HDMI signal to HDMI IN.
Or DVI(VIDEO)signal to HDMI/DVI port with DVI to HDMI cable.
- ❸ RGB/DVI Audio Input
Connect the monitor output from a PC to the appropriate input port.
- ❹ Antenna Input
Connect over-the-air signals to this jack.
- ❺ DIGITAL AUDIO OUT OPTICAL
Connect digital audio from various types of equipment.
Note: In standby mode, these ports do not work.
- ❻ RS-232C IN (CONTROL & SERVICE) PORT
Connect to the RS-232C port on a PC.
- ❼ Component Input
Connect a component video/audio device to these jacks.
- ❽ Euro Scart Socket (AV1/AV2)
Connect scart socket input or output from an external device to these jacks.
- ❾ Power Cord Socket
This TV operates on an AC power. The voltage is indicated on the Specifications page. Never attempt to operate the TV on DC power.

LCD TV Models : 37/42LF7*

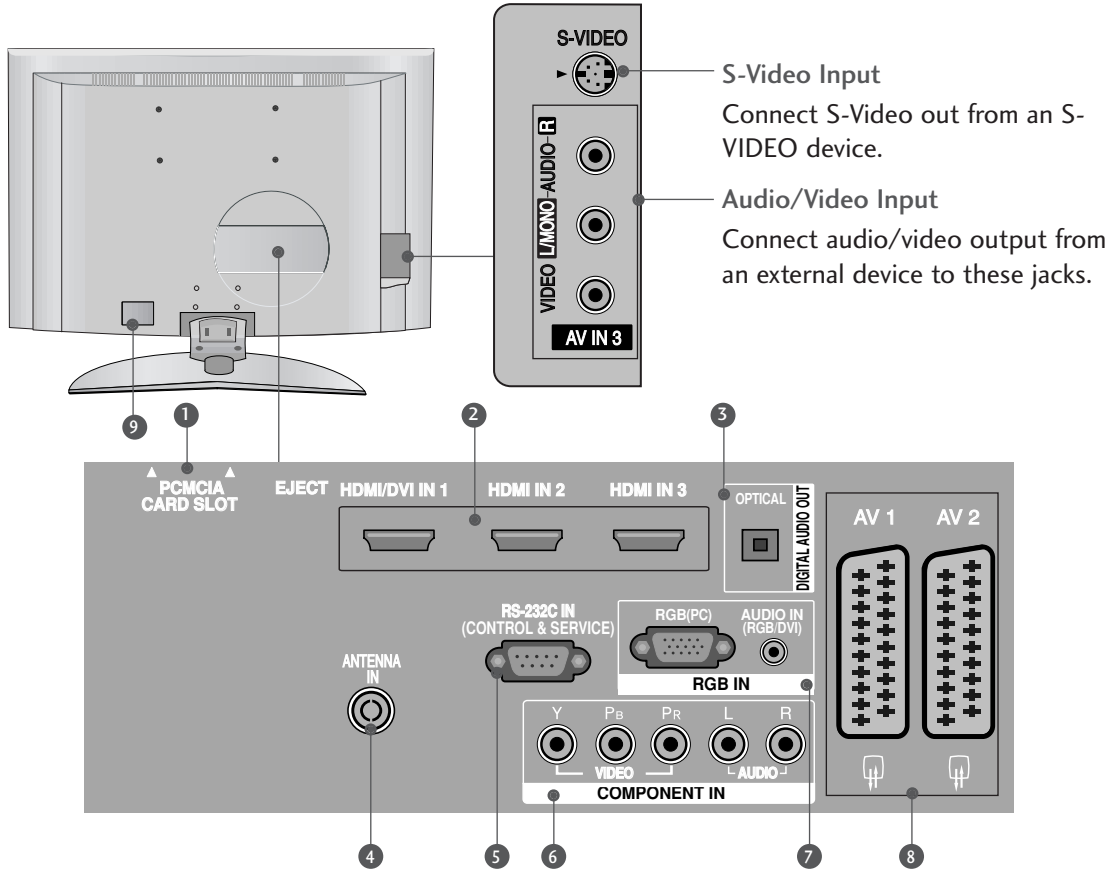

- 1** PCMCIA (Personal Computer Memory Card International Association) Card Slot
(This feature is not available in all countries.)
- 2** HDMI Input
Connect a HDMI signal to HDMI IN.
Or DVI(VIDEO)signal to HDMI/DVI port with DVI to HDMI cable.
- 3** DIGITAL AUDIO OUT OPTICAL
Connect digital audio from various types of equipment.
Note: In standby mode, these ports do not work.
- 4** Antenna Input
Connect over-the-air signals to this jack.
- 5** RS-232C IN (CONTROL & SERVICE) PORT
Connect to the RS-232C port on a PC.
- 6** Component Input
Connect a component video/audio device to these jacks.
- 7** RGB/DVI Audio Input
Connect the monitor output from a PC to the appropriate input port.
- 8** Euro Scart Socket (AV1/AV2)
Connect scart socket input or output from an external device to these jacks.
- 9** Power Cord Socket
This TV operates on an AC power. The voltage is indicated on the Specifications page. Never attempt to operate the TV on DC power.

PREPARATION

STAND INSTALLATION (Only 37 inch LCD TV Models)

- 1 Carefully place the product screen side down on a cushioned surface that will protect product and screen from damage.

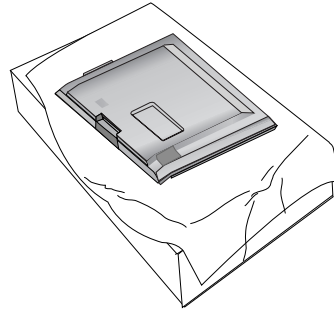

- 2 Assemble the product stand with the product as shown.

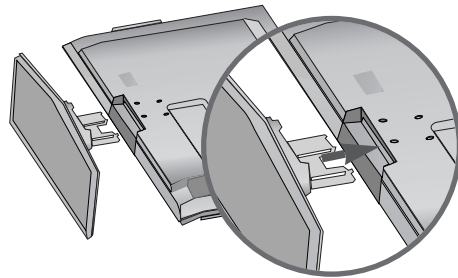

- 3 Install the 4 bolts securely, in the back of the product in the holes provided.

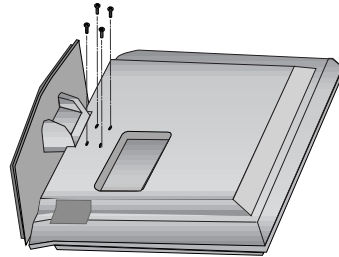

ATTACHING THE TV TO A DESK (Only 37LF7*)

The TV must be attached to desk so it cannot be pulled in a forward/backward direction, potentially causing injury or damaging the product. Use only an attached screw.

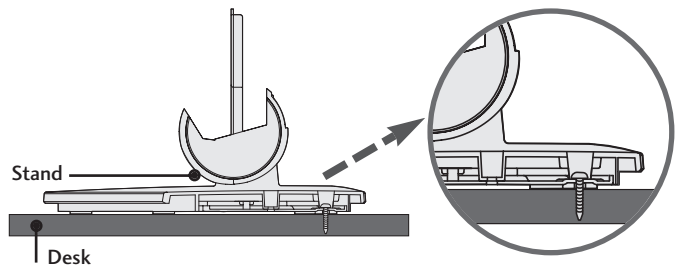
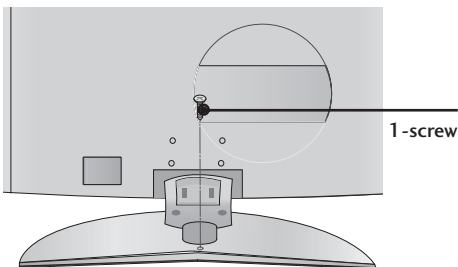

⚠ WARNING

- ▶ To prevent TV from falling over, the TV should be securely attached to the floor/wall per installation instructions. Tipping, shaking, or rocking the machine may cause injury.

ATTACHING THE TV TO A WALL

- This feature is not available for all models.
- Set it up close to the wall so the product doesn't fall over when it is pushed backwards.
- The instructions shown below is a safer way to set up the product, which is to fix it on the wall so the product doesn't fall over when it is pulled in the forward direction. It will prevent the product from falling for-ward and hurting people. It will also prevent the product from damage caused by fall. Please make sure that children don't climb on or hang from the product.

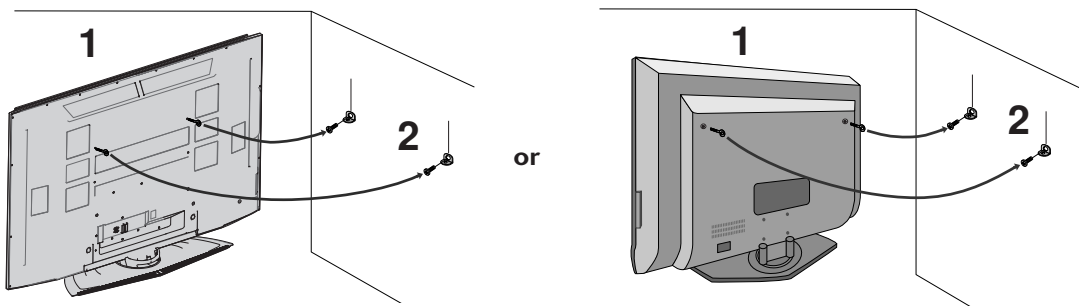

- 1 Use the eye-bolts or TV brackets/bolts to fix the product to the wall as shown in the picture.
(If your product has the bolts in the eye-bolts position before inserting the eye-bolts, loosen the bolts.)
* Insert the eye-bolts or TV brackets/bolts and tighten them securely in the upper holes.
- 2 Secure the wall brackets with the bolts (not provided as parts of the product, must purchase separately) on the wall. Match the height of the bracket that is mounted on the wall.

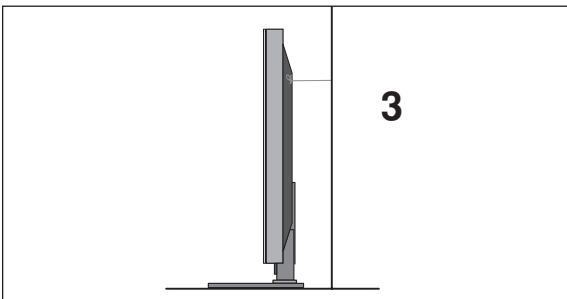

- 3 Use a sturdy rope (not provided as parts of the product, must purchase separately) to tie the product. It is safer to tie the rope so it becomes horizontal between the wall and the product.

! NOTE

- ▶ When moving the product to another place undo the ropes first.
- ▶ Use a product holder or a cabinet that is big and strong enough for the size and weight of the product.
- ▶ To use the product safely make sure that the height of the bracket that is mounted on the wall is same as that of the product.

PREPARATION

BACK COVER FOR WIRE ARRANGEMENT

Plasma TV models

PREPARATION

- 1 Hold the **CABLE MANAGEMENT** with both hands and pull it as shown.

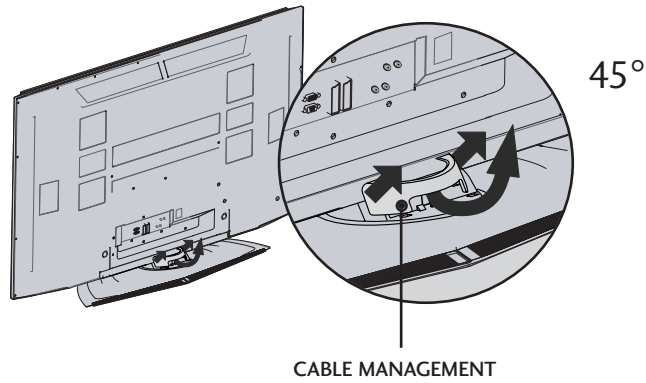

- 2 Connect the cables as necessary.
To connect an additional equipment, see the **External equipment Connections** section.

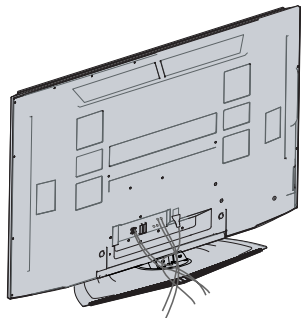

- 3 Reinstall the **CABLE MANAGEMENT** as shown.

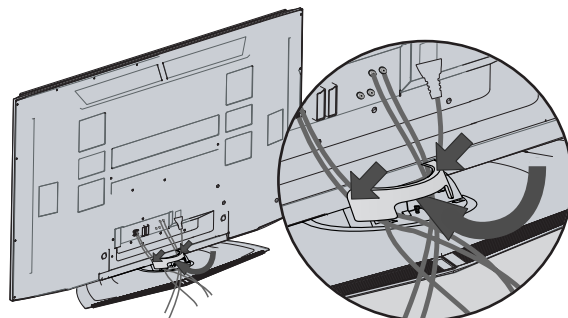

LCD TV models (Except 37/42LF7*)

- 1 Connect the cables as necessary.

To connect an additional equipment, see the **External equipment Connections** section.

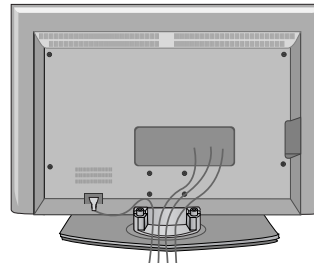

- 2 Install the **CABLE MANAGEMENT** as shown.

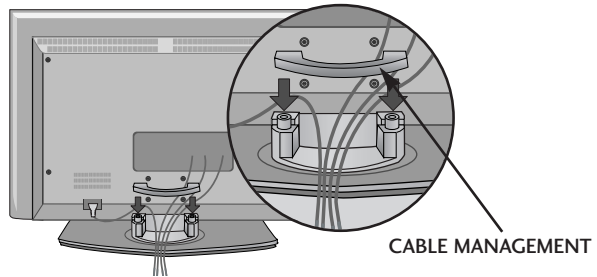

- 3 Bundle the cables using the supplied twister holder.
(This feature is not available for all models.)

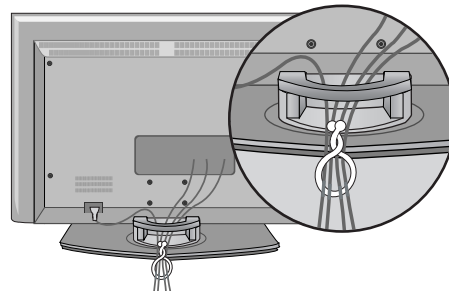

How to remove the cable management

Hold the **CABLE MANAGEMENT** with both hands and pull it upward.

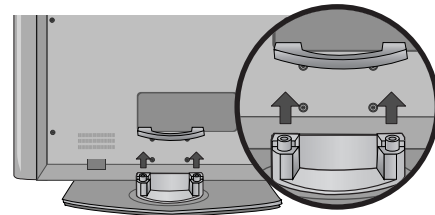

! NOTE

- ▶ Do not hold the **CABLE MANAGEMENT** when moving the product.
- If the product is dropped, you may be injured or the product may be broken.

PREPARATION

LCD TV model (Only 37/42LF7*)

- 1 Connect the cables as necessary.
To connect an additional equipment, see the **External equipment Connections** section.

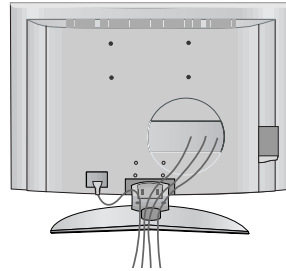

- 2 Install the **CABLE MANAGEMENT** as shown.
(Insert it as pushing the loops on the both sides of the cable management.)

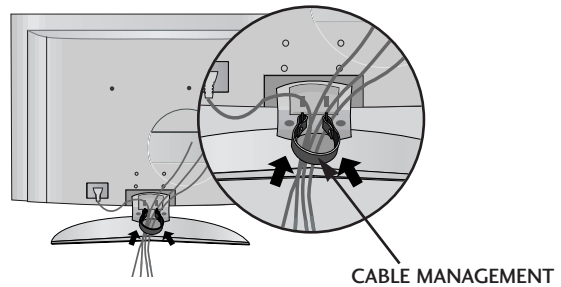

- 3 Bundle the cables using the supplied twist holder.
(This feature is not available for all models.)

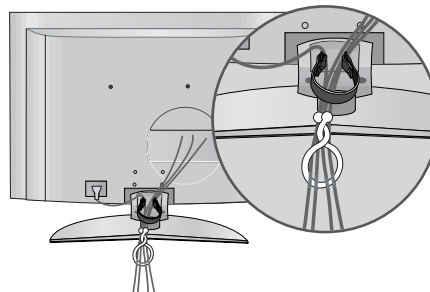

How to remove the cable management

Hold the **CABLE MANAGEMENT** with both hands and pull it out.
(Pull it out as holding the loops on the both sides of the cable management.)

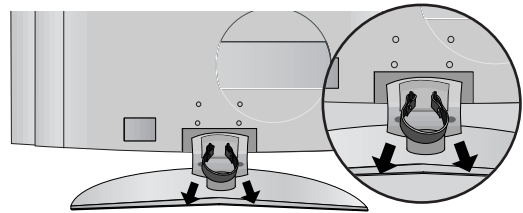

! NOTE

- ▶ Do not hold the **CABLE MANAGEMENT** when moving the product.
- If the product is dropped, you may be injured or the product may be broken.

- The set can be installed in various ways such as on a wall, or on a desktop etc.
- The set is designed to be mounted horizontally.

GROUNDING

Ensure that you connect the earth ground wire to prevent possible electric shock. If grounding methods are not possible, have a qualified electrician install a separate circuit breaker. Do not try to ground the unit by connecting it to telephone wires, lightening rods, or gas pipes.

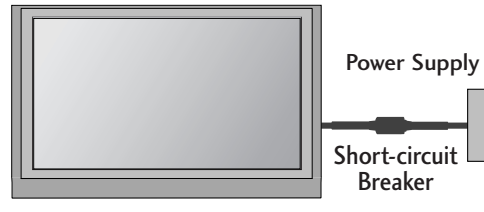

DESKTOP PEDESTAL INSTALLATION

For proper ventilation, allow a clearance of 4" on each side and from the wall.

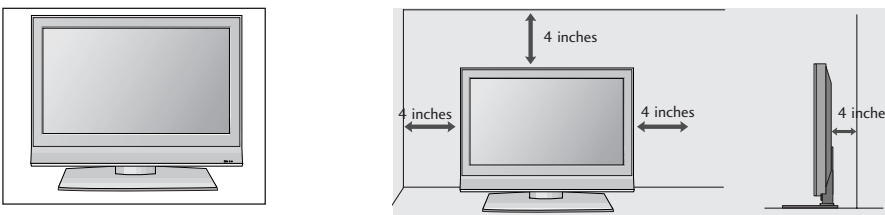

When not using the desk-type stand (60PF9* only)

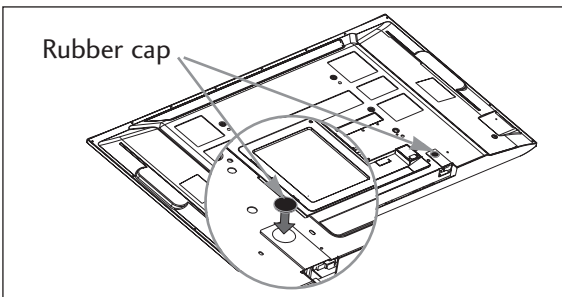

When not using the desk-type stand, install the supplied rubber caps for protecting the desk-type stand fixture as shown at the figure.

WALL MOUNT: HORIZONTAL INSTALLATION

For proper ventilation, allow a clearance of 4" on each side and from the wall. Detailed installation instructions are available from your dealer, see the optional Tilt Wall Mounting Bracket Installation and Setup Guide.

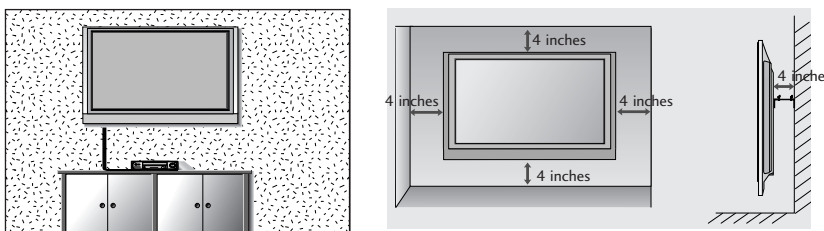

If you want to install the desk-type stand fixture protection cover (Plasma TV models only)

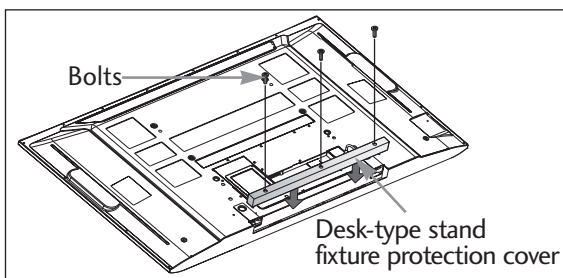

To prevent the foreign materials from entering the desk-type stand fixture, fix the desk-type stand fixture protection cover by using the supplied bolts as shown at the figure.

PREPARATION

- To prevent the equipment damage, never plug in any power cords until you have finished connecting all equipment.

ANTENNA CONNECTION

- For optimum picture quality, adjust antenna direction.
- An antenna cable and converter are not supplied.

PREPARATION

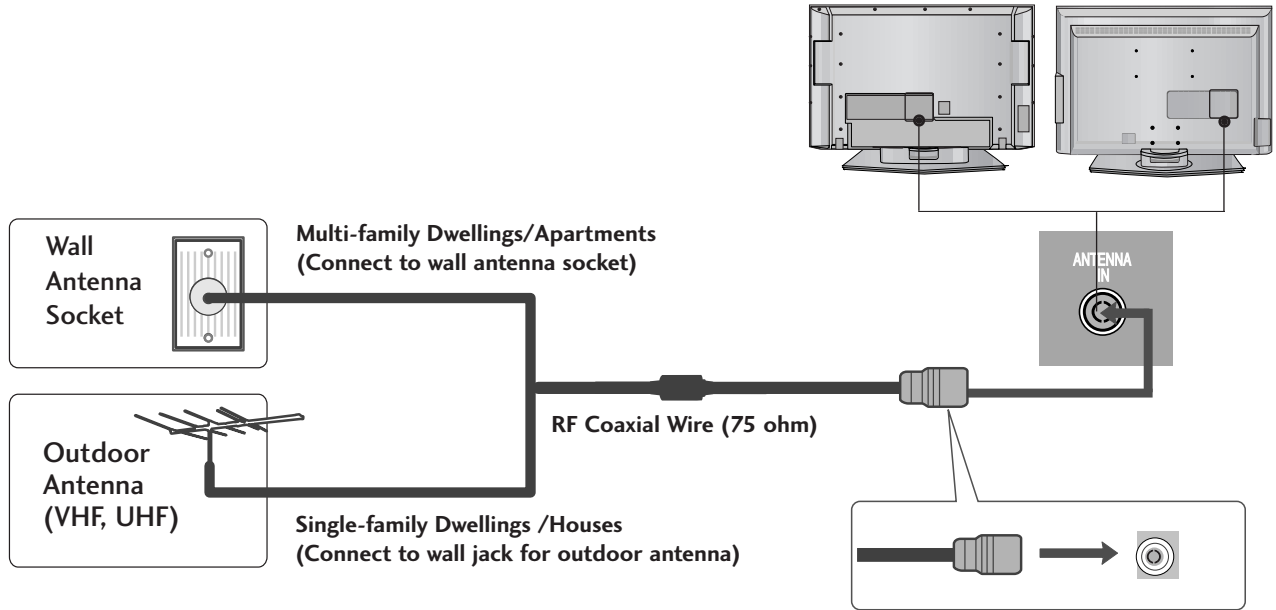

- Be careful not to bend the bronze wire when connecting to an antenna port.
- 5V antenna power works In Digital mode only. (Refer to p. 45)

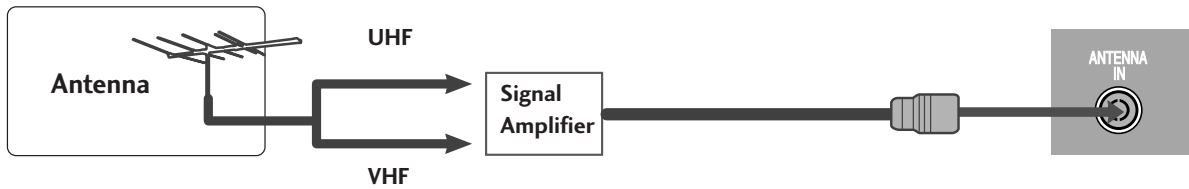

- In poor signal areas, to get better picture quality, install a signal amplifier to the antenna as shown to the right.
- If signal needs to be split for two TVs, use an antenna signal splitter for connection.

EXTERNAL EQUIPMENT SETUP

- To prevent the equipment damage, never plug in any power cords until you have finished connecting all equipment.
- This part of EXTERNAL EQUIPMENT SETUP mainly use pictures for the LCD TV models.

HD RECEIVER SETUP

- This TV can receive Digital Over-the-air/Cable signals without an external digital set-top box. However, if you do receive Digital signals from a digital set-top box or other digital external device, refer to the figure as shown below.

When connecting with a component cable

- 1 Connect the video outputs (Y, Pb, Pr) of the digital set top box to the **COMPONENT IN VIDEO** jacks on the set.
- 2 Connect the audio output of the digital set-top box to the **COMPONENT IN AUDIO** jacks on the set.
- 3 Turn on the digital set-top box.
(Refer to the owner's manual for the digital set-top box.)
- 4 Select **COMPONENT** input source with using the **INPUT** button on the remote control.

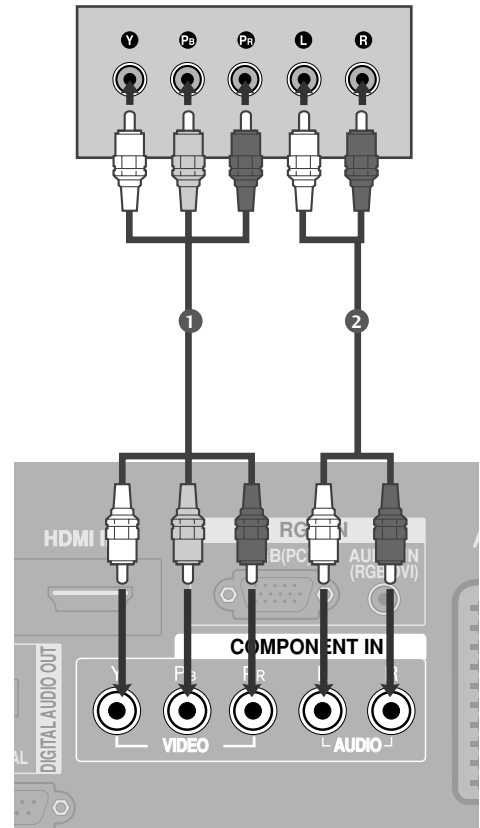

Signal	Component	HDMI1/2	HDMI3 (Only 37/42LF7*, 42LY99)
480i/576i	Yes	No	No
480p/576p	Yes	Yes	Yes
720p/1080i	Yes	Yes	Yes
1080p	Yes (60Hz only)	Yes (24Hz/50Hz/60Hz)	Yes (24Hz/50Hz/60Hz)

When connecting with a HDMI cable

Except 37/42LF7*, 42LY99

- 1 Connect the digital set-top box to **HDMI/DVI IN 1** or **HDMI IN 2** jack on the set.
- 2 Turn on the digital set-top box.
(Refer to the owner's manual for the digital set-top box.)
- 3 Select **HDMI1** or **HDMI2** input source with using the **INPUT** button on the remote control.

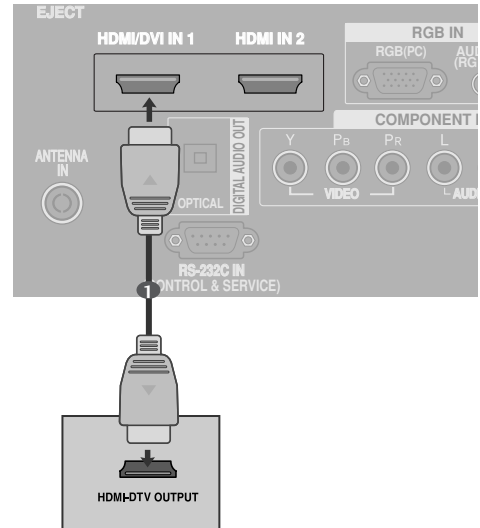

Only 37/42LF7*, 42LY99

- 1 Connect the digital set-top box to **HDMI/DVI IN 1**, **HDMI IN 2** or **HDMI IN 3** jack on the set.
- 2 Turn on the digital set-top box.
(Refer to the owner's manual for the digital set-top box.)
- 3 Select **HDMI1**, **HDMI2** or **HDMI3** input source with using the **INPUT** button on the remote control.

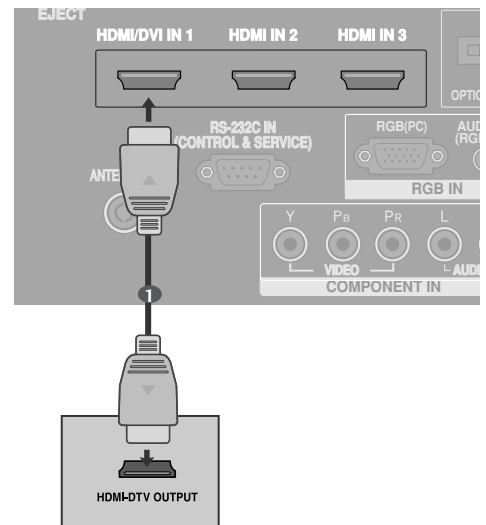

When connecting with a HDMI to DVI cable

Except 37/42LF7*, 42LY99

- 1 Connect the digital set-top box to **HDMI/DVI IN 1** jack on the set.
- 2 Connect the audio output of the digital set-top box to the **AUDIO IN (RGB/DVI)** jack on the set.
- 3 Turn on the digital set-top box. (Refer to the owner's manual for the digital set-top box.)
- 4 Select **HDMI1** input source with using the **INPUT** button on the remote control.

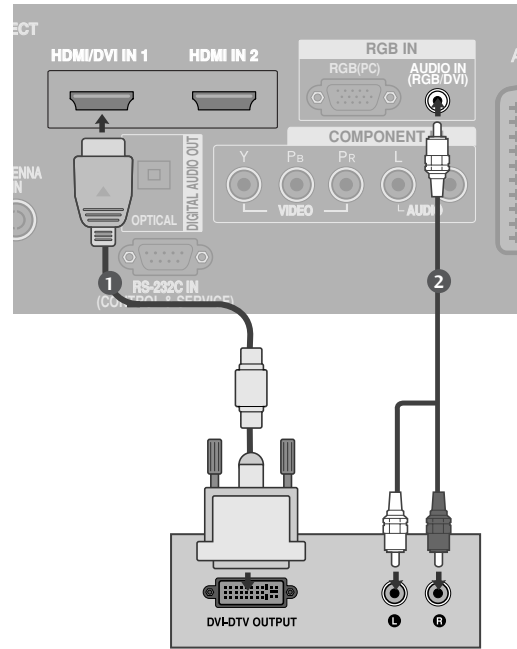

Only 37/42LF7*, 42LY99

- 1 Connect the digital set-top box to **HDMI/DVI IN 1** jack on the set.
- 2 Connect the audio output of the digital set-top box to the **AUDIO IN (RGB/DVI)** jack on the set.
- 3 Turn on the digital set-top box. (Refer to the owner's manual for the digital set-top box.)
- 4 Select **HDMI1** input source with using the **INPUT** button on the remote control.

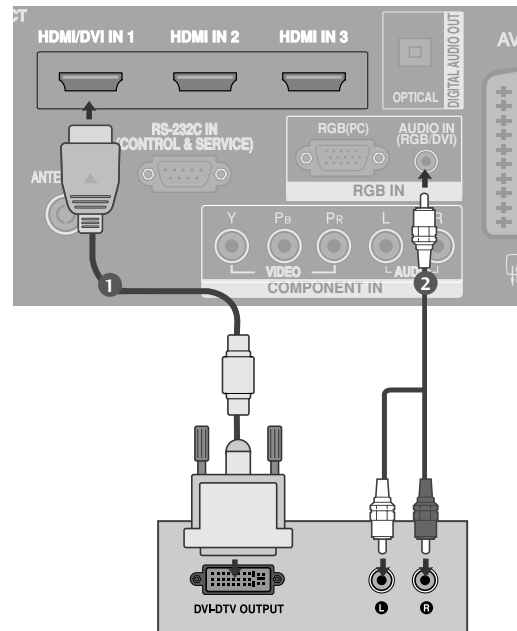

EXTERNAL EQUIPMENT SETUP

DVD SETUP

When connecting with a component cable

- 1 Connect the video outputs (Y, Pb, Pr) of the DVD to the **COMPONENT IN VIDEO** jacks on the set.
- 2 Connect the audio outputs of the DVD to the **COMPONENT IN AUDIO** jacks on the set.
- 3 Turn on the DVD player, insert a DVD.
- 4 Select **COMPONENT** input source with using the **INPUT** button on the remote control.
- 5 Refer to the DVD player's manual for operating instructions.

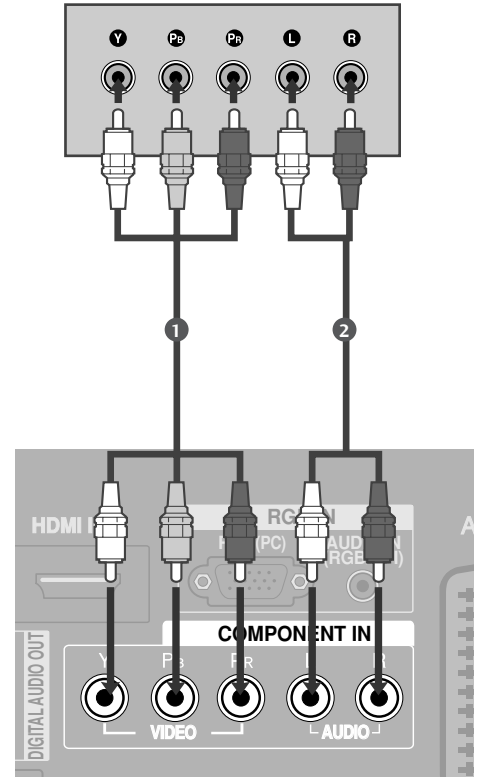

Component Input ports

To get better picture quality, connect a DVD player to the component input ports as shown below.

Component ports on the TV	Y	Pb	Pr
Video output ports on DVD player	Y	Pb	Pr
	Y	B-Y	R-Y
	Y	Cb	Cr
	Y	Pb	Pr

When connecting with a Euro Scart

- 1 Connect the Euro scart socket of the DVD to the **AV1** Euro scart socket on the set.
- 2 Turn on the DVD player, insert a DVD.
- 3 Select **AV1** input source with using the **INPUT** button on the remote control.
If connected to **AV2** Euro scart socket, select **AV2** input source.
- 4 Refer to the DVD player's manual for operating instructions.

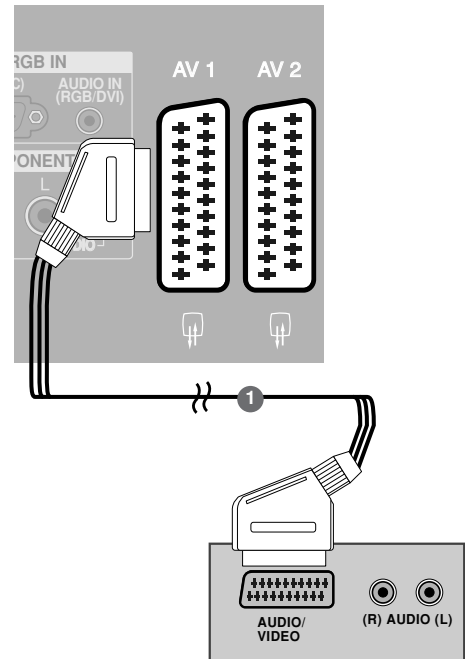

! NOTE

- ▶ If you want to use the EURO scart cable, you have to use the signal shielded Euro scart cable.

When connecting with an S-Video cable

- 1 Connect the S-VIDEO output of the DVD to the **S-VIDEO** input on the set.
- 2 Connect the audio outputs of the DVD to the **AUDIO** input jacks on the set.
- 3 Turn on the DVD player, insert a DVD.
- 4 Select **AV3** input source with using the **INPUT** button on the remote control.
- 5 Refer to the DVD player's manual for operating instructions.

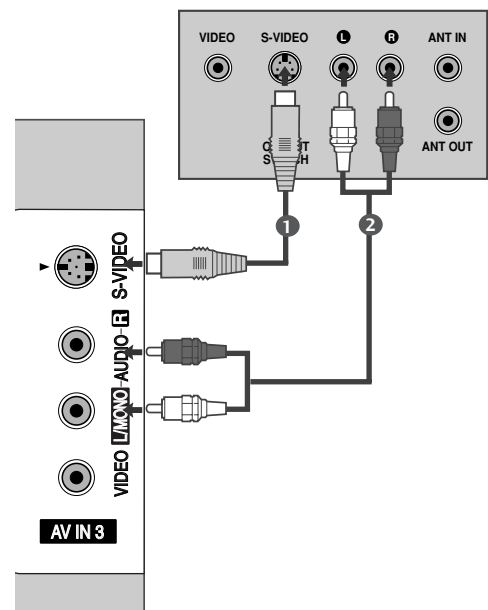

EXTERNAL EQUIPMENT SETUP

When connecting HDMI cable

Except 37/42LF7*, 42LY99

- 1 Connect the HDMI output of the DVD to the **HDMI/DVI IN 1** or **HDMI IN 2** jack on the set.
- 2 Select **HDMI1** or **HDMI2** input source with using the **INPUT** button on the remote control.
- 3 Refer to the DVD player's manual for operating instructions.

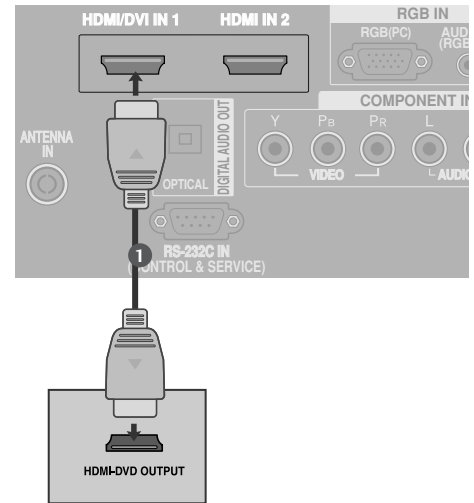

Only 37/42LF7*, 42LY99

- 1 Connect the HDMI output of the DVD to the **HDMI/DVI IN 1**, **HDMI IN 2** or **HDMI IN 3** jack on the set.
- 2 Select **HDMI1**, **HDMI2** or **HDMI3** input source with using the **INPUT** button on the remote control.
- 3 Refer to the DVD player's manual for operating instructions.

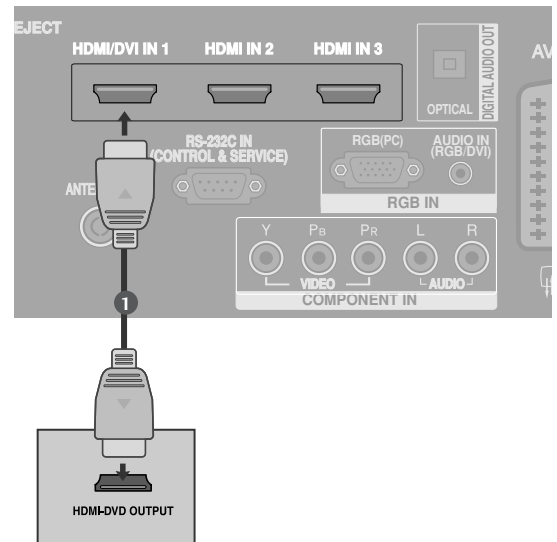

! NOTE

- ▶ TV can receive the video and audio signal simultaneously with using a HDMI cable.
- ▶ If the DVD does not support Auto HDMI, you need to set the output resolution appropriately.

INSERTION OF CI MODULE

(This feature is not available in all countries.)

- To view the scrambled (pay) services in digital TV mode.

- 1 Insert the CI Module to **PCMCIA** (Personal Computer Memory Card International Association) **CARD SLOT** of TV as shown.

For further information, see p.48.

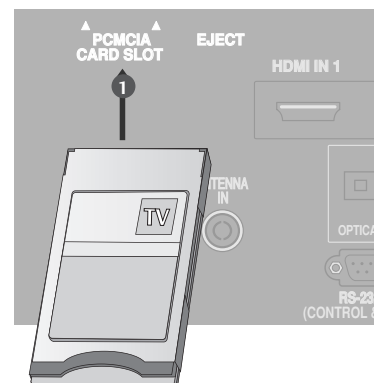

VCR SETUP

- To avoid picture noise (interference), leave an adequate distance between the VCR and TV.
- Typically a frozen still picture from a VCR. If the 4:3 picture format is used; the fixed images on the sides of the screen may remain visible on the screen.

When connecting with an antenna

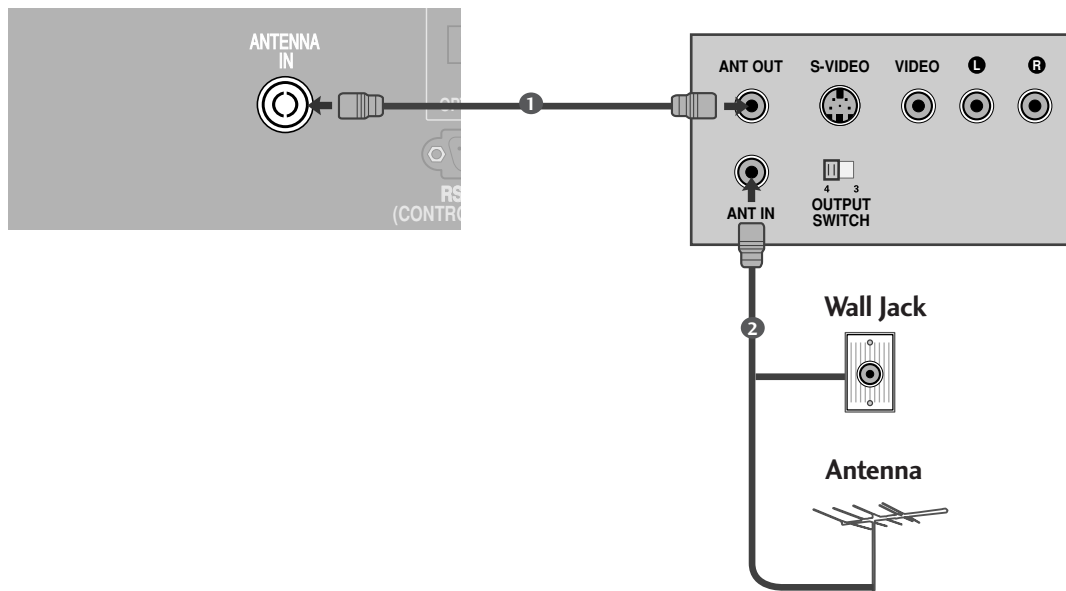

- 1 Connect the **ANT OUT** socket of the VCR to the **ANTENNA IN** socket on the set.
.....
- 2 Connect the antenna cable to the **ANT IN** socket of the VCR.
.....
- 3 Press the **PLAY** button on the VCR and match the appropriate programme between the TV and VCR for viewing.
.....

EXTERNAL EQUIPMENT SETUP

When connecting with a Euro Scart

- 1 Connect the Euro scart socket of the VCR to the **AV1** Euro scart socket on the set.
- 2 Insert a video tape into the VCR and press **PLAY** on the VCR. (Refer to the VCR owner's manual.)
- 3 Select **AV1** input source with using the **INPUT** button on the remote control.
- 4 If connected to **AV2** Euro scart socket, select **AV2** input source.

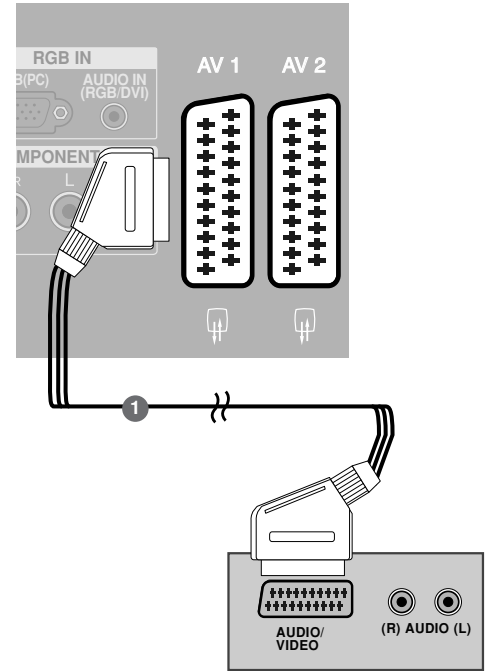

! NOTE

- ▶ If you want to use the EURO scart cable, you have to use the signal shielded Euro scart cable.

When connecting with a RCA cable

- 1 Connect the **AUDIO/VIDEO** jacks between TV and VCR. Match the jack colors (Video = yellow, Audio Left = white, and Audio Right = red)
- 2 Insert a video tape into the VCR and press **PLAY** on the VCR. (Refer to the VCR owner's manual.)
- 3 Select **AV3** input source using the **INPUT** button on the remote control.

! NOTE

- ▶ If you have a mono VCR, connect the audio cable from the VCR to the **AUDIO L/MONO** jack of the set.

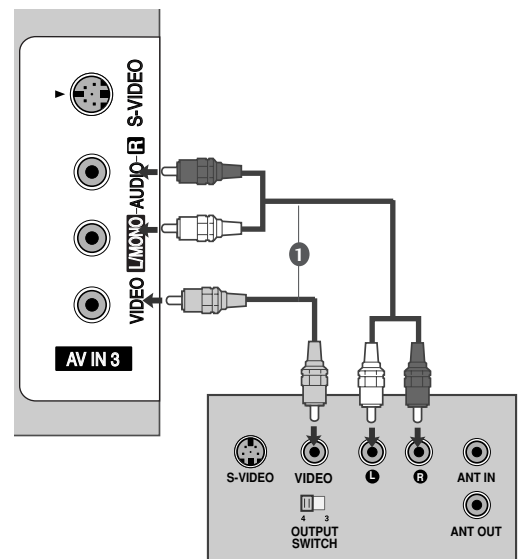

When connecting with an S-Video cable

- 1 Connect the S-VIDEO output of the VCR to the **S-VIDEO** input on the set. The picture quality is improved; compared to normal composite (RCA cable) input.
- 2 Connect the audio outputs of the VCR to the **AUDIO** input jacks on the set.
- 3 Insert a video tape into the VCR and press PLAY on the VCR. (Refer to the VCR owner's manual.)
- 4 Select **AV3** input source with using the **INPUT** button on the remote control.

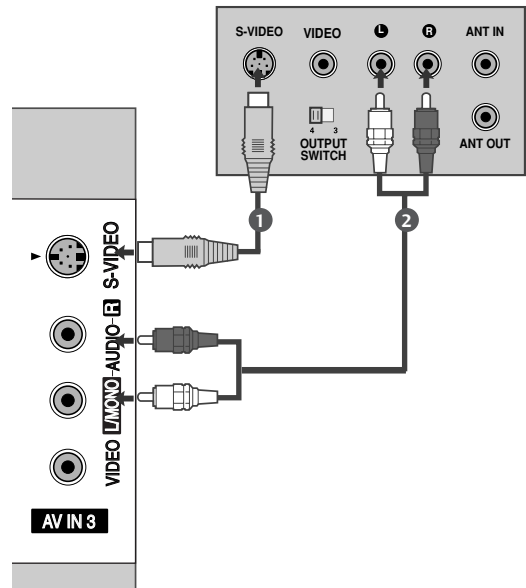

! NOTE

- ▶ If both S-VIDEO and VIDEO sockets have been connected to the S-VHS VCR simultaneously, only the S-VIDEO can be received.

DIGITAL AUDIO OUT SETUP

Send the TV's audio to external audio equipment via the Digital Audio Output (Optical) port.

- 1 Connect one end of an optical cable to the TV Digital Audio (Optical) Output port.
- 2 Connect the other end of the optical cable to the digital audio (optical) input on the audio equipment.
- 3 Set the "TV Speaker option - Off" in the AUDIO menu. (▶p.78). See the external audio equipment instruction manual for operation.

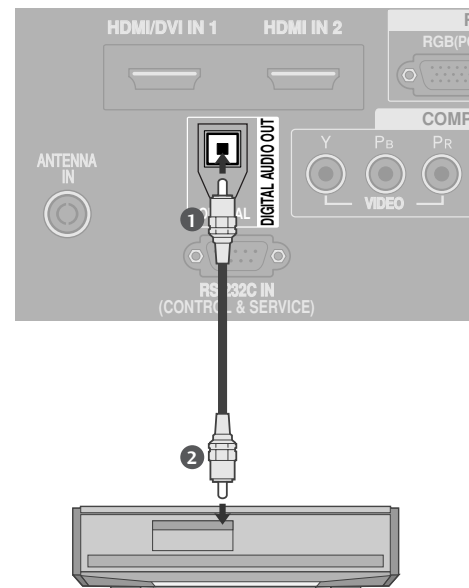

! CAUTION

- ▶ Do not look into the optical output port. Looking at the laser beam may damage your vision.

EXTERNAL EQUIPMENT SETUP

OTHER A/V SOURCE SETUP

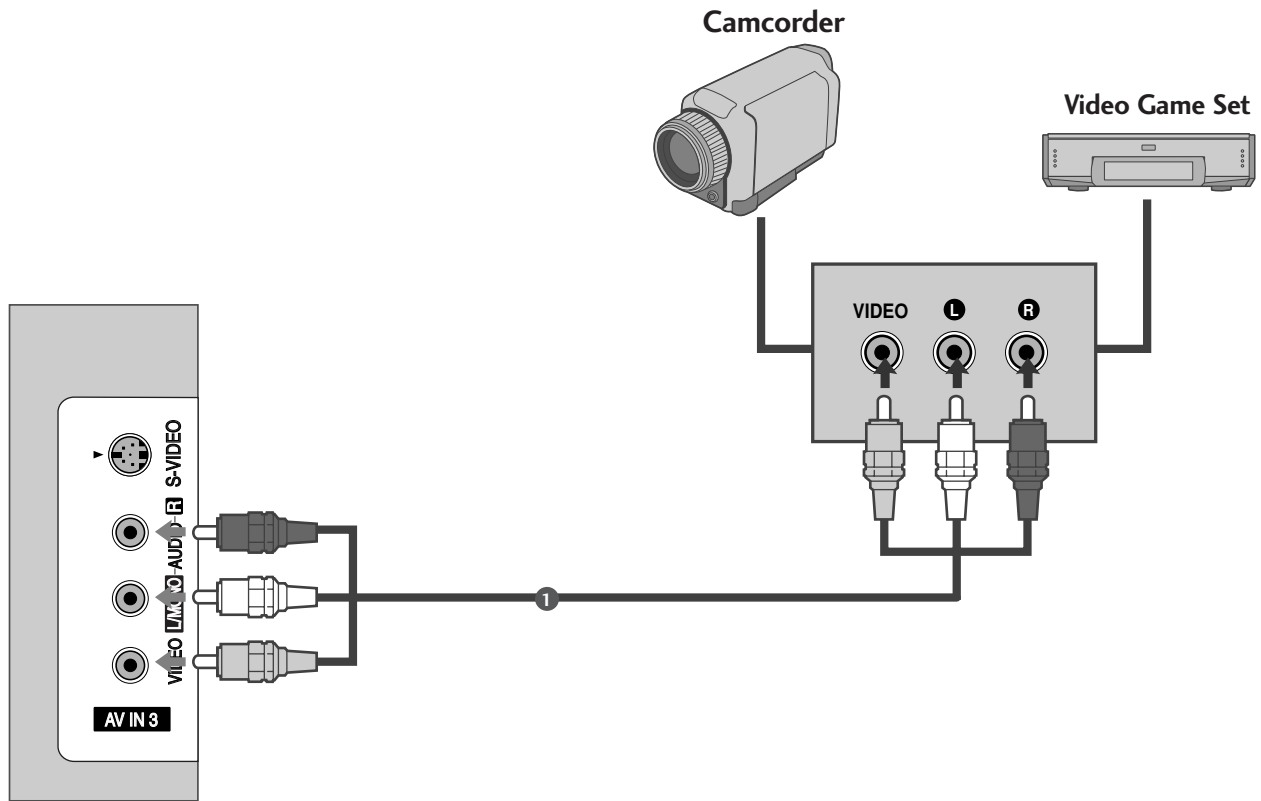

- 1 Connect the **AUDIO/VIDEO** jacks between TV and external equipment. Match the jack colors. (Video = yellow, Audio Left = white, and Audio Right = red)
- 2 Select **AV3** input source with using the **INPUT** button on the remote control.
- 3 Operate the corresponding external equipment. Refer to external equipment operating guide.

PC SETUP

This TV provides Plug and Play capability, meaning that the PC adjusts automatically to the TV's settings.

When connecting with a D-sub 15 pin cable

- 1 Connect the RGB output of the PC to the **RGB (PC)** jack on the set.
- 2 Connect the PC audio output to the **AUDIO IN (RGB/DVI)** jack on the set.
- 3 Turn on the PC and the set.
- 4 Select **RGB** input source with using the **INPUT** button on the remote control.

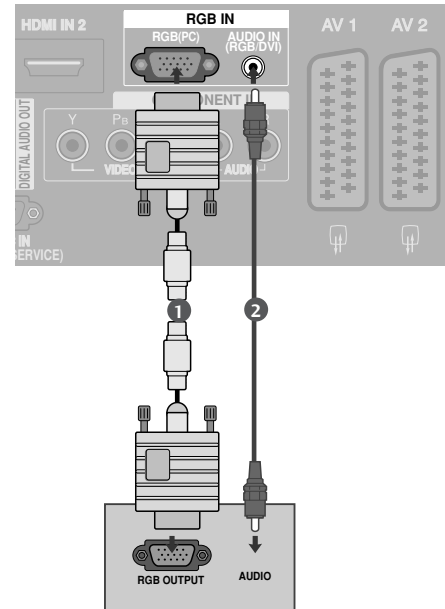

When connecting with a HDMI to DVI cable

- 1 Connect the DVI output of the PC to the **HDMI/DVI IN 1** jack on the set.
- 2 Connect the PC audio output to the **AUDIO IN (RGB/DVI)** jack on the set.
- 3 Turn on the PC and the set
- 4 Select **HDMI1** input source with using the **INPUT** button on the remote control.

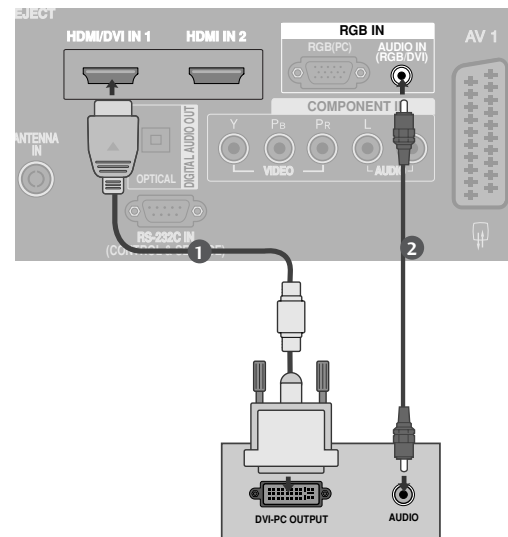

! NOTE

- ▶ If the PC has a DVI output and no HDMI output, a separated audio connection is necessary.
- ▶ If the PC does not support Auto DVI, you need to set the output resolution appropriately.

EXTERNAL EQUIPMENT SETUP

! NOTE

- ▶ To enjoy vivid picture and sound, connect a PC to the set.
- ▶ Avoid keeping a fixed image on the set's screen for a long period of time. The fixed image may become permanently imprinted on the screen; use a screen saver when possible.
- ▶ Connect PC to the RGB (PC) or HDMI IN (or HDMI/DVI IN) port of the set; change the resolution output of PC accordingly.
- ▶ There might be noise according to some resolution, vertical pattern, contrast or brightness in PC mode. Change the PC mode into another resolution or change the refresh rate into another rate or adjust the brightness and contrast on the menu until the picture is clean. If the refresh rate of the PC graphic card can not be changed, change the PC graphic card or consult it to the manufacturer of the PC graphic card.
- ▶ The synchronization input waveform for Horizontal and Vertical frequencies are separate.
- ▶ We recommend using 1920x1080 (Reduced Blanking Timing), 60Hz for the PC mode, they provide the best picture quality.
- ▶ In Plasma TV models, we recommend using 1024x768, 60Hz for the PC mode, they provide the best picture quality.
- ▶ Connect the signal cable from the monitor output port of the PC to the RGB (PC) port of the set or the signal cable from the HDMI output port of the PC to the HDMI IN (or HDMI/DVI IN) port on the set.
- ▶ Connect the audio cable from the PC to the Audio input on the set. (Audio cables are not included with the set).
- ▶ If using a sound card, adjust PC sound as required.
- ▶ This set uses a VESA Plug and Play Solution. The set provides EDID data to the PC system with a DDC protocol. The PC adjusts automatically when using this set.
- ▶ DDC protocol is preset for RGB (Analog RGB), HDMI (Digital RGB) mode.
- ▶ If required, adjust the settings for Plug and Play functionally.
- ▶ If graphic card on the PC does not output analog and digital RGB simultaneously, connect only one of either RGB or HDMI IN (or HDMI/DVI IN) to display the PC on the set.
- ▶ If graphic card on the PC does output analog and digital RGB simultaneously, set the set to either RGB or HDMI; (the other mode is set to Plug and Play automatically by the set.)
- ▶ DOS mode may not work depending on video card if you use a HDMI to DVI cable.
- ▶ When you use too long RGB-PC cable, there might be a noise on the screen. We recommend using under 5m of the cable. It provides the best picture quality.

Supported Display Resolution

RGB[PC] / HDMI[PC] mode			HDMI[DTV] mode		
Resolution	Horizontal Frequency(KHz)	Vertical Frequency(Hz)	Resolution	Horizontal Frequency(KHz)	Vertical Frequency(Hz)
720x400	31.468	70.08	640x480	31.469	59.94
640x480	31.469	59.94		31.469	60.00
	800x600	37.500	75.00	720x480	31.47
37.879		60.31	31.50		60.00
832x624	46.875	75.00	720x576	31.25	50.00
	49.725	74.55		37.50	50.00
1024x768	48.363	60.00	1280x720	44.96	59.94
	56.476	70.00		45.00	60.00
1280x768	60.023	75.03	1920x1080i	33.72	59.94
	47.693	59.99		33.75	60.00
1360x768	47.649	59.94	1920x1080p	28.125	50.00
1366x768	47.649	59.94		27.00	24.00
1280x1024	63.595	60.00	56.25	50.00	
1400x1050	65.160	60.00		67.433	59.94
1600x1200	74.077	60.00	67.500	60.00	
1920x1080	66.647	59.99			

 : HDMI[PC] mode only

! NOTE

- ▶ Reduced Blanking Timing is applied with 1600x1200, 1920x1080 in RGB[PC] / HDMI[PC] mode.
- ▶ 60PF9* isn't supported to 800x600, 75.00Hz in RGB[PC] mode.

EXTERNAL EQUIPMENT SETUP

Screen Setup for PC mode

Auto Configure (RGB [PC] mode only)

Automatically adjusts picture position and minimizes image shaking. After adjustment, if the image is still not correct, your set is functioning properly but needs further adjustment.

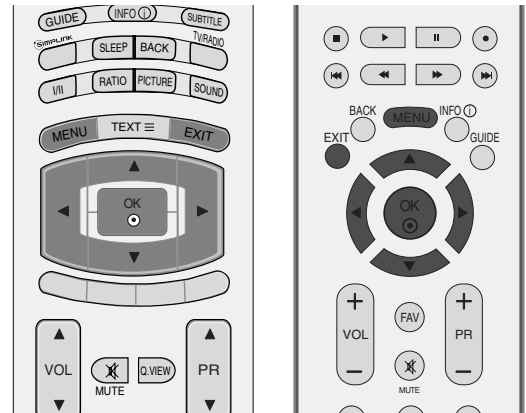

Auto configure

This function is for the automatic adjustment of the screen position, clock, and phase. The displayed image will unstable for a few seconds while the auto configuration is in progress.

- 1 Press the **MENU** button and then use ▲ or ▼ button to select the **SCREEN** menu.
- 2 Press the ► button and then use ▲ or ▼ button to select **Auto Config.**
- 3 Press the ► button to start **Auto Config.**
 - When **Auto Config.** has finished, **OK** will be shown on screen.
 - If the position of the image is still not correct, try Auto adjustment again.
 - If picture needs to be adjusted more after Auto adjustment in RGB (PC), you can adjust the **Manual Config.**
- 4 Press the **EXIT** button to return to normal TV viewing.

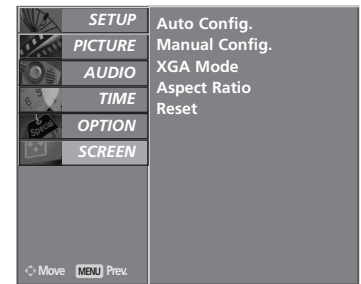

Adjustment for screen Phase, Clock, Position

If the picture isn't clear after auto adjustment and especially if characters are still trembling, adjust the picture phase manually.

It's not available to use this function in 1:1 Pixel mode.

To correct the screen size, adjust **Clock**.

This function works in the following mode : RGB[PC].

Clock This function is to minimize any vertical bars or stripes visible on the screen background. And the horizontal screen size will also change.

Phase This function allows you to remove any horizontal noise and clear or sharpen the image of characters.

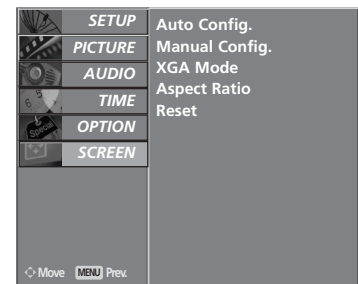
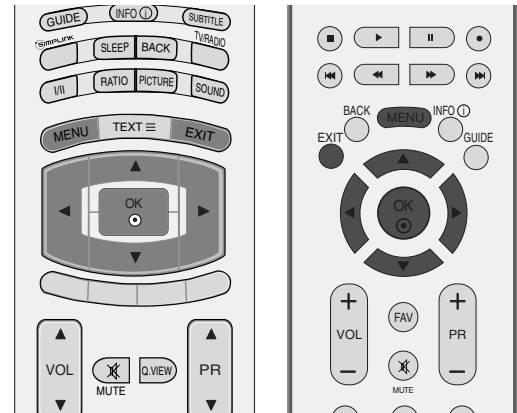

- 1 Press the **MENU** button and then use **▲** or **▼** button to select the **SCREEN** menu.
- 2 Press the **▶** button and then **▲** or **▼** button to select **Manual Config.**.
- 3 Press the **▶** button and then **▲** or **▼** button to select **Phase, Clock, H-Position** or **V-Position**.
- 4 Press the **◀** or **▶** button to make appropriate adjustments.
- 5 Press the **EXIT** button to return to normal TV viewing.

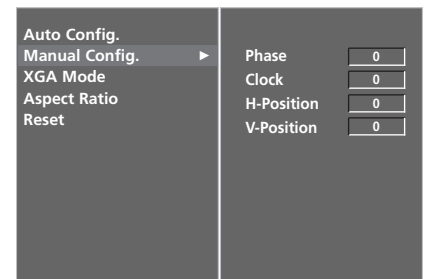

2 3 4

EXTERNAL EQUIPMENT SETUP

Selecting Wide XGA mode

To see a normal picture, match the resolution of RGB mode and selection of XGA mode.

This function works in the following mode: RGB[PC] mode

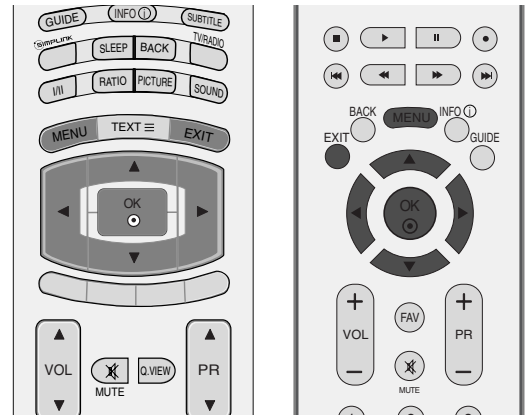

- 1 Press the **MENU** button and then use **▲** or **▼** button to select the **SCREEN** menu.
- 2 Press the **▶** button and then use **▲** or **▼** button to select **XGA Mode**.
- 3 Press the **▶** button and then use **▲** or **▼** button to select the desired XGA resolution.
- 4 Press the **EXIT** button to return to normal TV viewing.

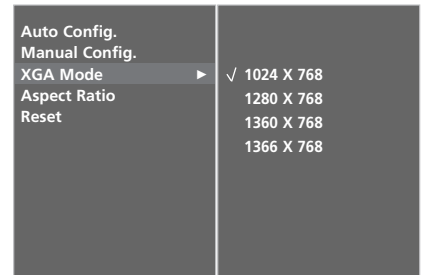
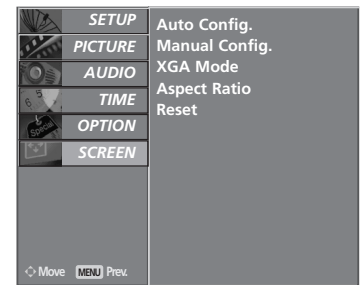

Initializing (Reset to original factory settings)

This function operates in current mode.
To initialize the adjusted value

It's not available to use **ISM Method** and **Low power** in **LCD TV** models.

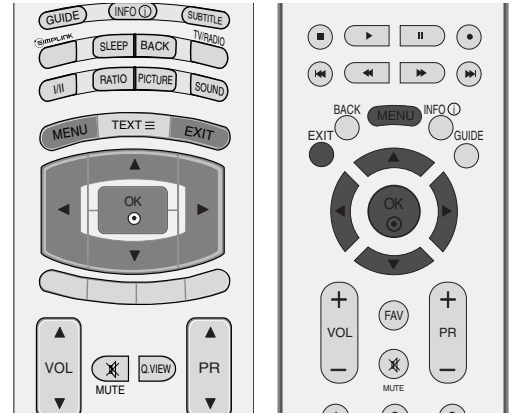

- 1 Press the **MENU** button and then **▲** or **▼** button to select the **OPTION** menu.
- 2 Press the **▶** button and then **▲** or **▼** button to select **Factory Mode**.
- 3 Press the **▶** button and then **▲** or **▼** button to select **Factory Reset**.
- 4 Press the **OK** button.

The message **“If you enter a password, all user setting will be reset”** will appear.

- 5 Use **NUMBER** buttons to input a 4-digit password.

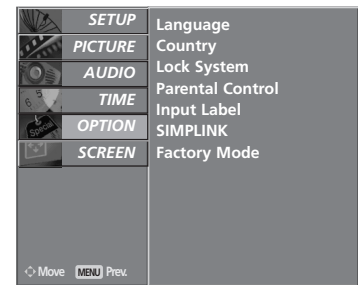

1

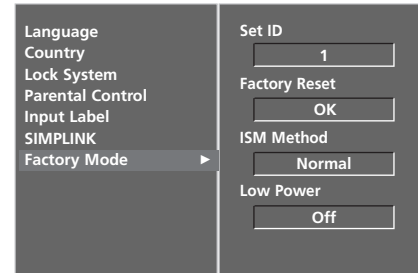

2

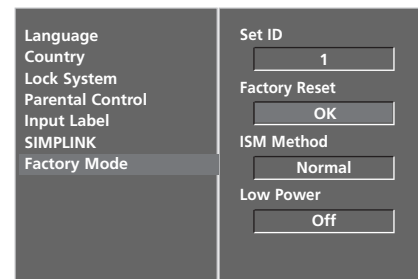

3 4

WATCHING TV /PROGRAMME CONTROL

REMOTE CONTROL KEY FUNCTIONS

(Only 37/42/47/52LY9*, 50/60PF9*)

When using the remote control, aim it at the remote control sensor on the TV.

WATCHING TV / PROGRAMME CONTROL



D/A Selects digital or analogue mode.
Switches the set on from standby.

POWER Switches the set on from standby or off to standby.

INPUT External input mode rotate in regular sequence.

MODE Selects the remote operating modes.

GUIDE Shows programme schedule.

INFO ⓘ Shows the present screen information.

SUBTITLE Recalls your preferred subtitle in digital mode.

THUMBSTICK (Up/Down/Left/Right) Allows you to navigate the on-screen menus and adjust the system settings to your preference.

OK Accepts your selection or displays the current mode.

Coloured buttons These buttons are used for teletext (only **TELETEXT** models) or **Programme edit**.

VOLUME UP /DOWN Adjusts the volume.

MUTE Switches the sound on or off.

Q.VIEW Returns to the previously viewed programme.

Programme UP/DOWN Selects a programme.

0~9 number button Selects a programme.
Selects numbered items in a menu.

LIST Displays the programme table.

FAV Displays the selected favourite programme.

VCR/DVD control buttons Controls some video cassette recorders or DVD players when you have already selected DVD or VCR mode button. Control connected AV devices by pressing the ▲ or ▼ or ◀ or ▶, OK buttons and buttons for play, stop, pause, fast reverse, fast forward, chapter skip. (The ⏪ button does not provide such functions.)

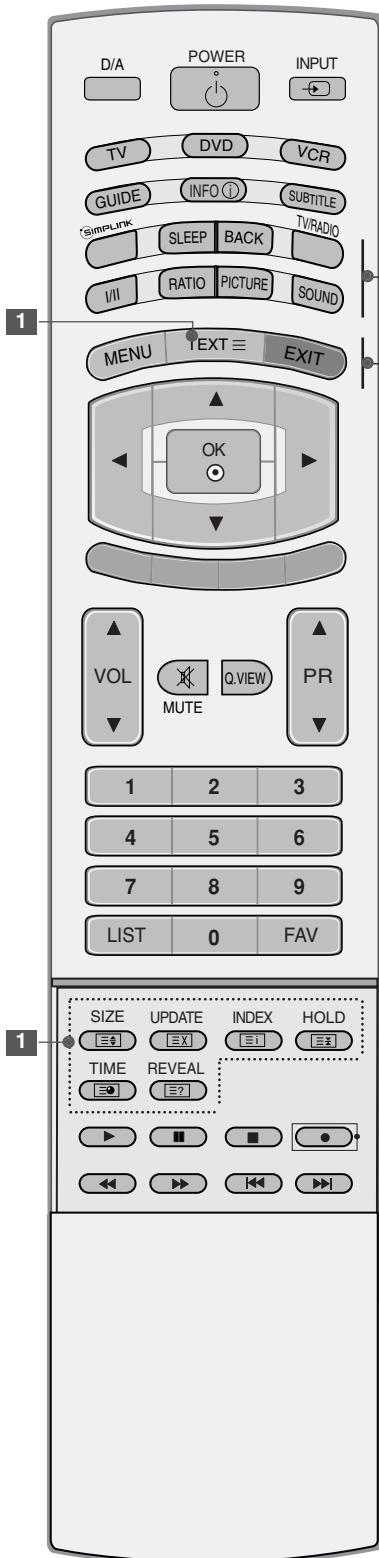

SIMPLINK See a list of AV devices connected to TV.
When you toggle this button, the Simplink menu appears at the screen.

SLEEP Sets the sleep timer.

BACK Allow the user to move back one step in an interactive application, EPG or other user interaction function.

TV/RADIO Selects Radio or TV channel in digital mode.

I/II Selects the sound output.

RATIO Selects your desired picture format.

PICTURE Adjusts the factory preset picture according to the room.

SOUND To select the sound appropriate to your viewing programme.

MENU Selects a menu.

1 TELETEXT BUTTONS These buttons are used for teletext.
For further details, see the 'Teletext' section.

EXIT Clears all on-screen displays and returns to TV viewing from any menu.

Installing Batteries

- Open the battery compartment cover on the back side and install the batteries matching correct polarity (+with +,-with -).
- Install two 1.5V AA batteries. Don't mix old or used batteries with new ones.
- Close cover.

WATCHING TV /PROGRAMME CONTROL

REMOTE CONTROL KEY FUNCTIONS (Only 37/42/47/52LF6*, 37/42LF7*)

When using the remote control, aim it at the remote control sensor on the TV.



POWER Switches the set on from standby or off to standby.

D/A INPUT Selects digital or analogue mode.
Switches the set on from standby.

TV/RADIO Selects Radio or TV channel in digital mode.

INPUT External input mode rotate in regular sequence.
Switches the set on from standby.

Brightness adjustment Adjusts screen brightness.
It returns to the default settings brightness by changing mode source.

Coloured buttons These buttons are used for teletext (only **TELETEXT** models) or **Programme edit**.

EXIT Clears all on-screen displays and returns to TV viewing from any menu.

BACK Allow the user to move back one step in an interactive application, EPG or other user interaction function.

MENU Selects a menu.

INFO Shows the present screen information.

GUIDE Shows programme schedule.

VOLUME UP /DOWN Adjusts the volume.

FAV Displays the selected favourite programme.

MUTE Switches the sound on or off.

Programme UP/DOWN Selects a programme.

0~9 number button Selects a programme.
Selects numbered items in a menu.

LIST Displays the programme table.

Q.VIEW Returns to the previously viewed programme.

1 INPUT D/A POWER MODE TV

TV/RADIO BRIGHT - + DVD VCR

INPUT SIMPLINK TEXT RATIO I/II

BACK MENU INFO

EXIT GUIDE

OK

VOL + - FAV PR

MUTE

1 2 3

4 5 6

7 8 9

LIST 0 Q.VIEW

1 UPDATE INDEX TIME

SLEEP HOLD REVEAL

SUBTITLE

MODE Selects the remote operating modes.

SIMPLINK See a list of AV devices connected to TV. When you toggle this button, the Simplink menu appears at the screen.

1 TELETEXT BUTTONS These buttons are used for teletext. For further details, see the 'Teletext' section.

RATIO Selects your desired picture format.

I/II Selects the sound output.

VCR/DVD control buttons Controls some video cassette recorders or DVD players when you have already selected DVD or VCR mode button. Control connected AV devices by pressing the ▲ or ▼ or ◀ or ▶, OK buttons and buttons for play, stop, pause, fast reverse, fast forward, chapter skip. (The ● button does not provide such functions.)

THUMBSTICK (Up/Down/Left Right) Allows you to navigate the on-screen menus and adjust the system settings to your preference.

OK Accepts your selection or displays the current mode.

SLEEP Sets the sleep timer.

SUBTITLE Recalls your preferred subtitle in digital mode.

Installing Batteries

Open the battery compartment cover on the back side and install the batteries matching correct polarity (+with +,-with -).

Install two 1.5V AA batteries. Don't mix old or used batteries with new ones.

Close cover.

WATCHING TV /PROGRAMME CONTROL

TURNING ON THE TV

- If your TV will be turned on, you will be able to use its features.

- 1 First, connect power cord correctly.
At this moment, the TV switches to standby mode.
- 2 In standby mode to turn TV on, press the ϕ / I, INPUT or PR \blacktriangle or \blacktriangledown button on the TV or press the POWER, INPUT, D/A, PR \blacktriangle or \blacktriangledown (or PR + or -) or NUMBER button on the remote control and then the TV will switch on.
(This feature is not available for all models.)

Initializing setup

If the OSD (On Screen Display) is displayed on the screen as figure after turning on the set, you can adjust the Language, Country, Time Zone, Auto programme tuning.

Note:

- a. It will automatically disappear after approx. 40 seconds unless a button is pressed.
- b. Press the **BACK** button to change current OSD into previous OSD.

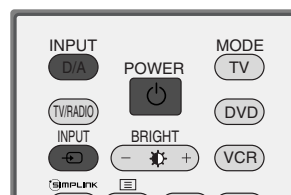
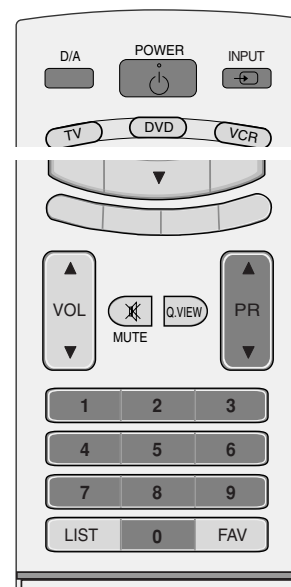

PROGRAMME SELECTION

- 1 Press the **PR ▲** or **▼** (or **PR +** or **-**) or **NUMBER** buttons to select a programme number.

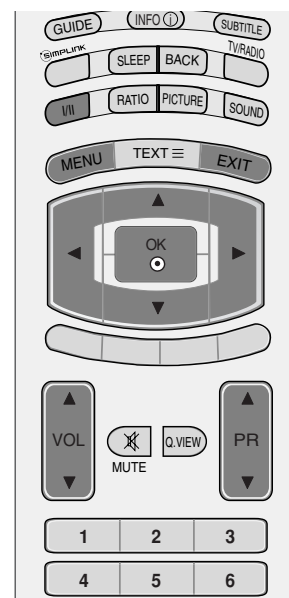

VOLUME ADJUSTMENT

- 1 Press the **VOL ▲** or **▼** (or **VOL +** or **-**) button to adjust the volume.

If you want to switch the sound off, press the **MUTE** button.

You can cancel this function by pressing the **MUTE**, **VOL ▲** or **▼** (or **VOL +** or **-**), or **I/II** button.

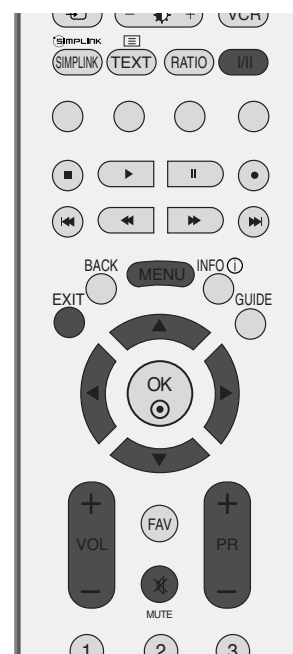

WATCHING TV /PROGRAMME CONTROL

ON SCREEN MENUS SELECTION AND ADJUSTMENT

Your TV's OSD (On Screen Display) may differ slightly from what is shown in this manual.

- 1 Press the **MENU** button and then ▲ or ▼ button to display each menu.
- 2 Press the ► button and then ▲ or ▼ button to select a menu item.
- 3 Change the setting of an item in the sub or pull-down menu with ◀ or ▶ button.
You can move to the higher level menu by pressing the **OK** or **MENU** button.

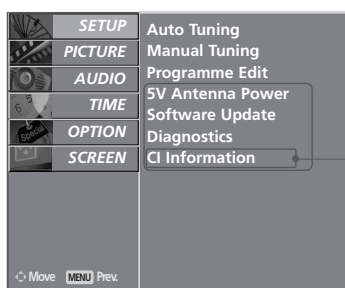

*: This feature is not available in all countries. ➤

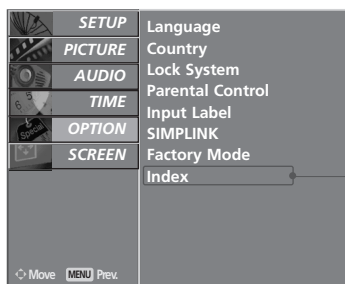
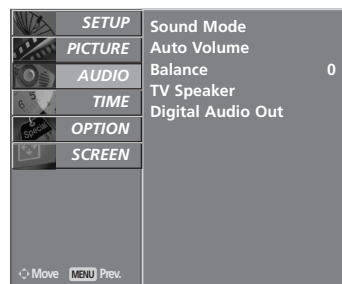
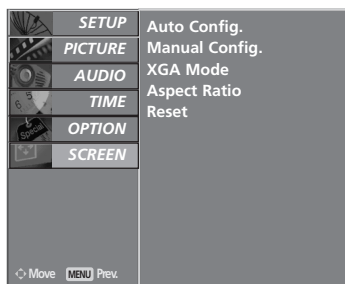
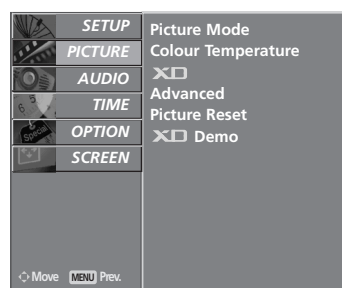

*: This feature is not available for all models. ◀

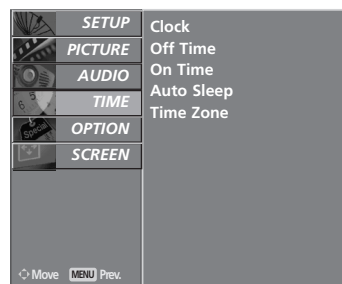

! NOTE

- ▶ It's not available to use **ISM Method** and **Low power** in LCD TV models.
- ▶ In Analogue mode, **5V Antenna Power**, **CI Information**, **Software Update** and **Diagnostics** will not display.

AUTO PROGRAMME TUNING (IN DIGITAL MODE)

Use it to automatically find and store all of the programmes.

When you start auto programming in digital mode, all the stored service information will be deleted.

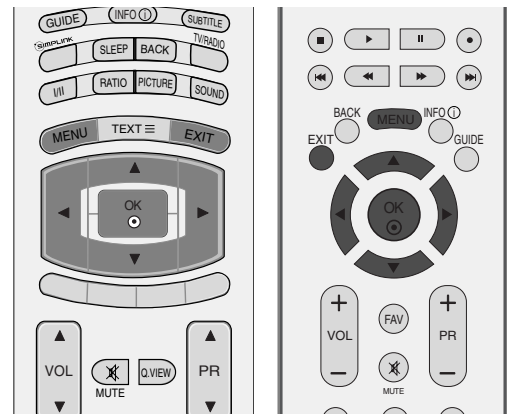

1 Press the **MENU** button and then ▲ or ▼ button to select the **SETUP** menu.

2 Press the ► button and then ▲ or ▼ button to select **Auto Tuning**.

3 Press the ► button to begin auto tuning. Use NUMBER buttons to input a 4-digit password in **Lock System 'On'**.

The message “**All service-information will be updated. Continue?**” will appear.

If you want to keep on auto tuning select **YES** with using the ◀ or ▶ button. Then, press the **OK** button. Otherwise select **NO**.

To stop auto tuning, press the **MENU** button.

4 Press the **EXIT** button to return to normal TV viewing.

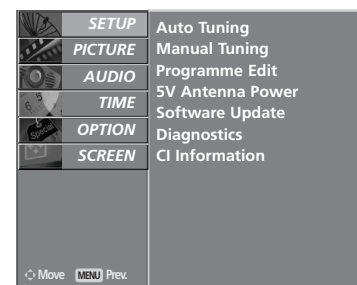

1

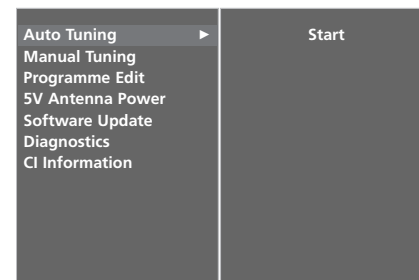

2

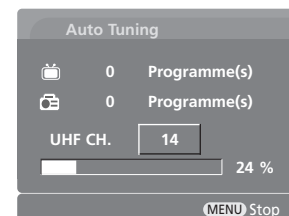

3

WATCHING TV /PROGRAMME CONTROL

MANUAL PROGRAMME TUNING (IN DIGITAL MODE)

Manual Tuning lets you manually add a programme to your programme list.

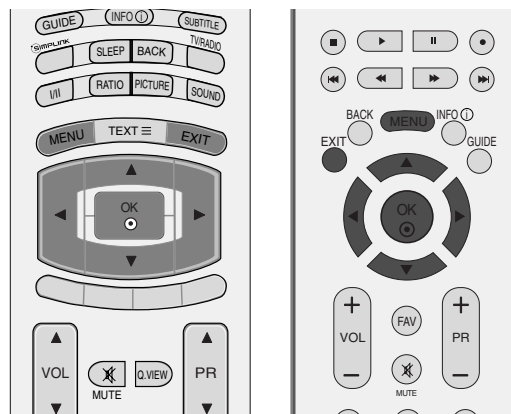

- 1 Press the **MENU** button and then **▲** or **▼** button to select the **SETUP** menu.
- 2 Press the **▶** button and then **▲** or **▼** button to select **Manual Tuning**.
- 3 Press the **▶** button and then **▲** or **▼** button or **NUMBER** buttons to select the desired channel number. Use **NUMBER** buttons to input a 4-digit password in **Lock System 'On'**.
- 4 Press the **OK** button to save.

When the channel number you want to add is already added in programme list, the message “**Setup information for the channel will be updated. Continue?**” will appear.

If you want to keep on manual tuning, select **YES** with using the **◀** or **▶** button.

Then, press the **OK** button. Otherwise select **NO**.

- 5 Press the **EXIT** button to return to normal TV viewing.

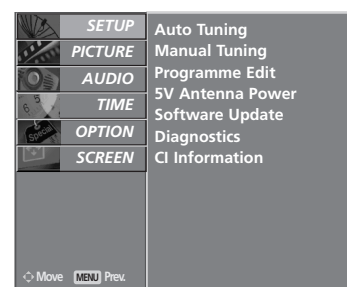

1

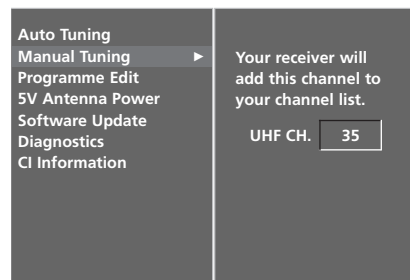

2

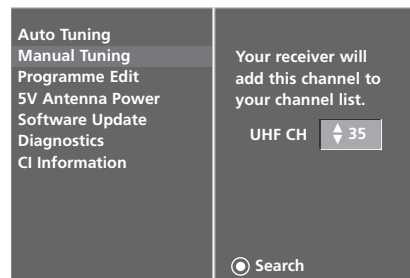

3 4

PROGRAMME EDIT (IN DIGITAL MODE)

When a programme number is skipped, it means that you will be unable to select it using PR ▲ or ▼ (or PR + or -) button during TV viewing.

If you want to select the skipped programme, directly enter the programme number with the **NUMBER** buttons or select it in the Programme edit menu.

This function enables you to skip the stored programmes.

It's available in some countries only to move a programme number by **YELLOW** button.

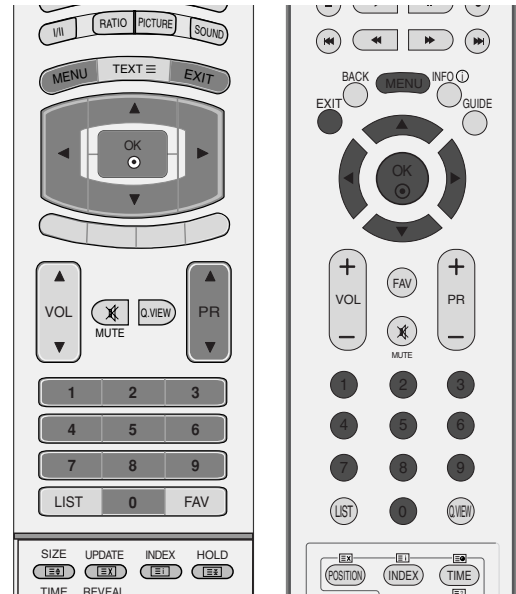

- 1 Press the **MENU** button and then ▲ or ▼ button to select the **SETUP** menu.
- 2 Press the ► button and then ▲ or ▼ button to select **Programme Edit** menu.
- 3 Press the ► button to enter the **Programme Edit** menu.
Use **NUMBER** buttons to input a 4-digit password in **Lock System 'On'**.
- 4 Select a programme to be stored or skipped with the ▲ or ▼ or ◀ or ▶ button.
- 5 Press the **BLUE** button repeatedly to have the programme skipped or stored.

In case of programmes to be skipped, skipped programme shows in blue colour and these programmes will not be selected by the PR ▲ or ▼ (or PR + or -) buttons during TV viewing.

- 6 Press the **EXIT** button to return to normal TV viewing.

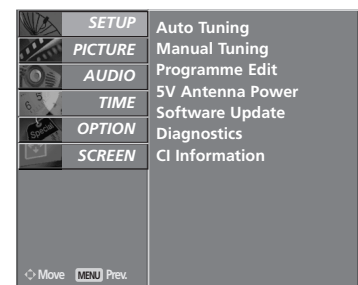

1

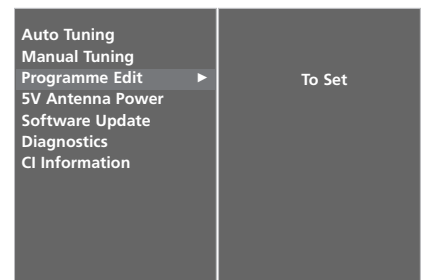

2 3

WATCHING TV /PROGRAMME CONTROL

Mini Glossary

 Displayed when the DTV Programme.	 Displayed when the Teletext Programme.
 Displayed when the Locked Programme.	 Displayed when the Subtitle Programme.
 Displayed when the Radio Programme.	 Displayed when the Scramble Programme.
 Displayed when the MHEG Programme.	 Displayed when the Dolby Programme.

■ Skipping a programme number

1 Select a programme number to be skipped with the ▲ or ▼ or ◀ or ▶ button.

2 Press the **BLUE** button. The skipped programme number turns to blue.

3 Press the **BLUE** button again to release the skipped programme.

When a programme number is skipped it means that you will be unable to select it using the **PR ▲** or **▼** (or **PR +** or **-**) button during normal TV viewing.

If you want to select the skipped programme, directly enter the programme number with the **NUMBER** buttons or select it in the programme edit or EPG.

4 Press the **EXIT** button to return to TV viewing.

■ Locking a programme (In Lock System On mode only)

1 Select a programme to be locked with the ▲ or ▼ or ◀ or ▶ button.

2 Press the **GREEN** button. The lock mark will appear in front of that programme number.

3 Press the **GREEN** button again to release this function.

Note :

- ▶ To watch a locked programme, input a 4-digit password in Lock system. Be sure to remember this number!
- ▶ If you forgot your password, press '7', '7', '7', '7' on the remote control handset.
- ▶ If you select other programme after releasing a locked programme and then return to the locked programme within 1 minute, you needn't input a password to select the locked programme.

■ Selecting favourite programme

1 Select your favourite programme number by pressing ▲ or ▼ or ◀ or ▶ button and then press the **FAV** button on your remote control handset.

It will automatically include the selected programme into your favourite programme list.

5V ANTENNA POWER (IN DIGITAL MODE ONLY)

Even if there isn't a special 5V adapter power in the external antenna, this function can output 5V in the set.

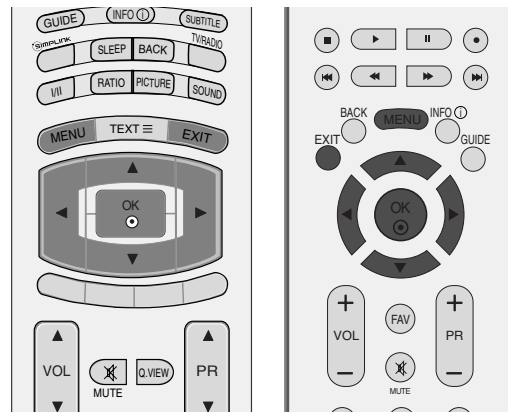

1 Press the **MENU** button and then **▲** or **▼** button to select the **SETUP** menu.

2 Press the **▶** button and then use **▲** or **▼** button to select **5V Antenna Power**.

3 Press the **▶** button and then use **▲** or **▼** button to select **On** or **Off**.

In **5V Antenna Power On**, if the set is short-circuited, it will automatically return to **Off**.

The message "**Antenna feed overloaded. Automatically switched off.**" will appear.

4 Press the **EXIT** button to return to normal TV viewing.

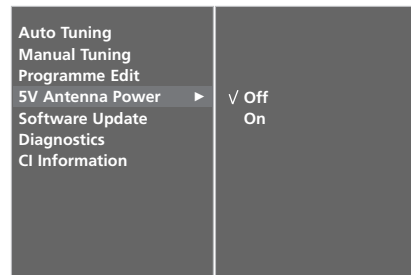
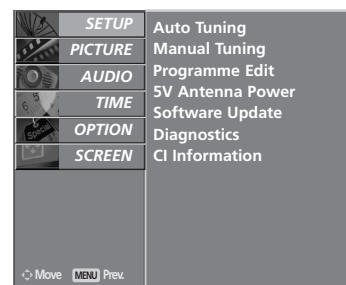

WATCHING TV /PROGRAMME CONTROL

SOFTWARE UPDATE (IN DIGITAL MODE ONLY)

Software Update, means software can be downloaded through the digital terrestrial broadcasting system.

- 1 Press the **MENU** button and then **▲** or **▼** button to select the **SETUP** menu.
- 2 Press the **▶** button and then **▲** or **▼** button to select **Software update**.
- 3 Press the **▶** button and then **▲** or **▼** button to select **Off** or **On**.
 - If you select **On**, a user confirm message box will be displayed to notify that new software is found.
- 4 Press the **EXIT** button to return to normal TV viewing.

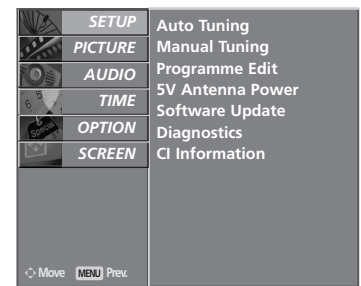
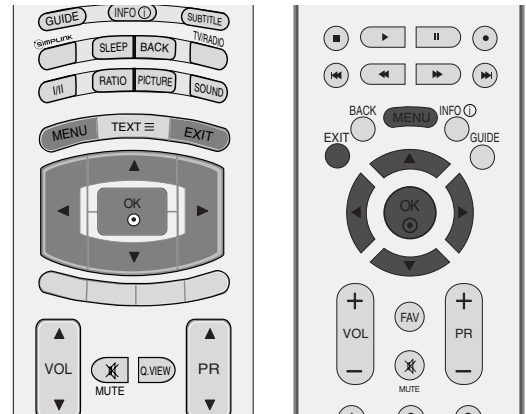

1

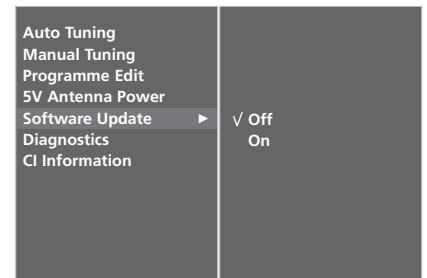

2 3

* When setting “Software Update”



Occasionally, a transmission of updated digital software information will result in the following menu on the TV screen.



Select the **YES** using the **◀** or **▶** button and when you see the following picture.



After Software Update is completed, the System takes about one minute to restart.

- During Progress of Software Update, please note the following:

- The power of the set must not be interrupted.
- The set must not be switched off.
- The antenna must not be disconnected.
- During this time, you should not switch off the power to the set.
- At this time, you should not work power On/Off.
- After Software Update, you can confirm the updated software version in Diagnostics menu.

DIAGNOSTICS (IN DIGITAL MODE ONLY)

This function enables you to watch Manufacturer, Model/Type, Serial Number and Software Version.

It's displayed the information and signal strength of the turned MUX.

It's displayed the signal information and service name of the selected MUX.

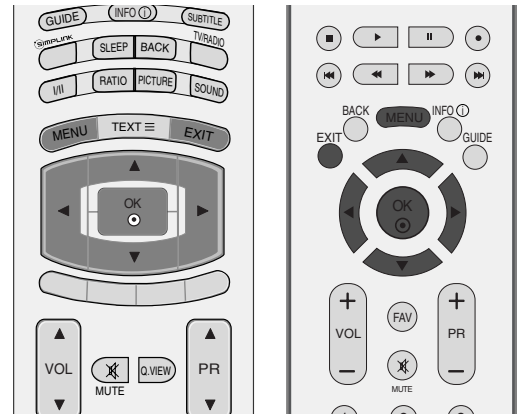

- 1 Press the **MENU** button and then ▲ or ▼ button to select the **SETUP** menu.
- 2 Press the ► button and then use ▲ or ▼ button to select **Diagnostics**.
- 3 Press the ► button to display Manufacturer, Model/Type, Serial Number and Software Version.
- 4 Press the **EXIT** button to return to normal TV viewing.

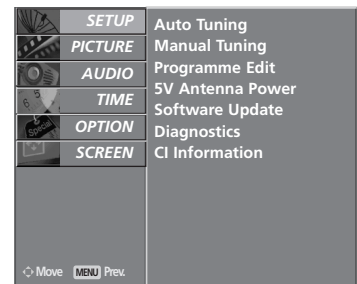

1

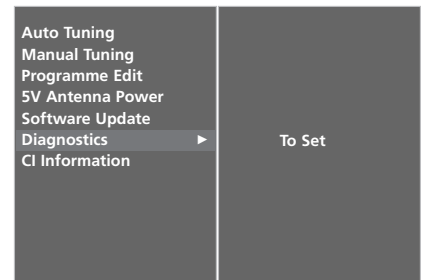

2

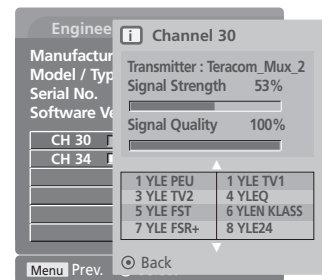

3

WATCHING TV /PROGRAMME CONTROL

CI [COMMON INTERFACE] INFORMATION (IN DIGITAL MODE ONLY)

This function enables you to watch some scrambled services (pay services). If you remove the CI Module, you can't watch the pay services. When the module is inserted to CI slot, you can access the module menu.

To purchase a module and smart card, contact your supplying dealer. Do not often insert or remove a CAM module from the set. It may cause a trouble. When the set turned on after inserting the CI Module, you often can't hear the sound.

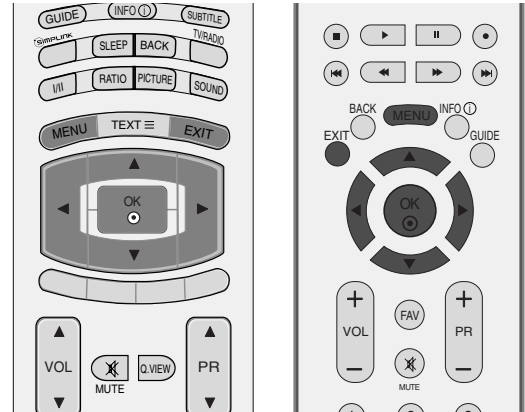

There might be unnatural picture according to CI module and smart card.

CI (Common Interface) function may not be applied based on country broadcasting circumstance.

- 1 Press the **MENU** button and then ▲ or ▼ button to select the **SETUP** menu.
- 2 Press the ► button and then ▲ or ▼ button to select **CI Information**.
- 3 Press the ► button and then OK button.
- 4 Press the ▲ or ▼ button to select the desired item: Module information, smart card information, language, or software download etc.
- 5 Press the OK button.
- 6 Press the **EXIT** button to return to normal TV viewing.

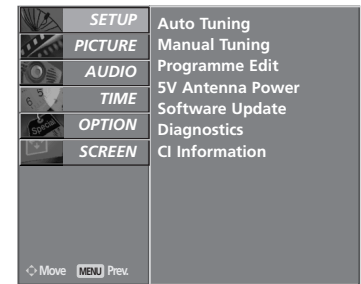

1

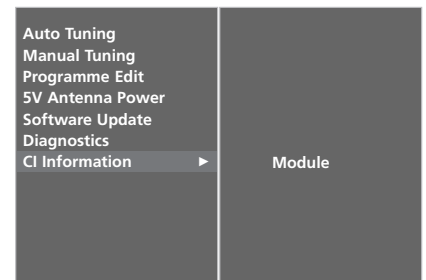

2 3

- This OSD is only for illustration and the menu options and screen format will vary according to the Digital pay services provider.
- It's possible for you to change CI (Common Interface) menu screen and service by your dealer.

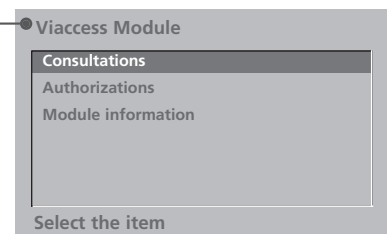

4 5

AUTO PROGRAMME TUNING (IN ANALOGUE MODE)

All stations that can be received are stored by this method. It is recommended that you use Auto tuning during installation of this set.

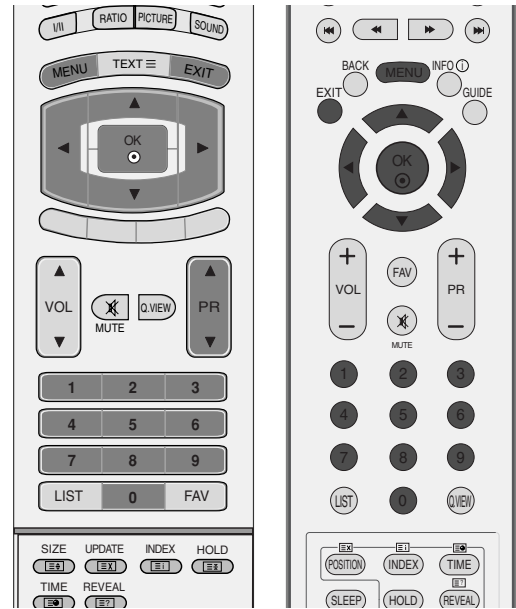

- 1 Press the **MENU** button and then **▲** or **▼** button to select the **SETUP** menu.
- 2 Press the **▶** button and then **▲** or **▼** button to select **Auto Tuning**.
- 3 Press the **▶** button to select **System**. Select a TV system with the **◀** or **▶** button;

L : SECAM L/L' (France)
BG : PAL B/G, SECAM B/G (Europe / East Europe / Asia / New Zealand / M.East / Africa / Australia)
I : PAL I/II (U.K. / Ireland / Hong Kong / South Africa)
DK : PAL D/K, SECAM D/K (East Europe / China / Africa / CIS)

- 4 Press the **▼** button to select **Storage From**.

Select the beginning programme number with the **◀** or **▶** button or NUMBER buttons on the **Storage From** menu.

- 5 Press the **▼** button to select **Start**.

The station name is stored for stations which broadcast VPS (Video Programme Service), PDC (Programme Delivery Control) or TELETTEXT data.

If no station name can be assigned to a station, the channel number is assigned and stored as **C** (V/UHF 01-69) or **S** (Cable 01-47), followed by a number.

To stop auto tuning, press the **MENU** button.

When auto tuning is completed, the **Programme Edit** menu appears on the screen.

See the **'Programme Edit'** section to edit the stored programme.



1

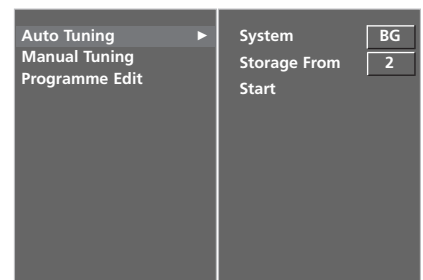

2 3 4 5

WATCHING TV /PROGRAMME CONTROL

MANUAL PROGRAMME TUNING (IN ANALOGUE MODE)

Manual Tuning lets you manually tune and arrange the stations in whatever order you desire.

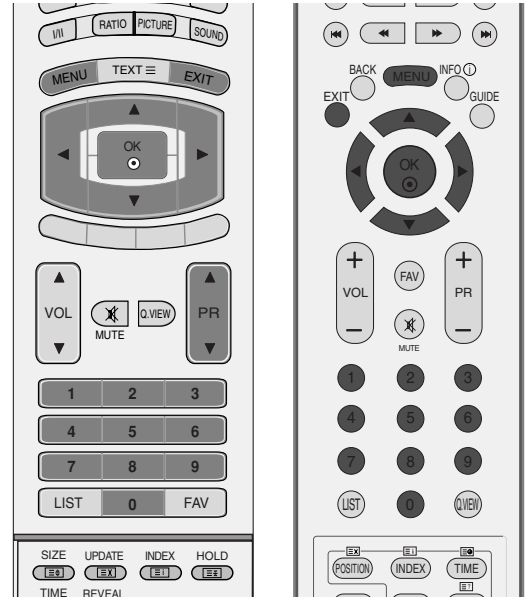

- 1 Press the **MENU** button and then **▲** or **▼** button to select the **SETUP** menu.
- 2 Press the **▶** button and then **▲** or **▼** button to select **Manual Tuning**.
- 3 Press the **▶** button to select **Storage**.
Select the desired programme number with the **◀** or **▶** button or **NUMBER** buttons on the **Storage** menu.
- 4 Press the **▼** button to select **System**. Select a TV system with the **◀** or **▶** button;
L : SECAM L/L' (France)
BG : PAL B/G, SECAM B/G (Europe / East Europe / Asia / New Zealand / M.East / Africa / Australia)
I : PAL I/II (U.K. / Ireland / Hong Kong / South Africa)
DK : PAL D/K, SECAM D/K (East Europe / China / Africa / CIS)
- 5 Press the **▼** button to select **Band**. Press the **◀** or **▶** button to select **V/UHF** or **Cable** as required.
- 6 Press the **▼** button to select **Channel**. You can select the desired channel number with the **◀** or **▶** button or **NUMBER** buttons.
If possible, select the channel number directly with the **NUMBER** buttons.
- 7 Press the **▼** button to select **Search**. Press the **◀** or **▶** button to commence searching. If a station is found the search will stop.
- 8 Press the **OK** button to store it.
- 9 To store another station, repeat steps 3 to 8.
- 10 Press the **EXIT** button to return to normal TV viewing.

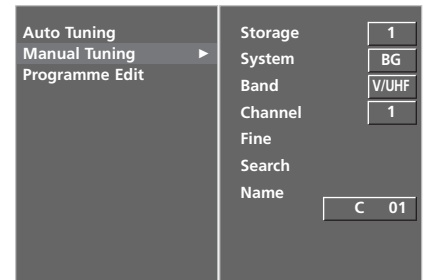
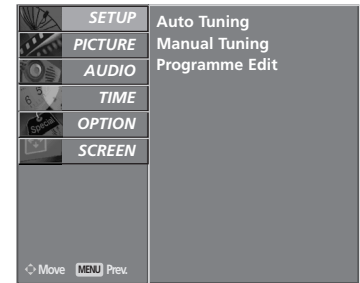

FINE TUNING (IN ANALOGUE MODE)

Normally fine tuning is only necessary if reception is poor.

- 1 Press the **MENU** button and then **▲** or **▼** button to select the **SETUP** menu.
- 2 Press the **▶** button and then **▲** or **▼** button to select **Manual Tuning**.
- 3 Press the **▶** button and then **▲** or **▼** button to select **Fine**.
- 4 Press the **▶** button and then **◀** or **▶** button to fine tune for the best picture and sound.
- 5 Press the **OK** button to store it.
- 6 Press the **EXIT** button to return to normal TV viewing.

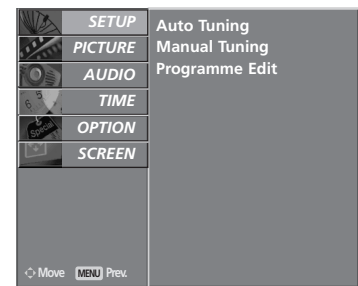
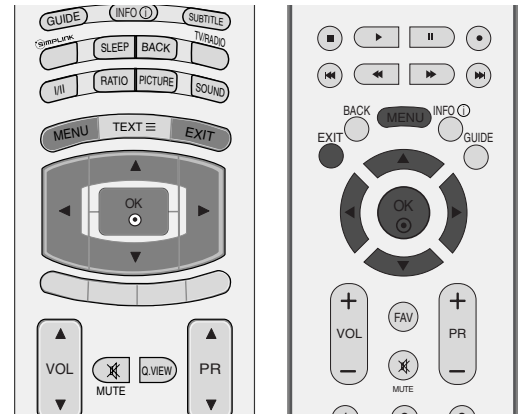

1

ASSIGNING A STATION NAME (IN ANALOGUE MODE)

You can assign a station name with five characters to each programme number.

- 1 Press the **MENU** button and then **▲** or **▼** button to select the **SETUP** menu.
- 2 Press the **▶** button and then **▲** or **▼** button to select **Manual Tuning**.
- 3 Press the **▶** button and then **▲** or **▼** button to select **Name**.
- 4 Press the **▶** button and then **▲** or **▼** button. You can use a the alphabet **A** to **Z**, the number **0** to **9**, +/ -, and blank.
- 5 Press the **◀** or **▶** button to select the position and make your choice of the second character, and so on.
- 6 Press the **OK** button to store it.
- 7 Press the **EXIT** button to return to normal TV viewing.

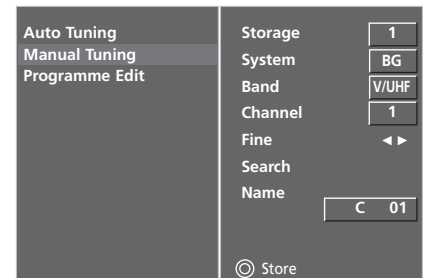

2 3 4 5

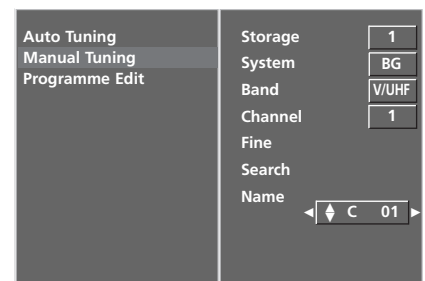

2 3 4 5 6

WATCHING TV /PROGRAMME CONTROL

PROGRAMME EDIT (IN ANALOGUE MODE)

This function enables you to delete or skip the stored programmes. Also you can move some stations to other programme numbers or copy a blank station data into the selected programme number.

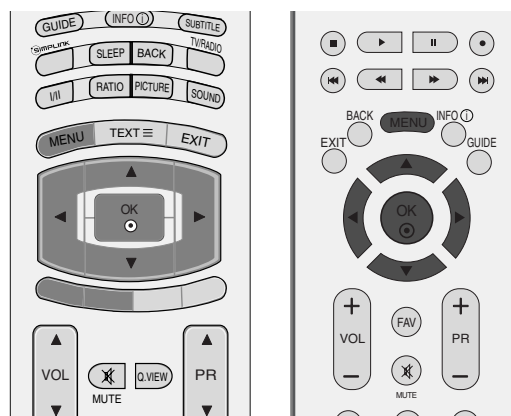

- 1 Press the **MENU** button and then **▲** or **▼** button to select the **SETUP** menu.
- 2 Press the **▶** button and then **▲** or **▼** button to select **Programme Edit**.
- 3 Press the **▶** button to display the Programme Edit menu.

■ Deleting a programme

- a Select a programme to be deleted with the **▲** or **▼** or **◀** or **▶** button.
- b Press the **RED** button twice. The selected programme is deleted, all the following programmes are shifted up one position.

■ Copying a programme

- a Select a programme to be copied with the **▲** or **▼** or **◀** or **▶** button.
- b Press the **GREEN** button. All the following programmes are shifted down one position.

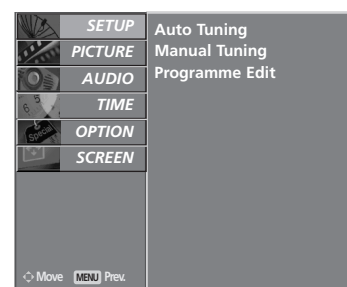

1



2

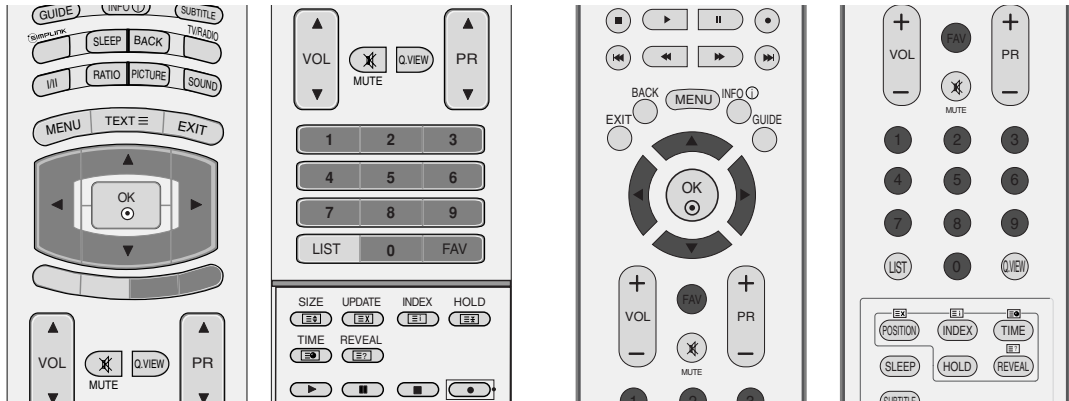

■ Moving a programme

- Select a programme to be moved with ▲ or ▼ or ◀ or ▶ button.
- Press the **YELLOW** button.
- Move the programme to the desired programme number with the ▲ or ▼ or ◀ or ▶ button.
- Press the **YELLOW** button again to release this function.

■ Skipping a programme number

- Select a programme number to be skipped with ▲ or ▼ or ◀ or ▶ button.
- Press the **BLUE** button. The skipped programme number turns to blue.
- Press the **BLUE** button to release the skipped programme.
- When a programme number is skipped it means that you will be unable to select it using the PR ▲ or ▼ (or PR + or -) button during normal TV viewing.

If you want to select the skipped programme, directly enter the programme number with the **NUMBER** buttons or select it in the programme edit or table menu.

■ Selecting Favourite Programme

- Select your favourite programme number with ▲ or ▼ or ◀ or ▶ button.
- Press the **FAV** button.

The selected programme will be added to the favourite programme list.

CALLING THE PROGRAMME TABLE

You can check the programmes stored in the memory by displaying the programme table.

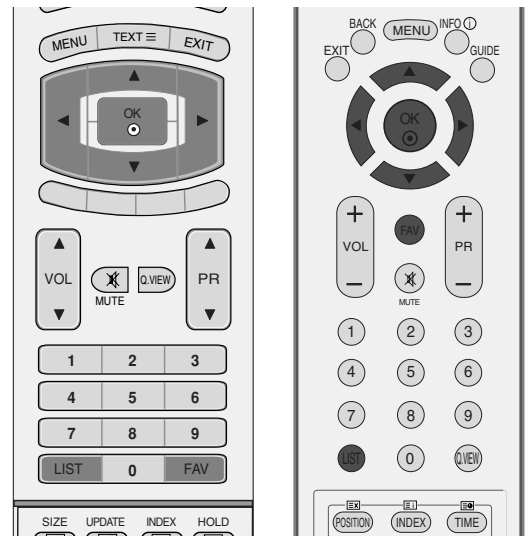

■ Displaying programme LIST

- 1 Press the **LIST** button to display the **PROGRAMME LIST** menu.

The programme list appears on the screen.

- You may find some blue programmes. They have been set up to be skipped by auto programming or in the programme edit mode.
- Some programmes with the channel number shown in the programme LIST indicate there is no station name assigned.

■ Selecting a programme in the programme list

- 1 Select a programme with the **▲** or **▼** button.
- 2 Press the **OK** button. The set switches to the chosen programme number.

■ Paging through a programme list

There are programme LIST pages which total contain 100 programmes (**Analogue Mode**).

- 1 Press the **▲** or **▼** button repeatedly to turn the pages.
- 2 Press the **LIST** button to return to normal TV viewing.

■ Displaying favourite programme table

Press the **FAV** button to display the Favourite Programme table menu.



< In Digital Mode >

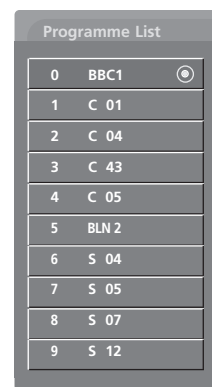

< In Analogue Mode >

Mini Glossary

- ♥ Displayed when the Favourite Programme.
- 🔒 Displayed when the Locked Programme.

INPUT SOURCE SELECTION

Sets a label to each input source which is not in use.

- 1 Press the **MENU** button and then use ▲ or ▼ button to select the **OPTION** menu.
- 2 Press the ► button and then use ▲ or ▼ button to select **Input Label**.
- 3 Press the ► button and then use ▲ or ▼ button to select the source: AV1, AV2, Comp., RGB, HDMI1, HDMI2 or HDMI3 (Only 37/42LF7*, 42LY99).
- 4 Press the ◀ or ▶ button to select the label.
- 5 Press **EXIT** button to return to normal TV viewing.

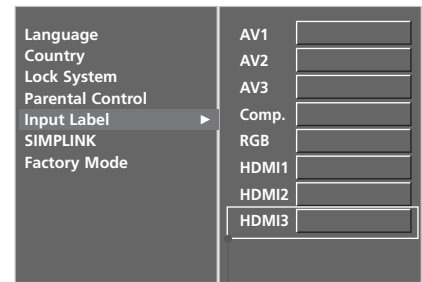
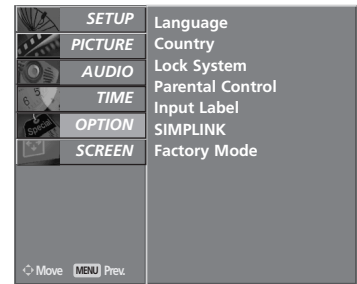
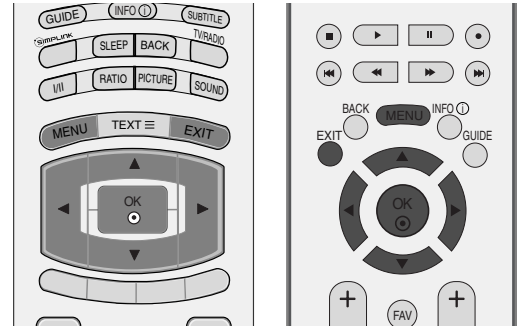

Only 37/42LF7*, 42LY99

3 4

INDEX

You can switch **FRONT DISPLAY** on or off.
This feature is not available for all models.

- 1 Press the **MENU** button and then use ▲ or ▼ button to select the **OPTION** menu.
- 2 Press the ► button and then use ▲ or ▼ button to select **Index**.
- 3 Press the ► button and then use ▲ or ▼ button to select **On** or **Off**.

When you select **On** mode, The **FRONT DISPLAY** illuminates brightly.
- 4 Press the **EXIT** button to return to normal TV viewing.

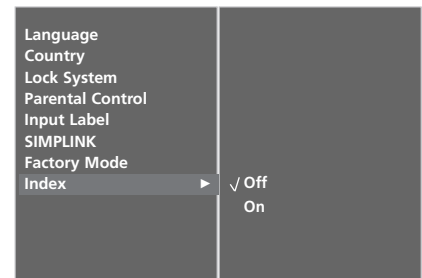
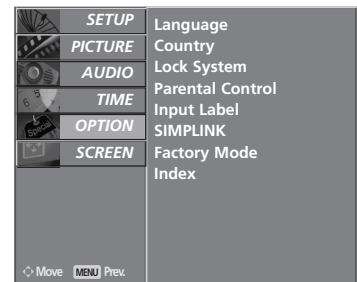

3

WATCHING TV /PROGRAMME CONTROL



This operates only for the devices with the SIMPLINK logo. Please check the SIMPLINK logo.

This allows you to control and play other AV devices connected to the display through HDMI cable without additional cables and settings.

If you do not want SIMPLINK menu, select “Off”.

In 37/42LF7*, 42LY99 model, SIMPLINK function is not supported by HDMI IN 3 input.

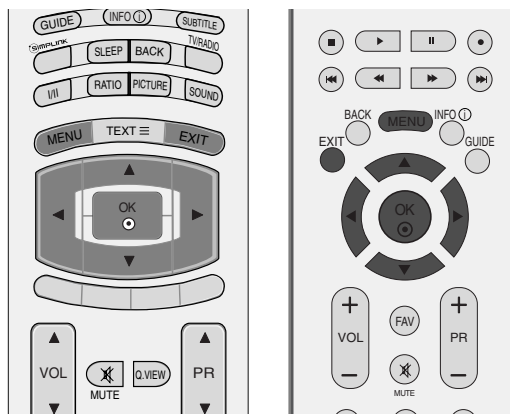

1 Press the MENU button and then ▲ or ▼ button to select the **OPTION** menu.

2 Press the ► button and then ▲ or ▼ button to select **SIMPLINK**.

3 Press the ► button and then ▲ or ▼ button to select **Off** or **On**.

4 Press the EXIT button to return to normal TV viewing.

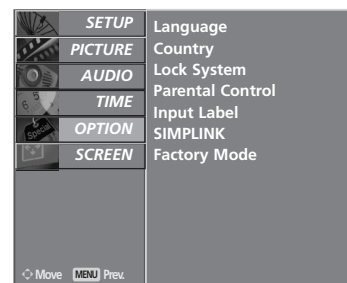



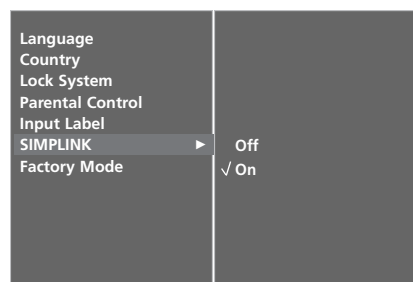



1



2 3

SIMPLINK Functions

Disc playback

Control connected AV devices by pressing the ▲ or ▼ or ◀ or ▶, OK, , , , , ,  and  buttons.

Direct Play

After connecting AV devices to TV, you can directly control the devices and play media without additional settings.

Select AV device

Enables you to select one of AV devices connected to TV and play it.

Power off all devices

When you power off TV, all connected devices are turned off.

Switch audio-out

Offers an easy way to switch audio-out.

* A device, which is connected to TV through HDMI cable but does not support Simplink, does not provide this function.

SIMPLINK Menu

Press the ▲ or ▼ or ◀ or ▶ button and then OK button to select the desired SIMPLINK source.

- 1 **TV viewing** : Switch to the previous TV programme regardless of the current mode.
- 2 **DISC playback** : Select and play connected discs. When multiple discs are available, the titles of discs are conveniently displayed at the bottom of the screen.
- 3 **VCR playback** : Play and control the connected VCR.
- 4 **HDD Recordings playback** : Play and control recordings stored in HDD.
- 5 **Audio Out to Home theatre/Audio Out to TV:** Select Home theatre or TV speaker for Audio Out.



! NOTE

- ▶ Connect the HDMI/DVI IN or HDMI IN terminal of the TV to the rear terminal (HDMI terminal) of the SIMPLINK device with the HDMI cable.
- ▶ After connecting the HDMI terminal for the home theater with SIMPLINK function in the above method, connect the DIGITAL AUDIO OUT terminal on the back of the TV to the DIGITAL AUDIO IN terminal on the back of the SIMPLINK device with the OPTICAL cable.
- ▶ When operating the external device with SIMPLINK, press the TV button among the MODE button on the remote controller.
- ▶ When you switch the Input source with the INPUT button on the remote controller, you can stop the operation of device controlled by SIMPLINK.
- ▶ When you select or operate the media device with home theater function, the speaker automatically switches to home theater speaker (HT speaker).

PICTURE CONTROL

EPG (ELECTRONIC PROGRAMME GUIDE) (IN DIGITAL MODE)

This system has an Electronic Programme Guide (EPG) to help your navigation through all the possible viewing options.

The EPG supplies information such as programme listings, start and end times for all available services. In addition, detailed information about the programme is often available in the EPG (the availability and amount of these programme details will vary, depending on the particular broadcaster).

This function can be used only when the EPG information is broadcasted by broadcasting companies.

The EPG displays the programme description for next 8 days.

Switch on/off EPG

- 1 Press the **GUIDE** button to switch on EPG.
- 2 Press the **GUIDE** or **EXIT** button again to switch off EPG and return to normal TV viewing.

Select a programme

- 1 Press the **▲** or **▼**, **◀** or **▶**, **PR ▲** or **▼** (or **PR +** or **-**) button to select desired programme, then press the **OK** button to display the selected programme.



Button Function in NOW/NEXT Guide Mode

Remote Control Buttons	Function
RED	Change EPG mode
YELLOW	Enter Timer Record/Remind setting mode
BLUE	Enter Timer Record/Remind list mode
●	Change to the selected channel
◀ or ▶	Select NOW or NEXT Programme
▲ or ▼	Select the Broadcasting Programme
PR	Page Up/Down
GUIDE/EXIT	Switch off EPG
TV/RADIO	Select TV or RADIO Programme
INFO ⓘ	The detail information on or off



Button Function in 8 Days Guide Mode

Remote Control Buttons	Function
RED	Change EPG mode
GREEN	Enter Date setting mode
YELLOW	Enter Timer Record/Remind setting mode
BLUE	Enter Timer Record/Remind list mode
●	Change to the selected channel
◀ or ▶	Select NOW or NEXT Programme
▲ or ▼	Select the Broadcasting Programme
PR	Page Up/Down
GUIDE/EXIT	Switch off EPG
TV/RADIO	Select TV or RADIO Programme
INFO ⓘ	The detail information on or off



PICTURE CONTROL

Button Function in Date Change Mode

Remote Control Buttons	Function
GREEN	Switch off Date setting mode
●	Change to the selected date
◀ or ▶	Select a date
▼	Switch off Date setting mode
GUIDE/EXIT	Switch off EPG



PICTURE CONTROL

Button Function in Extended Description Box

Remote Control Buttons	Function
▲ or ▼	Text Up/Down
YELLOW	Enter Timer Record/Remind setting mode
INFO ⓘ	The detail information on or off
GUIDE/EXIT	Switch off EPG

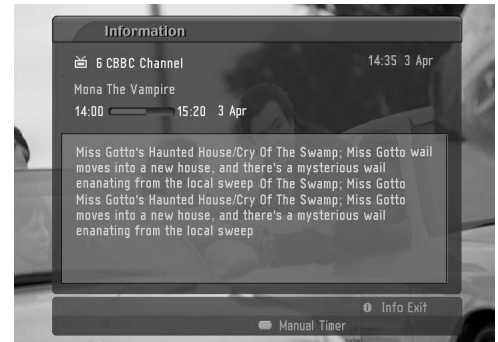

Button Function in Record/Remind Setting Mode

- This function is available only when recording equipment that use pin8 recording signalling has been connected to the DTV-OUT terminal, using a SCART cable.

Remote Control Buttons	Function
YELLOW	Change to Guide or Timer list mode
●	Save Timer Record/Remind
◀ or ▶	Select Type, Service, Date or Start/End time
▲ or ▼	Function setting

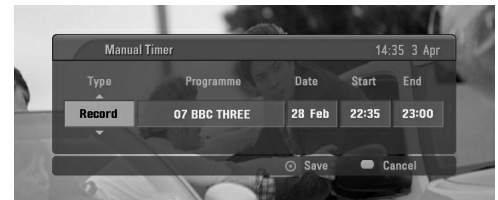

Button Function in Timer List Mode

Remote Control Buttons	Function
YELLOW	Add new Manual Timer setting mode
GREEN	Enter Timer list editing mode
RED	Delete the selected item
BLUE	Change to Guide mode
▲ or ▼	Select Timer list



PICTURE SIZE (ASPECT RATIO) CONTROL

You can watch the screen in various picture formats; **Spectacle**(Except 37/42LF7*, 42LY99), **Full**(Except 42LY99), **Original**, **4:3**, **16:9**, **14:9**, **Zoom 1/2** and **1:1 Pixel** (or **Just Scan**(Only 37/42LF7*, 42LY99)).

If a fixed image is displayed on the screen for a long time, that fixed image may become imprinted on the screen and remain visible.

There might be uncomfortable in full mode. Then change into other mode.

You can adjust the enlarge proportion using ▲ or ▼ button.

This function works in the following signal.

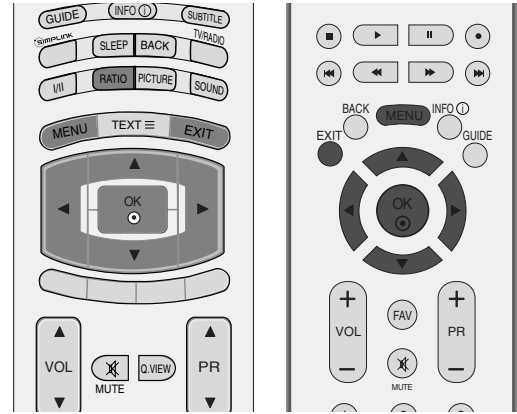

- 1 Press the **RATIO** button repeatedly to select the desired picture format. You can also adjust **Aspect Ratio** in the **SCREEN** menu.

- **Spectacle (Except 37/42LF7*, 42LY99)**
When your TV receives the wide screen signal, when selected it will adjust the picture horizontally, in non-linear proportion, to fill the entire screen.

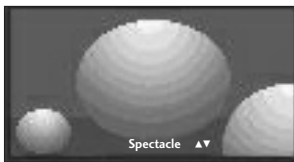

- **Full (Except 42LY99)**
When your TV receives the wide screen signal, when selected it will adjust the picture horizontally or vertically, in a linear proportion, to fill the entire screen fully.

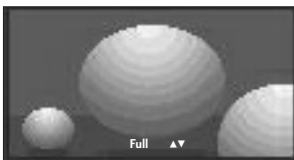

- **Original**
When your TV receives the wide screen signal, it will be automatically changed to the picture format to be sent.

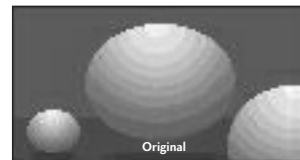

- **4:3**
Following selection will lead you to view a picture with an original 4:3 aspect ratio, with gray bars appearing at both the left and right sides.



PICTURE CONTROL

- **16:9**

Following selection will lead you to adjust the picture horizontally, in a linear proportion, to fill the entire screen (useful for viewing 4:3 formatted DVDs).

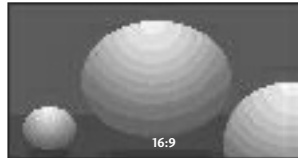

- **14:9**

You can enjoy the picture format of 14:9 or general TV programme through the 14:9 mode. The screen 14:9 is viewed just like that the screen 4:3 is magnified to the left / right.

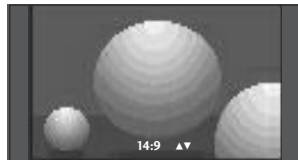

- **Zoom1**

Following selection will lead you to view the picture without any alternation, while filling the entire screen. However, the top and bottom portions of the picture will be cropped.

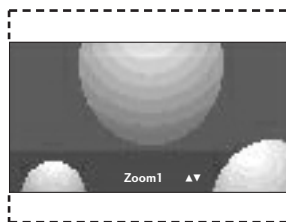

- **Zoom2**

Choose Zoom2 when you want the picture to be altered, both horizontally extended and vertically cropped. The picture taking a halfway trade off between alteration and screen coverage.

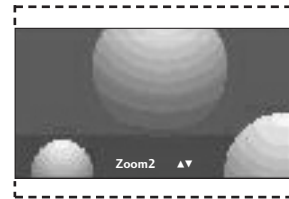

- **1:1 Pixel (or Just Scan(Only 37/42LF7*, 42LY99))**

Following Selection will lead you to view the picture of best quality without loss of original picture in high resolution image.

! NOTE

- ▶ You can only select **4:3, 16:9 (Wide)**, Zoom 1/2 in Component, HDMI mode.
- ▶ You can only select **4:3, 16:9 (Wide)** in RGB mode only.
- ▶ In HDMI (1080i 50Hz/60Hz, 1080p 24Hz/50Hz/60Hz) mode, **1:1 Pixel(or Just Scan(Only 37/42LF7*, 42LY99))** is available.

PRESET PICTURE SETTINGS

Picture Mode-Preset

- Dynamic** Select this option to display with a sharp image.
- Standard** The most general and natural screen display status.
- Mild** Select this option to display with a mild image.
- User 1/2** Select this option to use the user-defined setting.

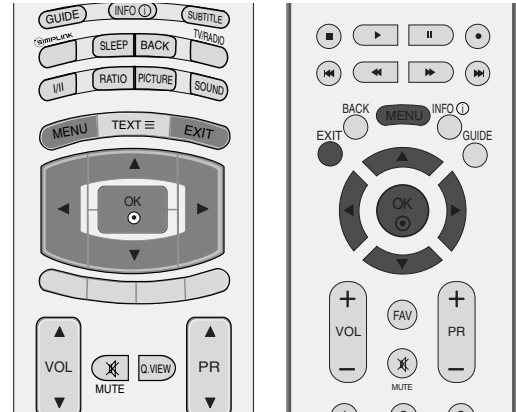

- 1 Press the **MENU** button and then **▲** or **▼** button to select the **PICTURE** menu.
- 2 Press the **▶** button and then **▲** or **▼** button to select **Picture Mode**.
- 3 Press the **▶** button and then **▲** or **▼** button to select **Intelligent Eye** (except 50/60PF9*), **Dynamic**, **Standard**, **Mild**, **User 1**, or **User 2**.
- 4 Press the **EXIT** button to return to normal TV viewing.

Picture Mode adjusts the set for the best picture appearance. Select the preset value in the **Picture Mode** menu based on the programme category.

Intelligent Eye (except 50/60PF9*), **Dynamic**, **Standard** and **Mild** are programmed for optimum picture reproduction at the factory and cannot be changed.

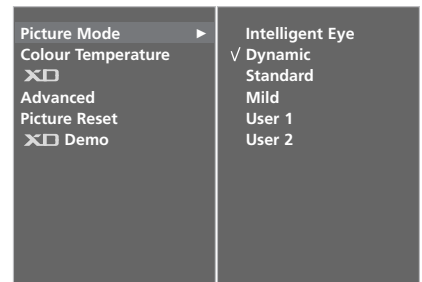
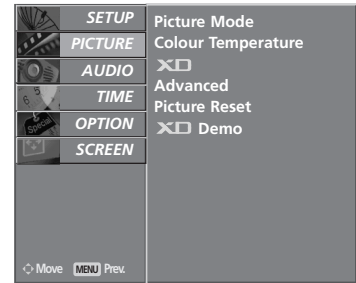

PICTURE CONTROL

Auto Colour Tone Control (Warm/Medium/Cool)

To initialize values (reset to default settings), select the Cool option.

Choose one of three automatic colour adjustments. Set to warm to enhance hotter colours such as red, or set to cool to see less intense colours with more blue.

It's available to use this function in **User** mode.

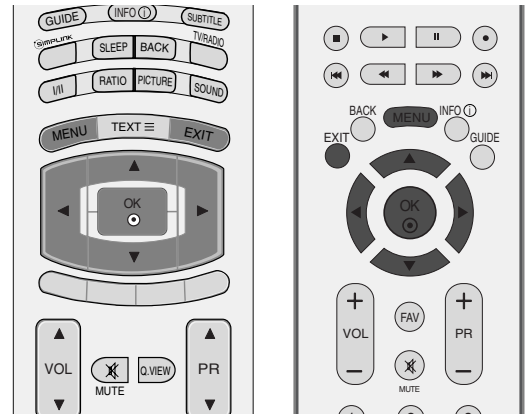

- 1 Press the **MENU** button and then **▲** or **▼** button to select the **PICTURE** menu.
- 2 Press the **▶** button and then **▲** or **▼** button to select **Colour Temperature**.
- 3 Press the **▶** button and then **▲** or **▼** button to select either **Cool**, **Medium**, **Warm**, or **User**.
- 4 Press the **EXIT** button to return to normal TV viewing.

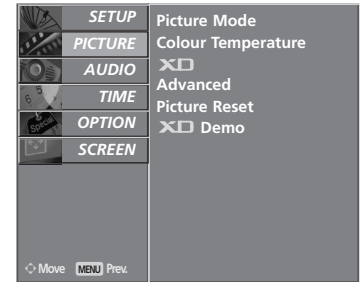

1

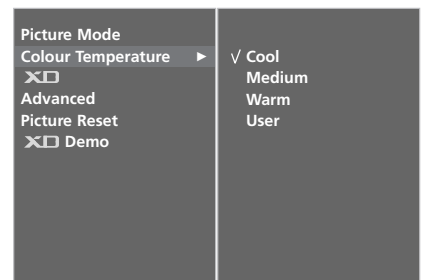

2 3

MANUAL PICTURE ADJUSTMENT

Picture Mode-User option

- Contrast** Adjusts the difference between the light and dark levels in the picture.
- Brightness** Increases or decreases amount of white in the your picture.
- Colour** Adjusts intensity of all colours.
- Sharpness** Adjusts the level of crispness in the edges between the light and dark areas of the picture. The lower the level, the softer the image.
- Tint** Adjusts the balance between red and green levels.

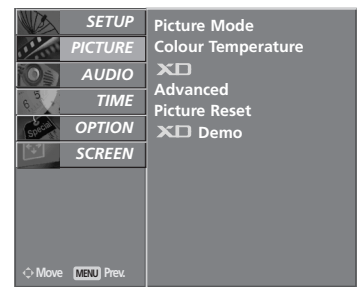
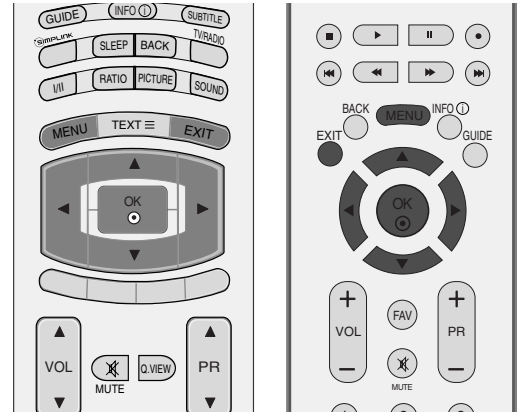

- 1 Press the **MENU** button and then **▲** or **▼** button to select the **PICTURE** menu.
- 2 Press the **▶** button and then **▲** or **▼** button to select **Picture Mode**.
- 3 Press the **▶** button and then **▲** or **▼** button to select **User 1** or **User 2**.
- 4 Press the **▶** button and then **▲** or **▼** button to select the desired picture option (**Contrast**, **Brightness**, **Colour**, **Sharpness** and **Tint**).
- 5 Press the **◀** or **▶** button to make appropriate adjustments.
- 6 Press the **EXIT** button to return to normal TV viewing.

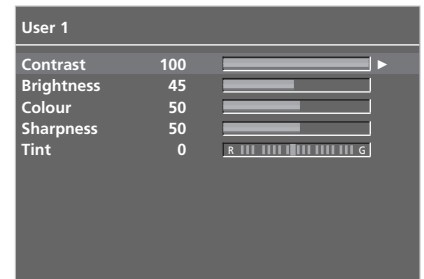
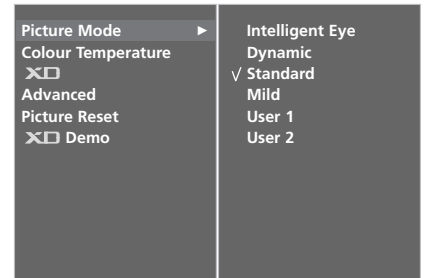

NOTE

- ▶ You can't adjust colour, sharpness and tint in the RGB-PC mode to the levels you prefer.

PICTURE CONTROL

Colour Tone - User option

To adjust red, green, blue to any colour temperature you prefer.

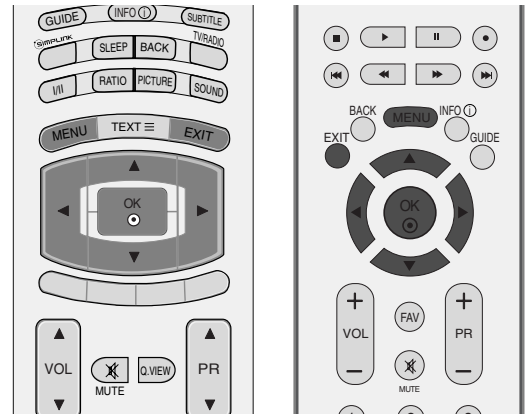

1 Press the **MENU** button and then **▲** or **▼** button to select the **PICTURE** menu.

2 Press the **▶** button and then **▲** or **▼** button to select **Colour Temperature**.

3 Press the **▶** button and then **▲** or **▼** button to select **User**.

4 Press the **▶** button and then **▲** or **▼** button to select **Red**, **Green** or **Blue**.

5 Press the **◀** or **▶** button to make appropriate adjustments.

6 Press the **EXIT** button to return to normal TV viewing.

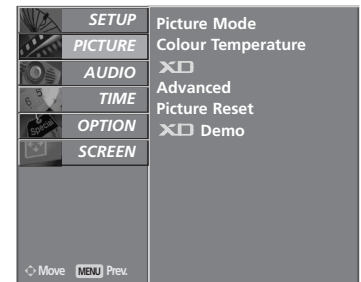

1

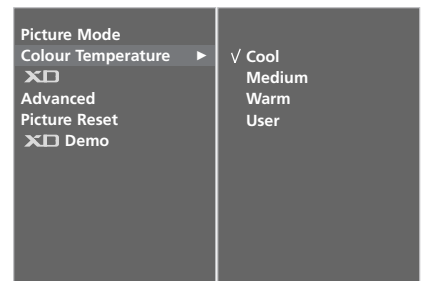

2 3

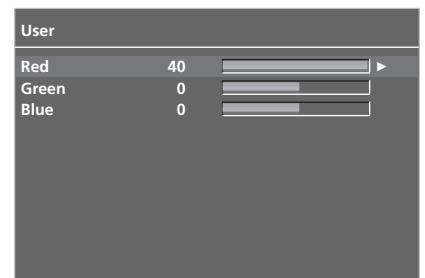

4 5

XD - PICTURE IMPROVEMENT TECHNOLOGY

XD is LG electronic's unique picture improving technology to display a real HD source through an advanced digital signal processing algorithm.

It's not available to use this function in PC[RGB/HDMI] mode.

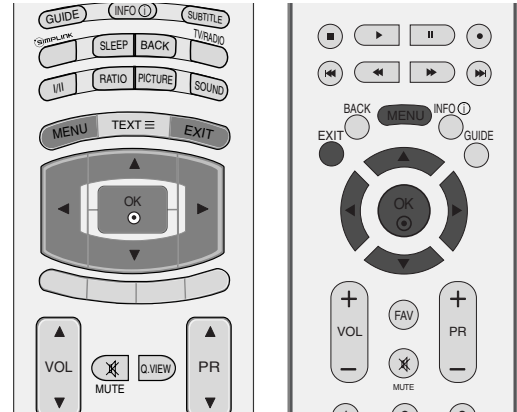

- 1 Press the MENU button and then ▲ or ▼ button to select the **PICTURE** menu.
- 2 Press the ► button and then ▲ or ▼ button to select **XD**.
- 3 Press the ► button and then ▲ or ▼ button to select **Auto** or **Manual**.
- 4 Press the EXIT button to return to normal TV viewing.

* Selecting the Manual

This menu is activated after selecting the **User1** or **User2** of **Picture Mode**.

- 1 Press the ► button and then ▲ or ▼ button to select **XD Contrast**, **XD Colour**, **XD NR** or **MPEG NR**.
- 2 Press the ► button and then ▲ or ▼ button to select **On** or **Off**.
- 3 Press the EXIT button to return to normal TV viewing.

- **XD Contrast** : Optimizing the contrast automatically according to the brightness of the reflection.
- **XD Colour** : Adjusting the colors of the reflection automatically to reproduce as closely as possible to the natural colors.
- **XD NR** : Removing the noise up to the point where it does not damage the original picture.
- **MPEG NR** : To reduce the picture noise which may appear on the screen during watching the TV.

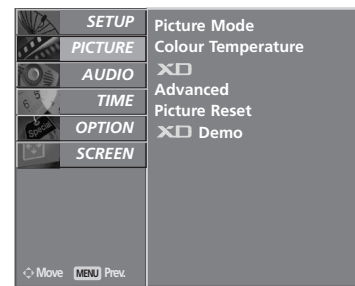

1

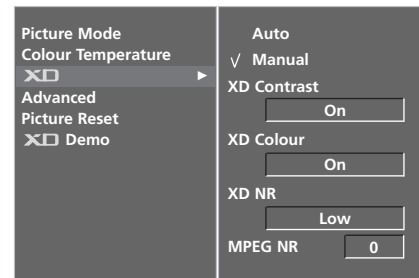

2

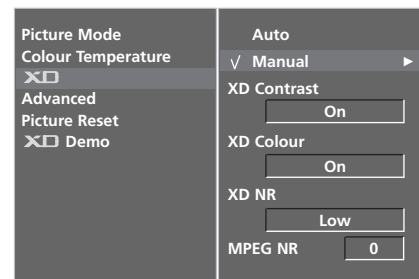

3

PICTURE CONTROL

XD DEMO

Use it to see the difference between XD Demo on and XD Demo off.

It's not available to use this function in RGB[PC], HDMI[PC] mode.

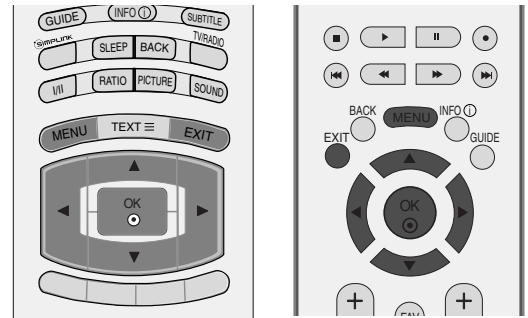

- 1 Press the MENU button and then ▲ or ▼ button to select the **PICTURE** menu.
- 2 Press the MENU button and then ▲ or ▼ button to select **XD Demo**.
- 3 Press the ► button to begin **XD Demo**.
- 4 To stop **XD Demo**, press the MENU or EXIT button.

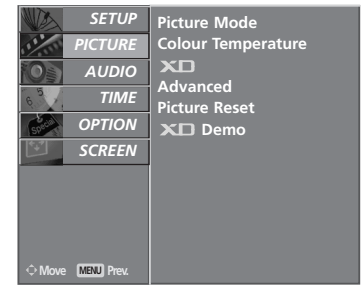

1

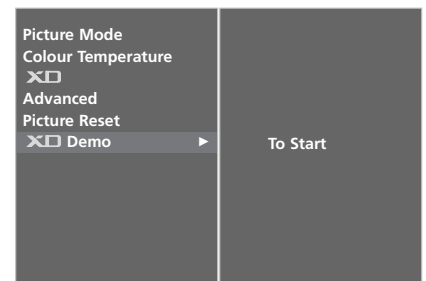

2 3

TRUMOTION DEMO (Only 42LY99)

Use it to see the difference between TruMotion Demo on and TruMotion Demo off.

It's not available to use this function in RGB[PC], HDMI[PC] mode.

- 1 Press the MENU button and then ▲ or ▼ button to select the **PICTURE** menu.
- 2 Press the MENU button and then ▲ or ▼ button to select **TruMotion Demo**.
- 3 Press the ► button to begin **TruMotion Demo**.
- 4 To stop **TruMotion Demo**, press the MENU or EXIT button.

* Only 42LY99

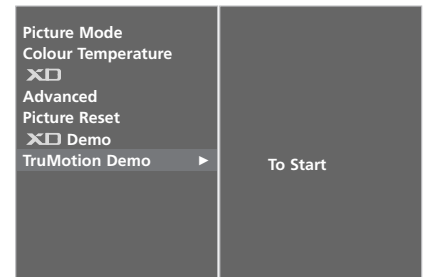

2 3

• XD Demo



• TruMotion Demo

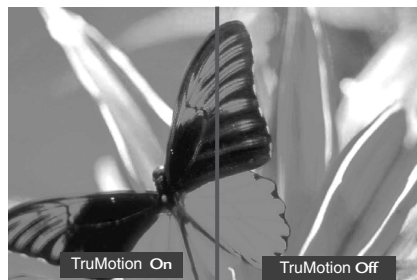

ADVANCED - CINEMA

Set up the TV for the best picture appearance for viewing movies.

This feature operates only in TV, AV, S-Video and Component 480i/576i, DTV mode.

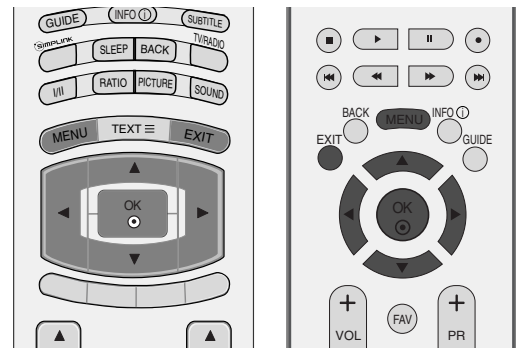

- 1 Press the **MENU** button and then **▲** or **▼** button to select the **PICTURE** menu.
- 2 Press the **▶** button and then **▲** or **▼** button to select **Advanced**.
- 3 Press the **▶** button and then **▲** or **▼** button to select **Cinema**.
- 4 Press the **◀** or **▶** button to select **On** or **Off**.
- 5 Press the **EXIT** button to return to normal TV viewing.

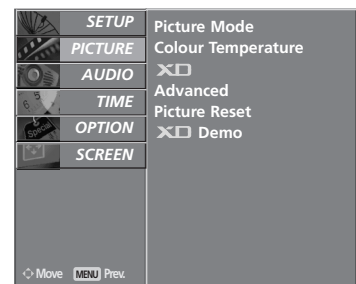

1

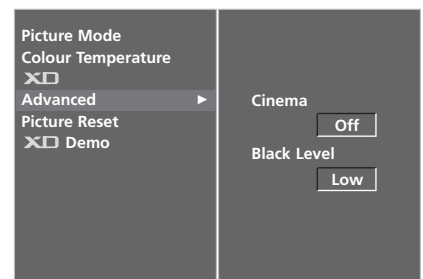

2

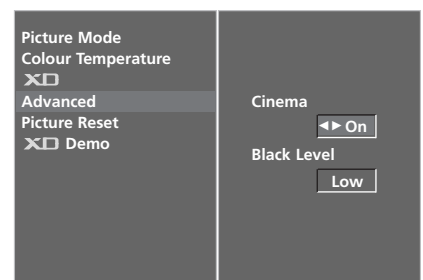

3

* Only 42LY99

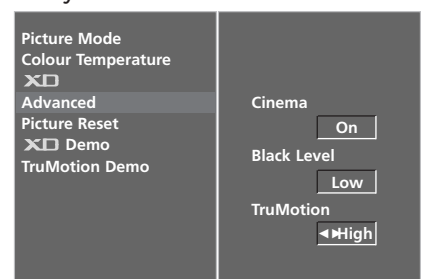

3

ADVANCED - TRUMOTION (Only 42LY99)

It is used for the best picture quality without any motion blur or judder when you enter a quick image or Film Source.

This feature is disable in RGB-PC,HDMI-PC mode.

- 1 Press the **MENU** button and then **▲** or **▼** button to select the **PICTURE** menu.
- 2 Press the **▶** button and then **▲** or **▼** button to select **Advanced**.
- 3 Press the **▶** button and then **▲** or **▼** button to select **TruMotion**.
- 4 Press the **◀** or **▶** button to select **Off**, **Low** or **High**.
 - Low
Set amount of film judder to low.
 - High
Set amount of film judder to high.

* If you have some problem in viewing picture, set **TruMotion** to **Low** or **Off**.

- 5 Press the **EXIT** button to return to normal TV viewing.

PICTURE CONTROL

ADVANCED - BLACK(DARKNESS) LEVEL

When you watch the movie, this function adjusts the set to the best picture appearance. Adjusting the contrast and the brightness of the screen using the black level of the screen.

This function works in the following mode: AV (NTSC-M), S-Video (NTSC-M) or HDMI.

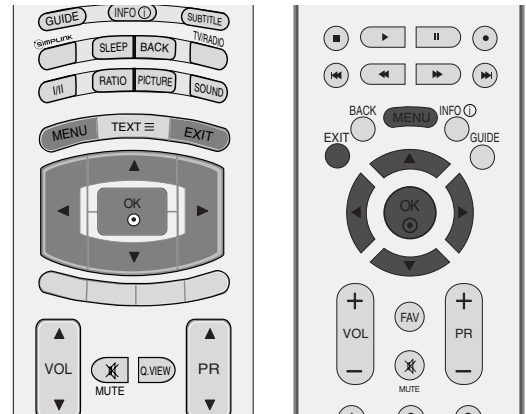

- 1 Press the **MENU** button and then ▲ or ▼ button to select the **PICTURE** menu.

- 2 Press the ► button and then ▲ or ▼ button to select **Advanced**.

- 3 Press the ► button and then ▲ or ▼ button to select **Black Level**.

- 4 Press the ◀ or ▶ button to select **Low** or **High**.
 - **Low** : The reflection of the screen gets darker.
 - **High** : The reflection of the screen gets brighter.

- 5 Press the **EXIT** button to return to normal TV viewing.

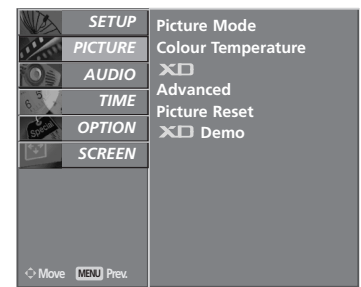

1

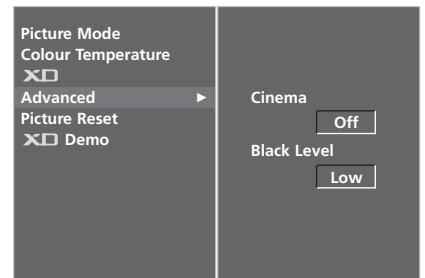

2

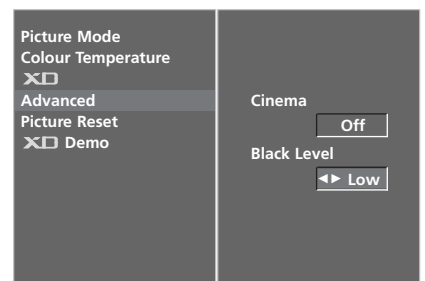

3 4

PICTURE RESET

Returns to the default settings Picture Mode, Colour Temperature, XD, Advanced at the factory.

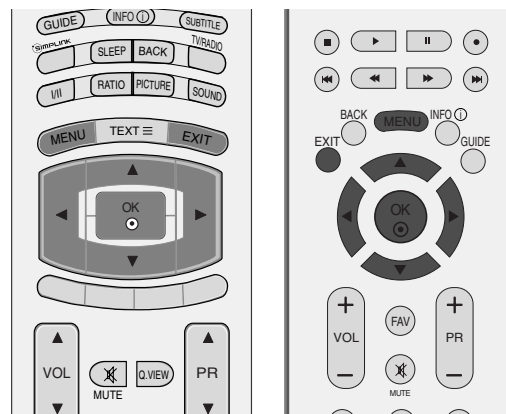

- 1 Press the **MENU** button and then **▲** or **▼** button to select the **PICTURE** menu.
- 2 Press the **▶** button and then **▲** or **▼** button to select **Picture Reset**.
- 3 Press the **▶** button to initialize the adjusted value.

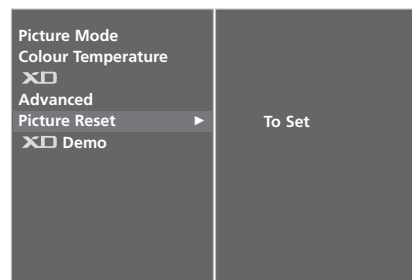
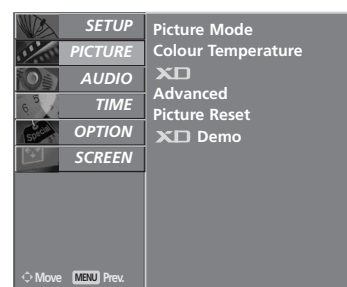

3

PICTURE CONTROL

IMAGE STICKING MINIMIZATION (ISM) METHOD

A frozen or still picture from a PC/video game displayed on the screen for prolonged periods will result in a ghost image remaining even when you change the image. Avoid allowing a fixed image to remain on the set's screen for a long period of time.

It's not available to use this function in LCD models.

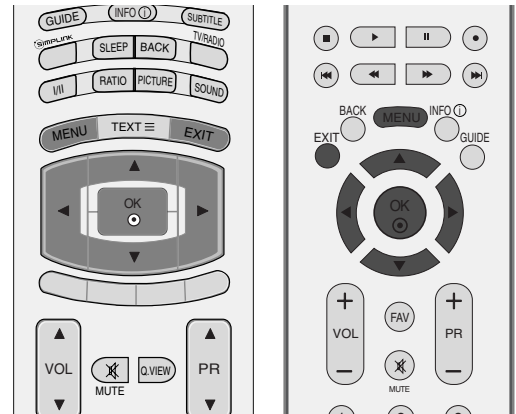

White wash

White wash removes permanent images from the screen.

Note: An excessive permanent image may be impossible to clear entirely with White Wash.

Orbiter

Orbiter may help prevent ghost images. However, it is best not to allow any fixed image to remain on the screen. To avoid a permanent image on the screen, the screen will move every 2 minutes.

Inversion

This is the function to invert the panel colour of the screen. The panel colour is automatically inverted every 30 minutes.

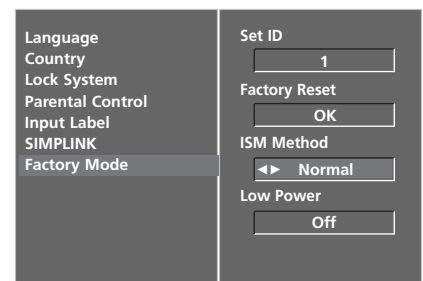
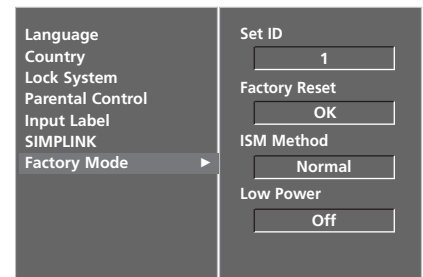
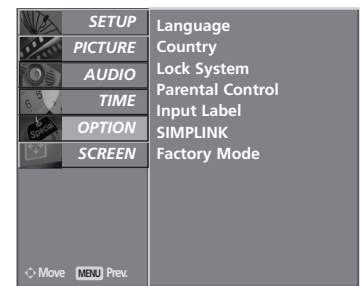

- 1 Press the **MENU** button and then **▲** or **▼** button to select the **OPTION** menu.
- 2 Press the **▶** button and then **▲** or **▼** button to select **Factory Mode**.
- 3 Press the **▶** button and then **▲** or **▼** button to select **ISM Method**.
- 4 Press the **◀** or **▶** button to select either **Normal**, **White wash**, **Orbiter** or **Inversion**. If you unnecessary to set this function, set **Normal**.
- 5 Press the **EXIT** button to return to normal TV viewing.

LOW-POWER PICTURE MODE

This is the function to reduce the power consumption of the set.

It's not available to use this function in LCD TV models.

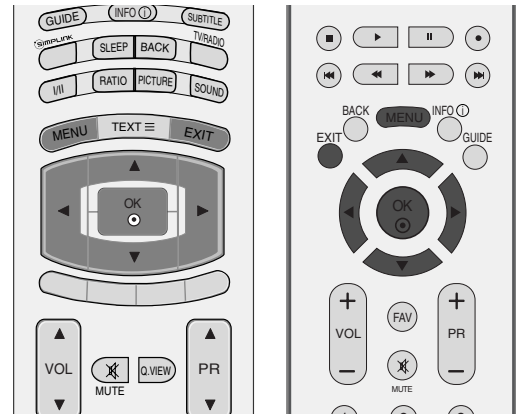

- 1 Press the **MENU** button and then **▲** or **▼** button to select the **OPTION** menu.
- 2 Press the **▶** button and then **▲** or **▼** button to select **Factory Mode**.
- 3 Press the **▶** button and then **▲** or **▼** button to select **Low power**.
- 4 Press the **◀** or **▶** button to select **On** or **Off**.
- 5 Press the **EXIT** button to return to normal TV viewing.

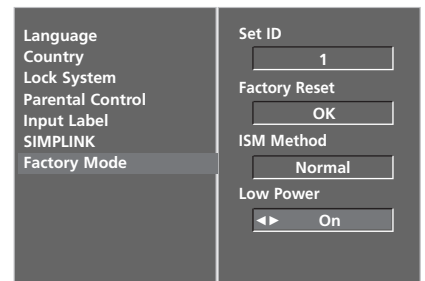
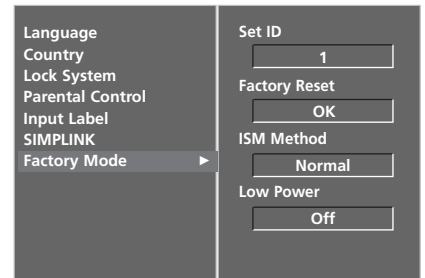
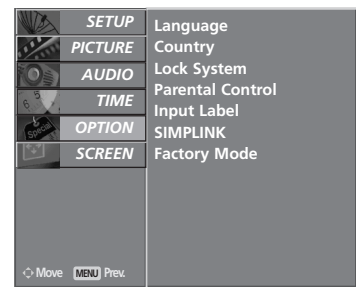

SOUND & LANGUAGE CONTROL

AUTO VOLUME LEVELER

AVL automatically keeps on an equal volume level even if you change programmes.

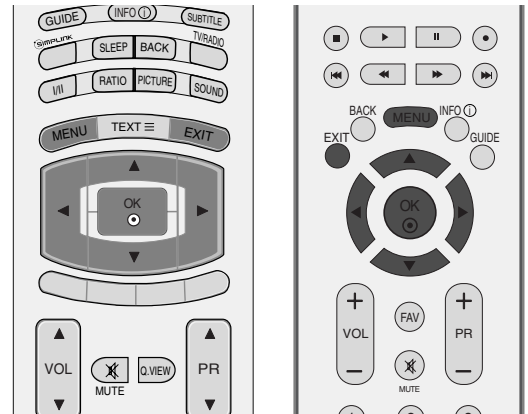

- 1 Press the **MENU** button and then **▲** or **▼** button to select the **AUDIO** menu.
- 2 Press the **▶** button and then **▲** or **▼** button to select **Auto Volume**.
- 3 Press the **▶** button and then **▲** or **▼** button to select **Off** or **On**.
- 4 Press the **EXIT** button to return to normal TV viewing.

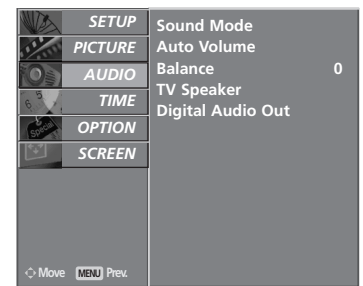

1

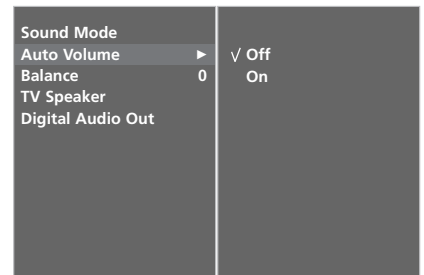

2 3

PRESET SOUND SETTINGS- SOUND MODE

You can select your preferred sound setting; Surround MAX, Standard, Music, Movie or Sports and you can also adjust the sound frequency of the equalizer.

Sound Mode lets you enjoy the best sound without any Special adjustment because the TV sets the appropriate sound options based on the programme content.

Surround MAX, Standard, Music, Movie, and Sports are preset for good sound quality at the factory and are not adjustable.

- Surround MAX** Select this option to sound realistic.
- Standard** The most commanding and natural audio.
- Music** Select this option to enjoy the original sound when listening to the music.
- Movie** Select this option to enjoy sublime sound.
- Sports** Select this option to watch sports broadcasting.
- User** Select this option to use the user-defined audio settings.

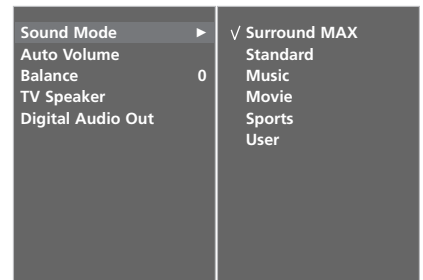
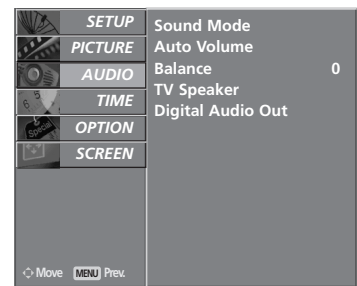
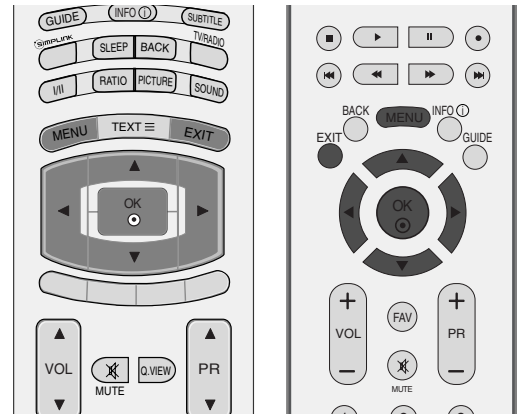

- 1 Press the **MENU** button and then **▲** or **▼** button to select the **AUDIO** menu.
- 2 Press the **▶** button and then **▲** or **▼** button to select **Sound Mode**.
- 3 Press the **▶** button and then **▲** or **▼** button to select **Surround MAX, Standard, Music, Movie, Sports** or **User**.
- 4 Press the **EXIT** button to return to normal TV viewing.

2 3

SOUND & LANGUAGE CONTROL

SOUND SETTING ADJUSTMENT -USER MODE

Adjust the sound equalizer.

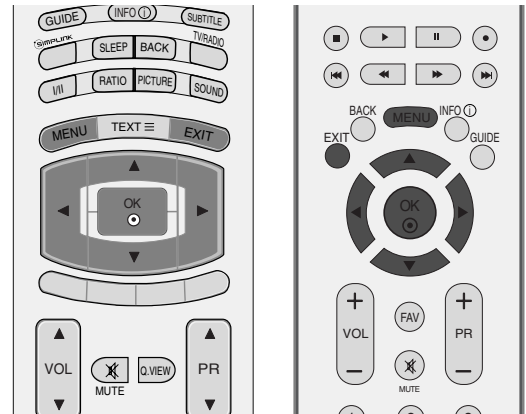

- 1 Press the **MENU** button and then ▲ or ▼ button to select the **AUDIO** menu.

- 2 Press the ► button and then ▲ or ▼ button to select **Sound Mode**.

- 3 Press the ► button and then ▲ or ▼ button to select **User**.

- 4 Press the ► button.

- 5 Select a sound band by pressing the ◀ or ▶ button. Make appropriate sound level with the ▲ or ▼ button.

- 6 Press the **EXIT** button to return to normal TV viewing.

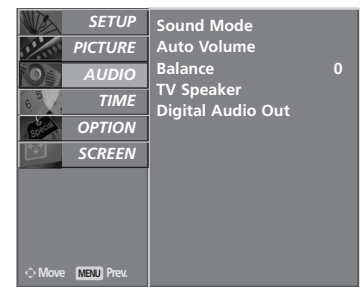

1

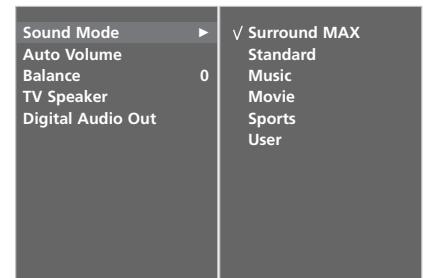

2 3



4 5

BALANCE

You can adjust the sound balance of speaker to the levels you prefer.

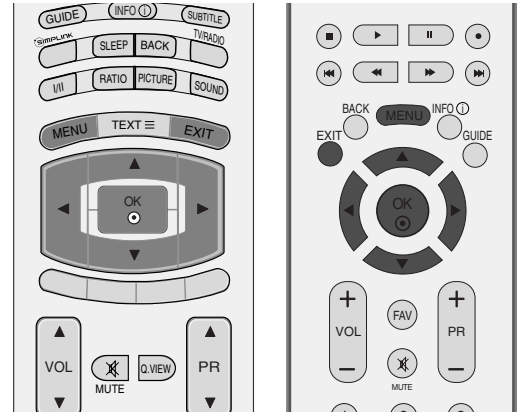

- 1 Press the **MENU** button and then **▲** or **▼** button to select the **AUDIO** menu.
- 2 Press the **▶** button and then **▲** or **▼** button to select **Balance**.
- 3 Press the **▶** button and then **◀** or **▶** button to make desired adjustment.
- 4 Press the **EXIT** button to return to normal TV viewing.

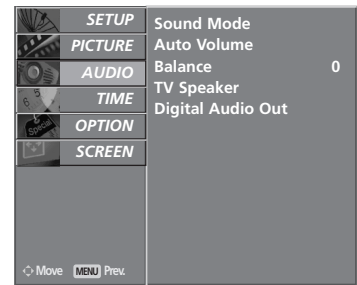

1

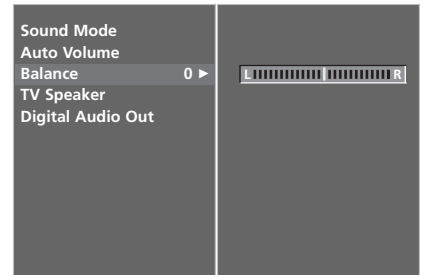

2 3

SOUND & LANGUAGE CONTROL

TV SPEAKERS ON/ OFF SETUP

You can adjust the internal speaker status.

In **AV1, AV2, AV3, COMPONENT, RGB** and **HDMI1** with HDMI to DVI cable, TV speaker can be outputted even though there is no video signal.

If you want to use your external hi-fi stereo system, turn off the internal speakers of the set.

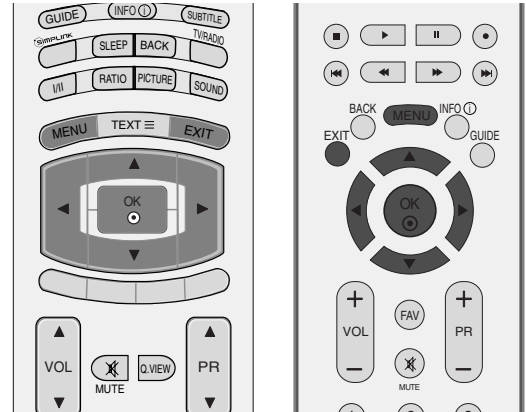

- 1 Press the **MENU** button and then **▲** or **▼** button to select the **AUDIO** menu.
- 2 Press the **▶** button and then **▲** or **▼** button to select **TV Speaker**.
- 3 Press the **▶** button and then **▲** or **▼** button to select **Off** or **On**.
- 4 Press the **EXIT** button to return to normal TV viewing.

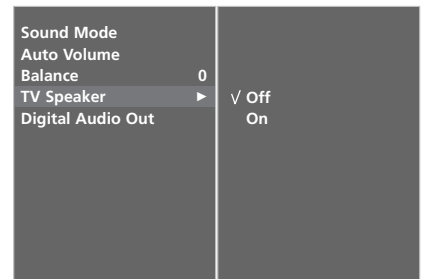
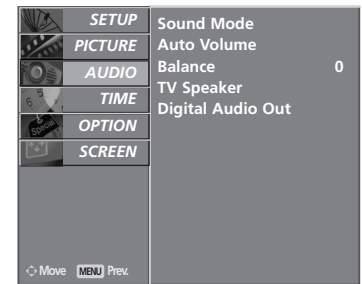

3

SELECTING DIGITAL AUDIO OUT

This function lets you select your preferred Digital Audio Output. The set can output Dolby Digital in a channel only which broadcast Dolby Digital Audio.

When it's applied the Dolby Digital format, if you select Dolby Digital on Digital audio out menu, SPDIF Output will be outputted Dolby Digital.

Even if it's selected Dolby Digital, when it doesn't apply Dolby Digital format, SPDIF Output will be outputted PCM. Even if both Dolby Digital and Audio language have been set in a channel which broadcast Dolby Digital Audio, only Dolby Digital will be played.

This function is not displayed in the Analog mode.



Manufactured under license from Dolby Laboratories. "Dolby" and the double-D symbol are trademarks of Dolby Laboratories.

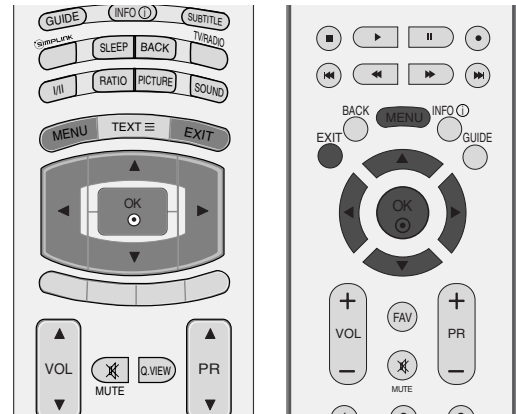

- 1 Press the **MENU** button and then **▲** or **▼** button to select the **AUDIO** menu.
- 2 Press the **▶** button and then **▲** or **▼** button to select **Digital Audio Out**.
- 3 Press the **▶** button and then **▲** or **▼** button to select **Dolby Digital** or **PCM**.
- 4 Press the **EXIT** button to return to normal TV viewing.

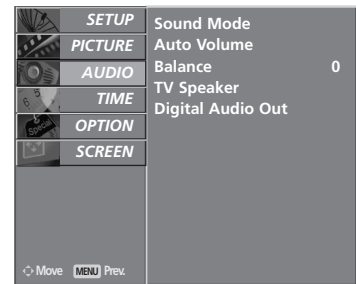

1

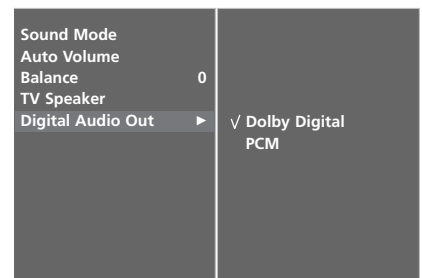

2 3

SOUND & LANGUAGE CONTROL

I/II

Stereo/Dual Reception (In Analogue Mode Only)

When a programme is selected, the sound information for the station appears after the programme number and station name disappear.

Broadcast	On Screen Display
Mono	MONO
Stereo	STEREO
Dual	DUAL I

■ Mono sound selection

If the stereo signal is weak in stereo reception, you can switch to mono by pressing the I/II button twice. In mono reception, the depth of sound is improved. To switch back to stereo, press the I/II button twice again.

■ Language selection for dual language broadcast

If a programme received two languages (dual language), you can switch to **DUAL I**, **DUAL II** or **DUAL I+II** by pressing the I/II button repeatedly.

DUAL I Sends the primary broadcast language to the loudspeakers.

DUAL II Sends the secondary broadcast language to the loudspeakers.

DUAL I+II Sends a separate language to each loudspeaker.

NICAM Reception (In Analogue Mode Only)

If the set is equipped with the receiver for NICAM reception, the high quality NICAM (Near Instantaneous Companding Audio Multiplex) digital sound can be received.

Sound output can be selected according to the type of received broadcast as follows by pressing the I/II button repeatedly.

-
- 1 When **NICAM mono** is received, you can select **NICAM MONO** or **FM MONO**.
-
- 2 When **NICAM stereo** is received, you can select **NICAM STEREO** or **FM MONO**.
If the stereo signal is weak, switch to **FM mono**.
-
- 3 When **NICAM dual** is received, you can select **NICAM DUAL I**, **NICAM DUAL II** or **NICAM DUAL I+II** or **MONO**.
-

Speaker Sound Output Selection

In AV, S-Video, Component, RGB and HDMI mode, you can select output sound for the left and right loudspeakers.

Repeatedly press the I/II button to select the sound output.

L+R: Audio signal from audio L input is sent to the left loud speaker and audio signal from audio R input is sent to the right loud speaker.

L+L: Audio signal from audio L input is sent to left and right loud speakers.

R+R: Audio signal from audio R input is sent to left and right loud speakers.

SOUND & LANGUAGE CONTROL

ON-SCREEN MENU LANGUAGE / COUNTRY SELECTION

Installation guide menu appears on TV screen when it is turned on for the first time.

1 Press the ▲ or ▼ or ◀ or ▶ button and then, OK button to select your desired language.

2 Press the ▲ or ▼ button and then, OK button to select your country.

* If you want to change Language/ Country selection

1 Press the **MENU** button and then use ▲ or ▼ button to select the **OPTION** menu.

2 Press the ▶ button and then use ▲ or ▼ button to select **Language**. The menus can be shown on the screen in the selected language.
Or, Press the ▶ button and then use ▲ or ▼ button to select **Country**.

3 Press the ▶ button and then use ◀ or ▶ button to select your desired language or country.

4 Press the OK button.

5 Press the **EXIT** button to return to normal TV viewing.

! NOTE

- ▶ If you don't finish set up **Installation Guide** by pressing **EXIT** button or time out of OSD (On Screen Display) display, it will continuously appear until completing set up whenever the set is turned on.
- ▶ If you select wrong local country, the teletext may not appear correctly on the screen and some problem may happen during teletext operation.
- ▶ CI (Common Interface) function may not be applied based on country broadcasting circumstance.
- ▶ DTV mode control buttons may not be working based on country broadcasting circumstance.

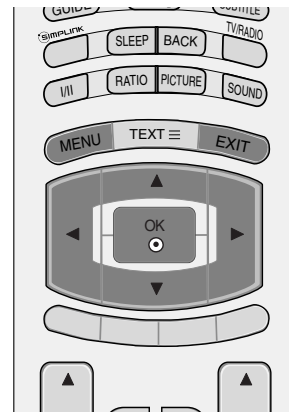

LANGUAGE SELECTION (IN DIGITAL MODE ONLY)

Audio function lets you select your preferred language for audio. If the audio data in selected language is not broadcasted, default language audio will be played.

Use **Subtitle** function when two or more subtitle languages are broadcasted. If the subtitle data in selected language is not broadcasted, default language subtitle will be displayed.

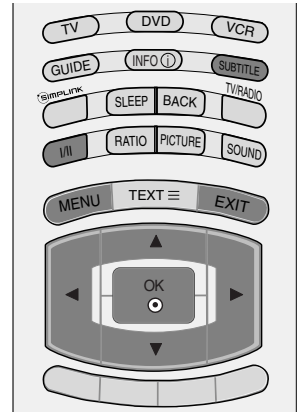

- 1 Press the **MENU** button and then use ▲ or ▼ button to select the **OPTION** menu.
- 2 Press the ► button and then use ▲ or ▼ button to select **Language**.
- 3 Press the ► button and then use ▲ or ▼ button to select **Audio, Subtitle or Subtitle Hard of hearing**.
- 4 Press the ► button and then use ◀ or ▶ button to select your desired language.
- 5 Press the **EXIT** button to return to normal TV viewing.

! NOTE

< Audio Language Selection >

- ▶ When two or more audio languages are broadcasted, you can select audio language with the I/II button on the remote control.
- ▶ Press the ▲ or ▼ button to select an audio language.
- ▶ Press the ◀ or ▶ button to select L+R, L+L or R+R.

< Subtitle Language Selection >

- ▶ When two or more subtitle languages are broadcasted, you can select subtitle language with the **SUBTITLE** button on the remote control.
- ▶ Press the ▲ or ▼ button to select a subtitle language.

- The audio/subtitle can be displayed simpler form with 1 to 3 characters which is broadcast by service provider.
- When you select supplementary Audio (Audio for “Visual/Hearing Impaired”) it may speak out a part of Main audio.

Audio Language OSD Information

Display	Status
N.A	Not Available
MPEG	MPEG Audio
Dolby Digital	Dolby Digital Audio
Visual Impaired	Audio for “Visual Impaired”
Hearing Impaired	Audio for “Hearing Impaired”

Subtitle Language OSD Information

Display	Status
N.A	Not Available
TEXT	Teletext Subtitle
Hearing Impaired	Subtitle for “Hard of Hearing”

TIME SETTING

CLOCK SETUP

The clock is set automatically when receiving the digital signal. (You can set the clock if the TV has no DTV signal.) You must set to the time correctly before using on/off time function.

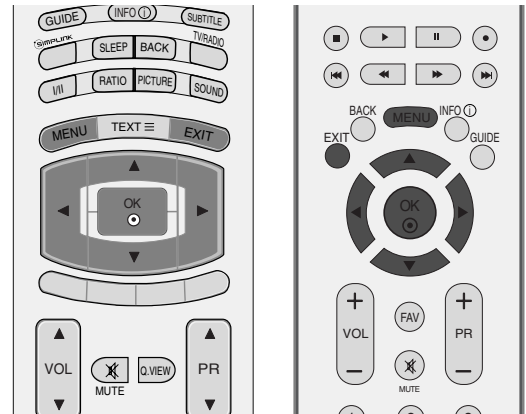

- 1 Press the **MENU** button and then **▲** or **▼** button to select the **TIME** menu.
- 2 Press the **▶** button and then **▲** or **▼** button to select **Clock**.
- 3 Press the **▶** button and then **◀** or **▶** button to select either the year, date, or time option.

Once selected, use the **▲** or **▼** button to set the year, date, and time options.

- 4 Press the **EXIT** button to return to normal TV viewing.

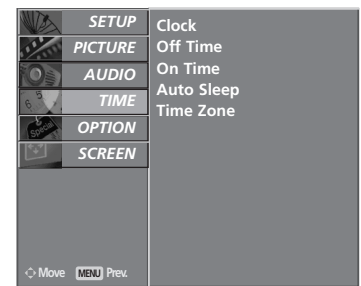

1

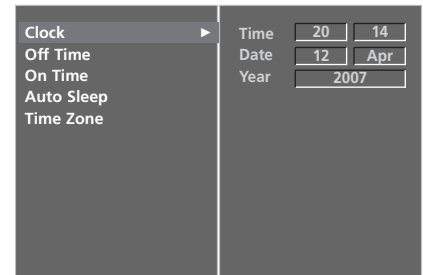

2 3

AUTO ON/OFF TIMER SETTING

The Off time automatically switches the set to standby at the preset time.

Two hours after the set is switched on by the on time function it will automatically switch back to standby mode unless a button has been pressed.

Once the on time/off time is set, these functions operate daily at the preset time.

Off time function overrides On timer function if they are set both to the same time.

The set must be in standby mode for the On timer to work.

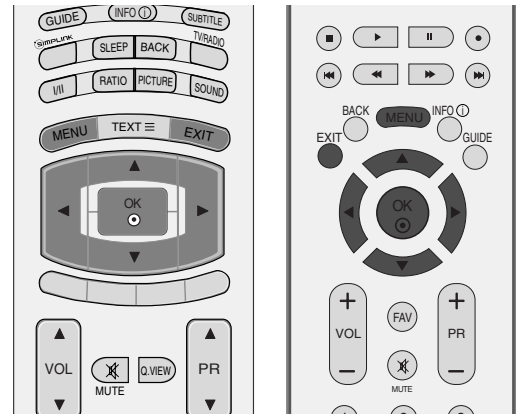

1 Press the **MENU** button and then **▲** or **▼** button to select the **TIME** menu.

2 Press the **▶** button and then **▲** or **▼** button to select **Off time/On Time**.

3 Press the **▶** button and then **▲** or **▼** button to select **On**.

- To cancel **On/Off Time** function, select **Off**.

4 Press the **▶** button and then **▲** or **▼** button to set the hour.

5 Press the **▶** button and then **▲** or **▼** button to set the minutes.

6 For only On time function

- **Programme:** Press the **▶** button and then **▲** or **▼** button to select **TV**, **DTV** or **Radio** in the **Mode** menu. And then, Press the **▶** button and then **▲** or **▼** button to select the programme.

- **Volume:** Press the **▶** button and then **▲** or **▼** button to adjust volume level at turn-on.

7 Press the **EXIT** button to return to normal TV viewing.

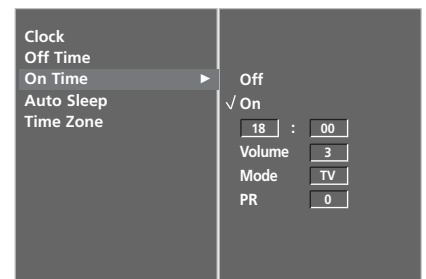
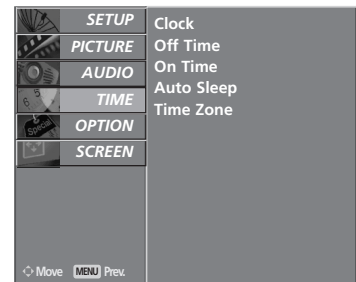

TIME SETTING

AUTO SHUT-OFF SETTING

If set to on and there is no input signal, the set turns off automatically after 10 minutes.

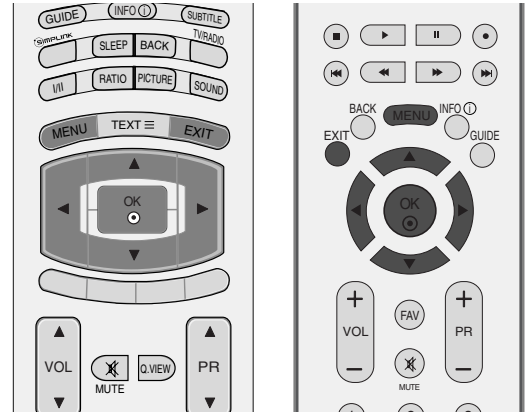

- 1 Press the **MENU** button and then **▲** or **▼** button to select the **TIME** menu.
- 2 Press the **▶** button and then **▲** or **▼** button to select **Auto Sleep**.
- 3 Press the **▶** button and then **▲** or **▼** button to select **Off** or **On**.
- 4 Press the **EXIT** button to return to normal TV viewing.

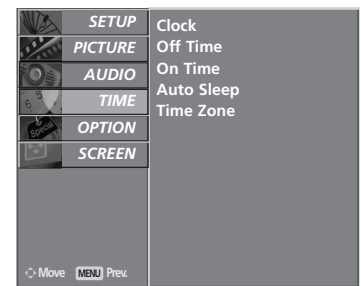

1

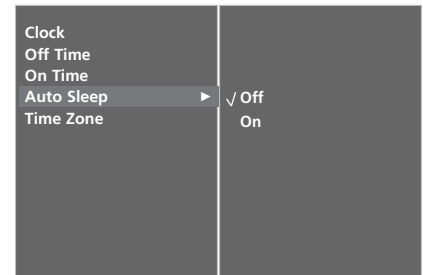

2 3

TIME ZONE SETUP

When you select a Time Zone city, TV time is set by the time offset information based on Time Zone and GMT (Greenwich Mean Time) information which is received to broadcasting signal when time is set automatically by a digital signal.

- 1 Press the **MENU** button and then **▲** or **▼** button to select the **TIME** menu.
- 2 Press the **▶** button and then **▲** or **▼** button to select **Time Zone**.
- 3 Press the **▶** button and then **◀** or **▶** button to select your viewing area time zone.
- 4 Press the **EXIT** button to return to normal TV viewing.

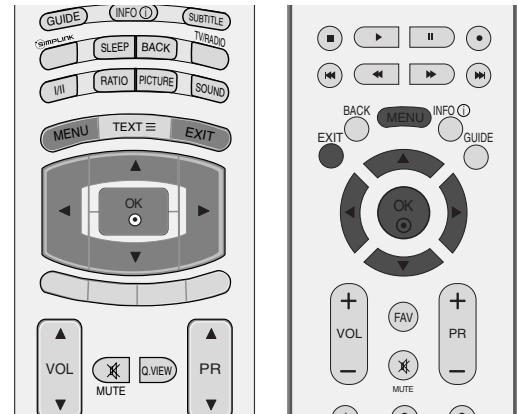

1

SLEEP TIMER SETTING

You don't have to remember to switch the set off before you go to sleep. The sleep timer automatically switches the set to standby after the preset time has elapsed.

- a Press the **SLEEP** button repeatedly to select the number of minutes.
The display ' - - - Min. ' will appear on the screen, followed by **10, 20, 30, 60, 90, 120, 180** and **240**.
- b When the number of minutes you want is displayed on the screen, the timer begins to count down from the number of minutes selected.
- c To view the remaining sleep time, press the **SLEEP** button once.
- d To cancel the sleep time, repeatedly press the **SLEEP** button until the display ' - - - Min. ' appears.
- e When you switch the set off, the set releases the pre-set sleep time.



2 3

PARENTAL CONTROL / RATINGS

SET PASSWORD & LOCK SYSTEM

If you first enter the password, press '0', '0', '0', '0' on the remote control handset.

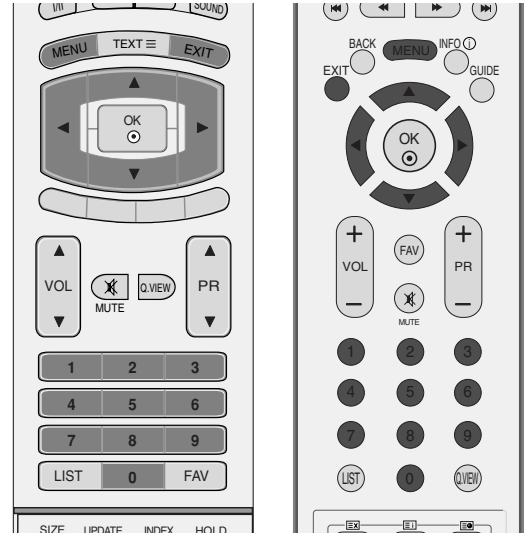

- 1 Press the **MENU** button and then **▲** or **▼** button to select the **OPTION** menu.
- 2 Press the **▶** button and then **▲** or **▼** button to select **Lock System**.
- 3 Press the **▶** button and then **◀** or **▶** button to select **On**.

To set the password

Press the **▶** button and then use **NUMBER** buttons to input a 4-digit password.

Be sure to remember this number!

Re-enter new password for confirm.

If you forgot your password, press '7', '7', '7', '7' on the remote control handset.

- 4 Press the **EXIT** button to return to normal TV viewing.

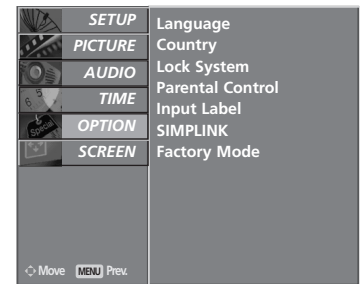

1

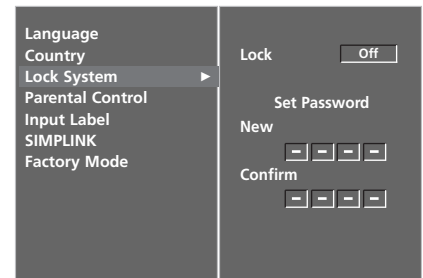

2 3

PARENTAL CONTROL

This function operates according to information from the broadcasting station. Therefore if the signal has wrong information, this function does not operate.

Lets you set up blocking schemes to block specific channels, ratings, and external viewing sources.

A password is required to gain access to this menu.

This set is programmed to remember which option it was last set to even if you turn the set off.

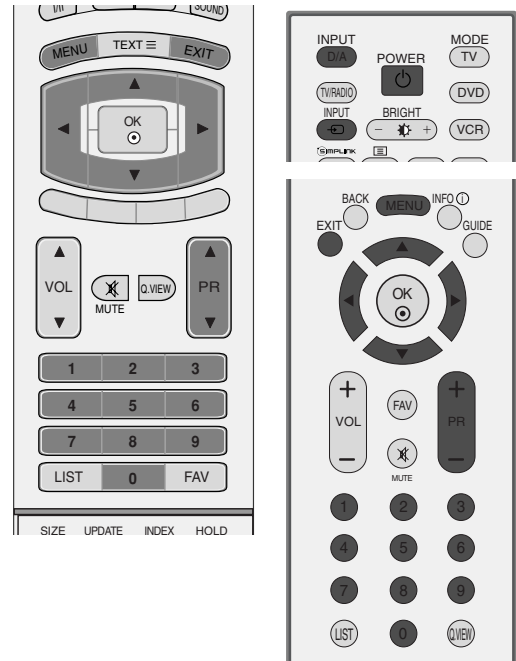

1 Press the **MENU** button and then **▲** or **▼** button to select the **OPTION** menu.

2 Press the **▶** button and then **▲** or **▼** button to select **Parental Control**. Then, press the **▶** button to enter the password as requested. The TV is set up with the initial password "0-0-0-0".

3 Press the **▶** button and then **▲** or **▼** button to select **Parental Guidance** or **Key Lock**.

Parental Guidance (In Digital mode only)
Prevents children from watching certain adult's TV programmes, according to the ratings limit set.

Key Lock
The set can be set so that the remote control is needed to control it. This feature can be used to prevent unauthorized viewing.

4 Press the **◀** or **▶** button to make appropriate adjustments.

5 Press the **EXIT** button to return to normal TV viewing.

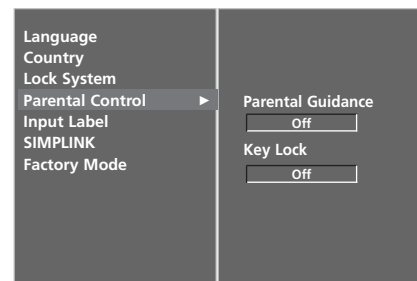
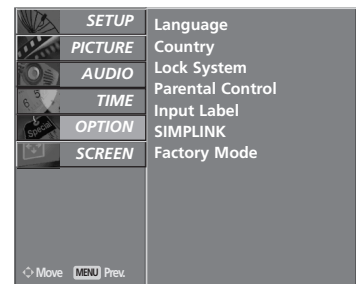

3 **4**

In **Key Lock 'On'**, if the set is turned off, press the **⏻ / I**, **INPUT**, **PR ▲** or **▼** button on the set or **POWER**, **INPUT**, **D/A**, **PR ▲** or **▼** (or **PR +** or **-**) or **NUMBER** buttons on the remote control.

With the **Key Lock On**, the display '**Key Lock On**' appears on the screen if any button on the front panel is pressed while viewing the set.

TELETEXT

This feature is not available in all countries.

Teletext is a free service broadcast by most TV stations which gives up-to-the-minute information on news, weather, television programmes, share prices and many other topics.

The teletext decoder of this TV can support the SIMPLE, TOP and FASTEXT systems. SIMPLE (standard teletext) consists of a number of pages which are selected by directly entering the corresponding page number. TOP and FASTEXT are more modern methods allowing quick and easy selection of teletext information.

SWITCH ON/OFF

Press the **TEXT** button to switch to teletext. The initial page or last page appears on the screen.

Two page numbers, TV station name, date and time are displayed on the screen headline. The first page number indicates your selection, while the second shows the current page displayed.

Press the **TEXT** or **EXIT** button to switch off teletext. The previous mode reappears.

SIMPLE TEXT

■ Page selection

- 1 Enter the desired page number as a three digit number with the NUMBER buttons. If during selection you press a wrong number, you must complete the three digit number and then re-enter the correct page number.
- 2 The **PR ▲** or **▼** (or **PR +** or **-**) button can be used to select the preceding or following page.

TOP TEXT

The user guide displays four fields-red, green, yellow and blue at the bottom of the screen. The yellow field denotes the next group and the blue field indicates the next block.

■ Block / group / page selection

- 1 With the blue button you can progress from block to block.
- 2 Use the yellow button to proceed to the next group with automatic overflow to the next block.
- 3 With the green button you can proceed to the next existing page with automatic overflow to the next group. Alternatively the **PR ▲** (or **PR +**) button can be used.
- 4 The red button permits to return to previous selection. Alternatively the **PR ▼** (or **PR -**) button can be used.

■ Direct page selection

Corresponding to the SIMPLE teletext mode, you can select a page by entering it as a three digit number using the NUMBER buttons in TOP mode.

FASTEXT

The teletext pages are colour coded along the bottom of the screen and are selected by pressing the corresponding coloured button.

■ Page selection

- 1 Press the  button to select the index page.
- 2 You can select the pages which are colour coded along the bottom line with the same coloured buttons.
- 3 Corresponding to the SIMPLE teletext mode, you can select a page by entering its three digit page number with the NUMBER buttons in FASTEXT mode.
- 4 The PR ▲ or ▼ (or PR + or -) button can be used to select the preceding or following page.

SPECIAL TELETEXT FUNCTIONS



■ REVEAL

Press this button to display concealed information, such as solutions of riddles or puzzles.
Press this button again to remove the information from the display.



■ UPDATE

Displays the TV picture on the screen while waiting for the new teletext page. The display will appear at the top left hand corner of the screen. When the updated page is available then display will change to the page number.
Press this button to view the updated teletext page.



■ TIME

When viewing a TV programme, press this button to display the time at the top right hand corner of the screen. Press this button again to remove the display. In the teletext mode, press this button to select a sub page number. The sub page number is displayed at the bottom of the screen. To hold or change the sub page, press the RED/GREEN, PR ▲ or ▼ (or PR + or -) or NUMBER buttons.
Press again to exit this function.



■ HOLD

Stops the automatic page change which will occur if a teletext page consists of 2 or more sub pages. The number of sub pages and the sub page displayed is, usually, shown on the screen below the time. When this button is pressed the stop symbol is displayed at the top left-hand corner of the screen and the automatic page change is inhibited. To continue press this button again.

DIGITAL TELETEXT

*This function works in UK only.

The set gives you access to a digital teletext which is greatly improved in various aspects such as text, graphics and so on.

This digital teletext can be accessed by special digital teletext services and specific services which broadcast digital teletext.

You should select off from the subtitle language to display teletext by pressing **SUBTITLE** button.

TELETEXT WITHIN DIGITAL SERVICE

- 1 Press the numeric or **PR ▲** or **▼** (or **PR +** or **-**) button to select a digital service which broadcasts digital teletext. To know which are digital teletext services, refer to the EPG service list.
- 2 Follow the indications on digital teletext and move onto the next step by pressing **TEXT**, **OK**, **▲** or **▼**, **◀** or **▶**, **RED**, **GREEN**, **YELLOW**, **BLUE** or **NUMBER** buttons and so on.
- 3 To change digital teletext service, just select a different service by the numeric or **PR ▲** or **▼** (or **PR +** or **-**) button.

If pressing the **MENU**, **GUIDE** or **INFO ⓘ** button, the teletext service disappear temporarily. When pressing these buttons again, the teletext service is appeared.



TELETEXT IN DIGITAL SERVICE

- 1 Press the numeric or **PR ▲** or **▼** (or **PR +** or **-**) button to select a certain service which broadcasts digital teletext.
- 2 Press the **TEXT** or colour button to switch on teletext.
- 3 Follow the indications on digital teletext and move onto the next step by pressing **OK**, **▲** or **▼**, **◀** or **▶**, **RED**, **GREEN**, **YELLOW**, **BLUE** or **NUMBER** buttons and so on.
- 4 Press the **TEXT** or colour button to switch off digital teletext and return to TV viewing.

Some services may allow you to access text services by pressing the **RED** button.

If pressing the **MENU**, **GUIDE** or **INFO ⓘ** button, the teletext service disappear temporarily. When pressing these buttons again, the teletext service is appeared.



APPENDIX

TROUBLESHOOTING

The operation does not work normally.

The remote control doesn't work	<ul style="list-style-type: none">■ Check to see if there is any object between the product and the remote control causing obstruction. Ensure you are pointing the remote control directly at the TV.■ Ensure that the batteries are installed with correct polarity (+ to +, - to -).■ Ensure that the correct remote operating mode is set: TV, VCR etc.■ Install new batteries.
Power is suddenly turned off	<ul style="list-style-type: none">■ Is the sleep timer set?■ Check the power control settings. Power interrupted.■ No broadcast on station tuned with Auto sleep activated.

The video function does not work.

No picture & No sound	<ul style="list-style-type: none">■ Check whether the product is turned on.■ Try another channel. The problem may be with the broadcast.■ Is the power cord inserted into wall power outlet?■ Check your antenna direction and/or location.■ Test the wall power outlet, plug another product's power cord into the outlet where the product's power cord was plugged in.
Picture appears slowly after switching on	<ul style="list-style-type: none">■ This is normal, the image is muted during the product startup process. Please contact your service centre, if the picture has not appeared after five minutes.
No or poor colour or poor picture	<ul style="list-style-type: none">■ Adjust Colour in menu option.■ Keep a sufficient distance between the product and the VCR.■ Try another channel. The problem may be with the broadcast.■ Are the video cables installed properly?■ Activate any function to restore the brightness of the picture.
Horizontal/vertical bars or picture shaking	<ul style="list-style-type: none">■ Check for local interference such as an electrical appliance or power tool.
Poor reception on some channels	<ul style="list-style-type: none">■ Station or cable product experiencing problems, tune to another station.■ Station signal is weak, reorient antenna to receive weaker station.■ Check for sources of possible interference.
Lines or streaks in pictures	<ul style="list-style-type: none">■ Check antenna (Change the direction of the antenna).

APPENDIX

The audio function does not work.

Picture OK & No sound	<ul style="list-style-type: none">■ Press the VOL button.■ Sound muted? Press MUTE button.■ Try another channel. The problem may be with the broadcast.■ Are the audio cables installed properly?
No output from one of the speakers	<ul style="list-style-type: none">■ Adjust Balance in menu option.
Unusual sound from inside the product	<ul style="list-style-type: none">■ A change in ambient humidity or temperature may result in an unusual noise when the product is turned on or off and does not indicate a fault with the product.

There is a problem in PC mode. (Only PC mode applied)

The signal is out of range (Invalid format)	<ul style="list-style-type: none">■ Adjust resolution, horizontal frequency, or vertical frequency.■ Check the input source.
Vertical bar or stripe on background & Horizontal Noise & Incorrect position	<ul style="list-style-type: none">■ Work the Auto configure or adjust clock, phase, or H/V position. (Option)
Screen colour is unstable or single colour	<ul style="list-style-type: none">■ Check the signal cable.■ Reinstall the PC video card.

MAINTENANCE

Early malfunctions can be prevented. Careful and regular cleaning can extend the amount of time you can enjoy your new TV.

Caution: Be sure to turn the power off and unplug the power cord before you begin any cleaning.

Cleaning the Screen

- 1 Here's a great way to keep the dust off your screen for a while. Wet a soft cloth in a mixture of lukewarm water and a little fabric softener or dish washing detergent. Wring the cloth until it's almost dry, and then use it to wipe the screen.
- 2 Make sure the excess water is off the screen, and then let it air-dry before you turn on your TV.

Cleaning the Cabinet

- To remove dirt or dust, wipe the cabinet with a soft, dry, lint-free cloth.
- Please be sure not to use a wet cloth.

Extended Absence

CAUTION

- ▶ If you expect to leave your TV dormant for a long time (such as a vacation), it's a good idea to unplug the power cord to protect against possible damage from lightning or power surges.

APPENDIX

PRODUCT SPECIFICATIONS

MODELS		37LF6*	42LF6*	47LF6*	52LF6*
		37LF65-ZC 37LF66-ZE	42LF65-ZC 42LF66-ZE	47LF65-ZC 47LF66-ZE	52LF65-ZC 52LF66-ZE
Dimensions (Width x Height x Depth)	with stand	9270 x 692.8 x 280.5 mm 36.5 x 27.3 x 11.0 inches	1033.1 x 750.0 x 300.0 mm 40.7 x 29.6 x 11.9 inches	1144.5 x 825.6 x 331.0 mm 45.1 x 32.5 x 13.1 inches	1032.7 x 750.0 x 287.6 mm 40.7 x 29.5 x 11.3 inches
	without stand	9270 x 630.0 x 88.0 mm 36.5 x 24.8 x 3.5 inches	1033.1 x 686.5 x 88.5 mm 40.7 x 27.1 x 3.5 inches	1144.5 x 754.9 x 103.0 mm 45.1 x 29.8 x 4.1 inches	1032.7 x 685.5 x 88.5 mm 40.7 x 27.0 x 3.5 inches
Weight	with stand	20.0 kg / 44.0 lbs	27.5 kg / 60.7 lbs	37.46 kg / 82.6 lbs	24.5 kg / 54.0 lbs
	without stand	16.0 kg / 35.3 lbs	23.0 kg / 50.8 lbs	31.4 kg / 69.3 lbs	20 kg / 44.1 lbs
Power requirement Power Consumption		AC100-240V~ 50/60Hz 1.8A 180W	AC100-240V~ 50/60Hz 2.5A 240W	AC100-240V~ 50/60Hz 3.2A 310W	AC100-240V~ 50/60Hz 3.5A 350W
MODELS		37LY9*	42LY9*	47LY9*	52LY9*
		37LY95-ZA 37LY96-ZB	42LY95-ZA 42LY96-ZB 42LY99-ZC	47LY95-ZA 47LY96-ZB	52LY95-ZA 52LY96-ZB
Dimensions (Width x Height x Depth)	with stand	1005.0 x 653.0 x 267.0 mm 39.6 x 25.8 x 10.6 inches	1113.3 x 722.5 x 294.3 mm 43.9 x 28.5 x 11.6 inches	1236.8 x 795.5 x 325.6 mm 48.7 x 31.4 x 12.9 inches	1033.1 x 749.5 x 287.6 mm 40.7 x 29.5 x 11.3 inches
	without stand	1005.0 x 594.4 x 88.0 mm 39.6 x 23.5 x 3.5 inches	1113.3 x 656.5 x 88.5 mm 43.9 x 25.9 x 3.5 inches	1236.8 x 725.4 x 103.0 mm 48.7 x 28.6 x 4.1 inches	1033.4 x 686.8 x 88.5 mm 40.7 x 27.0 x 3.5 inches
Weight	with stand	23.0 kg / 50.8 lbs	30.5 kg / 67.3 lbs	39.5 kg / 87.1 lbs	24.5 kg / 54.1 lbs
	without stand	18.8 kg / 41.5 lbs	24.3 kg / 53.6 lbs	33.0 kg / 72.8 lbs	20.4 kg / 45.0 lbs
Power requirement Power Consumption		AC100-240V~ 50/60Hz 1.8A 180W	AC100-240V~ 50/60Hz 2.6A 260W	AC100-240V~ 50/60Hz 3.2A 310W	AC100-240V~ 50/60Hz 3.5A 350W
Television System Program Coverage External Antenna Impedance		PAL/SECAM B/G/D/K, PAL I/II, SECAM L/L' VHF: E2 ~ E12, UHF: E21 ~ E69, CATV: S1 ~ S20, HYPER: S21 ~ S47 75 Ω			
Environment condition	Operating Temperature Operating Humidity	0 ~ 40°C / 32 ~ 104°F Less than 80%			
	Storage Temperature Storage Humidity	-20 ~ 60°C / -4 ~ 140°F Less than 85%			

■ The specifications shown above may be changed without prior notice for quality improvement.

MODELS		50PF9*	50PF9*	60PF9*
		50PF95-ZA 50PF96-ZB	50PF95-ZJ	60PF95-ZA 60PF95-ZJ 60PF96-ZB
Dimensions (Width x Height x Depth)	with stand	1360 x 889 x 370 mm 53.5 x 35 x 14.5 inches	1360 x 889 x 370 mm 53.5 x 35 x 14.5 inches	1613.6 x 1036.8 x 452.0 mm 63.5 x 40.9 x 17.8 inches
	without stand	1360 x 822.5 x 95.5 mm 53.5 x 32.3 x 3.7 inches	1360 x 822.5 x 95.5 mm 53.5 x 32.3 x 3.7 inches	1613.6 x 970.0 x 98.5 mm 63.5 x 38.2 x 3.9 inches
Weight	with stand	57.5 kg / 126.7 lbs	57.5 kg / 126.7 lbs	81.0 kg / 178.6 lbs
	without stand	48.5kg / 106.9 lbs	48.5kg / 106.9 lbs	65.0 kg / 143.3 lbs
Power requirement		AC100-240V~ 50/60Hz 4.5A	AC100-240V~ 50/60Hz 4.9A	AC100-240V~ 50/60Hz 6.5A
Power Consumption		450W	490W	650W
Television System		PAL/SECAM B/G/D/K, PAL I/II, SECAM L/L'		
Program Coverage		VHF: E2 ~ E12, UHF: E21 ~ E69, CATV: S1 ~ S20, HYPER: S21 ~ S47		
External Antenna Impedance		75 Ω		
Environment condition	Operating Temperature	0 ~ 40°C / 32 ~ 104°F		
	Operating Humidity	Less than 80%		
	Storage Temperature	-20 ~ 60°C / -4 ~ 140°F		
	Storage Humidity	Less than 85%		

MODELS		37LF7*	42LF7*
		37LF75-ZD 37LF76-ZB	42LF75-ZD 42LF76-ZB
Dimensions (Width x Height x Depth)	with stand	929.0 x 709.1 x 301.9 mm 36.6 x 27.9 x 11.9 inches	1030.8 x 779.8 x 333.2mm 40.58 x 30.7 x 13.1 inches
	without stand	929.0 x 633.3 x 88 mm 36.6 x 24.9 x 3.5 inches	1030.8 x 693 x 88.5 mm 40.58 x 27.28 x 3.48 inches
Weight	with stand	21.8 kg / 48.1 lbs	27.2 kg / 59.96 lbs
	without stand	18.6 kg / 41.0 lbs	23.3 kg / 51.3 lbs
Power requirement		AC100-240V~ 50/60Hz 1.8A	AC100-240V~ 50/60Hz 2.3A
Power Consumption		180W	230W
Television System		PAL/SECAM B/G/D/K, PAL I/II, SECAM L/L'	
Program Coverage		VHF: E2 ~ E12, UHF: E21 ~ E69, CATV: S1 ~ S20, HYPER: S21 ~ S47	
External Antenna Impedance		75 Ω	
Environment condition	Operating Temperature	0 ~ 40°C / 32 ~ 104°F	
	Operating Humidity	Less than 80%	
	Storage Temperature	-20 ~ 60°C / -4 ~ 140°F	
	Storage Humidity	Less than 85%	

■ The specifications shown above may be changed without prior notice for quality improvement.

PROGRAMMING THE REMOTE CONTROL

(Only 37/42/47/52LY9*, 50/60PF9*)

The remote is a multi-brand or a universal remote. It can be programmed to operate most remote-controllable devices of other manufacturers.

Note that the remote may not control all models of other brands.

-
- 1 To find out whether your remote can operate the device without programming, turn on the device such as a DVD or VCR and press the corresponding mode button on the remote.

.....
After that, press the **POWER** button. If the device is turned off then it responds properly and the remote need not to be programmed.

.....
If not, the remote should be programmed to operate the device. The programming procedures are explained below.

- 2 Press the **MENU** and **MUTE** button continuously at the same time for 2 seconds, the current selected device button will be illuminated.

.....
If you don't press any button for 20 seconds, the light on the mode button will be turned off. In that case, you have to repeat from step 2.

- 3 Enter code numbers using the number button on the remote by referring the code table on the following pages. When pressing the button, the light blinks at a time.

.....
If the device turned off, the programming is successful.

- 4 Press the **MENU** button to store the code. After blinking twice, this code is stored.

- 5 Test the remote functions to see if the device responds properly. If not, repeat from step 2.
-

■ VCRs

Brand	Codes	Brand	Codes	Brand	Codes	Brand	Codes
AIWA	034	KENWOOD	014 034 039 043	PORTLAND	108	TATUNG	039 043
AKAI	016 043 046 124 125 146		047 048	PULSAR	072	TEAC	034 039 043
AMPRO	072	LG (GOLDSTAR)	001 012 013 020 101 106 114 123	QUARTZ	011 014	TECHNICS	031 033 070
ANAM	031 033 103	LLOYD	034	QUASAR	033 066 075 145	TEKNIKA	019 031 033 034 101
AUDIO DYNAMICS	012 023 039 043	LXI	003 009 013 014 017 034 101 106	RCA	013 020 033 034 040 041 062 063 107 109 140 144 145 147	THOMAS	034
BROKSONIC	035 037 129	MAGIN	040	REALISTIC	003 008 010 014 031 033 034 040 053 054 101	TMK	006
CANON	028 031 033	MAGNAVOX	031 033 034 041 067 068	RICO	058	TOSHIBA	008 013 042 047 059 082 112 131
CAPEHART	108	MARANTZ	012 031 033 067 069	RUNCO	148	TOTEVISION	040 101
CRAIG	003 040 135	MARTA	101	SALORA	014	UNITECH	040
CURTIS MATHES	031 033 041	MATSUI	027 030	SAMSUNG	032 040 102 104 105 107 109 112 113 115 120 122 125	VECTOR RESEARCH	012
DAEWOO	005 007 010 064 065 108 110 111 112 116 117 119	MEI	031 033	SANSUI	022 043 048 135	VICTOR	048
DAYTRON	108	MEMOREX	003 010 014 031 033 034 053 072 101 102 134 139	SANYO	003 007 010 014 102 134	VIDEO CONCEPTS	012 034 046
DBX	012 023 039 043	MGA	045 046 059	SCOTT	017 037 112 129 131	VIDEOSONIC	040
DYNATECH	034 053	MINOLTA	013 020	SEARS	003 008 009 010 013 014 017 020 031 042 073 081 101	WARDS	003 013 017 024 031 033 034 040 053 054 131
ELECTROHOME	059	MITSUBISHI	013 020 045 046 049 051 059 061 151	SHARP	031 054 149	YAMAHA	012 034 039 043
EMERSON	006 017 025 027 029 031 034 035 036 037 046 101 129 131 138 153 003 008 009 010	MTC	034 040	SHINTOM	024	ZENITH	034 048 056 058 072 080 101
FISHER	034	MULTITECH	024 034	SONY	003 009 031 052 056 057 058 076 077 078 149		
FUNAI	031 033 063 072	NEC	012 023 039 043 048	SOUNDESIGN	034		
GE	107 109 144 147	NORDMENDE	043	STS	013		
GO VIDEO	132 136	OPTONICA	053 054	SYLVANIA	031 033 034 059 067		
HARMAN KARDON	012 045	PANASONIC	066 070 074 083 133 140 145	TANDY	010 034		
HITACHI	004 018 026 034 043 063 137 150	PENTAX	013 020 031 033 063				
INSTANTREPLAY	031 033	PHILCO	031 034 067				
JCL	031 033	PHILIPS	031 033 034 054 067 071 101				
JCPENNY	012 013 015 033 040 066 101	PILOT	101				
JENSEN	043	PIONEER	013 021 048				
JVC	012 031 033 043 048 050 055 060 130 150 152						

■ DVD

Brand	Codes	Brand	Codes	Brand	Codes	Brand	Codes
APEX DIGITAL	022	MAGNAVOX	013	PHILIPS	013	SONY	007
DENON	020 014	MARANTZ	024	PIONEER	004 026	THOMPSON	005 006
GE	005 006	MITSUBISHI	002	PROCEED	021	TOSHIBA	019 008
HARMAN KARDON	027	NAD	023	PROSCAN	005 006	YAMAHA	009 018
JVC	012	ONKYO	008 017	RCA	005 006	ZENITH	010 016 025
LG	001 010 016 025	PANASONIC	003 009	SAMSUNG	011 015		

APPENDIX

PROGRAMMING THE REMOTE CONTROL

(Only 37/42/47/52LF6*,37/42LF7*)

The remote is a multi-brand or a universal remote. It can be programmed to operate most remote-controllable devices of other manufacturers.

Note that the remote may not control all models of other brands.

Programming a code into a remote mode

- 1 Test your remote control.
To find out whether your remote control can operate the component without programming, turn on the component such as a VCR and press the corresponding mode button (such as a **DVD** or **VCR**) on the remote control, while pointing at the component. Test the **POWER** and **PR + / -** buttons to see if the component responds properly. If not, the remote requires programming to operate the device.
- 2 Turn on the component to be programmed, then press the corresponding mode button (such as a **DVD** or **VCR**) on the remote control. The remote control button of desired device is lighted.
- 3 Press the **MENU** and **MUTE** buttons simultaneously, the remote control is ready to be programmed for the code.
- 4 Enter a code number using the number buttons on the remote control. Programming code numbers for the corresponding component can be found on the following pages. Again, if the code is correct, the device will turn off.
- 5 Press the **MENU** button to store the code.
- 6 Test the remote control functions to see if the component responds properly. If not, repeat from step 2.

DVD

Brand	Codes	Brand	Codes	Brand	Codes
APEX DIGITAL	022	mitsubishi	002	RCA	005 006
DENON	020 014	NAD	023	SAMSUNG	011 015
GE	005 006	ONKYO	008 017	SONY	007
HARMAN KARDON	027	PANASONIC	003 009	THOMPSON	005 006
JVC	012	PHILIPS	013	TOSHIBA	019 008
LG	001 010 016 025	PIONEER	004 026	YAMAHA	009 018
MAGNAVOX	013	PROCEED	021	ZENITH	010 016 025
MARANTZ	024	PROSCAN	005 006		

VCR

Brand	Codes	Brand	Codes	Brand	Codes
AIWA	034	MAGNAVOX	031 033 034 041	SAMSUNG	032 040 102 104
AKAI	016 043 046 124		067 068		105 107 109 112
	125 146	MARANTZ	012 031 033 067		113 115 120 122
AMPRO	072		069		125
ANAM	031 033 103	MARTA	101	SANSUI	022 043 048 135
AUDIO DYNAMICS	012 023 039 043	MATSUI	027 030	SANYO	003 007 010 014
BROKSONIC	035 037 129	MEI	031 033		102 134
CANON	028 031 033	MEMOREX	003 010 014 031	SCOTT	017 037 112 129
CAPEHART	108		033 034 053 072		131
CRAIG	003 040 135		101 102 134 139	SEARS	003 008 009 010
CURTIS MATHES	031 033 041	MGA	045 046 059		013 014 017 020
DAEWOO	005 007 010 064	MINOLTA	013 020		031 042 073 081
	065 108 110 111	MITSUBISHI	013 020 045 046		101
	112 116 117 119		049 051 059 061	SHARP	031 054 149
DAYTRON	108		151	SHINTOM	024
DBX	012 023 039 043	MTC	034 040	SONY	003 009 031 052
DYNATECH	034 053	MULTITECH	024 034		056 057 058 076
ELECTROHOME	059	NEC	012 023 039 043		077 078 149
EMERSON	006 017 025 027		048	SOUNDESIGN	034
	029 031 034 035	NORDMENDE	043	STS	013
	036 037 046 101	OPTONICA	053 054	SYLVANIA	031 033 034 059
	129 131 138 153	PANASONIC	066 070 074 083		067
FISHER	003 008 009 010		133 140 145	SYMPHONIC	034
FUNAI	034			TANDY	010 034
GE	031 033 063 072	PENTAX	013 020 031 033	TATUNG	039 043
	107 109 144 147		063	TEAC	034 039 043
GO VIDEO	132 136	PHILCO	031 034 067	TECHNICS	031 033 070
HARMAN KARDON	012 045	PHILIPS	031 033 034 054	TEKNIKA	019 031 033 034
HITACHI	004 018 026 034		067 071 101		101
	043 063 137 150	PILOT	101	THOMAS	034
INSTANTREPLAY	031 033	PIONEER	013 021 048	TMK	006
JCL	031 033	PORTLAND	108	TOSHIBA	008 013 042 047
JCPENNY	012 013 015 033	PULSAR	072		059 082 112 131
	040 066 101	QUARTZ	011 014	TOTEVISION	040 101
JENSEN	043	QUASAR	033 066 075 145	UNITECH	040
JVC	012 031 033 043	RCA	013 020 033 034	VECTOR RESEARCH	012
	048 050 055 060		040 041 062 063	VICTOR	048
	130 150 152		107 109 140 144	VIDEO CONCEPTS	012 034 046
KENWOOD	014 034 039 043		145 147	VIDEOSONIC	040
	047 048	REALISTIC	003 008 010 014	WARDS	003 013 017 024
LG (GOLDSTAR)	001 012 013 020		031 033 034 040		031 033 034 040
	101 106 114 123		053 054 101		053 054 131
LLOYD	034	RICO	058	YAMAHA	012 034 039 043
LXI	003 009 013 014	RUNCO	148	ZENITH	034 048 056
	017 034 101 106	SALORA	014		058 072 080 101
MAGIN	040				

APPENDIX

IR CODES

1. How to Connect

- Connect your wired remote control to the Remote Control port on the TV.

2. Remote Control IR Codes

■ Output waveform

Single pulse, modulated with 37.917KHz signal at 455KHz

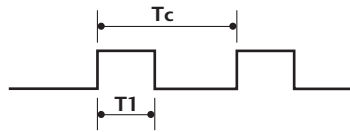

Carrier frequency
 $FCAR = 1/TC = fOSC/12$
 Duty ratio = $T1/TC = 1/3$

■ Configuration of frame

1st frame



Repeat frame

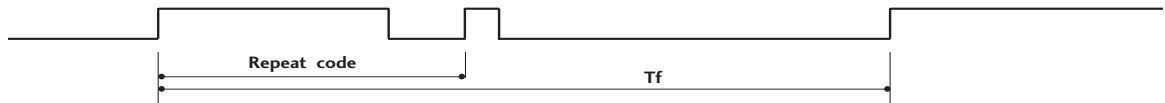

■ Lead code

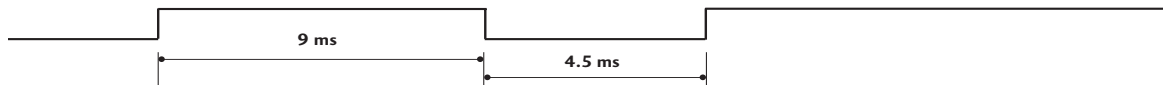

■ Repeat code

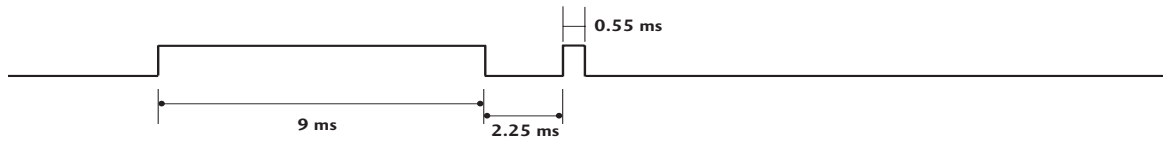

■ Bit description



■ Frame interval: Tf

The waveform is transmitted as long as a key is depressed.



Code (Hexa)	Function	Note
00	PR (▲) or PR +	R/C BUTTON
01	PR (▼) or PR -	R/C BUTTON
02	VOL (▲) or VOL +	R/C BUTTON
03	VOL (▼) or VOL -	R/C BUTTON
40	Up (▲)	R/C BUTTON
41	Down (▼)	R/C BUTTON
06	Right (▶)	R/C BUTTON
07	Left (◀)	R/C BUTTON
08	POWER	R/C BUTTON (POWER ON/OFF)
09	MUTE	R/C BUTTON
10	Number Key 0	R/C BUTTON
11	Number Key 1	R/C BUTTON
12	Number Key 2	R/C BUTTON
13	Number Key 3	R/C BUTTON
14	Number Key 4	R/C BUTTON
15	Number Key 5	R/C BUTTON
16	Number Key 6	R/C BUTTON
17	Number Key 7	R/C BUTTON
18	Number Key 8	R/C BUTTON
19	Number Key 9	R/C BUTTON
0B	INPUT	R/C BUTTON
AA	INFO ⓘ	R/C BUTTON
AB	GUIDE	R/C BUTTON
56	SUBTITLE	R/C BUTTON
5B	EXIT	R/C BUTTON
1E	FAV	R/C BUTTON
1A	Q.VIEW	R/C BUTTON
50	D/A	R/C BUTTON
F0	TV/RADIO	R/C BUTTON
7E	SIMPLINK	R/C BUTTON
E0	BRIGHT +	R/C BUTTON
E1	BRIGHT -	R/C BUTTON
0A	I/II	R/C BUTTON
0E	SLEEP	R/C BUTTON
43	MENU	R/C BUTTON
44	OK(⊙)	R/C BUTTON
53	LIST	R/C BUTTON
20	TEXT	R/C BUTTON
2A	REVEAL	R/C BUTTON
26	TIME	R/C BUTTON
28	BACK	R/C BUTTON
62	UPDATE	R/C BUTTON
70	INDEX	R/C BUTTON
65	HOLD	R/C BUTTON
61	BLUE Key	R/C BUTTON
63	YELLOW Key	R/C BUTTON
71	GREEN Key	R/C BUTTON
72	RED Key	R/C BUTTON
79	RATIO	R/C BUTTON
B0	▶	R/C BUTTON
BA	II	R/C BUTTON
B2	I◀◀	R/C BUTTON
B3	I▶▶	R/C BUTTON
8F	◀◀	R/C BUTTON
8E	▶▶	R/C BUTTON
B1	■	R/C BUTTON
BD	●	R/C BUTTON
4D	PICTURE	R/C BUTTON (Only 37/42/47/52LY9*, 50/60PF9*)
52	SOUND	R/C BUTTON (Only 37/42/47/52LY9*, 50/60PF9*)

EXTERNAL CONTROL DEVICE SETUP

RS-232C Setup

Connect the RS-232C (serial port) input jack to an external control device (such as a computer or an A/V control system) to control the product's functions externally.

Connect the serial port of the control device to the RS-232C jack on the product back panel.

Note: RS-232C connection cables are not supplied with the product.

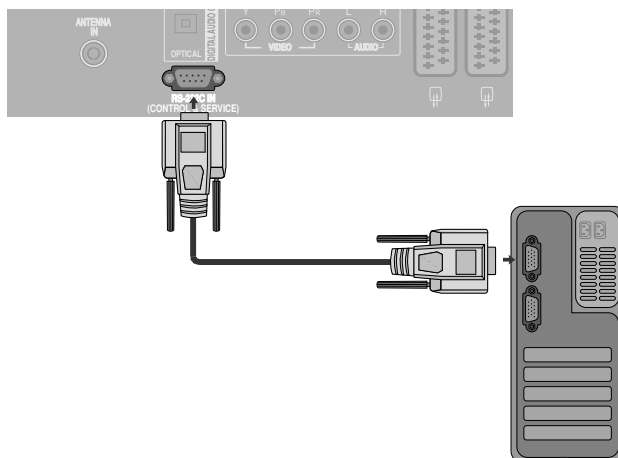

Type of Connector; D-Sub 9-Pin Male

No.	Pin Name
1	No connection
2	RXD (Receive data)
3	TXD (Transmit data)
4	DTR (DTE side ready)
5	GND
6	DSR (DCE side ready)
7	RTS (Ready to send)
8	CTS (Clear to send)
9	No Connection

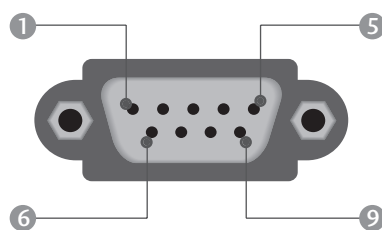

RS-232C Configurations

7-Wire Configurations (Standard RS-232C cable)

	PC	TV	
RXD	2 ● ——— ● 3		TXD
TXD	3 ● ——— ● 2		RXD
GND	5 ● ——— ● 5		GND
DTR	4 ● ——— ● 6		DSR
DSR	6 ● ——— ● 4		DTR
RTS	7 ● ——— ● 8		CTS
CTS	8 ● ——— ● 7		RTS
	D-Sub 9	D-Sub 9	

3-Wire Configurations (Not standard)

	PC	TV	
RXD	2 ● ——— ● 3		TXD
TXD	3 ● ——— ● 2		RXD
GND	5 ● ——— ● 5		GND
DTR	4	6	DTR
DSR	6	4	DSR
RTS	7	7	RTS
CTS	8	8	CTS
	D-Sub 9	D-Sub 9	

Set ID

Use this function to specify a set ID number.
Refer to 'Real Data Mapping'. ▶ p.109

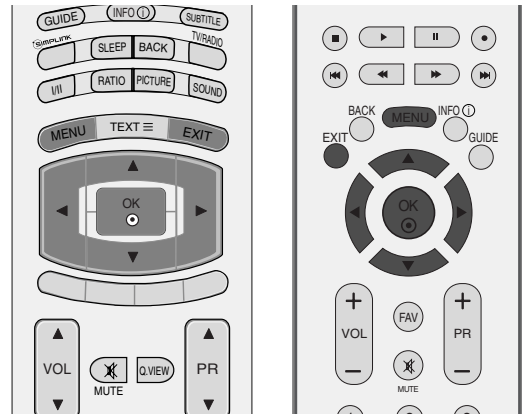

1 Press the **MENU** button and then use ▲ or ▼ button to select the **OPTION** menu.

2 Press the ► button and then use ▲ or ▼ button to select **Factory Mode**.

3 Press the ► button and then use ▲ or ▼ button to select **Set ID**.

4 Press the ◀ or ▶ button to adjust **Set ID** to choose the desired TV ID number. The adjustment range of SET ID is 1~99.

5 Press **EXIT** button to return to normal TV viewing.

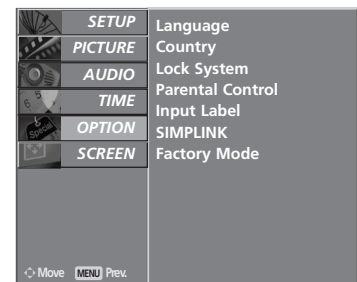

1

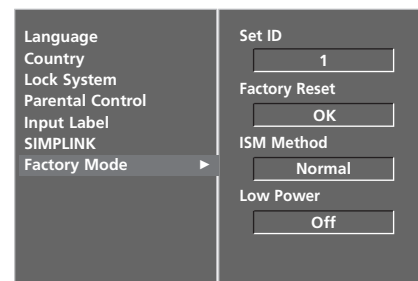

2

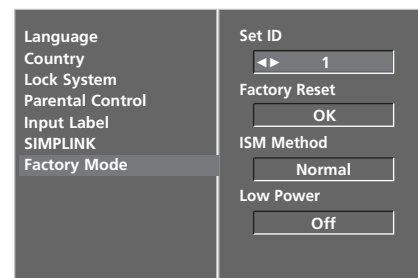

3 4

Communication Parameters

- Baud rate : 9600 bps (UART)
- Data length : 8 bits
- Parity : None
- Stop bit : 1 bit
- Communication code : ASCII code
- Use a crossed (reverse) cable.

Command Reference List

	COMMAND 1	COMMAND 2	DATA (Hexadecimal)
01. Power	k	a	0 ~ 1
02. Input Select	k	b	Refer to p. 107
03. Aspect Ratio	k	c	Refer to p. 107
04. Screen Mute	k	d	0 ~ 1
05. Volume Mute	k	e	0 ~ 1
06. Volume Control	k	f	0 ~ 64
07. Contrast	k	g	0 ~ 64
08. Brightness	k	h	0 ~ 64
09. Colour	k	i	0 ~ 64
10. Tint	k	j	0 ~ 64
11. Sharpness	k	k	0 ~ 64
12. OSD Select	k	l	0 ~ 1
13. Remote control lock mode	k	m	0 ~ 1
14. Balance	k	t	0 ~ 64
15. Colour Temperature	k	u	0 ~ 3
16. Red Adjustment	k	v	0 ~ 50
17. Green Adjustment	k	w	0 ~ 50
18. Blue Adjustment	k	\$	0 ~ 50
19. Abnormal Status	k	z	0 ~ 9
20. ISM Method	j	p	Refer to p. 109
21. Low Power	j	q	0 ~ 1
22. Auto Configure	j	u	1
23. Channel Select Command	m	a	Refer to p. 110
24. Send IR Code	m	c	Key Code
25. Input select (Main)	x	b	Refer to p. 110

* When setting the 19 ~ 25, a menu doesn't display on screen.

Transmission / Receiving Protocol

Transmission

[Command1][Command2][][Set ID][][Data][Cr]

- * [Command 1] : First command to control the set.
(j, k, m or x)
- * [Command 2] : Second command to control the set.
- * [Set ID] : You can adjust the set ID to choose desired monitor ID number in option menu.
Adjustment range is 1 ~ 99.
When selecting Set ID '0', every connected the set is controlled.
Set ID is indicated as decimal (1~99) on menu and as Hexa decimal (0x0~0x63) on transmission/receiving protocol.
- * [DATA] : To transmit command data.
Transmit 'FF' data to read status of command.
- * [Cr] : Carriage Return
ASCII code '0x0D'
- * [] : ASCII code 'space (0x20)'

OK Acknowledgement

[Command2][][Set ID][][OK][Data][x]

- * The set transmits ACK (acknowledgement) based on this format when receiving normal data. At this time, if the data is data read mode, it indicates present status data. If the data is data write mode, it returns the data of the PC computer.

Error Acknowledgement

[Command2][][Set ID][][NG][Data][x]

- * The set transmits ACK (acknowledgement) based on this format when receiving abnormal data from non-viable functions or communication errors.

- Data 1: Illegal Code
- 2: not support function
- 3: Wait more time

01. Power (Command 2 : a)

- ▶ To control Power On/Off of the set.

Transmission

```
[k][a][ ][Set ID][ ][Data][Cr]
```

Data 0 : Power Off 1 : Power On

Ack

```
[a][ ][Set ID][ ][OK][Data][x]
```

- ▶ To show Power On/Off.

Transmission

```
[k][a][ ][Set ID][ ][FF][Cr]
```

Ack

```
[a][ ][Set ID][ ][OK][Data][x]
```

* In like manner, if other functions transmit '0xFF' data based on this format, Acknowledgement data feed back presents status about each function.

02. Input Select (Command 2 : b)

- ▶ To select input source for the set.
You can also select an input source using the INPUT button on the set's remote control.

Transmission

```
[k][b][ ][Set ID][ ][Data][Cr]
```

Data 0 : DTV (This feature is not available for all models.)	6 : RGB-PC
1 : Analogue	7 : HDMI1
2 : AV1	8 : HDMI2
3 : AV2	9 : HDMI3(Only 37/42LF7*, 42LY99)
4 : AV3	
5 : Component	

Ack

```
[b][ ][Set ID][ ][OK][Data][x]
```

03. Aspect Ratio (Command 2 : c) (Main Picture Size)

- ▶ To adjust the screen format. (Main picture format)
You can also adjust the screen format using the RATIO (Aspect Ratio Control) button on remote control or in the SCREEN menu.

Transmission

```
[k][c][ ][Set ID][ ][Data][Cr]
```

Data 1 : Normal screen (4:3)	6 : Original
2 : Wide screen (16:9)	7 : 14:9
3 : Horizon (Spectacle)	8 : Full(Except 42LY99)
(Except 37/42LF7*, 42LY99)	9 : 1:1 Pixel
4 : Zoom1	(or Just Scan)
5 : Zoom2	(Only 37/42LF7*, 42LY99)

Ack

```
[c][ ][Set ID][ ][OK][Data][x]
```

* Using the PC input, you select either 16:9 or 4:3 screen aspect ratio.

* In HDMI (1080i 50Hz/60Hz, 1080p 24Hz/50Hz/60Hz) mode, 1:1 Pixel(or **Just Scan** (Only 37/42LF7*, 42LY99)) is available.

04. Screen Mute (Command 2 : d)

- ▶ To select screen mute on/off.

Transmission

```
[k][d][ ][Set ID][ ][Data][Cr]
```

Data 0 : Screen mute off (Picture on)

1 : Screen mute on (Picture off)

Ack

```
[d][ ][Set ID][ ][OK][Data][x]
```

05. Volume Mute (Command 2 : e)

- ▶ To control volume mute on/off.
You can also adjust mute using the MUTE button on remote control.

Transmission

```
[k][e][ ][Set ID][ ][Data][Cr]
```

Data 0 : Volume mute on (Volume off)

1 : Volume mute off (Volume on)

Ack

```
[e][ ][Set ID][ ][OK][Data][x]
```

06. Volume Control (Command 2 : f)

- ▶ To adjust volume.
You can also adjust volume with the VOLUME buttons on remote control.

Transmission

```
[k][f][ ][Set ID][ ][Data][Cr]
```

Data Min : 0 ~ Max : 64

* Refer to 'Real data mapping 1'. See page 109.

Ack

```
[f][ ][Set ID][ ][OK][Data][x]
```

07. Contrast (Command 2 : g)

- ▶ To adjust screen contrast.
You can also adjust contrast in the PICTURE menu.

Transmission

```
[k][g][ ][Set ID][ ][Data][Cr]
```

Data Min : 0 ~ Max : 64

* Refer to 'Real data mapping 1'. See page 109.

Ack

```
[g][ ][Set ID][ ][OK][Data][x]
```

08. Brightness (Command 2 : h)

- ▶ To adjust screen brightness.
You can also adjust brightness in the PICTURE menu.

Transmission

```
[k][h][ ][Set ID][ ][Data][Cr]
```

Data Min : 0 ~ Max : 64

* Refer to 'Real data mapping 1'. See page 109.

Ack

```
[h][ ][Set ID][ ][OK][Data][x]
```

APPENDIX

09. Colour (Command 2 : i)

- ▶ To adjust the screen colour.
You can also adjust colour in the PICTURE menu.

Transmission

[k][i][][Set ID][][Data][Cr]

Data Min : 0 ~ Max : 64
* Refer to 'Real data mapping 1'. See page 109.

Ack

[i][][Set ID][][OK][Data][x]

10. Tint (Command 2 : j)

- ▶ To adjust the screen tint.
You can also adjust tint in the PICTURE menu.

Transmission

[k][j][][Set ID][][Data][Cr]

Data Red : 0 ~ Green : 64
* Refer to 'Real data mapping 1'. See page 109.

Ack

[j][][Set ID][][OK][Data][x]

11. Sharpness (Command 2 : k)

- ▶ To adjust the screen sharpness.
You can also adjust sharpness in the PICTURE menu.

Transmission

[k][k][][Set ID][][Data][Cr]

Data Min : 0 ~ Max : 64
* Refer to 'Real data mapping 1'. See page 109.

Ack

[k][][Set ID][][OK][Data][x]

12. OSD Select (Command 2 : l)

- ▶ To select OSD (On Screen Display) on/off when controlling remotely.

Transmission

[k][l][][Set ID][][Data][Cr]

Data 0 : OSD off 1 : OSD on

Ack

[l][][Set ID][][OK][Data][x]

13. Remote control lock mode (Command 2 : m)

- ▶ To lock the front panel controls on the monitor and remote control.

Transmission

[k][m][][Set ID][][Data][Cr]

Data 0 : Lock off 1 : Lock on

Ack

[m][][Set ID][][OK][Data][x]

- * If you're not using the remote control, use this mode.
When main power is on/off, external control lock is released.

14. Balance (Command 2 : t)

- ▶ To adjust balance.
You can also adjust balance in the AUDIO menu.

Transmission

[k][t][][Set ID][][Data][Cr]

Data Min : 0 ~ Max : 64
* Refer to 'Real data mapping 1'. See page 109.

Ack

[t][][Set ID][][OK][Data][x]

15. Colour Temperature (Command 2 : u)

- ▶ To adjust colour temperature. You can also adjust Colour Temperature in the PICTURE menu.

Transmission

[k][u][][Set ID][][Data][Cr]

Data 0: Cool 1: Medium 2: Warm 3: User

Ack

[u][][Set ID][][OK][Data][x]

16. Red Adjustment (Command 2 : v)

- ▶ To adjust red in colour temperature.

Transmission

[k][v][][Set ID][][Data][Cr]

Data Min : 0 ~ Max : 50
* Refer to 'Real data mapping 2'. See page 109.

Ack

[v][][Set ID][][OK][Data][x]

17. Green Adjustment (Command 2 : w)

- ▶ To adjust green in colour temperature.

Transmission

[k][w][][Set ID][][Data][Cr]

Data Min : 0 ~ Max : 50
* Refer to 'Real data mapping 2'. See page 109.

Ack

[w][][Set ID][][OK][Data][x]

18. Blue Adjustment (Command 2 : \$)

- ▶ To adjust blue in colour temperature.

Transmission

[k][\$][][Set ID][][Data][Cr]

Data Min : 0 ~ Max : 50
* Refer to 'Real data mapping 2'. See page 109.

Ack

[\$][][Set ID][][OK][Data][x]

19. Abnormal State (Command 2 : z)

- To recognize an abnormal state.

Transmission

```
[k][z][ ][Set ID][ ][FF][ ][Cr]
```

Data FF : Read

Ack

```
[z][ ][Set ID][ ][OK][Data][x]
```

Data 0: Normal (Power on and signal exist)
 1: No signal (Power on)
 2: Turn the monitor off by remote control
 3: Turn the monitor off by sleep time function
 4: Turn the monitor off by RS-232C function
 5: 5V down
 6: AC down
 7: Turn the monitor off by Fan Alarm function
 8: Turn the monitor off by Off time function
 9: Turn the monitor off by Auto sleep function

* This function is “read only”.

20. ISM Method

(Command 1 : j, Command 2 : p)

- To control the ISM method. You can also adjust ISM Method in OPTION menu.
 It's not available to use this function in LCD TV models.

Transmission

Data 0: Normal 2: Orbiter
 1: White wash 3: Inversion

Ack

```
[p][ ][Set ID][ ][OK/NG][Data][x]
```

21. Low Power

(Command 1 : j, Command 2 : q)

- To reduce the power consumption of the set. You can also adjust Low Power in OPTION menu.
 It's not available to use this function in LCD TV models.

Transmission

```
[j][q][ ][Set ID][ ][Data][ ][Cr]
```

Data 0 : Off
 1 : On

Ack

```
[q][ ][Set ID][ ][OK/NG][Data][x]
```

* Real data mapping 1

```
0 : Step 0
⋮
A : Step 10 (Set ID 10)
⋮
F : Step 15 (Set ID 15)
10 : Step 16 (Set ID 16)
⋮
64 : Step 100
⋮
6E : Step 110
⋮
73 : Step 115
74 : Step 116
⋮
C7 : Step 199
⋮
FE : Step 254
FF : Step 255
```

* Real data mapping 2

```
0 : -40
1 : -39
2 : -38
⋮
28 : 0
⋮
4E : +38
4F : +39
50 : +40
```

APPENDIX

22. Auto Configure (Command 1 : j, Command 2 : u)

► To adjust picture position and minimize image shaking automatically. It works only in RGB (PC) mode.

Transmission

[j][u][][Set ID][][Data][Cr]

Data 1: To set

Ack

[u][][Set ID][][OK/NG][Data][x]

23. Channel Select Command (Command 1 : m, Command 2 : a)

► Select channel to following physical number.

Transmission

[m][a][][Set ID][][Data0][][Data1][][Data2][Cr]

Data0 :High channel data

Data1 :Low channel data

ex. No. 47 -> 00 2F (2FH)
No. 394 -> 01 88 (188H),
DTV No. 0 -> Don't care

Data2 0x00 : ATV Main

0x10 : DTV Main

Channel data range

Analogue - Min: 00 ~ Max: 63 (0~99)

Digital - Min: 00 ~ Max: 3E7 (0~999)

Ack

[a][][Set ID][][OK/NG][Data][x]

Data Min: 00 ~ Max: FF

24. Send IR Code (Command 1 : m, Command 2 : c)

► To send IR remote key code.

Transmission

[m][c][][Set ID][][Data][Cr]

Data Key code - Refer to page 103.

Ack

[c][][Set ID][][OK/NG][Data][x]

25. Input select (Command 1 : x, Command 2 : b) (Main Picture Input)

► To select input source for main picture.

Transmission

[x][b][][Set ID][][Data][Cr]

Data Structure

MSB				LSB			
0	0	0	0	0	0	0	0
└ External Input ┘				└ Input Number ┘			

External Input				Data
0	0	0	0	DTV
0	0	0	1	Analogue
0	0	1	0	AV
0	0	1	1	Component
0	1	0	0	RGB
0	1	0	1	HDMI

Input Number				Data
0	0	0	0	Input1
0	0	0	1	Input2
0	0	1	0	Input3
0	0	1	1	Input4

Ack

[b][][Set ID][][OK/NG][Data][x]

LG Electronics Inc.