



**7 inch Wide TFT color
TV System/Mobile Monitor
OWNER'S MANUAL
LAM770T1/LAM770**

Before connecting, operating or adjusting this product, please read this instruction booklet carefully and completely.



Table of contents

Important Safety Instruction 3-6

Main features 7-8

Installation 9-14

Parts supplied	9
Before installing	9
Installation order for the stand	10
Treatment of monitor cable	11
Installation of monitor unit	11-12
Installation order for the stand (Rear seat monitor) ..	13
Connection of exterior units	14

Parts name 15-17

Front view	15
Rear view	16
Remote control	17
Battery installation	17

Operation 18-21

Power ON/OFF	18
Mode conversion	18
Adjusting the volume	18
Mute	18
To enter the FUNCTION menu	19
Adjusting FUNCTION menu	19
To enter the TV SETUP menu	20
Adjusting TV SETUP menu	20-21

Troubleshooting 22-23

Specifications 24

Important Safety Instruction



The lightning flash with arrowhead symbol, within an equilateral triangle is intended to alert the user about the presence of uninsulated dangerous voltage within the product's enclosure that may be of sufficient magnitude to constitute a risk of electric shock.



The exclamation point within an equilateral triangle is intended to alert the user to the presence of important operating and maintenance (servicing) instructions in the literature accompanying the appliance.

To prevent a user or others from any physical or financial damage, please abide by the following. The following indications describe the degree of danger or damage for the misuse.

To reduce the risk of fire or electric shock, do not expose this apparatus to rain or moisture.

1. Read these instructions.
2. Keep these instructions.
3. Heed all warnings
4. Follow all warnings.
5. Do not use this apparatus near water.
6. Clean only with dry cloth.

Important Safety Instruction



Warning



Prohibition

- 1. Do not operate the TV while driving.**
Operating while driving may cause a fatal or serious accident.
Always operate after the vehicle is parked at a safe place.
- 2. While driving, do not watch the TV or video**
Watching TV or video while driving may cause a serious accident.
- 3. At a trouble or abnormal state, do not use it.**
If you use it at no sound or with smoke or strange smell, this can be the cause of a fire.
- 4. Do not expose your eyes or face close to the pole of an antenna.**
This may be the cause of injury.
- 5. In case of vehicles equipped with air bags, place the TV away from the operation range of the air bags.**
In case of an accident, impact between the air bags and the TV may cause a serious facial injury to passengers.
- 6. To place the TV with a double - sided tape, ensure to wash the adhesive side cleanly then place it.**
- 7. Excessive sound pressure from earphones and headphones can cause hearing loss.**



Warning



Disassembling prohibited

- 1. Do not disassemble or modify it.**
This may be the cause of an accident like a breakdown or a fire.

Note

TV function is only available for LAM770T1.

Important Safety Instruction



Notice



Prohibition

- 1. Do not drop it and avoid heavy impact at anytime.**
This may be the cause of a trouble or a fire.
- 2. Do not watch TV for a long time with engine turned off.**
A vehicle may not start due to the discharge of battery.
- 3. Do not grab the lower part of the antenna to adjust an angle.**
- 4. Do not charge, disassemble or heat the battery and keep it away from fire.**
This may be the cause of an explosion or a leakage.
- 5. Keep a glass washer out of children's reach.**
If it goes into eyes, wash them cleanly with water and consult with a doctor.
- 6. Do not install near any heat sources such as radiators, heat registers, or other apparatus (including amplifiers) that produce heat.**
- 7. Don't block any ventilation openings, install in accordance with the manufacturer's instructions.**
- 8. To prevent injury, this apparatus must be securely attached or fixed in accordance with the installation instructions**

Note

TV function is only available for LAM770T1.

Important Safety Instruction



Notice



Compulsion

- 1 Do not touch an antenna line or the TV when lightning.**
This may be the cause of an electric shock.
- 2. In case that cable passes through a hole or touches a metal part, protect it appropriately.**
- 3. Keep the battery out of children's reach.**
If a child swallows it, consult with a doctor right away.
- 4. Do ask a experienced technician to install this product.**
Skilled technique and experience are required to install and wire.
For your safety, ask a sales agency to do those kinds of works.
- 5. Protect the power cord so that it does not get walked on or pinched, particularly at the plug, convenience receptacles and the connecting point from the device.**
- 6. Only use attachments/accessories designated by the manufacturer.**
- 7. Use the product only with the cart, stand, tripod, bracket or table designated by the manufacturer or sold with the device. When the cart is used, be careful not to get injured from the cart with the device tipping over.**



- 8. Unplug the device during thunder storms or when not used for a long period of time.**
- 9. All services must be done by a qualified service personnel. Service is required when the apparatus has been damaged in any way, such as damaged power-supply cord or plug, liquid spilled on product or objects fallen on the device, exposure to rain or moisture, abnormal operation or when the product has been dropped.**

Main features

This unit is designed to fit the environment of vehicles. Unlike general units for home Use, the unit for the Vehicles is equipped with a special circuit inside the product to provide good quality picture and sound.

1. Video Low reflection and high definition LCD

Our LCD provides HD quality screen using 7 inch wide TFT LCD. In addition, it has the pixel disposition structure suitable to watch screen during Navigation.

Forced Synchronization Circuit

This circuit minimizes the shaking of the screen in order to provide a stable screen during motion.

2. Audio Sound conversion function

A built-in speaker with max of 1W output is equipped inside.

Noise Canceller Circuit

The Noise Canceller Circuit is designed to cancel the noises that can arise from the vehicle.

Ear-Phone Function

Can hear voice by Earphone in vehicles.

3. Exterior Audio/Video Input Function

Our unit has an outlet to connect with audio/video.



Disposal of your old appliance

1. When this crossed-out wheeled bin symbol is attached to a product, it means the product is covered by the European Directive 2002/96/EC.
2. All electrical and electronic products should be disposed of separately from the municipal waste stream via designated collection facilities appointed by the government or the local authorities.
3. The correct disposal of your old appliance will help prevent potential negative consequences for the environment and human health.
4. For more detailed information about disposal of your old appliance, please contact your city office, waste disposal service or the shop where you purchased the product.

Main features

4. Convenient Functions

Dimmer Function

According to the brightness of surrounding, that of the screen can be adjusted.

Up to 99 channel memory

Our TV is capable of transmitting regular broadcasting TV (public) and automatically memorizes up to 99 channels for regular broadcasting TV stations.

Remote Controller

A user-friendly remote controller is provided.

Auto Search Function

Auto search function is designed to find next available TV station and to memorize the station automatically. Just simply push the search button and you can easily find the TV station you want.

Full-Down Menu

All the function are displayed in one screen for your convenience.

AV1/AV2 Select Function

Can select AV1/AV2

Note

The LAM770T1 has three signal sources ; AV1, AV2 and TV, but the LAM770 only has two signal sources; AV1 and AV2.

LAM770T1 has TV mode when press the mode convention button.

The TV function will be had, but the LAM770 does not have TV mode.

LAM770T1, when in TV mode , the menu button is pressed the TV tuning menu will be had the CHANNEL, BADD/ERASE, BOUND SYSTEM, BFINE TUNE, BAUTO MEMORY and ALL RESET FUNCTIONS can be used, but the LAM770 doesn't have the function.

The remote controller is different. the LAM770T1 has 0-9 number buttons, but the LAM770 doesn't have.

The LAM770T1 has TV antenna but the LAM770 doesn't have."

Installation

Parts supplied



AV Cable



Cigar light adapter



Remote Control



Section-mount cradle
(Front)



Section-mount cradle
(Rear)



Cover case

Before installing

At low temperature (20°C... or less)

Turn on the heater for a proper temperature.
(to enhance adhesive power).

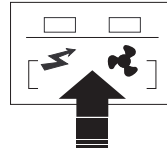

At high humidity (fog, rain and so on)

After making adhesive side dried with a dryer,
install the TV.



After installing of the Stand

Pulling the Monitor stand or installing the Monitor
within 24 hours of the stand installation may
weaken adhesive power of the stand.



Installation

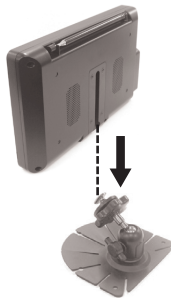
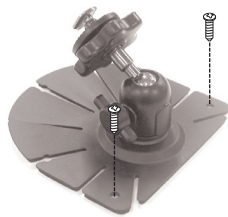
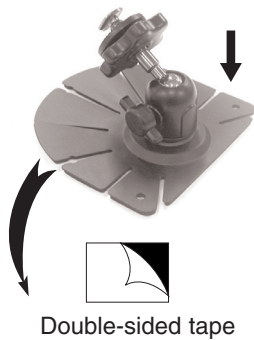

Installation order for the Stand

1. Decide a place for installation and make a forming by bending the adhesive side of the Stand according to the shape of the place.
2. Wash the adhesive side cleanly with a neutral detergent or alcohol.
3. After uncovering a double-sided tape out of the Stand, install it.



Notice

If the temperature of the adhesive side is low (20°C... or less), the adhesive power of the tape may be weakened. To prevent this, stick the Stand after heated.

4. Drive the screws into the product.
(The screws is not supplied.)



Notice

After screwing, check and take notice to escape any damage to the wire or the equipment of dashboard inside.

5. While putting the stand screw into a hole placed on the back side of the monitor unit, adjust installation height and angle.



Notice

Adjust the height and angle of the unit to reach a dashboard in order to prevent trembling by the vibration of a vehicle. After adjusting the height and angle, surely screw to fix it. While driving, this may be the cause of an accident by its bolting.

Treatment of monitor cable



Importance

- If the Monitor is installed and the Cable connected, put the cable in a good order not to disturb a safe driving.
- Pay attention to the cable not being caught in the rail of a door or a seat. The cable may be cut by its getting caught in.
- Because it is very dangerous for the cable to be rolled up by a shift lever, arrange it well with a cable clamp.

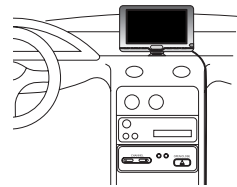

Installation of monitor unit



Importance

- The Monitor unit of this product is designed taking a serious views for safety.
- Unless you surely install it on a safe place, this may be the cause of an accident and be very dangerous.
- When you decide a place for attachment, check following notices necessarily.

Installation

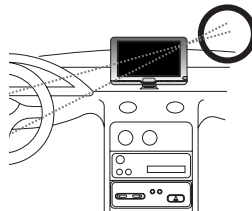
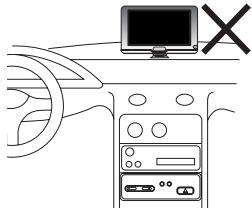
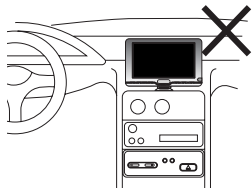

Adhere it on a place not to disturb the operation of air bags.



Importance

- Do not install on the place where disturbs front sight and the operating of steering, transmission shift lever, brake pedal and makes other passengers risky. This may be the cause of an accident or an injury.
- As shown on the above, attach it on a safe place where it does not disturb front sight or you don't have to avert your eyes extremely.



Notice

- Do not install it on a place where it is exposed at extremely high or low temperature. This may make the monitor unit transformed or be the cause of a trouble.
- While parking, protect it against the direct rays of the sun with the enclosed monitor cover because high temperature may influence on it.



Importance

- Do not attach on a place where the wind of air conditioner can directly reach the monitor unit.
- Do not attach on a place where it disturbs the opening of Globe Box.
- Do not install it on a wooden panel or a textile one because it is likely to be damaged.

Installation order for the stand (Rear seat monitor)

1. First, separate the head rest **A**.

Note

Refer to your car's user guide.

2. Insert the head rest **A** into the a hole placed on the up side of the section-mount cradle.
3. Install the head rest **A** into the a hole placed on the up side of the seat.
4. Drive the enclosed screws into the unit.
5. While putting the Stand screw into a hole placed on the bottom side of the unit, adjust installation height and angle.



Notice

Adjust the angle of the unit to reach a seat in order to prevent trembling by the vibration of a vehicle. After adjusting the angle, surely screw to fix it. While driving, this may be the cause of an accident by its bolting.

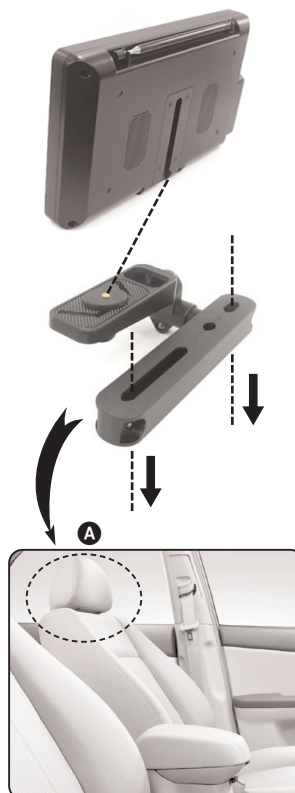

Installation

Connection of exterior units

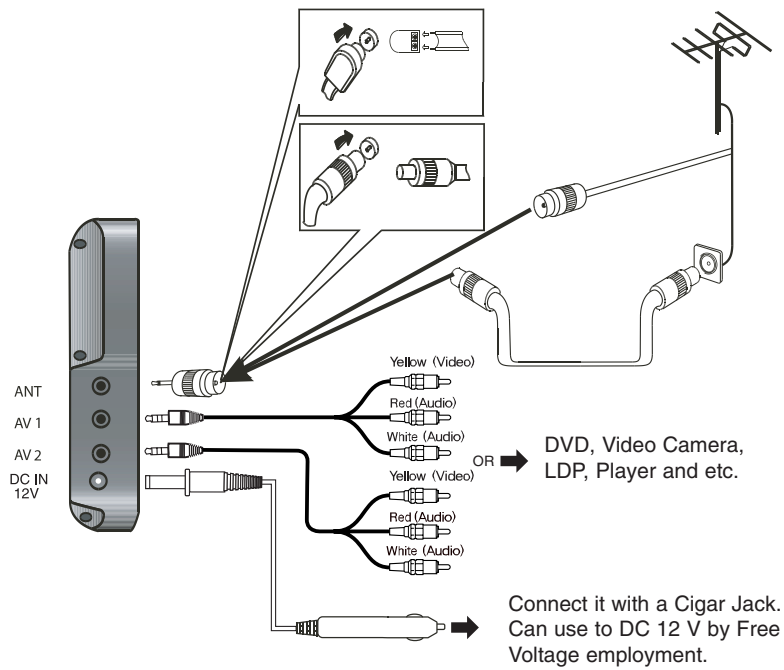

Note

TV function is only available for LAM770T1.
When the AV Cable is insert and pulled out of the AV jack, the picture will flicker for a short moment, which is normal.

Front view

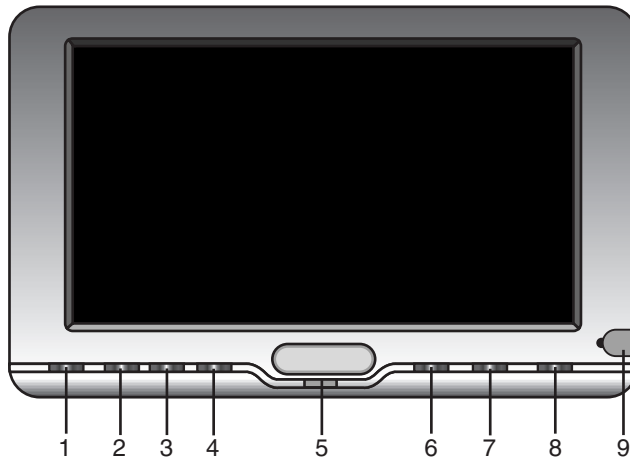

1. ⏻ : Power ON/OFF
2. •TV/AV : Mode conversion (TV → AV1 IN → AV2 IN) : LAM770T1
•AV1/AV2 : Mode conversion (AV1 IN → AV2 IN) : LAM770
3. ▼ : •Channel down select : LAM770T1
•Down button / Menu item select
4. ▲ : •Channel up select : LAM770T1
•Up button / Menu item select
5. STBY (R) : Standby lamp (Red color)
PWR (G) : Power Lamp (Green color)
6. ► : Volume up / Menu item adjust
7. ◀ : Volume down / Menu item adjust
8. MENU : Enter menu
9. 🎧 : Earphone socket

✦ **Note**

Please use the appropriate jack connector for the antenna input.

Parts name

Rear view

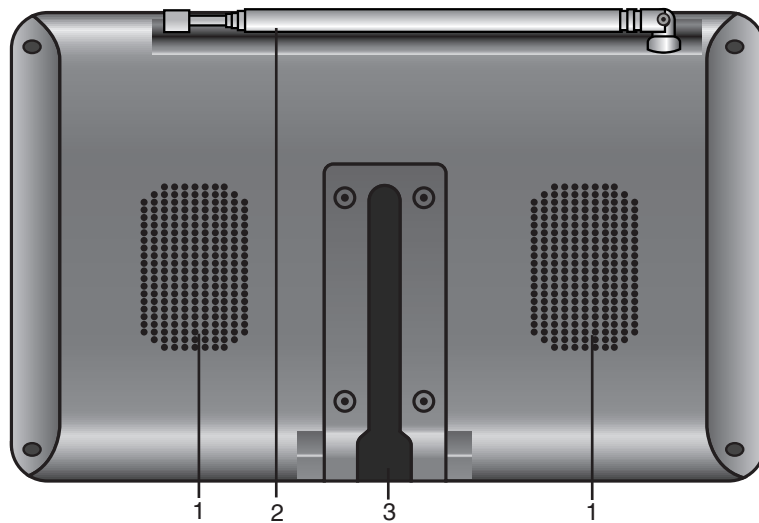

1. Left/ Right Speakers
2. TV Antenna (TV function is only available for LAM770T1.)
3. Docking connector

✦ **Note**

Actual player may vary slightly from images shown.

Remote control

1. POWER
2. •TV/AV : Mode conversion
(TV → AV1 IN → AV2 IN) : LAM770T1
•AV1/AV2 : Mode conversion
(AV1 IN → AV2 IN) : LAM770
3. NUMBER [0 -9]
4. MENU
5. •CHANNEL UP ▲ / DOWN ▼ : LAM770T1
•Menu item select
6. •VOLUME UP ► / DOWN ◀
•Menu item adjust
7. MUTE (AUDIO MUTE)

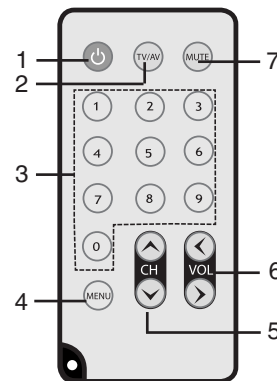

Battery installation

1. Remove the battery holder with fingers.
2. Install the battery on the battery holder.
3. Install the battery holder back into its original position.

Notes

- Use only one CR2025 (3V) lithium battery.
- Remove the battery if the remote control is not used for a long period of time.
- Do not leave the product in a hot or humid place.
- Do not handle the battery with metallic tools.
- Do not store the battery with metallic materials.
- In the event of battery leakage, wipe the remote control completely clean and install a new battery.

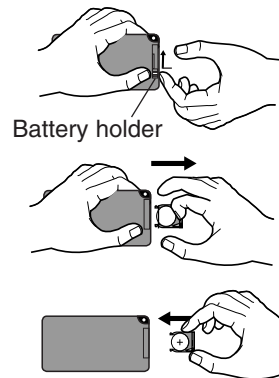

Operation



STBY : RED
PWR : GREEN

Power ON/OFF

- When connecting the power to the main system, red LED of STBY lights on.
- Press the Power (⏻) button, the ON/OFF can be repeatedly executed.
- At the power ON, green LED of PWR lights on.

✦ **Note**

When power of the main system is turned on or off, the picture sometimes flicker, which is normal.

Mode conversion

- Press the **TV/AV** button repeatedly. Mode is changed.
TV (LAM770T1) → AV1 IN → AV2 IN...
- In " TV " display mode, a channel number displays. Besides, AV1/AV2 displays.

✦ **Notes**

If power is supplied to the main system, the TV memorizes the previous status and makes ON/OFF automatically.

Adjusting the volume

Press the ◀ or ▶ buttons to adjust the sound level. The minimum volume is 0 and the maximum volume is 30.

✦ **Note**

When you turn the unit off, the current volume level is automatically memorized.

Mute

Press the **MUTE** on the remote control to cut the sound. To cancel it, press again.

To enter the FUNCTION menu

1. Select the **TV**, **AV1**, or **AV2** by pressing the **TV/AV** button repeatedly.
2. Press the **MENU** button.
The "TV SETUP" menu is displayed.

Note

When you press the AV1/AV2 switch, the picture will flicker for seconds, which is normal.

FUNCTION	
COLOR	30
BRIGHT	30
CONTRAST	33
MODE	16 : 9
ROTATE	◀▶
LANGUAGE	ENGLISH

Adjusting FUNCTION menu

Item	VOL ◀	VOL ▶
COLOR	Paler	Deeper
BRIGHT	Weaker	Stronger
CONTRAST	Darker	Lighter
MODE	16 : 9 ↔ 4 : 3	16 : 9 ↔ 4 : 3
ROTATE	Rotating the menu screen.	Rotating the menu screen.
LANGUAGE	ENGLISH ↔ RUSSIAN	ENGLISH ↔ RUSSIAN

1. Press the ▲ or ▼ buttons to select a item.
2. Press the ◀ or ▶ buttons to adjust.

Note

When the MODE is changed between 16:9 and 4:3, the picture will flicker for a second, which is normal.

Operation

TV SETUP	
SYSTEM	PAL B/G
CHANNEL	9
FINE	438.00MHZ
BAND	UHF
SKIP	OFF
MANUAL	◀▶
AUTO	▶

To enter the TV SETUP menu

1. Select the **TV** by pressing the **TV/AV** button repeatedly.
2. Press the **MENU** button twice.
The "TV SETUP" menu is displayed.

Adjusting TV SETUP menu

1. Press the ▲ or ▼ buttons to select a item.
2. Press the ◀ or ▶ buttons to adjust.

Note

TV function is only available for LAM770T1.

SYSTEM

If the sound is abnormal, maybe the sound system setting is wrong. You can select a proper sound system as follow.

PAL B/G ↔ SECAM D/K ↔ PAL D/K

Press the ◀ or ▶ buttons to select a proper sound system.

CHANNEL

Press the ◀ or ▶ buttons to start auto search.

All active channels will be preset and stored into the memory automatically. After presetting, the TV will go to the channel before the auto search starts.

FINE

Fine tuning is unnecessary under normal conditions. However in areas of inferior broadcast conditions where adjustment is necessary for a better picture and sound, use FINE TUNE.

1. Press the ▲ or ▼ buttons to select the CHANNEL item.
2. Press the ◀ or ▶ buttons to select a channel number you want to fine tune. (For example, channel 10)
3. Press the ▲ or ▼ buttons to select the "FINE" item.
4. Press the ◀ or ▶ buttons to fine tune till the best possible picture and sound are obtained.

BAND

Press the ◀ or ▶ buttons to select the the desired frequency.

UHF ↔ VHF L ↔ VHF H

SKIP

Press the ◀ or ▶ buttons to skip a channel.

MANUAL

Press the ◀ or ▶ buttons to start manual search.

AUTO

Press the ◀ or ▶ buttons to start auto search. All active channels will be preset and stored into the memory automatically. After presetting, the TV will go to the channel before the auto search starts.

Troubleshooting

Check following points first before judging as trouble.

Although you have checked following points, if a problem still remains, call the service center in this manual and we will take a proper action. (As this product is assembled in delicate parts, only a skilled technician is recommended for the disassembly of product.)

Small red, blue and green points display on the screen.

- LCD screen is made in a high technology. So, this may happen due to lack of pixels by 0.001% or frequent lighting up of pixels. But, it is not the reason of any trouble.

Audio and Video do not work.

- Check if the starting switch of a car is on ACC or ON.
- Check whether a connection code is unstable or is disconnected.
- This does not work while driving.

Video works but Audio does not.

- Check with a volume controller if the volume level is proper.
- Check whether an output port for voice is connected.

The corner of the screen displays on TV.

- If LCD screen has been used for long dark hours, it becomes dark gradually.
- If it gets dark severely, replace its exclusive fluorescent tube.

Voice quality is bad while receiving TV signal.

- Change the frequency in case of interference from a radio station.

TV displays only in black.

- Check its color by adjusting Color Set on Menu.











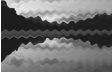



Note

TV function is only available for LAM770T1.

Troubleshooting

These cases are not the trouble.

Under following cases, it is difficult to watch TV because TV receiving signal is bad.

Screen	 Shaking	 Faded in double or triple
Sound	It noises.	It noises.
Environment	 Between Buildings	 A power cable nearby
	 At an airplane or a train passing nearby	 Deep in the mountains
Screen	 Field gets bad gradually. Color appears or disappears.	 Screen is spotted.
		 Stripes appear.
Sound	It noises.	It noises.
Environment	 In the mountain or forest	 A automobile A motorcycle A high tension wire
	 Far away from a radio station	 A neon sign nearby
	 In the neighborhood of a radio broadcasting or the transmission antenna of an amateur radio station.	

Specifications

Type.....	LCD color monitor
Power supply	DC 12 V
Consumption power	12 W
Receiving channel.....	99 channels
Operating temperature.....	-10°C - 60°C
Maintenance temperature.....	-20°C - 80°C
LCD panel.....	7 inch wide TFT LCD panel
Pixels	234 x 480
Effective pixels.....	99.99% or more
Display.....	Transmission type of color filter
Operating system	TFT active matrix
Sight angle (Left/Right)	120° (±60°)
Sight angle (Up/Down)	20°-40°
LCD lighting.....	L type CCFL
Voice power	1.5 Watt x 2
Size	W x L x H : 191.5 x 120 x 27 mm
Weight	400 g



P/NO : MFL41488902