



LG

LAD9700R

ENGLISH

AV Multimedia System

Read the manual carefully before using the unit.

The working life of this product is 7 years since the date of purchase.





Safety notes

	CAUTION RISK OF ELECTRIC SHOCK DO NOT OPEN	
CAUTION : TO REDUCE THE RISK OF ELECTRIC SHOCK DO NOT SPLIT COVER(OR BACK) NO USER SERVICEABLE PARTS INSIDE. REFER SERVICING TO QUALIFIED SERVICE PERSONNEL.		



The lightning flash with the arrowhead symbol, within an equilateral triangle is intended to alert the user about the presence of uninsulated dangerous voltage within the product's enclosure that may be of sufficient magnitude to constitute a risk of electric shock.



To reduce the risk of fire or electric shock, do not expose this product to dripping or splashing water, rain, or moisture.



The temperature of unit's outside can be extremely high, please use the unit after proper installation in your vehicle.



The exclamation point within an equilateral triangle is intended to alert the user to the presence of important operating and maintenance (servicing) instructions in the literature accompanying the appliance.



While driving, keep the sound volume at a proper level.



Always operate the vehicle in a safe manner. Do not become distracted by the vehicle while driving, and always be fully aware of all driving conditions. Do not change settings, or any functions. Pull over in a safe and legal manner before attempting such operations. To promote safety, certain functions are disabled unless the hand break is on.



Do not drop it and avoid heavy impacts at anytime.



The driver must not watch the monitor while driving. If the driver watches the monitor while driving, it may lead to carelessness and cause an accident.



This unit is for vehicles with a 12-volt battery and negative grounding. Before installing it in a recreational vehicle, lorry or bus, check the battery voltage. To avoid shorts in the electrical system, be sure to disconnect the  battery cable before beginning the installation.



Do not use for many hours at extremely low or high temperature. (-10°C to 60°C)



To reduce the risk of electric shock, do not remove the cover or back of this product. There are no user-serviceable parts inside. Refer servicing to qualified service personnel.



Safety notes

About this unit

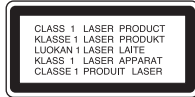

CAUTION :

This product uses a Laser System.

To ensure proper use of this product, please read this owner's manual carefully and retain it for future reference. Should the unit require maintenance, contact an authorized service center. Performing controls, adjustments, or carrying out procedures other than those specified herein may result in hazardous radiation exposure.

To prevent direct exposure to laser beam, do not try to open the enclosure.

Visible laser radiation when open. DO NOT STARE INTO BEAM.

Disposal of your old appliance



1. When this crossed-out wheeled bin symbol is attached to a product, it means the product is covered by the European Directive 2002/96/EC.
2. All electrical and electronic products should be disposed of separately from the municipal waste stream via designated collection facilities appointed by the government or the local authorities.
3. The correct disposal of your old appliance will help prevent potential negative consequences for the environment and human health.
4. For more detailed information about disposal of your old appliance, please contact your city office, waste disposal service or the shop where you purchased the product.

Before installing the unit

- This product is for vehicles with a 12-volt battery and negative earthing. Check the battery voltage of your vehicle before installation.
- To avoid shorts in the electrical system, be sure to disconnect the (-) battery cable before beginning installation.

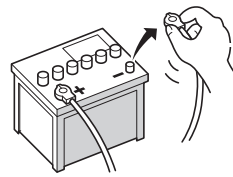

- This product cannot be installed in a vehicle that does not have an ACC (accessory) position on the ignition switch.



- The connector wiring may vary depending on the car manufacturer, even when ISO connector are used. We recommend to check the car's wiring provision before connecting the car stereo. Please pay particular attention to pin 5, where a misconnection might cause damage to the car or radio. Take special care when installing into '98 or later VW/Audi/ Skoda/Seat models as there may be a 12 V connection on Pin 5, which could damage the car stereo or into Ford from '97 or later, with an ISO connector, on which damage to the car's microcomputers is possible if misconnected. Use of ISO connector adapters available on the market may facilitate installation.



Safety notes

Types of Playable Discs



DVD (12 cm disc)



Video CD (VCD) (12 cm disc)



Audio CD (12 cm disc)

In addition, this unit plays DVD±R, DVD±RW and CD-R or CD-RW containing audio titles, MP3, WMA, JPEG, or DivX files.

- Depending on the conditions of the recording equipment or the CD-R/RW (or DVD±R/±RW) disc itself, some CD-R/RW (or DVD±R/±RW) discs cannot be played on the unit.
- Do not attach any seal or label to either side (the labeled side or the recorded side) of a disc.
- Do not use irregularly shaped CDs (e.g., heart-shaped or octagonal). It may result in malfunctions.

Precautions of handling discs and player



- A defective or soiled disc inserted into the unit can cause sound to drop during playback.
- Handle the disc by holding its inner/outer edges.
- Do not touch the surface of the unlabeled side of the disc.



Do not stick paper or tape etc. on the surface.



Do not expose the disc to direct sunlight or excessive heat.



This unit cannot play 8cm disc (use 12cm disc only).

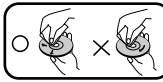

- Clean the disc before playback. Wipe the disc from the center outward with a cleaning cloth.
- Never use solvents such as benzine or alcohol to clean the disc.

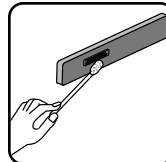

Periodically wipe the contacts on the back of the control panel with a cotton swab moistened with alcohol.

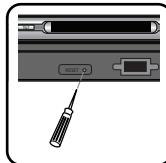

If the unit fails to operate properly, remove the control panel and then press the RESET button using a ball point pen or a similar tool.



Safety notes

About the Symbol Display

When you are watching a DVD and attempt to perform an operation, it may not be performed due to the programming on the disc. When this happens, the unit indicates the  on the screen.

Regional code



This unit is designed and manufactured for playback of region "5" encoded DVD software. This unit can only play DVD discs labeled "5" or "ALL".

Notes on Regional Codes

- Most DVD discs have a globe with one or more numbers on it clearly visible on the cover. This number must match your Car DVD Receiver's regional code or the disc cannot play.
- If you try to play a DVD with a different region code from your player, the message "Check region code" appears on the screen.

System Selection of monitor

You must select the appropriate system mode for monitor. If "NO DISC" appears in the display window, press and hold  on remote control for more than 5 seconds to be able to select a system (NTSC, PAL).

When the selected system does not coincide with the system of your monitor, normal colour picture may not be displayed.

NTSC : Select when the unit is connected with NTSC monitor.

PAL : Select when the unit is connected with PAL monitor.

NOTES ON COPYRIGHTS

It is forbidden by law to copy, broadcast, show, broadcast via cable, play in public, or rent copyrighted material without permission. This product features the copy protection function developed by Macrovision. Copy protection signals are recorded on some discs. When playing the pictures of these discs on a unit, picture noise will appear. This product incorporates copyright protection technology that is protected by method claims of certain U.S. patents and other intellectual property rights owned by Macrovision Corporation and other rights owners. Use of this copyright protection technology must be authorized by Macrovision Corporation, and is intended for home and other limited viewing uses only unless otherwise authorized by Macrovision Corporation. Reverse engineering or disassembly is prohibited.

"Manufactured under license from Dolby Laboratories. "Dolby" and double-D symbol are trademarks of Dolby Laboratories"
"DVD Logo is a trademark of DVD Format/Logo Licensing Corporation"



Table of contents

Control panel/Monitor	8
Remote control	9-10
Accessories	10
Connection	11-14
Connecting the system	11
Connecting to separately sold auxiliary device	12
Connecting the radio antenna of the vehicle	13
Connecting to a rear view camera	14
Installation	15
Basic installation/Removing the existing receiver unit	15
ISO-DIN installation/Detaching the control panel/ Attaching the control panel	15
Basic operation	16-23
Turning the unit on/ Turning the unit off/ Opening/ Closing the LCD panel	16
Inserting a disc/ Ejecting a disc/ Adjusting the volume/ Mute	16
Changing the monitor angle/ Turning the LCD panel horizontal	16
Selecting a EQ (Equalizer)/ Rear Seat Entertainment	17
Selecting a source with remote control/ Selecting a source on the screen	18
General operations of SETUP menu	18-23
Bluetooth operation	24-30
Understanding <i>Bluetooth</i> wireless technology	24
Connecting your unit and bluetooth phone	24-25
Disconnecting/Connecting again the bluetooth phone	25
Making a call with phone number/ Switching the sound path during a call	26
Making a call with speed dial numbers/ Making a call from recent calls	26
Answering calls/ Using your Phone Book	27-28
SETUP	29-30
DVD/VCD operation	31-33
Playing a DVD/VCD disc	31
Play/ Stop/ Pause/ Skip to the next chapter/track	31
Skip to the previous chapter/track	31
Return to the beginning of the current chapter/track	31
Still picture and frame-by-frame playback/ Slow motion	32
SCAN/ MENU/ SEARCH	32
REPEAT/ AUDIO/ SUBTITLE/ ANGLE/Using 	33



Table of contents

DivX operation34-35
Playing a Divx disc34
Play/ Stop/ Pause/ Skip to the next file34
Skip to the previous file34
Return to the beginning of the current file34
Still picture and frame-by-frame playback34
Slow motion/ Search/ REPEAT/ AUDIO/ SUBTITLE35
Locating a folder/file using the list35
CD/MP3/WMA operation36-37
Playing an audio CD and MP3/WMA disc36
INFORMATION36
SCAN/ REPEAT/ SHUFFLE37
Locating a folder/file using the list37
Photo operation38
Playing photo files/ Picture format38
Locating a folder/file using the list38
Radio (RDS) operation39-40
Listening to radio stations/ AS (Auto search memory)39
Storing and recalling stations/ RDS display options39
AF (Alternative frequency)/ TA (Traffic announcement identification)40
PTY (Program type recognition)/ REGION/ R-TEXT (Radio text recognition)40
Troubleshooting41
Language Codes/Area Codes42
Bluetooth phone compatibility list43-45
Specifications	

Control Panel/Monitor

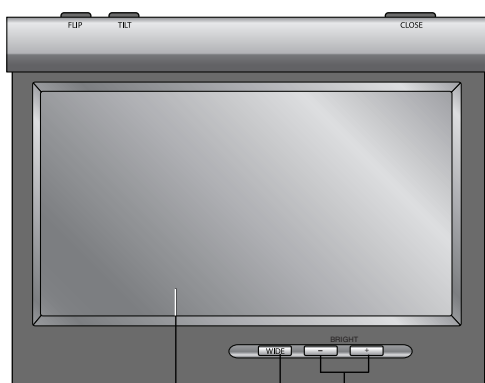
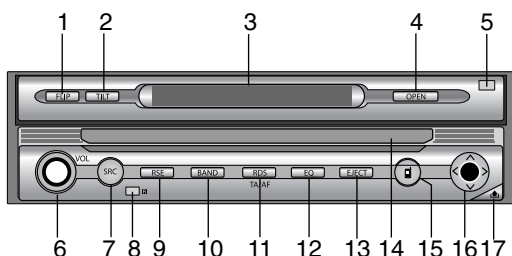

1. **FLIP**
Turns the LCD panel horizontally temporarily when the LCD panel is upright.
2. **TILT**
Adjusts the monitor angle.
3. **Display window**
4. **OPEN/CLOSE**
Opens (or Closes) the monitor.
5. **DIMMER SENSOR**
6. **Volume knob (VOL)**
 - Adjusts the volume.
 - Power on (Press it.)
 - Power off (Press a long time.)
 - Mute (Press a short time.)
7. **SRC (Source)**
Changes the sources.
8. **Remote sensor**
9. **RSE (Rear Seat Entertainment)**
10. **BAND**
Selects the band.

11. **RDS**
 - Selects the TA on/off. (Press a short time.)
 - Selects the AF on/off. (Press a long time.)
12. **EQ**
Selects various equalizer curves.
13. **EJECT**
Ejects a disc from the unit.
14. **Disc slot**
15. **PHONE (☎)**
Selects the bluetooth mode.
16. **Arrow keys (up/down/left/right)**
 - Selects the folders.
 - Selects the menu.
 - Skip (Push a short time.)
 - Seek (Push a short time.)
 - Enter

Notes

- Don't apply excessive force to the 5-way button may not work normally.



- When the 5-way button does not return to the center automatically, move it to the center position manually.

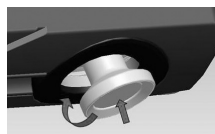

17. **📎**
Detaches the control panel.
18. **LCD**
19. **WIDE**
Changes the screen mode.
20. **BRIGHT +/-**
Adjusts the brightness of LCD.



Remote Control / Accessories

Install the battery of remote control

Pull the tray on the back of battery of remote control outward with a pencil or ball point pen and insert the battery with the plus (+) minus (-) poles pointing in the proper direction.

1. Remove the battery holder with a pencil or ball point pen.
2. Install the battery on the battery holder.
3. Install the battery holder back into its original position.

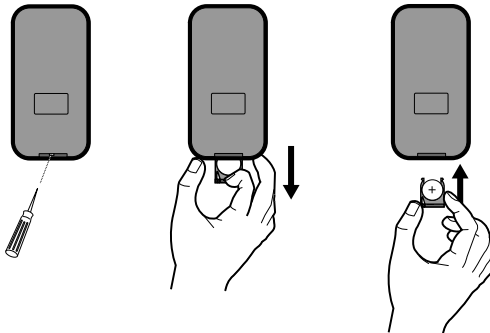

Using the remote control

Point the remote control in the direction of the control panel to operate.

Notes

- Use only one CR2025 (3V) lithium battery.
- Remove the battery if the remote control is not going to be used for a long period of time.
- Do not leave the product in a hot or humid place.
- Do not handle the battery with metallic tools.
- Do not store the battery with metallic materials.
- In the event of battery leakage, wipe the remote control completely clean and install a new battery.

Accessories

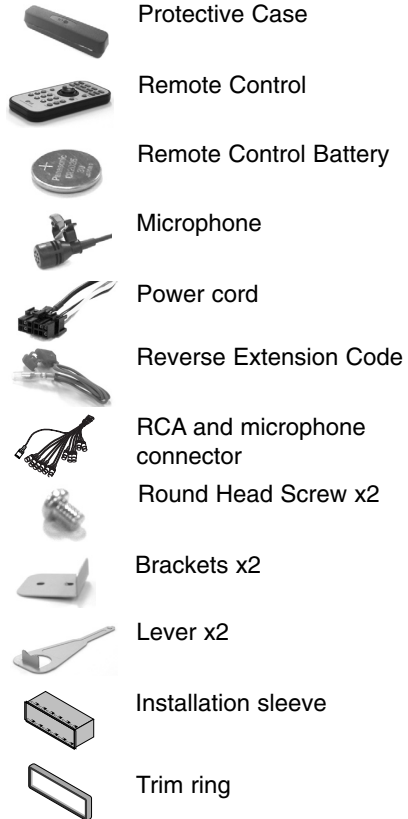



Connection

Connecting the system

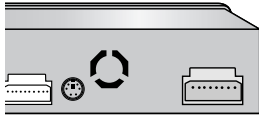

Power cord

Vehicle connector

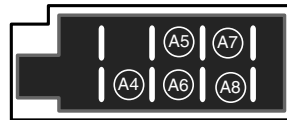

- A4 Yellow**
TO BATTERY (+)- To the car battery, continuous +12 V DC.
- A5 Blue**
POWER ANTENNA- To the power antenna
- A6 Orange**
DIMMER- This lead is for the dimmer line connection.
- A7 Red**
TO IGNITION- To the terminal from which the power is supplied when the ignition switch is set to ACC.
- A8 Black**
GROUND (-) - To the car body.

Blue/White
REMOTE ON- To the amplifier remote on.

Brown
HAND BRAKE- Be sure to wire the hand brake (parking brake) for safety and preventing accidents.

Pink
REVERSE GEAR - When connecting the rear view camera, use the reverse lead. Use a Reverse Extension if needed. (Page 14)

Speaker connector

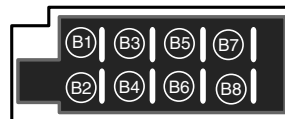

B1 : Violet : Rear Right +

B2 : Violet/ Black Stripe : Rear Right -

B3 : Gray : Front Right +

B4 : Gray / Black Stripe : Front Right -

B5 : White : Front Left +

B6 : White/Black Stripe : Front Left -

B7 : Green : Rear Left +

B8 : Green/ Black Stripe : Rear Left -

Connection

Connecting to separately sold auxiliary device

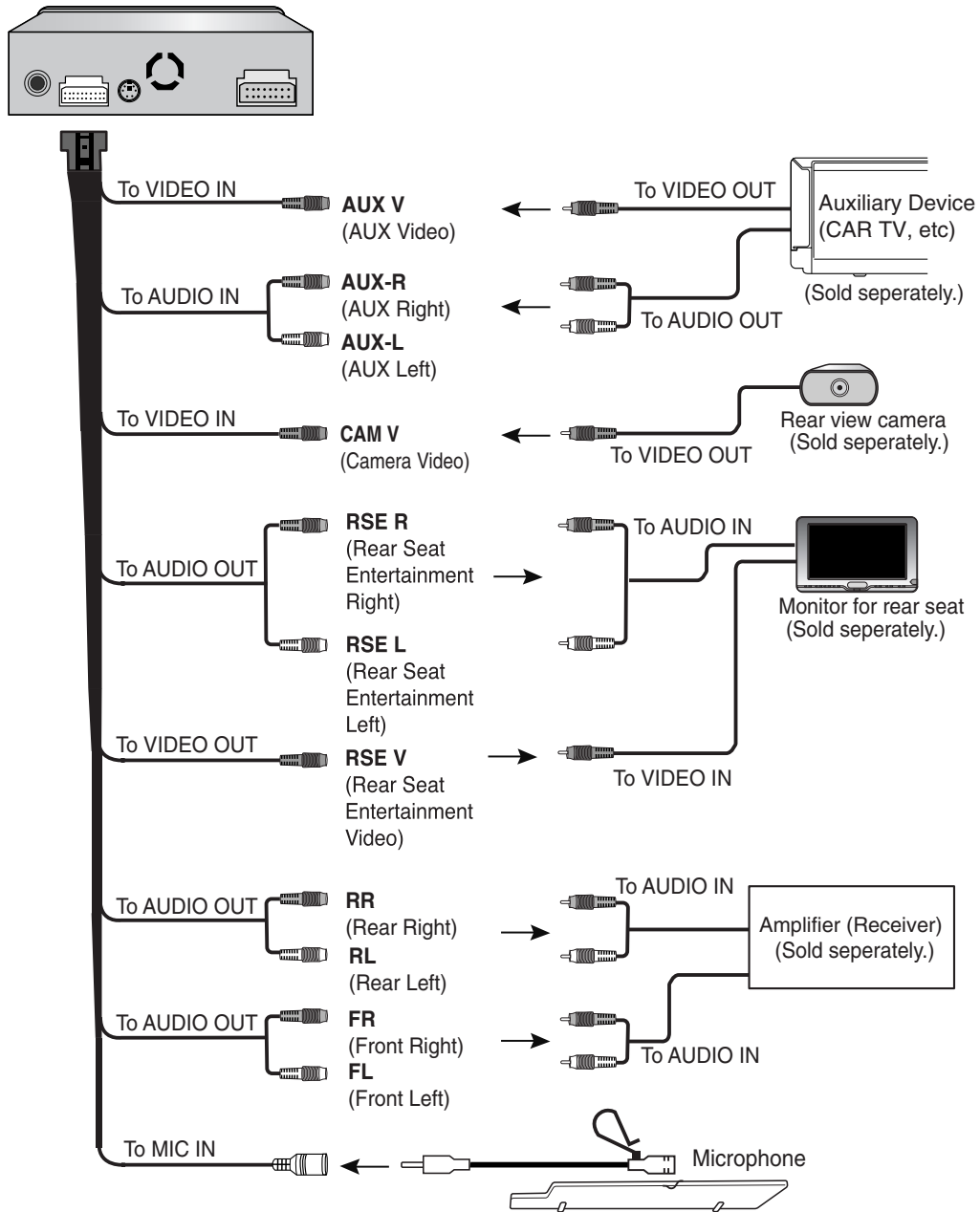



Connection

Connecting the radio antenna of the vehicle

Connect the radio antenna of the vehicle to the antenna jack of the unit.

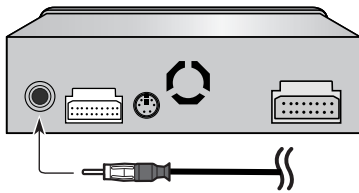



Connection

Connecting to a rear view camera

When using the unit with a rear view camera, automatic switching to video from a rear view camera is possible when the gearshift is moved to **REVERSE (R)** position. Rear view mode also allows you to check what is behind you while driving.

Notes

- Use input only for reverse or mirror image rear view camera. Other use may result in injury or damage.
- The screen image may appear reversed.
- The rear view camera function is to use this product as an aid to keep an eye on trailers, or backing into a tight parking spot. Do not use this function for entertainment purposes.
- The object in rear view may appear closer or more distant than in reality.
- Please note that the edges of the rear view camera images may differ slightly according to whether full screen images are displayed when backing, and whether the images are used for checking the rear when the vehicle is moving forward.

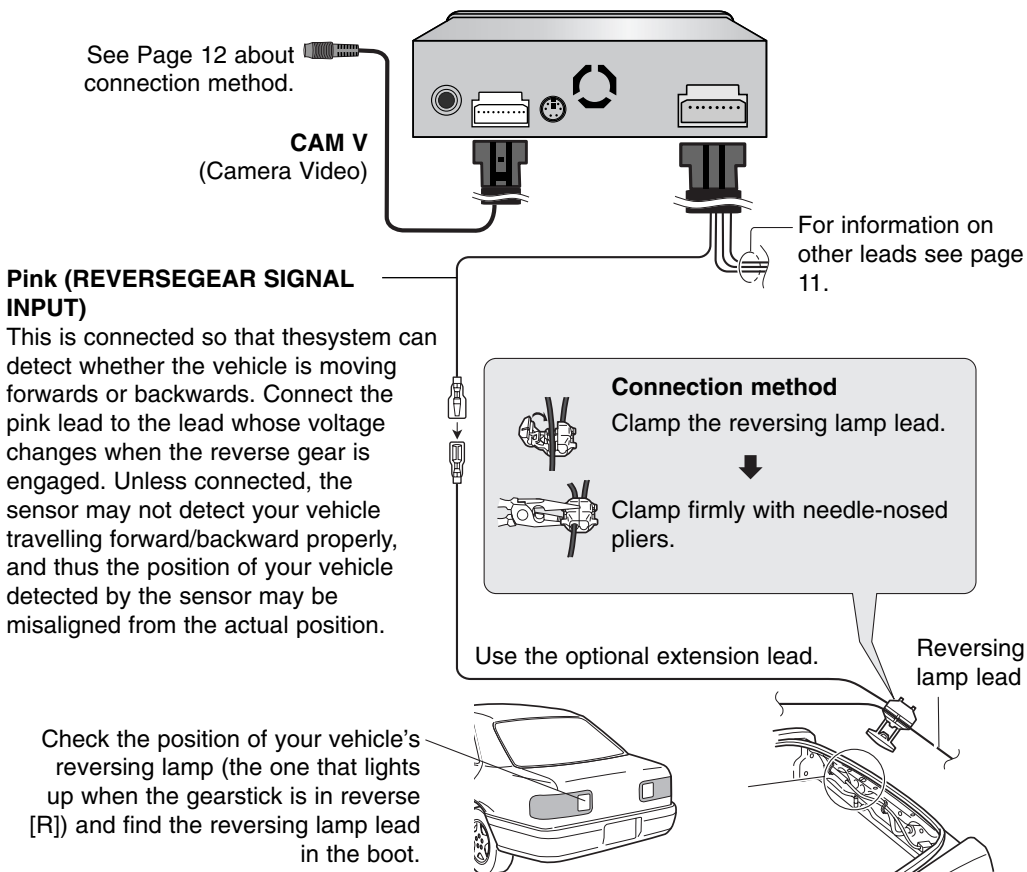



Installation

Basic installation

Before installing, make sure that the ignition-switch is set to OFF and remove the terminal of the car battery to avoid short-circuiting.

1. Remove the existing receiver unit.
2. Make the necessary connections.
3. Install the installation sleeve.
4. Install the unit into the installation sleeve.

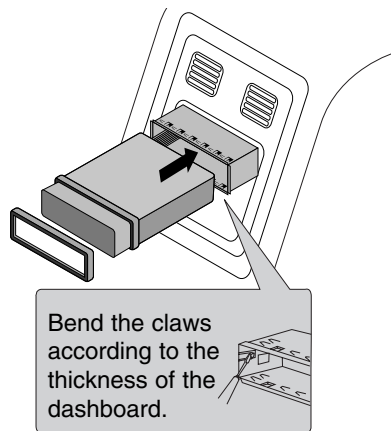

Removing the existing receiver unit

If there is already an installation sleeve for the receiver unit in the dashboard, it must be removed.

1. Remove the rear support from the unit.
2. Remove the control panel and trim ring from the unit.
3. Insert the lever **A** into the hole on one side of the unit. Perform the same operation on the other side and pull the unit out from the mounting sleeve.

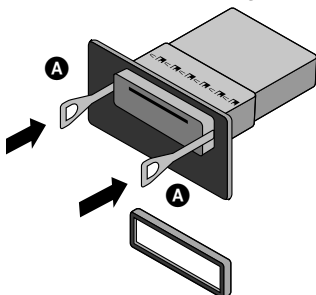

ISO-DIN Installation

1. Slide the unit into the ISO-DIN frame.
2. Install screws removed from the old unit.
3. Slide the unit and frame into the dash opening.
4. Install the dash panel or adapter plate.
5. Install the trim ring to the unit.

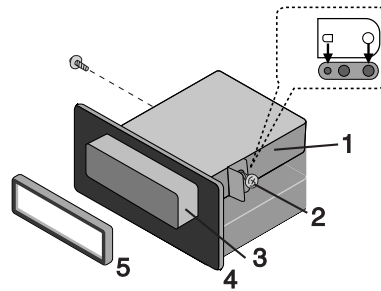

Detaching the control panel

You can detach the control panel when leaving the car.

When detaching or attaching the control panel, be careful not to damage the connector on the back of the control panel and on the panel holder.

1. Press the “” button to unlock the control panel.



2. Pull the control panel out of the unit.
3. Put the detached control panel into the provided case.

Attaching the control panel

1. Insert the left side of control panel into the groove on the panel holder.
2. Press the right side of control panel to fix it to the panel holder.



Basic operation

Turning the unit on

Press any other buttons (PWR on the remote control) except  or EJECT button on the control panel.

 **Note**

When you insert the disc in the disc slot, the unit is turned on automatically.

Turning the unit off

Press and hold “VOL” knob (PWR button on the remote control).

Opening/ Closing the LCD panel

Press the “OPEN/CLOSE” button.
The LCD panel will be opened or closed.

 **Note**

The LCD panel will be closed automatically with turning the power off.

Inserting a disc

Insert a disc in the disc slot and playback will start automatically.

Ejecting a disc

Press the “EJECT” button.
The disc is ejected from the loading slot.

 **Note**

If the ejected disc is not removed in approximately 10 seconds, the disc is automatically inserted again into the loading slot.

Adjusting the volume

Rotate the “VOL” knob (Press VOL. +/- buttons on the remote control to adjust the sound level.

 **Note**

When you turn the unit off, the current volume level is automatically memorized. Whenever you turn the unit back on, it will operate at the memorized volume level.

Mute

Press the “VOL” knob while listening to any source.
To resume the previous volume level, press the button again.

Changing the monitor angle

Press the “TILT” button to adjust the LCD panel to an easily viewable angle.
Each time you press the button, the LCD panel changes its angle step by step.

 **Note**

The adjusted LCD panel angle will be memorized and the monitor panel will automatically return to this angle next time the monitor panel is opened.

Turning the LCD panel horizontal

Press the “FLIP” button.
When the LCD panel is upright and hinders the operation of the air conditioner, the position of the panel can be turned horizontal temporarily.
To return to the original position, press the “FLIP” button again.

 **Note**

The LCD panel returns to the original position automatically with beep sounds in 10 seconds after operation.



Basic operation

Selecting a EQ (Equalizer)

Press the “EQ” button repeatedly to select a equalizer.

The mode switches as follows.

FLAT → POP → CLASSIC → ROCK →
JAZZ → VOCAL → SALSA → SAMBA →
USER → XDSS+ → FLAT...



- POP : Optimized for R&B, Soul and Country music.
- CLASSIC : Optimized for orchestral music.
- ROCK : Optimized for Hard Rock and Heavy Metal.
- JAZZ : Optimized for jazz music.
- VOCAL : Powerful realism with strong sound quality.
- SALSA : Reproduces salsa music acoustics.
- SAMBA : Reproduces samba music acoustics.
- USER : Use the menu to set the sound level you want.
- XDSS+ : Reinforces treble, bass and surround effect.

Rear Seat Entertainment

You can output any other sources via front monitor when you are playing a disc via monitor for rear seat connected to RSE OUT.

1. Insert a disc in the disc slot and playback will start automatically.
2. Press the “RSE” button until “RSE DVD” indicator appears on the screen when you are playing a disc via monitor for rear seat.



The “RSE DVD” indicator appears for a few seconds on the screen and disappears.

3. Select any other sources except for DVD/CD source by pressing the “SRC” button repeatedly.
4. To cancel it, press the “RSE” button. “RSE OFF” indicator appears on the screen.



The “RSE OFF” indicator appears for a few seconds on the screen and disappears

Notes

- When you select any other sources on the “RSE OFF” mode, the playback will stop via monitor for rear seat.
- Set the “Rear Speaker” to “Off” to optimize this function. (Page 20)



Basic operation

Selecting a source with remote control

Press SRC repeatedly to select a source. The mode switches as follows.

TUNER → DVD/CD → AUX → TUNER...

Selecting a source on the screen

You can select the source on the screen to make it operate according to your particular needs.

1. Turn the unit on.
2. Press OPEN/CLOSE to open the monitor.
3. Select the tuner or DVD/CD source by pressing SRC.
4. Touch **SOURCE** in the left position of the screen.



Note

Touch the screen on the AUX source. Press SRC on the bluetooth screen and then touch **SOURCE** in the left position of the screen.

5. Touch a source you want.

- : Touch when you want to listen to the radio broadcasting.
- : Touch when you want to play a disc.
- : Touch when you want to enter the setup menu.
- : Touch when you want to select a bluetooth.

: Touch when you want to play an auxiliary device.

: Touch when you don't want to select a source. (The time appears on the screen.)
If you cancel it, touch the screen.

General operations of SETUP menu

There are four kinds of SETUP menu : SCREEN, SOUND, DVD, RDS

1. Turn the unit on.
2. Press OPEN/CLOSE to open the monitor.
3. Select the tuner or DVD/CD source by pressing SRC.
4. Touch **SETUP** in the right position of the screen.

The "SETUP" menu appears on the screen.



Note

Touch the screen on the AUX source. Press SRC on the bluetooth screen and then touch **SOURCE** in the left position of the screen.

5. Touch the desired option.
6. Touch the desired settings then touch **End** to confirm your selection. Touch to move to the "SETUP" menu.

Basic operation

SCREEN

There are six kinds of screen menu:
Brightness/Contrast, Change Color, Adjust Dimmer, Language, Setback, Rear Camera

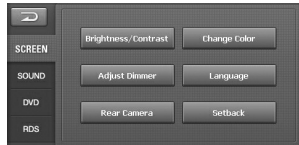

Brightness/Contrast

You can set the brightness and contrast of screen.



Touch ◀ or ▶ to adjust the settings.

Change Color

You can set the background color of screen.



Touch the option you want between **Marine Blue** and **Space Black**.

Adjust Dimmer

The dimmer adjustments for daytime, evening, and nighttime ambient lights are stored separately.
The brightness of LCD screen adjusts automatically to the optimum level in accordance with the ambient light based on the set values.



- On: Activates the functions.
- Off: Cancels the functions.

Language

You can set the display language.



Touch the language button you want.

Setback

You can move the LCD panel a little forward or backward.



- On: Activates the functions.
- Off: Cancels the functions.

Basic operation

Rear Camera



- On: The rear view through the rear view camera is automatically displayed on the monitor when the rear gear is applied.
- Off: Cancels the function.

SOUND

There are four kinds of sound menu: Balance/Fader, User Equalizer, Beep, Rear Speaker

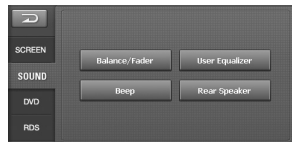

Balance/Fader



1. Touch **Left** or **Right**.
Adjust the balance—speaker output balance between the left and right speakers.
2. Touch **Front** or **Rear**.
Adjust fader—speaker output balance between the front and rear speakers.

User Equalizer

You can adjust the sound modes and store your own adjustments in memory.

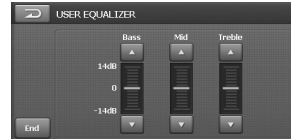

Touch **▲** or **▼** to adjust the level of each frequency band.

Beep



Beep Function

- **Off**: Cancels the function.
- **Long Key**: When long pressed, a beep sound occurs.
- **All key**: When any button is pressed, a beep sound occurs.

Beep Volume

Adjusts the Beep Volume. (Low/Medium/High)

Beep

Selects the Beep sound. (Bell/Aqua)

Rear Speaker



- On: Selects this to turn on the rear speaker output.
- Off: Selects this to turn off the rear speaker output.

Basic operation

DVD

There are four kinds of DVD menu:
DVD Language, Aspect Ratio, Lock, DivX
Registration



Note

This is only available only when you select the DVD/CD source.

DVD Language



Audio Language

If the disc contains multi-audio languages, you can change to a different audio.

Subtitle Language

If the disc contains multi-subtitle languages, you can change to a different subtitle language.

To erase the subtitle, select the "Off" button.

Menu Language

If the disc contains multi-menu languages, you can change to a different menu language.

Other

If the language you want is not listed in language menu list. Select the appropriate language code after touching **Other**. See page 42 to find the language code.



Number buttons

- **Enter**: Confirm the entered code.
- **←**: Delete the previous character at the cursor position.
- **Cancel**: Cancels the functions.

Aspect Ratio



Wide

Select when your screen's aspect ratio is fixed at 16:9 (Wide screen).

Letter Box

Select when your screen's aspect ratio is fixed at 4:3 (Conventional screen). While viewing a wide screen picture, the black bars appear on the top and the bottom of screen.

Panscan

Select when your screen's aspect ratio is fixed at 4:3.

While viewing a wide screen picture, the black bars do not appear. The left and right edges of the pictures will not be shown on the screen.



Basic operation

Lock

You can secure the device against unauthorized use by assigning a password. In addition, you can specify a rating level. If you set a rating level that is lower than the one found on the inserted DVD, it can be played only after entering the password.

If you have already assigned a password, first enter the old password with the number buttons 0-9.



Rating

Select the desired age-appropriate release 1-8.

To erase the desired age-appropriate release, select the “Off” button.

Notes

- Rating level means that some DVDs are equipped with a code that defines the age-appropriate release.
- If you have not yet assigned a password, the present password is 0000.
- If you forget your password, input the 6-digit number “210499” on the “DVD” mode of “SETUP” menu and then touch . The password is cleared.

Password

You can enter or change password.

1. Touch “Password”.
2. Enter the new password with the number buttons 0-9. And then touch .
3. Confirm the new password with the number buttons 0-9.
4. Touch to reset the password to the newly assigned one.

Area Code

1. Touch the or buttons to select the area code.
See page 42 to find the area code.
2. Touch the “End” button to exit the setup menu.

Notes

- If you have not yet assigned a password, the present password is 0000.
- Do not forget your password. A new password cannot be set without your old password.

DivX Registration

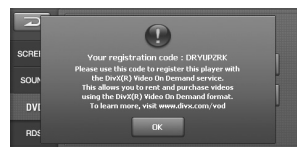

We provide you with the DivX® VOD (Video On Demand) registration code that allows you to rent and purchase videos using the DivX® VOD service.

For more information, visit www.divx.com/vod. Use the registration code to purchase or rent the videos from the DivX® VOD service at www.divx.com/vod.

Follow the instructions and download the video onto a disc for playback on this unit.

Basic operation

RDS

There are two kinds of RDS menu:
PI Mode, TA Mode

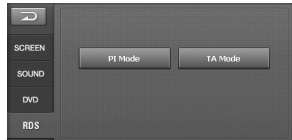

PI Mode



PI Mute

If the sound of a station with different PI is heard intermittently, the receiver mutes the sound right now.

PI Sound

If the sound of a station with different PI is heard intermittently, the receiver mutes the sound after 1 second.

TA Mode



TA Seek

When the newly tuned station does not receive TP information for 5 seconds, the receiver retunes to the next station which has the same TP information as well as the same PI as the last station.

TA Alarm

When a newly tuned station has no TP information for 5 seconds, a beep sound is output.



Bluetooth operation

Understanding Bluetooth wireless technology

Bluetooth wireless technology establishes a wireless link between two devices, such as your phone and the unit. The first time you use two devices together you must connect them by establishing a relationship using a PIN code. After the initial connecting, the two devices can connect automatically each time you turn them on.

Notes

- There may be restrictions on using Bluetooth technology in some locations.
- Due to the variety of Bluetooth phones and their firmware version, your device may respond differently when performing over Bluetooth.
- As difference in functional operation by model is mainly resulted from feature of a hands-free phone, consult manufacturer of a phone if you have any question.

Connecting your unit and bluetooth phone

To connect using the unit settings

1. Press the PHONE (P) button on the control panel. And then touch . The "SETUP" screen appears.



2. Touch **Connect Phone**. The "CONNECT PHONE" screen appears.



3. Touch **Search**.

The "Searching Bluetooth phones..." pop-up screen appears on the screen.



It will take about 25 seconds, to continue the process. If you want to cancel, touch **Cancel**.

4. Touch a bluetooth phone you desire from the "SEARCH RESULT" screen. The "Connecting Bluetooth phone..." pop-up screen appears.



5. Input the PIN code (1234) in your phone when the pop-up screen is displayed on the screen.

When it is successfully connected, the "This phone is connected." pop-up screen appears and then the mark is displayed in the "CONNECT PHONE" screen.



When it is not connected, the connection failure message appears and then the screen moves to the "CONNECT PHONE" screen.

Notes

- Before connecting, check the PIN code settings. Refer to "Changing the PIN code" on the page 30.
- This may not connect using the unit settings depending on the type of phone. Connect using the phone settings.



Bluetooth operation

To connect using the phone settings

Your phone's Bluetooth feature may be set to off by default. To use the Bluetooth feature, Bluetooth must be turned on in your phone. Refer to your phone's user guide.

1. Enable the phone's Bluetooth component. This might be in a menu called Settings, Bluetooth, Connections, or Hands-free.
2. Initiate a search for Bluetooth devices. These settings might be located in a menu called Bluetooth, Connections, or Hands-free.
3. Select the your device from the list of phone.
4. Input the PIN code (1234) in your phone. When it is successfully connected, the "This phone is connected." pop-up screen appears and then the  mark is displayed in the "CONNECT PHONE" screen.



Notes

- When you connect the headset in your phone,  icon is displayed on the upper right side.



- It works the same as the wired headset for mobile phone. The headset functionality is for telephone conversation. It is not for listening to music.

- Unlike the hands-free functionality, Headset connection will allow only two functions "answering calls" and "making a call from the latest call". Also the caller's number is not displayed when answering calls.
- If connecting through LAD9700R, initiate the hands-free connection first. If your Bluetooth phone does not support the hands-free connection, then initiate the headset connection.
- If connecting through a Bluetooth phone, the hands-free connection or headset connection may not operate depending on the type of the phone.

Disconnecting/Connecting again the bluetooth phone

1. Touch the connected phone. And then touch **OK**.



Your phone is disconnected and the  mark disappears.



2. Touch the disconnected phone again to connect your phone.

The  mark appears again.



Bluetooth operation

Making a call with phone number

Connect your unit and bluetooth phone before you make a call.

1. Press the PHONE (☎) button on the control panel.
The "PHONE" screen appears.



2. Input the phone number you want to call by touching the number buttons. And then touch **SEND**.



3. Touch **END** to finish the telephone conversations.

Notes

- If you make a mistake while dialing, touch **←** to erase one digit at a time.
- Touch **SEND** for long to make a call from a latest call.
- The user's recent call history applies only to the hands-free connection. (Making a call from a recent call with the headset connection depends on the call history of the Bluetooth phone.)
- The headset connection allows only making a call from a recent call.
- You cannot use **☎** and **☎** when calling.

Switching the sound path during a call

You can hear sound through the speaker of unit of phone by touching **☎** / **☎**.

Making a call with speed dial numbers

To make a call from a speed dial numbers, press **SEND** after pressing the speed dial number assigned to the Bluetooth phone, or press the last digit of the speed dial number for long.

Ex) When making a call from the speed dial number 10, touch 1 and touch 0 for long.



Note

Make sure that the speed dial functionality in the Bluetooth phone is enabled before using.

Making a call from recent calls

Your unit keeps a record of your recently received and dialed calls.

Touch and hold **SEND** for about 2 seconds.



Bluetooth operation

Answering calls

1. When you receive a call, your phone rings and the “Call from” pop-up screen is displayed on the screen.
2. Touch **Accept** to answer the call.

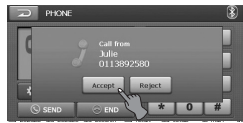

If you want to reject a call, touch **Reject**.

Notes

- If the Call-ID service is available, the caller's phone number is displayed.
- If the phone number is in the phone book, phone book entry's name is displayed.
- If the incoming call is from a number stored in your Contacts, the entry's name is displayed. The caller's phone number may also be displayed, if available.
- If “Rejecting” function is unusable, then the phone connected to the device does not support the rejecting calls function.

Using your Phone Book

You can view all entry's numbers by Phone, Home, Office.

1. Press the PHONE (☎) button on the control panel. And then Touch **☰**. The “PHONE BOOK” screen appears.



2. Touch the phone book entry you want to call.

Searching the phone number

You can search a contacts entry you want.

1. Touch **Search** on the “PHONE BOOK” screen.



Note

- Touch **AAA** to change touch button language into Latin.

Touch **☞** to change touch button language into alphabet on the Latin touch screen.

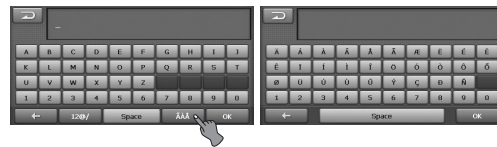

- Touch **12@/** to change touch button type into number/symbol.

Touch **☞** to change touch button language into alphabet on the number/symbol touch screen.

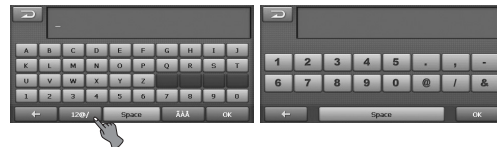

2. Enter a part of registration number or letter to search a contacts entry you want by using the keypad, **☞**, **12@/**, **Space**, **AAA**.

3. Touch **OK**.





Bluetooth operation

Adding the phone number

You can copy the phone book entries are supplied on the memory of phone to the unit.

1. Touch **Add** on the "PHONE BOOK" screen.

The "Waiting Data..." screen displays on the screen.

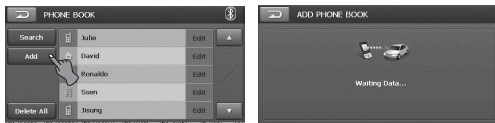

2. When you choose "Telephone No. Item Transmission" in the bluetooth phone, you can search LAD9700R.

(The bluetooth phone control method may differ according to the manufacturer. Refer to the Owner's manual.)

3. Press "Sending the phone number" in Bluetooth phone.
4. The telephone number is transmitted to the LAD9700R from the Bluetooth phone.

Note

This is only available for on the "PHONE BOOK" screen.

Deleting the phone number

You can delete all the list.

1. Touch **Delete All** on the "PHONE BOOK" screen.



2. Touch **OK**.

Editing the phone number

You can edit the information of contacts entry you want.

1. Touch **Edit** on the "PHONE BOOK" screen.



2. Touch **Info**. And then change the information.

Note

If the hands-free or headset connection has already been made, disconnect the corresponding connection to add a new contacts entry.



Bluetooth operation

SETUP

You can make various adjustments to items by using the setup menu.

1. Press the PHONE (☎) button on the control panel. And then Touch . The "SETUP" screen appears.



2. Set the items you want by touching **Connect Phone**, **Bluetooth Info**, **Save PIN Code** and **Mic Volume**.



Note

You can only operate the **Mic Volume** when calling.

Connect Phone (Connect Phone)



Search (Search)

You can search and connect a bluetooth phone. Refer to the "Connecting your unit and bluetooth phone" on the page 24.

End (End)

You can move to the "PHONE" screen.

Edit (Edit)

You can edit the information of bluetooth phone. Touch **Edit** and the pop-up screen displays in the screen.



- Info. (Information)

Touch **Info**, and the pop-up screen displays in the screen.



* Auto Connection

Bluetooth phone can be automatically connected, if there is a registered Bluetooth phone in the "CONNECT PHONE" screen and the "Auto Connection" is selected on the "REGISTERED PHONE INFORMATION" screen.

* Manual Connection

Bluetooth phone can be manually connected using the the function, if there is a registered Bluetooth phone in the "CONNECT PHONE" screen and the "Manual Connection" is selected on the "REGISTERED PHONE INFORMATION" screen.

In these cases, you would try to connect from the registered list at "CONNECT PHONE".

- Delete

You can delete the selected list.

- Cancel

Cancels the functions.

Notes

- Touch the button in the current screen to exit previous screen.
- A maximum of 6 Bluetooth phones can be registered at one time.
- Touch the or buttons to select the list you want to view.

Bluetooth operation

Bluetooth Info. (Bluetooth Info.)

You can check the Bluetooth phone information.



Name (Name)

You can change the Bluetooth phone name.

1. Touch **Name**.



2. Change the Bluetooth phone name using the keypad, **←**, **12@/**, **Space**, **AAA**.

3. Touch **OK**.



End (End)

You can move to the "PHONE" screen.

Show (Show)/ Hide (Hide)

You can select whether bluetooth phones are able to search the LAD9700R or not.

Note

Touch the **↩** button in the current screen to exit previous screen.

Save PIN Code (Save PIN Code)

You must select **On** to connect successfully your unit and bluetooth phone.



On (On)/Off (Off)

Touch **On** if you want to connect your unit and bluetooth phone. Unless, touch **Off**.

Changing the PIN code

1. Touch **PIN Code**. And then input the PIN code you want to change.



2. Touch **Enter** and the changed PIN code appears.



Mic Volume (Mic Volume)

Adjust the microphone volume by touching **-** / **+**.



DVD/VCD operation

Playing a DVD/VCD disc

The disc is drawn in, and “Disc reading” appears on the display window, and playback starts automatically.

If playback does not start, touch the screen and then touch .



DVD OSD menu

VCD OSD menu

Notes

- If there is no touch input for about 5 seconds, the indicators disappear in the menu screen.
- It takes several seconds for the unit to detect a disc type.
- In some cases, the disc menu might appear instead.
- If “⊘” appears on the screen, the disc cannot accept the operation you have tried.
- When VCD with PBC is detected, the PBC indicator appears on the screen.









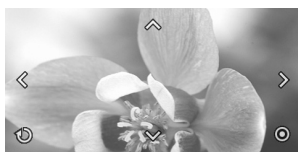

If menu screen is displayed

A menu screen may be displayed first after loading a DVD or Video 2.0 offering a menu.

This is available only for **DVD**.

1. Touch the screen in the menu screen.







2. Touch the , , , or  buttons to select the title/chapter you want to view.
 -   : Moves a cursor to up or down.
 -   : Move a cursor to left or right.
 -  : Enter to sub menu.
 -  : Moves to the DVD OSD menu.
3. Touch the “” button to start playback.

This is available only for **VCD**.

1. Touch the screen in the menu screen.



2. Touch the number 0~9 buttons, then confirm.

-  : Move a menu bar to up or down.
-  : Return to the previous screen.
-  : Moves to the VCD OSD menu.
-  : Enter to sub menu.

3. Touch the “” button to start playback.

Note

If there is no touch input for about 5 seconds, the indicators disappear in the menu screen.



Play

Touch the  button to start playback.

Stop

Touch the  button to stop.

Pause

1. Touch the  button during playback.
2. To return to playback, press the  button.

Skip to the next chapter/track

Touch briefly the  button to select the next chapter/track.

Skip to the previous chapter/track

Touch briefly the  button within 4 seconds of playing time.

Return to the beginning of the current chapter/track

Touch briefly the  button after 5 seconds of playing time.



DVD/VCD operation

Still picture and frame-by-frame playback

1. Press **II** (**II** on the remote control) during playback.
The unit will now go into the PAUSE mode.
2. You can advance the picture frame-by-frame by pressing **II** repeatedly on the remote control.
3. To return normal playback, press **▶** (PLAY **▶** on the remote control).

Slow motion

1. Press **II** (**II** on the remote control) during playback.
The unit will now go into the PAUSE mode.
2. Use **SCAN/SLOW ◀▶** on the remote control to select the required speed: **◀** 1/16, **◀** 1/8, **◀** 1/4, or **◀** 1/2 (backward), or **▶** 1/16, **▶** 1/8, **▶** 1/4, or **▶** 1/2 (forward).
With a Video CD, the Slow speed changes: **▶** 1/16, **▶** 1/8, **▶** 1/4 or **▶** 1/2 (forward).
3. To exit Slow Motion mode, press **▶** (PLAY **▶** on the remote control).

✦ Note

Slow motion playback in reverse is not possible with Video CDs.

SCAN

Touch the **◀** or **▶** buttons repeatedly to select the required speed (X2, X4, X8, X16, X32, X100).

✦ Notes

- With a VCD, the Search speed changes : (X2, X4, X8)
- To return to the normal speed, press the **▶** button.

MENU **DVD**

The menu may contain camera angles, spoken language, subtitle options and chapters for the title.

1. Touch the screen during playback.
The setup screen displays on the screen.
2. Touch the “**Menu**” button.
3. Touch the **◀**, **▶**, **⏪**, or **⏩** button to select a title you want.
4. Touch the “**⏻**” button to start playback.
⏻ : Enter to sub menu / Playback.

SEARCH

Use the number buttons to select the chapter or title you want to view.

1. Touch the screen during playback.
The setup screen displays on the screen.
2. Touch the “**Search**” button.
The number screen displays on the screen.



3. Touch the number 0~9 buttons, then confirm.
 - **◀ ▶**: Move a cursor to the desired information point.
(TITLE/CHAPTER/TIME)
 - **←**: Delete the inputted number(s).
 - **ENTER**: Enter to sub menu.
4. Touch the “**ENTER**” button.



DVD/VCD operation

REPEAT

Touch the “Repeat” button during playback.
The menu item changes as follows.

OFF → CHAPTER → TITLE... **DVD**
ALL → TRACK → ALL... **VCD**

- CHAPTER: Plays repeatedly the current chapter.
- TITLE: Plays repeatedly the current title.
- TRACK: Plays repeatedly the current track.
- ALL: Plays repeatedly all files on the current disc.
- OFF: Cancels repeat play.

Note

If you change the source, turn the power off or eject the disc, next time you select the DVD/CD player as the source or turn the power on, disc play back starts from where playback stopped previously.

AUDIO **DVD**

Touch the “Audio” button during playback.
If the disc contains multi-audio languages, you can change to a different audio language during playback.

SUBTITLE **DVD**

Touch the “Subtitle” button during playback.
If the disc contains multi-subtitle languages, you can change to a different subtitle language during playback.

ANGLE **DVD**

Touch the “Angle” button during playback.
If the disc contains multi-angle views, you can change to a different camera angle during playback.

Using

This is available only for **DVD**.
It is the function to use at the appears requiring menu selection, while playing DVDs.
The menu screen appears on the screen.
Please see page 31 for details.

DivX operation

Playing a DivX disc

The disc is drawn in, and "Disc reading" appears on the display window, and playback starts automatically.

If playback does not start, touch the screen and then touch .

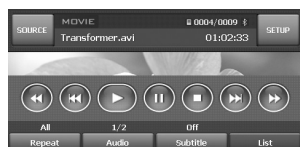

Notes

DivX disc compatibility with this player is limited as follows:

- Available resolution size of the DivX file is under 720x576 (W x H) pixels.
- The file name of the DivX subtitle has a length of 25 characters.
- If there is impossible code to express in the DivX file, it may be displayed as " * " mark on the display.
- If the number of the screen frame is over 30 per 1 second, this unit may not operate normally.
- If the video and audio structure of recorded file is not interleaved, either video or audio is output.
- Playable DivX file : *.avi, *.asf, *.div, *.divx, *.xvid
- Playable Subtitle format
 - SubRip (*.srt)
 - SAMI (*.smi)
 - SubStation Alpha (*.ssa)
 - MicroDVD (*.sub)
 - SubViewer 2.0 (*.sub)
 - Tmplayer (*.txt)
 - Advanced SubStation Alpha(*.ass)
 - DVD subtitle system (*.txt)
- Playable Codec format
"DIVX3.xx", "DIVX4.xx", "DIVX5.xx", "XVID", "MP4S"
- Playable Audio format
"Dolby Digital", "MP3"
 - Sampling frequency: within 8 - 48 kHz (MP3),
 - Bit rate: within 8 - 320kbps (MP3)



Play

Touch the  button to start playback.

Stop

Touch the  button to stop.

Pause

1. Touch the  button during playback.
2. To return to playback, press the  button.

Skip to the next file

Touch briefly the  button to select the next file.





Skip to the previous file

Touch briefly the  button within 4 seconds of playing time.

Return to the beginning of the current file

Touch briefly the  button after 4 seconds of playing time.

Still picture and frame-by-frame playback

1. Press  (|| on the remote control) during playback.
The unit will now go into the PAUSE mode.
2. You can advance the picture frame-by-frame by pressing  repeatedly on the remote control.
3. To return normal playback, press  (PLAY  on the remote control).



DivX operation

Slow motion

1. Press **⏸** (**⏸** on the remote control) during playback.
The unit will now go into the PAUSE mode.
2. Use **⏮** on the remote control to select the required speed: **⏮** 1/16, **⏮** 1/8, **⏮** 1/4, or **⏮** 1/2 (forward).
3. To exit Slow Motion mode, press **▶** (PLAY **▶** on the remote control).

Note

Slow motion playback in reverse is not possible with movie file.

Search

Touch the **⏮** or **⏭** buttons repeatedly to select the required speed (X2, X4, X16, X32).

REPEAT

Touch **Repeat** during playback.
The default setting plays all files in the disc.
The "All" is displayed on the screen.



- File: Touch **Repeat** on the default setting mode. The unit plays repeatedly the current file.
- All: Touch **Repeat** again on the file repeat mode. The unit plays repeatedly all files in the disc.
- Folder: Touch **Repeat** for about 2 seconds.
The unit plays repeatedly all files of the current folder.

AUDIO

Touch the "**Audio**" button during playback.
If the disc contains multi-audio languages, you can change to a different audio language during playback.

SUBTITLE

Touch the "**Subtitle**" button during playback.
If the disc contains multi-subtitle languages, you can change to a different subtitle language during playback.

Notice for displaying the DivX subtitle

If the subtitle does not display properly during playback, press and hold **Subtitle** repeatedly for about 3 seconds until the subtitle is displayed properly.

Locating a folder/file using the list

You can display the folder list/file list before starting play.

1. Touch the "**List**" button during playback.

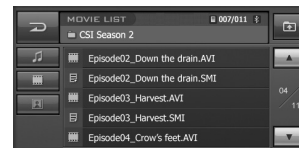

2. Touch the folder button you want.
3. Touch the file you want.
The file will be played.

- Touch the **⏮** button to select upper folder.
- Touch the **⏭** button in the current screen to exit previous screen.
- Touch the **▲** or **▼** buttons to select the list you want to view.
▲ **▼** : Previous/Next page of the list.
- When you want to classify the list as kind of file (music file, movie file or photo file), press the desired file button among the **🎵**, **🎬** or **📷** buttons.

CD/MP3/WMA operation

Playing an audio CD and MP3/WMA disc

The disc is drawn in and play starts automatically.



Notes

- The unit can play MP3/WMA formatted recordings on CD-ROM, CD-R or CD-RW (DVD-ROM, DVD-R, DVD+R, DVD-RW, DVD+RW) discs.
- MP3/WMA Disc compatibility with this unit is limited as follows:
 1. Sampling Frequency / 16 - 48 kHz (MP3) 8 - 44.1 kHz (WMA)
 2. Bit rate / within 8 - 320 kbps (include VBR) (MP3) 5 -160 kbps (WMA)
 3. CD-R/CD-RW physical format should be "ISO 9660"
 4. If you record MP3/WMA files using software which cannot create a FILE SYSTEM, for example "Direct-CD" etc., it will not be possible to playback MP3/WMA files. We recommend that you use "Easy-CD Creator" which creates an ISO9660 file system.

Customers should also note that permission is required in order to download MP3/WMA files and music from the Internet. Our company has no right to grant such permission. Permission should always be sought from the copyright owner.

Pause

1. Touch the **||** button during playback.
2. To return to playback, press the **▶** button.

Skip to the next track/file

Touch briefly the **▶▶** button to select the next track.

Skip to the previous track/file

Touch briefly the **◀◀** button within 4 seconds of playing time.

Return to the beginning of the current track/file

Touch briefly the **◀◀◀** button after 5 seconds of playing time.

Search

Touch and hold the **◀◀** or **▶▶** buttons during playback and then release at the point you want.

Skip to the previous folder/next folder

This is available only for **MP3 WMA**.

Touch briefly the **◀** or **▶** buttons to select the previous folder/the next folder.

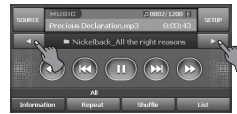

INFORMATION

Touch the **Information** button during playback.



When playing a disc containing information, you can see the CD TEXT/ID3 TAG (artist name, title name, album name).

In a CD TEXT, some information about the disc (disc title, performer and track title) is recorded.

In a ID3 TAG, some information about the file (album title, Performer name, song title, recording year, music genre and a brief comment) is recorded.



CD/MP3/WMA operation

SCAN

This is available only for **CD**.

Touch the "**Scan**" button during playback.
The item changes as follow.

All → Off (No display) → All...

- All: Plays the first 10 seconds of all tracks on the disc.

REPEAT

Touch **Repeat** during playback.

The default setting plays all files in the disc.
The "All" is displayed on the screen.



CD

- All : Plays repeatedly all files in the disc.
- Track : Plays repeatedly the current track.

MP3 WMA

- File: Touch **Repeat** on the default setting mode. The unit plays repeatedly the current file.
- All: Touch **Repeat** again on the file repeat mode. The unit plays repeatedly all files in the disc.
- Folder: Touch **Repeat** for about 2 seconds. The unit plays repeatedly all files of the current folder.

SHUFFLE

Touch the "**Shuffle**" button during playback.

CD

- All : Plays randomly all files in the disc.
- Off (No display): Cancels SHUFFLE play.

MP3 WMA

- Off (No display): Cancels SHUFFLE play.
- Folder: Touch **Shuffle**.
The unit plays randomly all files within current folder.
- All: Touch **Shuffle** for about 2 seconds.
The unit plays randomly all files in the disc.

Locating a folder/file using the list

You can display the folder list/file list before starting to play.

This is available only for **MP3 WMA**.

1. Touch the "**List**" button during playback.



2. Touch the folder button you want.
3. Touch the file you want. The file will be played.

- Touch the **+** button to select upper folder.
- Touch the **←** button in current screen to exit previous screen
- Touch the **▲** or **▼** buttons to select the list you want to view.
▲ ▼ : Previous/Next page of the list.
- If you want to classify by kind, press the **♪**, **📁** or **📄** buttons.



Photo operation

Playing photo files

The Photo viewer lets you view pictures from your device. This application recognizes JPG files.

The disc is drawn in and play starts automatically. (Slide show mode)



The previous Image and next Image arrow keys lets you display the previous or next image in the sequence of image files located in the selected folder.



The "Rotate" buttons lets you move the image clockwise (or counter clockwise). Each touch rotates the image 90 degrees.



The slide show button lets you view all JPG images in the disc in slide show mode. Photo viewer shows all pictures in full-screen mode automatically at a certain rate.

Picture format

The Load Failure warning message is displayed when the image file is too large. The picture format is not supported warning message is displayed when the image file is not saved in JPG format.

JPG : Image file size should use less than 2M pixels as 5120 x 3840 (Baseline).

Locating a folder/file using the list

You can display the folder list/file list before starting to play.

1. Touch the "List" button during playback.



2. Touch the folder button you want.
 3. Touch the file you want. The file will be played.
- Touch the button to select upper folder.
 - Touch the button in current screen to exit previous screen
 - Touch the or buttons to select the list you want to view.
 : Previous/Next page of the list.
 - If you want to classify by kind, press the , , or buttons.



Radio (RDS) operation

Listening to the radio stations

1. Press the "SRC" button to select the radio.



2. Press the "BAND" repeatedly to select a band.
The mode switches as follows.
FM1 → FM2 → FM3 → MW
3. **Seek tuning :**

Touch the or buttons.
The tuner will scan the frequencies until a broadcast with strong enough signal is found.

Manual tuning :

Touch the or buttons repeatedly until a preset number you want is selected.

AS (Auto search memory)

This function lets you automatically store the 6 strongest broadcast frequencies.

1. Select the band (FM1, FM2, FM3, MW) you want to store a station into.
2. Touch the "AS" button.



Local stations with the strongest signals are searched and stored automatically in the selected radio band.

3. To cancel, touch it again.

Storing and recalling stations

You can easily store up to 6 preset stations for later recall at the touch of a button.

1. Select the band (FM1, FM2, FM3, MW) you want to store a station into.
2. Touch the or buttons to select the desired frequency.
3. Touch and hold one of the preset buttons.
The preset station information will be displayed.

The selected preset station has been stored in memory.



4. Repeat steps 1 and 3 to preset other stations.
Next time, if you touch the preset buttons, the station is recalled from the memory.

Notes

- As FM1, FM2, FM3 have the same frequency range, up to 18 stations can be preset for FM.
- When a station is preset on the preset station button number on which another station of the same band has already been preset, the previously preset station is automatically erased.

RDS display options

The RDS system is capable of transmitting a wide variety of information in addition to the initial call sign that appears when a station is first tuned. In normal RDS operation the display will indicate the station name, broadcast network or call letters.



- **AF** (Alternative Frequencies for the actual program)
- **TA** (Traffic Announcement Identification)
- **PTY** (Program type recognition)
- **RT** (Radio text recognition)
- **PS** (Program Service name)
- **PI** (Program Identification) :
Contains additional information for regional program operation
- **TP** (Traffic Program Identification)



Radio (RDS) operation

AF (Alternative frequency)

When the reception quality drops, the tuner automatically changes to another station in the network, broadcasting a better reception quality, using the PI and AF codes.

This means : wherever you drive, you can continue to listen to the same program without interruptions.

1. Touch the “**AF**” button.
“AF On” appears on the screen.
2. To cancel, touch it again.

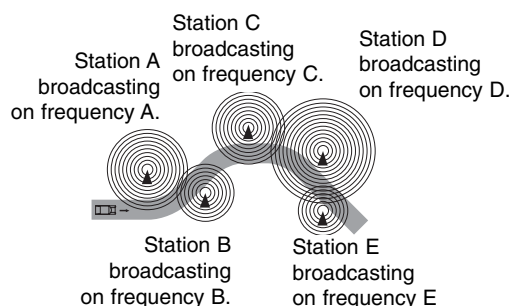

TA (Traffic announcement identification)

This is an ON/OFF switching signal that indicates when a traffic announcement is on air.

1. Touch the “**TA**” button.
The “TA On” appears on the screen.



2. To cancel, touch it again.

PTY (Program type recognition)

You can select your favorite program type.

1. Touch the “**PTY**” button.
2. The PTY list displays in the screen.



3. Touch one of your favorite program types.
4. Touch one of your favorite PTY code name.
5. “PTY SEARCH” appears on the screen.
6. To cancel, touch “**OFF**” button.

REGION

1. Touch the “**REGION**” button.
The “On” appears on the screen.
2. To cancel, touch it again.

On: Network-Tracking is activated.

The unit switches to another station, within the same network, broadcasting the same program when the receiving signals from the current station become weak.

Off: Network-Tracking is activated.

The unit switches to another station, within the same network when the receiving signals from the current station become weak. (In the mode, the program may differ from the one currently received.)

Notes

- RDS is only available for FM reception.
- Touch the button in current screen to exit the previous screen.

R-TEXT (Radio text recognition)

The radio station’s information is displayed on the screen.

1. Touch the “**R-TEXT**” button.
Radio text appears on the screen.
2. To cancel, touch it again.

Note

Some RDS stations may not choose to include some of these additional features. If the data required for the selected mode is not being transmitted, the screen will show a “RadioText Information” message.





Troubleshooting

Symptom	Cause	Correction
Power doesn't turn on. The unit doesn't operate.	<ul style="list-style-type: none"> Leads and connector are not properly connected. The fuse is blown. Noise and other factors are causing the built-in microprocessor to operate incorrectly. 	<ul style="list-style-type: none"> Confirm once more that all connections are correct. Rectify the problem that caused the fuse to blow, and then replace it. Be very sure to install the correct fuse with the same rate. Turn the unit off and then on.
Playback is not possible.	<ul style="list-style-type: none"> The disc is dirty. The loaded disc is of a type this unit cannot play. 	<ul style="list-style-type: none"> Clean disc. Check what type the disc.
No sound is heard. The volume level will not rise.	<ul style="list-style-type: none"> Cables are not connected correctly. 	<ul style="list-style-type: none"> Connect the cables correctly.
There's no sound.	<ul style="list-style-type: none"> The volume level is low. 	<ul style="list-style-type: none"> Adjust the volume.
There's audio skipping.	<ul style="list-style-type: none"> This unit is not firmly secured. 	<ul style="list-style-type: none"> Secure this unit firmly.
The unit does not operate correctly even when the appropriate remote control buttons are pressed.	<ul style="list-style-type: none"> Battery power is low. Some operations are prohibited with certain discs. 	<ul style="list-style-type: none"> Load new battery. Check using another disc.



Language Codes/Area Codes

Language Codes

Use this list to input your desired language for the following initial settings:
Disc Audio, Disc Subtitle, Disc Menu.

Language	Code	Language	Code	Language	Code	Language	Code
Abkhazian	6566	Fiji	7074	Lingala	7678	Singhalese	8373
Afar	6565	Finnish	7073	Lithuanian	7684	Slovak	8375
Afrikaans	6570	French	7082	Macedonian	7775	Slovenian	8376
Albanian	8381	Frisian	7089	Malagasy	7771	Somali	8379
Ameharic	6577	Galician	7176	Malay	7783	Spanish	6983
Arabic	6582	Georgian	7565	Malayalam	7776	Sudanese	8385
Armenian	7289	German	6869	Maltese	7784	Swahili	8387
Assamese	6583	Greek	6976	Maori	7773	Swedish	8386
Aymara	6588	Greenlandic	7576	Marathi	7782	Tagalog	8476
Azerbaijani	6590	Guarani	7178	Moldavian	7779	Tajik	8471
Bashkir	6665	Gujarati	7185	Mongolian	7778	Tamil	8465
Basque	6985	Hausa	7265	Nauru	7865	Tatar	8484
Bengali; Bangla	6678	Hebrew	7387	Nepali	7869	Telugu	8469
Bhutani	6890	Hindi	7273	Norwegian	7879	Thai	8472
Bihari	6672	Hungarian	7285	Oriya	7982	Tibetan	6679
Breton	6682	Icelandic	7383	Panjabi	8065	Tigrinya	8473
Bulgarian	6671	Indonesian	7378	Pashto, Pushto	8083	Tonga	8479
Burmese	7789	Interlingua	7365	Persian	7065	Turkish	8482
Byelorussian	6669	Irish	7165	Polish	8076	Turkmen	8475
Cambodian	7577	Italian	7384	Portuguese	8084	Twi	8487
Catalan	6765	Japanese	7465	Quechua	8185	Ukrainian	8575
Chinese	9072	Javanese	7487	Rhaeto-Romance	8277	Urdu	8582
Corsican	6779	Kannada	7578	Rumanian	8279	Uzbek	8590
Croatian	7282	Kashmiri	7583	Russian	8285	Vietnamese	8673
Czech	6783	Kazakh	7575	Samoan	8377	Volapük	8679
Danish	6865	Kirghiz	7589	Sanskrit	8365	Welsh	6789
Dutch	7876	Korean	7579	Scots Gaelic	7168	Wolof	8779
English	6978	Kurdish	7585	Serbian	8382	Xhosa	8872
Esperanto	6979	Laothian	7679	Serbo-Croatian	8372	Yiddish	7473
Estonian	6984	Latin	7665	Shona	8378	Yoruba	8979
Faroeese	7079	Latvian, Lettish	7686	Sindhi	8368	Zulu	9085

Area Codes

Choose a area code from this list.

Area	Code	Area	Code	Area	Code	Area	Code
Afghanistan	AF	Ethiopia	ET	Malaysia	MY	Saudi Arabia	SA
Argentina	AR	Fiji	FJ	Maldives	MV	Senegal	SN
Australia	AU	Finland	FI	Mexico	MX	Singapore	SG
Austria	AT	France	FR	Monaco	MC	Slovak Republic	SK
Belgium	BE	Germany	DE	Mongolia	MN	Slovenia	SI
Bhutan	BT	Great Britain	GB	Morocco	MA	South Africa	ZA
Bolivia	BO	Greece	GR	Nepal	NP	South Korea	KR
Brazil	BR	Greenland	GL	Netherlands	NL	Spain	ES
Cambodia	KH	Heard and McDonald Islands	HM	Netherlands Antilles	AN	Sri Lanka	LK
Canada	CA	Hong Kong	HK	New Zealand	NZ	Sweden	SE
Chile	CL	Hungary	HU	Nigeria	NG	Switzerland	CH
China	CN	India	IN	Norway	NO	Taiwan	TW
Colombia	CO	Indonesia	ID	Oman	OM	Thailand	TH
Congo	CG	Israel	IL	Pakistan	PK	Turkey	TR
Costa Rica	CR	Italy	IT	Panama	PA	Uganda	UG
Croatia	HR	Jamaica	JM	Paraguay	PY	Ukraine	UA
Czech Republic	CZ	Japan	JP	Philippines	PH	United States	US
Denmark	DK	Kenya	KE	Poland	PL	Uruguay	UY
Ecuador	EC	Kuwait	KW	Portugal	PT	Uzbekistan	UZ
Egypt	EG	Libya	LY	Romania	RO	Vietnam	VN
El Salvador	SV	Luxembourg	LU	Russian Federation	RU	Zimbabwe	ZW



Bluetooth phone compatibility list

- If even a phone as described in this list meets requirements of Bluetooth Hand-free Profile 1.0 and Object Push Profile 1.1, it can operate. However, it is noted that we cannot assure for operation by function.
- As difference in functional operation by model is mainly resulted from feature of a hand-free phone, consult manufacturer of a phone if you have any question.

O: Support, X: No support

Manufacturer	Model	Set				Phone				Reject	Answer	DTMF-Tone	Audio switch	Hang up	Dialing			Phone book	Remarks
		Search	Pairing	Connect	Disconnect	Search	Pairing	Connect	Disconnect						Dialing	Last	Memory		
LG	KG800	O	O	O	O	O	O	O	O	O	O	O	O	O	O	O	O	O	Note3
LG	U890	O	O	O	O	O	O	O	O	X	O	O	O	O	O	O	O	O	Note3, Note6
LG	KE970	O	O	O	O	O	O	O	O	O	O	O	O	O	O	O	O	O	Note3
LG	M4410	O	O	O	O	O	O	O	O	O	O	O	O	O	O	O	O	O	Note3
LG	ME970	O	O	O	O	O	O	O	O	O	O	O	O	O	O	O	O	O	Note3
LG	KE850	O	O	O	O	O	O	O	O	O	O	O	O	O	O	O	O	O	Note3
LG	MG280	O	O	O	O	O	O	O	O	O	O	O	O	O	O	O	O	O	Note3
LG	KE500	O	O	O	O	O	O	O	O	O	O	O	O	O	O	O	O	O	Note14
LG	KG290	O	O	O	O	O	O	O	O	O	O	O	O	O	O	O	O	O	
LG	KU380	O	O	O	O	O	O	O	O	O	O	O	O	O	O	O	O	O	Note3
LG	KU580 (3G)	O	O	O	O	O	O	O	O	O	O	O	O	O	O	O	O	O	Note3
LG	KU970 (3G)	O	O	O	O	O	O	O	O	O	O	O	O	O	O	O	O	O	Note3
LG	KU950	O	O	O	O	O	O	O	O	O	O	O	O	O	O	O	O	O	
LG	KE600	O	O	O	O	O	O	O	O	O	O	O	O	O	O	O	O	O	Note3
LG	KG338	O	O	O	O	O	O	O	O	O	O	O	O	O	O	O	O	O	Note14
LG	CU575 (3G)	O	O	O	O	O	O	O	O	O	O	O	O	O	O	O	O	O	Note3
LG	SV240	O	O	O	O	O	O	O	O	X	O	O	O	O	O	O	O	O	Note3
LG	KF1000	O	O	O	O	O	O	O	O	O	O	O	O	O	O	O	O	O	Note3
LG	LP-3900	O	O	O	O	O	O	O	O	O	O	O	O	O	O	O	O	X	Note10
LG	LV2400	O	O	O	O	O	O	O	O	X	O	O	O	O	O	O	O	O	Note3
Samsung	T509	O	O	O	O	O	O	O	O	O	O	O	O	O	O	O	O	O	Note5
Samsung	Z540v	O	O	O	O	O	O	O	O	O	O	O	O	O	O	O	O	O	Note5
Samsung	D820	O	O	O	O	O	O	O	O	O	O	O	O	O	O	O	O	O	Note5,Note14
Samsung	SCH-B380	O	O	O	O	O	O	O	O	O	O	O	O	O	O	O	O	O	Note5,Note14
Samsung	SPH-V9000	O	O	O	O	O	O	O	O	O	O	O	O	O	O	O	O	O	Note5,Note14
Samsung	SPH-V7450	O	O	O	O	O	O	O	O	O	O	O	O	O	O	O	O	O	Note5
Nokia	3230	O	O	O	O	O	O	O	O	O	O	O	O	O	O	O	O	O	Note4
Nokia	3250	O	O	O	O	O	O	O	O	O	O	O	O	O	O	O	O	O	Note2,Note4
Nokia	6021	O	O	O	O	O	O	O	O	O	O	O	O	O	O	O	O	O	Note8,Note4
Nokia	6681	O	O	O	O	O	O	O	O	O	O	O	O	O	O	O	O	O	Note4
Nokia	6820	O	O	O	O	O	O	O	O	O	O	O	O	O	O	O	O	O	Note2,Note4
Nokia	8800	O	O	O	O	O	O	O	O	O	O	O	O	O	O	O	X	O	Note7,Note4
Nokia	5300	O	O	O	O	O	O	O	O	O	O	O	O	O	O	O	X	O	Note7,Note4
Nokia	5500	O	O	O	O	O	O	O	O	O	O	O	O	O	O	O	O	O	Note4
Nokia	N-gage	O	O	O	O	O	O	O	O	O	O	O	O	O	O	O	O	O	Note4
Nokia	E50	O	O	O	O	O	O	O	O	O	O	O	O	O	O	O	O	O	Note4



Bluetooth phone compatibility list

Manufacturer	Model	Set			Phone				Reject	Answer	DTMF-Tone	Audio switch	Hang up	Dialing			Phone book	Remarks
		Search	Pairing	Connect	Disconnect	Search	Pairing	Connect						Disconnect	Dialing	Last		
Nokia	E62	O	O	O	O	O	O	O	O	O	O	O	O	O	O	O	O	Note4
Nokia	E70	O	O	O	O	O	O	O	O	O	O	O	O	O	O	O	O	Note4
Nokia	N73	O	O	O	O	O	O	O	O	O	O	O	O	O	O	O	O	Note4
Nokia	N80	O	O	O	O	O	O	O	O	O	O	O	O	O	O	O	O	Note4
Nokia	N92	O	O	O	O	O	O	O	O	O	O	O	O	O	O	O	O	Note4
Nokia	E60	O	O	O	O	O	O	O	O	O	O	O	O	O	O	O	O	Note4
Nokia	E61	O	O	O	O	O	O	O	O	O	O	O	O	O	O	O	O	Note4
Nokia	3650	O	O	O	O	O	O	O	O	O	O	O	O	O	O	O	O	Note4
Nokia	6103	O	O	O	O	O	O	O	O	O	O	O	O	O	O	O	O	Note8, Note4
Nokia	6131	O	O	O	O	O	O	O	O	O	O	O	O	O	O	O	O	Note4
Nokia	6230	O	O	O	O	O	O	O	O	O	O	O	O	O	O	O	O	Note4
Nokia	6230i	O	O	O	O	O	O	O	O	O	O	O	O	O	O	O	O	Note4
Nokia	6280	O	O	O	O	O	O	O	O	O	O	O	O	O	O	X	O	Note7, Note4
Nokia	6630	O	O	O	O	O	O	O	O	O	O	O	O	O	O	O	O	Note2, Note4
Nokia	6650	O	O	O	O	O	O	O	O	O	O	O	O	O	O	O	O	Note2, Note4
Nokia	6600	O	O	O	O	O	O	O	O	O	O	O	O	O	O	O	O	Note2, Note4
Nokia	6670	O	O	O	O	O	O	O	O	O	O	O	O	O	O	O	O	Note2, Note4
Nokia	6680	O	O	O	O	O	O	O	O	O	O	O	O	O	O	O	O	Note2, Note4
Nokia	6820a	O	O	O	O	O	O	O	O	O	O	O	O	O	O	O	O	Note2, Note4
Nokia	7370	O	O	O	O	O	O	O	O	O	O	O	O	O	O	O	O	Note4
Nokia	7380	O	O	O	O	O	O	O	O	O	O	O	O	O	O	O	O	Note4
Nokia	7610	O	O	O	O	O	O	O	O	O	O	O	O	O	O	O	O	Note4
Nokia	8910i	O	O	O	O	O	O	O	O	O	O	O	O	O	O	O	O	Note4
Nokia	9500	O	O	O	O	O	O	O	O	O	O	O	O	O	O	O	X	Note2, Note4, Note10
Motorola	V500	O	O	O	O	O	O	O	O	O	O	O	O	O	O	O	O	Note1
Motorola	V360	O	O	O	O	O	O	O	O	O	O	O	O	O	O	O	O	Note1, Note2
Motorola	E680	O	O	O	O	O	O	O	O	O	O	O	O	O	O	O	O	Note1
Motorola	E680i	O	O	O	O	O	O	O	O	O	O	O	O	O	O	O	O	Note1
Motorola	A780	O	O	O	O	O	O	O	O	O	O	O	O	O	O	O	O	Note1
Motorola	V3X	O	O	O	O	O	O	O	O	O	O	O	O	O	X	O	O	Note1, Note7
Motorola	U6	O	O	O	O	O	O	O	O	O	O	O	O	O	O	O	O	Note1
Motorola	V360	O	O	O	O	O	O	O	O	O	O	O	O	O	O	O	O	Note1, Note2
Motorola	V525	O	O	O	O	O	O	O	O	O	O	O	O	O	O	O	O	Note1, Note2
Motorola	E550	O	O	O	O	O	O	O	O	O	O	O	O	O	O	O	O	Note1
Motorola	V600	O	O	O	O	O	O	O	O	O	O	O	O	O	O	O	O	Note1, Note2
Motorola	E1000	O	O	O	O	O	O	O	O	O	O	O	O	O	O	O	O	Note1, Note2
Motorola	A1000	O	O	O	O	X	X	X	X	O	O	O	O	O	O	O	O	Note1, Note2, Note12
Motorola	RAZR V3i	O	O	O	O	O	O	O	O	O	O	O	O	O	O	O	O	Note1
Sony Ericsson	Z608	O	O	O	O	O	O	O	O	O	O	O	O	O	O	O	O	
Sony Ericsson	T618	O	O	O	O	O	O	O	O	O	O	O	O	O	O	O	O	
Sony Ericsson	T628	O	O	O	O	O	O	O	O	O	O	O	O	O	O	O	O	
Sony Ericsson	K700c	O	O	O	O	O	O	O	O	O	O	O	O	O	O	O	O	
Sony Ericsson	P908	X	X	X	X	O	O	O	O	O	O	O	O	O	O	O	O	Note11



Bluetooth phone compatibility list

Manufacturer	Model	Set				Phone				Reject	Answer	DTMF-Tone	Audio switch	Hang up	Dialing			Phone book	Remarks
		Search	Pairing	Connect	Disconnect	Search	Pairing	Connect	Disconnect						Dialing	Last	Memory		
Sony Ericsson	P990i	O	O	O	O	O	O	O	O	O	O	O	O	O	O	O	O	O	
Sony Ericsson	T610	O	O	O	O	O	O	O	O	O	O	O	O	O	O	O	O	O	
Sony Ericsson	W710i	O	O	O	O	O	O	O	O	O	O	O	O	O	O	O	O	O	
Sony Ericsson	K800i	O	O	O	O	O	O	O	O	O	O	O	O	O	O	O	O	O	
Sony Ericsson	W850i	O	O	O	O	O	O	O	O	O	O	O	O	O	O	O	O	O	
Sony Ericsson	T610	O	O	O	O	O	O	O	O	O	O	O	O	O	O	O	O	O	
Sony Ericsson	Z600	O	O	O	O	O	O	O	O	O	O	O	O	O	O	O	O	O	
Sony Ericsson	S700i	O	O	O	O	O	O	O	O	O	O	O	O	O	O	O	O	O	
Sony Ericsson	K700i	O	O	O	O	O	O	O	O	O	O	O	O	O	O	O	O	O	
Sony Ericsson	V800	O	O	O	O	O	O	O	O	O	O	O	O	O	O	O	O	O	
Siemens	SL75	O	O	O	O	O	O	X	X	O	O	O	O	O	O	O	O	O	Note12
Siemens	S65	O	O	O	O	O	O	O	O	O	O	O	O	O	O	O	O	O	
Siemens	SX1	O	O	O	O	O	O	O	O	O	O	O	O	O	O	O	O	O	Note4
Siemens	SK65	O	O	O	O	O	O	O	O	O	O	O	O	O	O	O	O	O	
Pantech	PG6200	O	O	O	O	O	O	O	O	O	X	O	O	O	O	O	O	O	Note14, Note9
Panasonic	X800	O	O	O	O	O	O	O	O	O	O	O	O	O	O	O	O	O	
NEC	N750	X	X	O	O	O	O	O	X	O	O	X	O	O	O	O	O	X	Note10, Note11, Note13
NEC	N930	X	X	O	O	O	O	O	O	O	O	O	O	O	O	O	O	X	Note10, Note11, Note13
Sharp	GX15	O	O	O	O	O	O	O	O	O	O	O	O	O	O	O	O	O	
Sharp	GX30	O	X	O	O	O	O	O	O	O	O	O	O	O	O	O	O	X	Note10, Note12
K-JAM	i_mate	O	O	O	O	O	O	O	O	O	O	O	O	O	O	O	O	O	

Remarks

Bluetooth may not operate if you connect the unit to headset or your phone is not initial screen condition depending on type of phone.

- Note1: Discoverable time is limited.
- Note2: This phone accepts PIN code for limited time.
- Note3: If you connect the unit and your phone at the first time, make a connection at your phone's settings first.
- Note4: If you switch the sound path during a call, the connection is broken.
- Note5: Keep your phone "Enable" (Or open a folder or slide-up) for connection or DTMF function.
- Note6: This phone does not support REJECT function.
- Note7: This phone does not support MEMORY DIAL function.
- Note8: This phone makes a call in a last dialed order without MEMORY DIAL function.
- Note9: This phone does not support DTMF function.
- Note10: This phone does not support PHONEBOOK function.
- Note11: Make a connection at your phone's settings.
- Note12: Make a connection at your unit's settings.
- Note13: The Call ID is not displayed.
- Note14: Touch "SEND" twice to get a call with the stored phone number.



Specifications

GENERAL

Output Power	50W x 4CH (Max.)
Power Source	DC 12V
Speaker impedance	4 Ω
Ground System	Negative
Dimensions (W x H x D)	180 x 53 x 198 mm
Net Weight	2.37 kg

DISPLAY

LCD	7 inch TFT LCD
Resolution	480 X 234
Back Light	LED type

CD/DVD/VCD SECTION

Frequency Response	20 Hz-20 kHz
S/N Ratio	80 dB
Distortion	0.15 %
Channel Separation (1kHz)	60 dB

RADIO SECTION

FM

Frequency Range	87.5-107.9 or 87.5-108 MHz
S/N Ratio	55 dB
Distortion	0.7 %
Usable Sensitivity	12 dB μ V

MW (AM)

Frequency Range	520-1720 or 522-1620 kHz
S/N Ratio	45 dB
Distortion	1.0 %
Usable Sensitivity	32 dB μ V



"The Bluetooth word mark and logos are owned by the Bluetooth SIG, Inc. and any use of such marks by LG Electronics is under license. Other trademarks and trade names are those of their respective owners."

P/N: MFL41634255