



LG Electronics Inc.

LCD TV | PLASMA TV OWNER'S MANUAL

LCD TV MODELS	PLASMA TV MODELS
26LC4R	42PC5R
26LC4RA	42PC5RV
26LC7R	42PC5RVH
32LC4R	50PC5R
37LC4R	42PC7RA
42LC4R	42PC7RAH

Please read this manual carefully and completely before operating your set. Retain it for future reference. Record model number and serial number of the set. See the label attached on the back cover and quote this information to your dealer when you require service.

WARNING

IMPORTANT SAFETY INSTRUCTIONS

Important safety instructions shall be provided with each apparatus. This information shall be given in a separate booklet or sheet, or be located before any operating instructions in an instruction for installation for use and supplied with the apparatus.

This information shall be given in a language acceptable to the country where the apparatus is intended to be used.

The important safety instructions shall be entitled "Important Safety Instructions". The following safety instructions shall be included where applicable, and, when used, shall be verbatim as follows. Additional safety information may be included by adding statements after the end of the following safety instruction list. At the manufacturer's option, a picture or drawing that illustrates the intent of a specific safety instruction may be placed immediately adjacent to that safety instruction :

Read these instructions.
Keep these instructions.
Heed all warnings.
Follow all instructions.



- 1 Do not use this apparatus near water.



- 2 Clean only with dry cloth.



- 3 Do not block any ventilation openings. Install in accordance with the manufacturer's instructions.



- 4 Do not install near any heat sources such as radiators, heat registers, stoves, or other apparatus (including amplifiers) that produce heat.



- 5 Do not defeat the safety purpose of the polarized or grounding-type plug. A polarized plug has two blades with one wider than the other. A grounding type plug has two blades and a third grounding prong. The wide blade or the third prong are provided for your safety. If the provided plug does not fit into your outlet, consult an electrician for replacement of the obsolete outlet.



WARNING

IMPORTANT SAFETY INSTRUCTIONS

- 6 Protect the power cord from being walked on or pinched particularly at plugs, convenience receptacles, and the point where they exit from the apparatus.



- 7 Only use attachments/accessories specified by the manufacturer.



- 8 Unplug this apparatus when unused for long periods of time.

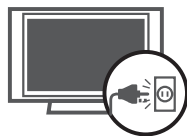

- 9 Use only with the cart, stand, tripod, bracket, or table specified by the manufacturer, or sold with the apparatus. When a cart is used, use caution when moving the cart/apparatus combination to avoid injury from tip-over.



- 10 Never touch this apparatus or antenna during a thunder or lightning storm.

- 11 Do not allow a impact shock or any objects to fall into the product, and do not drop onto the screen with something. (You may be injured or the product can be damaged.)

- 12 Refer all servicing to qualified service personnel. Servicing is required when the apparatus has been damaged in any way, such as power-supply cord or plug is damaged, liquid has been spilled or objects have fallen into the apparatus, the apparatus has exposed to rain or moisture, does not operate normally, or has been dropped.



WARNING

- 13** CAUTION concerning the Power Cord : Most appliances recommend they be placed upon a dedicated circuit; that is, a single outlet circuit which powers only that appliance and has no additional outlets or branch circuits. Check the specification page of this owner's manual to be certain.

Do not overload wall outlets. Overloaded wall outlets, loose or damaged wall outlets, extension cords, frayed power cords, or damaged or cracked wire insulation are dangerous. Any of these conditions could result in electric shock or fire. Periodically examine the cord of your appliance, and if its appearance indicates damage or deterioration, unplug it, discontinue use of the appliance, and have the cord replaced with an exact replacement part by an authorized servicer. Protect the power cord from physical or mechanical abuse, such as being twisted, kinked, pinched, closed in a door, or walked upon. Pay particular attention to plugs, wall outlets, and the point where the cord exits the appliance.

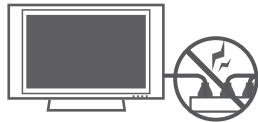

- 14** Outdoor Use Marking :
WARNING - To Reduce The Risk Of Fire Or Electric Shock, Do Not Expose This Appliance To Rain Or Moisture



- 15** Wet Location Marking : Apparatus shall not be exposed to dripping or splashing and no objects filled with liquids, such as vases, shall be placed on or over apparatus.



- 16** GROUNDING

Ensure that you connect the earth ground wire to prevent possible electric shock. If grounding methods are not possible, have a qualified electrician install a separate circuit breaker.

Do not try to ground the unit by connecting it to telephone wires, lightening rods, or gas pipes.

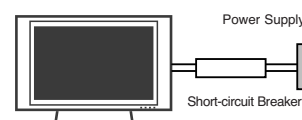

- 17** DISCONNECTING DEVICE FROM MAINS
Main plug is the disconnecting device. The plug must remain readily operable.

CONTENTS

WARNING	1
FEATURES OF THIS TV	6

PREPARATION

Accessories	7
Front Panel Controls	8
Back Panel Information	10
Back Cover for Wire Arrangement	12
Attaching the TV to a Wall	14
Stand Installation	15
Antenna or Cable Connection	18

EXTERNAL EQUIPMENT SETUP

HD Receiver Setup	19
DVD Setup	22
VCR Setup	24
Other A/V Source Setup	26
PC Setup	27
AV Out Setup	33
External Stereo	33

WATCHING TV / SETUP CONTROL

Remote Control Functions	34
Turning on the TV	36
- Volume Adjustment	36
- Channel Adjustment	36
On Screen Menus Selection and Adjustment ..	37
Auto tuning: Channel Search	38
Manual tuning: Adding/Deleting Channels	39
Fine tuning Adjustment	40
Favorite Channels Setup	41
SIMPLINK	42

PICTURE CONTROL

PIP/Double Window	45
- Watching PIP/Double Window	45
- TV Program Selection for PIP	45
- Selecting an Input Signal Source for the PIP/Double Window	46
- Sub Picture Size Adjustment (PIP mode only)	46
- Moving the Sub Picture (PIP mode only) ..	46
Picture Mode Control	47
Manual Picture Control (Picture mode-User option) ..	48
Color Temperature Control	49
Manual Color Temperature Control (User option)	50
XD	51
Advanced - Cinema Mode Setup	52
Advanced - Black Level	53
Aspect Ratio Control	54
Picture Reset	55
XD Demo	56

AUDIO CONTROL

Sound Mode Control	57
Sound Control Adjustment (User option)	58
Auto Volume Leveler	59
Balance Adjustment	60
TV Speakers On/Off Setup	61
Stereo/SAP Broadcast Setup	62

TIME SETTING

Clock Setup	63
On/Off Time Setup	64
Sleep Time	65
Auto Sleep	66

OPTION CONTROL

On Screen Menus Language Selection	67
Key Lock	68
Closed Captions	69
ISM (Image Sticking Minimization) Method	70
Low Power	71

APPENDIX

Troubleshooting Checklist	72
Maintenance	74
Product Specifications	75
Programming the Remote Control	77
Programming Codes	77

FEATURES OF THIS TV

What is a Plasma TV ?

Using plasma is the best way to achieve flat panel displays with excellent image quality and large screen sizes that are easily viewable. The Plasma TV can be thought of as a descendant of the neon lamp and or a series of fluorescent lamps.

How does it work?

Plasma TV is an array of cells, known as pixels, which are comprised of three sub-pixels, corresponding to the colors red, green, and blue. Gas in a plasma state is used to react with phosphors in each sub-pixel to produce colored light (red, green, or blue). These phosphors are the same types used in Cathode Ray Tube (CRT) devices such as televisions and common computer monitors.

Plasma TV offers a rich, dynamic display because each sub-pixel is individually controlled by advanced electronics to produce over 16 million different colors. This means that you get perfect images that are easily viewable in a display that is fewer than five inches thick.

160° - Wide angle range of vision

Your flat panel plasma screen offers an exceptionally broad viewing angle of over 160 degrees. This means that the display is clear and visible to viewers anywhere in the room.

Wide Screen

The wide screen offers a theater-like experience in your own home.

Multimedia

Connect your plasma display to a PC and use it for conferencing, games, and Internet browsing. The Picture-in-Picture feature allows you to view your PC and video images simultaneously.

Versatile

The light weight and thin size makes it easy to install your plasma display in a variety of locations where conventional TVs do not fit.

The Plasma TV Manufacturing Process: a few minute colored dots may be present on the Plasma TV screen

The Plasma TV is composed of 0.9 to 2.2 million cells. A few cell defects will normally occur in the Plasma TV manufacturing process. Several tiny, minute colored dots visible on the screen should be acceptable. This also occurs in other Plasma TV manufacturers' products. The tiny dots appearing does not mean that this Plasma TV is defective. Thus a few cell defects are not sufficient cause for the Plasma TV to be exchanged or returned. Our production technology minimizes these cell defects during the manufacture and operation of this product.

FOR LCD TV

If the TV feels cold to the touch, there may be a small "flicker" when it is turned on. This is normal, there is nothing wrong with TV.

Some minute dot defects may be visible on the screen, appearing as tiny red, green, or blue spots. However, they have no adverse effect on the monitor's performance.

Avoid touching the LCD screen or holding your finger(s) against it for long periods of time. Doing so may produce some temporary distortion effects on the screen.

On Disposal

- a. The fluorescent lamp used in this product contains a small amount of mercury.
- b. Do not dispose of this product with general household waste.
- c. Disposal of this product must be carried out in accordance to the regulations of your local authority.

PREPARATION

ACCESSORIES

Ensure that the following accessories are included with your product. If an accessory is missing, please contact the dealer where you purchased the product.

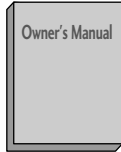

Owner's Manual

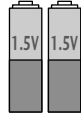

**Batteries
(Some models)**



Remote Control



Power Cord



RF Adapter (Some models)

You must connect it to the antenna wire after fixing in Antenna Input. This adapter is only supplied in Argentina.

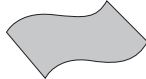

Polishing cloth
Polish the screen with the cloth.

* Slightly wipe stained spot on the exterior only with the cleansing cloths for the product exterior if there is stain or fingerprint on surface of the exterior.

* Do not wipe roughly when removing stain. Please be cautious of that excessive power may cause scratch or discoloration.

For Plasma TV models

* This feature is not available for all models.

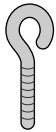

2-eye-bolts

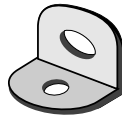

2-Wall brackets

For LCD TV models



Cable Management

* This feature is not available for all models.

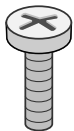

2- TV Bracket Bolts



**2- TV Brackets,
2- Wall Brackets**



Twister Holder
Arrange the wires with the twister holder.

26", 32", 37" only



**4-Bolts for stand assembly
(Refer to p.15)**

PREPARATION

FRONT PANEL CONTROLS

- This is a simplified representation of the front panel. Here shown may be somewhat different from your TV.
- If your product has a protection tape attached, remove the tape and then wipe the product with a cloth. (If a polishing cloth is included with your product, use it.)

<26LC4R*/32/37/42LC4R>

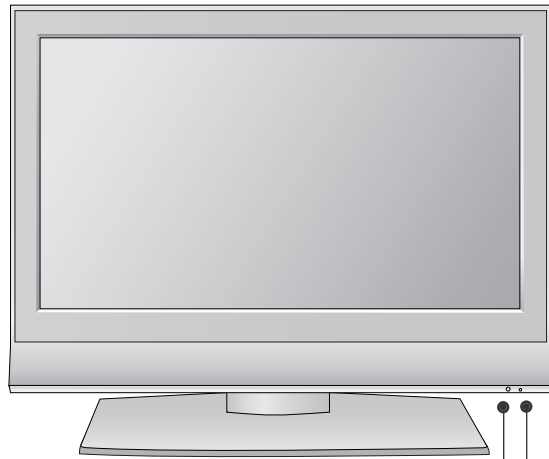

Remote Control Sensor

Power Standby Indicator

Illuminates red in standby mode.
When the TV is turned on, the indicator blinks green and then illuminates green before the picture is displayed.

<26LC7R>

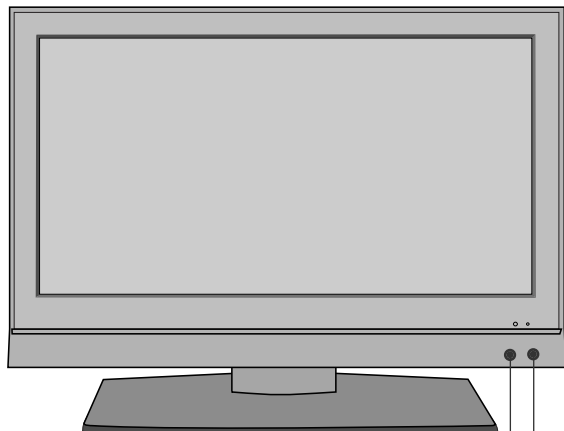

Remote Control Sensor

Power Standby Indicator

Illuminates red in standby mode.
When the TV is turned on, the indicator blinks green and then illuminates green before the picture is displayed.

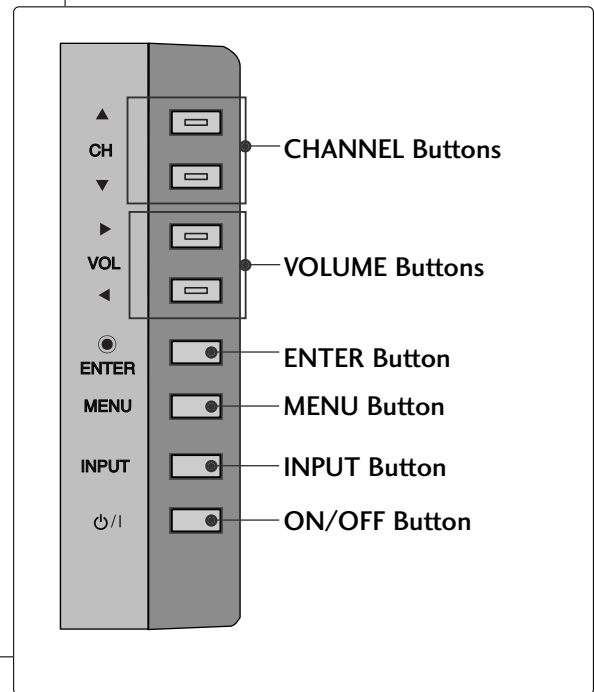

CHANNEL Buttons

VOLUME Buttons

ENTER Button

MENU Button

INPUT Button

ON/OFF Button

<42PC5R*/50PC5R>

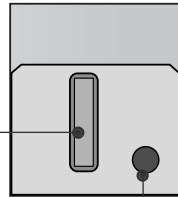
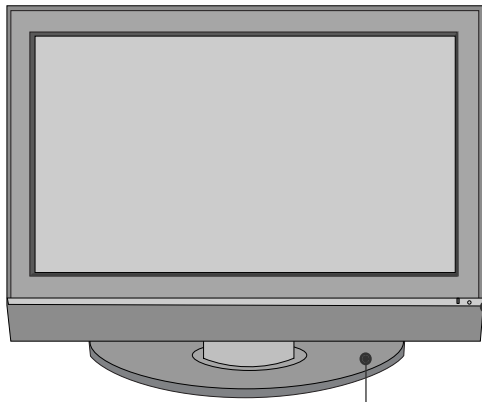

Remote Control Sensor

Power Standby Indicator

Illuminates red in standby mode. When the TV is turned on, the indicator blinks green and then illuminates green before the picture is displayed.

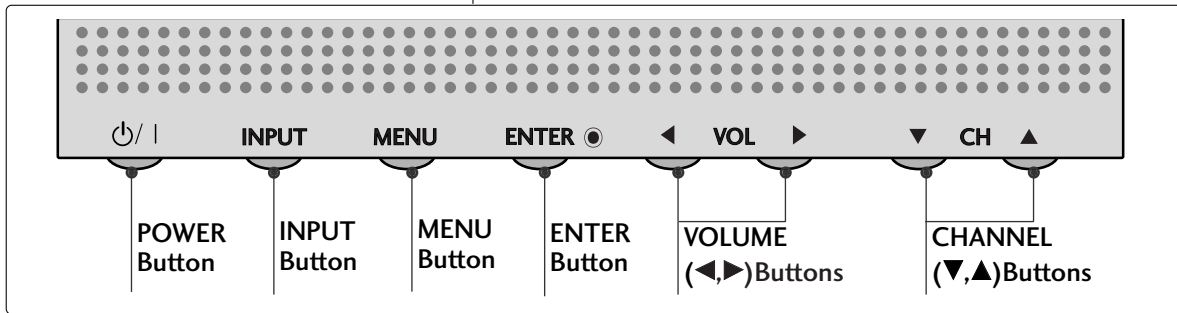

<42PC7R*>

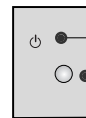
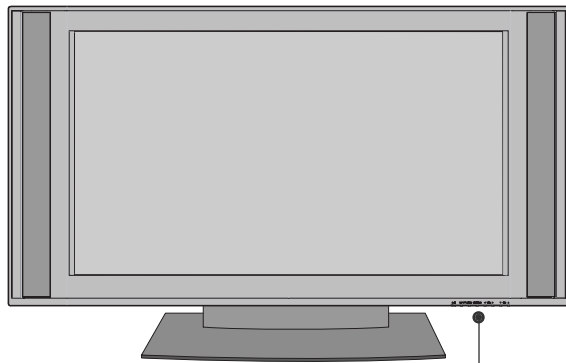

Power/Standby Indicator
Illuminates red in standby mode. Illuminates green when the set is switched on.

Remote Control Sensor

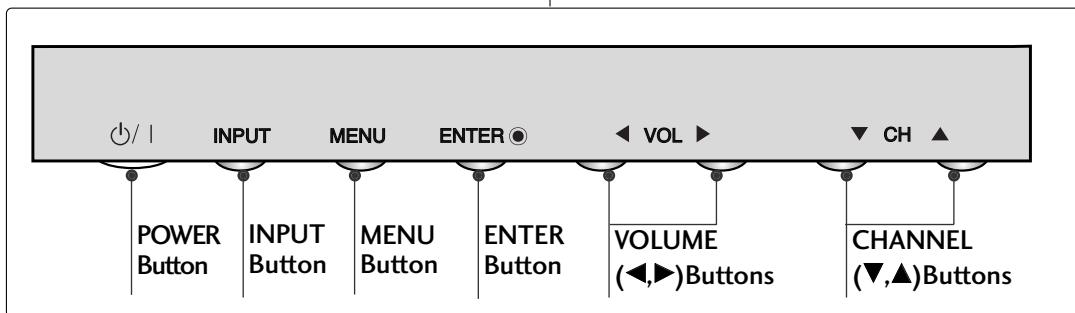

PREPARATION

BACK PANEL INFORMATION

Back Connection Panel

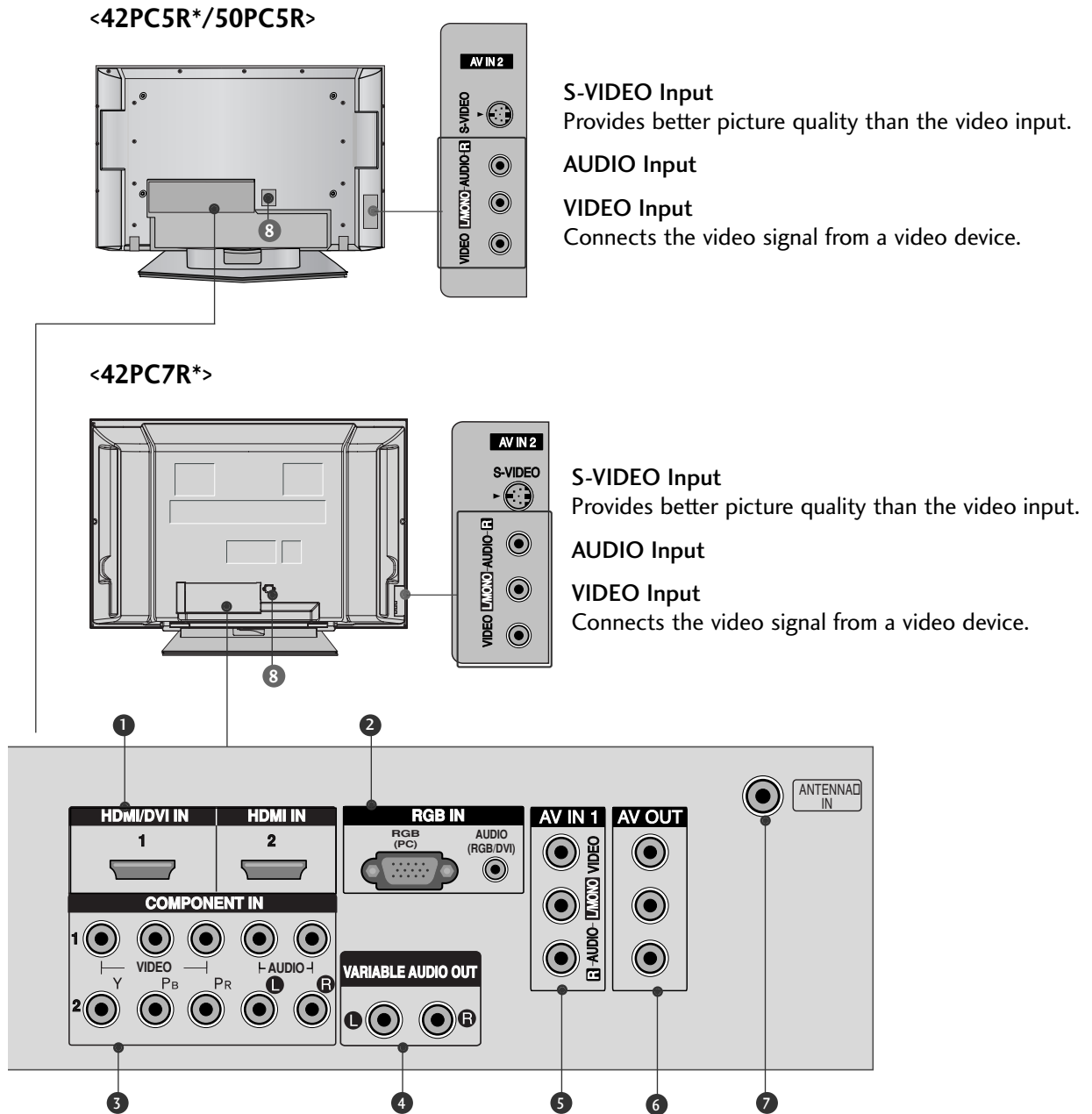

This is the back panel of model 26/32LC4R.

<26LC4R*/26LC7R/32/37/42LC4R>

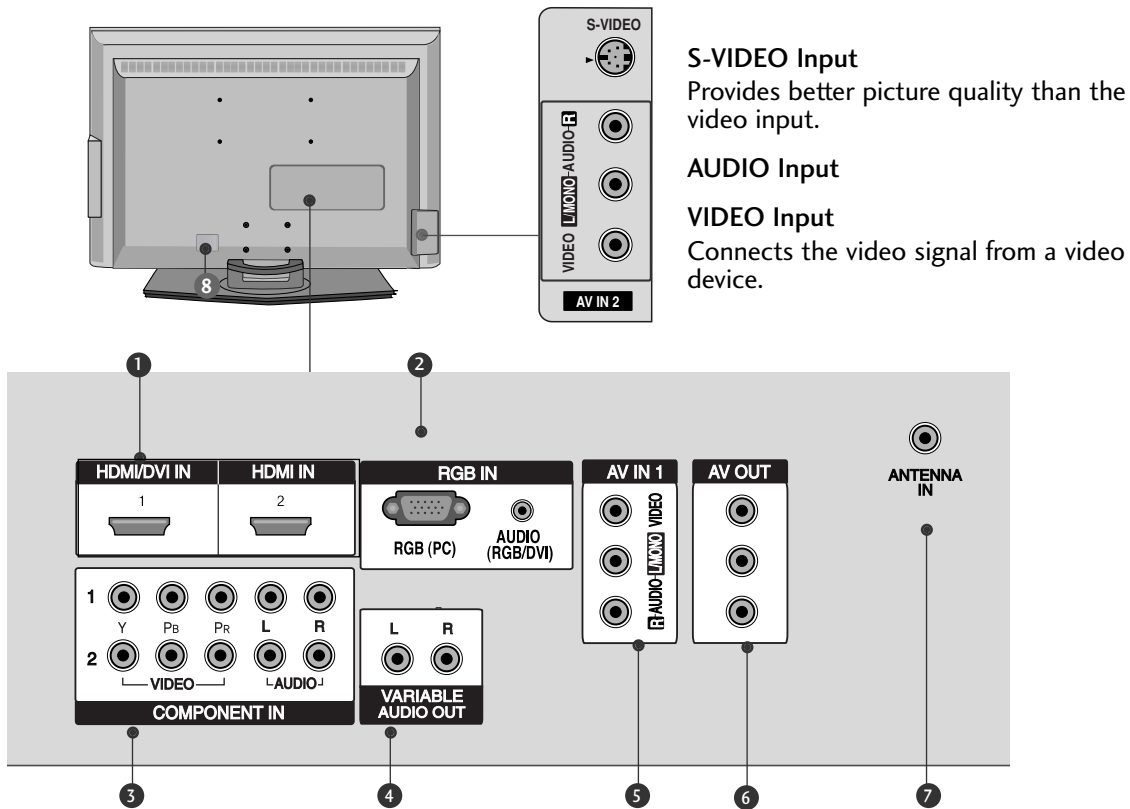

S-VIDEO Input
Provides better picture quality than the video input.

AUDIO Input

VIDEO Input
Connects the video signal from a video device.

- 1 HDMI/DVI, HDMI Input**
Connect a HDMI signal to HDMI IN.
Or DVI(VIDEO)signal to HDMI/DVI port with DVI to HDMI cable.
- 2 RGB/Audio Input**
Connect the monitor output from a PC, DTV(only Audio) to the appropriate input port.
- 3 Component Input 1/2**
Connect a component video/audio device to these jacks.
- 4 Variable Audio Output**
Connect an external amplifier or add a subwoofer to your surround sound system.
- 5 AV IN 1**
Connect audio/video output from an external device to these jacks.
- 6 AV OUT**
Connect second TV or monitor to the AV OUT socket on the set.
- 7 Antenna In**
Connect over-the-air signals to this jack.
- 8 Power Cord Socket**
This TV operates on an AC power. The voltage is indicated on the Specifications page. Never attempt to operate the TV on DC power.

PREPARATION

BACK COVER FOR WIRE ARRANGEMENT

Plasma TV models

- These models have two cable arrangement methods according to the stand type.

Stand type 1

Arrange the cables as shown picture.

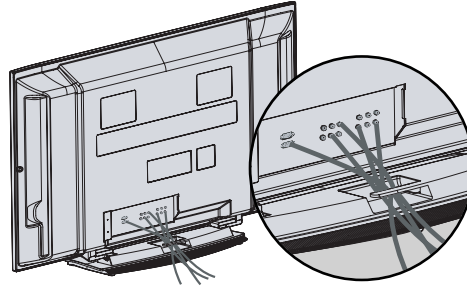

Stand type 2

- 1** Hold the **CABLE MANAGEMENT** with hands and push it as shown.

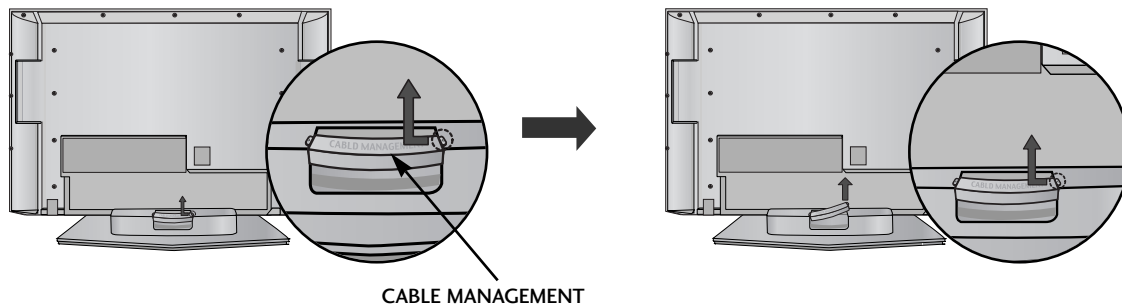

- 2** Connect the cables as necessary.

To connect an additional equipment, see the **External equipment Connections** section.

- 3** Reinstall the **CABLE MANAGEMENT** as shown.



<26LC4R*/26LC7R/32/37/42LC4R>

- 1 Connect the cables as necessary.
To connect an additional equipment, see the **External equipment Connections** section.

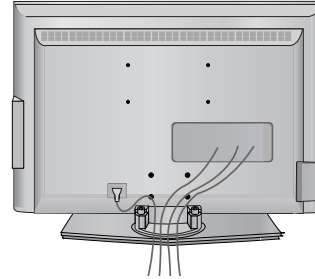

- 2 Install the **CABLE MANAGEMENT** as shown.

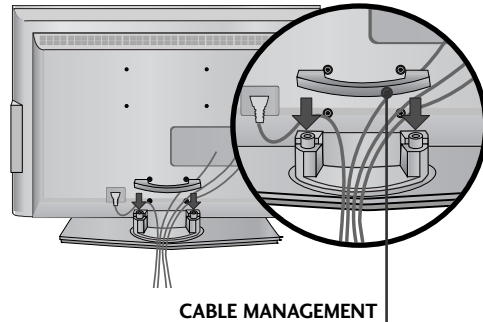

- 3 Bundle the cables using the supplied twister holder.
(This feature is not available for all models.)

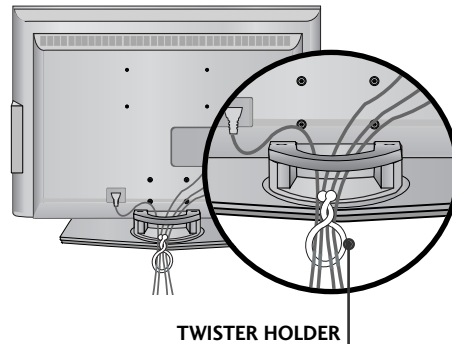

! NOTE

- ▶ Do not hold the **CABLE MANAGEMENT** when moving the product.
- If the product is dropped, you may be injured or the product may be broken.

How to remove the CABLE MANAGEMENT

- ▶ Hold the **CABLE MANAGEMENT** with both hands and pull it backward.

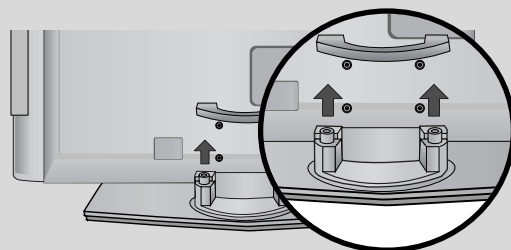

PREPARATION

ATTACHING THE TV TO A WALL

* This feature is not available for all models.

- Set it up close to the wall so the set doesn't fall over when it is pushed backwards.
- The instructions shown below is a safer way to set up the set, which is to fix it on the wall so the set doesn't fall over when it is pulled in the forward direction. It will prevent the set from falling forward and hurting people. It will also prevent the set from damage caused by fall. Please make sure that children don't climb on or hang from the set.

Plasma TV Model

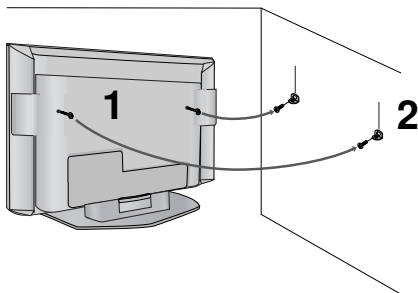

LCD TV Model

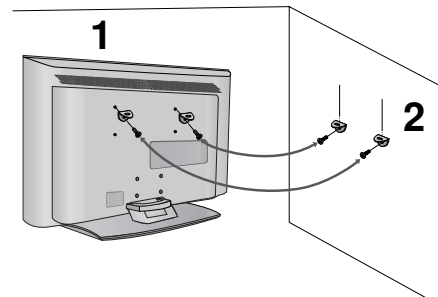

- 1 Use the eye-bolts or set brackets/bolts to fix the set to the wall as shown in the picture.
(If your set has the bolts in the eye-bolts position before inserting the eye-bolts, loosen the bolts.)
* Insert the eye-bolts or set brackets/bolts and tighten them securely in the upper holes.
- 2 Secure the wall brackets with the bolts (not provided as parts of the set, must purchase separately) on the wall. Match the height of the bracket that is mounted on the wall.

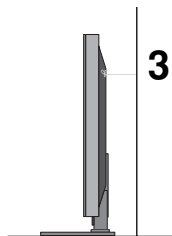

- 3 Use a sturdy rope (not provided as parts of the set, must purchase separately) to tie the set. It is safer to tie the rope so it becomes horizontal between the wall and the set.

NOTE

- ▶ When moving the set to another place undo the ropes first.
- ▶ Use a set holder or a cabinet that is big and strong enough for the size and weight of the set.
- ▶ To use the set safely make sure that the height of the bracket that is mounted on the wall is same as that of the set.

STAND INSTALLATION (Only 26/32/37 inch LCD TV models)

- 1 Carefully place the product screen side down on a cushioned surface that will protect product and screen from damage.

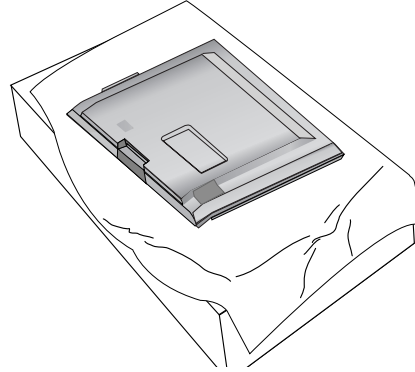

- 2 Assemble the product stand with the product as shown.

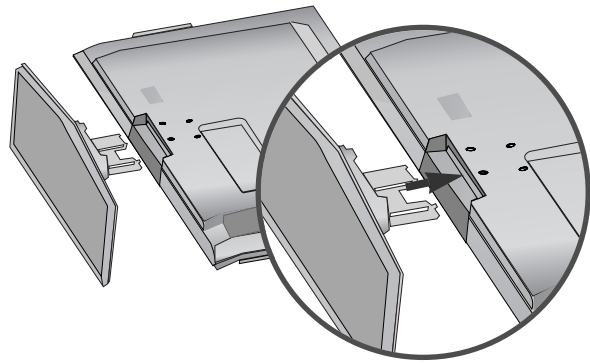

- 3 Install the 4 bolts securely, in the back of the product in the holes provided.

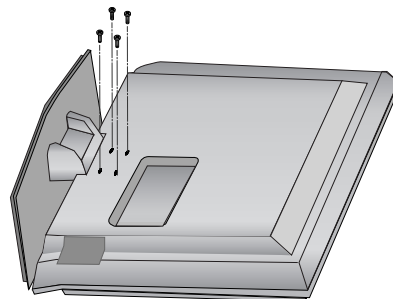

PREPARATION

PREPARATION

- The TV can be installed in various ways such as on a wall, or on a desktop etc.
- The TV is designed to be mounted horizontally.

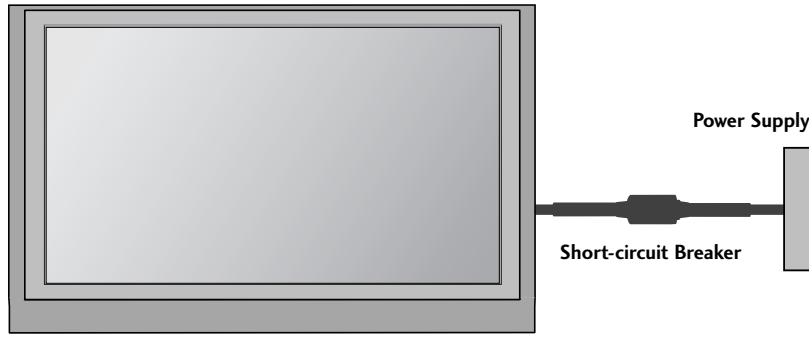

GROUNDING

Ensure that you connect the earth ground wire to prevent possible electric shock. If grounding methods are not possible, have a qualified electrician install a separate circuit breaker.

Do not try to ground the unit by connecting it to telephone wires, lightning rods, or gas pipes.

DESKTOP PEDESTAL INSTALLATION

For proper ventilation, allow a clearance of 4 inches on each side from the wall.

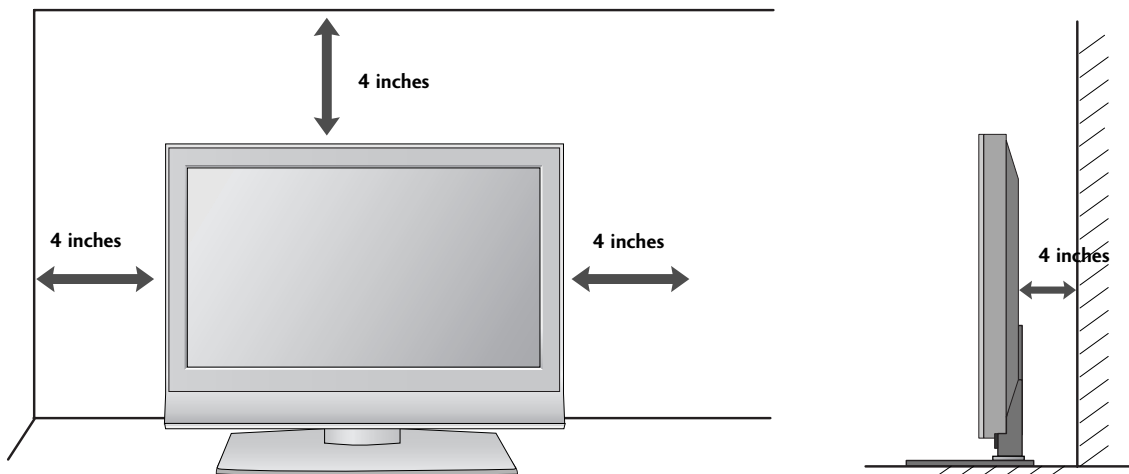

WALL MOUNT: HORIZONTAL INSTALLATION

For proper ventilation, allow a clearance of 4" on each side and from the wall. Detailed installation instructions are available from your dealer, see the optional Tilt Wall Mounting Bracket Installation and Setup Guide.

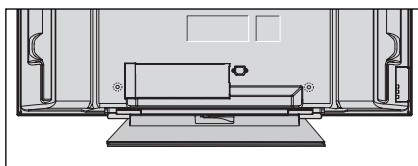
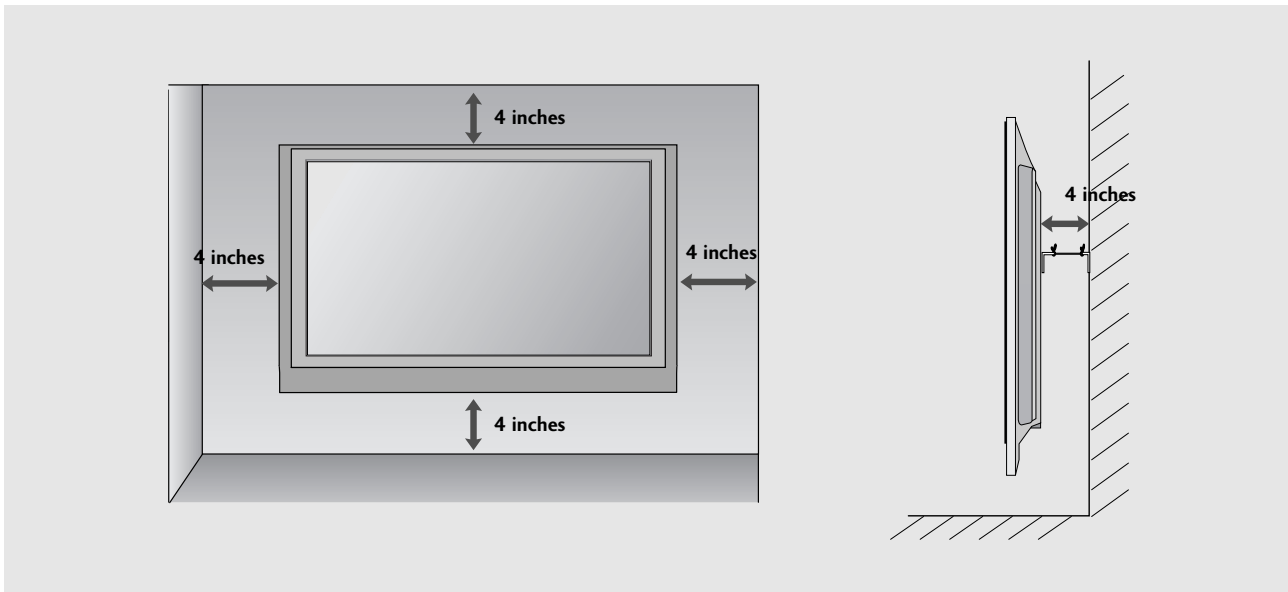

<Only 42PC7R*>

Remove two screws of the backside of the set before installing the wall mounting bracket.

PREPARATION

ANTENNA OR CABLE CONNECTION

Wall Antenna Socket or Outdoor Antenna without a Cable Box Connections.
For optimum picture quality, adjust antenna direction if needed.

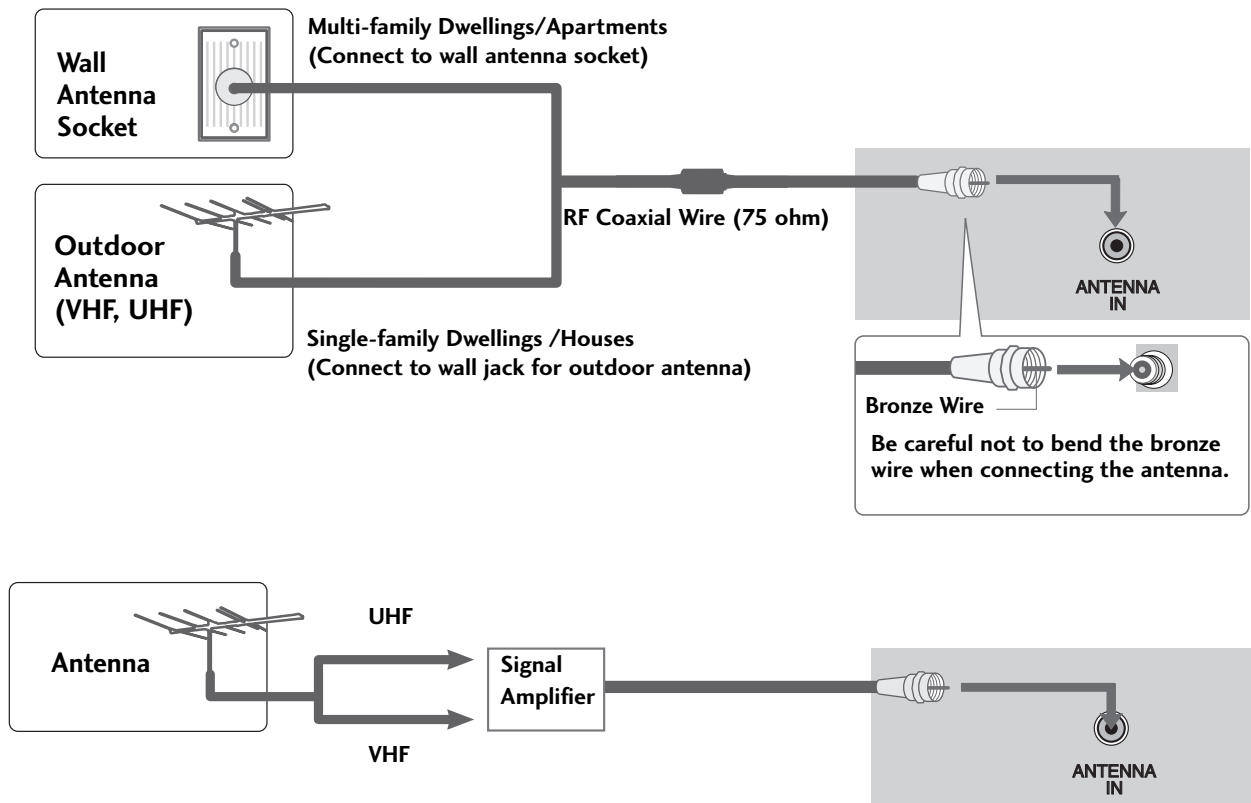

- To improve the picture quality in a poor signal area, please purchase a signal amplifier and install properly.
- If the antenna needs to be split for two TV's, install a 2-Way Signal Splitter.
- If the antenna is not installed properly, contact your dealer for assistance.

! NOTE

- ▶ The TV will let you know when the analog and cable scans are complete.

EXTERNAL EQUIPMENT SETUP

- To prevent the equipment damage, never plug in any power cords until you have finished connecting all equipment.
- This part of EXTERNAL EQUIPMENT SETUP mainly use pictures for the LCD TV models.

HD RECEIVER SETUP

When connecting with a component cable

1. How to connect

- 1 Connect the video outputs (Y, PB, PR) of the digital set top box to the **COMPONENT IN VIDEO 1** jacks on the set. Match the jack colors (Y = green, PB = blue, and PR = red).
- 2 Connect the audio output of the digital set-top box to the **COMPONENT IN AUDIO 1** jacks on the set.

2. How to use

- Turn on the digital set-top box.
(Refer to the owner's manual for the digital set-top box.)
- Select **Component 1** input source with using the **INPUT** button on the remote control.
- If connected to **COMPONENT IN 2** input, select **Component 2** input source.

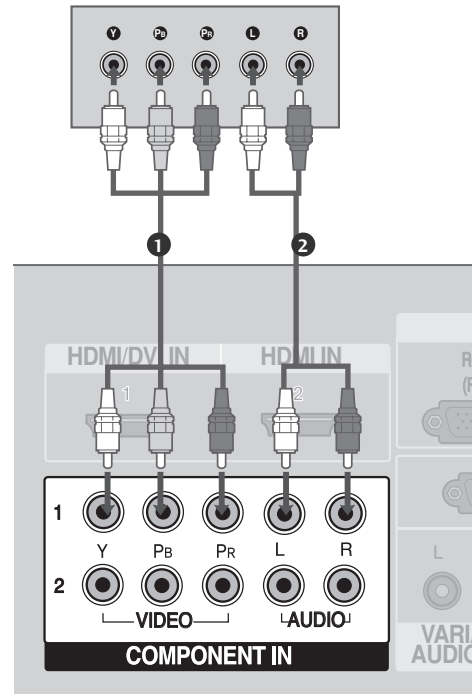

Signal	Component 1/2	HDMI1/DVI, HDMI2
480i	Yes	No
480p/720p	Yes	Yes
1080i	Yes	Yes
1080p	No	Yes

(except VGA Models: VGA models support up to 1080i)

EXTERNAL EQUIPMENT SETUP

When connecting with a HDMI cable

1. How to connect

- 1 Connect the digital set-top box to **HDMI/DVI IN 1** or **HDMI IN 2** jack on the set.
- 2 No separated audio connection is necessary.

2. How to use

- Turn on the digital set-top box.
(Refer to the owner's manual for the digital set-top box.)
- Select **HDMI1** or **HDMI2** input source with using the **INPUT** button on the remote control.

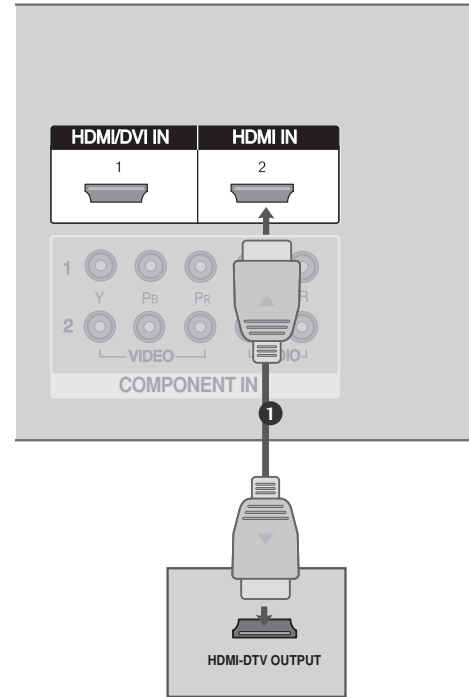

! NOTE

- ▶ TV can receive the video and audio signal simultaneously with using a HDMI cable.
- ▶ If the digital set-top box supports Auto HDMI function, the output resolution of the source device will be automatically set to 1280x720p.
- ▶ If the digital set-top box player does not support Auto HDMI, you need to set the output resolution appropriately.
To get the best picture quality, adjust the output resolution of the source device to 1280x720p.

Supported Display Resolution (HDMI-DTV mode)

Resolution	Horizontal Frequency(KHz)	Vertical Frequency(Hz)
720x480	31.47	59.94
	31.50	60.00
720x576	31.25	50.00
1280x720	44.96	59.94
	45.00	60.00
	37.50	50.00
1920x1080i	33.72	59.94
	33.75	60.00
	28.125	50.00
1920x1080p	67.432	59.94
	67.50	60.00
	56.25	50.00

(except VGA Models: —
VGA models support up to 1080i)

When connecting with a HDMI to DVI cable

1. How to connect

- 1 Connect the DVI output of the digital set-top box to the **HDMI/DVI IN 1** jack on the set.
- 2 Connect the audio output of the digital set-top box to the **AUDIO(RGB/DVI)** jack on the set.

2. How to use

- Turn on the digital set-top box. (Refer to the owner's manual for the digital set-top box.)
- Select **HDMI1** input source with using the **INPUT** button on the remote control.

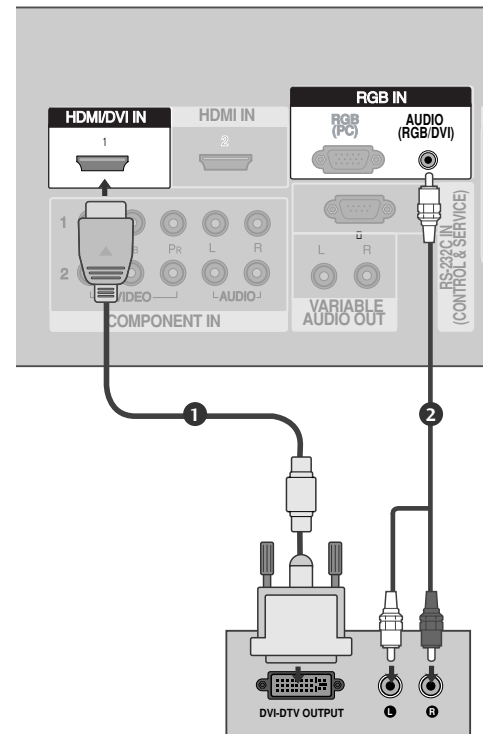

EXTERNAL EQUIPMENT SETUP

DVD SETUP

When connecting with a component cable

1. How to connect

- 1 Connect the video outputs (Y, PB, PR) of the DVD to the **COMPONENT IN VIDEO1** jacks on the set.
 Match the jack colors
 (Y = green, PB = blue, and PR = red).

- 2 Connect the audio outputs of the DVD to the **COMPONENT IN AUDIO1** jacks on the set.

2. How to use

- Turn on the DVD player, insert a DVD.
- Select **Component 1** input source with using the **INPUT** button on the remote control.
- If connected to **COMPONENT IN 2** input, select **Component 2** input source.
- Refer to the DVD player's manual for operating instructions.

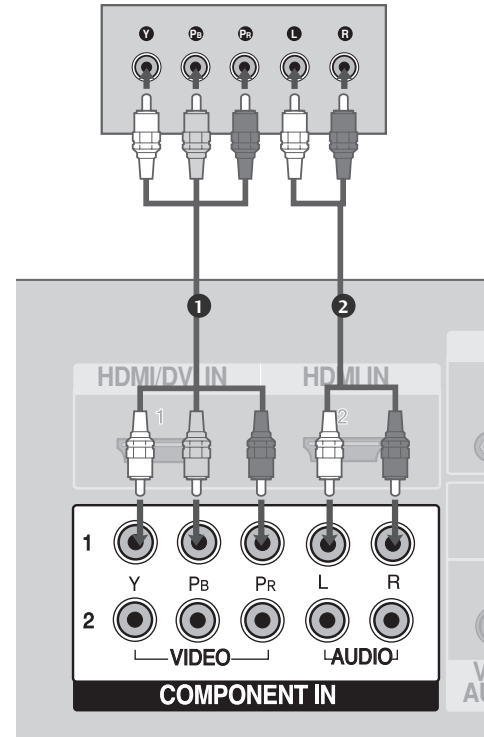

Component Input ports

To get better picture quality, connect a DVD player to the component input ports as shown below.

Component ports on the TV	Y	P _B	P _R
Video output ports on DVD player	Y	P _B	P _R
	Y	B-Y	R-Y
	Y	C _b	C _r
	Y	P _b	P _r

When connecting with an S-Video cable

1. How to connect

- 1 Connect the S-VIDEO output of the DVD to the **S-VIDEO** input on the set.
- 2 Connect the audio outputs of the DVD to the **AUDIO** input jacks on the set.

2. How to use

- Turn on the DVD player, insert a DVD.
- Select **AV2** input source with using the **INPUT** button on the remote control.
- Refer to the DVD player's manual for operating instructions.

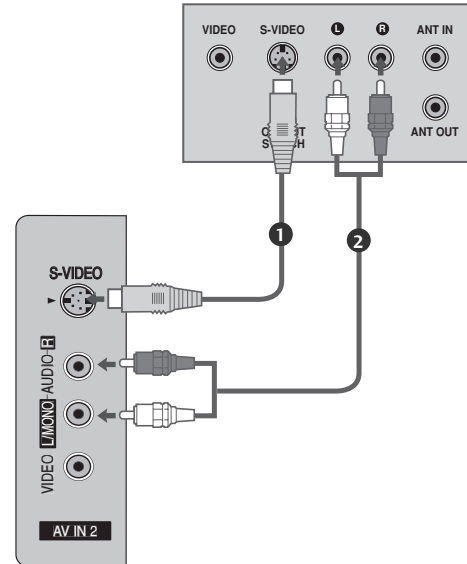

When connecting HDMI cable

1. How to connect

- 1 Connect the HDMI output of the DVD to the **HDMI/DVI IN 1** or **HDMI 2** jack on the set.
- 2 No separated audio connection is necessary.

2. How to use

- Select **HDMI1** or **HDMI2** input source with using the **INPUT** button on the remote control.
- Refer to the DVD player's manual for operating instructions.

! NOTE

- ▶ TV can receive the video and audio signal simultaneously with using a HDMI cable.
- ▶ If the DVD supports Auto HDMI function, the output resolution of the source device will be automatically set to 1280x720p.
- ▶ If the DVD player does not support Auto HDMI, you need to set the DVD output resolution appropriately.

To get the best picture quality, adjust the output resolution of the source device to 1280x720p.

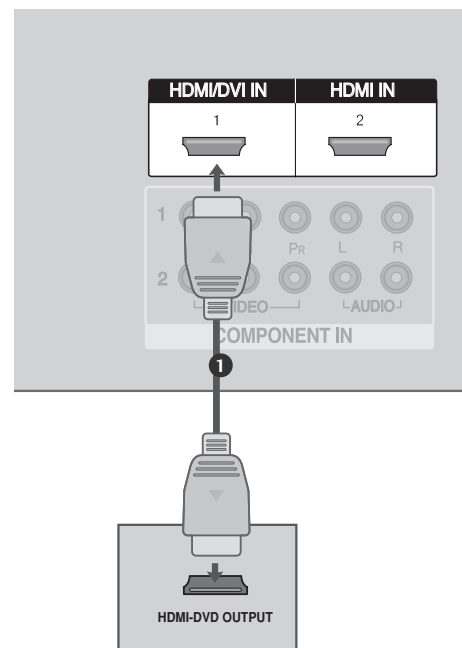

EXTERNAL EQUIPMENT SETUP

VCR SETUP

- To avoid picture noise (interference), leave an adequate distance between the VCR and TV.
- If the 4:3 picture format is used; the fixed images on the sides of the screen may remain visible on the screen. This phenomenon is common to all manufactures and in consequence the manufactures warranty does not cover the product bearing this phenomenon.

When connecting with an antenna

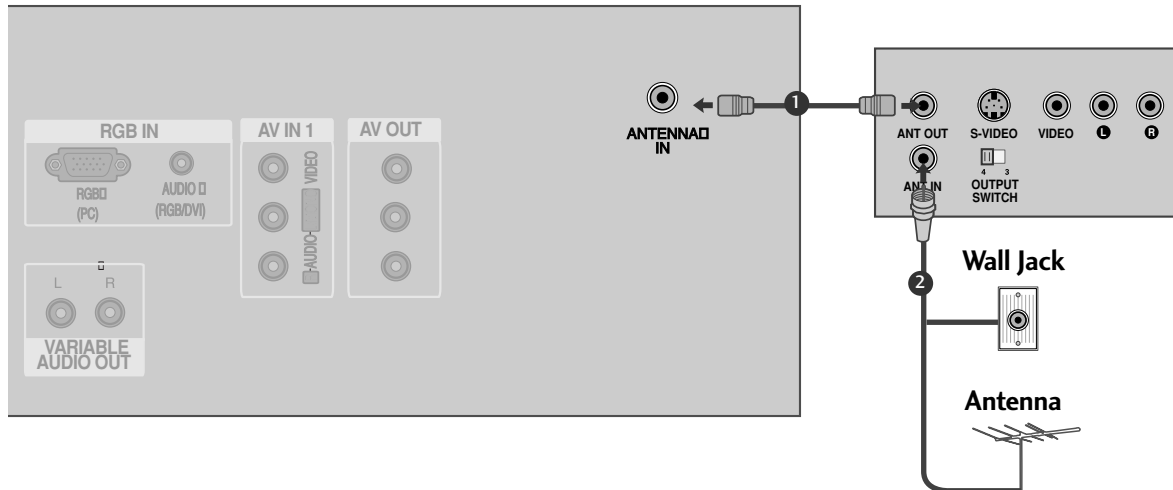

1. How to connect

- 1 Connect the RF antenna out socket of the VCR to the **Antenna** socket on the set.
- 2 Connect the antenna cable to the RF antenna in socket of the VCR.

2. How to use

- Set VCR output switch to 3 or 4 and then tune TV to the same channel number.
- Insert a video tape into the VCR and press PLAY on the VCR. (Refer to the VCR owner's manual.)

When connecting with a RCA cable

1. How to connect

- 1 Connect the **AUDIO/VIDEO** jacks between TV and VCR. Match the jack colors (Video = yellow, Audio Left = white, and Audio Right = red)

2. How to use

- Insert a video tape into the VCR and press **PLAY** on the VCR. (Refer to the VCR owner's manual.)
- Select **AV1** input source with using the **INPUT** button on the remote control.
- If connected to **AV IN2**, select **AV2** input source.

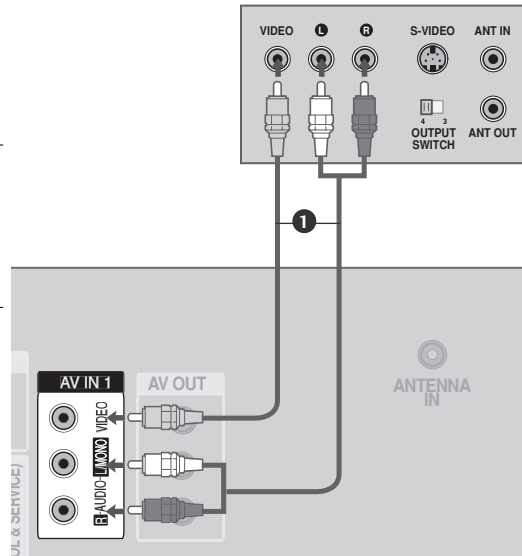

NOTE

- ▶ If you have a mono VCR, connect the audio cable from the VCR to the **AUDIO L/MONO** jack of the set.

When connecting with an S-Video cable

1. How to connect

- 1 Connect the **S-VIDEO** output of the VCR to the **S-VIDEO** input on the set.
- 2 Connect the audio outputs of the VCR to the **AUDIO** input jacks on the set.

2. How to use

- Insert a video tape into the VCR and press **PLAY** on the VCR. (Refer to the VCR owner's manual.)
- Select **AV2** input source with using the **INPUT** button on the remote control.

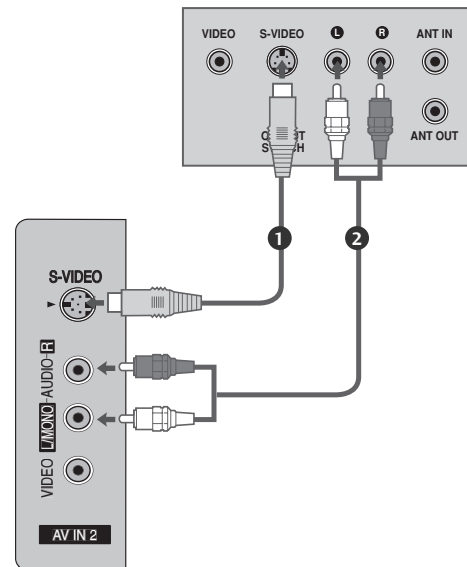

CAUTION

- ▶ Do not connect to both Video and S-Video at the same time. In the event that you connect both Video and the S-Video cables, only the S-Video will work.

NOTE

- ▶ The picture quality is improved: compared to normal composite (RCA cable) input.

EXTERNAL EQUIPMENT SETUP

OTHER A/V SOURCE SETUP

1. How to connect

- 1 Connect the **AUDIO/VIDEO** jacks between TV and external equipment. Match the jack colors. (Video = yellow, Audio Left = white, and Audio Right = red)

2. How to use

- Select **AV2** input source with using the **INPUT** button on the remote control.
- If connected to **AV IN1** input, select **AV1** input source.
- Operate the corresponding external equipment.

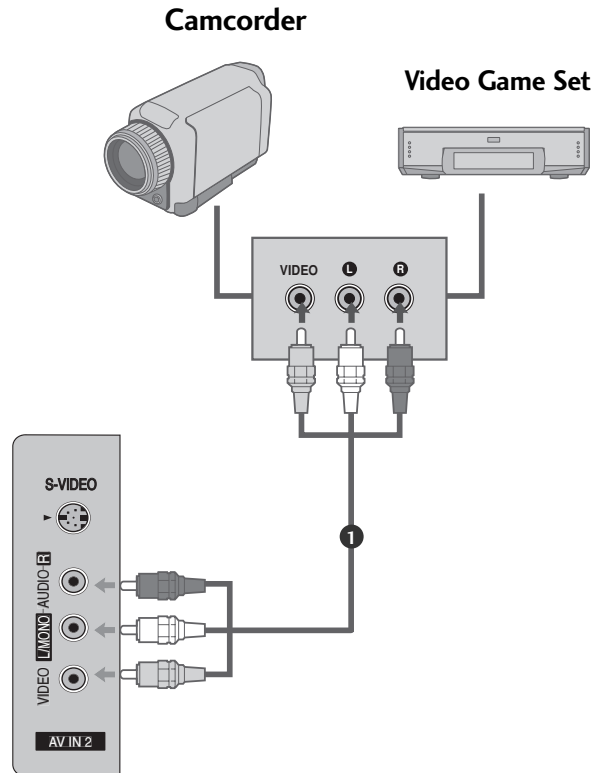

PC SETUP

This TV provides Plug and Play capability, meaning that the PC adjusts automatically to the TV's settings.

When connecting with a D-sub 15 pin cable

1. How to connect

- 1 Connect the RGB output of the PC to the **RGB(PC)** jack on the set.
- 2 Connect the PC audio output to the **AUDIO (RGB/DVI)** jack on the set.

2. How to use

- Turn on the PC and the set.
- Select **RGB-PC** input source with using the **INPUT** button on the remote control.

! NOTE

- ▶ Check the image on your TV. There may be noise associated with the resolution, vertical pattern, contrast or brightness in PC mode. If noise is present, change the PC output to another resolution, change the refresh rate to another rate or adjust the brightness and contrast on the VIDEO menu until the picture is clear. If the refresh rate of the PC graphic card can not be changed, change the PC graphic card or consult the manufacturer of the PC graphic card.

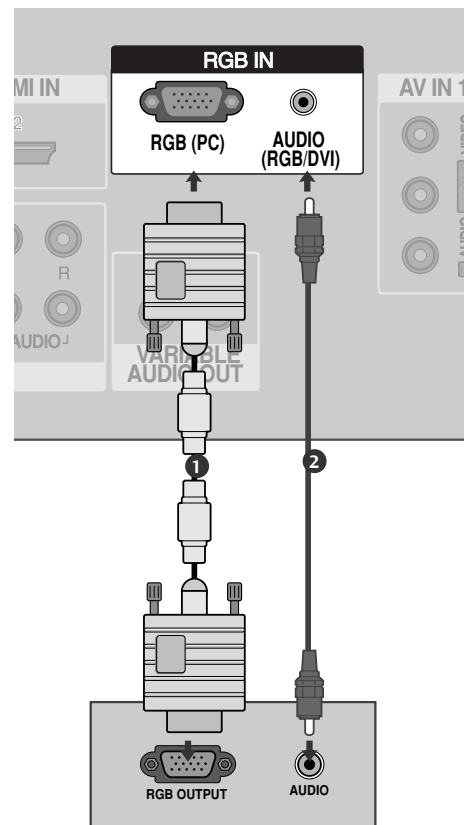

EXTERNAL EQUIPMENT SETUP

Supported Display Resolution (RGB[PC] mode)

Resolution	Horizontal Frequency(KHz)	Vertical Frequency(Hz)
640x350	31.468	70.09
720x400	31.469	70.08
640x480	31.469	59.94
848x480	31.5	60.00
852x480	31.5	60.00
800x600	37.879	60.31
1024x768	48.363	60.00
1280x768	47.776	59.87
1360x768	47.720	59.799
1366x768	47.720	59.799

! NOTE

- ▶ It's supported to 848x480, 852x480 in VGA modes. (VGA Models)
- ▶ It's supported to 1280x768, 1360x768, 1366x768 in XGA modes. (XGA Models)

! NOTE

- ▶ To enjoy vivid picture and sound, connect a PC to the set.
- ▶ Avoid keeping a fixed image on the set's screen for a long period of time. The fixed image may become permanently imprinted on the screen; use a screen saver when possible.
- ▶ Connect PC to the RGB (PC) port of the set; change the resolution output of PC accordingly.
- ▶ There might be noise according to some resolution, vertical pattern, contrast or brightness in PC mode. Change the PC mode into another resolution or change the refresh rate into another rate or adjust the brightness and contrast on the menu until the picture is clean. If the refresh rate of the PC graphic card can not be changed, change the PC graphic card or consult it to the manufacturer of the PC graphic card.
- ▶ The synchronization input waveform for Horizontal and Vertical frequencies are separate.
- ▶ We recommend using 1366x768, 60Hz (LCD TV models) / 852x480, 60Hz (42 inch WVGA PLASMA TV models) / 1024x768, 60Hz (42 inch XGA PLASMA TV models) / 1360x768, 60Hz (50 inch PLASMA TV models) for the PC mode, they provide the best picture quality.
- ▶ If the resolution of PC is over SXGA, there will be no picture on the set.
- ▶ Connect the audio cable from the PC to the Audio input on the set. (Audio cables are not included with the set).
- ▶ When you use too long RGB-PC cable, there might be a noise on the screen. We recommend using under 5m of the cable. It provides the best picture quality.

SCREEN SETUP FOR PC MODE

Auto Configure (RGB [PC] mode only)

Automatically adjusts picture position and minimizes image shaking.

Although the image is still not correct, your set is functioning properly but needs further adjustment.

Auto configure

This function is for the automatic adjustment of the screen position, clock, and phase. The displayed image will be unstable for a few seconds while the auto configuration is in progress.



1 Press the **MENU** button and then use ▲ or ▼ button to select the **Picture** menu.

2 Press the ► button and then use ▲ or ▼ button to select **Screen**.

3 Press the ► button and then use ▲ or ▼ button to select **Auto config.**

4 Press the ► button to start **Auto config.**

- When **Auto config.** has finished, **OK** will be shown on screen.
- If the position of the image is still not correct, try **Auto adjustment** again.

5 If picture needs to be adjusted more after **Auto adjustment** in **RGB (PC)**, you can adjust the **Manual config.**

6 Press the **EXIT** button to return to TV viewing or press the **MENU** button to return to the previous menu.

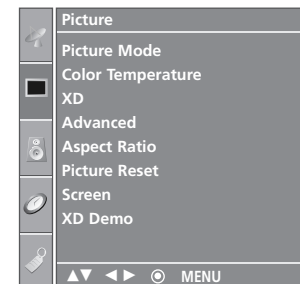

1

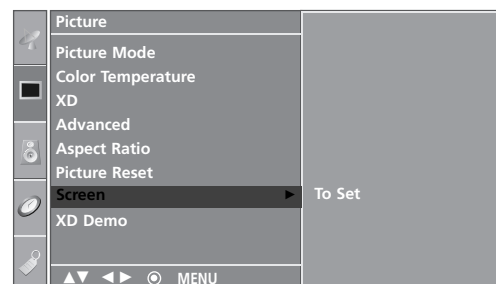

2

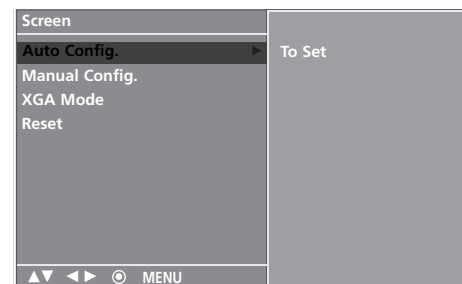

3 4

EXTERNAL EQUIPMENT SETUP

Adjustment for screen Phase, Clock, Position

If the picture isn't clear after auto adjustment and especially if characters are still trembling, adjust the picture phase manually.

To correct the screen size, adjust Clock.

This function works in the following mode : RGB[PC], COMPONENT (480i/480p/720p/1080i), HDMI (480p/720p/1080i/1080p(except VGA Models)).

It's not available to use Phase, Clock function in COMPONENT (480i/480p/720p/1080i), HDMI (480p/720p/1080i/1080p(except VGA Models)).



Clock This function is to minimize any vertical bars or stripes visible on the screen background. And the horizontal screen size will also change.

Phase This function allows you to remove any horizontal noise and clear or sharpen the image of characters.

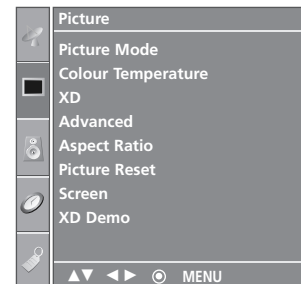

- 1 Press the **MENU** button and then use ▲ or ▼ button to select the **Picture** menu.
- 2 Press the ► button and then use ▲ or ▼ button to select **Screen**.
- 3 Press the ► button and then use ▲ or ▼ button to select **Manual config.**
- 4 Press the ► button and then use ▲ or ▼ button to select **Phase, Clock, H-position or V-position**.
- 5 Press the ◀ or ▶ button to make appropriate adjustments.
- 6 Press the **EXIT** button to return to TV viewing or press the **MENU** button to return to the previous menu.

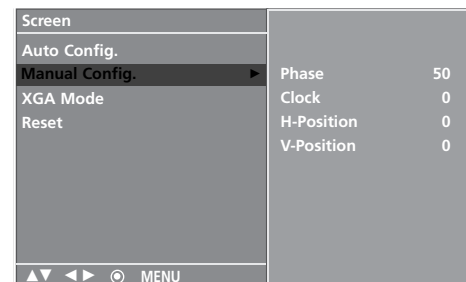
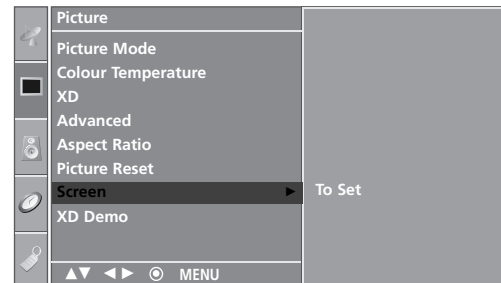

3 4 5

Selecting Wide VGA/XGA mode

To see a normal picture, match the resolution of RGB mode and selection of VGA/XGA mode.

This function works in the following mode: RGB[PC] mode.



- 1 Press the **MENU** button and then use ▲ or ▼ button to select the **Picture** menu.
- 2 Press the ► button and then use ▲ or ▼ button to select **Screen**.
- 3 Press the ► button and then use ▲ or ▼ button to select **XGA Mode** (or **VGA Mode**).
- 4 Press the ► button and then use ▲ or ▼ button to select the desired **VGA/XGA** resolution.
- 5 Press the **EXIT** button to return to TV viewing or press the **MENU** button to return to the previous menu.

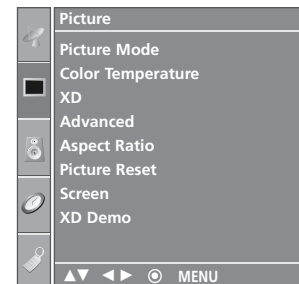

1

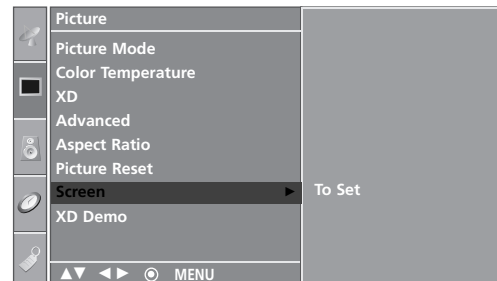

2

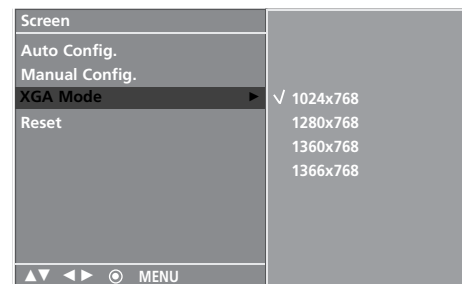

3 4

EXTERNAL EQUIPMENT SETUP

Initializing (Reset to original factory settings)

This function operates in current mode.
To initialize the adjusted value.



- 1 Press the **MENU** button and then use ▲ or ▼ button to select the **Picture** menu.
- 2 Press the ► button and then use ▲ or ▼ button to select **Screen**.
- 3 Press the ► button and then use ▲ or ▼ button to select **Reset**.
 - You can initialize Position, PIP size, PIP position.
- 4 Press the ► button.

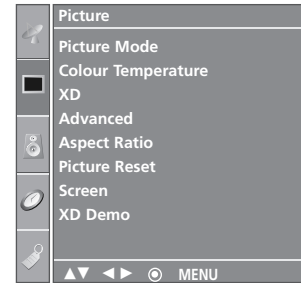

1

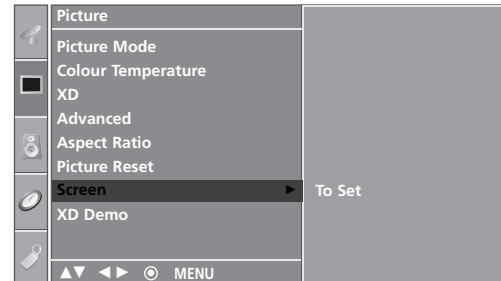

2

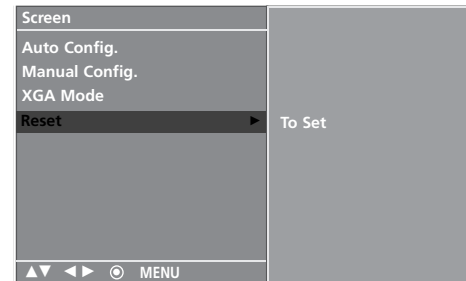

3 4

AV OUT SETUP

The TV has a special signal output capability which allows you to hook up the second TV or monitor.

1. How to connect

- 1 Connect the second TV or monitor to the TV's **AV OUT** jacks.
- 2 See the Operating Manual of the second TV or monitor for further details regarding that device's input settings.

NOTE

- ▶ Component, RGB, HDMI input sources cannot be used for AV out.
- ▶ We recommend to use the AV OUT jacks for VCR recording.

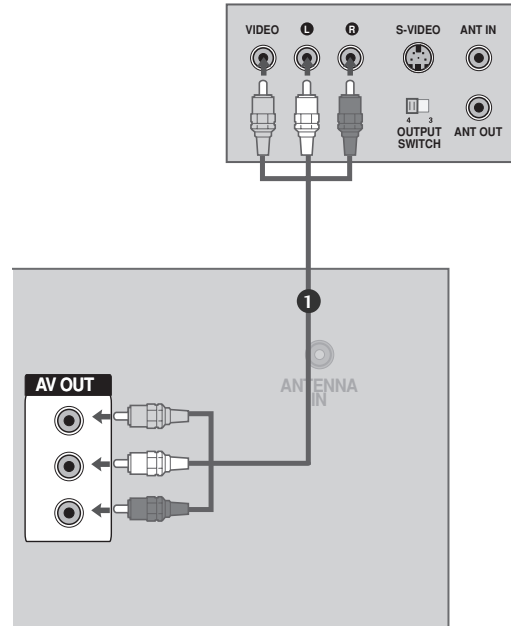

EXTERNAL STEREO

Use to connected either an external amplifier, or add a sub-woofer to your surround sound system.

1. How to connect

- 1 Connect the input jack of the stereos amplifier to the **VARIABLE AUDIO OUT** jacks on the set.
- 2 Set up your speakers through your analog stereo amplifier, according to the instructions provided with the amplifier.

NOTE

- ▶ When connecting with external audio equipments, such as amplifiers or speakers, please turn the TV speakers off. (▶ p.61)

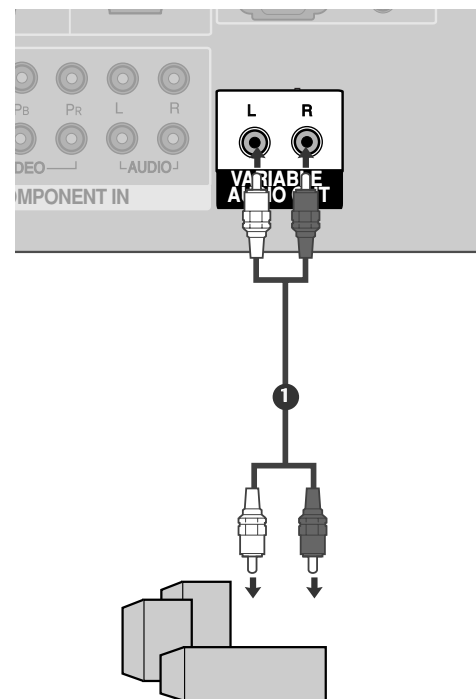

WATCHING TV /SETUP CONTROL

REMOTE CONTROL FUNCTIONS

When using the remote control, aim it at the remote control sensor on the TV.

WATCHING TV / SETUP CONTROL



POWER Turns your TV or any other programmed equipment on or off, depending on mode.

TV INPUT Returns to the TV mode.

INPUT If you press the button once, the input source OSD will appear on screen as shown. Press the ▲ / ▼ button and then ENTER button to select the desired input source (TV, AV1, AV2, Component 1, Component 2, RGB PC, HDMI1 or HDMI2).

RATIO Selects your desired picture format.

► p.54

Brightness adjustment Adjusts screen brightness. It returns to the default settings brightness by changing mode source.

PIP Switches the sub picture PIP, DW mode.

PIP CH - /+ Selects a channel for the sub picture.

* Not functional

PIP INPUT Selects the input source for the sub picture in PIP/DW mode.

VCR/DVD control buttons Controls some video cassette recorders or DVD players when you have already selected DVD or VCR mode button.

EXIT Clears all on-screen displays and returns to TV viewing from any menu.

MEMORY/ERASE Memorizes or erases selected channel.

MENU Selects a menu.

REVIEW Returns to the previously viewed channel.

CAPTION Selects CAPTION mode.

1 SIMPLINK See a list of AV devices connected to TV. When you toggle this button, the Simplink menu appears at the screen. ► p.42

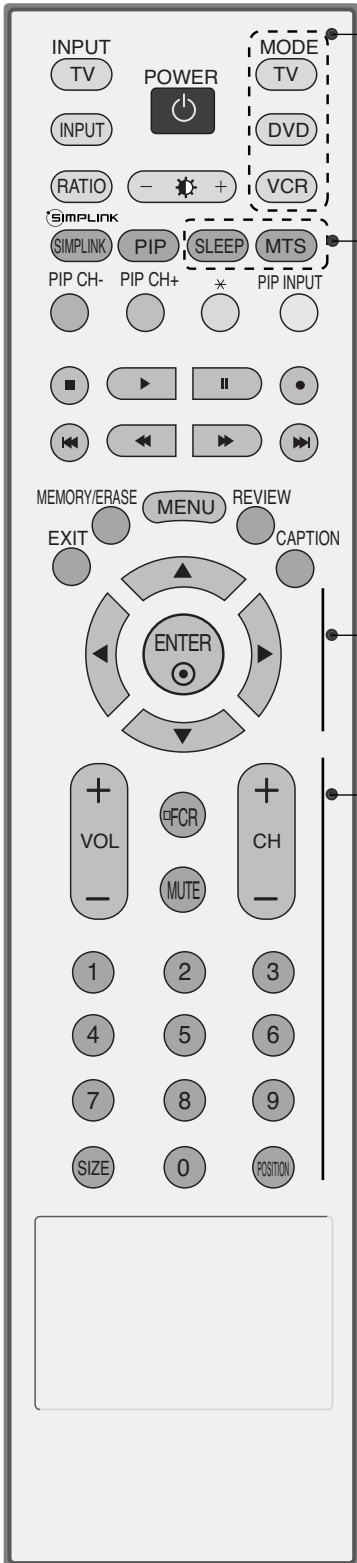

MODE Selects the remote operating modes.

SLEEP Sets the sleep timer.

MTS Selects the MTS sound: **Mono**, **Stereo**, or **SAP**.

THUMBSTICK (Up/Down/Left Right) Allows you to navigate the on-screen menus and adjust the system settings to your preference.

ENTER Accepts your selection or displays the current mode.

VOLUME UP/DOWN Increases/decreases the sound level.

FCR Selects a favorite channel.

MUTE Switches the sound on or off.

CHANNEL UP/DOWN Selects available channels found during Manual scan.

0~9 number button Selects a channel.
Selects numbered items in a menu.

SIZE Adjusts the sub picture size.

POSITION Moves the sub picture.

Installing Batteries

- Open the battery compartment cover on the back side and install the batteries matching correct polarity (+ with +, - with -).
- Install two 1.5V AA batteries. Don't mix old or used batteries with new ones.
- Close cover.

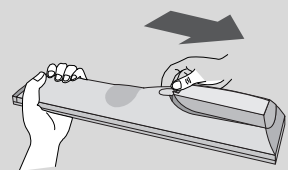

Remote control effective range

- Use a remote control up to 7 meters distance and 30 degree (left/right) within the receiving unit scope.
- Dispose of used batteries in a recycle bin to preserve environment.

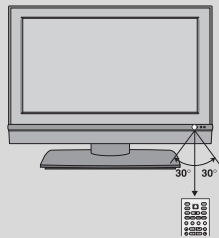

WATCHING TV /SETUP CONTROL

TURNING ON THE TV

If your TV will be turned on, you will be able to use its features.

- 1 First, connect power cord correctly.
At this moment, the TV switches to standby mode.
 - In standby mode to turn TV on, press the $\phi/1$, **INPUT**, **CH \blacktriangle / \blacktriangledown** button on the TV or press the **POWER**, **TV**, **INPUT**, **CH + /-**, **Number(0~9)** button on the remote control and then the TV will switch on.

Volume Adjustment

- 1 Press the **VOL + /-** button to adjust the volume.
- 2 If you want to switch the sound off, press the **MUTE** button.
- 3 You can cancel this function by pressing the **MUTE**, **VOL + /-** or **MTS** button.

Channel Adjustment

- 1 Press the **CH + /-** or **NUMBER** button to select a channel number.



! NOTE

- ▶ If you intend to be away on vacation, disconnect the power plug from wall power outlet.

ON SCREEN MENUS SELECTION AND ADJUSTMENT

Your TV's OSD (On Screen Display) may differ slightly from what is shown in this manual.
The OSD mainly use pictures for the Plasma TV models.

- 1 Press the **MENU** button and then use **▲** or **▼** button to select the each menu.
- 2 Press the **▶** button and then use **▲ ▼ ◀ ▶** button to display the available menus.

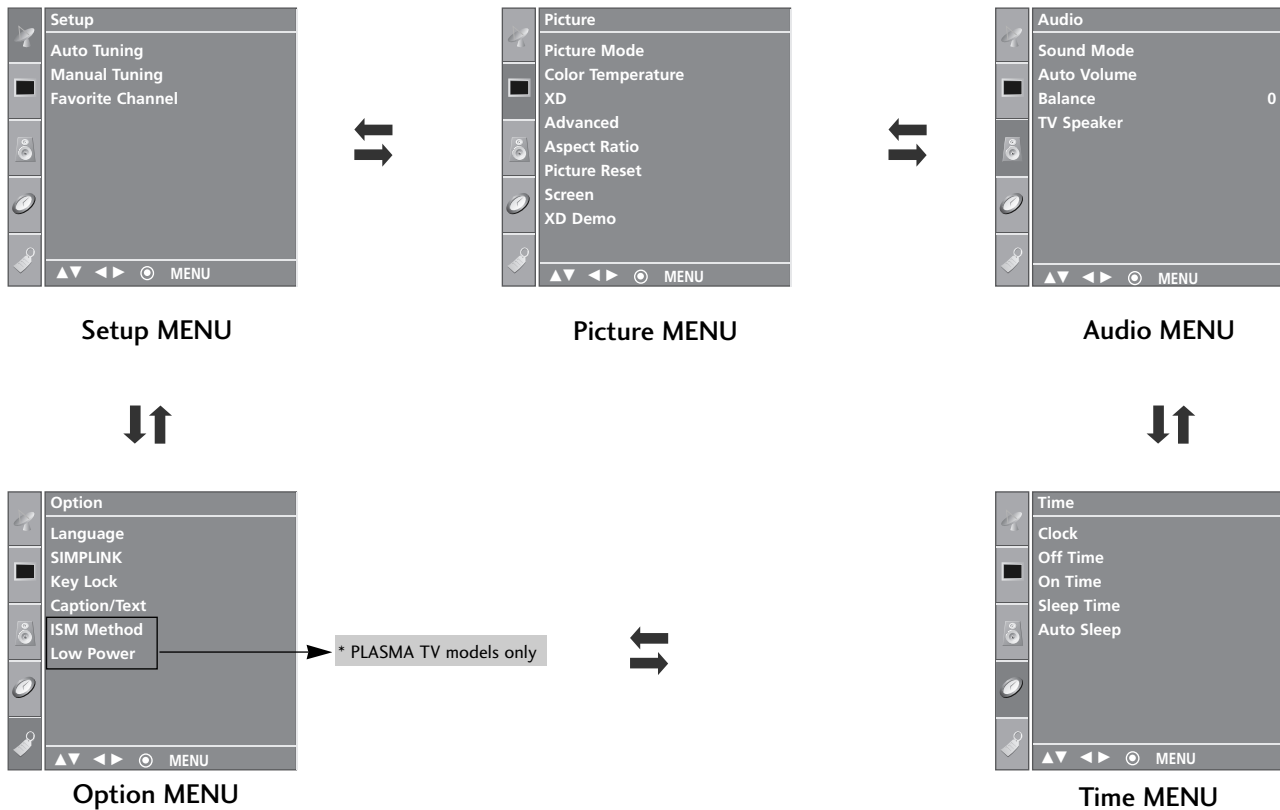

! NOTE

- a. The OSD (On Screen Display) function enables you to adjust the screen status conveniently since it provides graphical presentation.
- b. In this manual, the OSD (On Screen Display) may be different from your TV's because it is just example to help the TV operation.

WATCHING TV /SETUP CONTROL

CHANNEL SETUP

AUTO TUNING: CHANNEL SEARCH

Auto Tuning should be used to memorize all the active channels in your area before you are able to use the TV.

There are two ways of storing channels in the TV's memory. You can use either.

One is called **AUTO TUNING** and the other is called **MANUAL TUNING**.

In **AUTO TUNING** mode, the TV will memorize the channels in ascending numerical order. If there are additional channels you want to add or delete, you can manually add or delete those channels with Manual Tuning.

- Redo Auto Tuning if the TV is ever moved to another location.
- Auto Tuning will search for channels only through the Antenna jack.

1 Press the **MENU** button and then use ▲ or ▼ button to select the **Setup** menu.

2 Press the ► button and then use ▲ or ▼ button to select **Auto Tuning**.

3 Press the ► button. **Auto Tuning** starts the channel search.

4 If you want to stop auto programming, press the **MENU** button.
Only the channels found up to at that time are memorized.

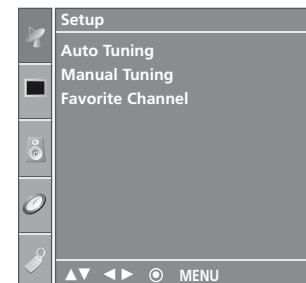
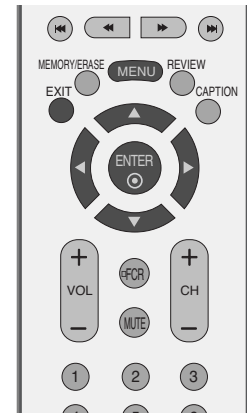

1



2

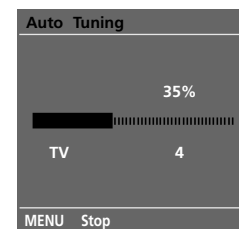

3

MANUAL TUNING: ADDING/DELETING CHANNELS

You can add or delete channels from the channel scan manually.

- 1 Use the **CH+ /-** or **NUMBER** buttons to select the channel number you want to add or delete.
- 2 Press the **MEMORY/ERASE** button.
- 3 Press the **MEMORY/ERASE** button to select **Memory** or **Erase**.
- 4 Press the **ENTER** button.



WATCHING TV / SETUP CONTROL

■ You can also use the **Setup** menu to adjust **Manual Tuning**.

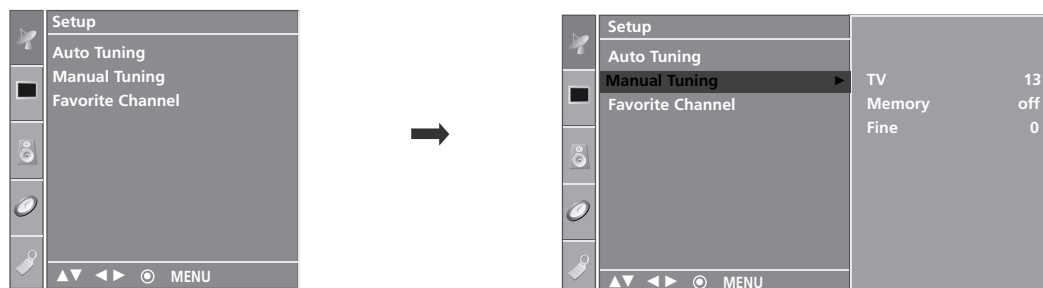

WATCHING TV /SETUP CONTROL

FINE TUNING ADJUSTMENT

Normally fine tuning is only necessary if reception is poor.

To remove fine tuning from a channel, reprogram the finely-tuned channel with Auto program or Manual Program.

If a finely-tuned channel is memorized, the color of the channel number changes to yellow.

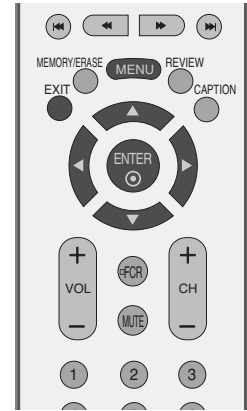

1 Press the **MENU** button and then use ▲ or ▼ button to select the **Setup** menu.

2 Press the ► button and then use ▲ or ▼ button to select **Manual Tuning**.

3 Press the ► button and then use ▲ or ▼ button to select **Fine**.

4 Press the ◀ or ▶ button to adjust the picture to your preference.

5 Press the **ENTER** button to store it.

6 Press the **EXIT** button to return to TV viewing or press the **MENU** button to return to the previous menu.

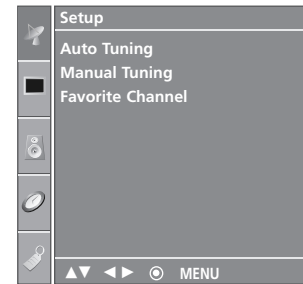

1

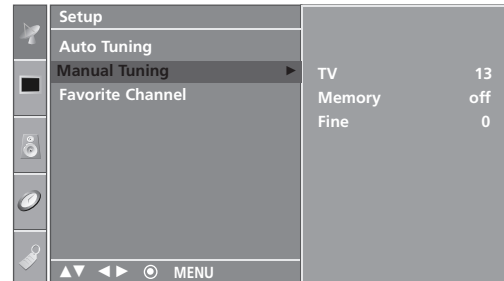

2



3

FAVORITE CHANNELS SETUP

Favorite Channels is a convenient feature that lets you quickly scan up to 8 channels of your choice without having to wait for the TV to scan through all the in-between channels.

To tune to a favorite channel, press the **FCR** (Favorite Channel Review) button repeatedly. The 8 favorite channels appear on the screen in numerical order.

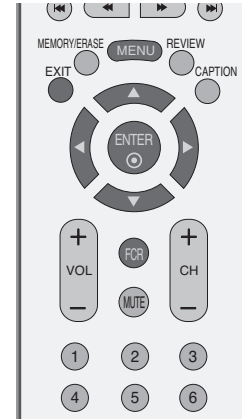

1 Press the **MENU** button and then use **▲** or **▼** button to select the **Setup** menu.

2 Press the **▶** button and then use **▲** or **▼** button to select **Favorite Channel**.

3 Press the **▶** button and then use **▲** or **▼** button to select the first favorite program position.

4 Use the **◀** or **▶** button to set the desired channel number for first favorite program.

5 Press the **EXIT** button to return to normal TV viewing.

6 Repeat steps 3 to 5 to memorize other favorite programs.

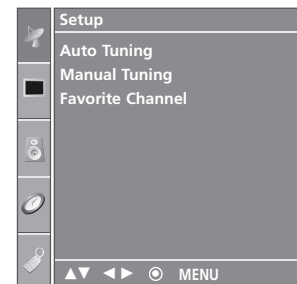

1

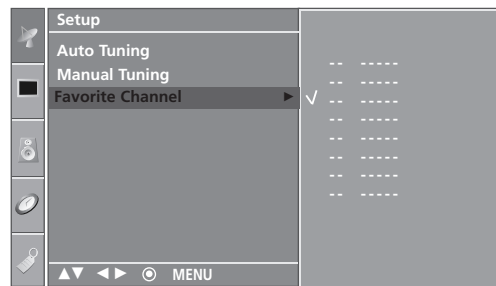

2 3 4 5

WATCHING TV /SETUP CONTROL



This operates only for the devices with the logo.
Please check the logo.

This allows you to control and play other AV devices connected to the display through HDMI cable without additional cables and settings.



1 Press the **MENU** button and then use **▲** or **▼** button to select the **Option** menu.

2 Press the **▶** button and then use **▲** or **▼** button to select **SIMPLINK**.

3 Press the **▶** button and then use **▲** or **▼** button to select **On** or **Off**.

4 Press the **EXIT** button to return to TV viewing or press the **MENU** button to return to the previous menu.

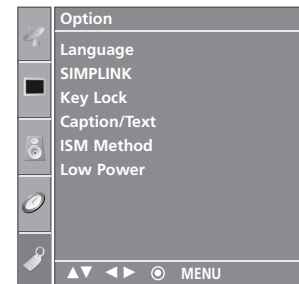

1

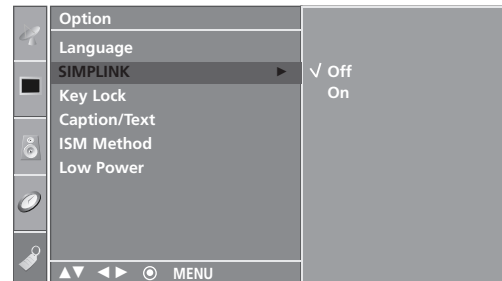

2 3

! NOTE

- ▶ Connect the HDMI/DVI IN 1 or HDMI IN 2 terminal of the TV to the rear terminal (HDMI output) of the Simplink device with the HDMI cable.
- ▶ After connecting the HDMI terminal for the home theater with simplink function in the above method, connect the VARIABLE AUDIO OUT terminal on the back of the TV to the VARIABLE AUDIO IN terminal on the back of the simplink device with the VARIABLE AUDIO OUT cable.
- ▶ When operating the external device with Simplink, press the TV button among the MODE button on the remote control.
- ▶ When you switch the Input source with the INPUT button on the remote control, you can stop the operation of device worked by Simplink.
- ▶ When you select or operate the media device with home theater function, the speaker automatically switches to home theater speaker (HT speaker).

SIMPLINK Functions

Direct Play

After connecting AV devices to TV, you can directly control the devices and play media without additional settings.

Select AV device

Enables you to select one of AV devices connected to TV and play it.

Disc playback

Control connected AV devices by pressing the , **▲▼◀▶**, **ENTER** buttons and buttons for play, stop, pause, fast reverse, fast forward, chapter skip.

Power off all devices

When you power off TV, all connected devices are turned off.

Switch audio-out

Offers an easy way to switch audio-out.

(A device, which is connected to TV through HDMI cable but does not support Simplink, does not provide this function)

Note: To operate SIMPLINK, the HDMI cable over 1.2 version with *CEC function should be used. (*CEC: Consumer Electronics Control)
Version 1.2 is the cable connected to No. 13 Pin and is the line to exchange information between units.

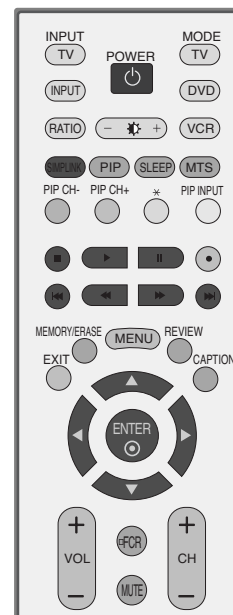

- 1 After selecting the **TV** button of the **MODE** on the remote control, press the **SIMPLINK** button.
- 2 Use **▲▼◀▶** button to select the desired device and then press the **ENTER** button.
- 3 Control connected AV devices by pressing the , **▲▼◀▶**, **ENTER** buttons.

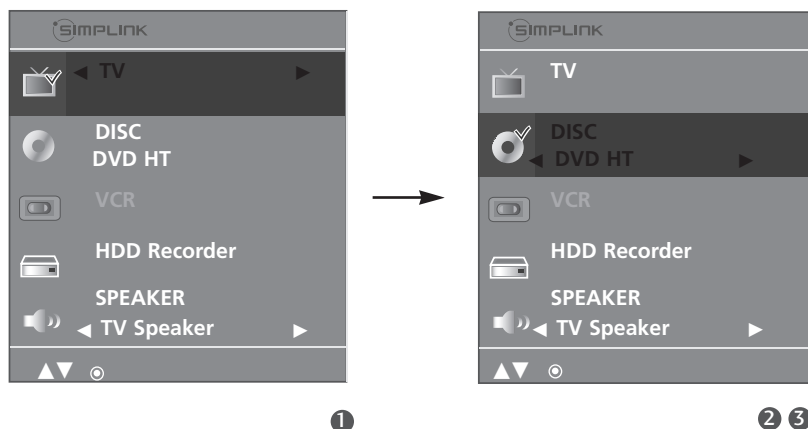

WATCHING TV /SETUP CONTROL

SIMPLINK Menu

- 1 **TV viewing** : Switch to the previous TV channel regardless of the current mode.
- 2 **DISC playback** : Select and play discs. When multiple discs are available, the titles of the discs are conveniently displayed at the bottom of the screen.
- 3 **VCR playback** : Play and control the connected VCR.
- 4 **HDD Recordings playback** : Play and control recordings stored in HDD.
- 5 **Audio Out to HT speaker/Audio Out to TV** : Select HT speaker or TV speaker for Audio Out.

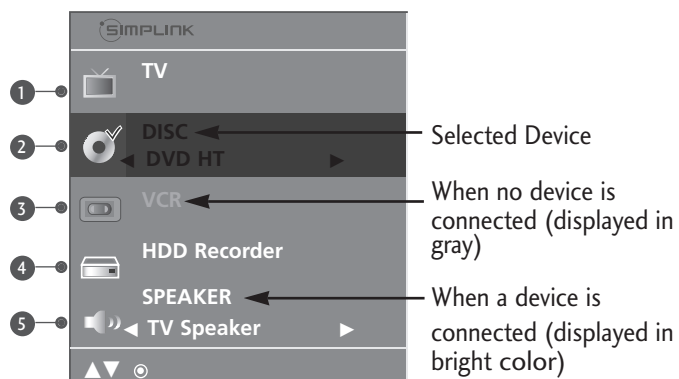

PICTURE CONTROL

PIP / DOUBLE WINDOW

PIP lets you view 2 different inputs (sources) on your TV screen at the same time. One source will be large, and the other source will show a smaller inset image.

Double Window mode splits the screen into two images, allowing two picture sources to be shown on the TV screen at the same time. Each source is given half the screen.

PIP function is available in the Component, RGB, HDMI mode. (But, it can't adjust 480i resolution of Component mode.)

Watching PIP/Double Window

Press the **PIP** button to access the sub picture.
Each press of PIP changes the PIP options as shown below.

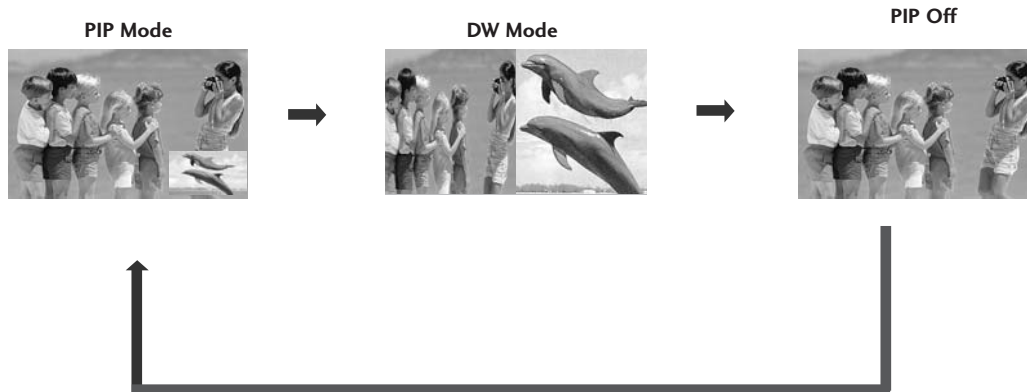

TV Program Selection for PIP

- 1 Use the **PIP CH +/-** button to select a channel for the sub picture.
The selected channel number is displayed just below the input source of main picture.

PICTURE CONTROL

Selecting an Input Signal Source for the PIP/Double Window

Use the **PIP INPUT** button to select the input source for the sub picture.
Each press of **PIP INPUT** button changes the PIP source.
(Sub picture can be selected only TV, AV1, AV2)

Sub Picture Size Adjustment (PIP mode only)

Press the **SIZE** button to adjust the sub picture size.
With **SIZE** button in PIP mode, sub picture is adjusted.

Moving the Sub Picture (PIP mode only)

Press the **POSITION** button.
Repeatedly press the **POSITION** button then sub picture moves.

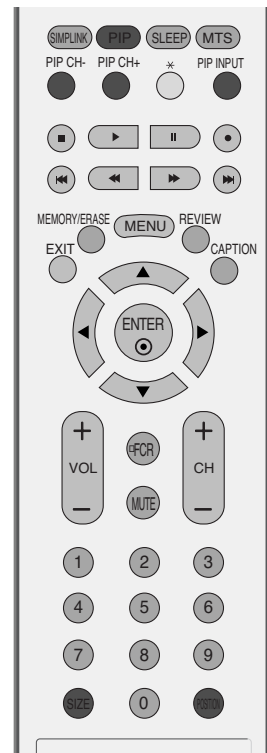

PICTURE MODE CONTROL

- Dynamic** Select this option to display with a sharp image.
- Standard** The most general and natural screen display status.
- Mild** Select this option to display with a mild image.
- User1/2** Select this option to use the user-defined setting.



- 1 Press the **MENU** button and then use ▲ or ▼ button to select the **Picture** menu.

- 2 Press the ► button and then use ▲ or ▼ button to select **Picture Mode**.

- 3 Press the ► button and then use ▲ or ▼ button to select **Dynamic, Standard, Mild, User1** or **User2**.

- 4 Press the **EXIT** button to return to TV viewing or press the **MENU** button to return to the previous menu.

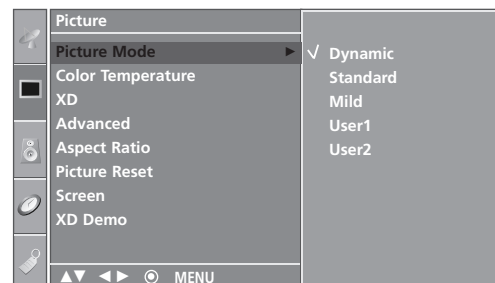
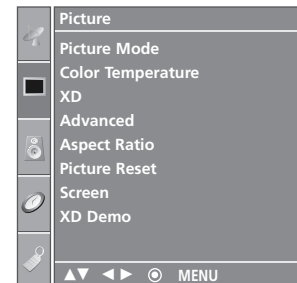

- **Picture Mode** adjusts the TV for the best picture appearance. Select the preset value in the Picture Mode menu based on the program category.
- **Dynamic, Standard, Mild** Settings are preset for optimum picture quality at the factory and are not adjustable.
- In the **User1** and **User2** modes only, you can directly adjust the contrast, brightness, color, sharpness, tint.

PICTURE CONTROL

MANUAL PICTURE CONTROL (PICTURE MODE-USER OPTION)

Adjust the picture appearance to suit your preference and viewing situations.

- Contrast** Adjusts the difference between the light and dark levels in the picture.
- Brightness** Increases or decreases amount of white in the picture.
- Color** Adjusts intensity of all colors.
- Sharpness** Adjusts the level of crispness in the edges between the light and dark areas of the picture. The lower the level, the softer the image.
- Tint** Adjusts the balance between red and green levels.

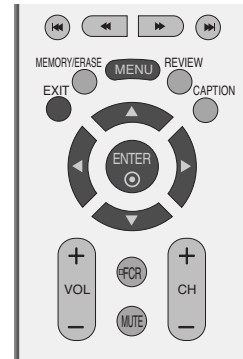

PICTURE CONTROL

1 Press the **MENU** button and then use ▲ or ▼ button to select the **Picture** menu.

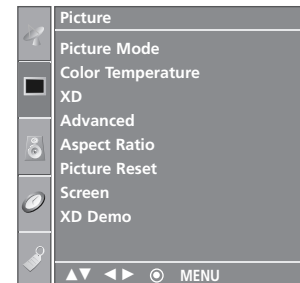

2 Press the ► button and then use ▲ or ▼ button to select **Picture Mode**.

3 Press the ► button and then use ▲ or ▼ button to select **User 1** or **User 2**.

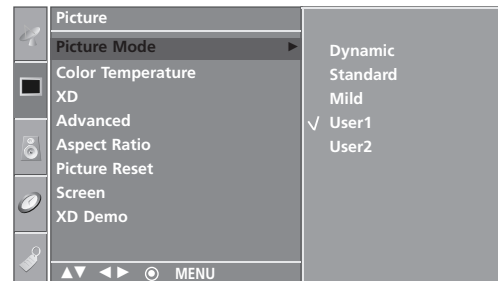

4 Press the ► button and then use ▲ or ▼ button to select the desired picture option (**Contrast**, **Brightness**, **Color**, **Sharpness** and **Tint**).

5 Press the ► button and then use ◀ or ▶ button to make appropriate adjustments.

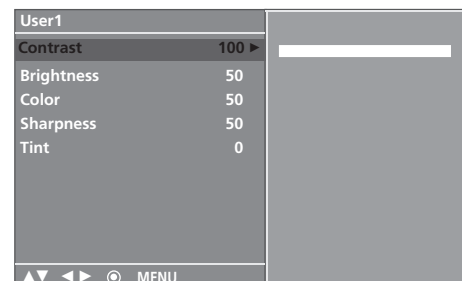

6 Press the **EXIT** button to return to TV viewing or press the **MENU** button to return to the previous menu.



NOTE

- ▶ In RGB-PC/HDMI(No signal) mode, you can't adjust color, sharpness and tint to the levels you prefer.

COLOR TEMPERATURE CONTROL

Choose one of three automatic color adjustments. Set to warm to enhance hotter colors such as red, or set to cool to see less intense colors with more blue.

This menu is activated after selecting the User 1 or User 2 of Picture Mode.

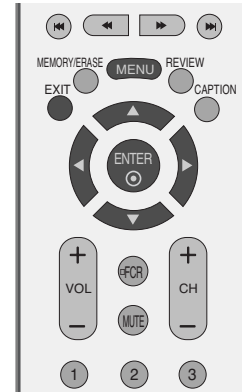

1 Press the **MENU** button and then use ▲ or ▼ button to select the **Picture** menu.

2 Press the ► button and then use ▲ or ▼ button to select **Color Temperature**.

3 Press the ► button and then use ▲ or ▼ button to select either **Cool, Medium, Warm** or **User**.

4 Press the **EXIT** button to return to TV viewing or press the **MENU** button to return to the previous menu.

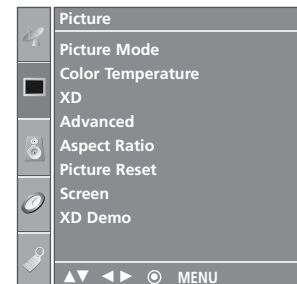

1

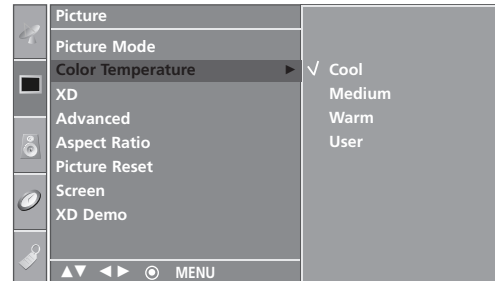

2 3

PICTURE CONTROL

MANUAL COLOR TEMPERATURE CONTROL (USER OPTION)

You can also adjust the detailed settings (Red, Green, Blue) by selecting the **user** menu.

This menu is activated after selecting the User 1 or User 2 of Picture Mode.



PICTURE CONTROL

1 Press the **MENU** button and then use ▲ or ▼ button to select the **Picture** menu.

2 Press the ► button and then use ▲ or ▼ button to select **Color Temperature**.

3 Press the ► button and then use ▲ or ▼ button to select **User**.

4 Press the ► button and then use ▲ or ▼ button to select **Red, Green** or **Blue**.

5 Press the ► button and then use ◀ or ▶ button to make appropriate adjustments.

- The adjustment range of **Red, Green, or Blue** is -30 ~ +30.

6 Press the **EXIT** button to return to TV viewing or press the **MENU** button to return to the previous menu.

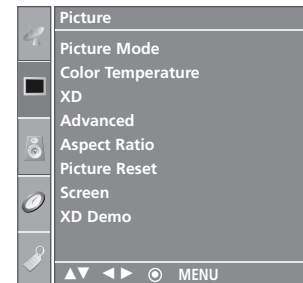

1

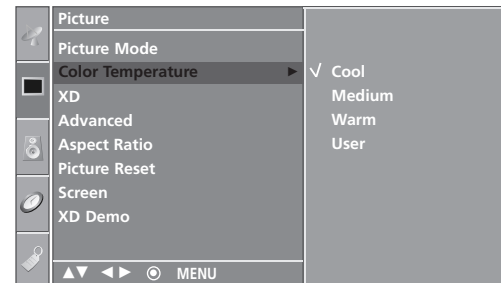

2 3



4



5

XD

XD is LG Electronic's unique picture improving technology to display a real HD source through an advanced digital signal processing algorithm.

When selecting Picture Mode options (Dynamic, Standard and Mild), XD is automatically changed to Auto.

When selecting Picture Mode options (User 1 and User 2), you can choose the Auto / Manual.

When selecting the Manual, you can adjust the XD Contrast, XD color and XD NR.

It's not available to use this function in RGB-PC/HDMI(No signal) mode.



- 1 Press the **MENU** button and then use ▲ or ▼ button to select the **Picture** menu.
- 2 Press the ► button and then use ▲ or ▼ button to select **XD**.
- 3 Press the ► button and then use ▲ or ▼ button to select **Auto** or **Manual**.

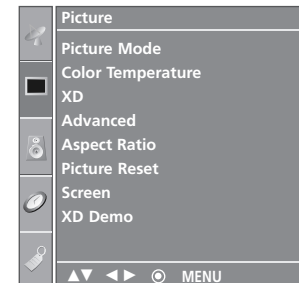

1

Selecting the Manual

This menu is activated after selecting the User 1 or User 2 of Picture Mode.

1. Press the ► button and then use ▲ or ▼ button to select **XD Contrast**, **XD Color** or **XD NR (Noise)**.
 - **XD Contrast:** Optimizing the contrast automatically according to the brightness of the reflection.
 - **XD Color:** Adjusting the colors of the reflection automatically to reproduce as closely as possible to the natural colors.
 - **XD NR (Noise) :** Removing the noise up to the point where it does not damage the original picture. (It's not available to use this function in HDMI, Component (except 480i), RGB-PC mode.)
2. Press the ► button and then use ▲ or ▼ button to select **On** or **Off**.

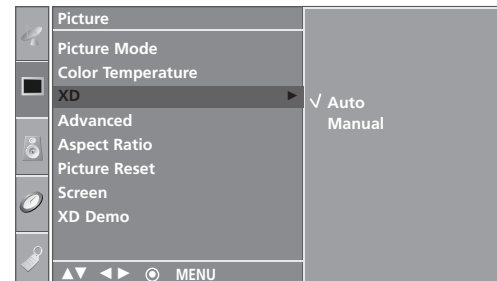

2 3

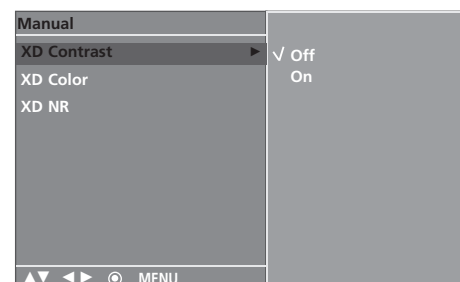

3

- 4 Press the **EXIT** button to return to TV viewing or press the **MENU** button to return to the previous menu.

PICTURE CONTROL

ADVANCED-CINEMA MODE SETUP

Set up the TV for the best picture appearance for viewing movies.

When you operate Cinema (3:2 Pull-Down Mode or Cinema Correction Mode), the TV will adjust 24 fps video from movies to 30 fps video for display.

This feature operates only in Analog TV, AV, S-video and Component 480i mode.

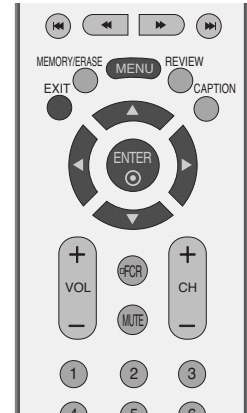

PICTURE CONTROL

1 Press the **MENU** button and then use ▲ or ▼ button to select the **Picture** menu.

2 Press the ► button and then use ▲ or ▼ button to select **Advanced**.

3 Press the ► button and then use ▲ or ▼ button to select **Cinema**.

4 Press the ► button and then use ▲ or ▼ button to select **On** or **Off**.

5 Press the **EXIT** button to return to TV viewing or press the **MENU** button to return to the previous menu.

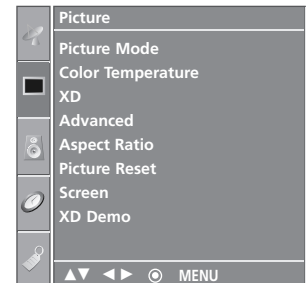

1

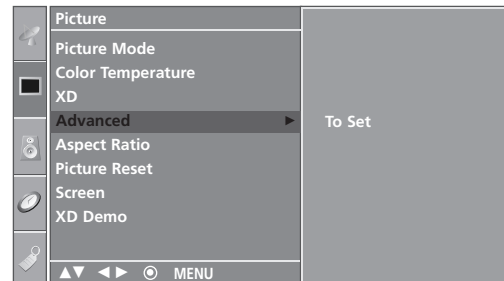

2 3

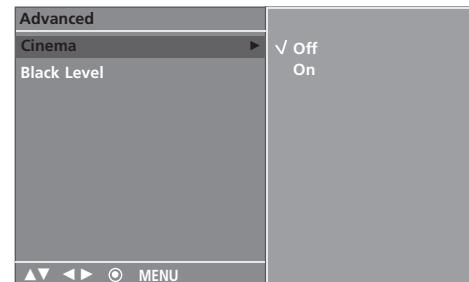

4

ADVANCED-BLACK LEVEL

Adjusting the contrast and the brightness of the screen using the black level of the screen.

This feature operates only in AV, S-Video and HDMI mode.
It's not available to use this function in HDMI(No signal) mode.

- 1 Press the **MENU** button and then use ▲ or ▼ button to select the **Picture** menu.
- 2 Press the ► button and then use ▲ or ▼ button to select **Advanced**.
- 3 Press the ► button and then use ▲ or ▼ button to select **Black Level**.
- 4 Press the ► button and then use ▲ or ▼ button to select **Low** or **High**.
 - **Low**
The reflection of the screen gets darker.
 - **High**
The reflection of the screen gets brighter.
- 5 Press the **EXIT** button to return to TV viewing or press the **MENU** button to return to the previous menu.

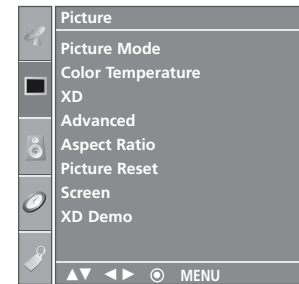
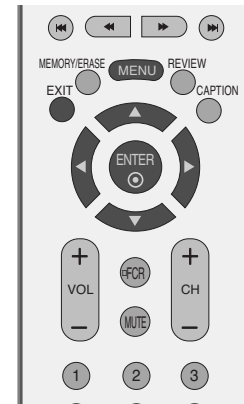

1

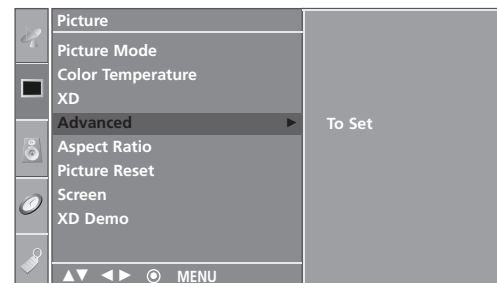

2 3

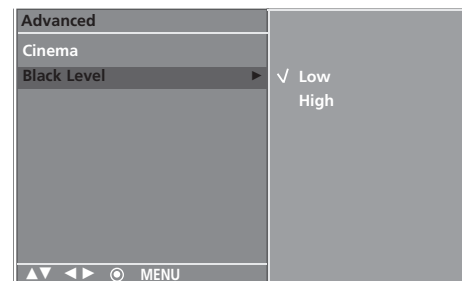

4

PICTURE CONTROL

ASPECT RATIO CONTROL

This feature lets you choose the way an analog picture with a 4:3 aspect ratio is displayed on your TV. When you receive an analog picture with a 4:3 aspect ratio on your 16:9 TV, you need to specify how the picture is to be displayed.

- Component, RGB and HDMI input source use 4:3 or 16:9 aspect ratio.

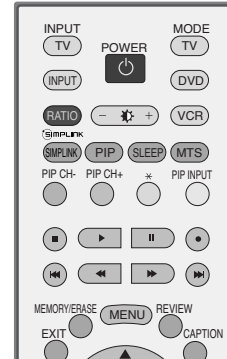

NOTE

- ▶ If a fixed image is displayed on the screen for a long time, the image may become imprinted on the screen and remain visible. This phenomenon is common to all manufactures and in consequence the manufactures warranty does not cover the product bearing this phenomenon.

- 1 Press the **RATIO** button repeatedly to select the desired picture format.

You can also adjust **Aspect Ratio** in the **Picture** menu.

4:3

Choose 4:3 when you want to view a picture with an original 4:3 aspect ratio.



16:9

Adjust the picture horizontally, in a linear proportion to fill the entire screen.



Horizon

The screen size is, more enlarged at both sides, to create a spectacular view.

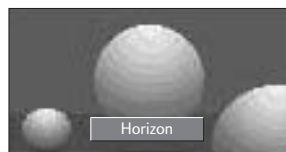

Zoom 1

Choose Zoom 1 when you want to view the picture without any alteration. However, the top and bottom portions of the picture will be cropped.

You can move the Zoom1 screen using ▲ or ▼ button.

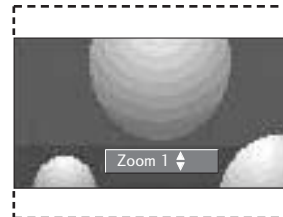

Zoom 2

Choose Zoom 2 when you want the picture to be altered, both vertically extended and cropped. The picture taking a halfway trade off between alteration and screen coverage.

You can move the Zoom2 screen using ▲ or ▼ button.

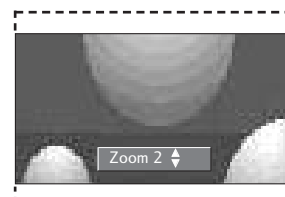

PICTURE RESET

Use to quickly reset all the Picture menu options to their original factory preset values.



- 1 Press the **MENU** button and then use **▲** or **▼** button to select the **Picture** menu.
- 2 Press the **▶** button and then use **▲** or **▼** button to select **Picture Reset**.
- 3 Press the **▶** button to initialize the adjusted value.

- Returns to the default settings Picture Mode, Color Temperature, XD, Advanced, Aspect Ratio at the factory.

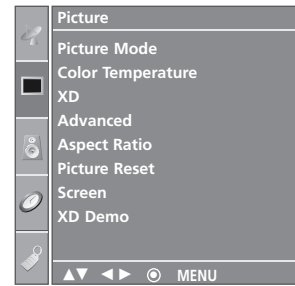

1

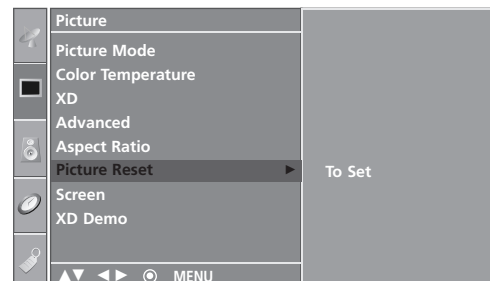

2 3

PICTURE CONTROL

XD DEMO

Use it to see the difference between XD Demo on and XD Demo off.

Note: It's not available to use this function in RGB-PC/HDMI(No signal) mode.



PICTURE CONTROL

1 Press the **MENU** button and then use ▲ or ▼ button to select the **Picture** menu.

2 Press the ► button and then use ▲ or ▼ button to select **XD Demo**.

3 Press the ► button to begin **XD Demo**.

4 To stop **XD Demo**, press the **MENU** button.

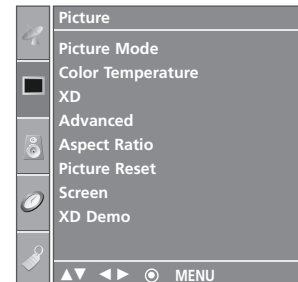

1

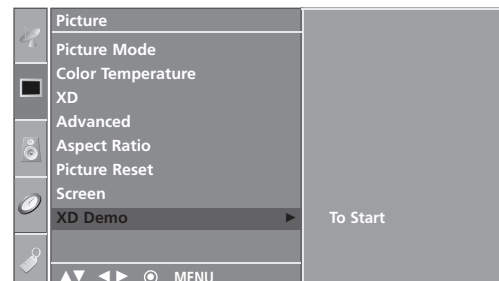

2 3

• XD Demo



AUDIO CONTROL

SOUND MODE CONTROL

Sound Mode lets you enjoy the best sound without any special adjustment because the TV sets the appropriate sound options based on the program content.

Surround MAX, Standard, Music, Movie, and Sports are preset for good sound quality at the factory and are not adjustable.

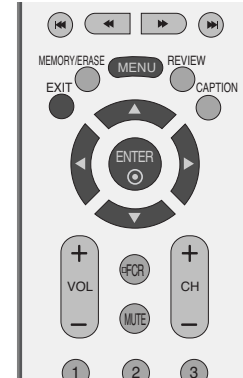

Surround MAX Select this option to sound realistic.

Standard The most commanding and natural audio.

Music Select this option to enjoy the original sound when listening to the music.

Movie Select this option to enjoy sublime sound.

Sports Select this option to watch sports broadcasting.

User Select this option to use the user-defined audio settings.

1 Press the **MENU** button and then use ▲ or ▼ button to select the **Audio** menu.

2 Press the ► button and then use ▲ or ▼ button to select **Sound Mode**.

3 Press the ► button and then use ▲ or ▼ button to select **Surround MAX, Standard, Music, Movie, Sports** or **User**.

4 Press the **EXIT** button to return to TV viewing or press the **MENU** button to return to the previous menu.

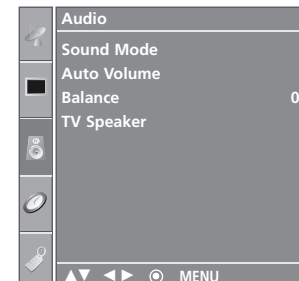

1

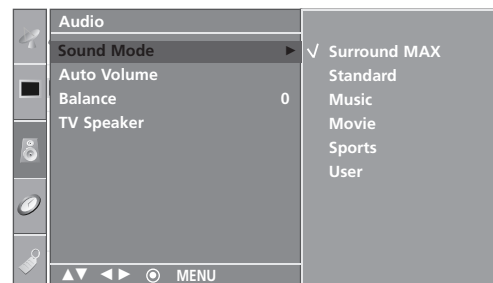

2 3

AUDIO CONTROL

SOUND CONTROL ADJUSTMENT (USER OPTION)

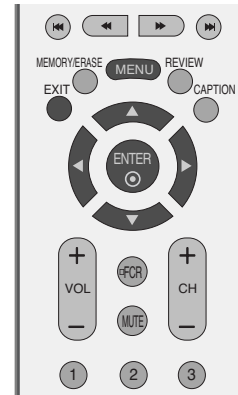

AUDIO CONTROL

- 1 Press the **MENU** button and then use ▲ or ▼ button to select the **Audio** menu.
- 2 Press the ► button and then use ▲ or ▼ button to select **Sound Mode**.
- 3 Press the ► button and then use ▲ or ▼ button to select **User**.
- 4 Press the ► button.
- 5 Select a sound band by pressing the ◀ / ▶ button. Make appropriate sound level with the ▲ / ▼ button.
- 6 Press the **EXIT** button to return to TV viewing or press the **MENU** button to return to the previous menu.

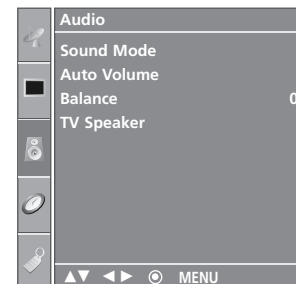

1

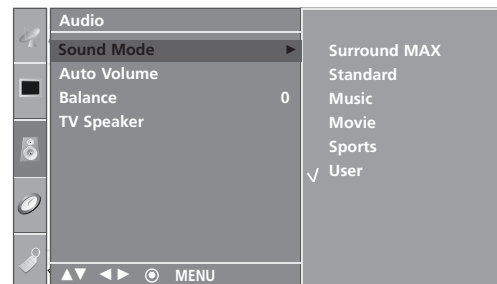

2 3 4

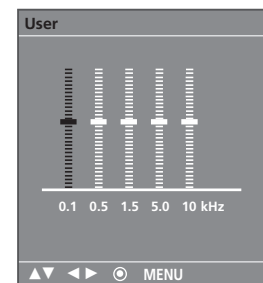

5

AUTO VOLUME LEVELER

Auto Volume automatically keeps on an equal volume level even if you change program.

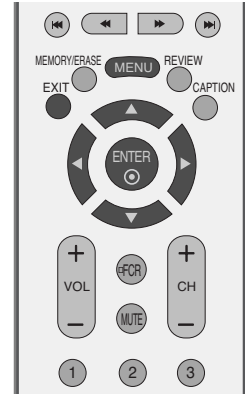

- 1 Press the **MENU** button and then use ▲ or ▼ button to select the **Audio** menu.
- 2 Press the ► button and then use ▲ or ▼ button to select **Auto Volume**.
- 3 Press the ► button and then use ▲ or ▼ button to select **On** or **Off**.
- 4 Press the **EXIT** button to return to TV viewing or press the **MENU** button to return to the previous menu.

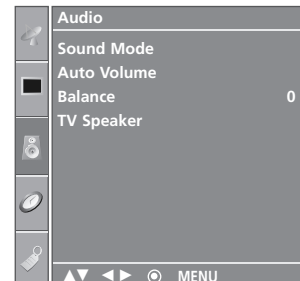

1

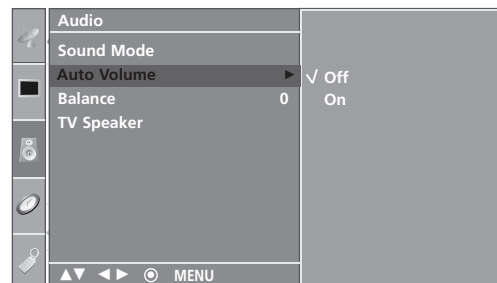

2 3

AUDIO CONTROL

BALANCE ADJUSTMENT

Adjust the left/right sound of speaker to suit your taste and room situations.

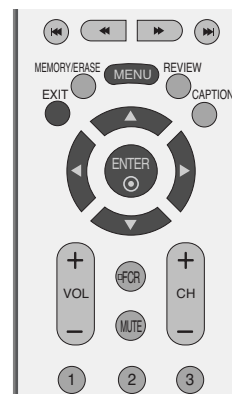

1 Press the **MENU** button and then use ▲ or ▼ button to select the **Audio** menu.

2 Press the ► button and then use ▲ or ▼ button to select **Balance**.

3 Press the ► button and then use ◀ or ▶ button to make desired adjustment.

4 Press the **EXIT** button to return to TV viewing or press the **MENU** button to return to the previous menu.

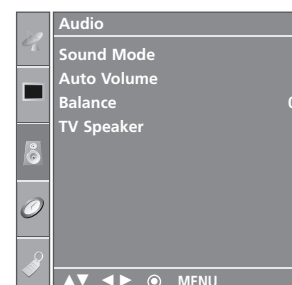

1

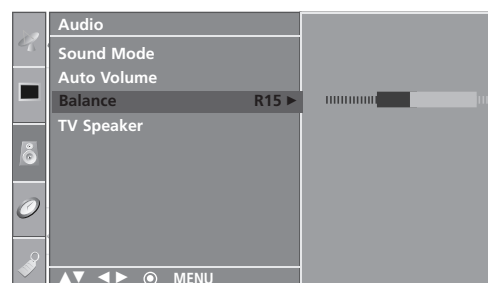

2 3

TV SPEAKERS ON/OFF SETUP

Turn the TV speakers off if using external audio equipment. Feature turns the TV Speakers option On or Off.

In AV, Component, RGB-PC and HDMI mode, internal speaker audio can be outputted even though there is no video signal.

If you want to use your external hi-fi stereo system, turn off the internal speakers of the set.

1 Press the **MENU** button and then use ▲ or ▼ button to select the **Audio** menu.

2 Press the ► button and then use ▲ or ▼ button to select **TV Speaker**.

3 Press the ► button and then use ▲ or ▼ button to select **On** or **Off**.

4 Press the **EXIT** button to return to TV viewing or press the **MENU** button to return to the previous menu.

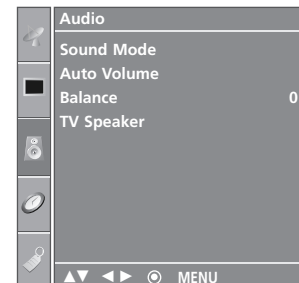
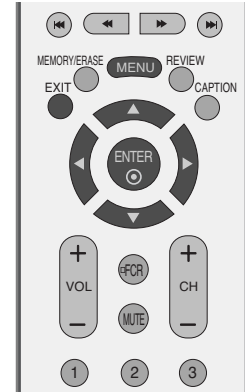

1

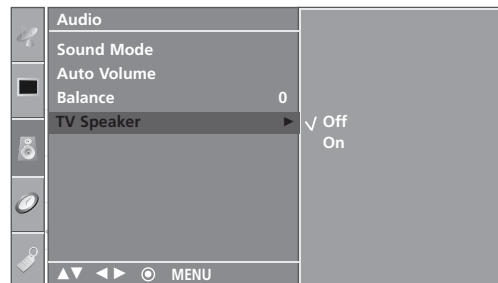

2 3

AUDIO CONTROL

STEREO/SAP BROADCASTS SETUP

The TV can receive MTS stereo programs and any SAP (Secondary Audio Program) that accompanies the stereo program; if the broadcaster transmits one additional sound signal in addition to the original one.

Mono: The primary language is heard from left and right speakers.
Signal mode is mono.

Stereo: The primary language is heard from left and right speakers.
Signal mode is stereo.

SAP: The secondary language is heard from left and right speakers in mono sound.

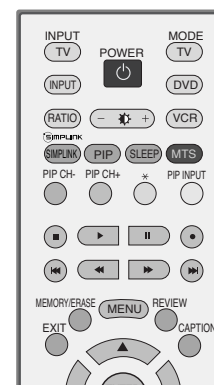

- 1 Use the **MTS** button to select your desired MTS mode in analog signal. Each time you press the **MTS** button, **Mono**, **Stereo**, or **SAP** appear in turn.
- 2 Press the **EXIT** button to save and return to TV viewing.

NOTE

- ▶ Select mono sound mode if the signal is not clear or in poor signal reception areas.
- ▶ **Stereo**, **SAP** modes are available only if included on the broadcast signal.

TIME SETTING

CLOCK SETUP

If the current time setting is wrong, reset the clock manually.

- 1 Press the **MENU** button and then use ▲ or ▼ button to select the **Time** menu.
- 2 Press the ► button and then use ▲ or ▼ button to select **Clock**.
- 3 Press the ► button and then use ▲ or ▼ button to set the Time.
- 4 Press **EXIT** button to return to TV viewing or press **MENU** button to return to the previous menu.

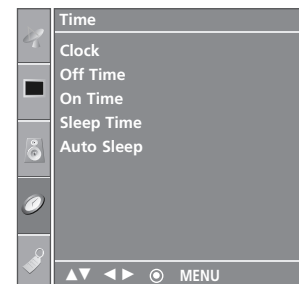

1

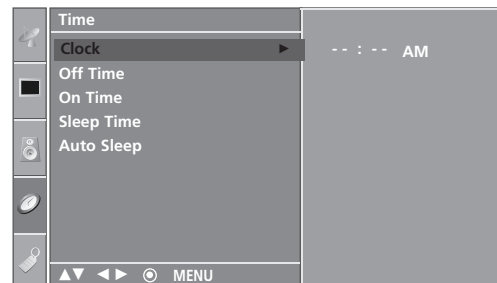

2 3

TIME SETTING

ON/OFF TIME SETUP

The time function operates only if the current time has been set.

The Off-Time function overrides the On-Time function if they are both set to the same time.

The TV must be in standby mode for the On-Time to work. If you do not press any button within 2 hours after the TV turns on with the On Time function, the TV will automatically revert to standby mode.



TIME SETTING

- 1 Press the **MENU** button and then use **▲** or **▼** button to select the **Time** menu.

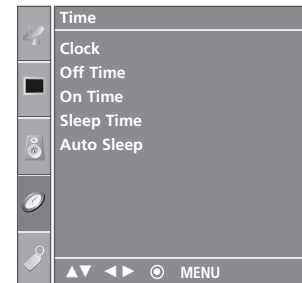

- 2 Press the **▶** button and then use **▲** or **▼** button to select **Off time** or **On time**.

- 3 Press the **▶** button and then use **▲** or **▼** button to select **On**.
 - To cancel the **On/Off time** function, select **Off**.

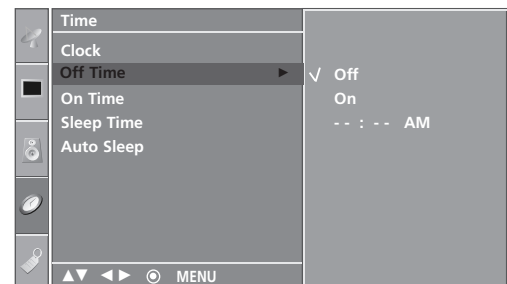

- 4 Press the **▶** button and then use **▲** or **▼** button to set the hour.

- 5 Press the **▶** button and then use **▲** or **▼** button to set the minutes.

2 3 4 5

- 6 **Only On time**
 Press the **▶** button and then use **▲** or **▼** to set the sound level at turn-on.
 Press the **▶** button and then use **▲** or **▼** to select the channel at turn-on.

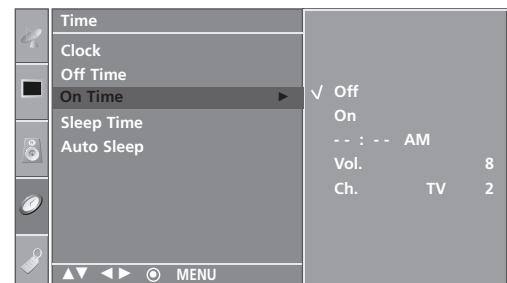

2 3 4 5 6

- 7 Press the **EXIT** button to return to TV viewing or press the **MENU** button to return to the previous menu.

SLEEP TIME

The Sleep Time turns the TV off at the preset time.

Note that this setting is cleared when the TV is turned off.

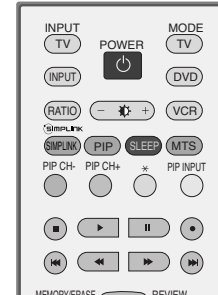

1 Press the **SLEEP** button repeatedly to select the number of minutes. First the  - - - option appears on the screen, followed by the following sleep timer options : 10, 20, 30, 60, 90, 120, 180, and 240 minutes.

2 When the number of minutes you want is displayed on the screen, press the **ENTER** button. The timer begins to count down from the number of minutes selected.

- You can also adjust **Sleep** in the **Time** menu.

! NOTE

- ▶ To view the remaining sleep time, press the **SLEEP** button once.
- ▶ To cancel the sleep time, repeatedly press the **SLEEP** button until the display ' - - -' appears.
- ▶ When you switch the set off, the set releases the preset sleep time.

TIME SETTING

AUTO SLEEP

If set to on and there is no input signal, the TV turns off automatically after 10 minutes.

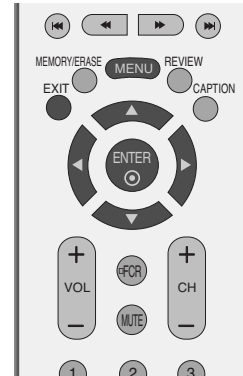

TIME SETTING

1 Press the **MENU** button and then use ▲ or ▼ button to select the **Time** menu.

2 Press the ► button and then use ▲ or ▼ button to select **Auto Sleep**.

3 Press the ► button and then use ▲ or ▼ button to select **On** or **Off**.

4 Press **EXIT** button to return to TV viewing or press **MENU** button to return to the previous menu.

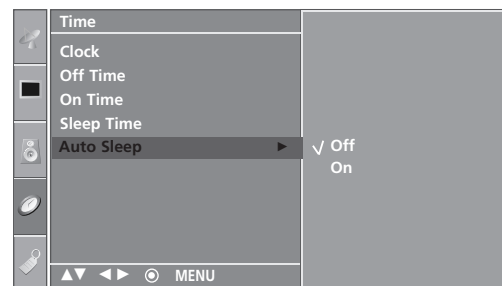
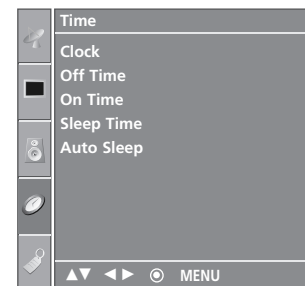

OPTION CONTROL

ON-SCREEN MENUS LANGUAGE SELECTION

The menus can be shown on the screen in the selected language.
First select your language.

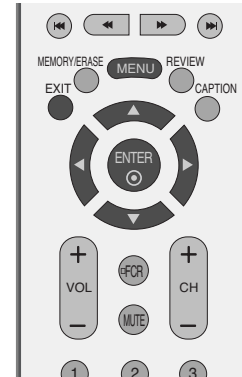

1 Press the **MENU** button and then use ▲ or ▼ button to select the **Option** menu.

2 Press the ► button and then use ▲ or ▼ button to select **Language**.

3 Press the ► button and then use ▲ or ▼ button to select your desired language.
From this point on, the on-screen menus will be shown in the selected language.

4 Press the **EXIT** button to return to TV viewing or press the **MENU** button to return to the previous menu.

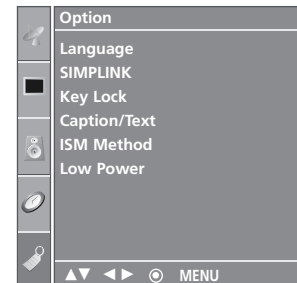

1

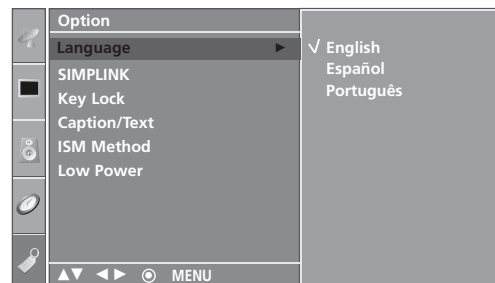

2 3

OPTION CONTROL

KEY LOCK

The TV can be set so that the remote control is needed to control it.

This feature can be used to prevent unauthorized viewing by locking out the front panel controls.

This TV is programmed to remember which option it was last set to even if you turn the set off.

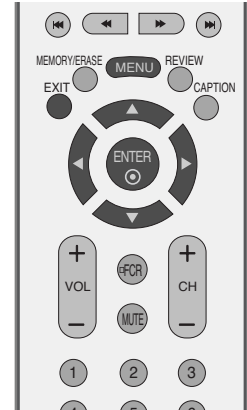

1 Press the **MENU** button and then use ▲ or ▼ button to select the **Option** menu.

2 Press the ► button and then use ▲ or ▼ button to select **Key lock**.

3 Press the ► button and then use ▲ or ▼ button to select **On** or **Off**.

4 Press the **EXIT** button to return to TV viewing or press the **MENU** button to return to the previous menu.

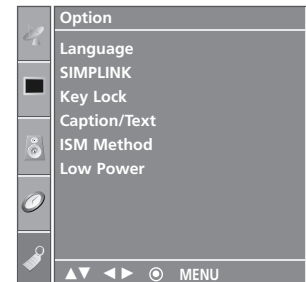

1

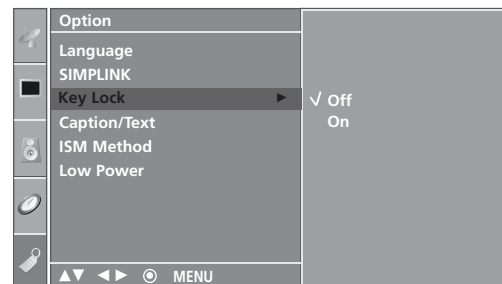

2 3

! NOTE

- ▶ In **Key lock 'On'**, if the set is turned off, press the **⏻ / I, INPUT, CH ▲ / ▼** button on the set or **POWER, INPUT, TV, CH - / +** or **NUMBER** buttons on the remote control.
- ▶ With the **Key lock On**, the display **'Key Lock On'** appears on the screen if any button on the front panel is pressed while viewing the set.

CLOSED CAPTIONS

Closed captioning is a process which converts the audio portion of a television program into written words which then appear as subtitles on the television screen. Closed captions allow viewers to read the dialogue and narration of television programs.

Using Closed Captions

Captions are the subtitles of the dialogue and narration of television programs. For prerecorded programs, program dialogue can be arranged into captions in advance. Its possible to caption a live program by using a process called real-time captioning, which creates captions instantly. Real-time captioning is normally done by professional reporters using a machine shorthand system and computer for translation into English.

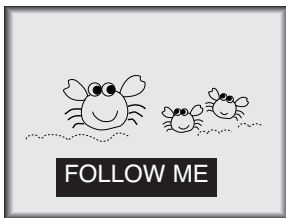

Captioning is an effective system for the hearing-impaired, and it can also aid in teaching language skills.

- The picture at left shows a typical caption.

Caption Tips

- Not all TV broadcasts include closed caption signals.
- Sometimes TV stations broadcast four different caption signals on the same channel. By selecting Mode1 to Mode2, you can choose which signal you view. Mode1 is usually the signal with the captions, while another mode might show demonstration or programming information.
- Your TV might not receive caption signals normally in the following situations.

1. Poor reception conditions are encountered:



• IGNITION:

Picture may flutter, drift, suffer from black spots, or horizontal streaking. Usually caused by interference from automobile ignition systems, neon lamps, electrical drills, and other electrical appliances.



• GHOSTS:

Ghosts are caused when the TV signal splits and follows two paths. One is the direct path and the other is reflected off tall buildings, hills or other objects. Changing the direction or position of the antenna may improve reception.



• SNOW:

If your receiver is located at the weak, fringe area of a TV signal, your picture may be marred by small dots. It may be necessary to install a special antenna to improve the picture.

2. An old, bad, or illegally recorded tape is being played.
3. Strong, random signals from a car or airplane interfere with the TV signal.
4. The signal from the antenna is weak.
5. The program wasn't captioned when it was produced, transmitted, or taped.

- 1 Use the **CAPTION** button repeatedly to select your caption Mode 1, Mode 2, Text1, Text2, or Off.

- 2 Press the **EXIT** button to return to TV viewing.

■ You can also adjust **Caption/Text** in the **Option** menu.

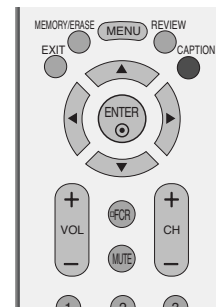

OPTION CONTROL

ISM (IMAGE STICKING MINIMIZATION) METHOD

A frozen of still picture from a PC/video game displayed on the screen for prolonged periods will result in a ghost image remaining even when you change the image. Avoid allowing a fixed image to remain on the set's screen for a long period of time.

It's not available to use this function in LCD models.

White Wash

White wash removes permanent images from the screen.

Note: An excessive permanent image may be impossible to clear entirely with White Wash.

Orbiter

Orbiter may help prevent ghost images. However, it is best not to allow any fixed image to remain on the screen. To avoid a permanent image on the screen, the screen will move every 2 minutes.

Inversion

This is the function to invert the panel colour of the screen. The panel colour is automatically inverted every 30 minutes.

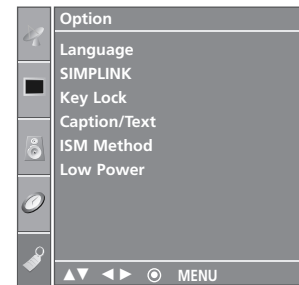
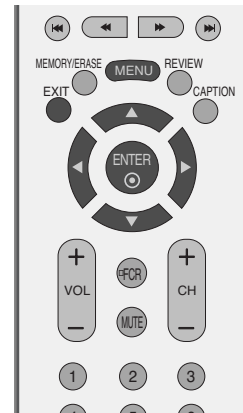

1

1 Press the **MENU** button and then use **▲** or **▼** button to select the **Option** menu.

2 Press the **▶** button and then use **▲** or **▼** button to select **ISM Method**.

3 Press the **▶** button and then use **▲** or **▼** button to select **Normal**, **White Wash**, **Orbiter** or **Inversion**.

4 Press the **EXIT** button to return to TV viewing or press the **MENU** button to return to the previous menu.

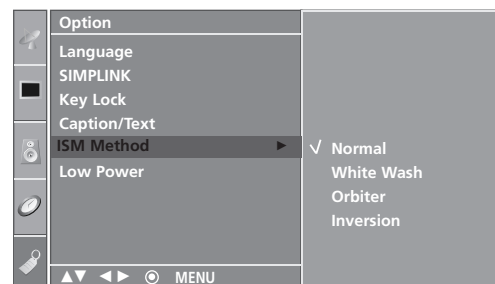

2 3

LOW POWER

This is the function to reduce the power consumption of the set.

It's not available to use this function in LCD models.



1 Press the **MENU** button and then use ▲ or ▼ button to select the **Option** menu.

2 Press the ► button and then use ▲ or ▼ button to select **Low power**.

3 Press the ► button and then use ▲ or ▼ button to select **On** or **Off**.

4 Press the **EXIT** button to return to TV viewing or press the **MENU** button to return to the previous menu.

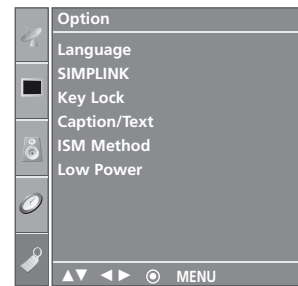

1

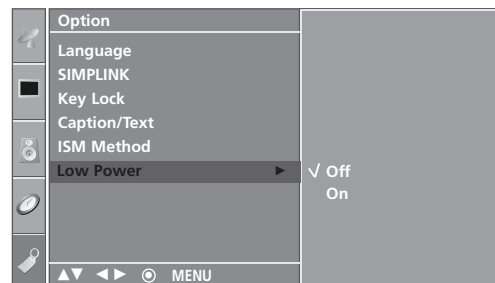

2 3

APPENDIX

TROUBLESHOOTING CHECKLIST

The operation does not work normally.

<p>The remote control doesn't work</p>	<ul style="list-style-type: none"> ■ Check to see if there is any object between the product and the remote control causing obstruction. Ensure you are pointing the remote control directly at the TV. ■ Ensure that the batteries are installed with correct polarity (+ to +, - to -). ■ Ensure that the correct remote operating mode is set: TV, VCR etc. ■ Install new batteries.
<p>Power is suddenly turned off</p>	<ul style="list-style-type: none"> ■ Is the sleep timer set? ■ Check the power control settings. Power interrupted. ■ No broadcast on station tuned with Auto off activated.

The video function does not work.

<p>No picture & No sound</p>	<ul style="list-style-type: none"> ■ Check whether the product is turned on. ■ Try another channel. The problem may be with the broadcast. ■ Is the power cord inserted into wall power outlet? ■ Check your antenna direction and/or location. ■ Test the wall power outlet, plug another product's power cord into the outlet where the product's power cord was plugged in.
<p>Picture appears slowly after switching on</p>	<ul style="list-style-type: none"> ■ This is normal, the image is muted during the product startup process. Please contact your service center, if the picture has not appeared after five minutes.
<p>No or poor color or poor picture</p>	<ul style="list-style-type: none"> ■ Adjust Color in menu option. ■ Keep a sufficient distance between the product and the VCR. ■ Try another channel. The problem may be with the broadcast. ■ Are the video cables installed properly? ■ Activate any function to restore the brightness of the picture.
<p>Horizontal/vertical bars or picture shaking</p>	<ul style="list-style-type: none"> ■ Check for local interference such as an electrical appliance or power tool.
<p>Poor reception on some channels</p>	<ul style="list-style-type: none"> ■ Station or cable product experiencing problems, tune to another station. ■ Station signal is weak, reorient antenna to receive weaker station. ■ Check for sources of possible interference.
<p>Lines or streaks in pictures</p>	<ul style="list-style-type: none"> ■ Check antenna (Change the direction of the antenna).

The audio function does not work.

<p>Picture OK & No sound</p>	<ul style="list-style-type: none"> ■ Press the VOL or VOLUME button. ■ Sound muted? Press MUTE button. ■ Try another channel. The problem may be with the broadcast. ■ Are the audio cables installed properly?
<p>No output from one of the speakers</p>	<ul style="list-style-type: none"> ■ Adjust Balance in menu option.
<p>Unusual sound from inside the product</p>	<ul style="list-style-type: none"> ■ A change in ambient humidity or temperature may result in an unusual noise when the product is turned on or off and does not indicate a fault with the product.

There is a problem in PC mode. (Only PC mode applied)

<p>The signal is out of range.</p>	<ul style="list-style-type: none"> ■ Adjust resolution, horizontal frequency, or vertical frequency. ■ Check the input source.
<p>Vertical bar or stripe on background & Horizontal Noise & Incorrect position</p>	<ul style="list-style-type: none"> ■ Work the Auto configure or adjust clock, phase, or H/V position. (Option)
<p>Screen color is unstable or single color</p>	<ul style="list-style-type: none"> ■ Check the signal cable. ■ Reinstall the PC video card.

APPENDIX

MAINTENANCE

Early malfunctions can be prevented. Careful and regular cleaning can extend the amount of time you will have your new TV. Be sure to turn the power off and unplug the power cord before you begin any cleaning.

Cleaning the Screen

- 1 Here's a great way to keep the dust off your screen for a while. Wet a soft cloth in a mixture of lukewarm water and a little fabric softener or dish washing detergent. Wring the cloth until it's almost dry, and then use it to wipe the screen.
- 2 Make sure the excess water is off the screen, and then let it air-dry before you turn on your TV.

Cleaning the Cabinet

- To remove dirt or dust, wipe the cabinet with a soft, dry, lint-free cloth.
- Please be sure not to use a wet cloth.

Extended Absence

⚠ CAUTION

- ▶ If you expect to leave your TV dormant for a long time (such as a vacation), it's a good idea to unplug the power cord to protect against possible damage from lightning or power surges.

PRODUCT SPECIFICATIONS

26LC4R* 26LC4R-MD 26LC4RA-MD	Dimensions (Width x Height x Depth)	with stand	676.4 x 529.2 x 221.0 mm 26.7 x 20.9 x 8.7 inches
		without stand	676.4 x 474.5 x 85.0 mm 26.7 x 18.7 x 3.4 inches
	Weight	with stand	22.2 pounds / 10.04 kg
		without stand	19.9 pounds / 9.02 kg
26LC7R 26LC7R-MD	Dimensions (Width x Height x Depth)	with stand	676.6 x 531.0 x 221.0 mm 26.6 x 20.9 x 8.7 inches
		without stand	676.6 x 478.7 x 84.0 mm 26.6 x 18.9 x 3.3 inches
	Weight	with stand	21.2 pounds / 9.62 kg
		without stand	19.0 pounds / 8.62 kg
32LC4R 32LC4R-MD	Dimensions (Width x Height x Depth)	with stand	801.0 x 607.5 x 254.0 mm 31.6 x 24.0 x 10.0 inches
		without stand	801.01 x 548.6 x 79.0 mm 31.6 x 21.6 x 3.2 inches
	Weight	with stand	28.9 pounds / 13.1 kg
		without stand	23.6 pounds / 10.7 kg
37LC4R 37LC4R-MD	Dimensions (Width x Height x Depth)	with stand	926.6 x 697.6 x 280.4 mm 36.5 x 27.5 x 11.1 inches
		without stand	926.6 x 635.6 x 88.0 mm 36.5 x 25.1 x 3.5 inches
	Weight	with stand	44.1 pounds / 20.0 kg
		without stand	36.0 pounds / 16.3 kg
42LC4R 42LC4R-MD	Dimensions (Width x Height x Depth)	with stand	1032.7 x 750.0 x 289.0 mm 40.7 x 29.6 x 11.4 inches
		without stand	1032.7 x 685.5 x 88.5 mm 40.7 x 27.0 x 3.5 inches
	Weight	with stand	54.1 pounds / 24.5 kg
		without stand	44.1 pounds / 20.0 kg
Power requirement Television System Program Coverage External Antenna Impedance			AC100-240V -50/60Hz NTSC, PAL-M/N VHF 2 ~ 13, UHF 14 ~ 69, CATV 1 ~ 125 75 ohm
Environment condition	Operating Temperature Operating Humidity		32 ~ 104°F (0 ~ 40°C) Less than 80%
	Storage Temperature Storage Humidity		-4 ~ 140°F (-20 ~ 60°C) Less than 85%

■ The specifications shown above may be changed without prior notice for quality improvement.

APPENDIX

PRODUCT SPECIFICATIONS

42PC5R* 42PC5R-MA 42PC5RV-MD 42PC5RVH-MD	Dimensions (Width x Height x Depth)	with stand	1048.0 x 766.0 x 310.0 mm 41.3 x 30.2 x 12.3 inches
		without stand	1048.0 x 713.0 x 83.5 mm 41.3 x 28.1 x 3.3 inches
	Weight	with stand	61.8 pounds / 28.0 kg
		without stand	54.3 pounds / 24.6 kg
50PC5R 50PC5R-MA	Dimensions (Width x Height x Depth)	with stand	1242.0 x 887.6 x 370.0 mm 48.9 x 35.0 x 14.6 inches
		without stand	1242.0 x 827.2 x 88.0 mm 48.9 x 32.6 x 3.5 inches
	Weight	with stand	95.5 pounds / 43.3 kg
		without stand	76.3 pounds / 34.6 kg
42PC7R* 42PC7RA-MA 42PC7RAH-MA	Dimensions (Width x Height x Depth)	with stand	1216.0 x 701.0 x 286.5 mm 47.9 x 27.6 x 11.3 inches
		without stand	1216.0 x 649.0 x 85.0 mm 47.9 x 25.6 x 3.3 inches
	Weight	with stand	67.2 pounds / 30.5 kg
		without stand	60.8 pounds / 27.6 kg
Power requirement Television System Program Coverage External Antenna Impedance			AC100-240V -50/60Hz NTSC, PAL-M/N VHF 2 ~ 13, UHF 14 ~ 69, CATV 1 ~ 125 75 ohm
Environment condition	Operating Temperature Operating Humidity		32 ~ 104°F (0 ~ 40°C) Less than 80%
	Storage Temperature Storage Humidity		-4 ~ 140°F (-20 ~ 60°C) Less than 85%

■ The specifications shown above may be changed without prior notice for quality improvement.

PROGRAMMING THE REMOTE CONTROL

The provided universal remote control can be programmed to operate most remote-controllable devices. Note that the remote may not control all models of other brands.

Programming a code into a remote mode

- 1 To find out whether your remote control can operate each device without programming, turn on the device (such as a VCR) and press the corresponding mode button on the remote.
After that, press the **POWER** button. If the device is turned off and it responds properly the remote control need not be programmed. If not, the remote should be programmed to operate the device. The programming procedures are explained below.
- 2 Press the **MENU** and **MUTE** button continuously at the same time for two seconds; the currently selected device button is illuminated.
If you don't press any button for 20 seconds, the light on the mode button will be turned off. In that case, you have to repeat from step 2.
- 3 Enter the appropriate code from the code table on the following pages. When pressing the button, the light blinks at a time. If the device turned off, the programming is successful.
- 4 Press the **MENU** button to store the code. After blinking twice, this code is stored.
- 5 Test the remote control functions to see if the device responds properly. If not, steps 2-5.

PROGRAMMING CODES

DVD

Brand	Codes	Brand	Codes	Brand	Codes
APEX DIGITAL	022	mitsubishi	002	RCA	005 006
DENON	020 014	NAD	023	SAMSUNG	011 015
GE	005 006	ONKYO	008 017	SONY	007
HARMAN KARDON	027	PANASONIC	003 009	THOMPSON	005 006
JVC	012	PHILIPS	013	TOSHIBA	019 008
LG	001 010 016 025	PIONEER	004 026	YAMAHA	009 018
MAGNAVOX	013	PROCEED	021	ZENITH	010 016 025
MARANTZ	024	PROSCAN	005 006		

APPENDIX

PROGRAMMING CODES

VCRs

Brand	Codes	Brand	Codes	Brand	Codes
AIWA	034	MAGNAVOX	031 033 034 041	SAMSUNG	032 040 102 104
AKAI	016 043 046 124 125 146	MARANTZ	067 068 012 031 033 067 069		105 107 109 112 113 115 120 122 125
AMPRO	072	MARTA	101	SANSUI	022 043 048 135
ANAM	031 033 103	MATSUI	027 030	SANYO	003 007 010 014 102 134
AUDIO DYNAMICS	012 023 039 043	MEI	031 033	SCOTT	017 037 112 129 131
BROKSONIC	035 037 129	MEMOREX	003 010 014 031 033 034 053 072 101 102 134 139	SEARS	003 008 009 010 013 014 017 020 031 042 073 081 101
CANON	028 031 033	MGA	045 046 059	SHARP	031 054 149
CAPEHART	108	MINOLTA	013 020	SHINTOM	024
CRAIG	003 040 135	MITSUBISHI	013 020 045 046 049 051 059 061 151	SONY	003 009 031 052 056 057 058 076 077 078 149
CURTIS MATHES	031 033 041	MTC	034 040	SOUNDESIGN	034
DAEWOO	005 007 010 064 065 108 110 111 112 116 117 119	MULTITECH	024 034	STS	013
DAYTRON	108	NEC	012 023 039 043 048	SYLVANIA	031 033 034 059 067
DBX	012 023 039 043	NORDMENDE	043	SYMPHONIC	034
DYNATECH	034 053	OPTONICA	053 054	TANDY	010 034
ELECTROHOME	059	PANASONIC	066 070 074 083 133 140 145	TATUNG	039 043
EMERSON	006 017 025 027 029 031 034 035 036 037 046 101 129 131 138 153	PENTAX	013 020 031 033 063	TEAC	034 039 043
FISHER	003 008 009 010	PHILCO	031 034 067	TECHNICS	031 033 070
FUNAI	034	PHILIPS	031 033 034 054 067 071 101	TEKNIKA	019 031 033 034 101
GE	031 033 063 072 107 109 144 147	PILOT	101	THOMAS	034
GO VIDEO	132 136	PIONEER	013 021 048	TMK	006
HARMAN KARDON	012 045	PORTLAND	108	TOSHIBA	008 013 042 047 059 082 112 131
HITACHI	004 018 026 034 043 063 137 150	PULSAR	072	TOTEVISION	040 101
INSTANTREPLAY	031 033	QUARTZ	011 014	UNITECH	040
JCL	031 033	QUASAR	033 066 075 145	VECTOR RESEARCH	012
JCPENNY	012 013 015 033 040 066 101	RCA	013 020 033 034 040 041 062 063 107 109 140 144 145 147	VICTOR	048
JENSEN	043	REALISTIC	003 008 010 014 031 033 034 040 053 054 101	VIDEO CONCEPTS	012 034 046
JVC	012 031 033 043 048 050 055 060 130 150 152	RICO	058	VIDEOSONIC	040
KENWOOD	014 034 039 043 047 048	RUNCO	148	WARDS	003 013 017 024 031 033 034 040 053 054 131
LG (GOLDSTAR)	001 012 013 020 101 106 114 123	SALORA	014	YAMAHA	012 034 039 043
LLOYD	034			ZENITH	034 048 056 058 072 080 101
LXI	003 009 013 014 017 034 101 106				
MAGIN	040				