



## LCD TV | PLASMA TV OWNER'S MANUAL

### LCD TV MODELS

26LG30R  
32LG30R  
37LG30R  
42LG30R  
47LG30R  
42LG50FR

### PLASMA TV MODELS

42PG20R  
50PG20R

Please read this manual carefully before operating your set.  
Retain it for future reference.  
Record model number and serial number of the set.  
See the label attached on the back cover and quote this information to your dealer when you require service.

P/NO : MFL41469207 (0805-REV06)

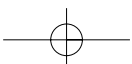
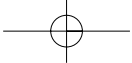

# WARNING / CAUTION



**WARNING / CAUTION**  
RISK OF ELECTRIC SHOCK  
DO NOT OPEN



TO REDUCE THE RISK OF ELECTRIC SHOCK DO NOT REMOVE COVER (OR BACK). NO USER SERVICEABLE PARTS INSIDE. REFER TO QUALIFIED SERVICE PERSONNEL.



The lightning flash with arrowhead symbol, within an equilateral triangle, is intended to alert the user to the presence of uninsulated “dangerous voltage” within the product’s enclosure that may be of sufficient magnitude to constitute a risk of electric shock to persons.



The exclamation point within an equilateral triangle is intended to alert the user to the presence of important operating and maintenance (servicing) instructions in the literature accompanying the appliance.

## WARNING/CAUTION

TO REDUCE THE RISK OF FIRE AND ELECTRIC SHOCK, DO NOT EXPOSE THIS PRODUCT TO RAIN OR MOISTURE.

# SAFETY INSTRUCTIONS

## IMPORTANT SAFETY INSTRUCTIONS

Important safety instructions shall be provided with each apparatus. This information shall be given in a separate booklet or sheet, or be located before any operating instructions in an instruction for installation for use and supplied with the apparatus.

This information shall be given in a language acceptable to the country where the apparatus is intended to be used. The important safety instructions shall be entitled "Important Safety Instructions". The following safety instructions shall be included where applicable, and, when used, shall be verbatim as follows. Additional safety information may be included by adding statements after the end of the following safety instruction list. At the manufacturer's option, a picture or drawing that illustrates the intent of a specific safety instruction may be placed immediately adjacent to that safety instruction:

**Read these instructions.**

**Keep these instructions.**

**Heed all warnings.**

**Follow all instructions.**



- 1** Do not use this apparatus near water.



- 2** Clean only with dry cloth.



- 3** Do not block any ventilation openings. Install in accordance with the manufacturer's instructions.



- 4** Do not install near any heat sources such as radiators, heat registers, stoves, or other apparatus (including amplifiers) that produce heat.



- 5** When mounting a TV it on the wall, make sure not to install TV by the hanging power and signal cables on the back of the TV.

- 6** Do not defeat the safety purpose of the polarized or grounding-type plug. A polarized plug has two blades with one wider than the other. A grounding type plug has two blades and a third grounding prong. The wide blade or the third prong are provided for your safety. If the provided plug does not fit into your outlet, consult an electrician for replacement of the obsolete outlet.



- 7** Protect the power cord from being walked on or pinched particularly at plugs, convenience receptacles, and the point where they exit from the apparatus.



- 8** Only use attachments/accessories specified by the manufacturer.



- 9** Unplug this apparatus during lightning storms or when unused for long periods of time.

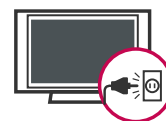

- 10** Use only with the cart, stand, tripod, bracket, or table specified by the manufacturer, or sold with the apparatus. When a cart is used, use caution when moving the cart/apparatus combination to avoid injury from tip-over.



- 11** Never touch this apparatus or antenna during a thunder or lightning storm.
- 12** Do not allow a impact shock or any objects to fall into the product, and do not drop onto the screen with something.
- 13** Refer all servicing to qualified service personnel. Servicing is required when the apparatus has been damaged in any way, such as power-supply cord or plug is damaged, liquid has been spilled or objects have fallen into the apparatus, the apparatus has exposed to rain or moisture, does not operate normally, or has been dropped.

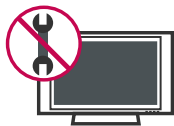

- 14** **CAUTION** concerning the Power Cord : Most appliances recommend they be placed upon a dedicated circuit; that is, a single outlet circuit which powers only that appliance and has no additional outlets or branch circuits. Check the specification page of this owner's manual to be certain.
- Do not overload wall outlets. Overloaded wall outlets, loose or damaged wall outlets, extension cords, frayed power cords, or damaged or cracked wire insulation are dangerous. Any of these conditions could result in electric shock or fire. Periodically examine the cord of your appliance, and if its appearance indicates damage or deterioration, unplug it, discontinue use of the appliance, and have the cord replaced with an exact replacement part by an authorized servicer. Protect the power cord from physical or mechanical abuse, such as being twisted,

kinked, pinched, closed in a door, or walked upon. Pay particular attention to plugs, wall outlets, and the point where the cord exits the appliance.



- 15** **Outdoor use marking :**  
**WARNING** - To reduce the risk of fire or electric shock, do not expose this appliance to rain or moisture.



- 16** **Wet Location Marking :** Apparatus shall not be exposed to dripping or splashing and no objects filled with liquids, such as vases, shall be placed on or over apparatus.



## **17** GROUNDING

Ensure that you connect the earth ground wire to prevent possible electric shock. If grounding methods are not possible, have a qualified electrician install a separate circuit breaker.

Do not try to ground the unit by connecting it to telephone wires, lightening rods, or gas pipes.

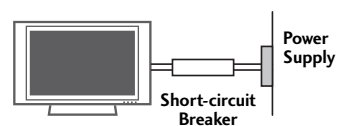

- 18** **DISCONNECTING DEVICE FROM MAINS**  
 Mains plug is the disconnecting device. The plug must remain readily operable.

- 19** Keep the product away from direct sunlight.  
 - The product can be damaged.

# CONTENTS

<b>WARNING/CAUTION</b> .....	1
<b>SAFETY INSTRUCTIONS</b> .....	2

## PREPARATION

Accessories .....	7
Front Panel Information .....	8
Back Panel Information .....	10
Stand Installation .....	13
Cable Management .....	15
Securing the TV to the wall fall over. ....	17
Protection Cover .....	18
Swivel Stand .....	18
Desktop Pedestal Installation .....	19
Wall Mount: Horizontal Installation .....	19
Attaching The TV To a Desk .....	19
Antenna Connection .....	20

## EXTERNAL EQUIPMENT SETUP

HD Receiver Setup .....	21
DVD Setup .....	24
VCR Setup .....	27
Other A/V Source Setup .....	30
PC Setup .....	31
External Stereo Setup .....	37
AV Out Setup .....	37

## WATCHING TV / CHANNEL CONTROL

Remote Control Key Functions .....	38
Turning On TV .....	40
Channel Selection .....	40
Volume Adjustment .....	40
Quick Menu .....	41
On-Screen Menus Selection .....	42
Channel Search .....	43
- Auto Turning .....	43
- Manual Turning: Adding / Deleting Channels ...	44

Fine Tuning Adjustment .....	45
Booster .....	46
Favorite Channels Setup .....	47
Key Lock .....	48
AV Mode .....	49
Simplink .....	50

## PICTURE CONTROL

Watching PIP (Picture-In-Picture) .....	52
Picture Size (Aspect Ratio) Control .....	53
Preset Picture Settings .....	54
- Picture Mode- Preset .....	54
- Auto Color Tone Control(Cool/Medium/Warm) ..	55
Manual Picture Adjustment .....	56
- Picture Mode- User Mode .....	56
- Color Tone - User Mode .....	57
XD - Picture Improvement Technology .....	58
Advanced - Gamma .....	60
Advanced - Film Mode .....	61
Advanced - Black (Darkness) Level .....	62
Advanced - Eye Care .....	63
Picture Reset .....	64
Power Indicator .....	65
Image Sticking Minimization (ISM) Method .....	66
Power Saving Picture Mode .....	67
Factory Reset .....	68

## SOUND & LANGUAGE CONTROL

Auto Volume Leveler .....	69
Preset Sound Setting - Sound Mode .....	70
Sound Setting Adjustment - User Mode .....	71
Balance .....	72
TV Speakers On/Off Setup .....	73
Selecting Audio Out .....	74
On-Screen Menus Language Selection .....	74
Closed Caption .....	75

## TIME SETTING

Clock Setup .....	76
Auto On/Off Time Setting .....	77
Sleep Timer Setting .....	78
Auto Shut-off Setting .....	79

## APPENDIX

Troubleshooting .....	80
Maintenance .....	81
Product Specifications .....	82
Programming the Remote Control .....	84
IR Codes .....	86
External Control Through RS-232C .....	88

# PREPARATION

## PREPARATION

---

### **FOR LCD TV**

If the TV feels cold to the touch, there may be a small “flicker” when it is turned on. This is normal, there is nothing wrong with TV.

Some minute dot defects may be visible on the screen, appearing as tiny red, green, or blue spots. However, they have no adverse effect on the monitor’s performance.

Avoid touching the LCD screen or holding your finger(s) against it for long periods of time. Doing so may produce some temporary distortion effects on the screen.

### **On Disposal (Only, Hg.lamp used LCD TV)**

- a. The fluorescent lamp used in this product contains a small amount of mercury.
- b. Do not dispose of this product with general household waste.
- c. Disposal of this product must be carried out in accordance to the regulations of your local authority.



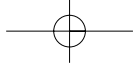

# ACCESSORIES

Ensure that the following accessories are included with your TV. If an accessory is missing, please contact the dealer where you purchased the TV.

The accessories included may differ from the images below.

PREPARATION

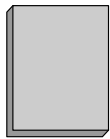

**Owner's Manual**

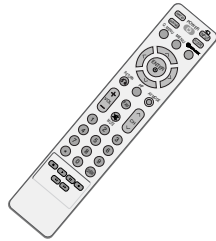

**Remote Control**



**Batteries  
(Some Models)**



**Power Cord**

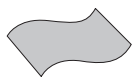

**Polishing Cloth**  
(This feature is not available for all models.)

- \* Only wipe spots on the exterior with the polishing cloth.
- \* Do not wipe roughly when removing stain. Please be cautious of that excessive pressure may cause scratch or discoloration.



**RF Adapter (Some Models)**

You must connect it to the antenna wire after fixing in Antenna Input. This adapter is only supplied in Argentina.

## For Plasma TV models



**Protection cover  
(Refer to p.18)**

(This accessories can be different from the figures shown here depending on your models.)

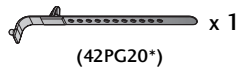

x 1  
(42PG20\*)



x 2  
(50PG20\*)

**Cable Holder**

(Only 42PG20\*)



x 4

**Bolts for stand assembly  
(Refer to P.13)**

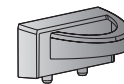

**Cable Management Clip**

## For LCD TV models

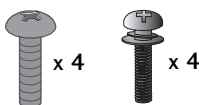

x 4 x 4

**Bolts for stand assembly  
(Refer to P.14)  
(Except 47LG30\*)**

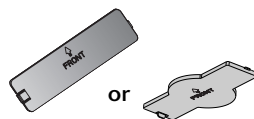

or

**Protection cover  
(Refer to p.18)**

(This accessories can be different from the figures shown here depending on your models.)

(Only 26/32/42LG30\*,  
42LG50\*\*)



**Screw for stand fixing  
(Refer to P.19)**

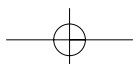

# PREPARATION

## FRONT PANEL INFORMATION

- Image shown may differ from your TV.
- NOTE:** If your TV has a protection tape attached, remove the tape. And then wipe the TV with a cloth (If a polishing cloth is included with your TV, use it).

### Plasma TV Models

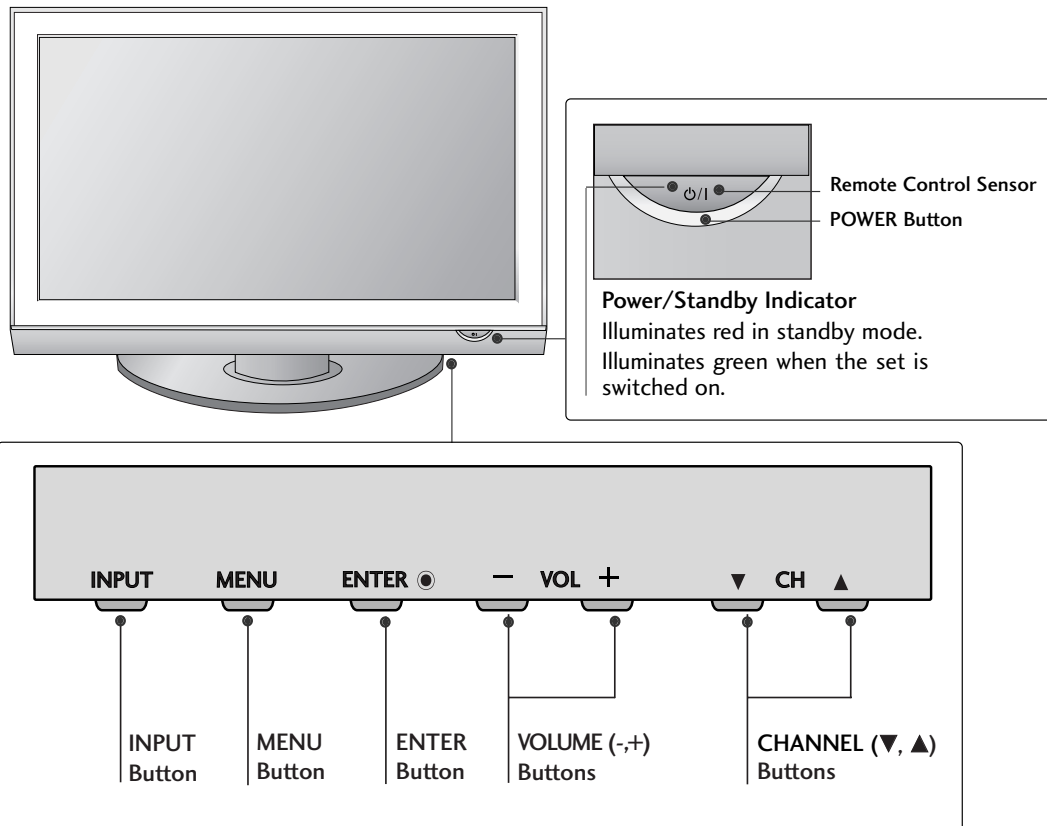

### LCD TV Models

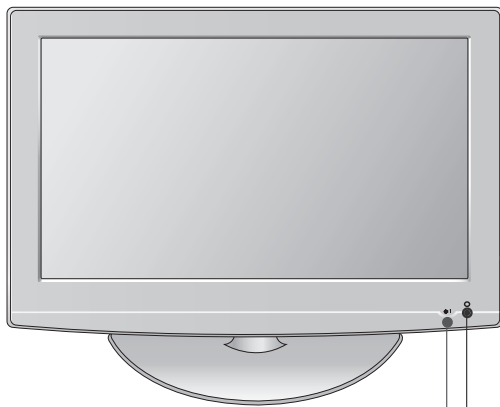

**Intelligent Sensor**  
 Adjusts picture according to the surrounding conditions (Only 42LG50\*\*)

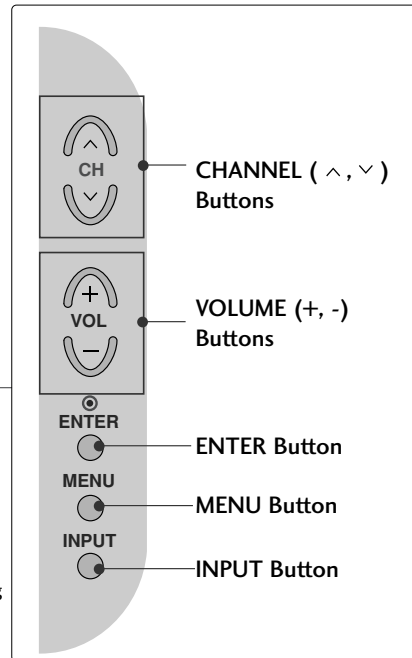

**CHANNEL ( ^, v ) Buttons**

**VOLUME (+, -) Buttons**

**ENTER Button**

**MENU Button**

**INPUT Button**

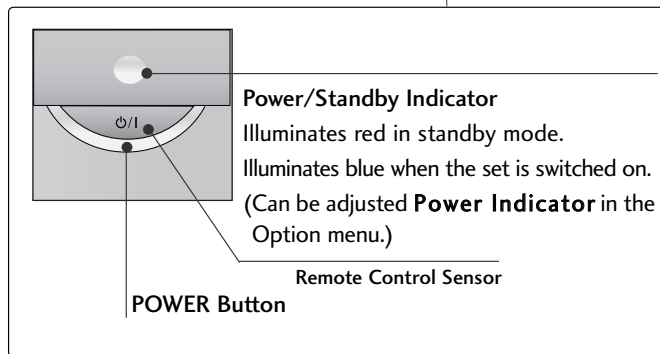

**Power/Standby Indicator**  
 Illuminates red in standby mode.  
 Illuminates blue when the set is switched on.  
 (Can be adjusted **Power Indicator** in the Option menu.)

**Remote Control Sensor**  
**POWER Button**

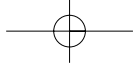

# PREPARATION

## BACK PANEL INFORMATION

■ Here shown may be somewhat different from your TV.

PREPARATION

### Plasma TV Models

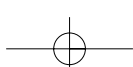
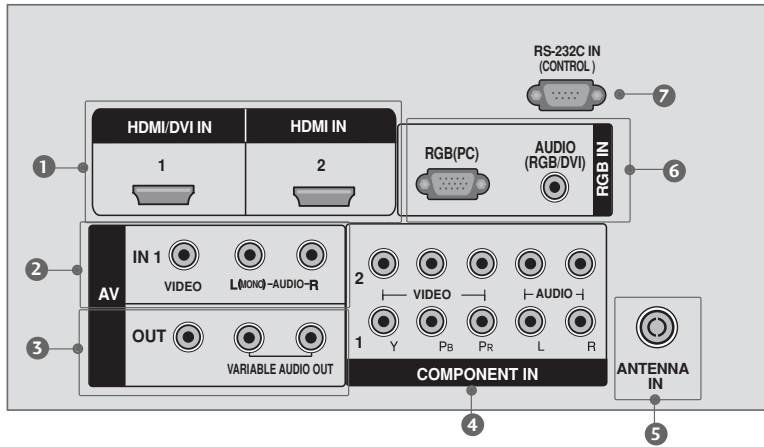
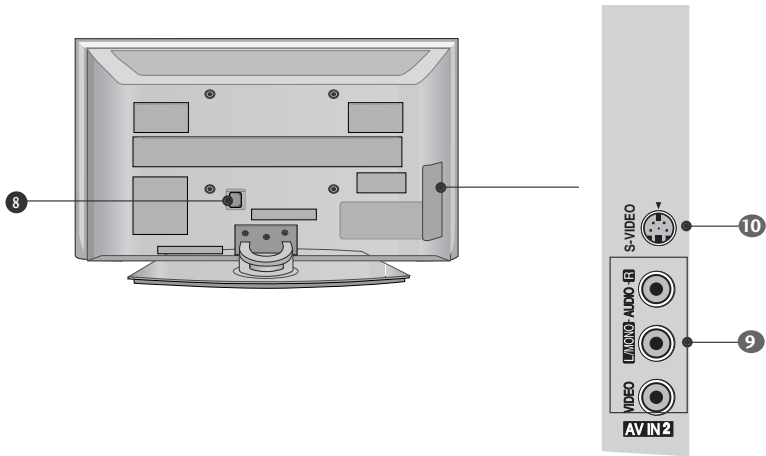

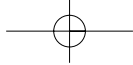

LCD TV Models

Only  
26/32/37/42/47LG30\*

Only 42LG50\*\*

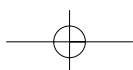
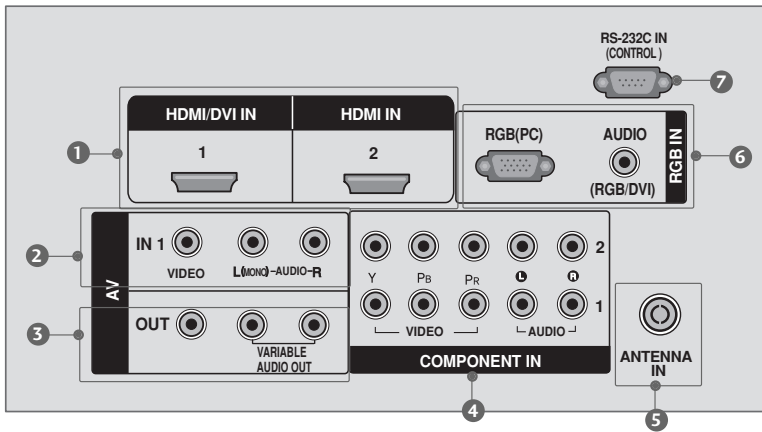
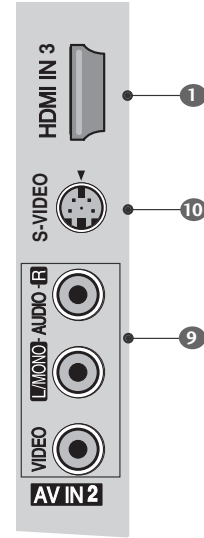
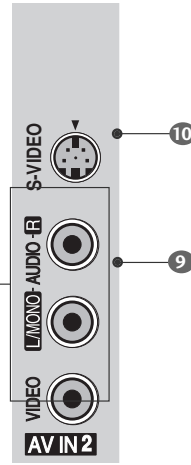
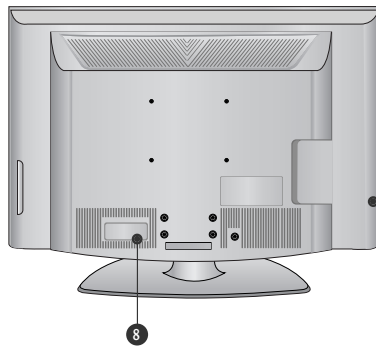

# PREPARATION

## PREPARATION

- 1 HDMI/DVI IN, HDMI IN**  
Connect a HDMI (DVI) connection to either input.
- 2 AV (Audio/Video) IN 1**  
Connect audio/video output from an external device to these jacks.
- 3 AV OUT**  
Connect a second TV or monitor.  
**VARIABLE AUDIO OUT**  
Connect an external amplifier or add a subwoofer to your surround sound system.
- 4 COMPONENT IN**  
Connect a component video/audio device to these jacks.
- 5 ANTENNA IN**  
Connect over-the air signals to this jack.
- 6 RGB IN**  
**RGB(PC)**  
Connect the output from a PC.  
**AUDIO(RGB/DVI)**  
Connect the audio from a PC or DTV.
- 7 RS-232C IN (CONTROL)(Except 42LG50\*\*)**  
For external control devices.
- 8 Power Cord Socket**  
For operation with AC power.  
Caution: Never attempt to operate the TV on DC power.
- 9 AV (Audio/Video) IN 2**  
Connect audio/video output from an external device to these jacks.
- 10 S-VIDEO**  
Connect S-Video out from an S-VIDEO device.

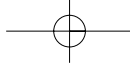

## STAND INSTALLATION

- Image shown may differ from your TV

### Plasma TV Model ( Only 42PG20\* )

- 1 Carefully place the TV screen side down on a cushioned surface to protect the screen from damage.

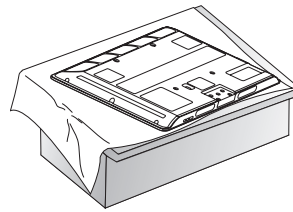

- 2 Assemble the TV as shown.

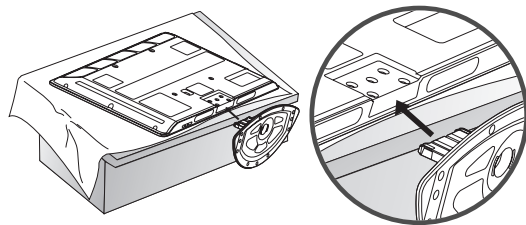

- 3 Fix the 4 bolts securely using the holes in the back of the TV.

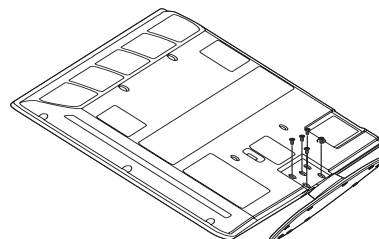

#### **!** NOTE

- ▶ When assembling the desk type stand, check whether the bolt is fully tightened. (If not tightened fully, the product can tilt forward after the product installation). If you tighten the bolt with excessive force, the bolt can deviate from abrasion of the tightening part of the bolt.

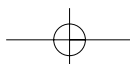

# PREPARATION

PREPARATION

## LCD TV Models (Except 47LG30\*)

- 1 Carefully place the TV screen side down on a cushioned surface to protect the screen from damage.

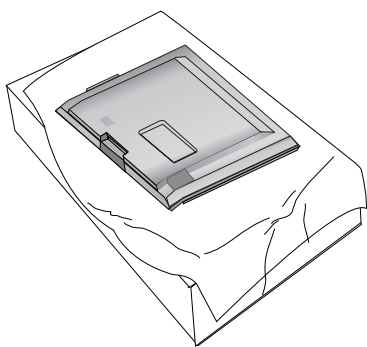

- 2 Assemble the parts of the **Stand Body** with the **Cover Base** of the TV.

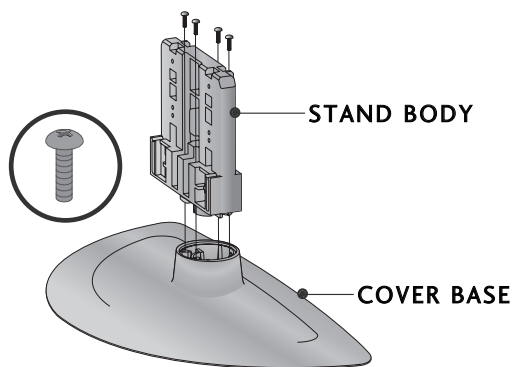

- 3 Assemble the TV as shown.

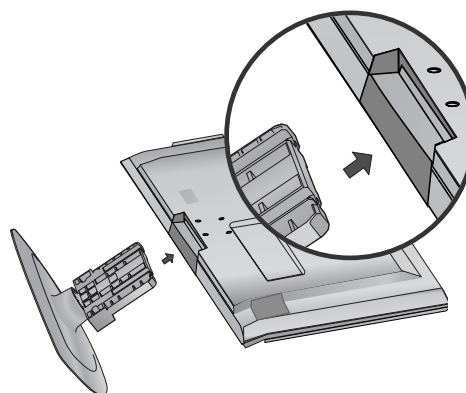

- 4 Fix the 4 bolts securely using the holes in the back of the TV.

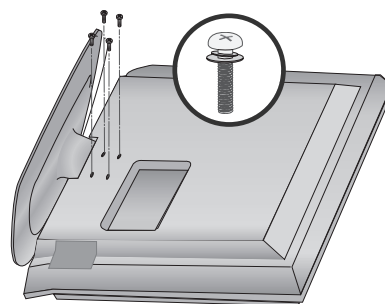

### ! NOTE

- ▶ When assembling the desk type stand, check whether the bolt is fully tightened. (If not tightened fully, the product can tilt forward after the product installation). If you tighten the bolt with excessive force, the bolt can deviate from abrasion of the tightening part of the bolt.



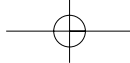

## CABLE MANAGEMENT

- Here shown may be somewhat different from your TV.

### Plasma TV Models

- 1 Connect the cables as necessary.  
To connect additional equipment, see the **EXTERNAL EQUIPMENT SETUP** section.

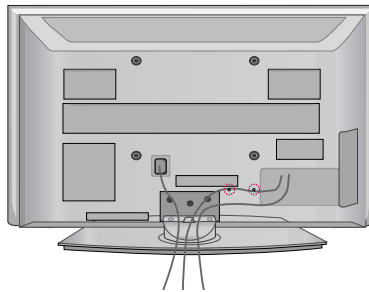

- 2 Install the **CABLE MANAGEMENT CLIP** as shown.  
If your TV has **CABLE HOLDER**, fix it as shown and bundle the cables.

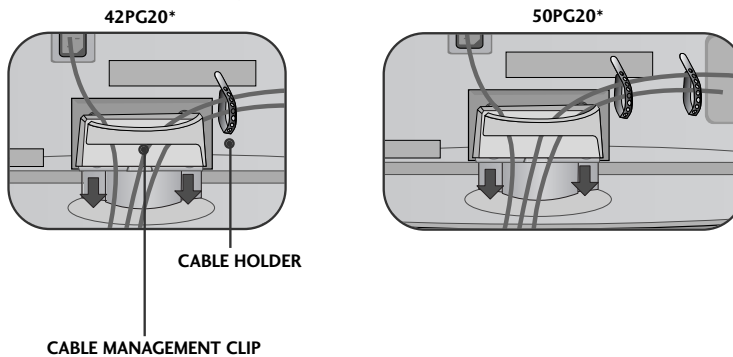

#### How to remove the CABLE MANAGEMENT CLIP

- ▶ Hold the **CABLE MANAGEMENT CLIP** with both hands and pull it upward.

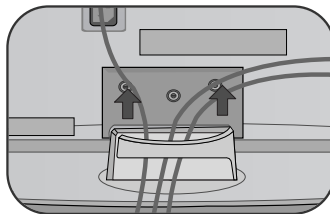

#### ! NOTE

- ▶ Do not hold the **CABLE MANAGEMENT CLIP** when moving the TV.  
- If the TV is dropped, you may be injured or the product may be broken.

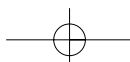

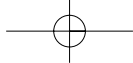

# PREPARATION

## LCD TV Model

- 1 Connect the cables as necessary.  
To connect additional equipment, see the **EXTERNAL EQUIPMENT SETUP** section.

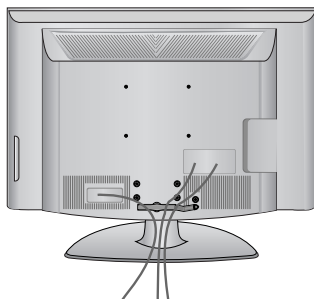

- 2 Install the **CABLE MANAGEMENT CLIP** as shown.

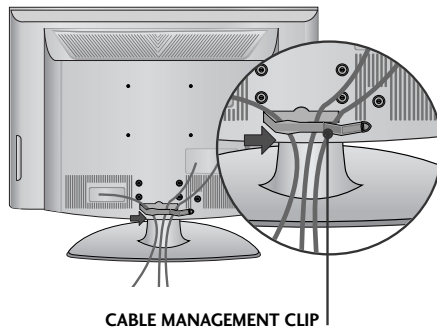

- 3 Put the cables inside the **CABLE MANAGEMENT CLIP** and snap it closed.

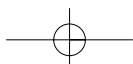
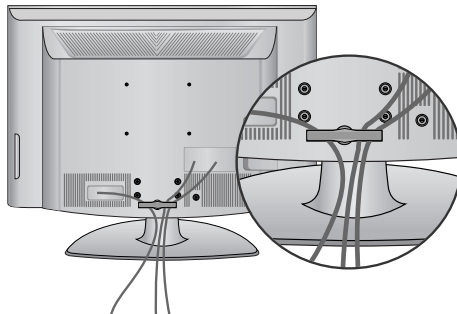

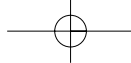

## SECURING THE TV TO THE WALL FALL OVER.

This feature is not available for all models.  
Here shown may be somewhat different from your TV.

- Position the TV close to the wall to avoid the possibility of it falling when pushed.
- The instructions shown below are a safer way to set up the TV, which is to fix it to the wall, avoiding the possibility of it falling forwards if pulled. This will prevent the TV from falling forward and causing injury. This will also prevent the TV from damage. Ensure that children do not climb or hang from the TV.
- You should purchase necessary components to prevent TV from falling off of the stand.

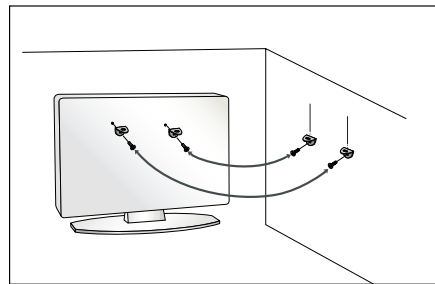
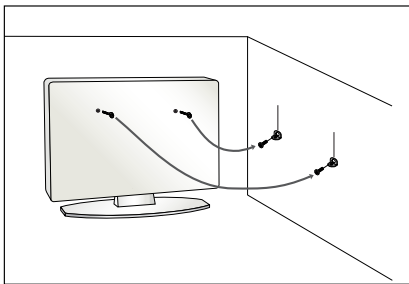

- Insert the eye-bolts (or TV brackets and bolts) to tighten the product to the wall as shown in the picture.  
\*If your product has the bolts in the eye-bolts position before inserting the eye-bolts, loosen the bolts.  
Secure the wall brackets with the bolts (not provided as parts of the product, must purchase separately) to the wall. Match the height of the bracket that is mounted on the wall to the holes in the product.  
Ensure the eye-bolts or brackets are tightened securely.

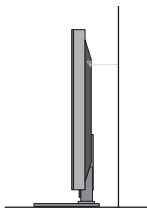

- Use a sturdy rope (not provided as parts of the product, must purchase separately) to tie the product. It is safer to tie the rope so it becomes horizontal between the wall and the product.

### ! NOTE

- ▶ When moving the TV undo the cords first.
- ▶ Use a platform or cabinet strong and large enough to support the size and weight of the TV.
- ▶ To use the TV safely make sure that the height of the bracket on the wall and on the TV is the same.

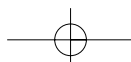

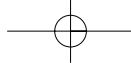

## PREPARATION

### PROTECTION COVER

- Image shown may differ from your TV.

After removing the stand, install the included **protection cover** over the hole for the stand. Press the **PROTECTION COVER** into the TV until you hear it click.

#### Plasma TV Models

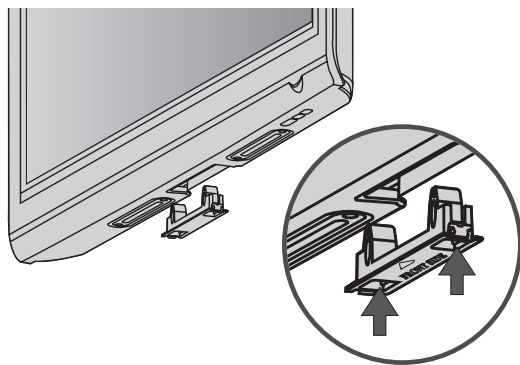

Detach the protection cover after pressing the left/right buttons.

#### ! NOTE

- ▶ Not to occur the vibration or noise, fix the protection cover using bolts (provided as parts of the product).

#### LCD TV Model

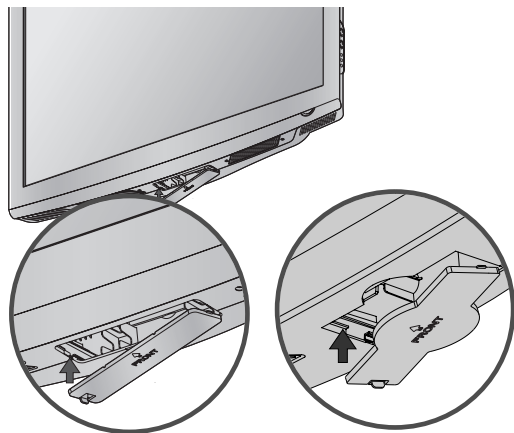

### SWIVEL STAND

After installing the TV, you can adjust the TV set manually to the left or right direction by 20 degrees to suit your viewing position.

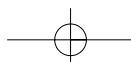
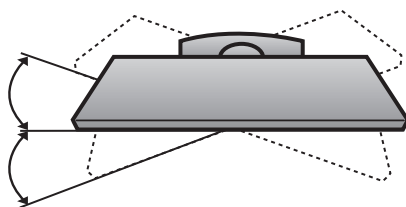

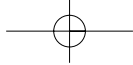

- This part mainly use picture for Plasma TV model.

## DESKTOP PEDESTAL INSTALLATION

For adequate ventilation allow a clearance of 4" (10cm) all around the TV.

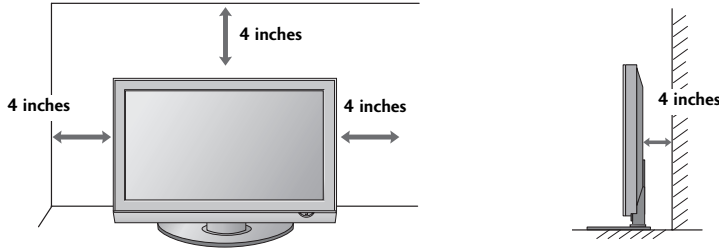

PREPARATION

- CAUTION**
- ▶ Ensure adequate ventilation by following the clearance recommendations.
  - ▶ Do not mount near or above any type of heat source.

## WALL MOUNT: HORIZONTAL INSTALLATION

For adequate ventilation allow a clearance of 4" (10cm) all around the TV. We recommend that you use an LG brand wall mount when mounting the TV to a wall.

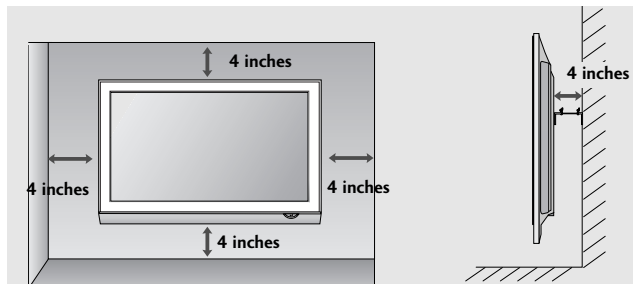
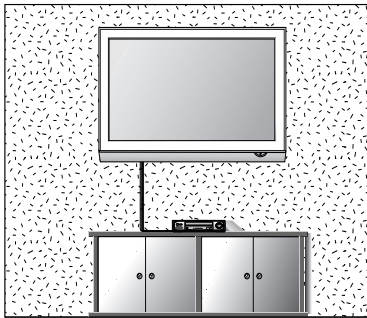

## ATTACHING THE TV TO A DESK (Only 26/32/42LG30\*, 42LG50\*\*)

If you wish to attach the TV to a desk, it must be securely fastened to the desk using a metal screw (as shown below). Failure to securely attach the TV may result in the TV falling: which may cause damage to the TV and serious personal injury.

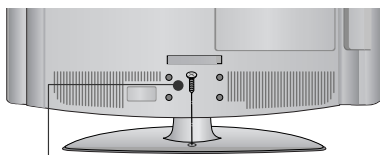

1-Screw  
(provided as parts of the product)

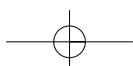
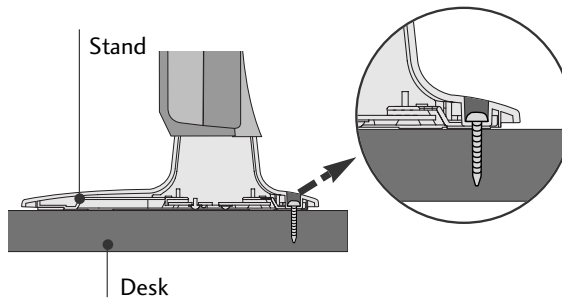

## PREPARATION

- To prevent damage do not connect to the mains outlet until all connections are made between the devices.

## ANTENNA CONNECTION

- For optimum picture quality, adjust antenna direction.
- An antenna cable and converter are not supplied.

PREPARATION

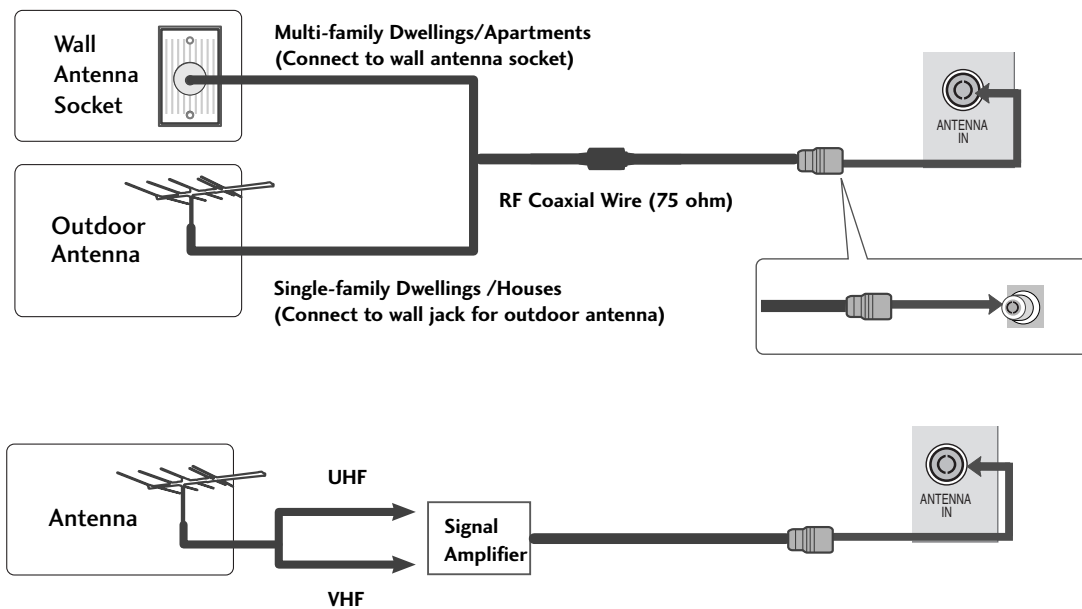

- In poor signal areas, to achieve better picture quality it may be necessary to install a signal amplifier to the antenna as shown above.
- If signal needs to be split for two TVs, use an antenna signal splitter for connection.

# EXTERNAL EQUIPMENT SETUP

- To avoid damaging any equipment, never plug in any power cords until you have finished connecting all equipment.
- This section on EXTERNAL EQUIPMENT SETUP mainly uses diagrams for the Plasma TV models.
- Image shown may differ from your TV.

## HD RECEIVER SETUP

### When connecting with a component cable

- 1 Connect the video outputs (Y, Pb, Pr) of the digital set top box to the **COMPONENT IN VIDEO** jacks on the TV.
- 2 Connect the audio output of the digital set-top box to the **COMPONENT IN AUDIO** jacks on the TV.
- 3 Turn on the digital set-top box.  
(Refer to the owner's manual for the digital set-top box.)
- 4 Select **Component1** input source using the **INPUT** button on the remote control.  
If connected to **COMPONENT IN2**, select **Component2** input source.

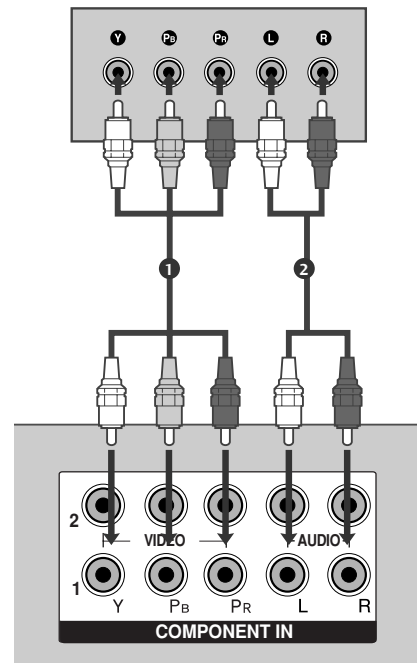

EXTERNAL EQUIPMENT SETUP

Signal	Component
480i/576i	Yes
480p/576p	Yes
720p/1080i	Yes
1080p	Yes
	(Only 50Hz, 60Hz)

# EXTERNAL EQUIPMENT SETUP

EXTERNAL EQUIPMENT SETUP

## When connecting with a HDMI cable

- 1 Connect the HDMI output of the digital set-top box to the **HDMI/DVI IN 1**, **HDMI IN 2** or **HDMI IN 3** (Only 42LG50\*\*) jack on the TV.
- 2 Select **HDMI1/DVI**, **HDMI2** or **HDMI3** (Only 42LG50\*\*) input source using the **INPUT** button on the remote control.
- 3 Turn on the digital set-top box.  
(Refer to the owner's manual for the digital set-top box.)

### NOTE

▶ TV can receive the video and audio signal simultaneously with using a HDMI cable.

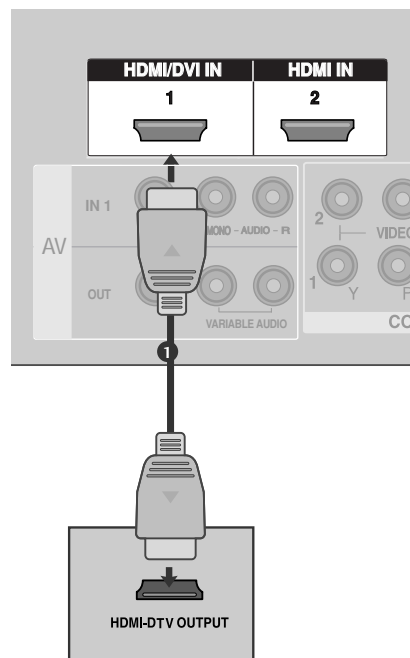

### HDMI-DTV mode

#### Plasma TV Models

Resolution	Horizontal Frequency(kHz)	Vertical Frequency(Hz)
720x480	31.47	59.94
	31.50	60.00
720x576	31.25	50.00
		50.00
1280x720	44.96	59.94
	45.00	60.00
	37.50	50.00
1920x1080i	33.72	59.94
	33.75	60.00
	28.125	50.00
1920x1080p	67.432	59.94
	67.50	60.00
	56.25	50.00
	27.0	24.00
	33.75	30.00

#### LCD TV Models

Resolution	Horizontal Frequency(kHz)	Vertical Frequency(Hz)
720x480	31.47	59.94
	31.50	60.00
720x576	31.25	50.00
1280x720	44.96	59.94
	45.00	60.00
	37.50	50.00
1920x1080i	33.72	59.94
	33.75	60.00
	28.125	50.00
1920x1080p	67.432	59.94
	67.50	60.00
	56.25	50.00
	27.00	24.00
	33.75	30.00



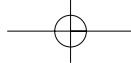

## When connecting with a HDMI to DVI cable

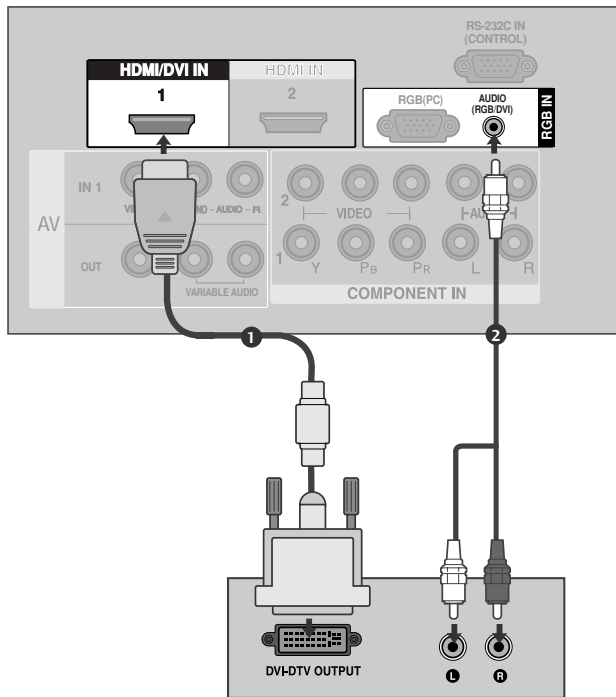

- 1 Connect the DVI output of the digital set-top box to the **HDMI/DVI IN 1** jack on the TV.
- 2 Connect the audio output of the digital set-top box to the **AUDIO (RGB/DVI)** jack on the TV.
- 3 Turn on the digital set-top box. (Refer to the owner's manual for the digital set-top box.)
- 4 Select **HDMI1/DVI** input source using the **INPUT** button on the remote control.

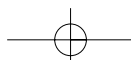

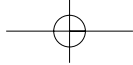

# EXTERNAL EQUIPMENT SETUP

## DVD SETUP

### When connecting with a component cable

EXTERNAL EQUIPMENT SETUP

- 1 Connect the video outputs (Y, Pb, Pr) of the DVD to the **COMPONENT IN VIDEO** jacks on the TV.
- 2 Connect the audio outputs of the DVD to the **COMPONENT IN AUDIO** jacks on the TV.
- 3 Turn on the DVD player, insert a DVD.
- 4 Select **Component1** input source using the **INPUT** button on the remote control.  
If connected to **COMPONENT IN2**, select **Component 2** input source.
- 5 Refer to the DVD player's manual for operating instructions.

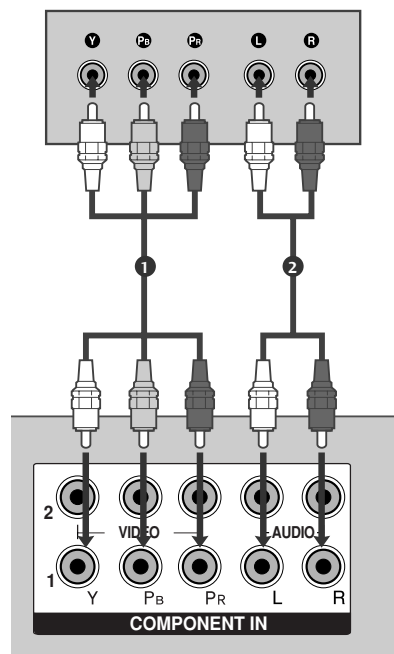

#### Component Input ports

To achieve better picture quality, connect a DVD player to the component input ports as shown below.

Component ports on the TV	Y	Pb	Pr
Video output ports on DVD player	Y	Pb	Pr
	Y	B-Y	R-Y
	Y	Cb	Cr
	Y	Pb	Pr

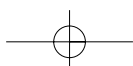

## When connecting with an S-Video cable

- 1 Connect the S-VIDEO output of the DVD to the **S-VIDEO** input on the TV.
- 2 Connect the audio outputs of the DVD to the **AUDIO** input jacks on the TV.
- 3 Turn on the DVD player, insert a DVD.
- 4 Select **AV2** input source using the **INPUT** button on the remote control.
- 5 Refer to the DVD player's manual for operating instructions.

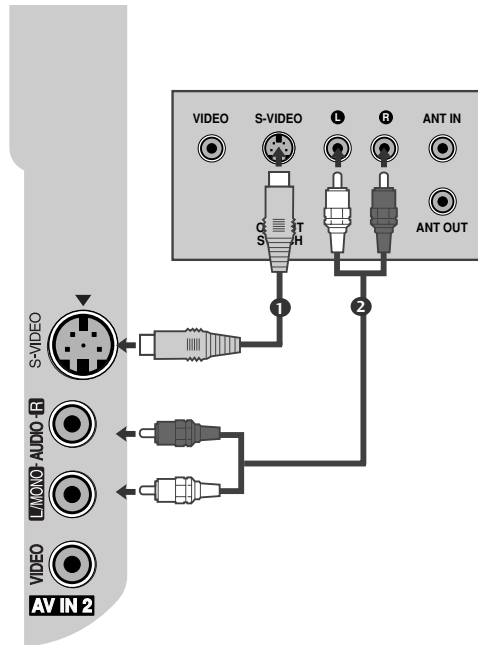

## EXTERNAL EQUIPMENT SETUP

### When connecting HDMI cable

- 1 Connect the HDMI output of the DVD to the **HDMI/DVI IN 1**, **HDMI IN 2** or **HDMI IN 3** (Only 42LG50\*\*) jack on the TV.
- 2 Select **HDMI1/DVI**, **HDMI2** or **HDMI3** (Only 42LG50\*\*) input source using the **INPUT** button on the remote control.
- 3 Refer to the DVD player's manual for operating instructions.

#### ! NOTE

- ▶ The TV can receive video and audio signals simultaneously when using a HDMI cable.

#### ! NOTE

- ▶ TV can receive the video and audio signal simultaneously with using a HDMI cable.
- ▶ If the DVD supports Auto HDMI function, the output resolution of the source device will be automatically set to 1280x720p.
- ▶ If the DVD player does not support Auto HDMI, you need to set the DVD output resolution appropriately.

To get the best picture quality, adjust the output resolution of the source device to 1280x720p.  
(42LG50\*\* :1920x1080i/1080p).

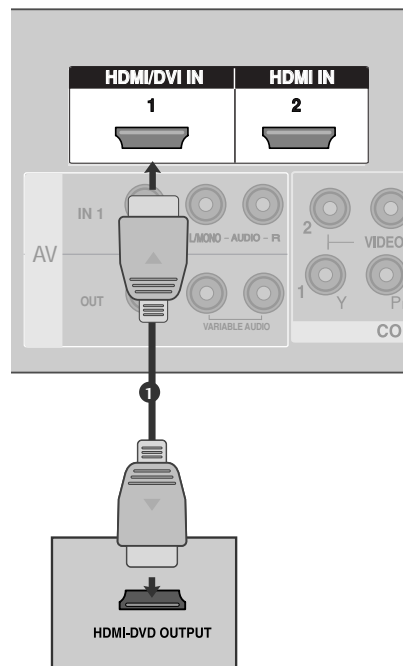

## VCR SETUP

- To avoid picture noise (interference), allow adequate distance between the VCR and TV.
- Typically a frozen still picture from a VCR. If 4:3 picture format is used for an extended period the fixed images on the sides of the screen may remain visible.

### When connecting with an antenna

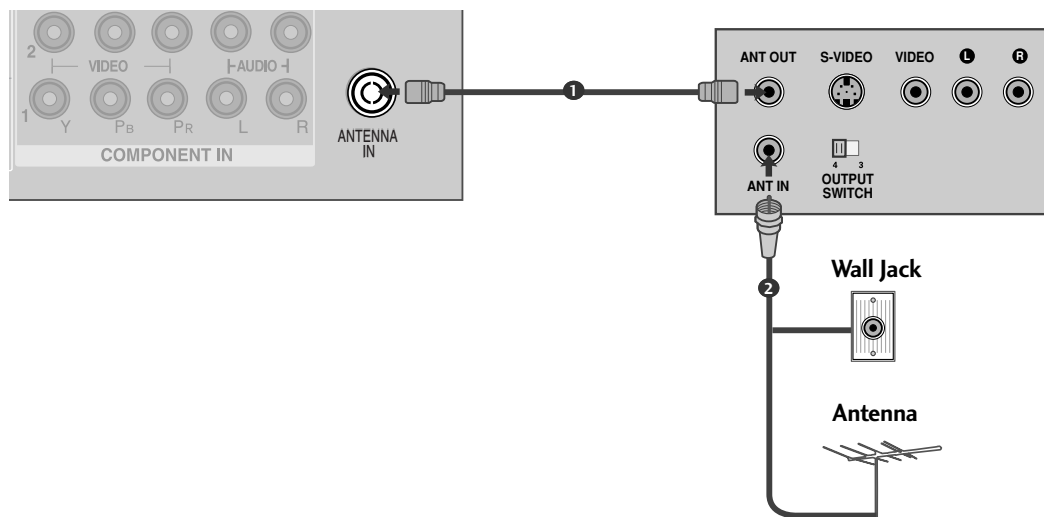

- 1 Connect the ANT OUT socket of the VCR to the **ANTENNA IN** socket on the TV.
- 2 Connect the antenna cable to the ANT IN socket of the VCR.
- 3 Press the PLAY button on the VCR and match the appropriate program between the TV and VCR for viewing.

## EXTERNAL EQUIPMENT SETUP

### When connecting with a RCA cable

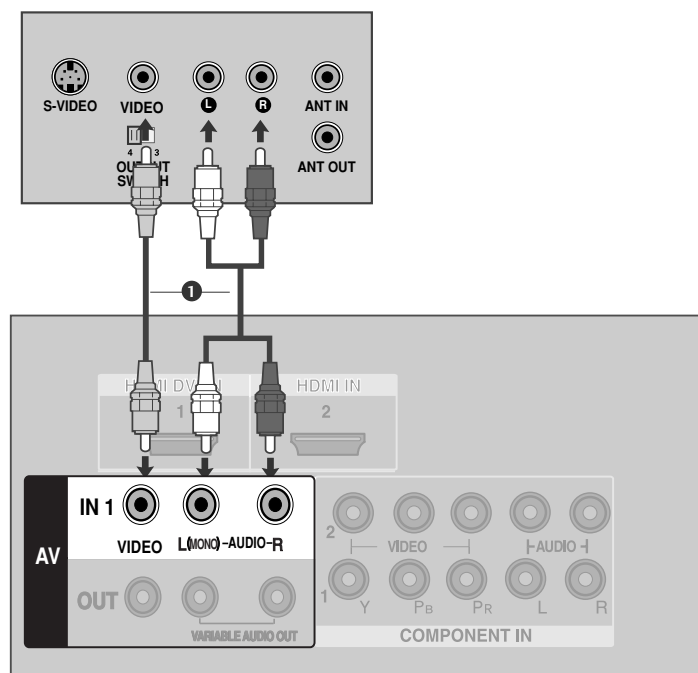

- 1 Connect the **AUDIO/VIDEO** jacks between TV and VCR. Match the jack colors (Video = yellow, Audio Left = white, and Audio Right = red)
- 2 Insert a video tape into the VCR and press **PLAY** on the VCR. (Refer to the VCR owner's manual.)
- 3 Select **AV1** input source using the **INPUT** button on the remote control. If connected to **AV IN2**, select **AV2** input source.

#### NOTE

- ▶ If you have a mono VCR, connect the audio cable from the VCR to the **AUDIO L/MONO** jack of the TV.

## When connecting with an S-Video cable

- 1 Connect the S-VIDEO output of the VCR to the **S-VIDEO** input on the TV. The picture quality is improved; compared to normal composite (RCA cable) input.
- 2 Connect the audio outputs of the VCR to the **AUDIO** input jacks on the TV.
- 3 Insert a video tape into the VCR and press **PLAY** on the VCR. (Refer to the VCR owner's manual.)
- 4 Select **AV2** input source using the **INPUT** button on the remote control.

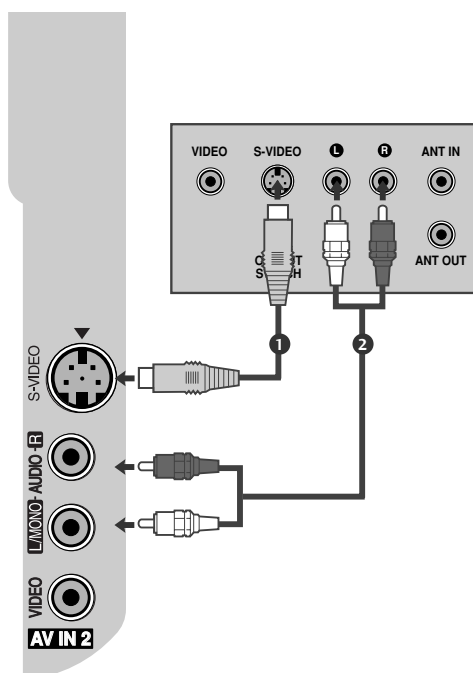

EXTERNAL EQUIPMENT SETUP

### ! NOTE

- ▶ If both S-VIDEO and VIDEO sockets have been connected to the S-VHS VCR simultaneously, only the S-VIDEO can be received.

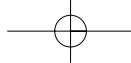

## EXTERNAL EQUIPMENT SETUP

### OTHER A/V SOURCE SETUP

EXTERNAL EQUIPMENT SETUP

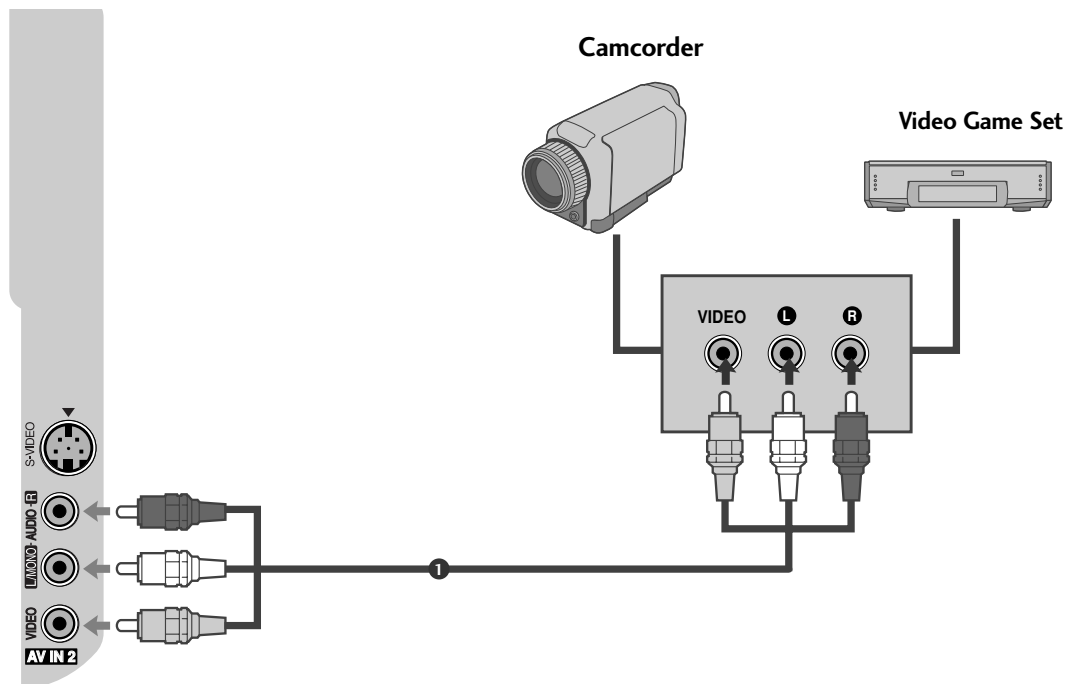

- 1 Connect the **AUDIO/VIDEO** jacks between TV and external equipment. Match the jack colors. (Video = yellow, Audio Left = white, and Audio Right = red)
- 2 Select **AV2** input source using the **INPUT** button on the remote control. If connected to **AV IN1**, select **AV1** input source.
- 3 Operate the corresponding external equipment. Refer to external equipment operating guide.

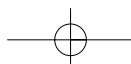



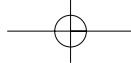

## PC SETUP

This TV provides Plug and Play capability, meaning that the PC adjusts automatically to the TV's settings.

### Connecting with a D-sub 15 pin cable

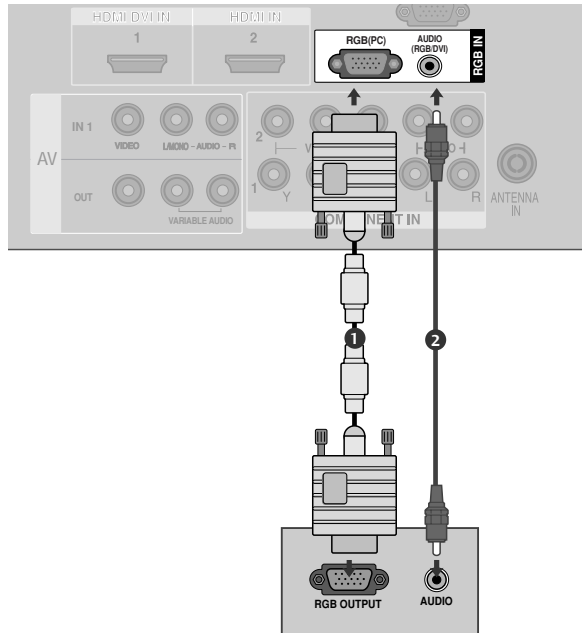

- 1** Connect the RGB output of the PC to the **RGB (PC)** jack on the TV.

.....
- 2** Connect the PC audio output to the **AUDIO (RGB/DVI)** jack on the TV.

.....
- 3** Turn on the PC and the TV.

.....
- 4** Select **RGB PC** input source using the **INPUT** button on the remote control.

.....

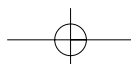

## EXTERNAL EQUIPMENT SETUP

### NOTES

- ▶ To enjoy vivid picture and sound, connect the PC to the TV.
- ▶ Avoid keeping a fixed image on the TV's screen for prolonged periods of time. The fixed image may become permanently imprinted on the screen; use a screen saver when possible.
- ▶ Connect the PC to the RGB (PC) port of the TV; change the resolution output of PC accordingly.
- ▶ There may be interference relating to resolution, vertical pattern, contrast or brightness in PC mode. Change the PC mode to another resolution or change the refresh rate to another rate or adjust the brightness and contrast on the menu until the picture is clear. If the refresh rate of the PC graphic card can not be changed, change the PC graphic card or consult the manufacturer of the PC graphic card.
- ▶ The synchronization input waveform for Horizontal and Vertical frequencies are separate.
- ▶ If the resolution of PC is over SXGA, there will be no picture on the TV. (Only HD Models)
- ▶ Connect the audio cable from the PC to the Audio input on the TV. (Audio cables are not included with the TV).
- ▶ If you use too long an RGB-PC cable, there may be interference on the screen. We recommend using under 5m of the cable. This provides the best picture quality.

### Supported Display Resolution (RGB-PC mode)

#### Plasma TV Models

Resolution	Horizontal Frequency(kHz)	Vertical Frequency(Hz)
640x350	31.468	70.09
720x400	31.469	70.09
640x480	31.469	59.94
800x600	37.879	60.317
1024x768	48.363	60.004
1280x768	47.776	59.87
1360x768	47.720	59.799

Only 50PG20\*

#### LCD TV Models

Resolution	Horizontal Frequency(kHz)	Vertical Frequency(Hz)
640x350	31.468	70.09
720x400	31.469	70.09
640x480	31.469	59.94
800x600	37.879	60.317
1024x768	48.363	60.004
1280x768	47.776	59.87
1360x768	47.720	59.799
1366x768	47.700	60.00
1280x1024	63.668	59.895
1920x1080	66.587	59.934

Only 42LG50\*\*

## SCREEN SETUP FOR PC MODE

### Auto Configure (RGB [PC] mode only)

Automatically adjusts picture position and minimizes image instability. After adjustment, if the image is still not correct, your TV is functioning properly but needs further adjustment.

#### Auto configure

This function is for the automatic adjustment of the screen position, clock, and phase. The displayed image will be unstable for a few seconds while the auto configuration is in progress.

- 1 Press the **MENU** button and then use  $\wedge$  or  $\vee$  button to select the **Picture** menu.
- 2 Press the  $\>$  button and then use  $\wedge$  or  $\vee$  button to select **Screen**.
- 3 Press the  $\>$  button and then use  $\wedge$  or  $\vee$  button to select **Auto Config.**
- 4 Press the  $\>$  button to start **Auto Config.**
  - When Auto config. has finished, OK will be shown on screen.
  - If the position of the image is still not correct, try Auto adjustment again.
- 5 If picture needs to be adjusted again after Auto adjustment in RGB (PC), you can adjust the **Manual Config.**
- 6 Press the **MENU** button to return to TV viewing. Press the **RETURN** button to move to the previous menu.

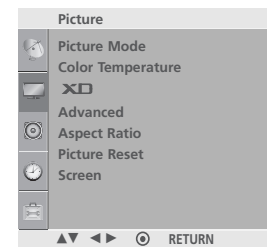

1

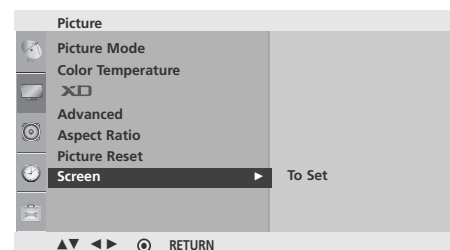

2

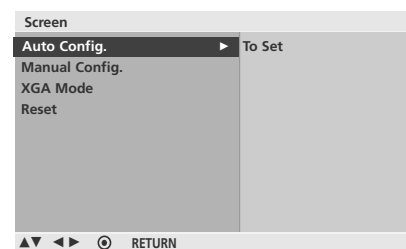

3 4

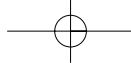

## EXTERNAL EQUIPMENT SETUP

### Manual Configure - Adjustment for screen Phase, Clock, Position (RGB [PC] mode only)

If the picture isn't clear after auto adjustment and especially if characters are still trembling, adjust the picture phase manually.

It's not available to use Phase, Clock function in COMPONENT (480i/480p/576i/576p/720p/1080i/1080p), HDMI (480p/576p/720p/1080i/1080p).

**Clock** This function is to minimize any vertical bars or stripes visible on the screen background. And the horizontal screen size will also change.

**Phase** This function allows you to remove any horizontal noise and clear or sharpen the image of characters.

1 Press the **MENU** button and then use  $\wedge$  or  $\vee$  button to select the **Picture** menu.

2 Press the  $\rightarrow$  button and then use  $\wedge$  or  $\vee$  button to select **Screen**.

3 Press the  $\rightarrow$  button and then use  $\wedge$  or  $\vee$  button to select **Manual Config.**

4 Press the  $\rightarrow$  button and then use  $\wedge$  or  $\vee$  button to select **Phase, Clock, H-Position, V-Position**.

5 Press the  $\leftarrow$  or  $\rightarrow$  button to make appropriate adjustments.

6 Press the **MENU** button to return to TV viewing.  
Press the **RETURN** button to move to the previous menu.

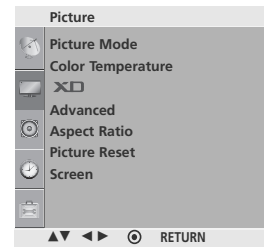

1

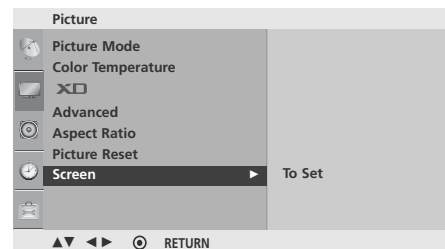

2

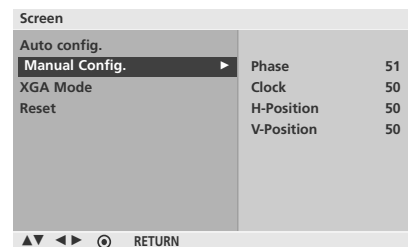

3 4 5

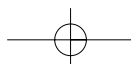

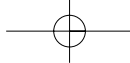

## Selecting XGA mode

- Except 42PG20\*

To see a normal picture, match the resolution of RGB mode and selection of XGA mode.

This function works in the following mode: RGB[PC] mode.

- 1 Press the **MENU** button and then use  $\wedge$  or  $\vee$  button to select the **Picture** menu.
- 2 Press the  $\triangleright$  button and then use  $\wedge$  or  $\vee$  button to select **Screen**.
- 3 Press the  $\triangleright$  button and then use  $\wedge$  or  $\vee$  button to select **XGA Mode**.
- 4 Press the  $\triangleright$  button and then use  $\wedge$  or  $\vee$  button to select the desired XGA resolution.
- 5 Press the **MENU** button to return to TV viewing.  
Press the **RETURN** button to move to the previous menu.

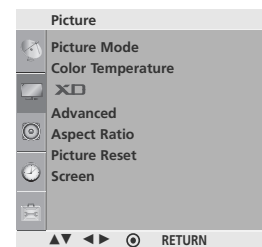

1

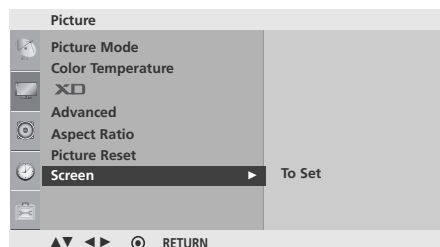

2

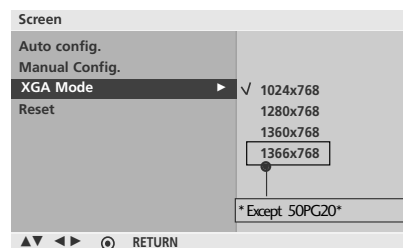

3 4

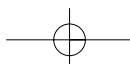

# EXTERNAL EQUIPMENT SETUP

## Initializing (Reset to original factory settings)

This function operates in current mode.

To initialize the adjusted value

- 1 Press the **MENU** button and then use  $\wedge$  or  $\vee$  button to select the **Picture** menu.
- 2 Press the  $\rightarrow$  button and then use  $\wedge$  or  $\vee$  button to select **Screen**.
- 3 Press the  $\rightarrow$  button and then use  $\wedge$  or  $\vee$  button to select **Reset**.
- 4 Press the  $\rightarrow$  button.
- 5 Press the **MENU** button to return to TV viewing.  
Press the **RETURN** button to move to the previous menu.

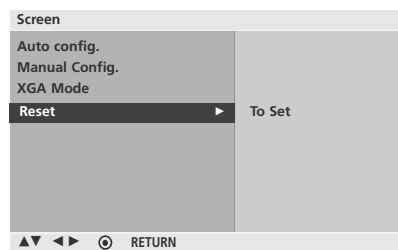
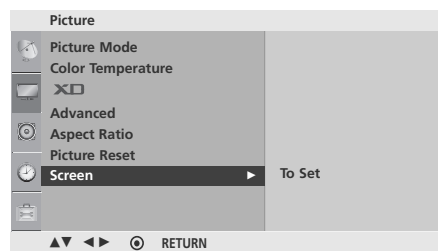
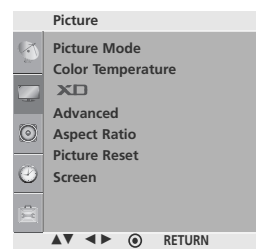

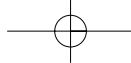

## EXTERNAL STEREO SETUP

Use to connected either an external amplifier, or add a sub-woofer to your surround sound system.

- 1 Connect the input jack of the stereo amplifier to the **VARIABLE AUDIO OUT** jacks on the TV.
- 2 Set up your speakers through your analog stereo amplifier, according to the instructions provided with the amplifier.

### NOTE

- ▶ When connecting with external audio equipments, such as amplifiers or speakers, please turn the TV speakers off.
- ▶ Select **Variable Out** in Audio manu to connect the **VARIABLE AUDIO OUT** jacks. (▶ p.74)

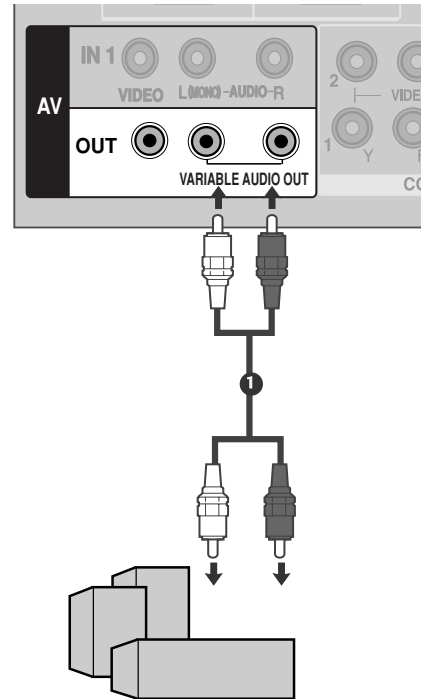

EXTERNAL EQUIPMENT SETUP

## AV OUT SETUP

The TV has a special signal output capability which allows you to hook up the second TV or monitor.

- 1 Connect the second TV or monitor to the TV's **AV OUT** jacks.
- 2 See the Operating Manual of the second TV or monitor for further details regarding that device's input settings.

### NOTE

- ▶ Component, RGB, HDMI input sources cannot be used for AV out.
- ▶ We recommend to use the AV OUT jacks for VCR recording.

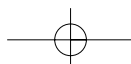
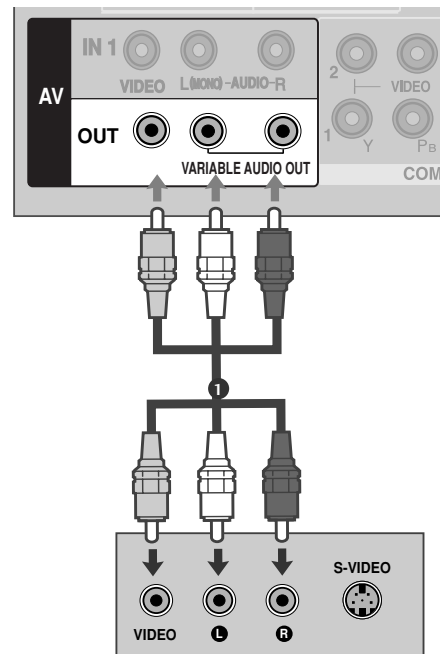

# WATCHING TV / CHANNEL CONTROL

## REMOTE CONTROL KEY FUNCTIONS

When using the remote control, aim it at the remote control sensor on the TV.

### (Plasma TV Models)

WATCHING TV / CHANNEL CONTROL



**RATIO** Change the aspect ratio. ► **p.53**

**SOUND** Select the appropriate type of sound for type of program. ► **p.70**

**INPUT** External input modes rotate in regular sequence.

**PICTURE** Adjust the factory preset picture depend on the viewing environment. ► **p.54**

**Q. MENU** Select the desired quick menu source. ► **p.41**

**MENU** Displays the main menu.  
Clear all on-screen displays and return to TV viewing from any menu.

**SIMPLINK** See a list of AV devices connected to TV.  
When you toggle this button, the Simplink menu appears at the screen. ► **p.50**

**VOLUME UP /DOWN** Increase/decrease in the sound level.

**FAV** Scroll through the programmed favorite channels. ► **p.47**

**MUTE** Switches the sound on or off. ► **p.40**

**CH UP/DOWN** Select available channels.

**0~9 number button** Selects a channel.  
Selects numbered items in a menu.

**Q.VIEW** Tune to the last channel viewed.



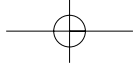

**(LCD TV Models)**



**TV/DVD/STB** Select the remote operating mode: TV, DVD, or STB.

**INPUT** External input modes rotate in regular sequence.

**THUMBSTICK** Navigate the on-screen menus and adjust the system (Up/Down/Left Right/ENTER)

**RETURN** Allows the user to move return one step in an interactive application or other user interaction function.

**PIP** Switches the sub picture PIP, DW mode.

**AV MODE** It helps you select and set images and sounds when connecting AV devices. ► p.49

**VCR/DVD, SIMPLINK** Control video cassette recorders or DVD players. Control the SIMPLINK compatible devices.

**Control buttons**

**Installing Batteries**

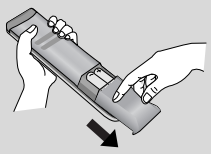

- Open the battery compartment cover on the back and install the batteries matching correct polarity (+with +,-with -).
- Install two 1.5V AAA batteries. Do not mix old or used batteries with new ones.
- Close cover.

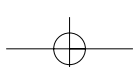

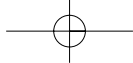

## WATCHING TV /CHANNEL CONTROL

### TURNING ON TV

- 1 Firstly, connect the power cord correctly.  
At this stage, the TV switches to standby mode.
  - In standby mode to turn TV on, press the  $\phi/|$  , **INPUT, CH (▲ or ▼)** or **CH (^ or v)** button on the TV or press the **POWER, INPUT, CH (^ or v)**, **NUMBER(0~9)** button on the remote control.

#### ! NOTE

- ▶ If you intend to be away on vacation, disconnect the power plug from the wall power outlet.

#### Initializing setup.

If the OSD (On Screen Display) is displayed on the screen after turning on the TV, you can adjust the **Language, Location, Auto Tuning**.

#### Note:

- a. It will automatically disappear after approx. 40 seconds unless a button is pressed.
- b. "In - store" mode is only for shop display and not for general customer use.
- c. "Home" mode is the optimal setting for home environments, and is the TV's default mode.
- d. "In - store" mode is the optimal setting for store environments. If a user modifies image quality data, "In Store" mode initializes the product to the image quality set by us after a certain period of time.
- e. The mode (Home, In - store) can be changed by executing Factory Reset in the Option menu.

### CHANNEL SELECTION

- 1 Press the **CH (^ or v)** or **NUMBER** buttons to select a channel number.

### VOLUME ADJUSTMENT

Adjust the volume to suit your personal preference.

- 1 Press the **VOL (+ or -)** button to adjust the volume.
- 2 If you want to switch the sound off, press the **MUTE** button.
- 3 You can cancel the Mute function by pressing the **MUTE** or **VOL (+ or -)** button.

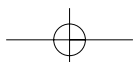

## QUICK MENU

Your TV's OSD (On Screen Display) may differ slightly from what is shown in this manual.

Q.Menu (Quick Menu) is a menu of features which users might use frequently.

- **Aspect Ratio**: Selects your desired picture format.
- **Backlight** (only LCD TV Models): Adjust the brightness of LCD panel to control the brightness of the screen.
- **Power Saving** (only Plasma TV Models): Adjusts screen brightness to reduce the power consumption of the set.
- **Picture Mode**: Selects the factory preset picture depend on the viewing environment.
- **Sound Mode**: Selects the factory preset sound for type of program.
- **SAP**: Selects the sound output.
- **Caption/Text**: Select a closed caption.
- **Ch.Memory/Erase**: Sets the channel add or delete.
- **Sleep Timer**: Select the amount of time before your TV turns off automatically.

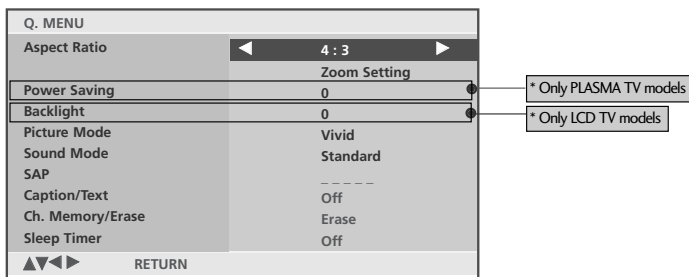

- 1 Press the **Q.MENU** button and then  $\wedge$  or  $\vee$  button to display each menu.
- 2 Press the  $\lt$  or  $\gt$  button to make appropriate adjustments.
- 3 Press the **Q.MENU** button to return to TV viewing.

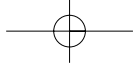

# WATCHING TV /CHANNEL CONTROL

## ON-SCREEN MENUS SELECTION

The OSD (On Screen Display) function enables you to adjust the screen status conveniently since it provides graphical presentation.

In this manual, the OSD (On Screen Display) may be different from your TV's because it is just example to help the TV operation.

- 1 Press the **MENU** button and then  $\wedge$  or  $\vee$  button to display each menu.
- 2 Press the  $\rightarrow$  button and then  $\wedge$  or  $\vee$  button to select a menu item.
- 3 Change the setting of an item in the sub or pull-down menu with  $\leftarrow$  or  $\rightarrow$  button.  
You can move to a higher level menu by pressing the **ENTER** or **MENU** button.

WATCHING TV / CHANNEL CONTROL

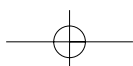
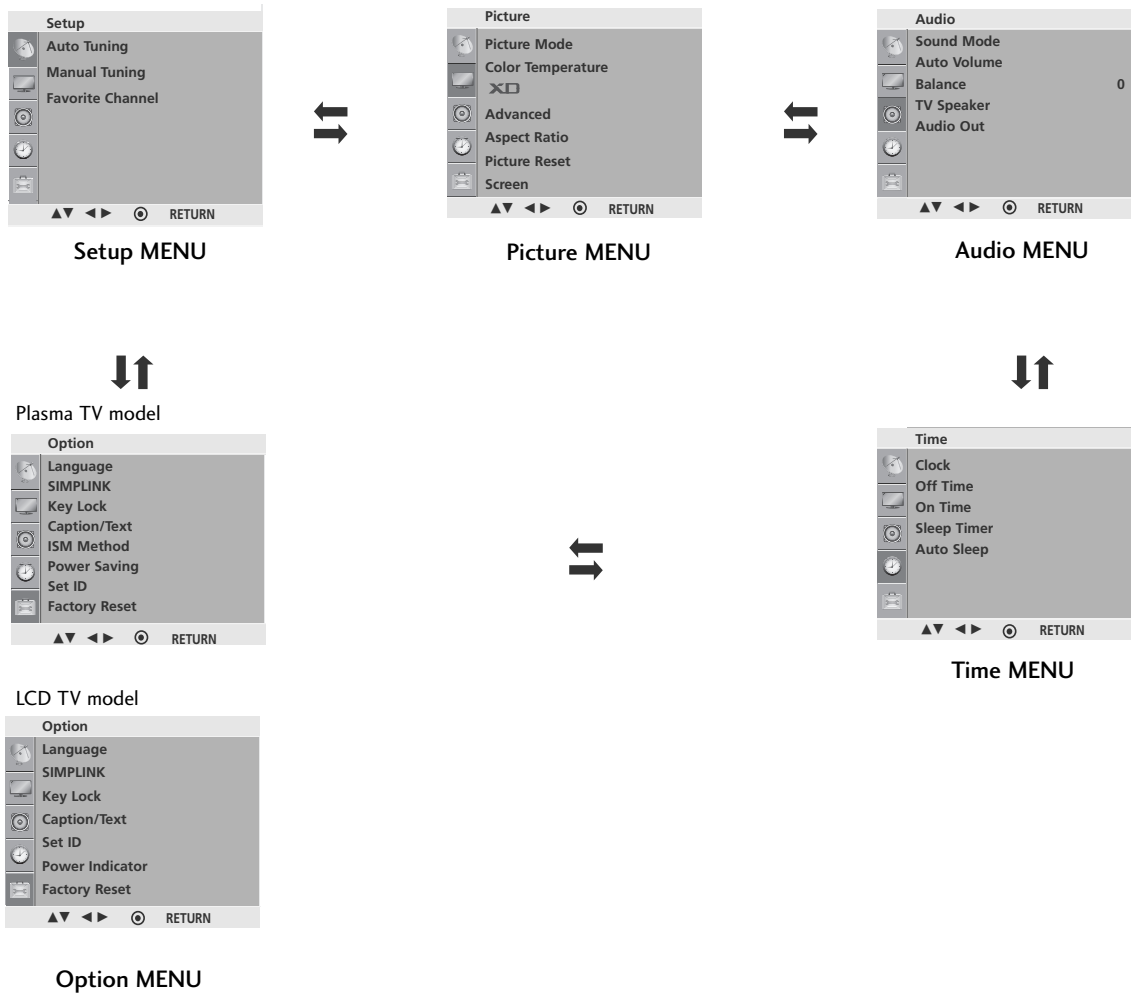

## CHANNEL SEARCH

### Auto Tuning

Auto Tuning should be used to memorize all the active channels in your area before you are able to use the TV.

There are two ways of storing channels in the TV's memory. You can use either.

One is called Auto Tuning and the other is called Manual Tuning.

In Auto Tuning mode, the TV will memorize the channels in ascending numerical order. If there are additional channels you want to add or delete, you can manually add or delete those channels with Manual Tuning.

**1** Press the **MENU** button and then use  $\wedge$  or  $\vee$  button to select the **Setup** menu.

**2** Press the  $\>$  button and then use  $\wedge$  or  $\vee$  button to select **Auto Tuning**.

**3** Press the  $\>$  button. **Auto Tuning** starts the channel search.

**4** If you want to stop auto programming, press the **RETURN** button.

Only the channels found up to at that time are memorized.

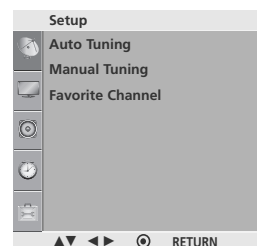

**1**

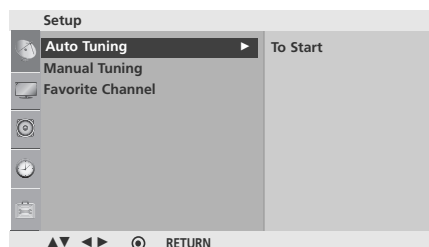

**2**

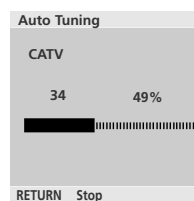

**3**

## WATCHING TV /CHANNEL CONTROL

### Manual Tuning: Adding/Deleting Channels

You can add or delete channels from the channel scan manually.

- 1 Press the **MENU** button and then  $\wedge$  or  $\vee$  button to select the **Setup** menu.
- 2 Press the  $\triangleright$  button and then  $\wedge$  or  $\vee$  button to select **Manual Tuning**.
- 3 Press the  $\triangleright$  button and then  $\triangleleft$  or  $\triangleright$  button to select **channel number**.
- 4 Press the  $\vee$  button and then  $\triangleleft$  or  $\triangleright$  button to select **Memory** or **Erase**.
- 5 Press the **MENU** button to return to TV viewing.  
Press the **RETURN** button to move to the previous menu.

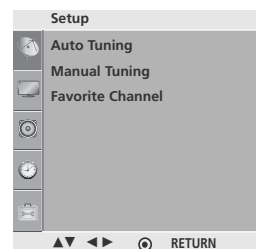

1



2 3

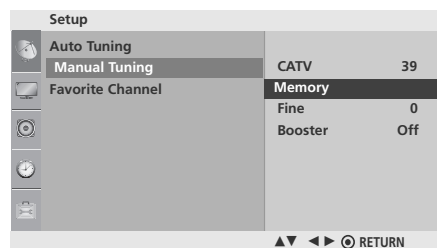

4

## FINE TUNING ADJUSTMENT

Normally fine tuning is only necessary if reception is poor.

- 1 Press the **MENU** button and then use  $\wedge$  or  $\vee$  button to select the **Setup** menu.
- 2 Press the  $\>$  button and then use  $\wedge$  or  $\vee$  button to select **Manual Tuning**.
- 3 Press the  $\>$  button and then use  $\wedge$  or  $\vee$  button to select **Fine**.
- 4 Press the  $\leftarrow$  or  $\rightarrow$  button to adjust the picture to your preference.
- 5 Press the **MENU** button to return to TV viewing.  
Press the **RETURN** button to move to the previous menu.

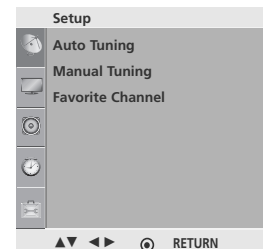

1



2

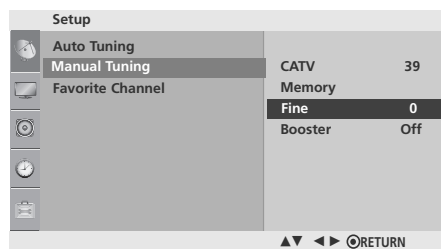

3 4

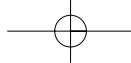

## WATCHING TV /CHANNEL CONTROL

### BOOSTER

In some models, **Booster** is an optional function. Only a set with **Booster** can perform this function.

If reception is poor, select **Booster to On**.  
When the signal is strong, select "OFF".

- 1 Press the **MENU** button and then use  $\wedge$  or  $\vee$  button to select the **Setup** menu.
- 2 Press the  $\rightarrow$  button and then use  $\wedge$  or  $\vee$  button to select **Manual Tuning**.
- 3 Press the  $\rightarrow$  button and then use  $\wedge$  or  $\vee$  button to select **Booster**.
- 4 Press the  $\leftarrow$  or  $\rightarrow$  button to **On** or **Off**.
- 5 Press the **MENU** button to return to TV viewing.  
Press the **RETURN** button to move to the previous menu.

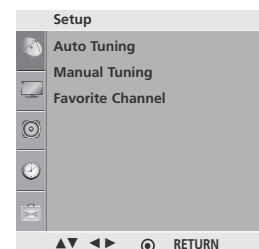

1

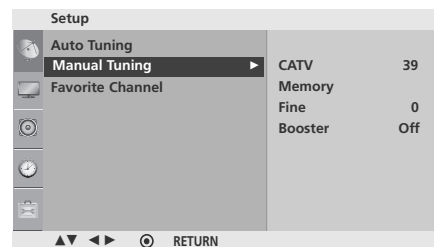

2

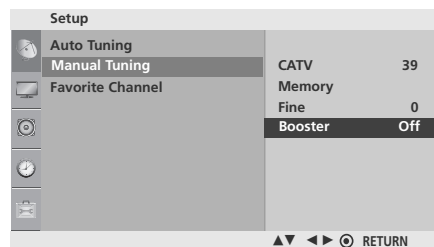

3 4

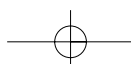



## FAVORITE CHANNELS SETUP

This function lets you select your favorite channels directly.

Repeatedly press the FAV button to select stored favorite channels.

- 1 Press the **MENU** button and then use  $\wedge$  or  $\vee$  button to select the **Setup** menu.
- 2 Press the  $\>$  button and then use  $\wedge$  or  $\vee$  button to select **Favorite Channel**.
- 3 Press the  $\>$  button and then use  $\wedge$  or  $\vee$  button to select the first favorite channel position.
- 4 Press the  $\leftarrow$  or  $\rightarrow$  button to set the desired channel number for first favorite channel.
- 5 Repeat steps 3 to 5 to memorize other favorite channels. You can store up to 8 channels.
- 6 Press the **MENU** button to return to TV viewing. Press the **RETURN** button to move to the previous menu.

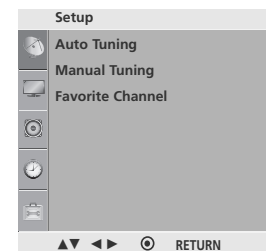

1

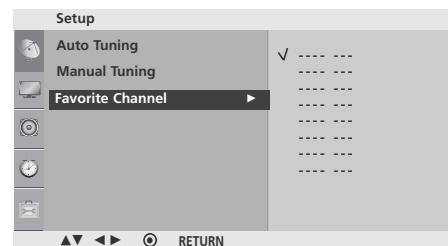

2 3 4

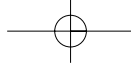

## WATCHING TV /CHANNEL CONTROL

### KEY LOCK

The TV can be set so that the remote control is needed to control it.

This feature can be used to prevent unauthorized viewing.

This TV is programmed to remember which option it was last set to even if you turn the TV off.

- 1 Press the **MENU** button and then use  $\wedge$  or  $\vee$  button to select the **Option** menu.
- 2 Press the  $\>$  button and then use  $\wedge$  or  $\vee$  button to select **Key Lock**.
- 3 Press the  $\>$  button and then use  $\wedge$  or  $\vee$  button to select **On** or **Off**.
- 4 Press the **MENU** button to return to TV viewing.  
Press the **RETURN** button to move to the previous menu.

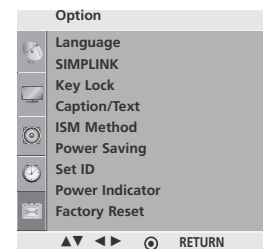

1

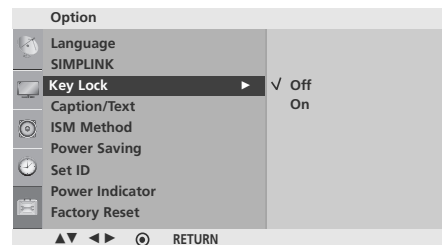

2 3

#### NOTE

- ▶ In **Key Lock 'On'**, if the TV is turned off, press the **INPUT, CH (▲ or ▼)** or **CH (∧ or ∨)** button on the TV or **POWER, INPUT, CH (∧ or ∨), NUMBER** buttons on the remote control.
- ▶ With the **Key Lock On**, the display 'Key Lock On' appears on the screen if any button on the front panel is pressed while viewing the TV.

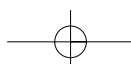

## AV MODE

As pressing the AV MODE button to change the Cinema, Sport and Game at the same time, you can see the optimal images and sounds.

It gives the viewing environment (Picture Quality + Sound Quality) optimized for the consumers.

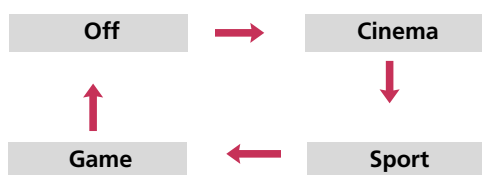

- 1 Press the **AV MODE** button repeatedly to select the desired source.

- If you select Cinema Mode in AV mode, Cinema mode will be selected both for Picture Mode and Sound Mode in Picture menu and Audio menu respectively.
- If you select "Off" in AV mode, the picture and image which you initially set will be selected.

- 2 Press the **RETURN** button to return to normal TV viewing.

## WATCHING TV /CHANNEL CONTROL



This function operates only with devices with the  logo.

This TV might not function when using it with other products with HDMI-CEC function.

This allows you to control and play other AV devices connected with HDMI cable without additional cables and settings.

**1** Press the **MENU** button and then use  $\wedge$  or  $\vee$  button to select the **Option** menu.

**2** Press the  $\blacktriangleright$  button and then use  $\wedge$  or  $\vee$  button to select **SIMPLINK**.

**3** Press the  $\blacktriangleright$  button and then use  $\wedge$  or  $\vee$  button to select **On** or **Off**.

**4** Press the **MENU** button to return to normal TV viewing. Press the **RETURN** button to move to the previous menu screen.

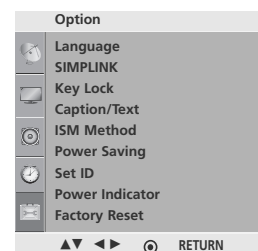

1

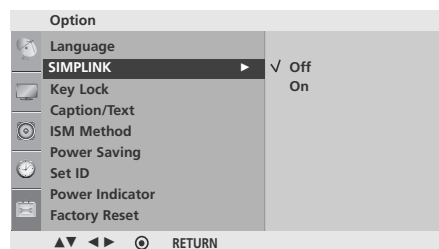

2 3

### ! NOTE

- ▶ After connecting the HDMI terminal for the home theater with SIMPLINK function in the above method, connect the VARIABLE AUDIO OUT terminal on the back of the TV to the VARIABLE AUDIO IN terminal on the back of the SIMPLINK device with the VARIABLE AUDIO OUT cable. (MENU -> Audio-> Variable Out)

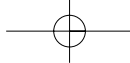

## Simplink Functions

- **Direct Play:** After connecting AV devices to TV, you can directly control the devices and play media without additional settings.
- **Select AV device:** Enables you to select one of AV devices connected to TV and play it.
- **Disc playback:** Control connected AV devices by pressing the  $\wedge$   $\vee$   $\langle$   $\rangle$ , ENTER,  $\blacktriangleright$ ,  $\blacksquare$ ,  $\parallel$ ,  $\blacktriangleleft$  and  $\blacktriangleright\blacktriangleright$  buttons (The  $\bullet$  button does not provide such functions)
- **Power off all devices:** When you power off TV, all connected devices are turned off. (This option only applied when the devices are stopped.)
- **Switch audio-out:** Offers an easy way to switch audio-out.  
Sync Power on: When you play the connected AV device, TV will automatically turn on.

(A device, which is connected to TV through HDMI cable but does not support Simplink, does not provide this function)

Note: To operate SIMPLINK, the HDMI cable should be used.

- 1 Press the **SIMPLINK** button.
- 2 Use  $\wedge$   $\vee$   $\langle$   $\rangle$  button to select the desired device and then press the **ENTER** button.
- 3 Control connected AV devices by pressing the  $\blacktriangleright$ ,  $\blacksquare$ ,  $\parallel$ ,  $\blacktriangleleft$ ,  $\blacktriangleright\blacktriangleright$ ,  $\wedge$   $\vee$   $\langle$   $\rangle$ , **ENTER** buttons.

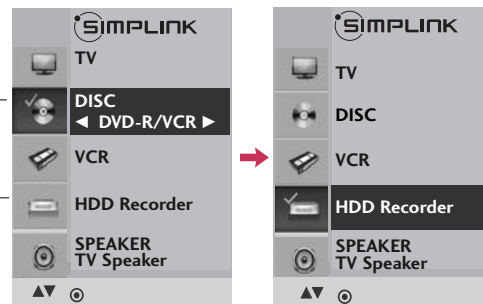

## Simplink Menu

- 1 **TV viewing** : Switch to the previous TV programme regardless of the current mode.
- 2 **DISC playback** : Select and play discs. When multiple discs are available, the titles of the discs are conveniently displayed at the bottom of the screen.
- 3 **VCR playback** : Control the connected VCR.
- 4 **HDD Recordings playback** : Control recordings stored in HDD.
- 5 **Audio Out to Home theater/Audio Out to TV** : Select Home theater or TV speaker for Audio Out.

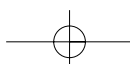
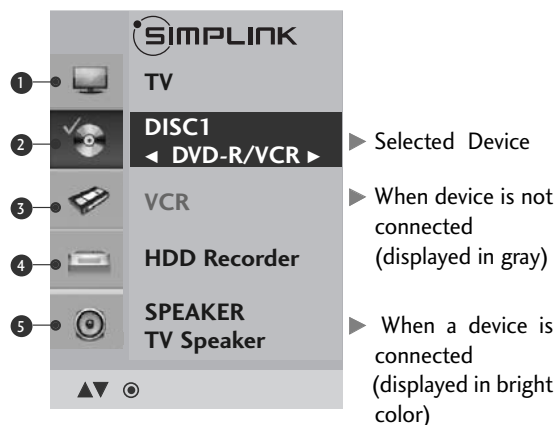

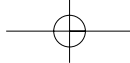

# PICTURE CONTROL

## WATCHING PIP(PICTURE-IN-PICTURE)

PIP lets you view 2 different inputs (sources) on your TV screen at the same time.

One source will be large, and the other source will show a smaller inset image.

PIP function is available in the Component, RGB, HDMI mode.

(For FHD models, it can support TV, AV1, AV2 mode.)

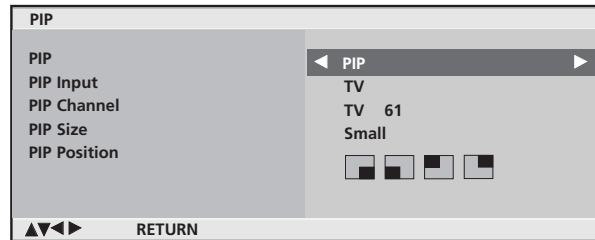

### Watching PIP/Double Window

Press the **PIP** button and then press the  $\wedge \vee < >$  button to change the PIP options as shown below.

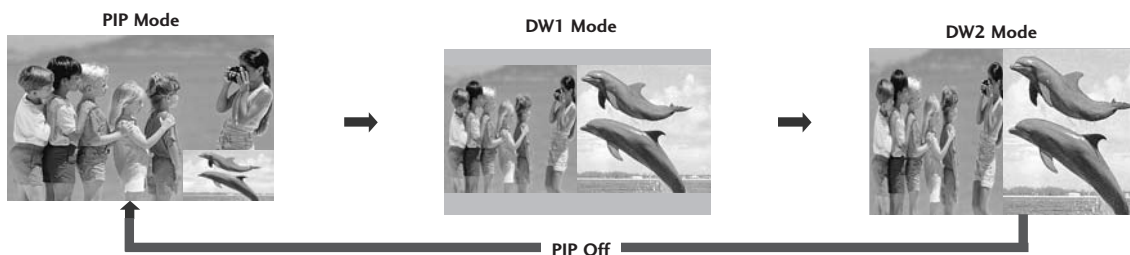

### Channel Selection for Sub Picture

Press the **PIP** button and then press the  $\wedge \vee < >$  button to select a channel for the sub picture.

The selected channel number is displayed just below the channel number of main picture.

### Input Source Selection for Sub Picture

Press the **PIP** button and then press the  $\wedge \vee < >$  button to select the PIP Input source for the sub picture.

(Sub picture can be selected only TV, AV1, AV2)

### Sub Picture Size Adjustment (PIP mode only)

Press the **PIP** button and then press the  $\wedge \vee < >$  button to adjust the sub picture size.

### Moving the Sub Picture (PIP mode only)

Press the **PIP** button and then press the  $\wedge \vee < >$  button to adjust the sub picture position.

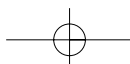

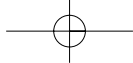

## PICTURE SIZE (ASPECT RATIO)CONTROL

You can watch the screen in various picture formats; **16:9**, **4:3**, and **Zoom1/2** and **Just Scan**.

If a fixed image is displayed on the screen for a long time, that fixed image may become imprinted on the screen and remain visible.

- Press the **RATIO** button repeatedly to select the desired picture format. (Only 42/50PG20\*)

**1** You can adjust **Aspect Ratio** in the **Picture** menu.

### • 16:9

The following selection will allow you to adjust the picture horizontally, in linear proportion, to fill the entire screen (useful for viewing 4:3 formatted DVDs).



### • 4:3

The following selection will allow you to view a picture with an original 4:3 aspect ratio, grey bars will appear on both the left and right hand of the screen.



### • Zoom1

The following selection will allow you to view the picture without any alteration, while filling the entire screen. However, the top and bottom of the picture will be cropped. You can adjust the enlarge proportion using **^** or **∨** button.

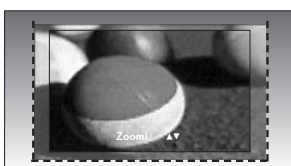

### • Zoom2

Choose Zoom 2 when you wish the picture to be altered, both horizontally extended and vertically cropped. The picture adopting a compromise between alteration and screen coverage.

You can adjust the enlarge proportion using **^** or **∨** button.

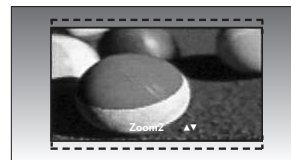

### • Just Scan

Following selection will lead to you view the picture of best quality without loss of original picture in high resolution image.

Notes: If there are noise in original picture, you can see the noise at the edge.

**Just Scan** operates only in Component (720p/1080i/1080p), HDMI(720p/1080i/1080p) input source.

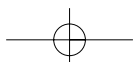

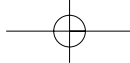

# PICTURE CONTROL

## PRESET PICTURE SETTINGS

### Picture Mode-Preset

Picture Mode adjusts the TV for the best picture appearance. Select the preset value in the **Picture Mode** menu based on the channel category.

Intelligent sensor(Only 42LG50\*\*), Vivid, Standard, Cinema, Sport and Game are programmed for optimum picture reproduction at the factory and cannot be changed.

When the Intelligent sensor function is on, the most suitable picture is automatically adjusted according to the surrounding conditions.(Only 42LG50\*\*)

- Press the **PICTURE** button repeatedly to select the picture appearance setup option. (Only 42/50PG20\*)

- 1 Press the **MENU** button and then  $\wedge$  or  $\vee$  button to select the **Picture** menu.
- 2 Press the  $\>$  button and then  $\wedge$  or  $\vee$  button to select **Picture Mode**.
- 3 Press the  $\>$  button and then  $\wedge$  or  $\vee$  button to select **Intelligent Sensor(Only 42LG50\*\*), Vivid, Standard, Cinema, Sport, Game, User1** or **User2**.
- 4 Press the **MENU** button to return to TV viewing.  
Press the **RETURN** button to move to the previous menu screen.

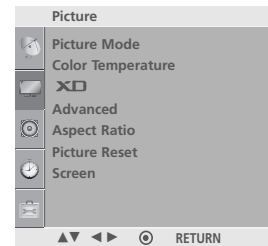

1

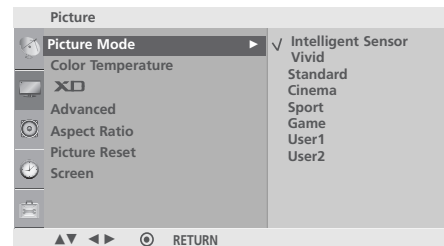

2 3

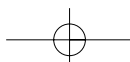



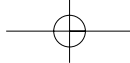

## Auto Color Tone Control(Cool/Medium/Warm)

To initialize values (reset to default settings), select the Cool option.

Choose one of three automatic color adjustments. Set to warm to enhance hotter colors such as red, or set to cool to see less intense colors with more blue.

This menu is activated after selecting "User1" or "User2" in the Picture Mode.

- 1 Press the **MENU** button and then  $\wedge$  or  $\vee$  button to select the **Picture** menu.
- 2 Press the  $\>$  button and then  $\wedge$  or  $\vee$  button to select **Color Temperature**.
- 3 Press the  $\>$  button and then  $\wedge$  or  $\vee$  button to select either **Cool**, **Medium** or **Warm**.
- 4 Press the **MENU** button to return to TV viewing.  
Press the **RETURN** button to move to the previous menu screen.

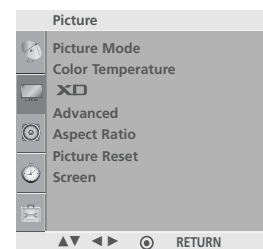

1

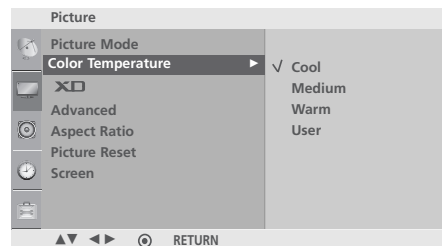

2 3

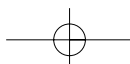

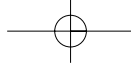

## PICTURE CONTROL

### MANUAL PICTURE ADJUSTMENT

#### Picture Mode-User Mode

- Backlight** To control the brightness of the screen, adjust the brightness of LCD panel.(Only LCD TV models)
- Contrast** Adjusts the difference between light and dark.
- Brightness** Increases or decreases the amount of white in the picture.
- Color** Adjusts intensity of all colors.
- Sharpness** Adjusts the level of crispness in the edges between the light and dark areas of the picture. The lower the level, the softer the image.
- Tint** Adjusts the balance between red and green levels.

- 1 Press the **MENU** button and then  $\wedge$  or  $\vee$  button to select the **Picture** menu.
- 2 Press the  $\triangleright$  button and then  $\wedge$  or  $\vee$  button to select **Picture Mode**.
- 3 Press the  $\triangleright$  button and then  $\wedge$  or  $\vee$  button to select **User1** or **User2**.
- 4 Press the  $\triangleright$  button and then  $\wedge$  or  $\vee$  button to select the desired picture option (**Backlight**(Only LCD TV modes), **Contrast**, **Brightness**, **Color**, **Sharpness** and **Tint**).
- 5 Press the  $\triangleleft$  or  $\triangleright$  button to make appropriate adjustments.
- 6 Press the **MENU** button to return to TV viewing.  
Press the **RETURN** button to move to the previous menu screen.

#### ! NOTE

- ▶ You cannot adjust color, sharpness and tint in the RGB-PC mode.

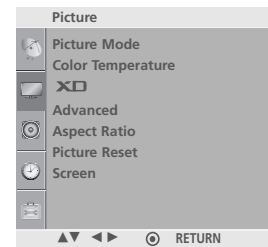

1

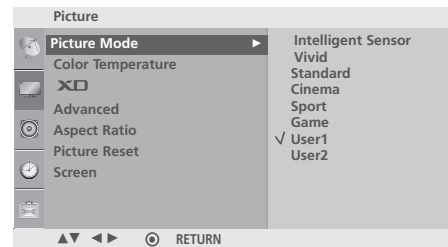

2 3

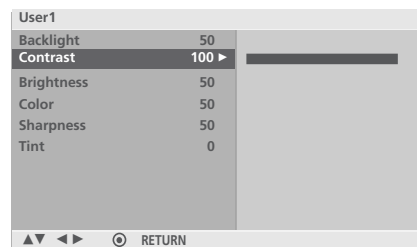

4



5

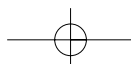

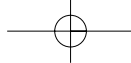

## Color Tone - User Mode

To adjust red, green, blue to any color temperature you prefer.

When selecting Picture Mode (User1 or User2), you can operate this function.

1 Press the **MENU** button and then  $\wedge$  or  $\vee$  button to select the **Picture** menu.

2 Press the  $\>$  button and then  $\wedge$  or  $\vee$  button to select **Color Temperature**.

3 Press the  $\>$  button and then  $\wedge$  or  $\vee$  button to select **User**.

4 Press the  $\>$  button and then  $\wedge$  or  $\vee$  button to select **Red, Green or Blue**.

5 Press the  $\leftarrow$  or  $\rightarrow$  button to make appropriate adjustments.

6 Press the **MENU** button to return to TV viewing.  
Press the **RETURN** button to move to the previous menu screen.

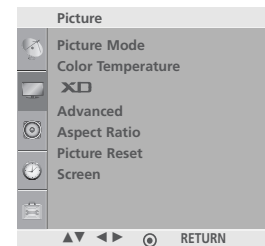

1

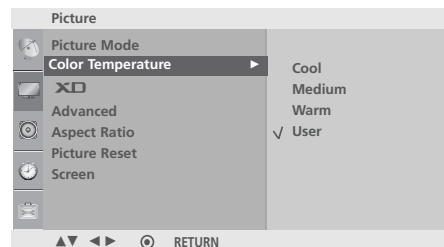

2 3

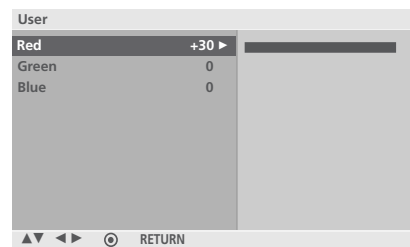

4



5

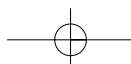

## PICTURE CONTROL

### **XD** - PICTURE IMPROVEMENT TECHNOLOGY

XD is LG electronic's unique picture improving technology to display a real HD source through an advanced digital signal processing algorithm.

It is not possible to use this function in RGB-PC mode.

- 1 Press the **MENU** button and then  $\wedge$  or  $\vee$  button to select the **Picture** menu.
- 2 Press the  $\rightarrow$  button and then  $\wedge$  or  $\vee$  button to select **XD**.
- 3 Press the  $\rightarrow$  button and then  $\wedge$  or  $\vee$  button to select **Auto** or **Manual**.
- 4 Press the **MENU** button to return to TV viewing.  
Press the **RETURN** button to move to the previous menu screen.

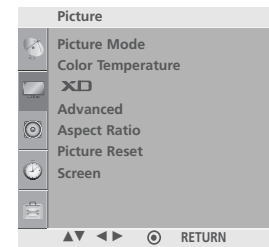

1

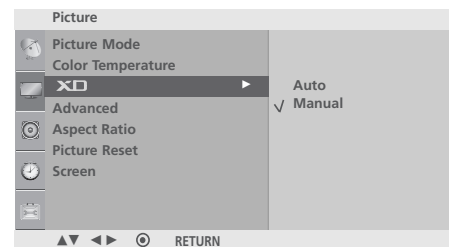

2 3

### \* Manual Selection

When selecting Picture Mode (User1 or User2), you can operate this function.

- 1 Press the **>** button and then **^** or **v** button to select **XD Contrast**, **XD Color** or **XD NR**.
  - **XD Contrast:** Optimizing the contrast automatically according to the brightness of the reflection.
  - **XD Color:** Adjusting the colors of the reflection automatically to reproduce as closely as possible to the natural colors.
  - **XD NR :** Removing the noise up to the point where it does not damage the original picture.
- 2 Press the **>** button and then **^** or **v** button to select **Off**, **Low** or **High**(XD Contrast), **Off**, **Low** or **High**(XD Color), **Off**, **Low**, **High** or **Adaptive**(XD NR).
- 3 Press the **MENU** button to return to TV viewing.  
Press the **RETURN** button to move to the previous menu screen.

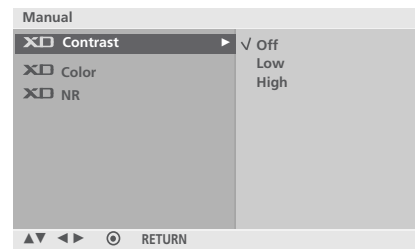

1 2

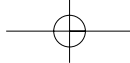

## PICTURE CONTROL

### ADVANCED - GAMMA

High gamma values display whitish images and low gamma values display high contrast images.

It is not possible to use this function in RGB-PC mode.

- 1 Press the **MENU** button and then  $\wedge$  or  $\vee$  button to select the **Picture** menu.

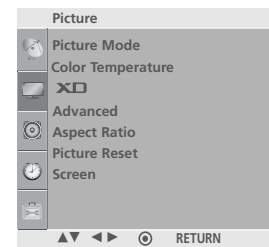

- 2 Press the  $\rightarrow$  button and then  $\wedge$  or  $\vee$  button to select **Advanced**.

- 3 Press the  $\rightarrow$  button and then  $\wedge$  or  $\vee$  button to select **Gamma**.

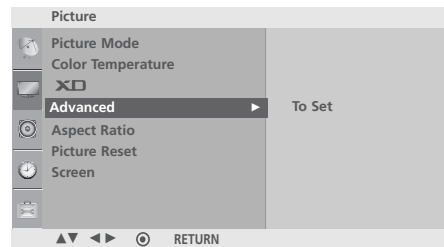

- 4 Press the  $\rightarrow$  button and then  $\wedge$  or  $\vee$  button to select **Low**, **Medium** or **High**.

- 5 Press the **MENU** button to return to TV viewing.  
Press the **RETURN** button to move to the previous menu screen.

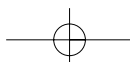
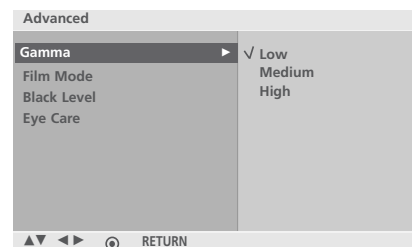

## ADVANCED - FILM MODE

To set the TV up for the best picture quality for viewing films.

This feature operates only in Analog TV, AV, S-video and Component 480i/576i mode.

1 Press the **MENU** button and then  $\wedge$  or  $\vee$  button to select the **Picture** menu.

2 Press the  $\triangleright$  button and then  $\wedge$  or  $\vee$  button to select **Advanced**.

3 Press the  $\triangleright$  button and then  $\wedge$  or  $\vee$  button to select **Film Mode**.

4 Press the  $\triangleright$  button and then  $\wedge$  or  $\vee$  button to select **On** or **Off**.

5 Press the **MENU** button to return to TV viewing.  
Press the **RETURN** button to move to the previous menu screen.

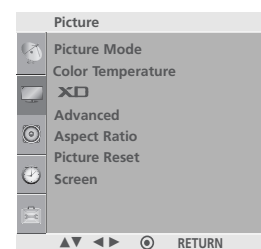

1

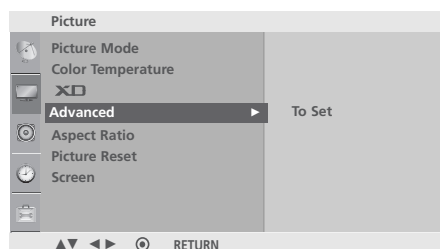

2 3

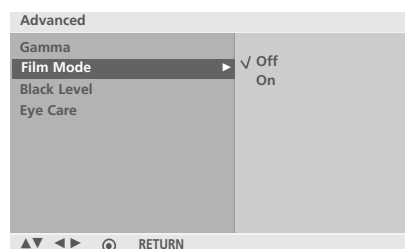

4

## PICTURE CONTROL

### ADVANCED - BLACK(DARKNESS) LEVEL

When you view a film this function adjust the TV to best picture quality. Adjusting the contrast and the brightness of the screen using the black level of the screen.

1 Press the **MENU** button and then  $\wedge$  or  $\vee$  button to select the **Picture** menu.

2 Press the  $\rightarrow$  button and then  $\wedge$  or  $\vee$  button to select **Advanced**.

3 Press the  $\rightarrow$  button and then  $\wedge$  or  $\vee$  button to select **Black Level**.

4 Press the  $\rightarrow$  button and then  $\wedge$  or  $\vee$  button to select **Low** or **High**.

■ **Low** : The reflection of the screen gets darker.

■ **High** : The reflection of the screen gets brighter.

5 Press the **MENU** button to return to TV viewing.  
Press the **RETURN** button to move to the previous menu screen.

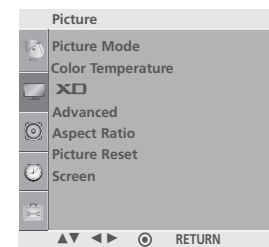

1

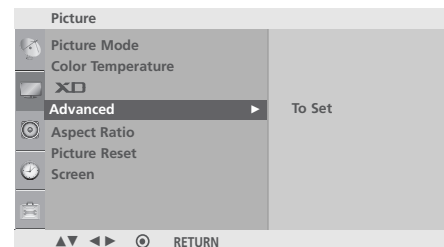

2 3

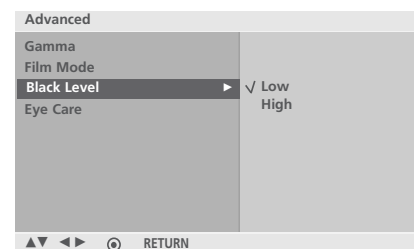

4



## ADVANCED - EYE CARE - *Only LCD TV models*

The Eye Care limits the brightness of the LCD.

It reduces the eye dazzling by lowering the backlight voltage to decrease the brightness if the APL(Average Picture Level) is too high.

When selecting Picture Mode (Standard, Game, Sport, User1 and User2), you can operate this function.

1 Press the **MENU** button and then  $\wedge$  or  $\vee$  button to select the **Picture** menu.

2 Press the  $\>$  button and then  $\wedge$  or  $\vee$  button to select **Advanced**.

3 Press the  $\>$  button and then  $\wedge$  or  $\vee$  button to select **Eye Care**.

4 Press the  $\>$  button and then  $\wedge$  or  $\vee$  button to select **Off** or **On**.

5 Press the **MENU** button to return to TV viewing.  
Press the **RETURN** button to move to the previous menu screen.

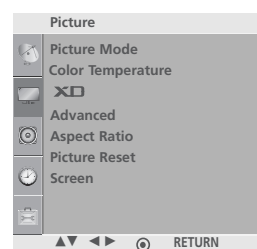

1

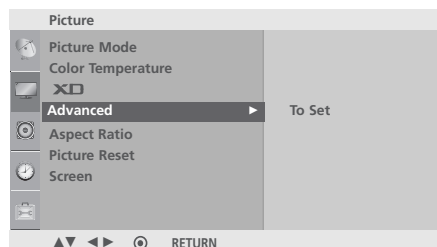

2 3

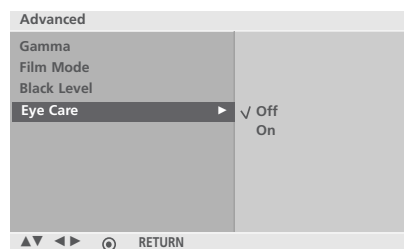

4

# PICTURE CONTROL

## PICTURE RESET

Returns to the default factory setting for Picture Mode, Color Temperature, XD, Advanced, Aspect Ratio.

- 1 Press the **MENU** button and then  $\wedge$  or  $\vee$  button to select the **Picture** menu.
- 2 Press the  $\>$  button and then  $\wedge$  or  $\vee$  button to select **Picture Reset**.
- 3 Press the  $\>$  button to initialize the adjusted value.
- 4 Press the **MENU** button to return to TV viewing.  
Press the **RETURN** button to move to the previous menu screen.

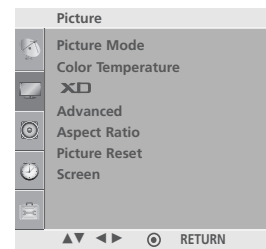

1

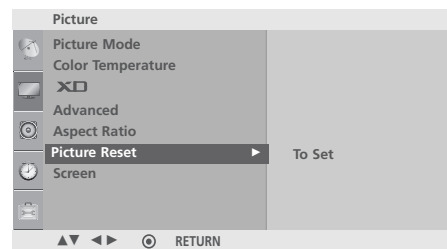

2 3

## POWER INDICATOR - *Only LCD TV models*

It helps you adjust the brightness of moving LED when power is turned on.

- 1 Press the **MENU** button and then  $\wedge$  or  $\vee$  button to select the **Option** menu.
- 2 Press the  $\>$  button and then  $\wedge$  or  $\vee$  button to select **Power Indicator**.
- 3 Press the  $\>$  button to select **Standby Light** or **Power Light**.
- 4 Press the  $\>$  button and then  $\wedge$  or  $\vee$  button to select **On / Off**.
- 5 Press the **MENU** button to return to TV viewing.  
Press the **RETURN** button to move to the previous menu screen.

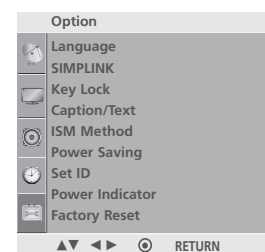

1

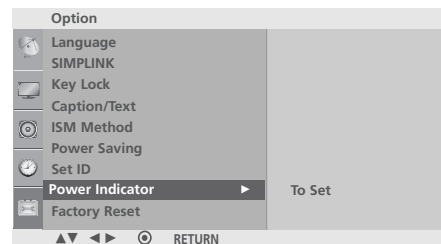

2 3

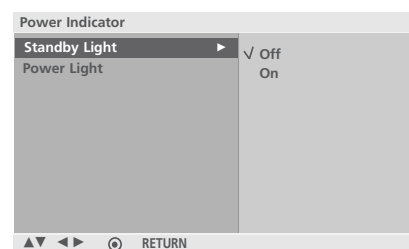

4

## PICTURE CONTROL

### IMAGE STICKING MINIMIZATION(ISM)METHOD

- Only PLASMA TV models

A frozen or still picture from a PC/Video game displayed on the screen for prolonged periods will result in a ghost image remaining even when you change the image. Avoid allowing a fixed image to remain on the screen for prolonged periods.

#### White Wash

White wash removes permanent images from the screen.

Note: An excessive permanent image may be impossible to clear entirely with White Wash.

#### Orbiter

Orbiter may help prevent ghost images. However, it is best not to allow any fixed image to remain on the screen. To avoid a permanent image on the screen, the screen will move every 2 minutes.

#### Inversion

This function inverts the panel color of the screen.

The panel color is automatically inverted every 30 minutes.

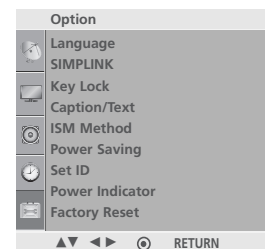

1

1 Press the **MENU** button and then  $\wedge$  or  $\vee$  button to select the **Option** menu.

2 Press the  $\>$  button and then  $\wedge$  or  $\vee$  button to select **ISM Method**.

3 Press the  $\>$  button and then  $\wedge$  or  $\vee$  button to select either **Normal**, **White Wash**, **Orbiter** or **Inversion**.  
If you do not need this function, set **Normal**.

4 Press the **MENU** button to return to TV viewing.  
Press the **RETURN** button to move to the previous menu screen.

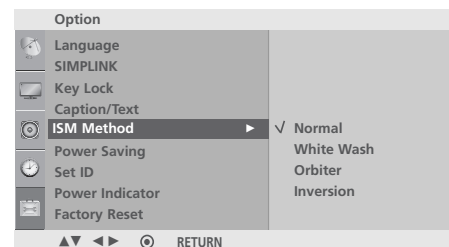

2 3

## POWER SAVING PICTURE MODE

- Only PLASMA TV models

This function allows you to reduce the power consumption of the TV.

- 1 Press the **MENU** button and then  $\wedge$  or  $\vee$  button to select the **Option** menu.
- 2 Press the  $\>$  button and then  $\wedge$  or  $\vee$  button to select **Power Saving**.
- 3 Press the  $\>$  button and then  $\wedge$  or  $\vee$  button to select power levels.
- 4 Press the **MENU** button to return to TV viewing.  
Press the **RETURN** button to move to the previous menu screen.

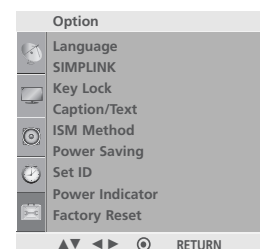

1

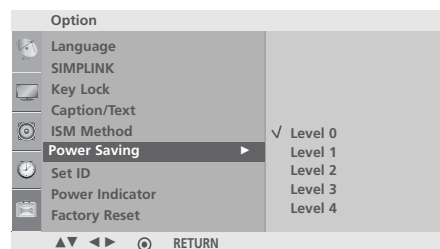

2 3

# PICTURE CONTROL

## FACTORY RESET

Use to quickly reset all the menu options to their original factory preset values.

This function deletes all TV programs.

- 1 Press the **MENU** button and then  $\wedge$  or  $\vee$  button to select the **Option** menu.
- 2 Press the  $\blacktriangleright$  button and then  $\wedge$  or  $\vee$  button to select **Factory Reset**.
- 3 Press the  $\blacktriangleright$  button and then  $\blacktriangleleft$  or  $\blacktriangleright$  button to select **YES** or **NO**.
- 4 Press the **MENU** button to return to TV viewing.  
Press the **RETURN** button to move to the previous menu screen.

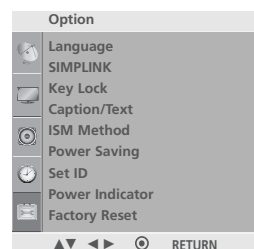

1

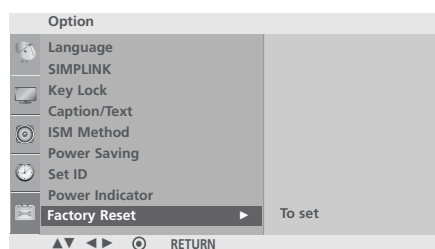

2

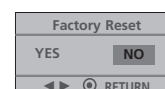

3

# SOUND & LANGUAGE CONTROL

## AUTO VOLUME LEVELER

Auto Volume automatically remains on the same level of volume if you change programs.

- 1 Press the **MENU** button and then  $\wedge$  or  $\vee$  button to select the **Audio** menu.
- 2 Press the  $\triangleright$  button and then  $\wedge$  or  $\vee$  button to select **Auto Volume**.
- 3 Press the  $\triangleright$  button and then  $\wedge$  or  $\vee$  button to select **On** or **Off**.
- 4 Press the **MENU** button to return to TV viewing.  
Press the **RETURN** button to move to the previous menu screen.

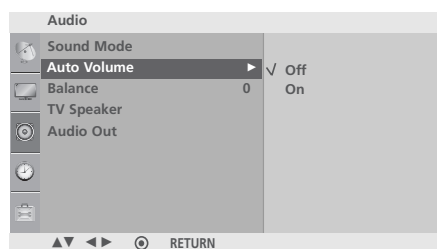
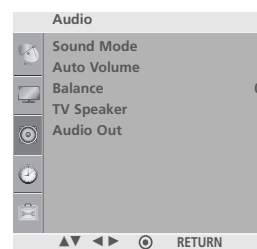

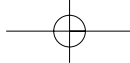

## PRESET SOUND SETTINGS-SOUND MODE

You can select your preferred sound setting; SRS TSXT, Clear Voice, Standard, Music, Cinema, Sport or Game and you can also adjust the frequency of the equalizer.

Sound Mode lets you enjoy the best sound without any Special adjustment as the TV sets the appropriate sound options based on the channel content.

**SRS TSXT, Clear Voice, Standard, Music, Cinema, Sport and Game** are pre-set for optimum sound quality at the factory and are not adjustable.

- Press the **SOUND** button repeatedly to select the appropriate sound setup.  
(Only 42/50PG20\*)

- 1 Press the **MENU** button and then  $\wedge$  or  $\vee$  button to select the **Audio** menu.
- 2 Press the  $\>$  button and then  $\wedge$  or  $\vee$  button to select **Sound Mode**.
- 3 Press the  $\>$  button and then  $\wedge$  or  $\vee$  button to select **SRS TSXT, Clear Voice, Standard, Music, Cinema, Sport, Game** or **User**.
- 4 Press the **MENU** button to return to TV viewing.  
Press the **RETURN** button to move to the previous menu screen.

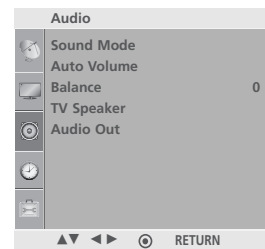

1

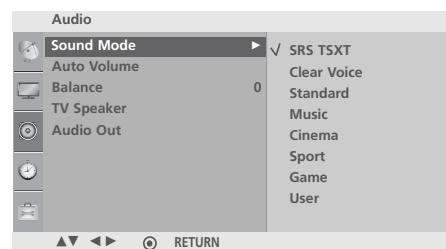

2 3

- ▶ is a trademark of SRS Labs, Inc.
- ▶ TruSurround XT technology is incorporated under license from SRS Labs, Inc.

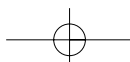



## SOUND SETTING ADJUSTMENT -USER MODE

Adjusting the audio equalizer.

- 1 Press the **MENU** button and then  $\wedge$  or  $\vee$  button to select the **Audio** menu.
- 2 Press the  $\>$  button and then  $\wedge$  or  $\vee$  button to select **Sound Mode**.
- 3 Press the  $\>$  button and then  $\wedge$  or  $\vee$  button to select **User**.
- 4 Press the  $\>$  button.
- 5 Select a frequency band by pressing the  $\lt$  or  $\gt$  button. Set the desired sound level with the  $\wedge$  or  $\vee$  button.
- 6 Press the **MENU** button to return to TV viewing. Press the **RETURN** button to move to the previous menu screen.

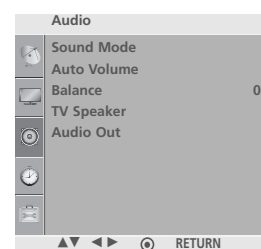

1

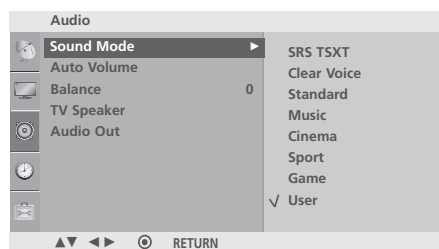

2 3 4

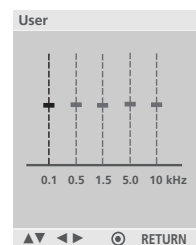

5

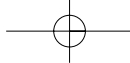

## SOUND & LANGUAGE CONTROL

### BALANCE

You can adjust the sound balance of the speakers to the preferred levels.

- 1 Press the **MENU** button and then  $\wedge$  or  $\vee$  button to select the **Audio** menu.
- 2 Press the  $\triangleright$  button and then  $\wedge$  or  $\vee$  button to select **Balance**.
- 3 Press the  $\triangleright$  button and then  $\triangleleft$  or  $\triangleright$  button to make desired adjustment.
- 4 Press the **MENU** button to return to TV viewing.  
Press the **RETURN** button to move to the previous menu screen.

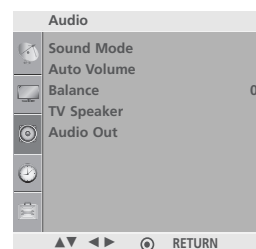

1

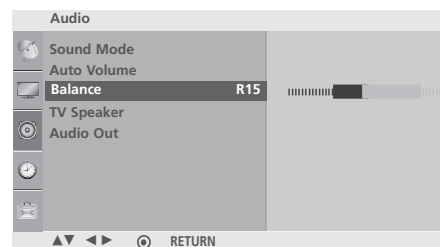

2 3

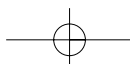

## TV SPEAKERS ON/OFF SETUP

You can adjust the internal speaker status.

In TV, AV, COMPONENT, RGB[PC] and HDMI mode, internal speaker audio can be operational even though there is no video signal.

If you wish to use an external hi-fi system, turn off the TV internal speakers.

- 1 Press the **MENU** button and then  $\wedge$  or  $\vee$  button to select the **Audio** menu.
- 2 Press the  $\>$  button and then  $\wedge$  or  $\vee$  button to select **TV Speaker**.
- 3 Press the  $\>$  button and then  $\wedge$  or  $\vee$  button to select **On** or **Off**.
- 4 Press the **MENU** button to return to TV viewing.  
Press the **RETURN** button to move to the previous menu screen.

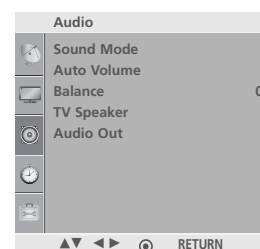

1

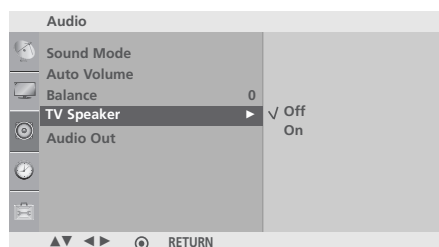

2 3

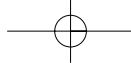

## SOUND & LANGUAGE CONTROL

### SELECTING AUDIO OUT

Select **Monitor Out** or **Variable Out** to connect the audio outputs.

- 1 Press the **MENU** button and then  $\wedge$  or  $\vee$  button to select the **Audio** menu.
- 2 Press the  $\>$  button and then  $\wedge$  or  $\vee$  button to select **Audio Out**.
- 3 Press the  $\>$  button and then  $\wedge$  or  $\vee$  button to select **Monitor Out** or **Variable Out**.
- 4 Press the **MENU** button to return to TV viewing.  
Press the **RETURN** button to move to the previous menu screen.

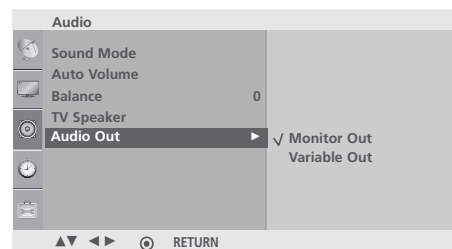
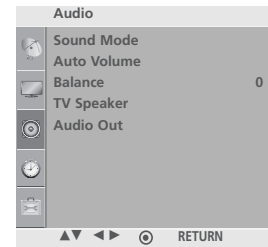

1  
2 3

### ON-SCREEN MENUS LANGUAGE SELECTION

The menus can be shown on the screen in the selected language. First select your language.

- 1 Press the **MENU** button and then use  $\wedge$  or  $\vee$  button to select the **Option** menu.
- 2 Press the  $\>$  button and then use  $\wedge$  or  $\vee$  button to select **Language**.
- 3 Press the  $\>$  button and then use  $\lt$  or  $\gt$  button to select your desired language.
- 4 Press the **ENTER** button.
- 5 Press the **MENU** button to return to TV viewing.  
Press the **RETURN** button to move to the previous menu screen.

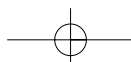

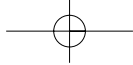

## CLOSED CAPTIONS

Closed captioning is a process which converts the audio portion of a television program into written words which then appear as subtitles on the television screen. Closed captions allow viewers to read the dialogue and narration of television programs.

### Using Closed Captions

Captions are the subtitles of the dialogue and narration of television programs. For prerecorded programs, program dialogue can be arranged into captions in advance. Its possible to caption a live program by using a process called real-time captioning, which creates captions instantly. Real-time captioning is normally done by professional reporters using a machine shorthand

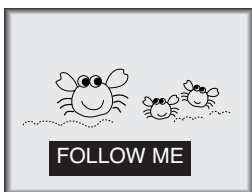

system and computer for translation into English. Captioning is an effective system for the hearing-impaired, and it can also aid in teaching language skills.

- The picture at left shows a typical caption.

### Caption Tips

- Not all TV broadcasts include closed caption signals.
- Sometimes TV stations broadcast four different caption signals on the same channel. By selecting Mode 1 to Mode 2, you can choose which signal you view. Mode 1 is usually the signal with the captions, while another mode might show demonstration or programming information.
- Your TV might not receive caption signals normally in the following situations.

1. Poor reception conditions are encountered:



#### • IGNITION:

Picture may flutter, drift, suffer from black spots, or horizontal streaking. Usually caused by interference from automobile ignition systems, neon lamps, electrical drills, and other electrical appliances.



#### • GHOSTS:

Ghosts are caused when the TV signal splits and follows two paths. One is the direct path and the other is reflected off tall buildings, hills or other objects. Changing the direction or position of the antenna may improve reception.



#### • SNOW:

If your receiver is located at the weak, fringe area of a TV signal, your picture may be marred by small dots. It may be necessary to install a special antenna to improve the picture.

2. An old, bad, or illegally recorded tape is being played.
3. Strong, random signals from a car or airplane interfere with the TV signal.
4. The signal from the antenna is weak.
5. The program wasn't captioned when it was produced, transmitted, or taped.

- 1 Press the **MENU** button and then  $\wedge$  or  $\vee$  button to select the **Option** menu.

- 2 Press the  $\>$  button and then  $\wedge$  or  $\vee$  button to select **Caption/Text**.

- 3 Press the  $\>$  button and then  $\wedge$  or  $\vee$  button to select your caption.

- 4 Press the **MENU** button to return to TV viewing. Press the **RETURN** button to move to the previous menu screen.

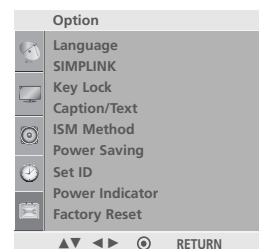

1

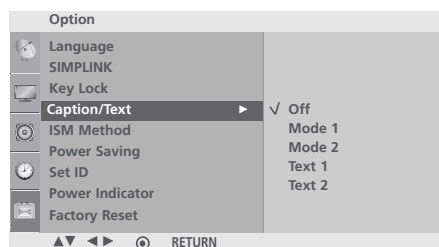

2 3

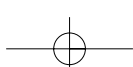

# TIME SETTING

## CLOCK SETUP

You must set the time correctly before using on/off timer function.

If current time setting is erased by a power failure or the TV is unplugged, reset the clock.

- 1 Press the **MENU** button and then  $\wedge$  or  $\vee$  button to select the **Time** menu.

- 2 Press the  $\>$  button and then  $\wedge$  or  $\vee$  button to select **Clock**.

- 3 Press the  $\>$  button and then  $\wedge$  or  $\vee$  button to set the hour.

- 4 Press the  $\>$  button and then  $\wedge$  or  $\vee$  button to set the minute.

- 5 Press the **MENU** button to return to TV viewing.  
Press the **RETURN** button to move to the previous menu screen.

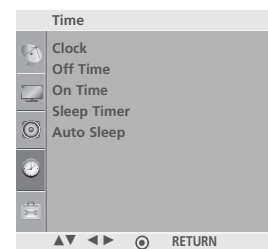

1

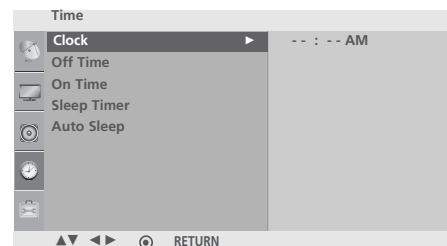

2 3 4

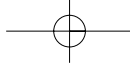

## AUTO ON/OFF TIME SETTING

The Off time function automatically switches the TV to standby at a preset time.

Two hours after the TV is switched on by the on time function it will automatically switch back to standby mode unless a button has been pressed.

Once the on time/off time is set, these functions operate daily at the preset time.

The Off time function overrides the On time function if both are set to the same time.

The TV must be in standby mode for the On time to work.

- 1 Press the **MENU** button and then  $\wedge$  or  $\vee$  button to select the **Time** menu.

- 2 Press the  $\>$  button and then  $\wedge$  or  $\vee$  button to select **On/Off Time**.

- To cancel **On/Off Time** function, select **Off**.

- 3 Press the  $\>$  button and then  $\wedge$  or  $\vee$  button to set the hour.

- 4 Press the  $\>$  button and then  $\wedge$  or  $\vee$  button to set the minutes.

- 5 **For On Time function only**

- **Channel:** Press the  $\>$  button and then  $\wedge$  or  $\vee$  button to select the channel.
- **Volume:** Press the  $\>$  button and then  $\wedge$  or  $\vee$  button to adjust volume level at switch-on.

- 6 Press the **MENU** button to return to TV viewing.  
Press the **RETURN** button to move to the previous menu screen.

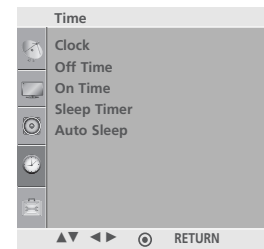

1

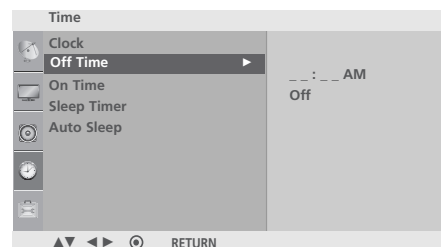

2 3 4

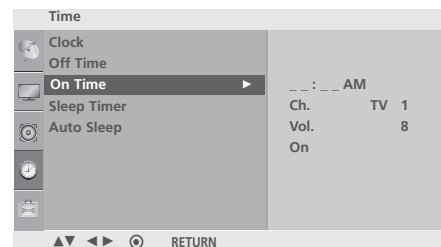

2 3 4 5

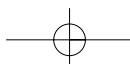
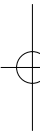

## TIME SETTING

### SLEEP TIMER SETTING

You do not have to remember to switch the TV off before you go to sleep. The sleep timer automatically switches the TV to standby after the preset time has elapsed.

- 1 Press the **MENU** button and then  $\wedge$  or  $\vee$  button to select the **Time** menu.
- 2 Press the  $\rightarrow$  button and then  $\wedge$  or  $\vee$  button to select **Sleep Timer**.
- 3 Press the  $\rightarrow$  button and then  $\wedge$  or  $\vee$  button to set the minute.
- 4 Press the **MENU** button to return to TV viewing.  
Press the **RETURN** button to move to the previous menu screen.

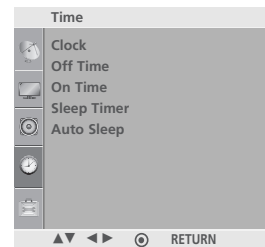

1

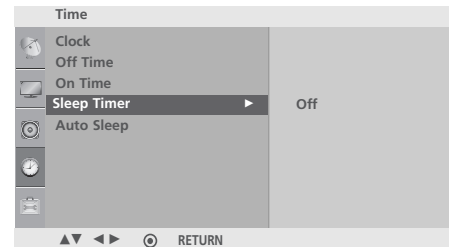

2 3 4

#### ! NOTE

- ▶ When you switch the TV off, the TV releases the preset sleep timer.



## AUTO SHUT-OFF SETTING

If the TV set is switched on and there is no input signal, it will switch off automatically after 10 minutes.

1 Press the **MENU** button and then  $\wedge$  or  $\vee$  button to select the **Time** menu.

2 Press the  $\>$  button and then  $\wedge$  or  $\vee$  button to select **Auto Sleep**.

3 Press the  $\>$  button and then  $\wedge$  or  $\vee$  button to select **On** or **Off**.

4 Press the **MENU** button to return to TV viewing.  
Press the **RETURN** button to move to the previous menu screen.

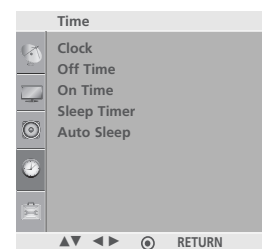

1

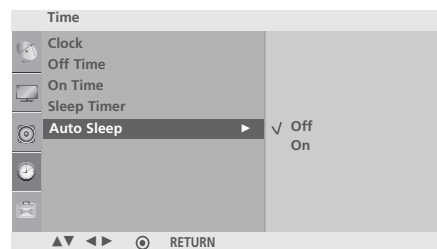

2 3

# APPENDIX

## TROUBLESHOOTING

### The TV does not operate properly

#### The remote control does not work

- Check to see if there is any object between the TV and the remote control causing an obstruction.
- Are batteries installed with correct polarity (+ to +, - to -)?
- Correct remote operating mode set: TV, STB etc.?
- Install new batteries.

#### Power is suddenly turned off

- Is the sleep time set?
- Check the power control settings. Has the Power supply been interrupted.
- Is Auto sleep activated on this station.

### The video function does not work.

#### No picture & No sound

- Check whether the TV is switched on.
- Try another channel. The problem may be with the broadcast.
- Is the power cord inserted correctly into the mains?
- Check your antenna direction and/or location.
- Test the mains outlet by plugging another TV into the same outlet.

#### Picture appears slowly after switching on

- This is normal, the image is muted during the TV startup process. Please contact your service center, if the picture has not appeared after five minutes.

#### No or poor color or poor picture

- Adjust Color in menu option.
- Allow a sufficient distance between the TV and the VCR.
- Try another channel. The problem may be with the broadcast.
- Are the video cables installed properly?
- Activate any function to restore the brightness of the picture.

#### Horizontal/vertical bars or picture shaking

- Check for local interference such as an electrical appliance or power tool.

#### Poor reception on some channels

- Station or cable channel experiencing problems, tune to another station.
- Station signal is weak, reposition the antenna to receive weaker stations.
- Check for sources of possible interference.

#### Lines or streaks in pictures

- Check antenna (Change the position of the antenna).

#### No picture when connecting HDMI

- Check HDMI cable over version 1.3.  
The HDMI cables don't support HDMI version 1.3, it cause flickers or no screen display. In this case use the latest cables that support HDMI version 1.3. (Some models)

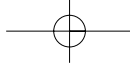

The audio function does not work.	
<b>Picture ENTER &amp; No sound</b>	<ul style="list-style-type: none"> <li>■ Press the <b>VOL+/- (or Volume)</b> button.</li> <li>■ Sound muted? Press <b>MUTE</b> button.</li> <li>■ Try another channel. The problem may be with the broadcast.</li> <li>■ Are the audio cables installed properly?</li> </ul>
<b>No output from one of the speakers</b>	<ul style="list-style-type: none"> <li>■ Adjust Balance in menu option.</li> </ul>
<b>Unusual sound from inside the TV</b>	<ul style="list-style-type: none"> <li>■ A change in ambient humidity or temperature may result in an unusual noise when the TV is switched on or off and does not indicate a fault with the TV.</li> </ul>
<b>No sound when connecting HDMI/USB</b>	<ul style="list-style-type: none"> <li>■ Check HDMI cable over version 1.3.</li> <li>■ Check USB cable over version 2.0.</li> <li>■ Use normal MP3 file. <span style="float: right;">(Some models)</span></li> </ul>

There is a problem in PC mode. (Only PC mode applied)	
<b>The signal is out of range.</b>	<ul style="list-style-type: none"> <li>■ Adjust resolution, horizontal frequency, or vertical frequency.</li> <li>■ Check the input source.</li> </ul>
<b>Vertical bar or stripe on background &amp; Horizontal Noise &amp; Incorrect position</b>	<ul style="list-style-type: none"> <li>■ Use Auto configure or adjust clock, phase, or H/V position.</li> </ul>
<b>Screen color is unstable or single color</b>	<ul style="list-style-type: none"> <li>■ Check the signal cable.</li> <li>■ Reinstall the PC video card.</li> </ul>

## MAINTENANCE

Early malfunctions can be prevented. Careful and regular cleaning can prolong the life of your new TV.

**Caution:** Be sure to switch the power off and unplug the power cord before you begin any cleaning.

### Cleaning the Screen

- 1 A good way to keep the dust off your screen for a while is to wet a soft cloth in a mixture of lukewarm water and a little fabric softener or dish washing detergent. Wring the cloth until it's almost dry, and then use it to wipe the screen.
- 2 Ensure there is no excess water on the screen. Allow any water or dampness to evaporate before switching on.

### Cleaning the Cabinet

- To remove dirt or dust, wipe the cabinet with a soft, dry, lint-free cloth.
- Do not use a wet cloth.

### Extended Absence

#### ⚠ CAUTION

- ▶ If you expect to leave your TV dormant for prolonged periods (such as a holiday), unplug the power cord to protect against possible damage from lightning or power surges.

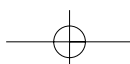

## APPENDIX

## PRODUCT SPECIFICATIONS

<b>42PG20R</b> (42PG20R-MA)	Width x Height x Depth (inches/mm)	With Stand	40.9 x 28.7 x 12.1 inches 1040.0 x 731.3 x 308.0 mm
		Without Stand	40.9 x 26.6 x 3.3 inches 1040.0 x 677.0 x 86.0 mm
	Weight (pounds / kg)	With Stand	60.1 pounds / 27.3 kg
		Without Stand	53.8 pounds / 24.4 kg
<b>50PG20R</b> (50PG20R-MA)	Width x Height x Depth (inches/mm)	With Stand	48.2 x 33.4 x 14.3 inches 1224.7 x 849.0 x 364.0 mm
		Without Stand	48.2 x 31.1 x 3.3 inches 1224.7 x 790.0 x 86.0 mm
	Weight (pounds / kg)	With Stand	92.1 pounds / 41.8kg
		Without Stand	83.3 pounds / 37.8 kg
Power requirement	AC100-240V ~ 50/60Hz		
Television System	NTSC, PAL-M/N		
Program Coverage	VHF 2-13, UHF 14-69, CATV 1-125		
External Antenna Impedance	75 ohm		
Operating Temperature Range	32 ~ 104°F (0 ~ 40°C)		
Operating Humidity Range	Less than 80%		
Storage Temperature Range	-4 ~ 140°F (-20 ~ 60°C)		
Storage Humidity Range	Less than 85%		

- The specifications shown above may be changed without prior notice for quality improvement.

<b>26LG30R</b> (26LG30R-MA)	Width x Height x Depth (inches/mm)	With Stand	26.1 x 20.0 x 8.9 inches 663.3 x 508.2 x 227.3 mm
		Without Stand	26.1 x 17.7 x 3.1 inches 663.3 x 449.8 x 80.0 mm
	Weight (pounds / kg)	With Stand	22.2 pounds / 10.1 kg
		Without Stand	18.9 pounds / 8.6 kg
<b>32LG30R</b> (32LG30R-MA)	Width x Height x Depth (inches/mm)	With Stand	31.5 x 23.7 x 8.9 inches 801.8 x 604.2 x 227.3 mm
		Without Stand	31.5 x 21.4 x 3.1 inches 801.8 x 544.1 x 79.0 mm
	Weight (pounds / kg)	With Stand	29.5 pounds / 13.4 kg
		Without Stand	26.2 pounds / 11.9 kg
<b>37LG30R</b> (37LG30R-MA)	Width x Height x Depth (inches/mm)	With Stand	36.2 x 26.8 x 11.5 inches 919.6 x 682.3 x 293.8 mm
		Without Stand	36.2 x 24.0 x 3.5 inches 919.6 x 610.3 x 89.0 mm
	Weight (pounds / kg)	With Stand	41.4 pounds / 18.8 kg
		Without Stand	35.7 pounds / 16.2 kg
<b>42LG30R</b> (42LG30R-MA)	Width x Height x Depth (inches/mm)	With Stand	40.6 x 29.2 x 11.5 inches 1032.8 x 742.3 x 293.8 mm
		Without Stand	40.6 x 26.3 x 3.6 inches 1032.8 x 670.1 x 92.0 mm
	Weight (pounds / kg)	With Stand	52.0 pounds / 23.6 kg
		Without Stand	46.2 pounds / 21.0 kg
<b>47LG30R</b> (47LG30R-MA)	Width x Height x Depth (inches/mm)	With Stand	45.1 x 31.7 x 13.5 inches 1146.0 x 805.8 x 342.9 mm
		Without Stand	45.1 x 28.8 x 4.0 inches 1146.0 x 732.8 x 103.0 mm
	Weight (pounds / kg)	With Stand	65.0 pounds / 29.5 kg
		Without Stand	54.8 pounds / 24.9 kg
<b>42LG50FR</b> (42LG50FR-MA)	Width x Height x Depth (inches/mm)	With Stand	40.6 x 35.2 x 11.5 inches 1032 x 894.8 x 293.8 mm
		Without Stand	40.6 x 26.1 x 3.5 inches 1032 x 662.3 x 89mm
	Weight (pounds / kg)	With Stand	57.8 pounds / 26.2 kg
		Without Stand	51.8 pounds / 23.5 kg
Power requirement	AC100-240V ~ 50/60Hz		
Television System	NTSC, PAL-M/N		
Program Coverage	VHF 2-13, UHF 14-69, CATV 1-125		
External Antenna Impedance	75 ohm		
Operating Temperature Range	32 ~ 104°F (0 ~ 40°C)		
Operating Humidity Range	Less than 80%		
Storage Temperature Range	-4 ~ 140°F (-20 ~ 60°C)		
Storage Humidity Range	Less than 85%		

■ The specifications shown above may be changed without prior notice for quality improvement.

## APPENDIX

### PROGRAMMING THE REMOTE CONTROL

The remote control is a multi brand or universal remote. It can be programmed to operate most remote controlled devices from other manufacturers.

Note that the remote control may not control all models from other brands.

#### Programming a code into a remote mode

- 1 Testing your remote control.  
To find out whether your remote control can operate other components without programming, turn on a component such as a VCR and press the corresponding mode button (such as a **DVD** or **STB**) on the remote control, while pointing at the component. Test the **POWER** and **CH**  $\wedge/\vee$  buttons to see if the component responds correctly. If the component does not operate correctly, the remote control requires programming to operate the device.
- 2 Switch on the component to be programmed, then press the corresponding mode button (such as a **DVD** or **STB**) on the remote control. The remote control button of the desired device is illuminated.
- 3 Press the **MENU** and **MUTE** buttons simultaneously, the remote control is ready to be programmed with the code.
- 4 Enter a code number using the number buttons on the remote control. Programming code numbers for the corresponding component can be found on the following pages. If the code is correct, the device will turn off.
- 5 Press the **MENU** button to store the code.
- 6 Test the remote control functions to see if the component responds correctly. If not, repeat from step 2.

## Programming code

(This feature is not available for all models.)

### DVD

Brand	Codes	Brand	Codes	Brand	Codes
APEX DIGITAL	022	mitsubishi	002	RCA	005 006
DENON	020 014	NAD	023	SAMSUNG	011 015
GE	005 006	ONKYO	008 017	SONY	007
HARMAN KARDON	027	PANASONIC	003 009	THOMPSON	005 006
JVC	012	PHILIPS	013	TOSHIBA	019 008
LG	001 010 016 025	PIONEER	004 026	YAMAHA	009 018
MAGNAVOX	013	PROCEED	021	ZENITH	010 016 025
MARANTZ	024	PROSCAN	005 006		

### HDSTB

Brand	Codes	Brand	Codes	Brand	Codes
ALPHASTAR DSR	123	HOUSTON TRACKER	033 037 039 051	REALISTIC	043 074
AMPLICA	050		057 104	SAMSUNG	123
Astro Philips(ML)	159	HUGHES	068	SATELLITE SERVICE CO	028 035 047 057
Astro Thompson(ML)	160	Humax(SL)	158		085
Astro Nokia(ML)	161	JANIEL	060 147	Samart(TH)	156
BIRDVIEW	051 126 129	JERROLD	061	SCIENTIFIC ATLANTA	032 138
CHANNEL MASTER	013 014 015 018	KATHREIN	108	SONY	103
	036 055	LEGEND	057	STARCAST	041
CHAPARRAL	008 009 012 077	LG	001	SUPER GUIDE	020 124 125
CITOH	054	LUTRON	132	TEECOM	023 026 075 087
CURTIS MATHES	050 145	LUXOR	062 144		088 090 107 130
DRAKE	005 006 007 010	MACOM	010 059 063 064		137
	011 052 112 116		065	TOSHIBA	002 127
	141	MEMOREX	057	True Vision(TH)	155
DX ANTENNA	024 046 056 076	NEXTWAVE	028 124 125	UBC(TH)	153
ECHOSTAR	038 040 057 058	NORSAT	069 070	UBC/SAMART(TH)	154
	093 094 095 096	PACE SKY SATELLITE	143	UNIDEN	016 025 042 043
	097 098 099 100	PANASONIC	060 142		044 045 048 049
	122	PANSAT	121		078 079 080 086
ELECTRO HOME	089	PERSONAL CABLE	117		10 135 136
EUROPLUS	114	PHILIPS	071	VIEWSTAR	115
FUJITSU	017 021 022 027	PICO	105	VTC(VN)	162
	133 134	PRESIDENT	019 102	WINEGARD	128 146
GENERAL INSTRUMENT	003 004 016 029	PRIMESTAR	030 110 111	ZENITH	081 082 083 084
	031 059 101	PROSAT	072		091 120
HITACHI	139 140	PSI(TH)	157		
		RCA	066 106		

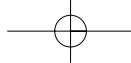

# APPENDIX

## IR CODES

### 1. How to Connect

- Connect your wired remote control to the Remote Control port on the TV.

### 2. Remote Control IR Codes

#### ■ Output waveform

Single pulse, modulated with 37.917KHz signal at 455KHz

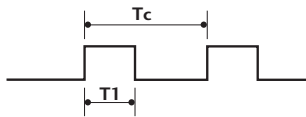

Carrier frequency  
 $FCAR = 1/TC = fOSC/12$   
 Duty ratio =  $T1/TC = 1/3$

#### ■ Configuration of frame

1st frame

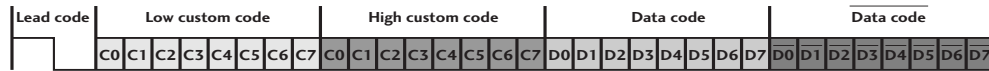

Repeat frame

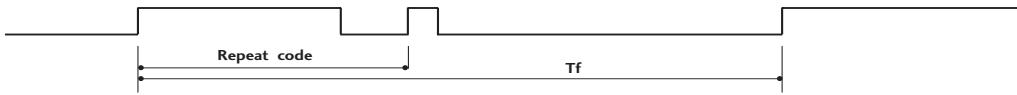

#### ■ Lead code

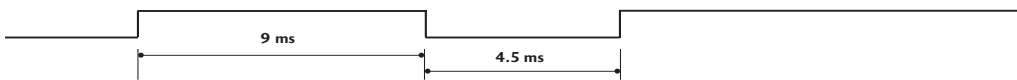

#### ■ Repeat code

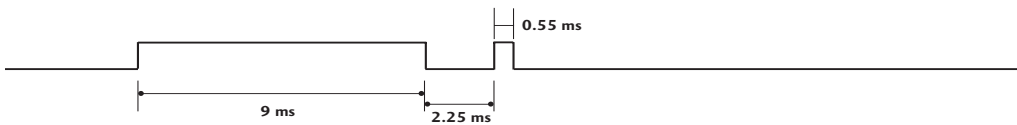

#### ■ Bit description



#### ■ Frame interval: Tf

The waveform is transmitted as long as a key is depressed.

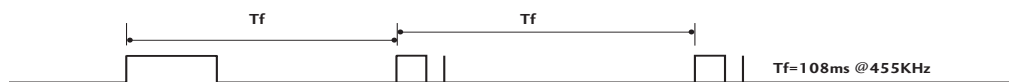

APPENDIX

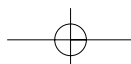



Code (Hexa)	Function	Note	Code (Hexa)	Function	Note
0B	INPUT	R/C Button	09	MUTE	R/C Button
08	POWER	R/C Button (Power On/Off)	10 ~ 19	Number Key 0 ~ 9	R/C Button
60	PIP	R/C Button	1E	FAV	R/C Button
43	MENU	R/C Button	1A	Q.VIEW	R/C Button
5B	RETURN	R/C Button	7E	SIMPLINK	R/C Button
07	<	R/C Button	B1	■ Stop	R/C Button
06	>	R/C Button	B0	▶ Play	R/C Button
40	^	R/C Button	BA	Pause	R/C Button
41	∨	R/C Button	8F	◀◀ Rew	R/C Button
44	ENTER	R/C Button	8E	▶▶ FF	R/C Button
02	VOL +	R/C Button	BD	●(Record)	R/C Button
03	VOL -	R/C Button	45	Q.MENU	R/C Button
00	CH ^	R/C Button			
01	CH ∨	R/C Button			
30	AV MODE	R/C Button			

## APPENDIX

### EXTERNAL CONTROL THROUGH RS-232C

(Except 42LG50\*\*)

Connect the RS-232C input jack to an external control device (such as a computer or an A/V control system) and control the TV's functions externally.

Connect the serial port of the control device to the RS-232C jack on the TV back panel. RS-232C connection cables are not supplied with the TV.

#### RS-232C Setup

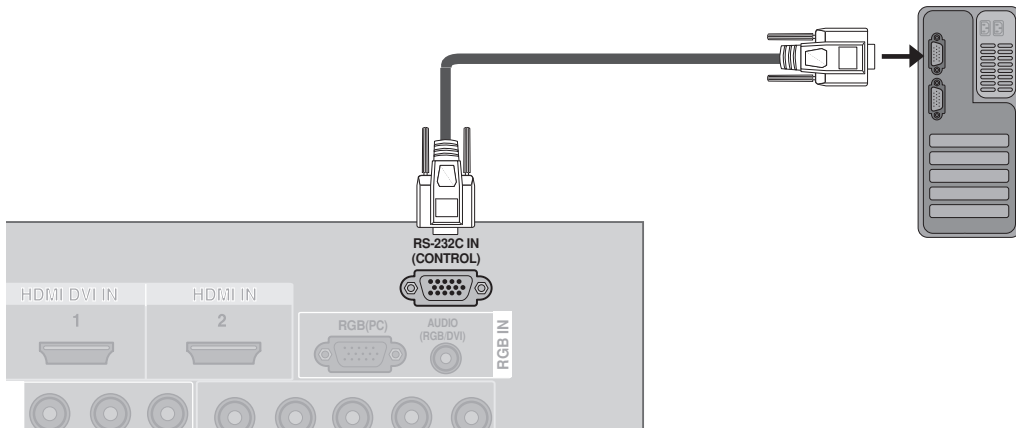

#### Type of Connector; D-Sub 9-Pin Male

No.	Pin Name
1	No connection
2	RXD (Receive data)
3	TXD (Transmit data)
4	DTR (DTE side ready)
5	GND
6	DSR (DCE side ready)
7	RTS (Ready to send)
8	CTS (Clear to send)
9	No Connection

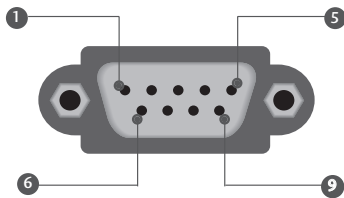

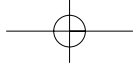

## RS-232C Configurations

### 7-Wire Configurations (Standard RS-232C cable)

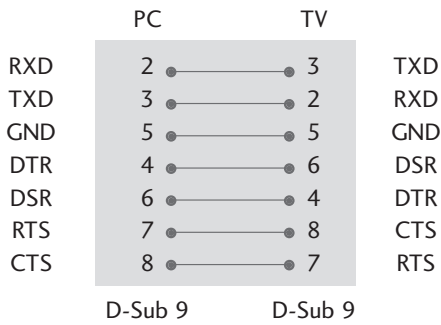

### 3-Wire Configurations(Not standard)

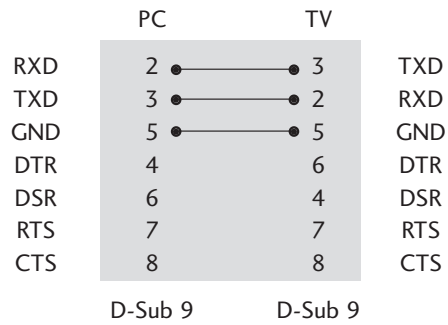

## Set ID

Use this function to specify a set ID number.  
Refer to 'Real Data Mapping'1. ▶ p.93.

- 1 Press the **MENU** button and then use  $\wedge$  or  $\vee$  button to select the **Option** menu.
- 2 Press the  $\>$  button and then use  $\wedge$  or  $\vee$  button to select **Set ID**.
- 3 Press the  $\>$  button and then use  $\wedge$  or  $\vee$  button to adjust **Set ID** to choose the desired TV ID number.
  - The adjustment range of SET ID is 1~99.
- 4 Press the **MENU** button to return to TV viewing.  
Press the **RETURN** button to move to the previous menu screen.

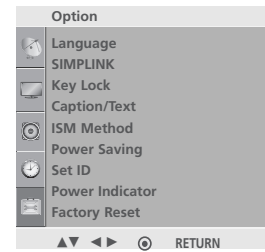

1

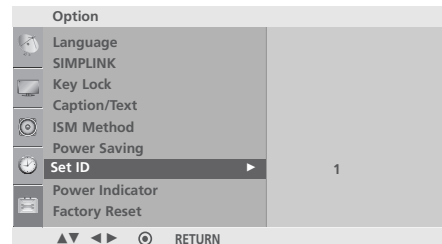

2 3

APPENDIX

## Communication Parameters

- Baud rate : 9600 bps (UART)
- Data length : 8 bits
- Parity : None
- Stop bit : 1 bit
- Communication code : ASCII code
- Use a crossed (reverse) cable.

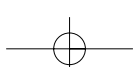

# APPENDIX

## Command Reference List

	COMMAND1	COMMAND2	DATA (Hexadecimal)		COMMAND1	COMMAND2	DATA (Hexadecimal)
01. Power	k	a	00 ~ 01	15. Balance	k	t	00 ~ 64
02. Aspect Ratio	k	c	(▶ p.91)	16. Color Temperature	k	u	00 ~ 03
03. Screen Mute	k	d	00 ~ 01	17. Red Adjustment	k	v	00 ~ 3C
04. Volume Mute	k	e	00 ~ 01	18. Green Adjustment	k	w	00 ~ 3C
05. Volume Control	k	f	00 ~ 64	19. Blue Adjustment	k	\$	00 ~ 3C
06. Contrast	k	g	00 ~ 64	20. Abnormal Status	k	z	FF
07. Brightness	k	h	00 ~ 64	21. ISM Method	j	p	00 ~ 03
08. Color	k	i	00 ~ 64	22. Power Saving	j	q	00 ~ 04
09. Tint	k	j	00 ~ 64	23. Auto Configure	j	u	01
10. Sharpness	k	k	00 ~ 64	24. Equalize	j	v	(▶ p.93)
11. OSD Select	k	l	00 ~ 01	25. Tune Command	m	a	(▶ p.94)
12. Remote Control lock /Key Lock mode	k	m	00 ~ 01	26. Channel Add/Del	m	b	00 ~ 01
13. PIP/DW	k	n	00 ~ 03	27. Key	m	c	Key Code
14. PIP Position	k	q	00 ~ 03	28. Input select (Main)	x	b	(▶ p.95)
				29. Input select (PIP)	x	y	(▶ p.95)
				30. Control Backlight	m	g	0 ~ 64

Only Plasma TV Models

Only LCD TV Models

## Transmission / Receiving Protocol

### Transmission

[Command1][Command2][ ][Set ID][ ][Data][Cr]

[Command 1] : First command to control the set.(j,k,m or x)

[Command 2] : Second command to control the set.

[Set ID] : You can adjust the set ID to choose desired TV ID number in Setup menu. Adjustment range is 1~99. When selecting Set ID '0', every connected TV is controlled. Set ID is indicated as decimal (1~99) on menu and as Hexa decimal (0x0~0x63) on transmission/receiving protocol.

[DATA] : To transmit command data.

Transmit 'FF' data to read status of comand.

[Cr] : Carriage Return

ASCII code '0x0D'

[ ] : ASCII code 'space (0x20)'

### OK Acknowledgement

[Command2][ ][Set ID][ ][OK][Data][x]

The TV transmits ACK (acknowledgement) based on this format when receiving normal data. At this time, if the data is data read mode, it indicates present status data. If the data is data write mode, it returns the data of the PC computer.

### Error Acknowledgement

[Command2][ ][Set ID][ ][NG][Data][x]

TV transmits ACK(acknowledgement) based on this format when receiving abnormal data form non-viable functions or communication errors.

[Command 2] : use as command.

[Set ID]: use the small character, if set ID is 10, TV will send the '0', 'a'

[Data]: use the small character, if data is 0xab, TV will send the 'a', 'b'.

[NG]: use the large character.

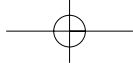

### 01. Power (Command: k a)

To control Power On/Off of the TV.

*Transmission* [k][a][ ][Set ID][ ][Data][Cr]

Data 00 : Power Off      Data 01 : Power On

*Acknowledgement* [a][ ][Set ID][ ][OK/NG][Data][x]

To show Power On/Off.

*Transmission* [k][a][ ][Set ID][ ][FF][Cr]

*Acknowledgement* [a][ ][Set ID][ ][OK/NG][Data][x]

\* If there is the time delay between command and ack message during power on sequence, It should be described like "Note: In this model, TV will send the Acknowledge after power on processing completion. There might be a time delay between command and acknowledge."

### 02. Aspect Ratio (Command: k c) (Main picture size)

To adjust the screen format. (Main picture format)

You can adjust the screen format using the Aspect Ratio in the Picture menu.

*Transmission* [k][c][ ][Set ID][ ][Data][Cr]

Data 01 : Normal screen (4:3)      Data 05: Zoom2

Data 02: Wide screen (16:9)      Data 09: Just Scan

Data 04: Zoom1

*Acknowledgement* [c][ ][Set ID][ ][OK/NG][Data][x]

\* Using the RGB-PC, Component or HDMI input, you select either 16:9 or 4:3 screen aspect ratio.

\* Just Scan works in the following mode:

Component (720p/1080i/1080p),

HDMI (720p/1080i/1080p)

### 03. Screen Mute (Command: k d)

To select screen mute on/off.

*Transmission* [k][d][ ][Set ID][ ][Data][Cr]

Data 00 : Screen mute off (Picture on)

Data 01 : Screen mute on (Picture off)

*Acknowledgement* [d][ ][Set ID][ ][OK/NG][Data][x]

### 04. Volume Mute (Command: k e)

To control volume mute on/off.

You can also adjust mute using the MUTE button on remote control.

*Transmission* [k][e][ ][Set ID][ ][Data][Cr]

Data 00 : Volume mute on (Volume off)

Data 01 : Volume mute off (Volume on)

*Acknowledgement* [e][ ][Set ID][ ][OK/NG][Data][x]

### 05. Volume Control (Command: k f)

To adjust volume.

You can also adjust volume with the volume buttons on remote control.

*Transmission* [k][f][ ][Set ID][ ][Data][Cr]

Data Min : 00 ~ Max : 64

Refer to 'Real data mapping 1'. See page 93.

*Acknowledgement* [f][ ][Set ID][ ][OK/NG][Data][x]

### 06. Contrast (Command: k g)

To adjust screen contrast.

You can also adjust contrast in the Picture menu.

*Transmission* [k][g][ ][Set ID][ ][Data][Cr]

Data Min : 00 ~ Max : 64

Refer to 'Real data mapping 1'. See page 93.

*Acknowledgement* [g][ ][Set ID][ ][OK][Data][x]

### 07. Brightness (Command: k h)

To adjust screen brightness.

You can also adjust brightness in the Picture menu.

*Transmission* [k][h][ ][Set ID][ ][Data][Cr]

Data Min : 00 ~ Max : 64

Refer to 'Real data mapping 1'. See page 93.

*Acknowledgement* [h][ ][Set ID][ ][OK/NG][Data][x]

### 08. Color (Command: k i)

To adjust the screen color.

You can also adjust color in the Picture menu.

*Transmission* [k][i][ ][Set ID][ ][Data][Cr]

Data Min : 00 ~ Max : 64

Refer to 'Real data mapping 1'. See page 93.

*Acknowledgement* [i][ ][Set ID][ ][OK/NG][Data][x]

### 09. Tint (Command: k j)

To adjust the screen tint.

You can also adjust tint in the Picture menu.

*Transmission* [k][j][ ][Set ID][ ][Data][Cr]

Data Red : 00 ~ Green : 64

Refer to 'Real data mapping 1'. See page 93.

*Acknowledgement* [j][ ][Set ID][ ][OK/NG][Data][x]

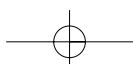

# APPENDIX

## 10. Sharpness (Command: k k)

To adjust the screen sharpness.

You can also adjust sharpness in the Picture menu.

*Transmission* [k][k][ ][Set ID][ ][Data][Cr]

Data Min: 00 ~ Max: 64

Refer to 'Real data mapping 1'. See page 93.

*Acknowledgement* [k][ ][Set ID][ ][OK/NG][Data][x]

## 11. OSD Select (Command: k l)

To select OSD (On Screen Display) on/off when controlling remotely.

*Transmission* [k][l][ ][Set ID][ ][Data][Cr]

Data 00: OSD off

Data 01: OSD on

*Acknowledgement* [l][ ][Set ID][ ][OK][Data][x]

## 12. Remote Control Lock/Key Lock Mode (Command: k m)

To lock the remote control and the front panel controls on the set.

*Transmission* [k][m][ ][Set ID][ ][Data][Cr]

Data 00: Lock off

Data 01: Lock on

*Acknowledgement* [m][ ][Set ID][ ][OK/NG][Data][x]

If you are not using the remote control and front panel controls on the TV, use this mode. When main power is on/off, remote control lock is released.

## 13. PIP / DW (Command: k n)

To control the PIP (Picture In picture)/DW.

You can also control the PIP/DW using the PIP button on the remote control or in the PIP/DW menu.

*Transmission* [k][n][ ][Set ID][ ][Data][Cr]

Data 00: PIP/DW off

Data 01: PIP

Data 02: DW1

Data 03: DW2

*Acknowledgement* [n][ ][Set ID][ ][OK/NG][Data][x]

## 14. PIP Position (Command: k q)

To select sub picture position for PIP.

You can also adjust the sub picture position using PIP button on the remote control or in the PIP/DW menu.

*Transmission* [k][q][ ][Set ID][ ][Data][Cr]

Data 00: Right down on screen

Data 01: Left down on screen

Data 02: Left up on screen

Data 03: Right up on screen

*Acknowledgement* [q][ ][Set ID][ ][OK/NG][Data][x]

## 15. Balance (Command: k t)

To adjust balance.

You can also adjust balance in the Audio menu.

*Transmission* [k][t][ ][Set ID][ ][Data][Cr]

Data Min: 00 ~ Max: 64

Refer to 'Real data mapping 1'. See page 93.

*Acknowledgement* [t][ ][Set ID][ ][OK/NG][Data][x]

## 16. Color Temperature (Command: k u)

To adjust color temperature.

You can also adjust Color Temperature in the Picture menu.

*Transmission* [k][u][ ][Set ID][ ][Data][Cr]

Data 00: Medium 01: Cool 02: Warm 03: User

*Acknowledgement* [u][ ][Set ID][ ][OK/NG][Data][x]

## 17. Red Adjustment (Command: k v)

To adjust red in color temperature.

*Transmission* [k][v][ ][Set ID][ ][Data][Cr]

Data Min: 00 ~ Max: 3C

Refer to 'Real data mapping 2'. See page 93.

*Acknowledgement* [v][ ][Set ID][ ][OK/NG][Data][x]

## 18. Green Adjustment (Command: k w)

To adjust green in color temperature.

*Transmission* [k][w][ ][Set ID][ ][Data][Cr]

Data Min: 00 ~ Max: 3C

Refer to 'Real data mapping 2'. See page 93.

*Acknowledgement* [w][ ][Set ID][ ][OK/NG][Data][x]

## 19. Blue Adjustment (Command: k \$)

To adjust blue in color temperature.

*Transmission* [k][\$][ ][Set ID][ ][Data][Cr]

Data Min: 00 ~ Max: 3C

Refer to 'Real data mapping 2'. See page 93.

*Acknowledgement* [\$][ ][Set ID][ ][OK/NG][Data][x]

### 20. Abnormal State (Command: k z)

To recognize an abnormal state.

*Transmission* [k][z][ ][Set ID][ ][FF][ ][Cr]

Data FF: Read

*Acknowledgement* [z][ ][Set ID][ ][OK/NG][Data][x]

- Data 00: Normal (Power on and signal exist)
- Data 01: No signal (Power on)
- Data 02: Turn the TV off by remote control
- Data 03: Turn the TV off by sleep time function
- Data 04: Turn the TV off by RS-232C function
- Data 05: 5V down
- Data 06: AC down
- Data 07: Turn the TV off by Fan Alarm function (option)
- Data 08: Turn the TV off by Off time function
- Data 09: Turn the TV off by Auto off function
- Data a: Turn the TV off by AV board detection.

\* This function is "read only".

### 21. ISM Method (Command: j p)

To avoid having a fixed image remain on screen.

*Transmission* [j][p][ ][Set ID][ ][Data][Cr]

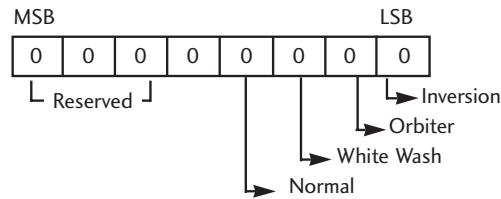

7	6	5	4	3	2	1	0	Function
				0	0	0	1	Inversion
				0	0	1	0	Orbiter
				0	1	0	0	White wash
				1	0	0	0	Normal
x	x	x	x					Reserved

\*More two kinds of function can not be set at a time.

*Acknowledgement* [p][ ][Set ID][ ][OK/NG][Data][x]

### 22. Low Power(Power Saving) (Command: j q)

To reduce the power consumption of the TV.

*Transmission* [j][q][ ][Set ID][ ][Data][ ][Cr]

Data Min: 00 ~ Max: 04 (\*transmit by Hexadecimal code)

*Acknowledgement* [q][ ][Set ID][ ][OK/NG][Data][x]

### 23. Auto Configure (Command: j u)

To adjust picture position and minimize image shaking automatically. It works only in RGB (PC) mode.

*Transmission* [j][u][ ][Set ID][ ][Data][Cr]

Data 01: To set

*Acknowledgement* [u][ ][Set ID][ ][OK/NG][Data][x]

#### \* Real data mapping 1

- 00 : Step 0
- ⋮
- A : Step 10
- ⋮
- F : Step 15
- 10 : Step 16
- ⋮
- 64 : Step 100
- ⋮
- 6E : Step 110
- ⋮
- 73 : Step 115
- 74 : Step 116
- ⋮
- C7 : Step 199
- ⋮
- FE : Step 254
- FF : Step 255

#### \* Real data mapping 2

- 00: -30
- 01: -29
- 02: -28
- ⋮
- 1E: 0
- ⋮
- 28: +10
- ⋮
- 3A: +28
- 3B: +29
- 3C: +30
- ⋮
- 4E: N/A
- 4F: N/A
- 50: N/A

### 24. Equalize(Command: j v)

▶ To adjust equalize.

*Transmission* [j][v][ ][Set ID][ ][Data][Cr]

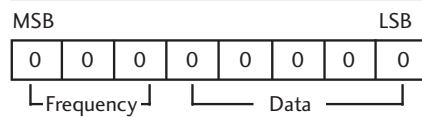

7	6	5	Frequency	4	3	2	1	0	Step
0	0	0	1'st Band	0	0	0	0	0	0(decimal)
0	0	1	2'st Band	0	0	0	0	1	1(decimal)
0	1	0	3'st Band	0	0	0	1	0	2(decimal)
0	1	1	4'st Band						...
1	0	0	5'st Band						
1	0	1	6'st Band						
1	1	0	7'st Band	1	1	1	1	0	30(decimal)
1	1	1	8'st Band	1	1	1	1	1	31(decimal)

*Acknowledgement* [v][ ][Set ID][ ][OK/NG][Data][x]

# APPENDIX

## 25 . Tune Command (Command: m a)

Tune Channel to following Physical/major/minor number

*Transmission* [m][a][ ][Set ID][ ][Data0][ ][Data1]  
[ ][Data2][ ][Data3][ ][Data4][ ][Data5][Cr]

Data 0: Physical Channel Number(Transmit by Hexadecimal code)

NTSC air: 02~45

NTSC cable: 01, 0e~7d

Data1, Data2: Major Channel Number(two part) or Channel Number(one part)

Data1: High byte

Data2: Low byte

Two part channel number: Major number-Minor number

One part channel number:

In case of using one part channel number, minor channel does not need.

Data3, Data4: Minor Channel Number

Not needed for NTSC.

Data3: High byte

Data4: Low byte

Data5:

Attribute

7	Main/Sub Picture	6	Two/One Part Channel	5	Using Physical Channel	4	Reserved	3	2	1	0	Step
0	Main	0	Two	0	Use	x	0	0	0	0	0	NTSC air
1	Sub	1	One	1	No Use	x	0	0	0	0	1	NTSC cable

### \* Two/One part Channel: 6<sup>th</sup> bit

This bit is used in a cable-ready system.

### \* Using physical channel: 5<sup>th</sup> bit

If the channel band is NTSC air or NTSC cable, channel tuning can be done by only physical channel. In this case, using physical channel bit must be low(0).

Example)

1. Analog channel: NTSC cable, channel number(35), main picture

Command: ma 00 23 xx xx xx xx 01

attribute(0x01): main picture, two part(it's not mandatory), using physical channel, NTSC cable xx' data: don't care major and minor channel number in case analog channel tuning

*Acknowledgement*[a][ ][Set ID][ ][OK][Data0][Data1]  
[Data2][Data3][Data4][Data5][x][a][ ][Set ID]  
[ ][NG][Data0][x]



**26. Channel Add/Del(Command: m b)**

► To add and delete the channels.

```
Transmission [m][b][ ][Set ID][ ][Data][Cr]
Data 0: Delete      Data 1: Add
Acknowledgement [b][ ][Set ID][ ][OK/NG][Data][x]
```

**27. Key Code (Command: m c)**

To send IR remote key code.

```
Transmission [m][c][ ][Set ID][ ][Data][Cr]
Data: Key code - Refer to page 87.
Acknowledgement [c][ ][Set ID][ ][OK/NG][Data][x]
```

**28. Input select (Command: x b)**  
**(Main Picture Input)**

To select input source for TV.

```
Transmission [x][b][ ][Set ID][ ][Data][Cr]
Data: Structure
```

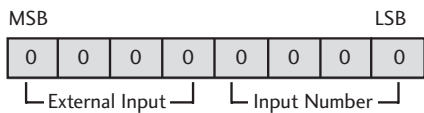

External Input				Data
0	0	0	1	Analog
0	0	1	0	AV
0	1	0	0	Component
0	1	1	0	RGB-PC
1	0	0	1	HDMI

Input Number				Data
0	0	0	0	Input1
0	0	0	1	Input2
0	0	1	0	Input3
0	0	1	1	Input4

```
Acknowledgement [b][ ][Set ID][ ][OK/NG][Data][x]
```

**29. PIP Input select (Command: x y)**

To adjust input source for sub picture in PIP mode.

```
Transmission [x][y][ ][Set ID][ ][Data][Cr]
Data: Structure
```

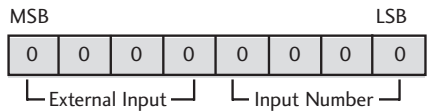

External Input				Data
0	0	0	1	Analog
0	0	1	0	AV

Input Number				Data
0	0	0	0	Input1
0	0	0	1	Input2
0	0	1	0	Input3
0	0	1	1	Input4

```
Acknowledgement [y][ ][Set ID][ ][OK/NG][Data][x]
```

**30. Control Backlight (Command : m g)**

Only LCD TV Models

To control the back light.

```
Transmission [m][g][ ][Set ID][ ][Data][Cr]
Data: Min : 00H ~ Max : 64H
Acknowledgement [g][ ][Set ID][ ][OK][Data][x]
Data: Min : 00H ~ Max : 64H
```

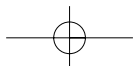
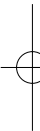
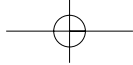

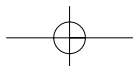
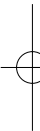
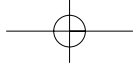

**LG Electronics Inc.**

