

User's Guide

L226WU

Make sure to read the **Important Precautions** before using the product.
Keep the User's Guide(CD) in an accessible place for future reference.

See the label attached on the product and give the information to your dealer when you ask for service.

This unit has been engineered and manufactured to ensure your personal safety, however improper use may result in potential electrical shock or fire hazards. In order to allow the proper operation of all safeguards incorporated in this display, observe the following basic rules for its installation, use, and servicing.

On Safety

Use only the power cord supplied with the unit. In case you use another power cord, make sure that it is certified by the applicable national standards if not being provided by the supplier. If the power cable is faulty in any way, please contact the manufacturer or the nearest authorized repair service provider for a replacement.

The power supply cord is used as the main disconnection device. Ensure that the socket-outlet is easily accessible after installation.

Operate the display only from a power source indicated in the specifications of this manual or listed on the display. If you are not sure what type of power supply you have in your home, consult with your dealer.

Overloaded AC outlets and extension cords are dangerous. So are frayed power cords and broken plugs. They may result in a shock or fire hazard. Call your service technician for replacement.

Do not Open the Display.

- There are no user serviceable components inside.
- There are Dangerous High Voltages inside, even when the power is OFF.
- Contact your dealer if the display is not operating properly.

To Avoid Personal Injury :

- Do not place the display on a sloping shelf unless properly secured.
- Use only a stand recommended by the manufacturer.
- Do not drop an object on or apply impact to the product. Do not throw any toys or objects on the product screen.
It can cause injury to human, problem to product and damage the display.

To Prevent Fire or Hazards:

- Always turn the display OFF if you leave the room for more than a short period of time. Never leave the display ON when leaving the house.
- Keep children from dropping or pushing objects into the display's cabinet openings. Some internal parts carry hazardous voltages.
- Do not add accessories that have not been designed for this display.
- When the display is to be left unattended for an extended period of time, unplug it from the wall outlet.
- In the presence of thunder and lightning, never touch the power cord and signal cable because it can be very dangerous. It can cause electric shock.

On Installation

Do not allow anything to rest upon or roll over the power cord, and do not place the display where the power cord is subject to damage.

Do not use this display near water such as near a bathtub, washbowl, kitchen sink, laundry tub, in a wet basement, or near a swimming pool.

Displays are provided with ventilation openings in the cabinet to allow the release of heat generated during operation. If these openings are blocked, built-up heat can cause failures which may result in a fire hazard. Therefore, NEVER:

- Block the bottom ventilation slots by placing the display on a bed, sofa, rug, etc.
- Place the display in a built-in enclosure unless proper ventilation is provided.
- Cover the openings with cloth or other material.
- Place the display near or over a radiator or heat source.

Do not rub or strike the Active Matrix LCD with anything hard as this may scratch, mar, or damage the Active Matrix LCD permanently.

Do not press the LCD screen with your finger for a long time as this may cause some afterimages.

Some dot defects may appear as Red, Green or Blue spots on the screen. However, this will have no impact or effect on the display performance.

If possible, use the recommended resolution to obtain the best image quality for your LCD display. If used under any mode except the recommended resolution, some scaled or processed images may appear on the screen. However, this is characteristic of the fixed-resolution LCD panel.

On Cleaning

- Unplug the display before cleaning the face of the display screen.
- Use a slightly damp (not wet) cloth. Do not use an aerosol directly on the display screen because over-spraying may cause electrical shock.

On Repacking

- Do not throw away the carton and packing materials. They make an ideal container in which to transport the unit. When shipping the unit to another location, repack it in its original material.

On Disposal

- The fluorescent lamp used in this product contains a small amount of mercury.
- Do not dispose of this product with general household waste.
Disposal of this product must be carried out in accordance to the regulations of your local authority.

Connecting the Display

- Before setting up the monitor, ensure that the power to the monitor, the computer system, and other attached devices is turned off.

Connecting the stand base

1. Place the monitor with its front facing downward on a cushion or soft cloth.
2. Rotate the Stand Body as shown in figure ①.

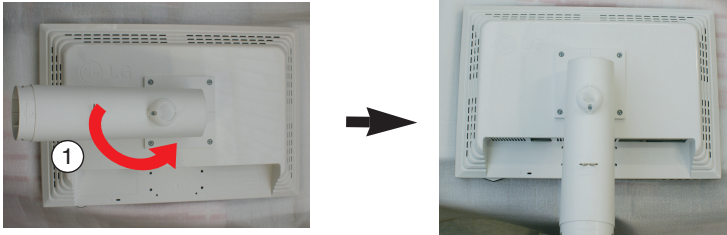

3. Assemble the Stand Base(Front, Rear) into the Stand Body in the correct direction.
4. Once assembled take the monitor up carefully and face the front side

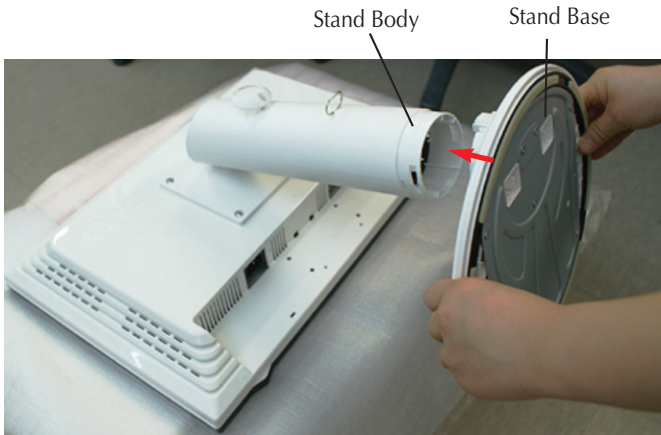

Warning

- The tape and locking pin may only be removed from those monitors equipped with a standing base when the base is pulled up. Otherwise, you may be injured by the protruding sections of the stand.

Disassembling the stand

1. Put a cushion or soft cloth on a flat surface.



2. Place the monitor face Down on the cushion or soft cloth.



3. Pushing Latch inside, Take the stand base from stand body.

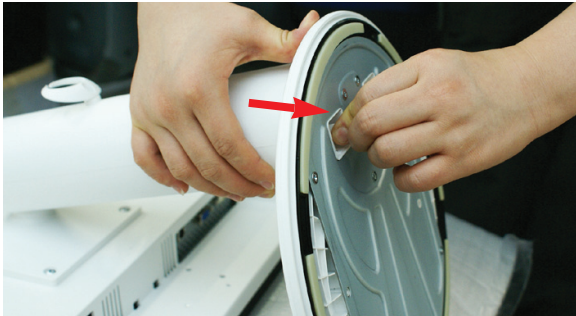

Important

- This illustration depicts the general model of connection. Your monitor may differ from the items shown in the picture.
- Do not carry the product upside down holding only the stand base. The product may fall and get damaged or injure your foot.

Connecting the Display

- Before setting up the monitor, ensure that the power to the monitor, the computer system, and other attached devices is turned off.

Positioning your display

1. Adjust the position of the panel in various ways for maximum comfort.

■ Tilt Range : -3° ~ 17°

■ Swivel : 356°

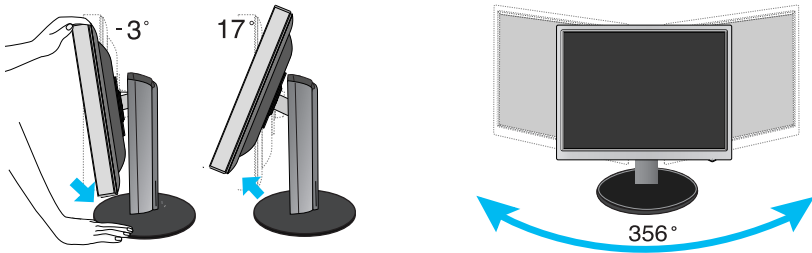

■ Height Range : maximum 5.51 inch (140.0mm)

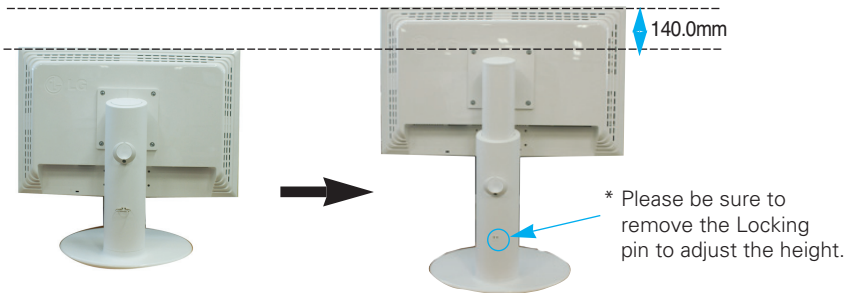

Ergonomic

- It is recommended that in order to maintain an ergonomic and comfortable viewing position, the forward tilt angle of the monitor should not exceed 5 degrees.
- You do not need to replace the Locking pin after it is removed, to adjust its height.

Using the Computer

1. Make sure to turn off the computer and product.
Connect signal input cable ① and power cable ② in order, then tighten the screw of the signal cable.

- Ⓐ Connect DVI Cable
- Ⓑ Connect D-sub Cable
- Ⓒ Connect USB Cable

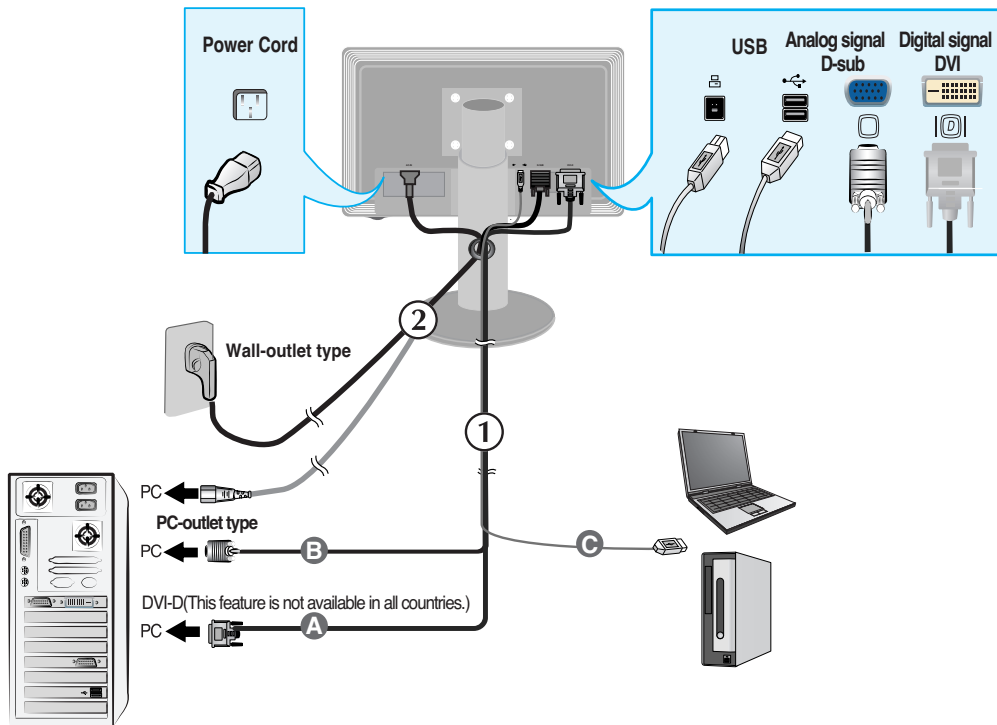

2. Press  button on the front switch panel to turn the power on.
When monitor power is turned on, the **'Self Image Setting Function'** is executed automatically.
(Only Analog Mode)

PROCESSING SELF
IMAGE SETTING

NOTE

'Self Image Setting Function'? This function provides the user with optimal display settings. When the user connects the monitor for the first time, this function automatically adjusts the display to optimal settings for individual input signals. If you want to adjust the monitor while in use, or wish to manually run this function once again, push the 'AUTO/SET' button on the front panel of the monitor. Otherwise, you may execute the 'Factory reset' option on the OSD adjustment menu. However, be aware that this option initializes all the menu items except 'Language'.

Connecting the USB(Universal Serial Bus) Cable

1. Plug in the USB cable as in the diagram.

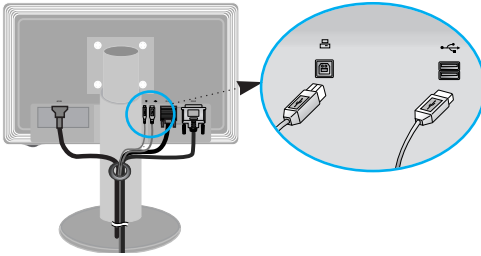

One USB Upstream port

Two USB Downstream ports

Connect to downstream connectors of desktop or laptop computers, mouse, memory stick or USB hard disk. (However, the computer must support USB and have the USB port.)

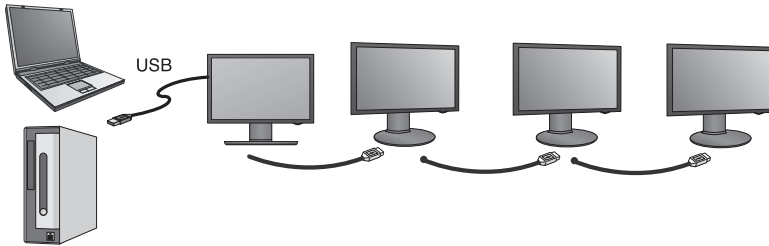

Tidying USB (Universal Serial Bus) Cable

1. Elevate the monitor as far as possible follow the arrow to rotate, and plug the USB cable into the monitor.

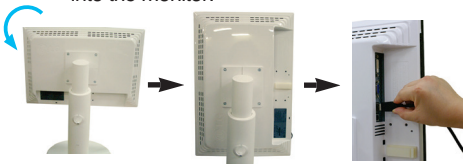

2. Tidy the USB cable as in the diagram, press(follow the arrow) the cable holder, and open it.

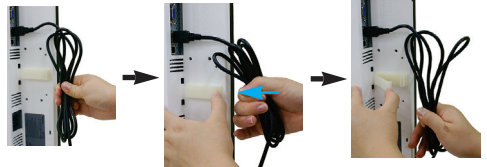

3. Fit the USB cable into the cable holder as in the diagram.

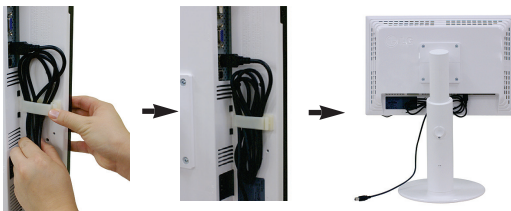

■ When connecting multi screens



Use USB programs

- The display feature can be used by easily connecting the USB cable between laptops/desktops and the USB port at the back of the monitor.
- **System Requirements**
In order to make full use of USB Display features, your computer must meet the following minimum system requirements:
 - 1.2 GHz CPU or higher, 512 MB memory or higher (Recommended Specifications: 1.6 GHz Core2 Duo CPU, 1 GB memory)
 - USB 2.0 Interface
 - Windows 2000 (Service Pack 4), Windows XP (Service Pack 2) Operating Systems (O/S) are supported. (But, Windows 98, ME, NT, Vista, Macintosh, Linux Operating Systems (O/S) are not supported.)

1. Connect the USB cable as shown in the picture and press the 'SOURCE' button on the front of the monitor to select the main display.
2. "LG USB Easy Connection" driver installation automatically starts.
Before installation, make sure your computer meets the minimum system requirements of **Windows 2000 (Service Pack 4) and Windows XP (Service Pack 2)**. If your computer fails to meet those requirements, update the operating systems at <http://www.microsoft.com>.

When the "LG USB Easy Connection" program does not install automatically, please install the driver manually as shown below.

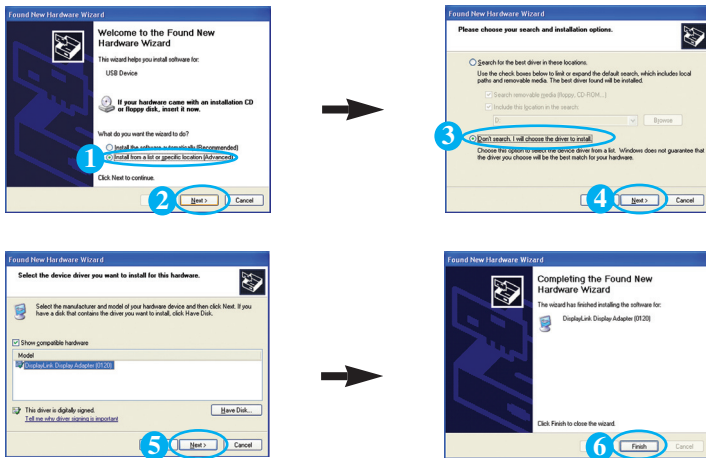

If your computer fails to meet the system requirements, the warning message "DisplayLink Core Software" will be displayed. Press the [OK] button, and continue to install "LG USB Easy Connection" program.

3. Install "LG USB Easy Connection" program as the instruction message says, fully remove the USB cable, and then reboot your computer. Without rebooting, "LG USB Easy Connection" will not operate properly. For more detailed information on installation and removal, refer to the accompanied <LG USB Easy Connection Installation Guide>.

4. When the installation of "LG USB Easy Connection" program is completed, icons as shown in the picture will be created in the taskbar. With these icons, you can easily use features such as Screen Resolution, Color Quality, Screen Rotation, Extend To, Extend and Mirror.

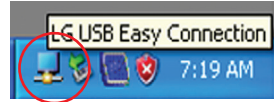

- **Screen Resolution** : Provides information on the resolution that the USB supports.

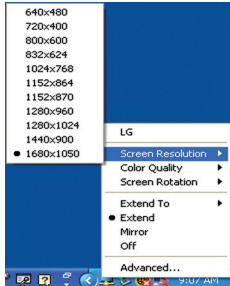

- **Color Quality** : You can choose 16 bit or 32 bit colors.

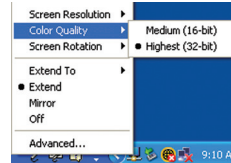

- **Screen Rotation** : You can set the direction to display USB images. (Pivot function)
* When there is an input USB signal, you can use Pivot programs on GUI.

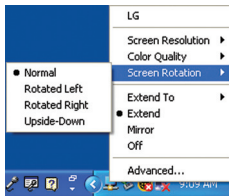

1. Lift the monitor to its highest height to utilize the Pivot function.

2. Landscape & Portrait : You can rotate the panel 90° clockwise. Please be cautious and avoid contact between the monitor head and the Stand Base when rotating the screen to access the Pivot function. If the monitor head touches the Stand Base, then the Stand Base could crack.

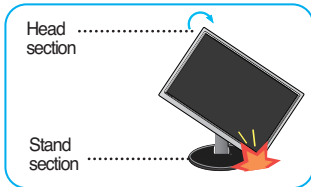

3. When rotating the monitor, be careful with the connected cables.

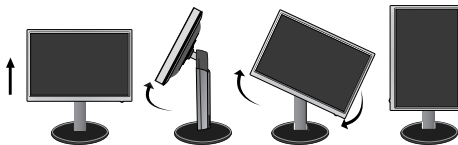

- **Extend To** : Sets the location to display USB images.
(1: Standard monitor, 3: USB Monitor)

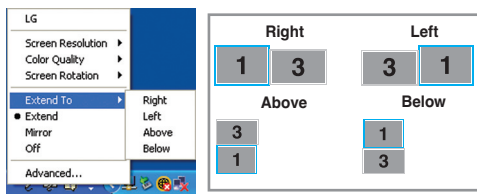

- **Extend** : Expands the display to a sub screen.
- **Mirror** : Shows the same display as the main screen.
- **Off** : Does not to display data to make sure USB screen is not displayed.

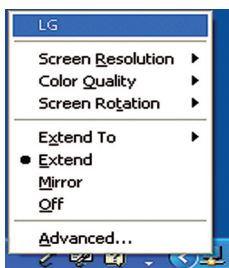

5. When using multiple USB monitors, you can set "LG USB Easy Connection" program separately for each monitor.

① In case of USB dual monitors.

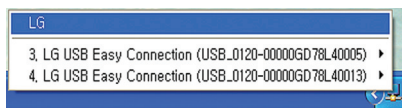

② Select No. 3 USB monitor and use "LG USB Easy Connection" features.



NOTE

- In a monitor to monitor connection, with one USB up to five are possible with direction connection, and up to six are possible with parallel connection.
- With the USB cable unconnected, you will not have any trouble using the PC.
- Monitor and USB Display connectors support USB 2.0 High Speed.
- Does not support DOS game (StarCraft) and other 3D games.
- For more information on USB, visit the following web site. (<http://www.usb.org>)
- 'LG USB Easy Connection' program may be changed without notice for the purpose of product improvement.

Front Panel Controls

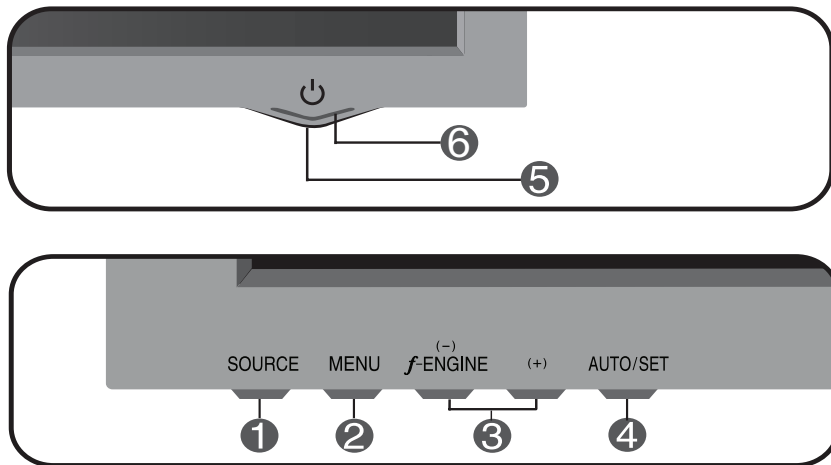

-
- 1 SOURCE Button** You can select the computer that you want to use by selecting input signal (DVI, D-Sub or USB). The default input signal is analogue (D-Sub).

-
- 2 MENU Button** Use this button to enter or exit the On Screen Display.

OSD LOCKED/UNLOCKED

This function allows you to lock the current control settings, so that they cannot be inadvertently changed. Press and hold the **MENU button** for several seconds. The message "**OSD LOCKED**" should appear.

You can unlock the OSD controls at any time by pushing the **MENU button** for several seconds. The message "**OSD UNLOCKED**" should appear.



-
- 3 - + Buttons** Use these buttons to select or adjust functions in the On Screen Display.
-

f•ENGINE (-) For more information, refer to page A19.

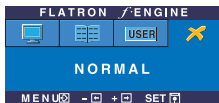

-
- 4 AUTO/SET Button** Use this button to enter a selection in the On Screen Display.
-

AUTO IMAGE ADJUSTMENT

When adjusting your display settings, always press the **AUTO/SET** button before entering the On Screen Display(OSD). This will automatically adjust your display image to the ideal settings for the current screen resolution size (display mode).



The best display mode is

- 22 inch monitor : **1680 x 1050**

- 5 Power Button** Use this button to turn the display on or off.
-

- 6 Power Indicator** This Indicator lights up blue when the display operates normally(On Mode). If the display is in Sleep Mode (Energy Saving), this indicator color changes to amber.
-

Screen Adjustment

Making adjustments to the image size, position and operating parameters of the display is quick and easy with the On Screen Display Control system. A short example is given below to familiarize you with the use of the controls. The following section is an outline of the available adjustments and selections you can make using the OSD.

NOTE

- Allow the display to stabilize for at least 30 minutes before making image adjustments.

To make adjustments in the On Screen Display, follow these steps:

MENU → - + → AUTO/SET → - + → MENU

- 1** Press the **MENU Button**, then the main menu of the OSD appears.
- 2** To access a control, use the **- or + Buttons**. When the icon you want becomes highlighted, press the **AUTO/SET Button**.
- 3** Use the **- /+ Buttons** to adjust the image to the desired level. Use the **AUTO/SET Button** to select other sub-menu items.
- 4** Push the **MENU Button** once to return to the main menu to select another function. Push the **MENU Button** twice to exit from the OSD.

On Screen Display(OSD) Selection and Adjustment

The following table indicates all the On Screen Display control, adjustment, and setting menus.

Main menu	Sub-menu		A	D	USB	Reference
PICTURE	BRIGHTNESS		●	●	●	To adjust the brightness, contrast and gamma of the screen
	CONTRAST		●	●	●	
	GAMMA		●	●	●	
COLOR	PRESET	sRGB	●	●	●	To customize the color of the screen
		6500K	●	●	●	
		9300K	●	●	●	
	RED		●	●	●	
	GREEN		●	●	●	
	BLUE		●	●	●	
POSITION	HORIZONTAL		●			To adjust the position of the screen
	VERTICAL		●			
TRACKING	CLOCK		●			To improve the clarity and stability of the screen
	PHASE		●			
	SHARPNESS		●	●	●	
SETUP	LANGUAGE		●	●	●	To customize the screen status for a user's operating environment
	OSD	HORIZONTAL	●	●	●	
		VERTICAL	●	●	●	
	WHITE BALANCE		●			
	POWER INDICATOR		●	●	●	
	FACTORY RESET		●	●	●	
	ARC		●	●	●	
FLATRON F-ENGINE	MOVIE/TEXT		●	●	●	To select or customize desired image settings
	USER		●	●	●	
	NORMAL		●	●	●	
			● : Adjustable			
			A : Analog Input			
			D : Digital Input			
			USB: Digital Input			

NOTE

- The order of icons may differ depending on the model (A14~A19).

You were introduced to the procedure of selecting and adjusting an item using the OSD system. Listed below are the icons, icon names, and icon descriptions of the all items shown on the Menu.

Press the MENU Button, then the main menu of the OSD appears.

The screenshot shows the OSD menu with the following elements:

- Menu Name:** PICTURE
- Icons:** A vertical list of icons on the left side, including a monitor, RGB, a monitor with a plus sign, a monitor with a minus sign, and a gear.
- Sub-menus:** BRIGHTNESS (value 50), CONTRAST (value 50), and GAMMA (value 0). Each sub-menu has a horizontal bar with a minus sign on the left and a plus sign on the right.
- Button Tip:** A grey box at the bottom containing the following information:
 - MENU : Exit
 - - + : Adjust (Decrease/Increase)
 - SET : Enter
 - : Select another sub-menu

NOTE

- OSD (On Screen Display) menu languages on the monitor may differ from the manual.

Main menu	Sub menu	Description
-----------	----------	-------------



PICTURE

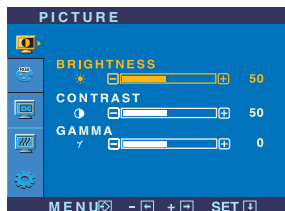

BRIGHTNESS

To adjust the brightness of the screen.

CONTRAST

To adjust the contrast of the screen.

GAMMA

Set your own gamma value. : -50/0/50
On the monitor, high gamma values display whitish images and low gamma values display high contrast images.

- **MENU** : Exit
- **-** : Decrease
- **+** : Increase
- **SET** : Select another sub-menu



COLOR



PRESET

Select the screen color.

- sRGB: Set the screen color to fit the sRGB standard color specification.
- 6500K: Slightly reddish white.
- 9300K: Slightly bluish white.

■ **RED**

Set your own red color levels.

■ **GREEN**

Set your own green color levels.

■ **BLUE**

Set your own blue color levels.

- **MENU** : Exit
- **-** : Decrease
- **+** : Increase
- **SET** : Select another sub-menu

Main menu	Sub menu	Description
-----------	----------	-------------



POSITION

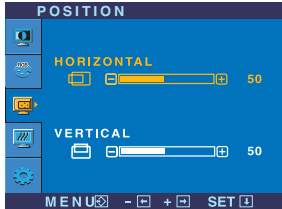

HORIZONTAL

To move image left and right.

VERTICAL

To move image up and down.

- **MENU** : Exit
- **-** : Decrease
- **+** : Increase
- **SET** : Select another sub-menu



TRACKING

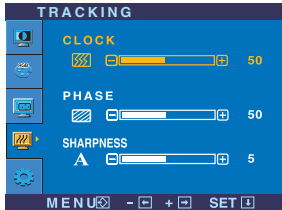

CLOCK

To minimize any vertical bars or stripes visible on the screen background. The horizontal screen size will also change.

PHASE

To adjust the focus of the display. This item allows you to remove any horizontal noise and clear or sharpen the image of characters.

SHARPNESS

To adjust the clearness of the screen.

- **MENU** : Exit
- **-** : Decrease
- **+** : Increase
- **SET** : Select another sub-menu

On Screen Display(OSD) Selection and Adjustment

Main menu	Sub menu	Description
-----------	----------	-------------



SETUP

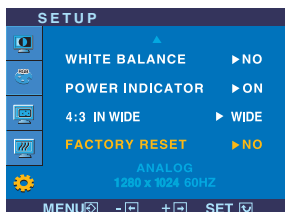
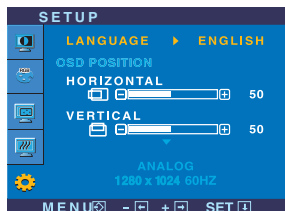

- **MENU** : Exit
- **-** : Adjust
- **+** : Adjust
- **SET** : Select another sub-menu

LANGUAGE To choose the language in which the control names are displayed.

OSD POSITION To adjust position of the OSD window on the screen.

WHITE BALANCE If the output of the video card is different the required specifications, the color level may deteriorate due to video signal distortion. Using this function, the signal level is adjusted to fit into the standard output level of the video card in order to provide the optimal image.

Activate this function when white and black colors are present in the screen.

POWER INDICATOR Use this function to set the power indicator on the front side of the monitor to **ON** or **OFF**.

If you set **OFF**, it will go off.

If you set **ON** at any time, the power indicator will automatically be turned on.

4:3 IN WIDE To select the image size of the screen.



WIDE



4:3

※ **4:3** : Depending on the input video signal ratio, it is automatically changed to an optimized screen ratio. (The 1280X1024 input signal is changed to 5:4 ratio and 1024X768 to 4:3.)

Resolution	Screen ratio
1280x1024	5 : 4
1152x864	4 : 3
1024x768	4 : 3
800x600	4 : 3
640x480	4 : 3
720x480	3 : 2

The input signal which the 4:3 IN WIDE does not support '**4:3**' is the following.

- The 22 inch monitor is

720x400,1280x768,1360x768,1440x900,1680x1050

FACTORY RESET Restore all factory default settings except "**LANGUAGE**."

Press the **- +** button to reset immediately.

If this does not improve the screen image, restore the factory default settings.

If necessary, perform the white balance function again. This function will be enabled only when the input signal is an analog signal.

On Screen Display(OSD) Selection and Adjustment

- The OSD screen will appear when you touch the **f-ENGINE (-)** button on the front of the monitor.

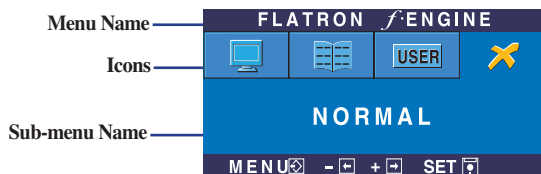

FLATRON F-ENGINE

When you execute F-ENGINE, two tones will appear on the screen as shown. The applied screen will appear on the left side, whereas the non-applied screen will appear on the right side. Touch the SET button to use the adjusted screen.

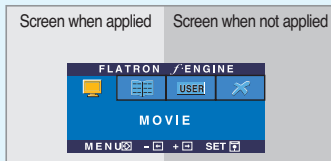

Main menu	Sub menu	Description
<p>MOVIE</p> <p>MENU SET </p> <ul style="list-style-type: none"> ■ MENU : Exit ■ - , + : Move ■ SET : Select 	<p>MOVIE TEXT</p>	<p>This feature lets you easily select the best desired image condition optimized to the environment (ambient illumination, image types etc).</p> <p>MOVIE: For animation images in videos or movies</p> <p>TEXT: For text images (Word processing etc.)</p>
<p>USER</p> <p>MENU SET </p> <p>To adjust the USER sub-menu function, Press the SET Button</p> <p>BRIGHTNESS 50</p> <p>ACE 1</p> <p>RCM 2</p> <p>SAVE NO</p> <p>MENU SET </p> <ul style="list-style-type: none"> ■ MENU : Exit ■ - : Decrease ■ + : Increase ■ SET : Select another sub-menu 	<p>USER</p>	<p>User</p> <p>You can manually adjust brightness, ACE or RCM. You can save or restore the adjusted value even when using a different environment.</p> <ul style="list-style-type: none"> ... (Brightness): Adjusts screen brightness. ... ACE(Adaptive Clarity Enhancer): Selects the clarity mode. ... RCM(Real Color Management): Selects the color mode. <div style="border: 1px solid black; padding: 5px;"> <ul style="list-style-type: none"> 0 Not applied 1 Green enhance 2 Flesh tone 3 Color Enhance </div> <p>Select the SAVE sub-menu using the SET button and save the YES value using the buttons.</p>
<p>NORMAL</p> <p>MENU SET </p>	<p>NORMAL</p>	<p>This is under normal operating conditions.</p>

Check the following before calling for service.

No image appears	
● Is the power cord of the display connected?	• Check and see if the power cord is connected properly to the power outlet.
● Is the power on and the power indicator blue or green?	• Adjust the brightness and the contrast.
● Is the power indicator amber?	• If the display is in power saving mode, try moving the mouse or pressing any key on the keyboard to bring up the screen. • Try to turn on the PC.
● Do you see an "OUT OF RANGE" message on the screen?	• This message appears when the signal from the PC (video card) is out of horizontal or vertical frequency range of the display. See the 'Specifications' section of this manual and configure your display again.
● Do you see a "CHECK SIGNAL CABLE" message on the screen?	• This message appears when the signal cable between your PC and your display is not connected. Check the signal cable and try again.

Do you see a "OSD LOCKED" message on the screen?	
● Do you see "OSD LOCKED" when you push MENU button?	• You can secure the current control settings, so that they cannot be inadvertently changed. You can unlock the OSD controls at any time by pushing the MENU button for several seconds: the message "OSD UNLOCKED" will appear.

Display image is incorrect

- | | |
|---|--|
| <ul style="list-style-type: none">● Display Position is incorrect. | <ul style="list-style-type: none">• Press the AUTO/SET button to automatically adjust your display image to the ideal setting. If the results are unsatisfactory, adjust the image position using the H position and V position icon in the on screen display. |
| <ul style="list-style-type: none">● On the screen background, vertical bars or stripes are visible. | <ul style="list-style-type: none">• Press the AUTO/SET button to automatically adjust your display image to the ideal setting. If the results are unsatisfactory, decrease the vertical bars or stripes using the CLOCK icon in the on screen display. |
| <ul style="list-style-type: none">● Any horizontal noise appearing in any image or characters are not clearly portrayed. | <ul style="list-style-type: none">• Press the AUTO/SET button to automatically adjust your display image to the ideal setting. If the results are unsatisfactory, decrease the horizontal bars using the PHASE icon in the on screen display.• Check Control Panel --> Display --> Settings and adjust the display to the recommended resolution or adjust the display image to the ideal setting. Set the color setting higher than 24 bits (true color). |

Important

- Check **Control Panel --> Display --> Settings** and see if the frequency or the resolution were changed. If yes, readjust the video card to the recommend resolution.
- **Reasons for Recommending Optimal Resolution** : The aspect ratio is 16:10. If the input resolution is not 16:10 (for instance, 16:9, 5:4, 4:3), you might encounter problems such as blurred letters, blurry screen, cut-off screen display or tilted screen.
- The setting method can differ by computer and O/S (Operation System), and resolution mentioned above may not be supported by the video card performance. In this case, please ask to the computer or the video card manufacturer.

Display image is incorrect

- | | |
|--|---|
| <ul style="list-style-type: none">● The screen color is mono or abnormal. | <ul style="list-style-type: none">• Check if the signal cable is properly connected and use a screwdriver to fasten if necessary.• Make sure the video card is properly inserted in the slot.• Set the color setting higher than 24 bits (true color) at Control Panel - Settings. |
| <ul style="list-style-type: none">● The screen blinks. | <ul style="list-style-type: none">• Check if the screen is set to interlace mode and if yes, change it to the recommend resolution. |

Have you installed the display driver?

- | | |
|--|---|
| <ul style="list-style-type: none">● Have you installed the display driver? | <ul style="list-style-type: none">• Be sure to install the display driver from the display driver CD (or diskette) that comes with your display. Or, you can also download the driver from our web site: http://www.lge.com. |
| <ul style="list-style-type: none">● Do you see an "Unrecognized monitor, Plug&Play (VESA DDC) monitor found" message? | <ul style="list-style-type: none">• Make sure to check if the video card supports Plug&Play function. |

Specifications

Display	22 inches (55.868 cm) Flat Panel Active matrix-TFT LCD Anti-Glare coating 22 inches viewable 0.282*0.282 mm pixel pitch		
Sync Input	Horizontal Freq.	28 - 83 kHz (Automatic)	
	Vertical Freq.	Analog : 56 - 75 Hz (Automatic) Digital, USB : 60 Hz (Automatic)	
	Input Form	Separate Sync. SOG (Sync On Green) Digital (HDCP)	
Video Input	Signal Input	15 pin D-Sub Connector DVI-D Connector (Digital) USB Connector (Digital)	
	Input Form	RGB Analog (0.7 Vp-p/ 75 ohm) Digital, USB	
Resolution	Max	VESA 1680 x 1050 @60 Hz	
	Recommend	VESA 1680 x 1050 @60 Hz	
Plug&Play	DDC 2B		
Power Consumption	On Mode	: 45 W(Typ.)	
	Sleep Mode	≤ 2 W	
	Off Mode	≤ 2 W	
Dimensions & Weight		With Stand	Without Stand
	Width	50.17 cm / 19.75 inches	50.17 cm / 19.75 inches
	Height	43.00 cm / 16.93 inches	37.14 cm / 14.62 inches
	Depth	25.11 cm / 9.89 inches	6.00 cm / 2.36 inches
	Net	6.2 kg (13.78 lbs)	
Range	Tilt	-3°~17° (Head)	
	Height	5.51inch (140.0mm)	
	Swivel	356°	
	Rotation	90° clockwise	
Power Input	AC 100-240V~ 50/60Hz 1.2A		
Environmental Conditions	Operating Conditions		
	Temperature	10°C to 35 °C	
	Humidity	10 % to 80 % non-Condensing	
	Storage Conditions		
	Temperature	-20°C to 60 °C	
Humidity	5 % to 90 % non-Condensing		

Specifications

Stand Base	Attached (<input type="checkbox"/>), Detached (<input type="radio"/>)	
Power cord	Wall-outlet type or PC-outlet type	
USB	Standard	USB 2.0, Self-Power
	Data Rate	Max 480 Mbps
	Power Consumption	Max 2.5W x 2

NOTE

- Information in this document is subject to change without notice.

Preset Modes (Resolution)

Analog,Digital supporting modes

Display Modes (Resolution)	Horizontal Freq. (kHz)	Vertical Freq. (Hz)	
1	720 x 400	31.468	70
2	640 x 480	31.469	60
3	640 x 480	37.500	75
4	800 x 600	37.879	60
5	800 x 600	46.875	75
6	1024 x 768	48.363	60
7	1024 x 768	60.123	75
8	1152 x 864	67.500	75
9	1280 x 1024	63.981	60
10	1280 x 1024	79.976	75
11	1680 x 1050	64.674	60
*12	1680 x 1050	65.290	60

*Recommend Mode

USB supporting mode

Display Modes (Resolution)	Horizontal Freq. (kHz)	Vertical Freq. (Hz)	
1	640 x 480	31.469	60
2	720 X 400	31.468	70
3	800 x 600	37.879	60
4	832 x 624	49.727	75
5	1024 x 768	48.363	60
6	1152 x 864	67.500	75
7	1152 X 870	63.681	75
8	1280 x 960	60.000	60
9	1280 x 1024	63.981	60
10	1440 x 900	55.469	60
11	1680 x 1050	65.290	60

Indicator

MODE	LED Color
On Mode	blue
Sleep Mode	amber
Off Mode	Off

Installing the Wall mount plate

This monitor satisfies the specifications of the Wall mount plate or the interchange device.

1. Place the monitor with its front facing downward on a soft cloth.



2. Separate the stand using a screwdriver as shown in the picture.

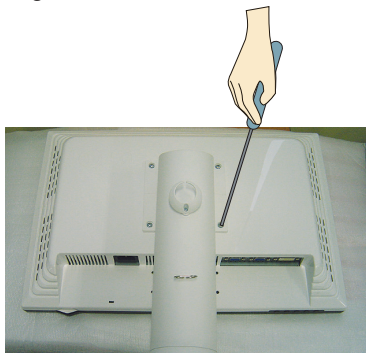

3. Install the Wall mount plate.

Wall mount plate(Seperate purchase)

This is stand-type or wall mount type and is connectable with Wall mount plate.

Please refer to the installation guide for more details, which is provided when Wall mount plate is purchased.

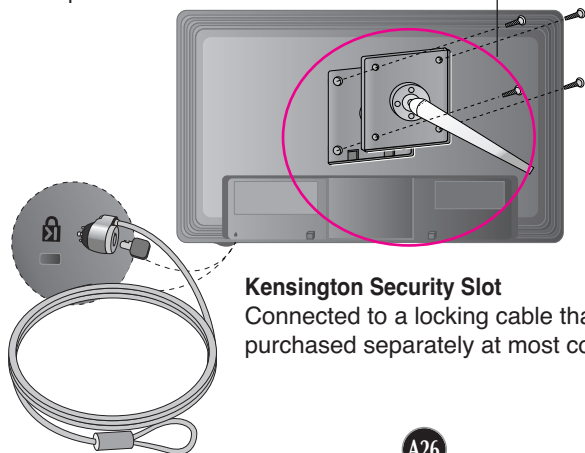

Kensington Security Slot

Connected to a locking cable that can be purchased separately at most computer stores.

Digitally yours ■■■■■■■■■■

