

LCD TV | PLASMA TV OWNER'S MANUAL

LCD TV MODELS

32LB5R*
37LB5R*
42LB5R*
47LB5R*
52LB5R*

PLASMA TV MODELS

42PB4R*
50PB4R*

Please read this manual carefully before operating your TV.
Retain it for future reference.
Record model number and serial number of the TV.
Refer to the label on the back cover and quote this information
To your dealer when requiring service.



This feature is not available for all models.
(47LB5R*/52LB5R* only)

ACCESSORIES

Ensure that the following accessories are included with your TV. If an accessory is missing, please contact the dealer where you purchased the product.

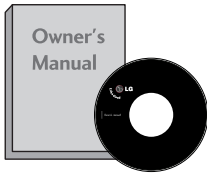

Owner's Manual

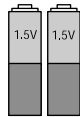

Batteries

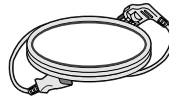

Power Cord

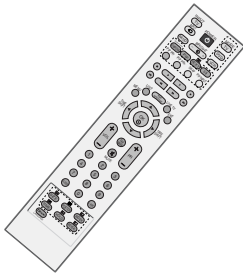

Remote Control

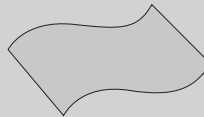

Polishing Cloth
Polishing cloth for use on the screen

*Lightly wipe any stains or fingerprints on the surface of the TV with the polishing cloth.

Do not use excessive force. This may cause scratching or discolouration.

Plasma TV models

This feature is not available for all models.



2-Wall brackets



2-eye-bolts

LCD TV models



Cable management

This feature is not available for all models.



Twists holder
Arrange the cables with the twists



2-TV Brackets
2-Wall Brackets



2-bolts

32", 37" only



4-bolts for stand assembly
Refer to p. 9

CONTENTS

ACCESSORIES 1

PREPARATION

Home Menu.....	4
Front Panel Controls.....	5
Back Panel Information	7
Stand Installation.....	9
Attaching the TV to a Wall	10
Back Cover for Wire Arrangement.....	11
Desktop Pedestal Installation	13
Wall Mount: Horizontal installation	13
Antenna Connection.....	14

EXTERNAL EQUIPMENT SETUP

HD Receiver Setup	15
DVD Setup.....	18
VCR Setup.....	21
Other A/V Source Setup.....	24
AV Output Setup	25
External Stereo Setup	25
USB in Setup	26
PC Setup.....	27
- Screen Setup for PC Mode	30

WATCHING TV / PROGRAMME CONTROL

Remote Control Key Functions.....	34
Turning on the TV.....	36
Programme Selection	36
Volume Adjustment.....	36
On Screen Menus Selection and Adjustment	37
Auto Programme Tuning.....	38
Manual Programme Tuning.....	39
Fine Tuning.....	40
Assigning a Station Name	41
Booster	42
Programme Edit	43
Favourite Programme	44
Calling the Programme List.....	45
Input Source Selection	46
Key lock.....	47
 SIMPLINK	48

TIME MACHINE

TimeShift Mode(Pause & Replay of Live TV).....	50
Format hard disk	53
Instant Recording	54
Manual Record	56
Schedule List.....	57
Record Quality	57
To use the USB device.....	58
Recorded TV Programme List	60
USB Backup	63
Photo List.....	66
Music List.....	70
Movie List.....	73
Subtitle	75
DivX Registration Code	76

PICTURE CONTROL

Watching PIP(Picture-in-Picture)	77
Picture Size (Aspect Ratio)Control	79
Preset Picture Settings	
- Picture Mode-Preset	81
- Auto Colour Temperature Control(Warm/Medium/Cool) ..	82
Manual Picture Adjustment	
- Picture Mode-User option.....	83
- Colour Temperature - User option.....	84
XD - Picture Improvement Technology.....	85
XD Demo	86
Advanced - Cinema	87
Advanced - Black(Darkness) Level.....	88
Picture Reset.....	89
Image Sticking Minimization(ISM) Method	90
Low-Power Picture Mode	91

SOUND & LANGUAGE CONTROL

Auto Volume Leveler	92
Preset Sound Settings - Sound Mode	93
Sound Setting Adjustment - User Mode	94
Balance	95
TV Speakers On/Off Setup	96
I/II	
- Stereo/Dual Reception	97
- NICAM Reception	98
- Speaker Sound Output Selection.....	98
On-Screen Menu Language Selection	99

TIME SETTING

Clock Setup	100
Auto On/Off Timer Setting.....	101
Sleep Timer Setting	102
Auto Shut-off Setting	103

TELETEXT

Switch On/Off	104
SIMPLE Text	104
TOP Text	105
FASTEXT	105
Special Teletext Functions	106

APPENDIX

Troubleshooting.....	107
Maintenance	109
Product Specifications	110
Programming the Remote Control	112
IR Codes	114
External Control Device Setup	116

PREPARATION

HOME MENU

This menu is a contents guide.

In Home Menu, you enter the Recorded list of TIME MACHINE, Manual Recording of TIME MACHINE, Schedule List ,Photo List, Music List, Movie List or TV Menu.

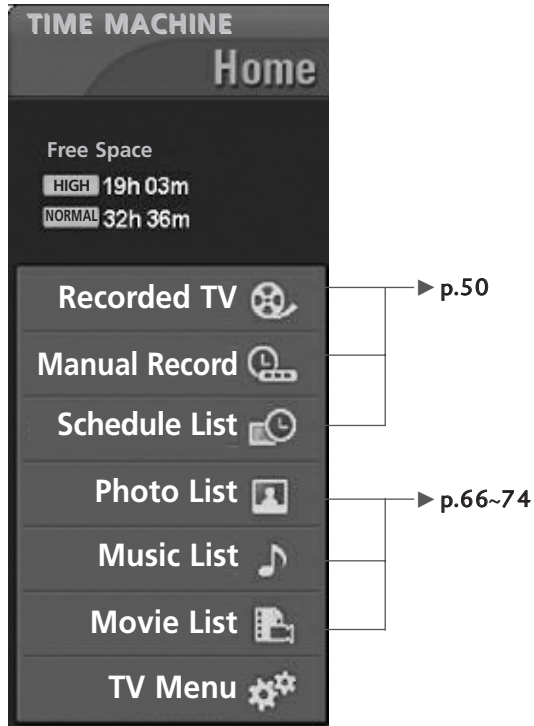
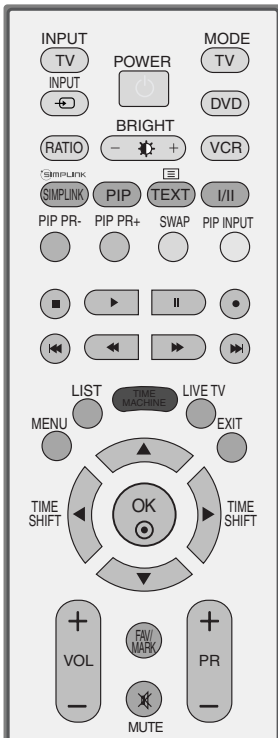

FRONT PANEL CONTROLS

- This is a simplified representation of the front panel. Image shown may differ from your TV.
- If your TV has a protection film attached, remove the film and then wipe the product with a polishing cloth.

Plasma TV Models

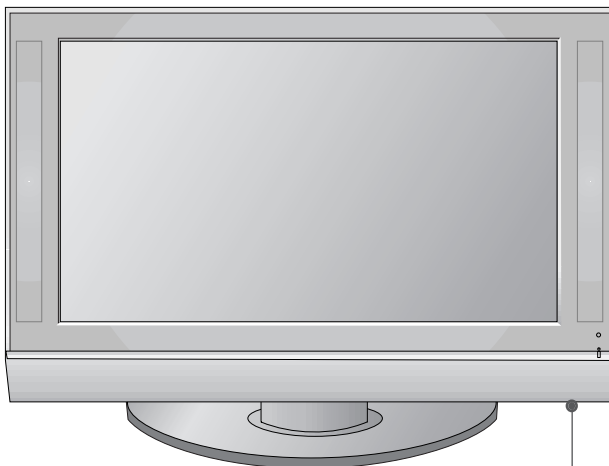

Remote Control Sensor

Power/Standby Indicator

- illuminates red in standby mode.
- illuminates green when the TV is switched on.
- illuminates orange when the TV is switched off during recording.

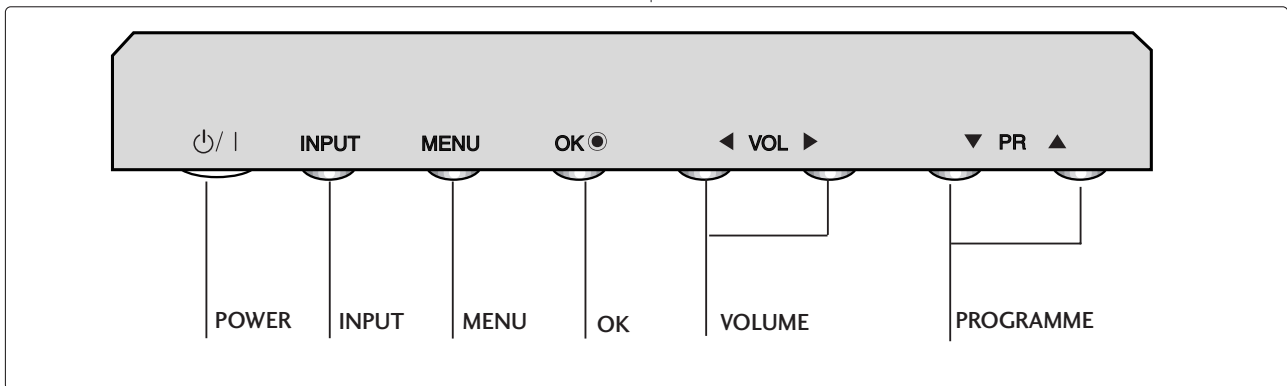

PREPARATION

LCD TV Models

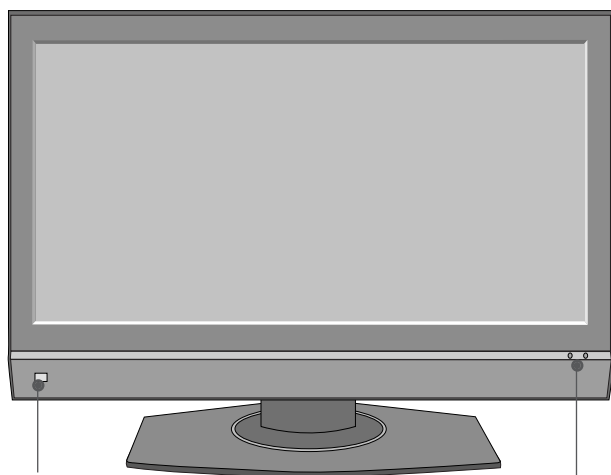

Intelligent Eye
Adjusts picture according to the surrounding conditions.

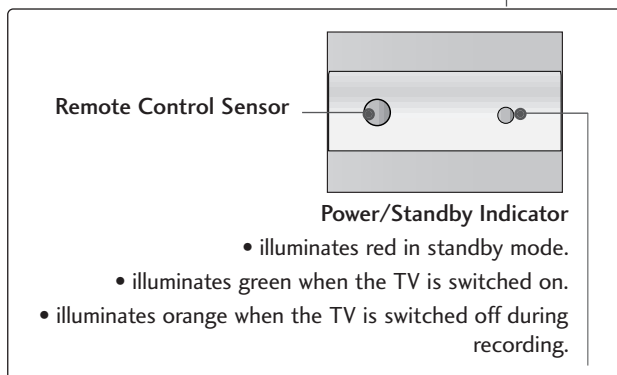
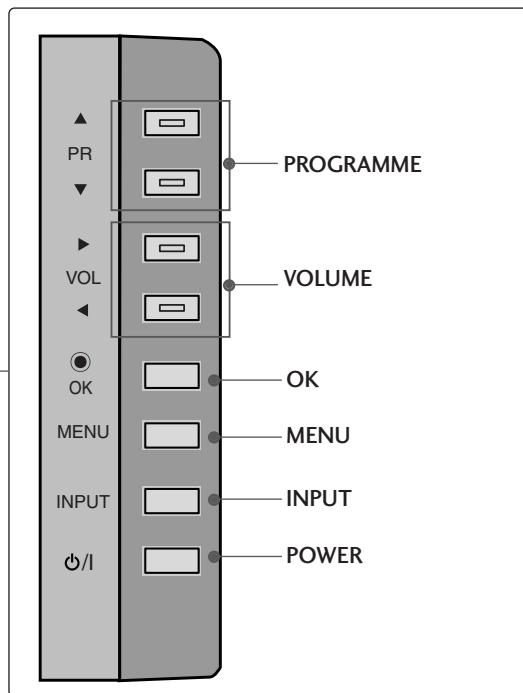

BACK PANEL INFORMATION

■ This is a simplified representation of the back panel. Image shown may differ from your TV.

Plasma TV Models

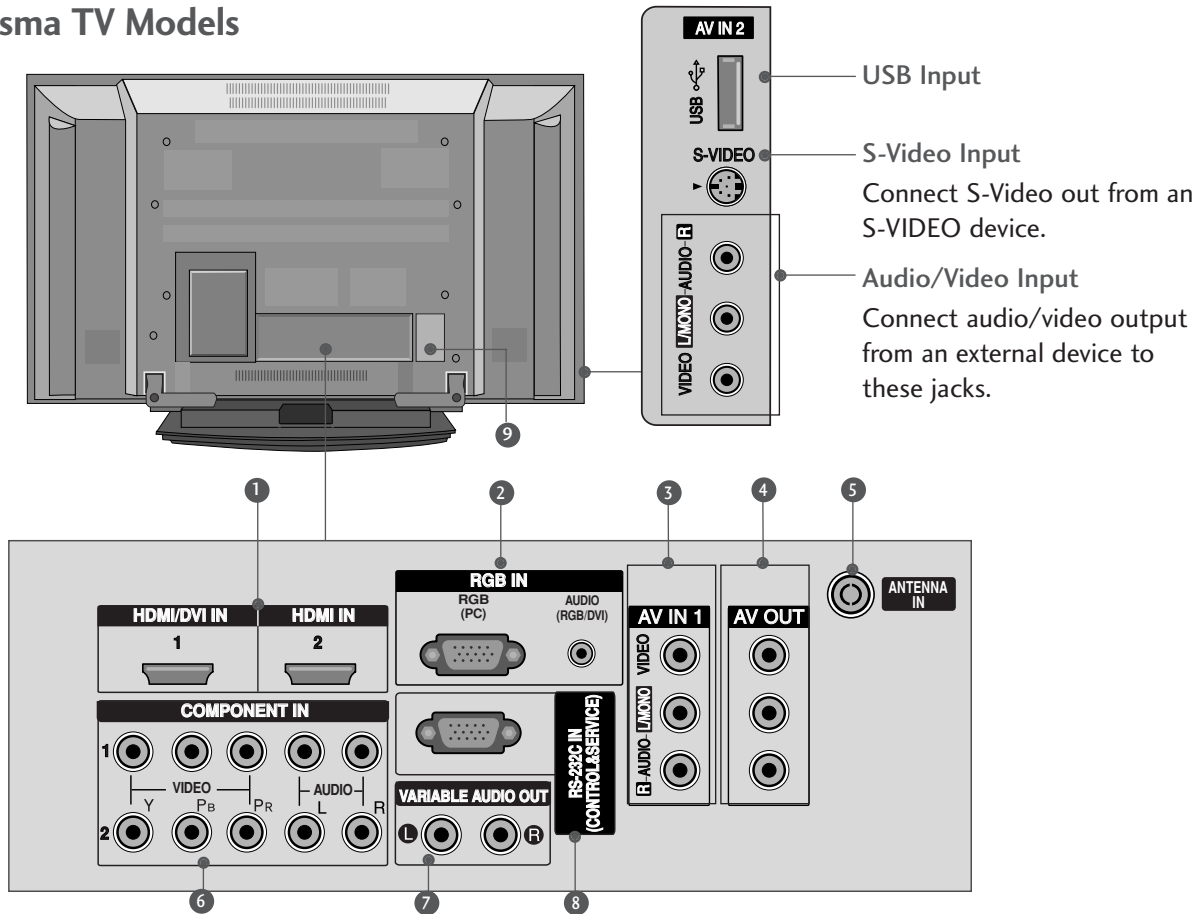

- 1 HDMI/DVI1, HDMI2 Input**
Connect a HDMI signal to HDMI IN.
Or DVI(VIDEO)signal to HDMI/DVI port with DVI to HDMI cable.
- 2 RGB/Audio Input**
Connect the monitor output from a PC to the appropriate input port.
- 3 Audio/Video Input (AV IN 1)**
Connect audio/video output from an external device to these jacks.
- 4 AV Output**
Connect second TV or monitor to the AV OUT socket on the TV.
- 5 Antenna Input**
Connect RF antenna (UHF) to this jack
- 6 Component Input 1/2**
Connect a component video/audio device to these jacks.
- 7 Variable Audio Output**
Connect an external amplifier or add a subwoofer to your surround sound system.
- 8 RS-232C Input(CONTROL&SERVICE)Port**
Connect the serial port of the control devices to the RS-232C jack.
- 9 Power Cord Socket**
This TV operates on an AC power. The voltage is indicated on the Specifications page. Never attempt to operate the TV on DC power.

PREPARATION

LCD TV Models

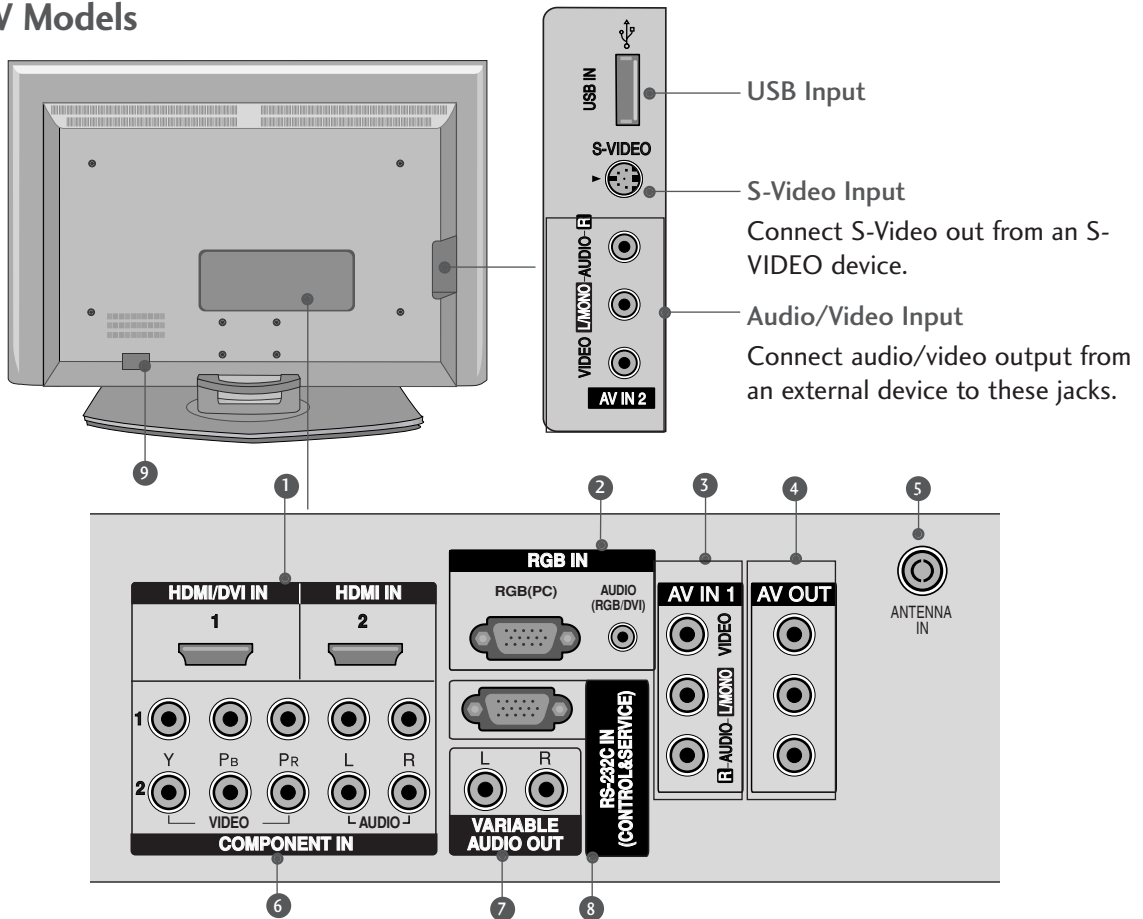

- 1** HDMI/DVI1, HDMI2 Input
Connect a HDMI signal to HDMI IN.
Or DVI(VIDEO)signal to HDMI/DVI port with DVI to HDMI cable.
- 2** RGB/Audio Input
Connect the monitor output from a PC to the appropriate input port.
- 3** Audio/Video Input (AV IN 1)
Connect audio/video output from an external device to these jacks.
- 4** AV Output
Connect second TV or monitor to the AV OUT socket on the TV.
- 5** Antenna Input
Connect RF antenna (UHF) to this jack
- 6** Component Input 1/2
Connect a component video/audio device to these jacks.
- 7** Variable Audio Output
Connect an external amplifier or add a subwoofer to your surround sound system.
- 8** RS-232C Input(CONTROL&SERVICE)Port
Connect the serial port of the control devices to the RS-232C jack.
- 9** Power Cord Socket
This TV operates on an AC power. The voltage is indicated on the Specifications page. Never attempt to operate the TV on DC power.

STAND INSTALLATION (Only 32, 37 inch LCD TV Models)

- 1 Carefully place the TV screen side down on a cushioned surface to protect the screen from damage.

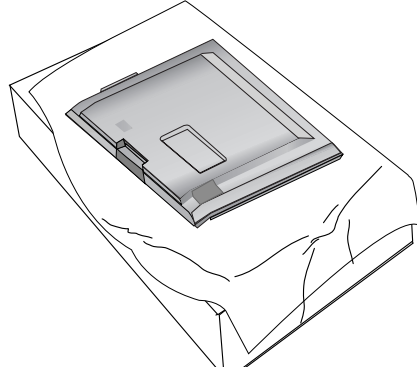

- 2 Assemble the TV as shown.

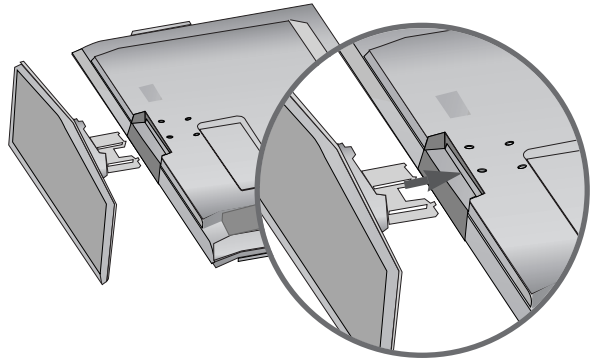

- 3 Fix the 4 bolts securely using the holes in the back of the TV.

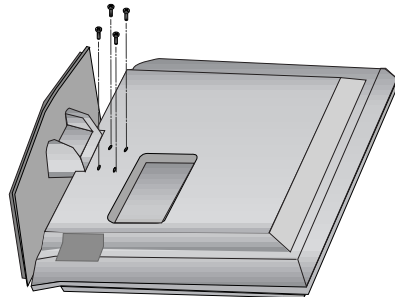

PREPARATION

ATTACHING THE TV TO A WALL (This feature is not available for all models.)

- Position the TV close to the wall to avoid the possibility of it falling when pushed.
- The instructions shown below are a safer way to set up the TV, which is to fix it to the wall, avoiding the possibility of it falling forwards if pulled. This will prevent the TV from falling forward and causing injury. This will also prevent the TV from damage. Ensure that children do not climb or hang from the TV.

Plasma TV models

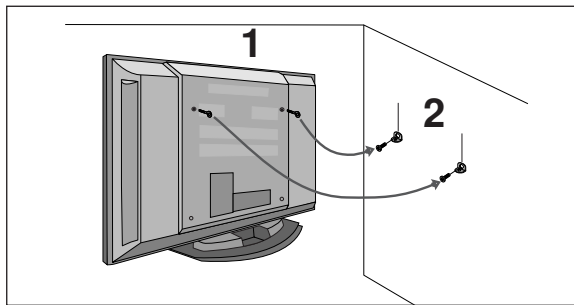

LCD TV models

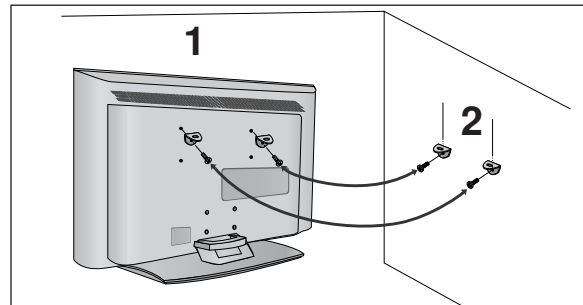

- 1 Use the eye-bolts or TV brackets/bolts to fix the product to the wall as shown in the picture. (If your TV has bolts in the eye-bolts, loosen then bolts.)
* Insert the eye-bolts or TV brackets/bolts and tighten them securely in the upper holes.
- 2 Secure the wall brackets with bolts (must purchase separately) to the wall. Ensure that both brackets are even.

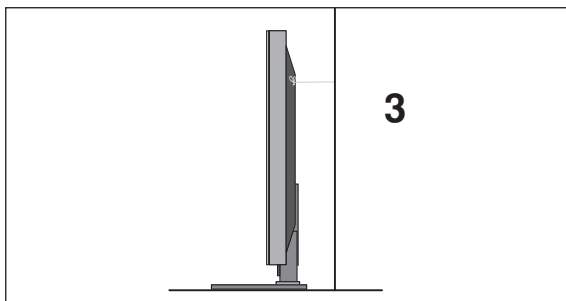

- 3 Use a strong cord (must purchase separately) to secure the TV. Secure the cord in such a way that it becomes tight when the TV is in position.

! NOTE

- ▶ When moving the TV undo the cords first.
- ▶ Use a platform or cabinet string and large enough to support the size and weight of the TV.
- ▶ To use the TV safely make sure that the height of the bracket on the wall and on the TV is the same.

BACK COVER FOR WIRE ARRANGEMENT

Plasma TV models

- 1 Grip the **CABLE MANAGEMENT** and push the cover upwards

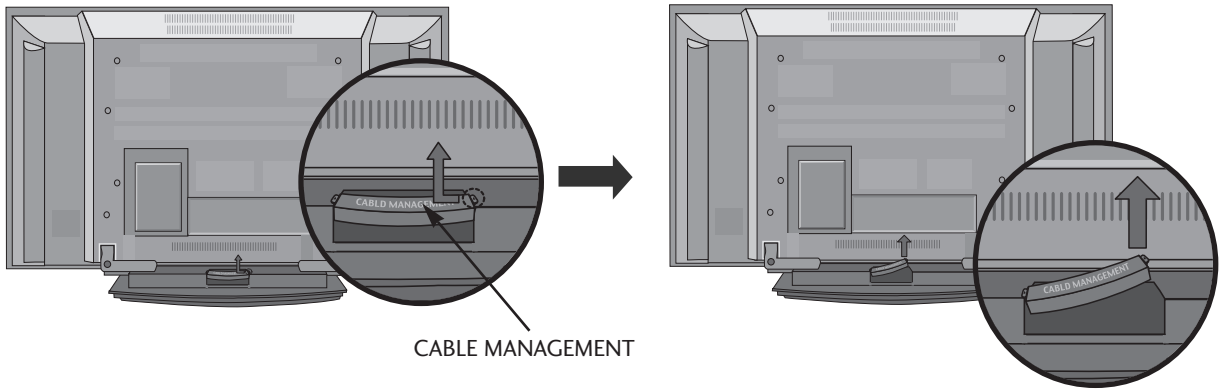

- 2 Connect the cables as necessary.
To connect additional equipment, see the **External equipment Setup** section.

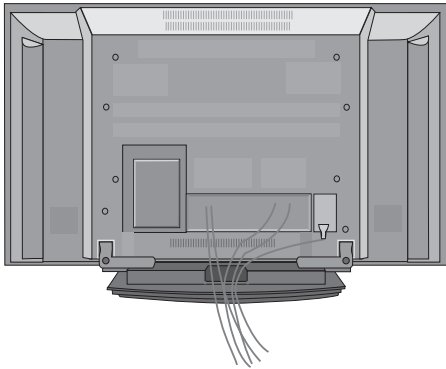

- 3 Reinstall the **CABLE MANAGEMENT** as shown

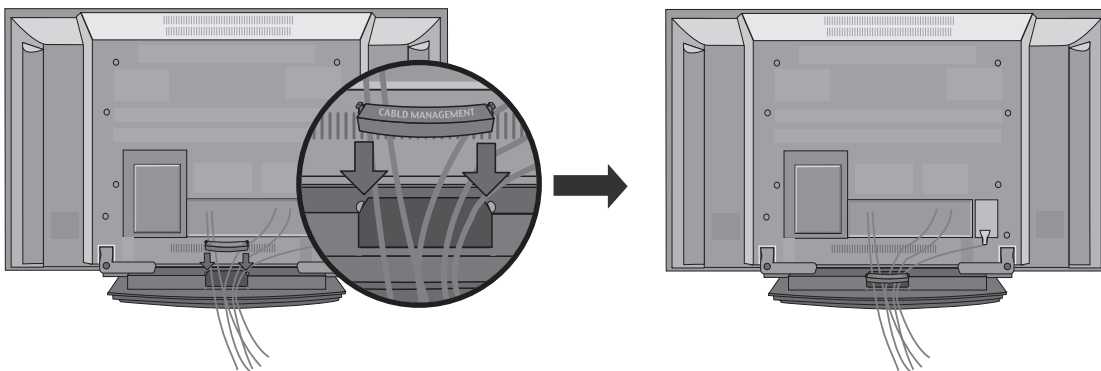

PREPARATION

LCD TV models

- 1 Connect the cables as necessary.
To connect additional equipment, see the **External equipment Setup** section.

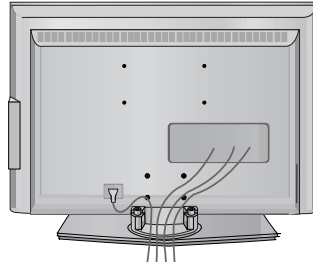

- 2 Reinstall the **CABLE MANAGEMENT** as shown

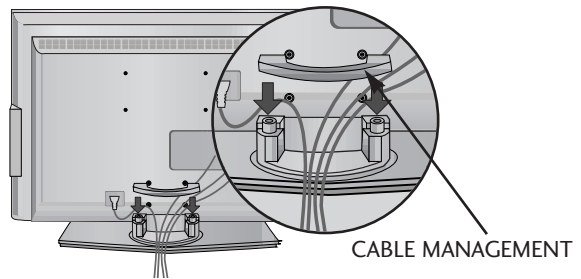

- 3 Bundle the cables together using the supplied twister holder. (This feature is not available for all models.)

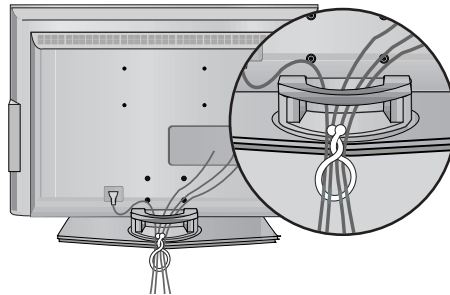

How to remove the cable management

Hold the **CABLE MANAGEMENT** with both hands and pull it upward.

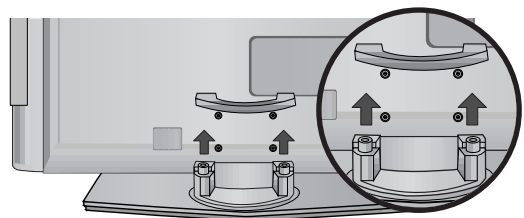

! NOTE

- ▶ Do not use the **CABLE MANAGEMENT** to lift the TV.
- If the TV is dropped, you may be injured or the TV may be damaged.

- The TV can be installed in various ways such as on a wall, or on a desktop etc.
- The TV is designed to be mounted horizontally.

EARTHING

Ensure that you connect the earth wire to prevent possible electric shock. If grounding methods are not possible, have a qualified electrician install a separate circuit breaker.

Do not try to earth the TV by connecting it to telephone wires, lightening rods or gas pipes.

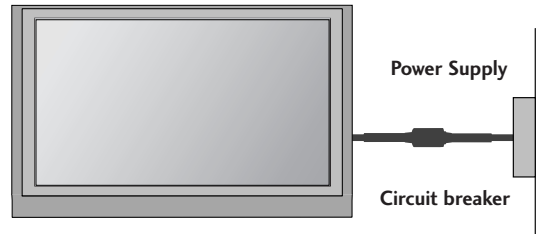

DESKTOP PEDESTAL INSTALLATION

For adequate ventilation allow a clearance of 4" (10cm) all around the TV .

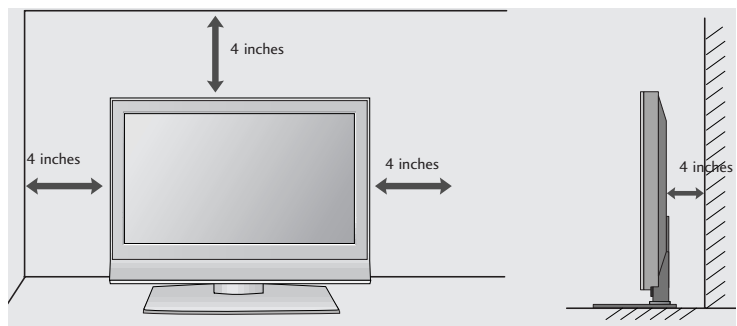
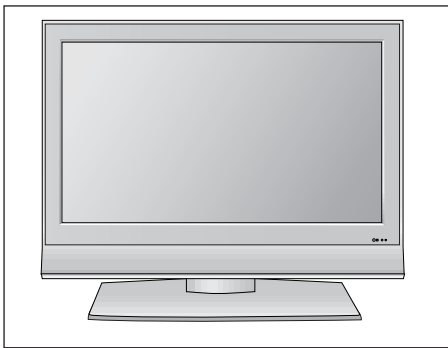

WALL MOUNT: HORIZONTAL INSTALLATION

For adequate ventilation allow a clearance of 4" (10cm) all around the TV. Detailed installation instructions are available from your dealer, see the optional Tilt Wall Mounting Bracket Installation and Setup Guide.

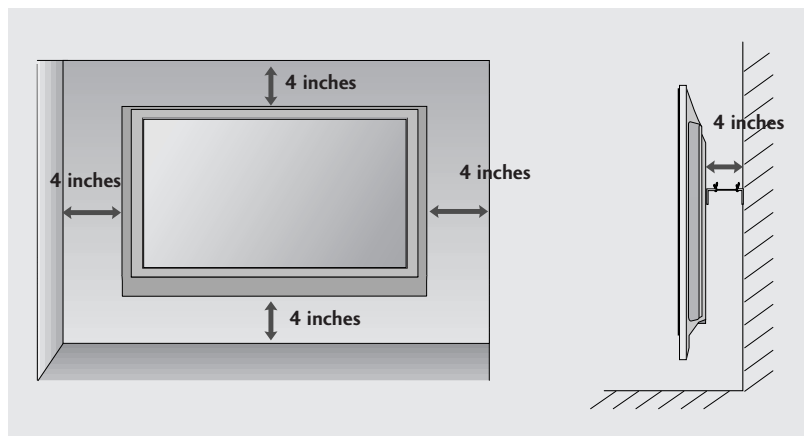
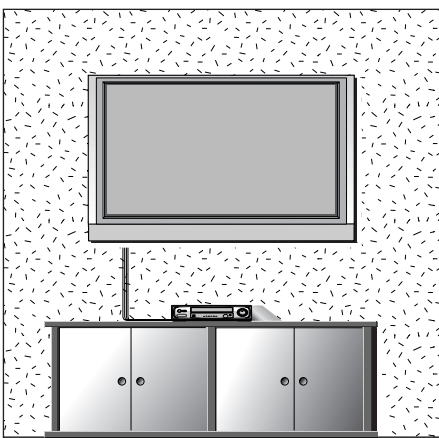

PREPARATION

- It is recommended that 42PB4RTH / 50PB4RTH model only be used at an altitude of less than 6561 feet (2000m) to get the best quality picture and sound.
- To prevent damage do not connect to the mains outlet until all connections are made between the devices.

ANTENNA CONNECTION

- For optimum picture quality, adjust antenna direction.
- An antenna cable and converter are not supplied.

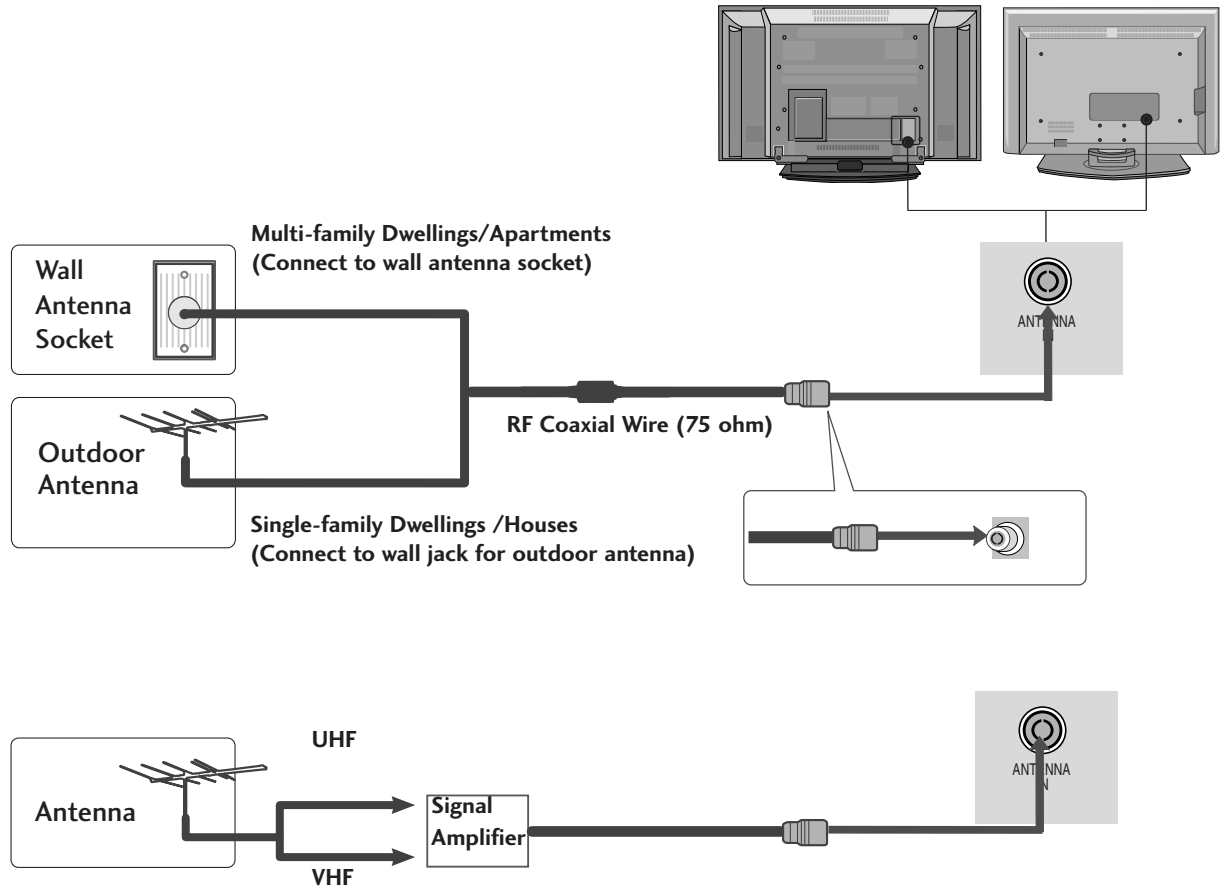

- In poor signal areas, to achieve better picture quality it may be necessary to install a signal amplifier to the antenna as shown above.
- If signal needs to be split for two TVs, use an antenna signal splitter for connection.

EXTERNAL EQUIPMENT SETUP

- To avoid damaging any equipment, never plug in any power cords until you have finished connecting all equipment.
- This section on EXTERNAL EQUIPMENT SETUP mainly uses diagrams for the LCD TV models.

HD RECEIVER SETUP

Connecting with a component cable

- 1 Connect the video outputs (Y, Pb, Pr) of the digital set top box to the **COMPONENT IN VIDEO** jacks on the TV.
- 2 Connect the audio output of the digital set-top box to the **COMPONENT IN AUDIO** jacks on the TV.
- 3 Turn on the digital set-top box.
(Refer to the owner's manual for the digital set-top box.)
- 4 Select **Component1** input source using the **INPUT** button on the remote control.
If connected to **COMPONENT IN2**, select **Component2** input source.

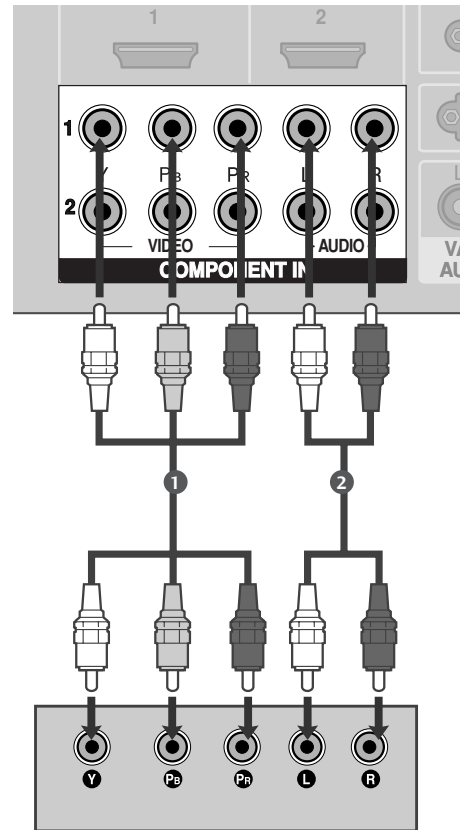

Signal	Component 1/2	HDMI1/DVI, HDMI2
480i/576i	Yes	No
480p/576p	Yes	Yes
720p/1080i	Yes	Yes
1080p(50/60Hz)	Yes	Yes

EXTERNAL EQUIPMENT SETUP

Connecting with a HDMI cable

- 1 Connect the HDMI output of the digital set-top box to the **HDMI/DVI IN 1** or **HDMI IN 2** jack on the TV.
- 2 Select **HDMI1/DVI** or **HDMI2** input source using the **INPUT** button on the remote control.
- 3 Turn on the digital set-top box.
(Refer to the owner's manual for the digital set-top box.)

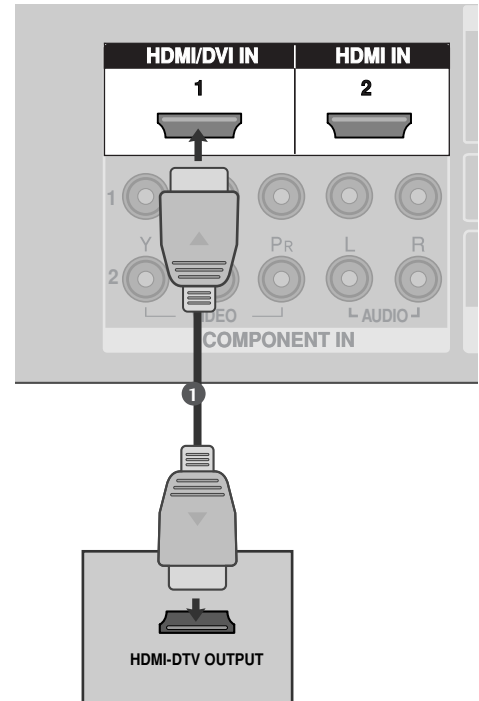

Connecting with a HDMI to DVI cable

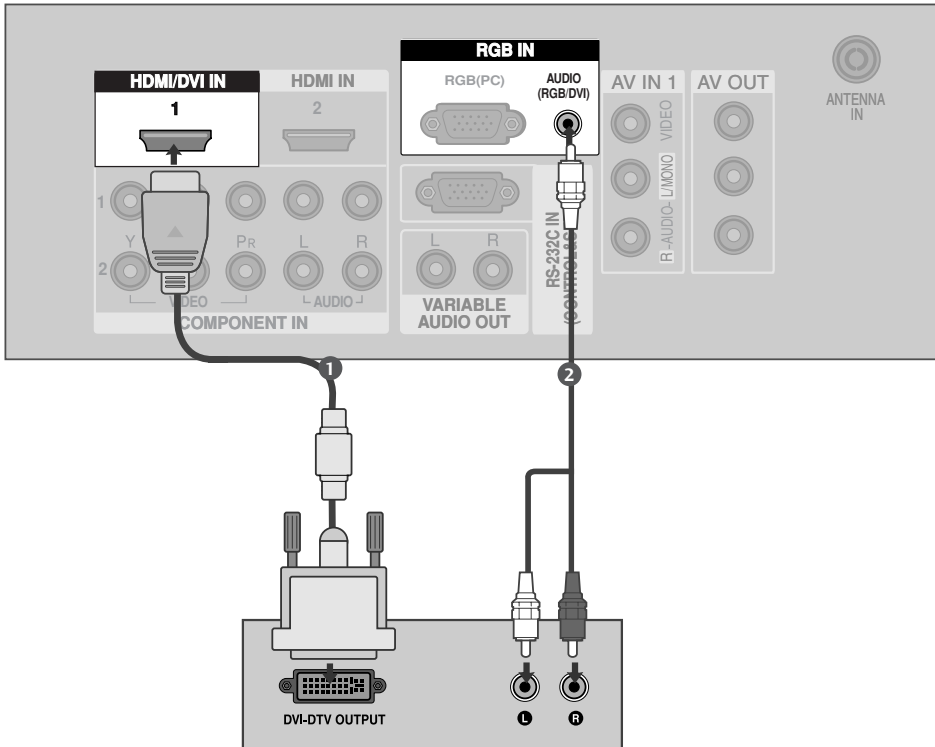

- 1 Connect the DVI output of the digital set-top box to the **HDMI/DVI IN 1** jack on the TV.
- 2 Connect the audio output of the digital set-top box to the **AUDIO (RGB/DVI)** jack on the TV.
- 3 Turn on the digital set-top box. (Refer to the owner's manual for the digital set-top box.)
- 4 Select **HDMI1/DVI** input source using the **INPUT** button on the remote control.

EXTERNAL EQUIPMENT SETUP

DVD SETUP

Connecting with a component cable

- 1 Connect the video outputs (Y, Pb, Pr) of the DVD to the **COMPONENT IN VIDEO** jacks on the TV.
- 2 Connect the audio outputs of the DVD to the **COMPONENT IN AUDIO** jacks on the TV.
- 3 Turn on the DVD player, insert a DVD.
- 4 Select **Component1** input source using the **INPUT** button on the remote control.
If connected to **COMPONENT IN2**, select **Component2** input source.
- 5 Refer to the DVD player's manual for operating instructions.

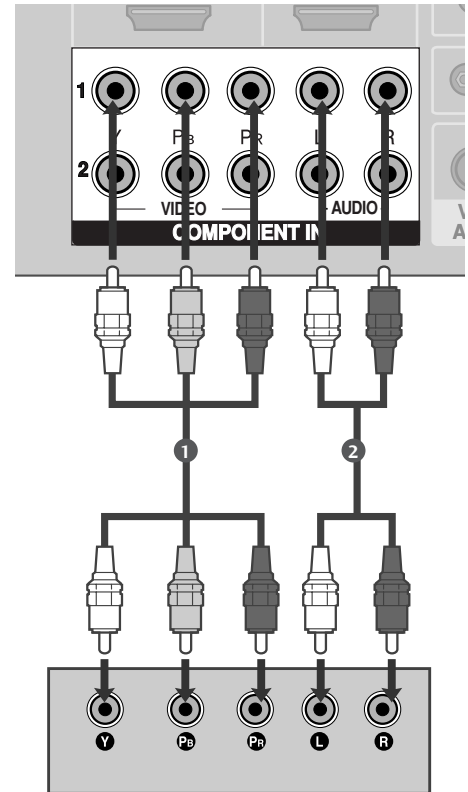

Component Input ports

To achieve better picture quality, connect a DVD player to the component input ports as shown below.

Component ports on the TV	Y	P _B	P _R
Video output ports on DVD player	Y	P _B	P _R
	Y	B-Y	R-Y
	Y	C _b	C _r
	Y	P _b	P _r

Connecting with an S-Video cable

- 1 Connect the S-VIDEO output of the DVD to the **S-VIDEO** input on the TV.
- 2 Connect the audio outputs of the DVD to the **AUDIO** input jacks on the TV.
- 3 Turn on the DVD player, insert a DVD.
- 4 Select **AV2** input source using the **INPUT** button on the remote control.
- 5 Refer to the DVD player's manual for operating instructions.

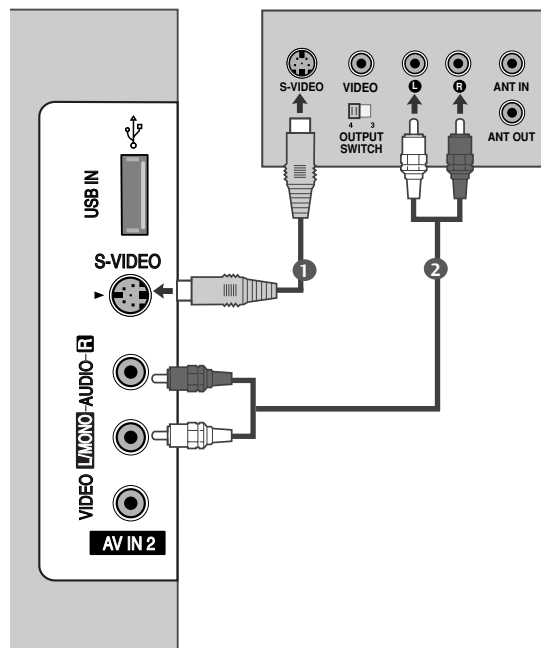

EXTERNAL EQUIPMENT SETUP

Connecting the HDMI cable

- 1 Connect the HDMI output of the DVD to the **HDMI/DVI IN 1** or **HDMI IN 2** jack on the TV.
- 2 Select **HDMI1/DVI** or **HDMI2** input source using the **INPUT** button on the remote control.
- 3 Refer to the DVD player's manual for operating instructions.

! NOTE

- ▶ TV can receive the video and audio signal simultaneously with using a HDMI cable.
- ▶ If the DVD player does not support Auto HDMI, you must set the output resolution appropriately.

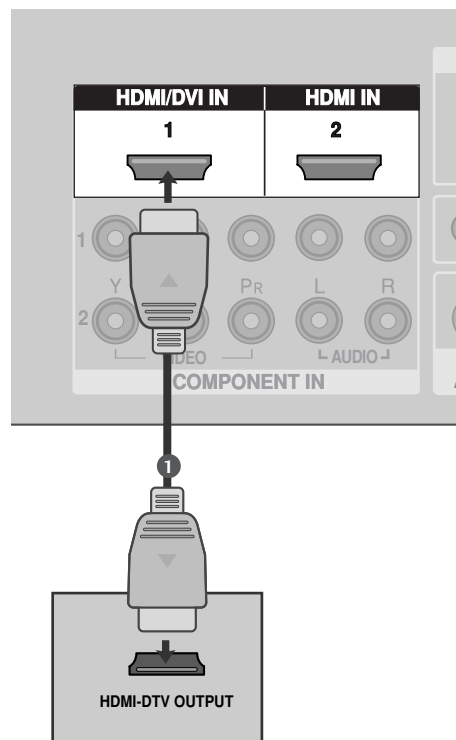

VCR SETUP

- To avoid picture noise (interference), allow adequate distance between the VCR and TV.
- Typically a frozen still picture from a VCR. If 4:3 picture format is used for an extended period the fixed images on the sides of the screen may remain visible.

Connecting with a RF Cable

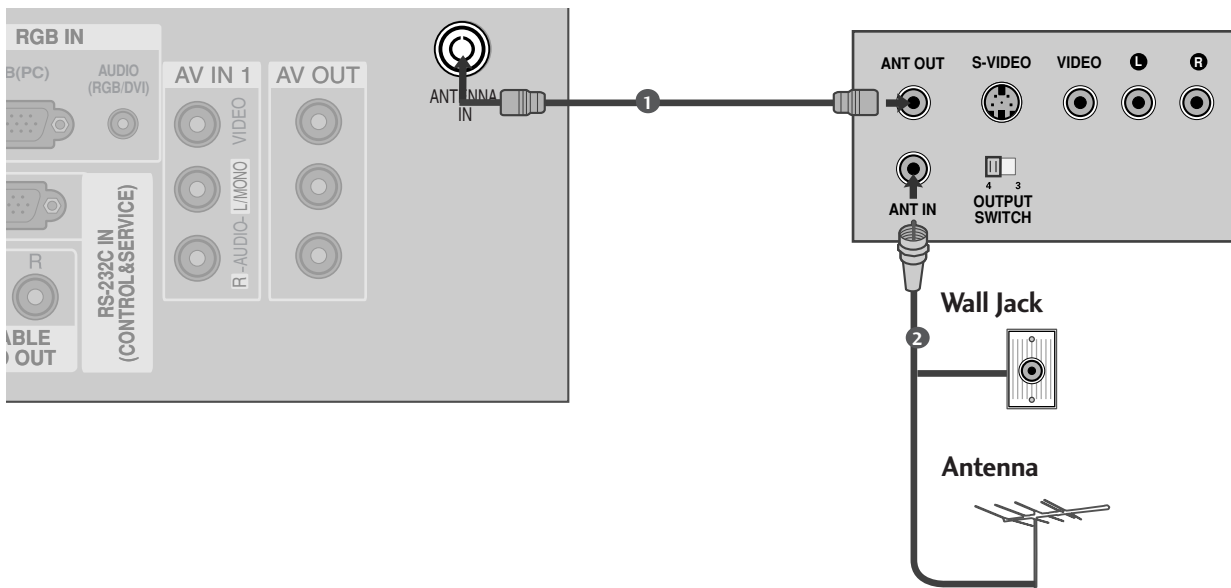

- 1 Connect the **ANT OUT** socket of the VCR to the **ANTENNA IN** socket on the TV.
.....
- 2 Connect the antenna cable to the **ANT IN** socket of the VCR.
.....
- 3 Press the **PLAY** button on the VCR and match the appropriate programme between the TV and VCR for viewing.
.....

EXTERNAL EQUIPMENT SETUP

Connecting with a RCA cable

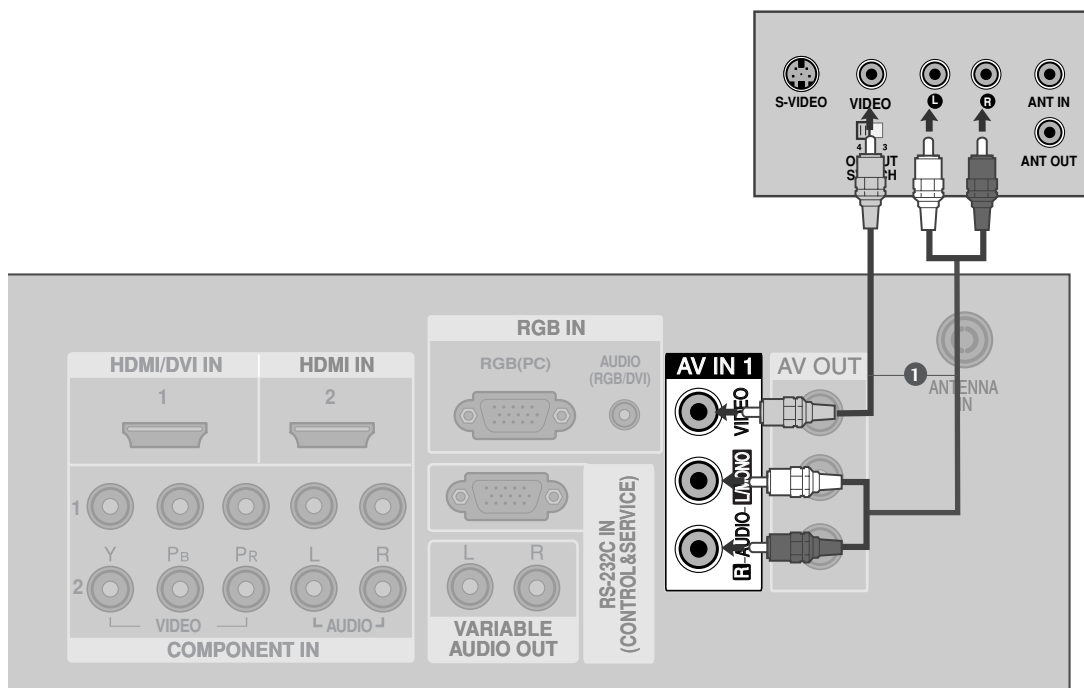

- 1 Connect the **AUDIO/VIDEO** jacks between TV and VCR. Match the jack colours (Video = yellow, Audio Left = white, and Audio Right = red)
- 2 Insert a video tape into the VCR and press **PLAY** on the VCR. (Refer to the VCR owner's manual.)
- 3 Select **AV1** input source using the **INPUT** button on the remote control. If connected to **AV IN2**, select **AV2** input source.

NOTE

- ▶ If you have a mono VCR, connect the audio cable from the VCR to the **AUDIO L/MONO** jack of the TV.

Connecting with a S-Video cable

- 1 Connect the S-VIDEO output of the VCR to the S - VIDEO input on the TV. The picture quality is improved; compared to normal composite (RCA cable) input.
- 2 Connect the audio outputs of the VCR to the AUDIO input jacks on the TV.
- 3 Insert a video tape into the VCR and press PLAY on the VCR. (Refer to the VCR owner's manual.)
- 4 Select **AV2** input source using the **INPUT** button on the remote control.

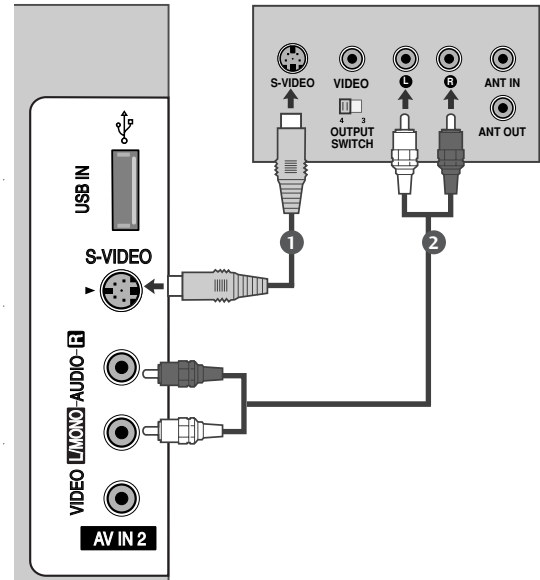

! NOTE

- ▶ If both S-VIDEO and VIDEO sockets have been connected to the S-VHS VCR simultaneously, only the S-VIDEO can be received.

EXTERNAL EQUIPMENT SETUP

OTHER A/V SOURCE SETUP

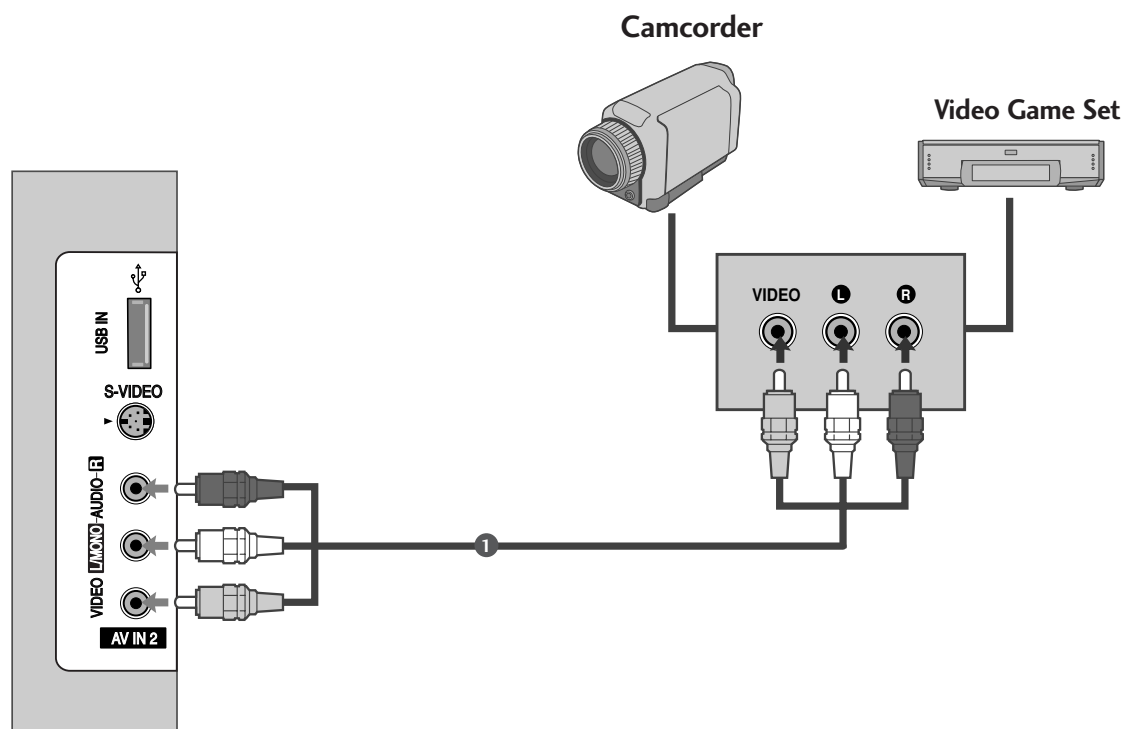

- 1 Connect the **AUDIO/VIDEO** jacks between TV and external equipment. Match the jack colours. (Video = yellow, Audio Left = white, and Audio Right = red)
- 2 Select **AV2** input source with using the **INPUT** button on the remote control. If connected to **AV IN1**, select **AV1** input source.
- 3 Operate the corresponding external equipment. Refer to external equipment operating guide.

AV OUTPUT SETUP

The TV has a special signal output capability which allows you to hook up the second TV or monitor.

- 1 Connect the second TV or monitor to the TV's **AV OUT** jacks.
- 2 See the Operating Manual of the second TV or monitor for further details regarding that device's input settings.

! NOTE

- ▶ Component, RGB, HDMI input sources cannot be used for AV out.
- ▶ We recommend to use the AV OUT jacks for VCR recording.

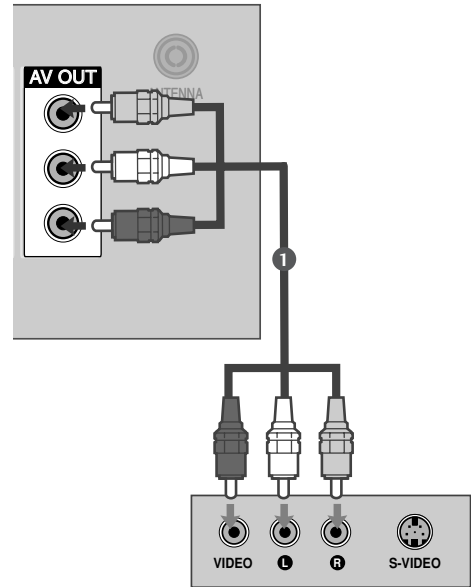

EXTERNAL STEREO SETUP

Use to connected either an external amplifier, or add a sub-woofer to your surround sound system.

- 1 Connect the input jack of the stereo amplifier to the **VARIABLE AUDIO OUT** jacks on the TV.
- 2 Set up your speakers through your analog stereo amplifier, according to the instructions provided with the amplifier.

! NOTE

- ▶ When connecting with external audio equipments, such as amplifiers or speakers, please turn the TV speakers off. (▶ p.96)

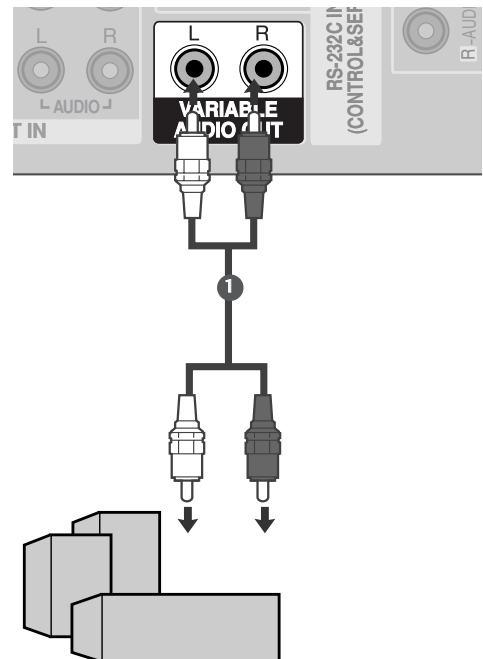

EXTERNAL EQUIPMENT SETUP

USB IN SETUP

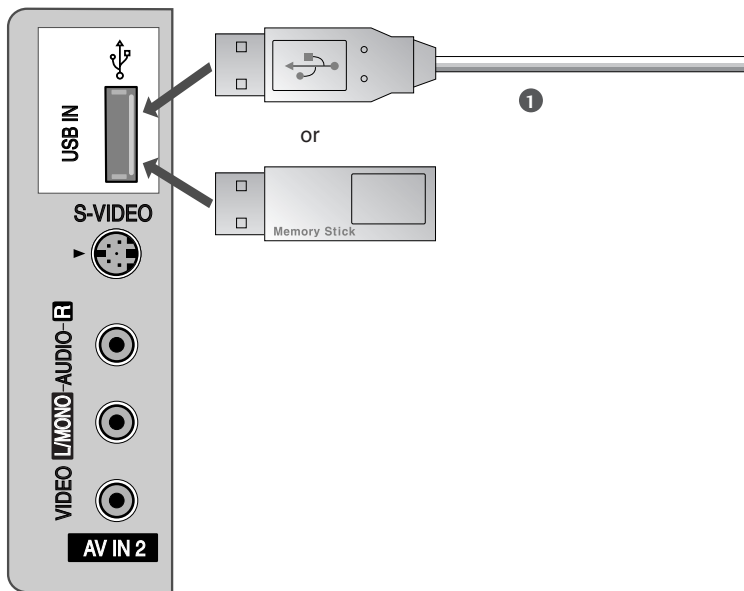

1 Connect the USB device to the **USB IN** jacks on the side of TV.

.....

2 After connecting the **USB IN** jacks, you use the **TIME MACHINE** function. (► p.58)

PC SETUP

This TV provides Plug and Play capability, meaning that the PC adjusts automatically to the TV's settings.

Connecting with a D-sub 15 pin cable

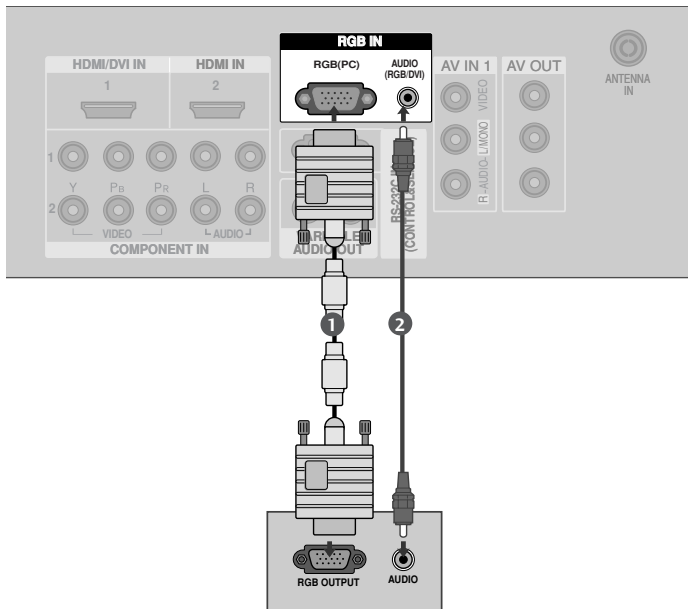

- 1 Connect the RGB output of the PC to the **RGB (PC)** jack on the TV.
.....
- 2 Connect the PC audio output to the **AUDIO(RGB/DVI)** jack on the TV.
.....
- 3 Turn on the PC and the TV.
.....
- 4 Select **RGB** input source using the **INPUT** button on the remote control.

EXTERNAL EQUIPMENT SETUP

Connecting with a HDMI to DVI cable

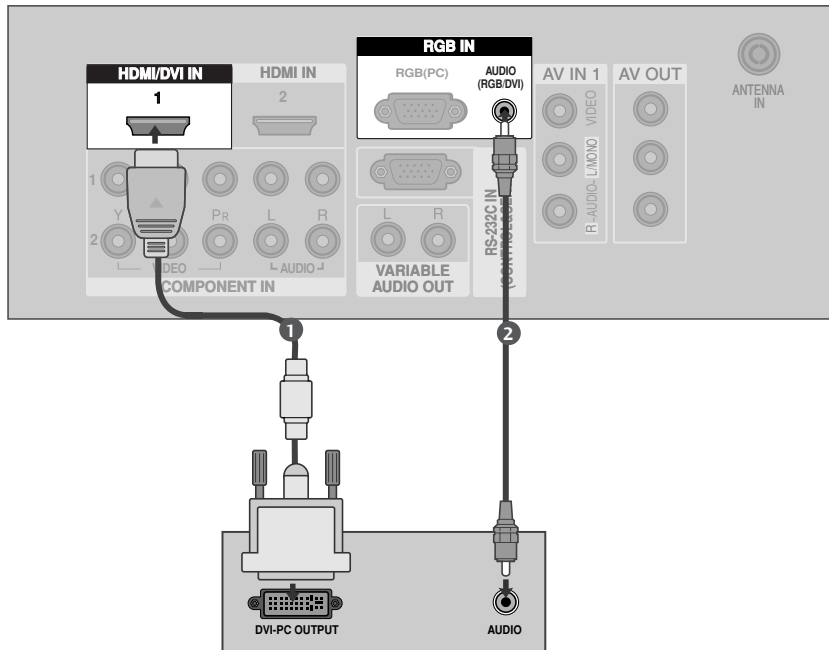

- 1 Connect the DVI output of the PC to the **HDMI/DVI IN 1** jack on the TV.
.....
- 2 Connect the PC audio output to the **AUDIO (RGB/DVI)** jack on the TV.
.....
- 3 Turn on the PC and the TV.
.....
- 4 Select **HDMI1/DVI** input source using the **INPUT** button on the remote control.

! NOTE

- ▶ If the PC has a DVI output and no HDMI output, a separated audio connection is necessary.
- ▶ If the PC does not support Auto DVI, you need to set the output resolution appropriately.

Supported Display Resolution (RGB/HDMI[PC]mode)

Resolution	Horizontal Frequency(kHz)	Vertical Frequency(Hz)
720x400	31.469	70.08
640x480	31.469 37.500	59.94 75.00
800x600	37.879 46.875	60.31 75.00
1024x768	48.363 56.476 60.023	60.00 70.06 75.02
1280x768	47.693	59.99
1360x768	47.700	60.00
1366x768	47.700	60.00
1280x1024	64.00	60.00
1920x1080	66.59	59.93

→ 47LB5R*/52LB5R* only

! NOTE

- ▶ To enjoy vivid picture and sound, connect a PC to the set.
- ▶ Avoid keeping a fixed image on the set's screen for prolonged periods of time. The fixed image may become permanently imprinted on the screen; use a screen saver when possible.
- ▶ Connect the PC to the RGB (PC) or HDMI IN (or HDMI/DVI IN) port of the set; change the resolution.
- ▶ There might be noise according to some resolution, vertical pattern, contrast or brightness in PC mode. Change the PC mode to another resolution or change the refresh rate to another rate or adjust the brightness and contrast on the menu until the picture is clear. If the refresh rate of the PC graphic card can not be changed, change the PC graphic card or consult the manufacturer of the PC graphic card.
- ▶ The synchronization input waveform for Horizontal and Vertical frequencies are separate.
- ▶ We recommend using 1366x768, 60Hz (32, 37, 42inch LCD TV models) / 1920x1080, 60Hz (47, 52inch LCD TV models) / 1024x768, 60Hz (42 inch PLASMA TV models) / 1360x768, 60Hz (50 inch PLASMA TV models) for the PC mode, these should provide the best picture quality.
- ▶ Connect the signal cable from the monitor output port of the PC to the RGB (PC/DTV) port of the set or the signal cable from the HDMI output port of the PC to the HDMI IN (or HDMI/DVI IN) port on the set.
- ▶ Connect the audio cable from the PC to the Audio input on the set. (Audio cables are not included with the set).
- ▶ If using a sound card, adjust PC sound as required.
- ▶ This set uses a VESA Plug and Play Solution. The set provides EDID data to the PC system with a DDC protocol. The PC adjusts automatically when using this set.
- ▶ DDC protocol is preset for RGB (Analog RGB), HDMI (Digital RGB) mode.
- ▶ If required, adjust the settings for Plug and Play functionality
- ▶ If the graphic card on the PC does not output analogue and digital RGB simultaneously, connect only one of either RGB or HDMI IN (or HDMI/DVI IN) to display the PC output on the set.
- ▶ If the graphic card on the PC does output analogue and digital RGB simultaneously, switch the TV set to either RGB or HDMI; (the other mode is set to Plug and Play automatically by the set.)
- ▶ DOS mode may not work depending on the video card if you use a HDMI to DVI cable.
- ▶ If you use too long an RGB-PC cable, there may be interference on the screen. We recommend using under 5m of cable. This provides the best picture quality

EXTERNAL EQUIPMENT SETUP

Screen Setup for PC mode

Auto Configure (RGB mode only)

Automatically adjusts picture position and minimizes image instability. After adjustment, if the image is still not correct, your TV is functioning properly but needs further adjustment.

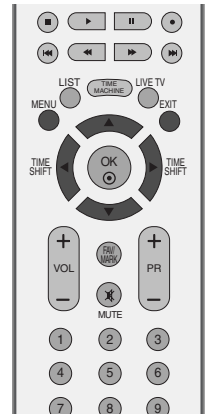

Auto configure

This function is for automatic adjustment of the screen position, clock, and phase. The displayed image will be unstable for a few seconds while the auto configuration is in progress..

1 Press the **MENU** button and then use **▲ / ▼** button to select the **PICTURE** menu.

2 Press the **▶** button and then use **▲ / ▼** button to select **Screen**.

3 Press the **▶** button and then use **▲ / ▼** button to select **Auto Config.**

4 Press the **▶** button to start **Auto Config.**

- When **Auto config.** has finished, OK will be shown on screen.
- If the position of the image is still not correct, try Auto adjustment again.
- If picture needs to be adjusted again after Auto adjustment in RGB (PC), you can adjust the **Manual Config.**

5 Press the **EXIT** button to return to TV viewing.

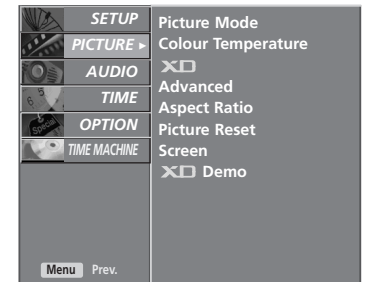

1

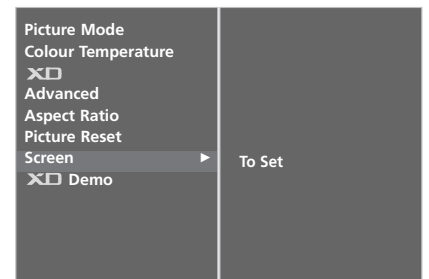

2

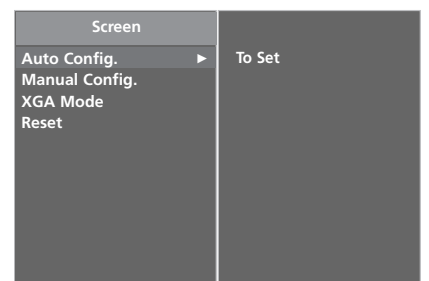

3 4

Adjustment for screen Phase, Clock, Position

If the picture isn't clear after auto adjustment and especially if characters are still trembling, adjust the picture phase manually.

To correct the screen size, adjust **Clock**.

In Just Scan mode, You can only select H-Position, V-Position in HDMI(1080i/1080p) mode only.

This function works in the following mode : RGB, COMPONENT (480p/576p/720p/1080i/1080p), HDMI (480p/576p/720p/1080i/1080p).

It's not available to use Phase, Clock function in COMPONENT (480p/576p/720p/1080i/1080p), HDMI (480p/576p/720p/1080i/1080p).

Clock Clock This function is to minimize any vertical bars or stripes visible on the screen background the horizontal screen size will also change.

Phase This function allows you to remove any horizontal noise and clear or sharpen the image of characters.

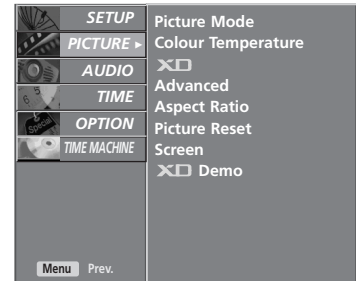
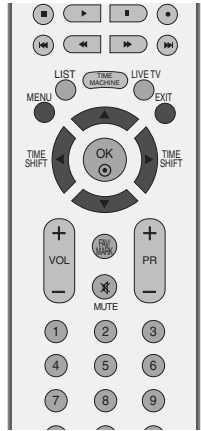

1

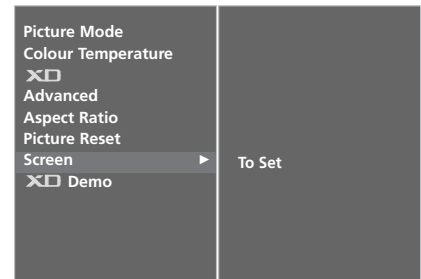

2

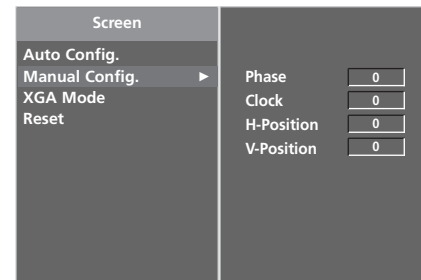

3 4 5

- 1 Press the **MENU** button and then use ▲ / ▼ button to select the **PICTURE** menu.
- 2 Press the ► button and then use ▲ / ▼ button to select **Screen**.
- 3 Press the ► button and then use ▲ / ▼ button to select **Manual Config.**
- 4 Press the ► button and then use ▲ / ▼ button to select **Phase, Clock, H-Position** or **V-Position**.
- 5 Press the ◀ / ▶ button to make appropriate adjustments.
- 6 Press the **EXIT** button to return to TV viewing.

EXTERNAL EQUIPMENT SETUP

Selecting Wide XGA mode

To view a normal picture, match the resolution of RGB mode and selection of XGA mode.

This function works in the following mode: RGB mode.

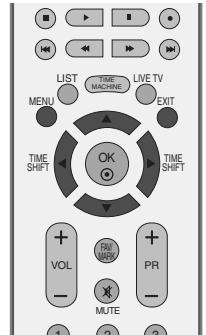

1 Press the **MENU** button and then use ▲ / ▼ button to select the **PICTURE** menu.

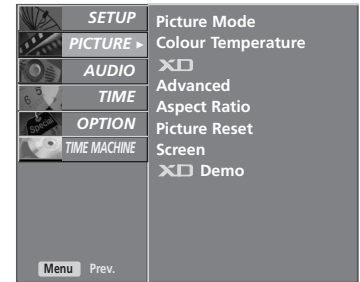

2 Press the ► button and then use ▲ / ▼ button to select **Screen**.



3 Press the ► button and then use ▲ / ▼ button to select **XGA Mode**.

4 Press the ► button and then use ▲ / ▼ button to select the desired XGA resolution.

5 Press the **EXIT** button to return to TV viewing.

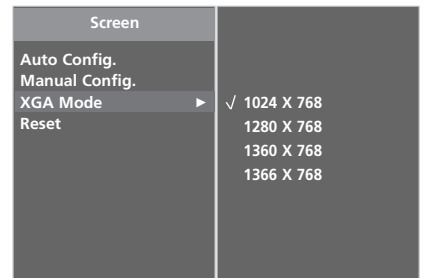

Initializing (Reset to original factory settings)

This function operates in current mode.
To initialize the adjusted value



- 1 Press the MENU button and then use ▲ / ▼ button to select the **PICTURE** menu.
- 2 Press the ► button and then use ▲ / ▼ button to select **Screen**.
- 3 Press the ► button and then use ▲ / ▼ button to select **Reset**.
- 4 Press the ► button.
- 5 Press the EXIT button to return to TV viewing.

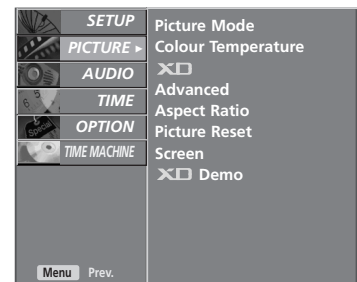

1

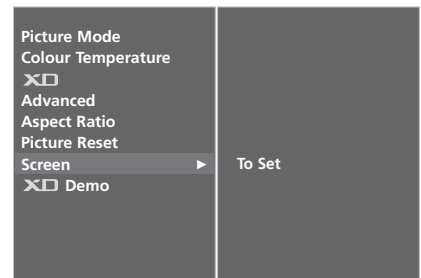

2

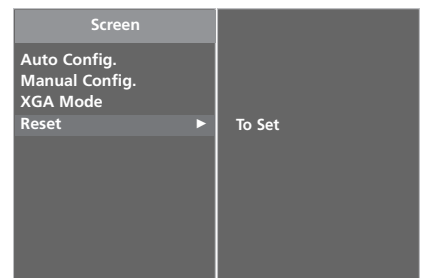

3 4

WATCHING TV / PROGRAMME CONTROL

REMOTE CONTROL KEY FUNCTIONS

When using the remote control, aim it at the remote control sensor on the TV.

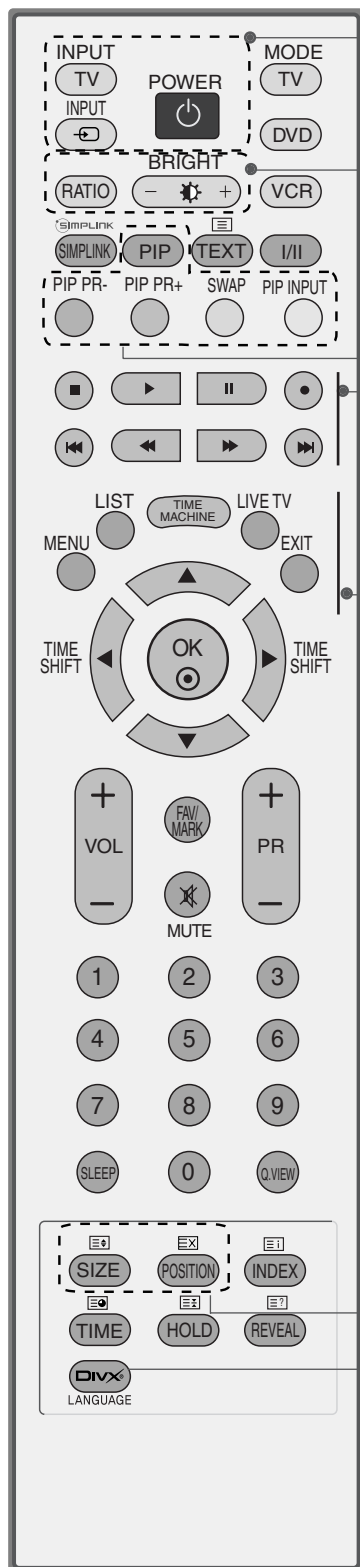

WATCHING TV / PROGRAMME CONTROL

POWER Switches the TV on from standby or off to standby.

TV INPUT Returns to the TV viewing from any mode. Switches the TV on from standby.

INPUT If you press the button once, the input source OSD will appear on screen as shown. Press the ▲ / ▼ button and then OK button to select the desired input source (TV, AV1, AV2, Component1, Component2, RGB, HDMI1/DVI or HDMI2).

RATIO Selects your desired picture format.

Brightness adjustment Adjusts screen brightness. This returns to the default settings brightness by changing mode source.

1 **PIP** Switches the sub picture PIP, DW mode.

PIP PR - / + Selects a programme for the sub picture.

SWAP Exchanges the main/sub images in PIP/DW.

PIP INPUT Selects the input source for the sub picture in PIP/DW picture mode.

SIZE Adjusts the sub picture size.

POSITION Moves the sub picture.

TIME MACHINE/ VCR/DVD control buttons Controls video cassette recorders or DVD players when you select DVD or VCR mode button. Control connected AV devices by pressing the ▲ / ▼ / ◀ / ▶, OK buttons and buttons for play, stop, pause, fast reverse, fast forward, chapter skip. (The ● button does not provide such functions.) Use for TIME MACHINE record or trick play.

MENU Selects a menu.

LIST Displays the programme list.

TIME MACHINE Call up the Home menu.

LIVE TV In Delayed mode, the screen returns to Live programme from TV, AV1, AV2 and Component1, Component2 modes.

EXIT Clears all on-screen displays and returns to TV viewing from any menu.

2 **DivX** Selects a DivX Audio Language or Subtitle Language

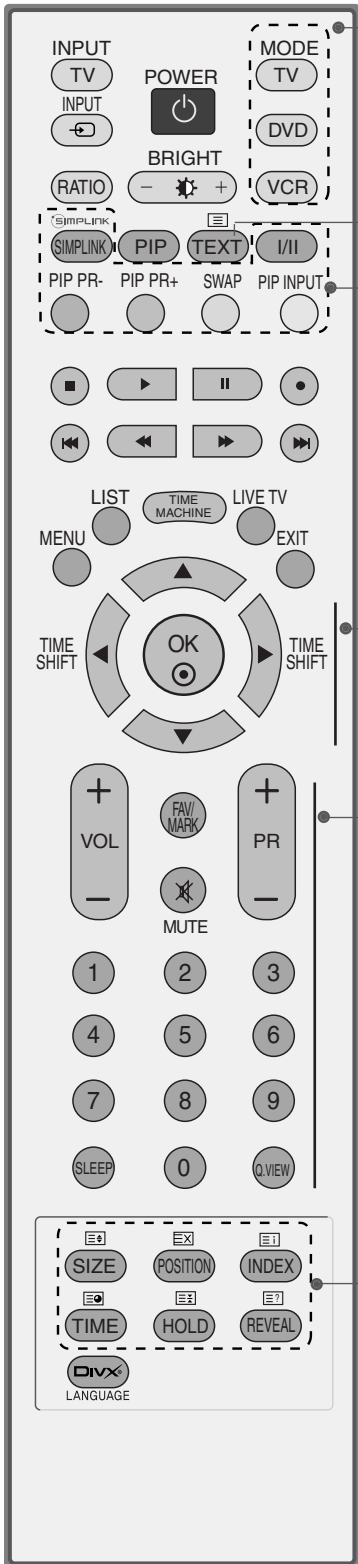

MODE Selects the remote operating modes.

3 TELETEXT BUTTONS These buttons are used for teletext. For further details, see the 'Teletext' section.

SIMP LINK See a list of AV devices connected to TV. When you toggle this button, the Simplink menu appears at the screen. (▶ p.48)

I/II Selects the sound output.

Coloured buttons These buttons are used for teletext (only **TELETEXT** models) or **Programme edit**.

THUMBSTICK Allows you to navigate the on-screen menus and adjust the system settings to your preference. (Up/Down/Left Right) (TIME SHIFT)

OK Accepts your selection or displays the current mode.

VOLUME UP/DOWN Adjusts the volume.

FAV Displays the selected favourite programme.

MARK Check and un-check programmes in the recorded TV menu.

MUTE Switches the sound on or off.

Programme UP/DOWN Selects a programme.

0~9 number buttons Selects a programme. Selects numbered items in a menu.

SLEEP Sets the sleep timer.

Q.VIEW Returns to the previously viewed programme.

Installing Batteries

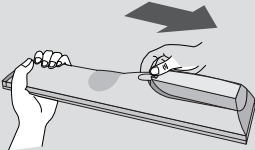

- Open the battery compartment cover on the back and install the batteries matching correct polarity (+with +,-with -).
- Install two 1.5V AA batteries. Don't mix old or used batteries with new ones.
- Close cover.

WATCHING TV / PROGRAMME CONTROL

TURNING ON THE TV

When your TV is turned on, you will be able to use its features.

- 1 Firstly, connect the power cord correctly.
At this stage, the TV switches to standby mode.
 - In standby mode to turn TV on, press the $\phi/|$, **INPUT**, **PR ▲ / ▼** button on the TV or press the **POWER**, **TV**, **INPUT**, **PR + / -**, **Number(0~9)** button on the remote control and the TV will switch on.

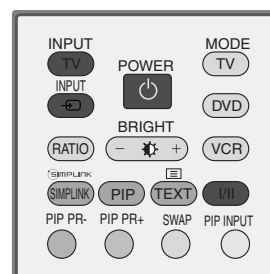

PROGRAMME SELECTION

- 1 Press the **PR + / -** or **NUMBER** buttons to select a programme number.

VOLUME ADJUSTMENT

- 1 Press the **VOL + / -** button to adjust the volume.
- 2 If you wish to switch the sound off, press the **MUTE** button.
- 3 You can cancel the Mute function by pressing the **MUTE**, **VOL + / -** or **I/II** button.

ON SCREEN MENUS SELECTION AND ADJUSTMENT

Your TV's OSD (On Screen Display) may differ slightly from that shown in this manual.
The OSD mainly use pictures for the Plasma TV models.

- 1 Press the **MENU** button and then **▲** / **▼** button to display each menu.
- 2 Press the **▶** button and then **▲** / **▼** button to select a menu item.
- 3 Change the setting of an item in the sub or pull-down menu with **◀** / **▶** button.
You can move to a higher level menu by pressing the **OK** or **MENU** button.

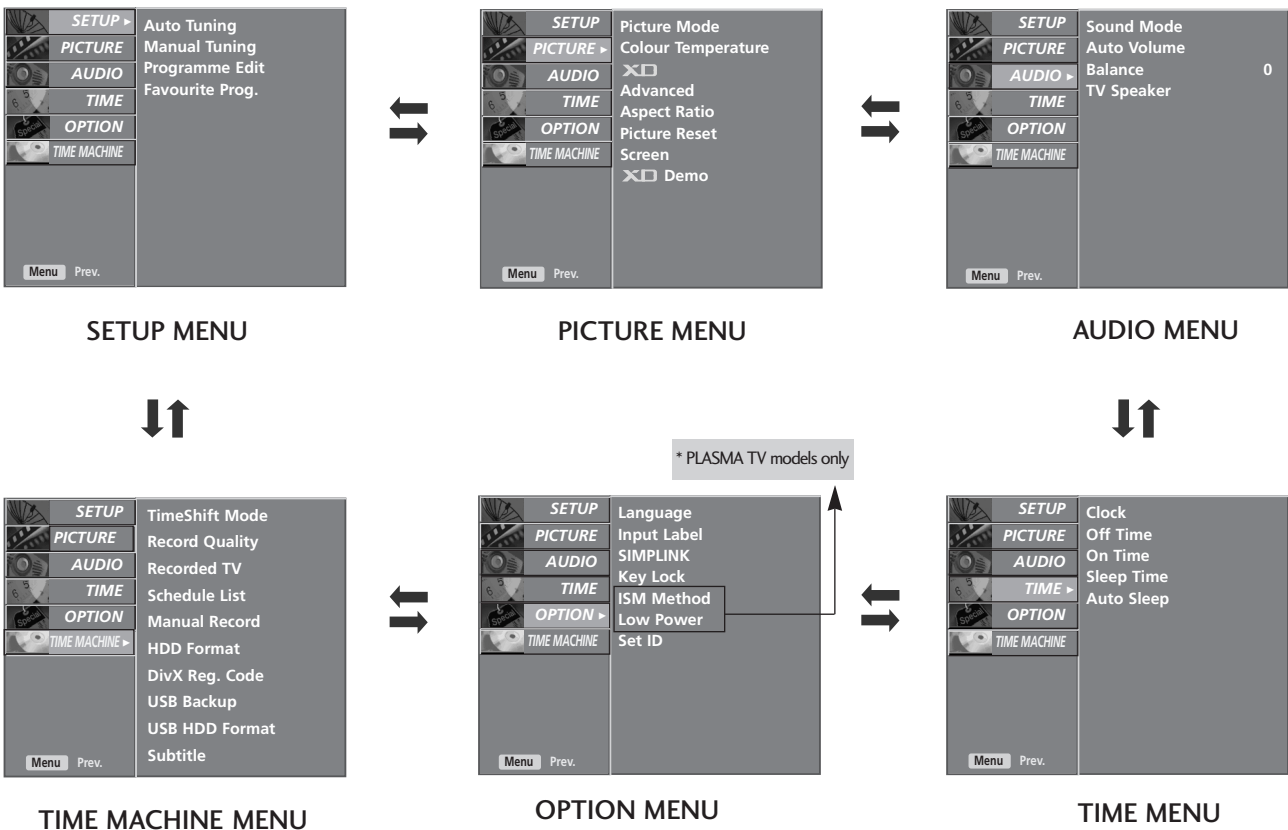

! NOTE

- ▶ The OSD (On Screen Display) function enables you to adjust the screen status conveniently since it provides graphical presentation.
- ▶ In this manual, the OSD (On Screen Display) may be different from your TV's because it is just example to help the TV operation.
- ▶ In the teletext mode, menus are not displayed
- ▶ It's not available to use **SETUP** menu on playing recorded programme.

WATCHING TV / PROGRAMME CONTROL

AUTO PROGRAMME TUNING

Up to 100 TV stations can be stored by programme numbers (0 to 99). Once you have preset the stations, you will be able to use the PR + / - or NUMBER buttons to scan the stations you have programmed.

Stations can be tuned using automatic or manual modes.

All stations which can be received are stored by this method. It is recommended that you use Auto tuning during installation of this TV.

It is not possible to use this function whilst recording a programme.



1 Press the **MENU** button and then **▲ / ▼** button to select the **SETUP** menu.

2 Press the **▶** button and then **▲ / ▼** button to select **Auto Tuning**.

3 Press the **▶** button and then **▲ / ▼** button to select **System**.

4 Press the **◀ / ▶** button to select a TV system menu;
 BG: PAL B/G, SECAM B/G (Europe / East Europe / Asia / New/Zeland / M.East / Africa / Australia)
 I : PAL I/II (U.K. / Ireland / Hong Kong / South Africa)
 DK: PAL D/K, SECAM D/K (East Europe / China / Africa / CIS)
 M : (USA / Korea / Philippines)

5 Press the **▲ / ▼** button to select **Storage From**.

6 Press the **◀ / ▶** button or NUMBER buttons to select the beginning programme number. If you use NUMBER buttons, any number under 10 is entered with a numeric '0' in front of it, i.e. '05' for 5.

7 Press the **▲ / ▼** button to select **Start**.

8 Press the **▶** button to begin auto tuning.
 All receivable stations are stored.

To stop auto tuning, press the **MENU** button.

When auto tuning is complete, the Programme Edit menu appears on the screen. See the Programme edit section to edit the stored programme.

9 Press the **EXIT** button to return to normal TV viewing.

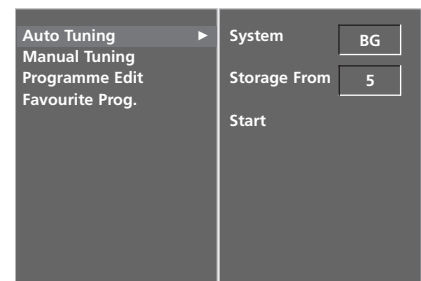

2 3 4 5 6 7

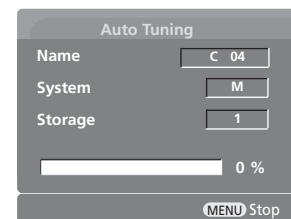

8

MANUAL PROGRAMME TUNING

Manual programme lets you manually tune and arrange the stations in whatever order you desire.

It is not possible to use this function with TimeShift Mode On .

It is not possible to use this function whilst recording a programme.



- 1 Press the **MENU** button and then **▲ / ▼** button to select the **SETUP** menu.
- 2 Press the **▶** button and then **▲ / ▼** button to select **Manual Tuning**.
- 3 Press the **▶** button and then **▲ / ▼** button to select **Storage**.
- 4 Press the **◀ / ▶** button or **NUMBER** buttons to select the desired programme number (0 to 99). If you use **NUMBER** buttons, any number under 10 is entered with a numeric '0' in front of it, i.e. '05' for 5.
- 5 Press the **▲ / ▼** button to select **System**.
- 6 Press the **◀ / ▶** button to select a TV system menu;
 - BG: PAL B/G, SECAM B/G (Europe / East Europe / Asia / NewZealand / M.East / Africa / Australia)
 - I : PAL I/II (U.K. / Ireland / Hong Kong / South Africa)
 - DK: PAL D/K, SECAM D/K (East Europe / China / Africa / CIS)
 - M : (USA / Korea / Philippines)
- 7 Press the **▲ / ▼** button to select **Band**.
- 8 Press the **▶** button and then **◀ / ▶** button to select **V/UHF** or **Cable**.
- 9 Press the **▲ / ▼** button to select **Channel**.
- 10 You can select the desired programme number with the **◀ / ▶** button or number buttons. If possible, select the programme number directly with the number buttons. Any number under 10 is entered with a numeric '0' in front of it, i.e. '05' for 5.
- 11 Press the **▲ / ▼** button to select **Search**.
- 12 Press the **◀ / ▶** button to commence searching. If a station is found the search will stop.
- 13 Press the **OK** button to store it.
- 14 To store another station, repeat steps 3 to 13.
- 15 Press the **EXIT** button to return to normal TV viewing.

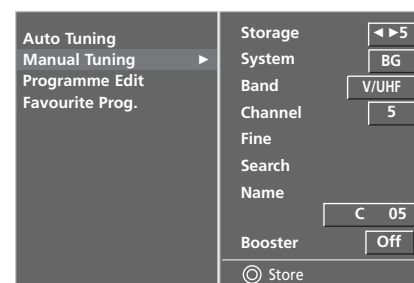

- 2
- 3
- 4
- 5
- 6
- 7
- 8
- 9
- 10
- 11
- 12

WATCHING TV / PROGRAMME CONTROL

FINE TUNING

Normally fine tuning is only necessary if reception is poor.

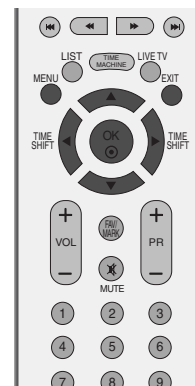

- 1 Press the **MENU** button and then ▲ / ▼ button to select the **SETUP** menu.
- 2 Press the ► button and then ▲ / ▼ button to select **Manual Tuning**.
- 3 Press the ► button and then ▲ / ▼ button to select **Fine**.
- 4 Press the ◀ / ▶ button to fine tune for the best picture and sound.
- 5 Press the OK button to store settings.
- 6 Press the **EXIT** button to return to normal TV viewing.

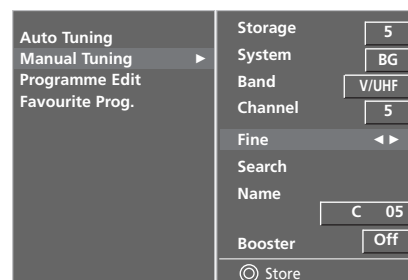

2 3 4 5

ASSIGNING A STATION NAME

You can assign a station name up to five characters to each programme number.

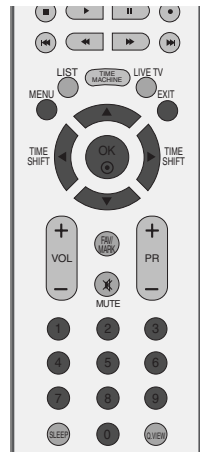

- 1 Press the **MENU** button and then **▲ / ▼** button to select the **SETUP** menu.

- 2 Press the **▶** button and then **▲ / ▼** button to select **Manual Tuning**.

- 3 Press the **▶** button and then **▲ / ▼** button to select **Name**.

- 4 Press the **▶** button and then **▲ / ▼** button. You can use the alphabet A to Z, numbers 0 to 9, +/ -, and blank.

- 5 Press the **◀ / ▶** button to select the position and make your choice of the second character, and so on.

- 6 Press the **OK** button to store it.

- 7 Press the **EXIT** button to return to normal TV viewing.

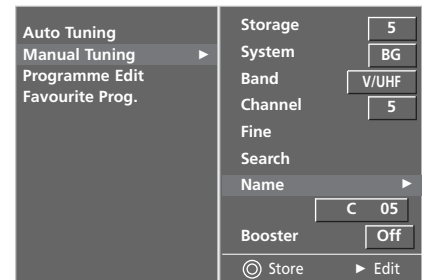

1
2 3 4 5 6

WATCHING TV / PROGRAMME CONTROL

BOOSTER

In some models, **Booster** is an optional function. Only a TV with **Booster** can perform this function.

If reception is poor select **Booster** to On.

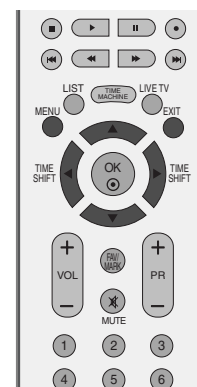

1 Press the **MENU** button and then **▲** / **▼** button to select the **SETUP** menu.

2 Press the **▶** button and then **▲** / **▼** button to select **Manual Tuning**.

3 Press the **▶** button and then use **▲** / **▼** button to select **Booster**.

4 Press the **▶** button and then use **◀** / **▶** button to select **On** or **Off**.

5 Press the **EXIT** button to return to normal TV viewing.



1

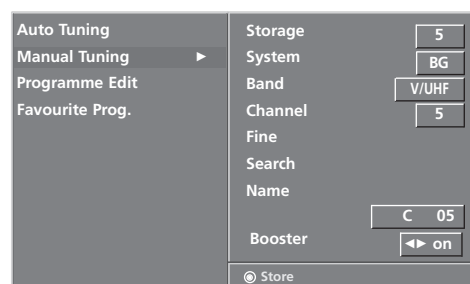

2 3

PROGRAMME EDIT

This function enables you to delete or skip stored programmes. You can also move some channels to other programme numbers or copy a blank channel data into the selected programme number.

It is not possible to use this function whilst recording a programme.

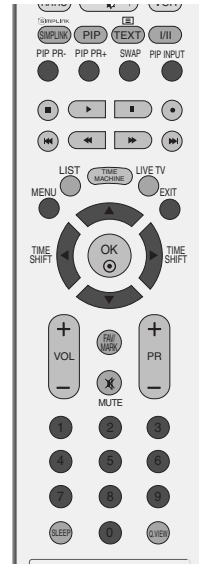

1 Press the **MENU** button and then **▲ / ▼** button to select the **SETUP** menu.

2 Press the **▶** button and then **▲ / ▼** button to select **Programme Edit**.

3 Press the **▶** button to display the Programme edit menu.

■ Deleting a programme

1. Select a programme to be deleted with the **▲ / ▼ / ◀ / ▶** button.
2. Press the **RED** button twice.
The selected programme is deleted, all the following programmes are shifted up one position.

■ Copying a programme

1. Select a programme to be copied with the **▲ / ▼ / ◀ / ▶** button.
2. Press the **GREEN** button.
All the following programmes are shifted down one position.

■ Moving a programme

1. Select a programme to be moved with the **▲ / ▼ / ◀ / ▶** button.
2. Press the **YELLOW** button.
3. Move the programme to the desired programme number with the **▲ / ▼ / ◀ / ▶** button.
4. Press the **YELLOW** button again to release this function.

■ Skipping a programme number

1. Select a programme number to be skipped with the **▲ / ▼ / ◀ / ▶** button.
2. Press the **BLUE** button. The skipped programme turns to blue.
3. Press the **BLUE** button again to release the skipped programme.

When a programme number is skipped it means that you will be unable to select it using the **▲ / ▼** button during normal TV viewing. If you want to select the skipped programme, directly enter the programme number with the **NUMBER** buttons or select it in the programme edit or table menu.

4 Press the **EXIT** button to return to normal TV viewing.



1



2

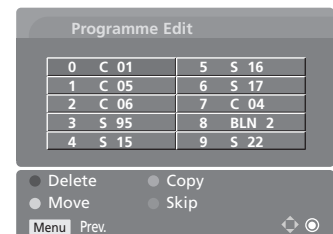

3

WATCHING TV / PROGRAMME CONTROL

FAVOURITE PROGRAMME

This function lets you select your favourite programmes directly.

Repeatedly press the **FAV** button to select stored favourite programmes.

1 Press the **MENU** button and then **▲ / ▼** button to select the **SETUP** menu.

2 Press the **▶** button and then **▲ / ▼** button to select **Favourite Prog..**

3 Press the **▶** button.

4 Press the **▲ / ▼** button to select - - - - -.

5 Select a desired programme with the **◀ / ▶** button or **NUMBER** buttons. Any number under 10 is entered with a numeric '0' in front of it, i.e. '05' for 5.

6 To store another programme, repeat steps **4** to **5**. You can store up to 8 programmes.

7 Press the **EXIT** button to return to normal TV viewing.

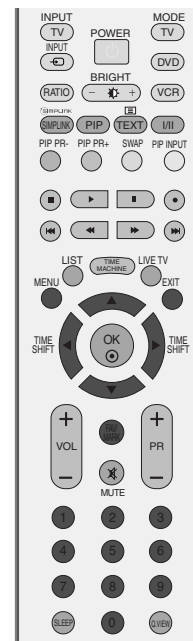

1

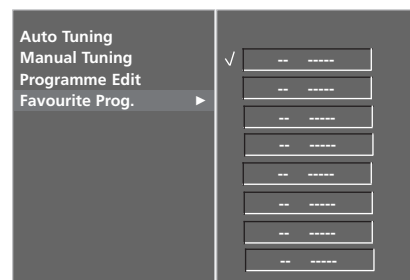

2 3 4 5

CALLING THE PROGRAMME LIST

You can check which programmes are stored in the memory by displaying the programme list.



Programme List

0	-----	5	S 02
1	C 01	6	S 04
2	C 04	7	C 08
3	C 05	8	S 11
4	BLN 2	9	S 28

■ Displaying programme List

Press the **LIST** button to display the Programme List menu.

The programme list appears on the screen.

One programme list contains ten programmes as shown.

! NOTE

- You may find some blue programmes. These have been set up to be skipped by auto programming or in the programme edit mode.
- Some programmes with the channel number shown in the programme list indicate there is no station name assigned.

■ Selecting a programme in the programme List

Select a programme with the **▲ / ▼ / ◀ / ▶** button.

Then press the **OK** button. The set switches to the chosen programme number.

■ Paging through a programme List

Programme LIST pages contain 100 programmes in total. Pressing the **▲ / ▼ / ◀ / ▶** button repeatedly turns the pages.

Press the **LIST** button to return to normal TV viewing.

WATCHING TV / PROGRAMME CONTROL

INPUT SOURCE SELECTION

Selects a label for each input source which is not in use when you press **INPUT** button.

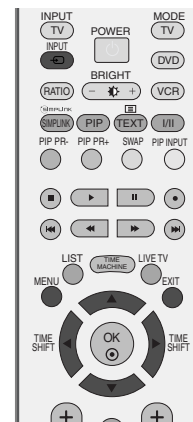

1 Press the **MENU** button and then use ▲ / ▼ button to select the **OPTION** menu.

2 Press the ► button and then use ▲ / ▼ button to select **Input Label**.

3 Press the ► button and then use ▲ / ▼ button to select the source: AV1, AV2, Component1/2, RGB, HDMI1/DVI or HDMI2.

4 Press the ► button and then use ▲ / ▼ button to select the label.

5 Press **EXIT** button to return to normal TV viewing.

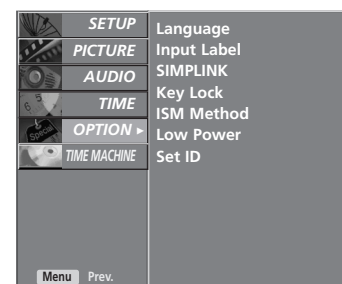

1

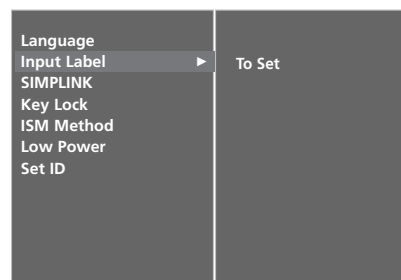

2

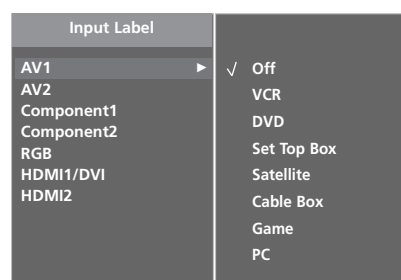

3

KEY LOCK

The TV can be set so that the remote control is needed to control it.

This feature can be used to prevent unauthorized viewing.

This TV is programmed to remember which option it was last set to even if you turn the TV off.

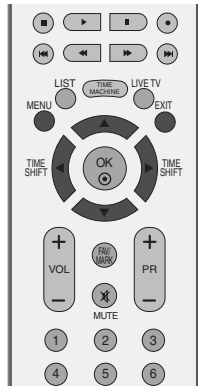

1 Press the **MENU** button and then **▲ / ▼** button to select the **OPTION** menu.

2 Press the **▶** button and then **▲ / ▼** button to select **Key Lock**.

3 Press the **▶** button and then **▲ / ▼** button to select **On** or **Off**.

4 Press the **EXIT** button to return to normal TV viewing.



1

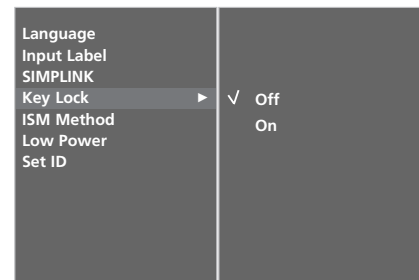

2 3

! NOTE

- ▶ In **Key Lock 'On'**, if the TV is turned off, press the **⏻ / I**, **INPUT**, **PR ▲ / ▼** button on the TV or **POWER**, **INPUT**, **TV**, **PR +/-** or **NUMBER** buttons on the remote control then the TV will be turned on.
- ▶ With the **Key Lock On**, the display '**! Key Lock On**' appears on the screen if any button on the front panel is pressed while viewing the TV.

WATCHING TV / PROGRAMME CONTROL



This function operates only with devices with the SIMPLINK logo.
Please check the SIMPLINK logo.

This allows you to control and play other AV devices connected to the display through HDMI cable without additional cables and settings.

If you do not require the SIMPLINK menu, select "Off".

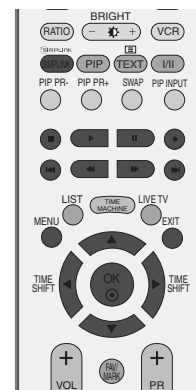

1 Press the **MENU** button and then **▲ / ▼** button to select the **OPTION** menu.

2 Press the **▶** button and then **▲ / ▼** button to select **SIM-PLINK**.

3 Press the **▶** button and then **▲ / ▼** button to select **On** or **Off**.

4 Press the **EXIT** button to return to normal TV viewing.



1

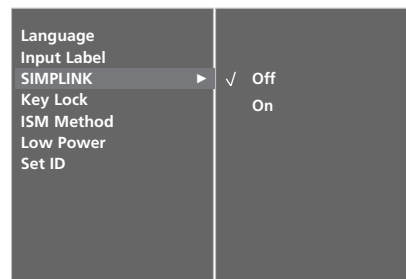

2 3

SIMPLINK Functions

Disc playback

Control connected AV devices by pressing the ▲ / ▼ / ◀ / ▶, OK buttons and buttons for play, stop, pause, fast reverse, fast forward, chapter skip. (The ⏻ button does not provide such functions)

Direct Play

After connecting AV devices to the TV, you can directly control the devices and play media without additional settings.

Select AV device

Enables you to select one of AV devices connected to TV and play it.

Power off all devices

When you switch off the TV, all connected devices are turned off.

Switch audio-out

Offers an easy way to switch audio-out.

* A device, which is connected to the TV through a HDMI cable but does not support SIMPLINK, does not provide this function.

SIMPLINK Menu

Press the ▲ / ▼ / ◀ / ▶ button and then OK button to select the desired SIMPLINK source.

- ① **TV viewing** : Switch to the previous TV programme regardless of the current mode.
- ② **DISC playback** : Select and play discs. When multiple discs are available, the titles of the discs are conveniently displayed at the bottom of the screen.
- ③ **VCR playback** : Control the connected VCR.
- ④ **HDD Recordings playback** : Control recordings stored in HDD.
- ⑤ **Audio Out to Home theater/Audio Out to TV** : Select Home theater or TV speaker for Audio Out.



! NOTE

- ▶ Connect the HDMI/DVI IN or HDMI IN terminal of the TV to the rear terminal (HDMI terminal) of the SIMPLINK device with the HDMI cable.
- ▶ After connecting the HDMI terminal for the home theater with SIMPLINK function using the above method, connect the VARIABLE AUDIO OUT terminal on the back of the TV to the VARIABLE AUDIO IN terminal on the back of the SIMPLINK device with the VARIABLE AUDIO OUT cable.
- ▶ When operating an external device with SIMPLINK, press the TV button from the MODE buttons on the remote control.
- ▶ When you switch the Input source using the INPUT button on the remote control, you can stop the operation of a device controlled by SIMPLINK.
- ▶ When you select or operate a media device with home theatre function, the speaker automatically switches to home theatre speaker (HT speaker).
- ▶ If the SIMPLINK is operated, the keys such as stop / play / pause / fast reverse / fast forward / chapter skip are used for driving the SIMPLINK device, but not used for the TIME MACHINE feature.

TIME MACHINE

TIMESHIFT MODE(PAUSE & REPLAY OF LIVE TV)

This function allows the unit to automatically record live TV and make it available for viewing at any time.

With the TimeShift Mode turned on, you may pause and rewind normal TV viewing at any time without missing any of the live broadcast.

(TimeShift Mode and Recording functions may not work if the signal strength is weak.)

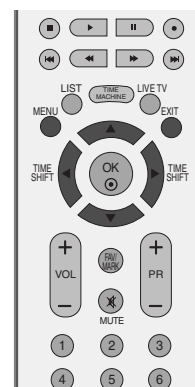

1 Press the **MENU** button and then use ▲ / ▼ button to select the **TIME MACHINE** menu.

2 Press the ► button and then use ▲ / ▼ button to select the **TimeShift Mode**.

3 Press the ► button and then use ▲ / ▼ button to select **On** or **Off**.

4 Press the **EXIT** button to return to normal TV viewing.

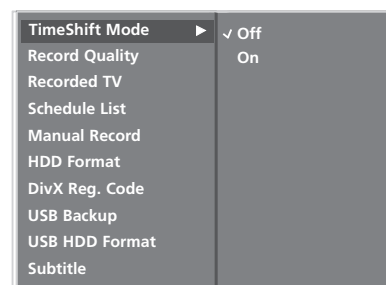

Using the TimeShift Mode function

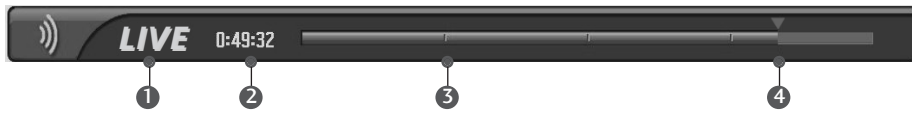

- 1 After selecting **TimeShift Mode On**, press the **OK** button.
 - As soon as Timeshift starts, a progress bar indicating the current recording status is displayed in the bottom of the screen.
 - Press the **EXIT** button to hide the 'Progress Bar' or press the **OK** button to display the 'Progress Bar'.
 - This function is preserved even change a programme on progressing the Timeshift.

The 'Progress Bar'?

This function indicates what TIME MACHINE reviewing is possible, a current on-screen and live broadcasting position.

- 1 Status of current displayed video.
- 2 Current save time.
- 3 15 minute intervals from TimeShift Mode start time. (Total - one hour).
- 4 Indicates current TimeShift Mode position.

- 2 When finishing the Timeshift function, enter the **TIME MACHINE** menu and turn **TimeShift Mode Off**.

! NOTE

- ▶ **TIME MACHINE** : A device which records and plays broadcast programme contents onto a hard disk in set or SET TOP BOX.
- ▶ In order to save hard-disk space, nothing is saved when there is no signal.
- ▶ The total storage space of the hard-disk is 80 GB. 4 GB minimum is reserved for TimeShift Mode.
- ▶ When turning power on, it may take up to a maximum of 3 minutes to initialize the HDD.
- ▶ The Recording function will not initiate for a copy-protected programme.
- ▶ Because an analogue broadcast is converted to a digital signal, video which contains rapid movement may show "cross stripes". This happens when the analog signal is compressed and then restored in the digital signal. The unit will attempt to reduce excessive picture interference.
- ▶ When using the PIP/DW mode, Timeshift is stopped.
- ▶ TimeShift Mode is available in TV, AV1, AV2, Component(480i/480p/576i/576p/720p/1080i) mode.
- ▶ TimeShift Mode is not available for Audio only channels.
- ▶ Maximum recording file size is up to 16GB(4Hr).

TIME MACHINE

Using the TimeShift Mode function, play

- When in timeshift mode, the following options are available.



Indicates that the current broadcast and displayed video differ.



- When pressing the ● button delaying Timeshift, Timeshift is dumped. And delayed time is recording.

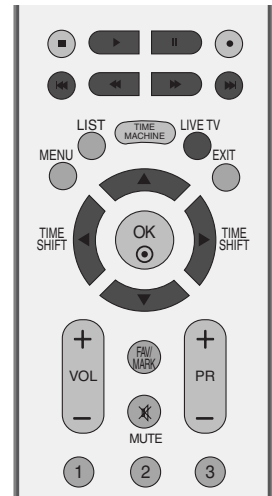

Using the remote control

You can shift playback to any point within the recorded programme

◀◀ / ▶▶	<p>When playing,</p> <p>repeatedly, press the REW(◀◀) button to speed up ◀◀ -> ◀◀◀◀ -> ◀◀◀◀◀◀ -> ◀◀◀◀◀◀◀◀ -> ◀◀◀◀◀◀◀◀◀◀◀◀ .</p> <p>repeatedly, press the FF(▶▶) button to speed up ▶▶-> ▶▶▶▶ -> ▶▶▶▶▶▶ -> ▶▶▶▶▶▶▶▶ .</p> <ul style="list-style-type: none"> ■ Pressing these buttons repeatedly increases the fast forward/reverse speed.
◀◀ / ▶▶	<p>Press the ▶▶ button to jump about 20 seconds forward.</p> <ul style="list-style-type: none"> ■ Pressing the ◀◀ button to jump about 8 seconds back.
	<p>During playback, press the Pause() button.</p> <ul style="list-style-type: none"> ■ Still screen is displayed. ■ Repeatedly press the Pause() button to advance frame by frame. ■ Press the Pause() button and then use the FF(▶▶) button for slow motion (the ▶ icon is displayed.) ■ Press the Pause() button and then use the FF(◀◀) button for slow motion (the ◀ icon is displayed.)
◀ / ▶	<ul style="list-style-type: none"> ■ When using the ◀ or ▶ button during playback a cursor indicating the position can be viewed on the screen.
PLAY(▶)	<p>Press the PLAY(▶) button to return to normal playback.</p>
LIVE TV	<p>If you want to return to the current live broadcast, press the LIVE TV button.</p>

FORMAT HARD DISK

Erases all programmes and initializes the hard disk.

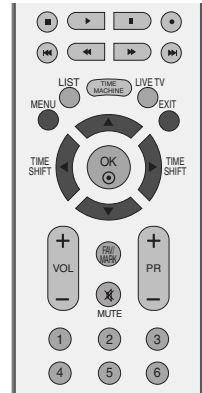

- 1 Press the **MENU** button and then use ▲ / ▼ button to select the **TIME MACHINE** menu.
- 2 Press the ► button and then use ▲ / ▼ button to select **HDD Format**.
- 3 Press the ► button to start **HDD Format**.

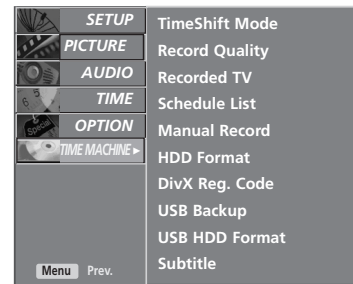

1

■ if you press the ► button, this message is displayed.

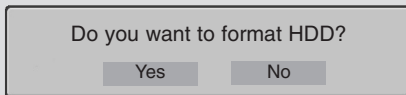

■ if you select Yes, this message is displayed.

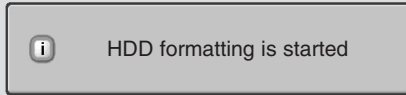

■ When completing, this message is displayed.

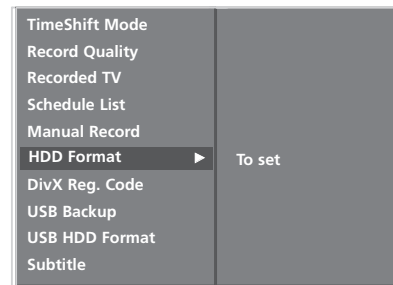
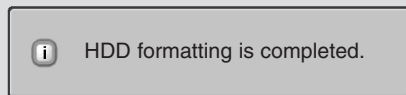

2 3

- 4 Press the **EXIT** button to return to normal TV viewing.

INSTANT RECORDING

Use this function to record the programme you are watching on the main screen.

Instant Record

This function records the currently displayed programme.

- 1 Select the programme you wish to record and then press the ● button. During recording  is displayed. Use this feature to record up to 2 hours of programming.

- 2 If you wish to stop recording, press the ■ button.

- While recording, if you press the ■ button less than 10 seconds after recording started, this message is displayed.
- If you press the ■ button more than 10 seconds after recording started, this message is displayed.



Recording is not completed.
Recording time must exceed 10 seconds.

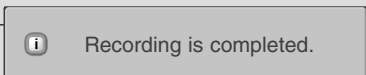

Recording is completed.

- 3 You can increase or decrease the recording time by pressing the ● button while recording. After pressing the ● button, press the ◀ / ▶ buttons repeatedly to increase or decrease the recording time. Each time you press ◀ / ▶ button the recording duration changes as shown below.

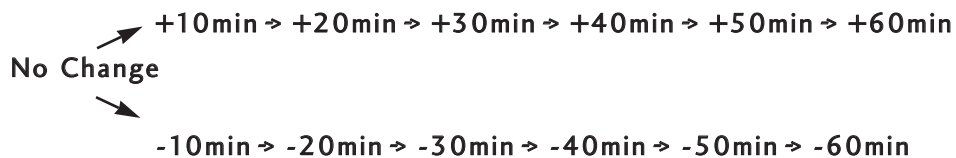

↗ +10min → +20min → +30min → +40min → +50min → +60min
No Change
↘ -10min → -20min → -30min → -40min → -50min → -60min

The extra recording time added to the existing setting equals the final recording time.

- 4 After adjusting the recording time, select **OK**. The Status bar will be displayed.

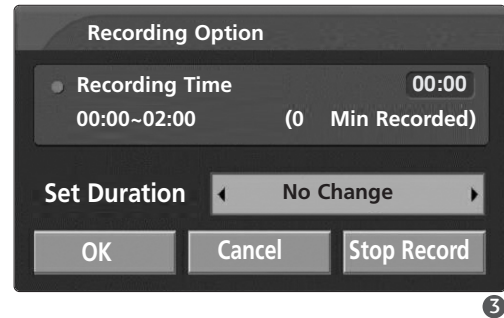
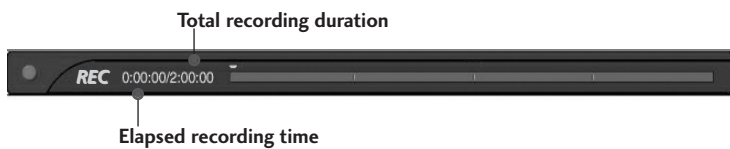

- Press the **EXIT** button to hide the Status bar. Press the **OK** button to display the Status bar.

- 5 Recording stops when the selected duration is reached or when you press the **■** button. Although recording has stopped, the Timeshift feature remains active.

! NOTE

- ▶ When recording, if the available storage space is not sufficient, the recording will automatically Stop.
- ▶ Recordings of less than 10 seconds will not be saved.
- ▶ To save disk space while recording broadcasts, no data will be saved if there is no signal.
- ▶ The recording function will not initiate for a copy-protected programme.
- ▶ The displayed time may differ slightly from the actual time.
- ▶ When there is no signal or a film source is being viewed, the displayed time may differ slightly from the actual time.
- ▶ Timeshift recording is not possible with copy-protected programmes.

 Stop recording due to copy protection.

- ▶ When a poor quality external source is recorded (for example old VHS tape) the quality of the recording will not be optimal.
- ▶ Programmes are stored separately according to the colour system used. e.g. PAL/NTSC.
- ▶ Manual Recording available time is maximum 4 hours and minimum 5 minutes.

TIME MACHINE

MANUAL RECORD

This function is easy to register to reserved recording.

This function is also available in TIME MACHINE menu.

When Manual Recording, the default sound of the set is stored.

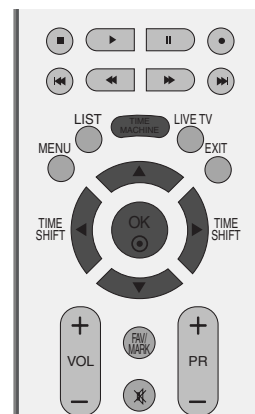

- 1 Press the **TIME MACHINE** button to display **Home** menu. Use the ▲ / ▼ button to select the **Manual Record** and then use the **OK** or ► button.

- 2 The **Manual Record** screen is displayed as shown below. Use the ▲ / ▼ / ◀ / ▶ button to set the **Input**, **PR**, **Date**, **Time**, **Duration**, **Frequency** .

- ▶ **Input** : Select the input source from the TV, AV1, AV2, Component1/2 (480i/576i).
- ▶ **PR** : Select either the current programme or a scanned programme.
- ▶ **Date** : You can select a date up to one month in advance.
- ▶ **Time /Duration** : Ensure you have set correctly.
- ▶ **Frequency** : Choose among Once, Daily and Weekly.

- 3 After setting the **Manual Record** , press the **OK** button.

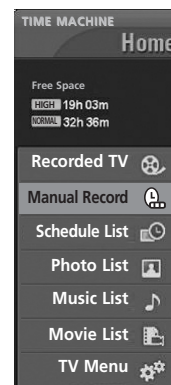

1

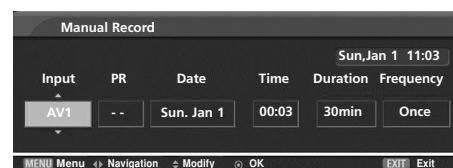

2

SCHEDULE LIST

This function is used to show scheduled recordings.
 This function is also available in the TIME MACHINE menu.

You can store up to 8 programmes.

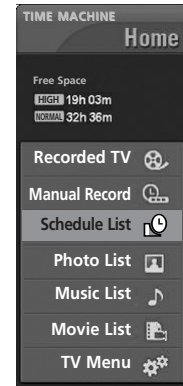
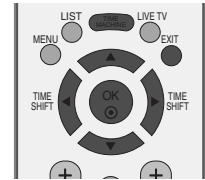

- 1 Press the **TIME MACHINE** button to display **Home** menu. Use the ▲ / ▼ button to select the **Schedule List** and then use the **OK** or ► button.
- 2 The **Schedule List** screen is displayed as shown below. Use the ▲ / ▼ button to select a recorded programme.

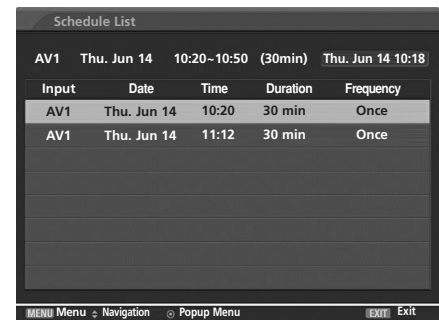

RECORD QUALITY

When recording analogue broadcasts and external input signals, the Record Quality can be selected.

This function is not available while a recording is taking place.

- 1 Press the **MENU** button and then use ▲ / ▼ button to select the **TIME MACHINE** menu.
- 2 Press the ► button and then use ▲ / ▼ button to select **Record Quality**.
- 3 Press the ► button and then use ▲ / ▼ button to select **High** or **Normal**.
- 4 Press the **EXIT** button to return to normal TV viewing.

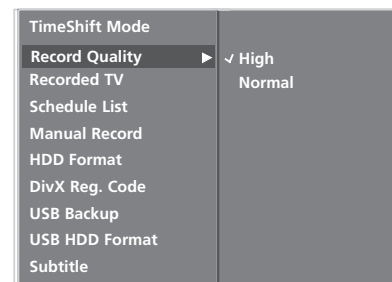

TO USE THE USB DEVICE

Precautions when using the USB device

- ▶ Only a USB storage device is recognizable.
- ▶ If the USB storage device is connected through a USB hub, the device is not recognizable.
- ▶ A USB storage device using an automatic recognition programme may not be recognized.
- ▶ A USB storage device which uses its own driver may not be recognized.
- ▶ In case of a card reader, up to four memory cards are concurrently recognizable.
- ▶ The recognition speed of a USB storage device may depend on each device.
- ▶ Please do not turn off the TV or unplug the USB device when the connected USB storage device is working. When such device is suddenly separated or unplugged, the stored files or the USB storage device may be damaged.
- ▶ Please do not connect the USB storage device which was artificially maneuvered on the PC. The device may cause the product to malfunction or fail to be played. Never forget to use only a USB storage device which has normal music files or image files.
- ▶ Please use only a USB storage device which was formatted as a FAT32 file system provided with the Windows operating system. In case of a storage device formatted as a different utility programme which is not supported by Windows, it may not be recognized.
- ▶ Please connect power to a USB storage device which requires an external power supply. If not, the device may not be recognized.
- ▶ Please connect a USB storage device with cable is offered by USB maker. If connected with cable is not offered by USB maker or an excessively long cable, the device may not be recognized.
- ▶ Some USB storage devices may not be supported or operated smoothly.
- ▶ If the name of a folder or file is too long, it will not be displayed or recognized.
- ▶ Please backup the important file because a data of USB device may be damaged. Data management is consumer's responsibility and in consequence the manufactures does not cover the product bearing data damage.
- ▶ Supported maximum external HDD size is up to 400GB.
- ▶ Supported maximum USB memory stick size is up to 32GB.

When connecting the USB device

Enjoy the recorded media, photo, music and Movie stored in the USB device. When you connect a USB device, this screen is displayed, automatically.

In USB device, you can not add a new folder or delete the existing folder.

- 1 Connect the USB device to the **USB IN** jacks on the side of TV.
- 2 Press the ▲ / ▼ button to select the desired item.
- 3 Press the OK button.

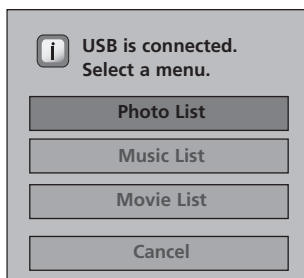
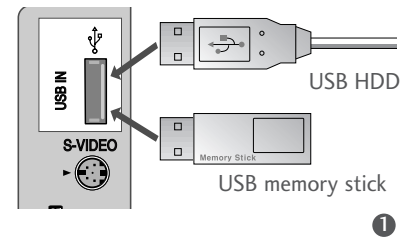

For the case when the USB which contains photo, music, and movie files is connected



For the case when the USB which defaulted to backup use of the record list

2 3

2 3

To use the recorded list with USB storage device

- 1 Connect the USB device to the **USB IN** jacks on the side of TV.

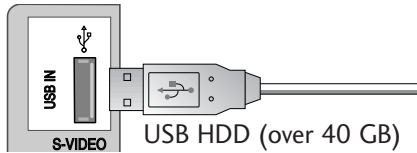

- Only USB HDD that are over 40 GB and 1 partition can be used for USB Backup.

- 2 To use the USB storage device (over 40 GB) for USB Backup, execute the “USB HDD Format”

- It initialises the HDD connected to the USB as disk mode for backup.
- It is activated only when the USB HDD available for backup is connected.
- When “USB HDD Format” is executed, all the data stored in the USB storage device is deleted.
- While performing “USB HDD Format”, do not remove the USB storage device. It may cause error on the TV and the storage device.

- 1 Press the **MENU** button and then use ▲ / ▼ button to select the **TIME MACHINE** menu.
- 2 Press the ► button and then use ▲ / ▼ button to select **USB HDD Format**.
- 3 Press the ► button to start **USB HDD Format**.

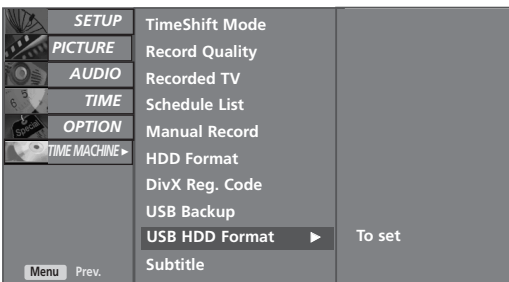

- if you press the ► button, this message is displayed.

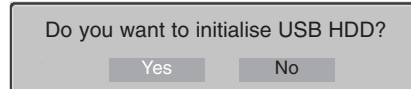

When ‘Yes’ is selected, a pop-up notice appears containing a message to initialise the connected USB HDD.

When initialisation is complete, a pop-up notice of completion is displayed and the connected USB HDD is available for backup.

- Depending on the capacity of the USB storage device, the initialisation time may vary.
- The initialised USB storage device only operates in the “Recorded List”.
- The initialised USB storage device is not recognised by the PC.
- When a USB storage device of less than 40 GB is connected, the “USB HDD Format” is not activated.
- Supported maximum external HDD size for back-up is up to 400GB.

! NOTE

- ▶ When attempting to access the USB Backup of the TIME MACHINE menu after the initialisation, an alert message is displayed and access is blocked because there are no backed up items.
- ▶ When even a single backed up file exists through ‘Copy to USB HDD’ from the ‘Recorded TV’ of the TIME MACHINE menu, the access to USB Backup is allowed.

- 3 Press the **TIME MACHINE** button to display **HOME** menu.
Use the ▲ / ▼ button to select **Recorded TV** and then use the **OK** or ► button.

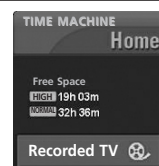

TIME MACHINE

RECORDED TV PROGRAMME LIST

You can view the recorded programme list at a glance.
This function is also available in the TIME MACHINE menu.

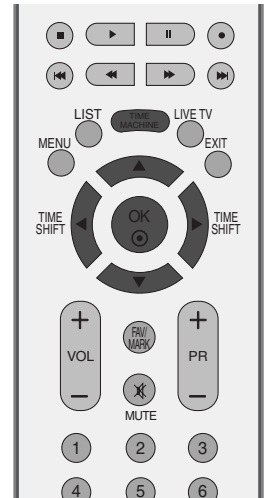

- 1 Press the **TIME MACHINE** button to display **HOME** menu. Use the **▲ / ▼** button to select **Recorded TV** and then use the **OK** or **▶** button.

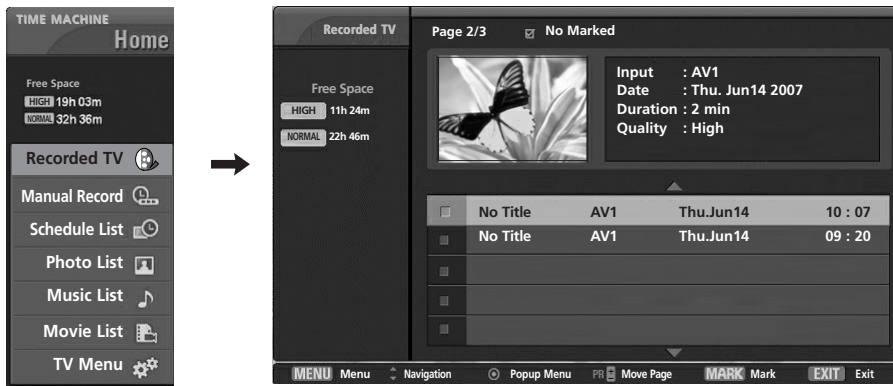

TIME MACHINE

Screen Components

- 1 Usable HDD space
- 2 Current page/Total pages
- 3 Marked title or programme
- 4 Corresponding buttons on the remote control

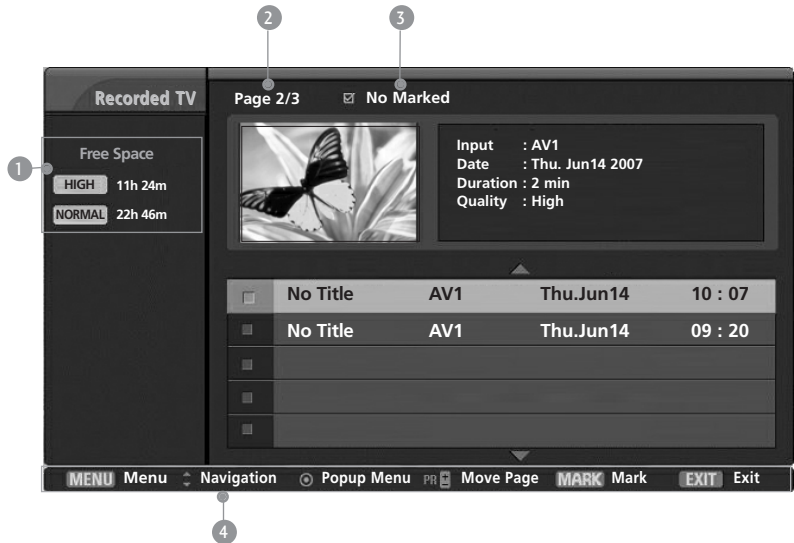

Recorded programme Selection and Popup Menu

The recorded programme stored in the internal HDD or the USB storage device can be played.

The preview recorded list is shown above.

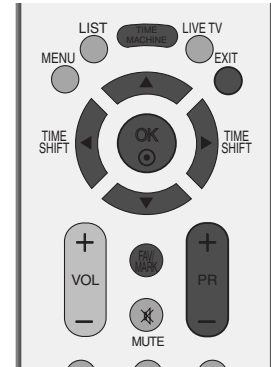

1 Use the **PR +/-** button for page up/down navigation.

2 Use the **MARK** button to delete from the list. A is displayed next to the preview window if an item is marked.

3 Use **▲ / ▼** button to navigation the appropriate Recorded programme, then press the **OK** button to open the Pop-up Menu.

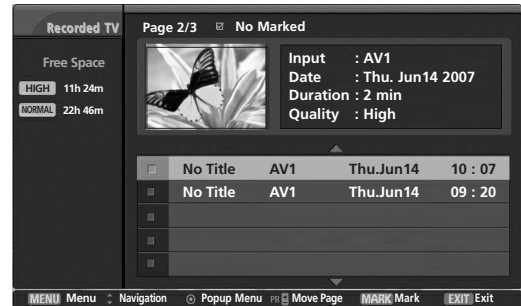

1

- ▶ **Play** : Begin playback of selected recorded programme.
- ▶ **Mark All** : mark all recorded programmes on the screen.
- ▶ **Unmark All** : Change marked recorded programmes to unmarked recorded programmes.
- ▶ **Delete** : Delete the selected recorded programmes.
- ▶ **Rename** : Edit recorded programme title.
- ▶ **Copy to USB HDD** : Copies the recorded programme in the internal HDD to the USB storage device.

It is activated only when a USB HDD available for backup is connected.

<HDD Backup process screen>

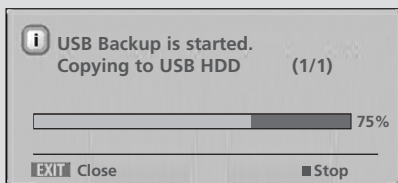

■ if you press the **■** button, this message is displayed.

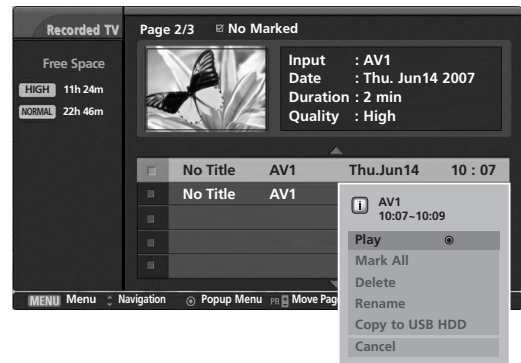
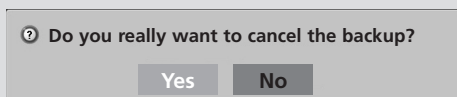

2 3

TIME MACHINE

- When 'Yes' is selected, the backup is cancelled and is converted back to input mode. If more than two files are transferred, the transferred file is stored, and the backup operations on the files in progress of transferring and scheduled for backup are cancelled.
- When 'No' is selected, returns to the backup process screen.





While backup is being performed in the background, the status of the copy progress can be checked by pressing the 'OK' button.

► **Cancel** : Close the Pop-up menu.

4 Repeatedly, press the **EXIT** button to return to TV viewing or press the **TIME MACHINE** button to return to the **Home** menu.

- If the HDD has a problem performing a recording related function, this message is displayed.
- If the temperature is below zero (0°), a warning message is displayed and you will not be able to use the **TIME MACHINE** functions.

 HDD initialisation is in progress.

 Cannot operate **TIME MACHINE** at low temperature.

USB BACKUP

- When the Recorded List is stored exceeding the capacity of the internal HDD, the USB backup feature allows the backup of Recorded List of the internal HDD to the external HDD for backup connected through USB.
- To use USB backup function, be sure to initialize the USB HDD using TIME MACHINE menu- USB HDD format.
- To use USB Backup, USB HDD is necessary more than 40 GB, 1 partition disk, and FAT32 system.
- It only supports file backup features; therefore, playback of the Recorded List directly from the current OSD is not allowed. In order to play the recorded contents, the files must be moved to the internal HDD through the 'Copy to Recorded List' from the popup menu.
- View the list of the backed up recorded programme by using the 'Copy to USB HDD' from the 'Recorded TV'.
- It moves to the external HDD list for backup connected by USB.

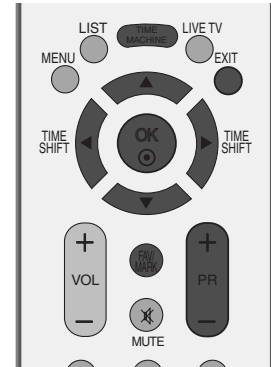

- 1 Press the **MENU** button and then use ▲ / ▼ button to select the **TIME MACHINE** menu.
- 2 Press the ► button and then use ▲ / ▼ button to select **USB Backup**.
- 3 Press the ► button to start **USB Backup**.
- 4 **Recorded TV** screen is displayed as shown. Use the **PR +/-** button to navigation in the recorded programme.

Use **MARK** button to mark or unmark a recorded programme.

Use ▲ / ▼ button to navigation the appropriate recorded programme, then press the **OK** button to show up the pop-up menu.

- ▶ **Mark All** : mark all recorded programmes on the screen.
- ▶ **Unmark All** : Change marked recorded programmes to unmarked recorded programmes.
- ▶ **Delete** : Delete the selected recorded programmes.

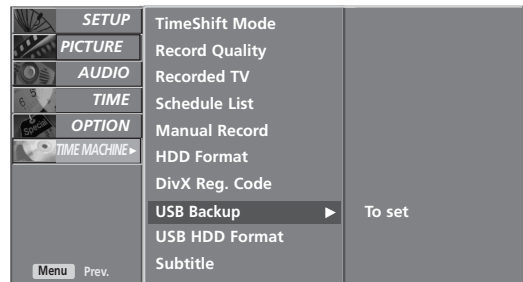

1 2 3

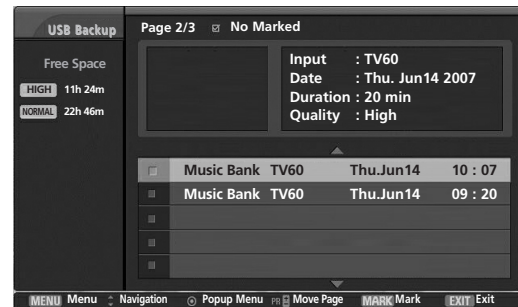

4

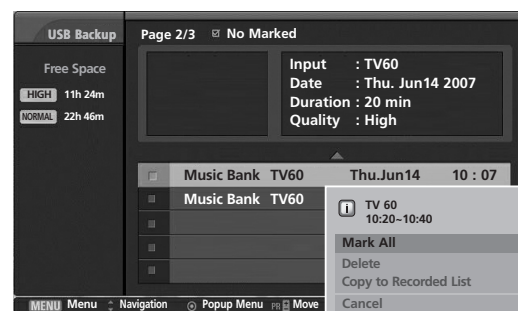

4

- ▶ **Copy to Recorded List** :Restores the Recorded Programme to the internal HDD.

<HDD Backup process screen>

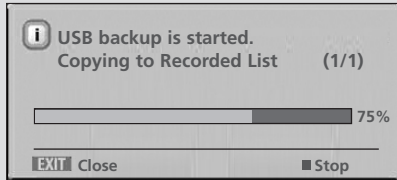

- if you press the **■** button, this message is displayed.

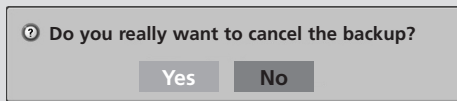

- When 'Yes' is selected, the backup is cancelled and is converted back to input mode. If more than two files are transferred, the transferred file is stored, and the backup operations on the files in progress of transferring and scheduled for backup are cancelled.
- When 'No' is selected, returns to the backup process screen.



While backup is being performed in the background, the status of the copy progress can be checked by pressing the 'OK' button.

- ▶ **Cancel** : Close the pop-up menu.

- 5 Repeatedly, press the **EXIT** button to return to TV viewing or press the **TIME MACHINE** button to return to the **Home** menu.

! CAUTION

- ▶ If you turn the power off on Copying or recording, this message is displayed as shown below.

<copying>

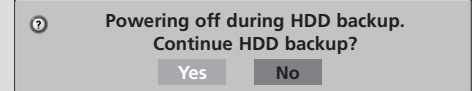

<Copying and recording>

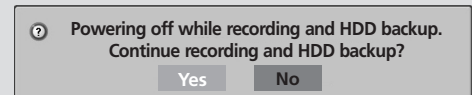

- ▶ If you selects No, Copying stops and then power is off.
- ▶ If you selects Yes, Copying continues and the power is turned off.
- ▶ If you press the **EXIT** button to disappear this message.

! NOTE

- ▶ When even a single back up file exists in the initialised USB HDD (from the USB HDD Format menu) through 'Copy to USB HDD' from the 'Recorded TV', the access to the USB Backup is allowed.
- ▶ If Manual or Instant Record operates while a recorded programme is transferring from USB HDD to Recorded TV, Copying will pause.
Then, press the OK button, and '--%' will be displayed in Record message, and after recording is completed, Copying will continue again.
- ▶ Playback is not available while recording along with USB Backup.

Playing recorded programmes

- You can play a selected programme from the recorded programme list.

- 1 Play a recorded programme.
- 2 While playing, You will see a playback screen as shown below.
 - To stop displaying the recorded programmes icon, press the **EXIT** button.

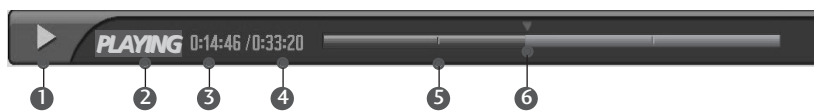

The 'Progress Bar'?

This function indicates what TIME MACHINE reviewing is possible, a current on-screen and live broadcasting position, a section of section-recording.

- 1 Indicates progress of recorded programme.
- 2 Indicates status of recorded programme.
- 3 Indicates elapsed playback time.
- 4 Indicates total playback time.
- 5 Indicates a quarter of programme runtime.
- 6 Indicates current playback position.

Using the remote control

You can shift playback to any point within the recorded programme.

◀◀ / ▶▶	<p>When playing, repeatedly, press the REW(◀◀) button to speed up ◀◀ -> ◀◀◀◀ -> ◀◀◀◀◀◀ -> ◀◀◀◀◀◀◀◀ -> ◀◀◀◀◀◀◀◀◀ .</p> <p>repeatedly, press the FF(▶▶) button to speed up ▶▶-> ▶▶▶▶ -> ▶▶▶▶▶▶ -> ▶▶▶▶▶▶▶▶ -> ▶▶▶▶▶▶▶▶▶▶ .</p> <ul style="list-style-type: none"> ▪ Pressing these buttons repeatedly increases the fast forward/reverse speed.
◀◀ / ▶▶	<p>Press the ▶▶ button to jump about 20 seconds forward.</p> <ul style="list-style-type: none"> ▪ Pressing the ◀◀ button to jump about 8 seconds backward.
	<p>During playback, press the Pause() button.</p> <ul style="list-style-type: none"> ▪ Still screen is displayed. ▪ Repeatedly press the Pause() button to advance frame by frame. ▪ Press the Pause() button and then use the FF(▶▶) button for slow motion (the ▶ icon is displayed.) ▪ Press the Pause() button and then use the FF(◀◀) button for slow motion (the ◀ icon is displayed.)
◀ / ▶	<ul style="list-style-type: none"> ▪ When using the ◀ or ▶ button during playback a cursor indicating the position can be viewed on the screen.
PLAY(▶)	<p>Press the PLAY(▶) button to return to normal playback.</p>
LIVE TV	<p>Press the LIVE TV button to jump at the front of the programme.</p>
STOP(■)	<ul style="list-style-type: none"> ▪ If you press the STOP(■) button, you can view live TV.

TIME MACHINE

PHOTO LIST

It's available to playback the photo file(*.jpg) in the USB device.

The On Screen Display may be different from your TV. Images are an example to assist with the TV operation.

Supports up to four drives.

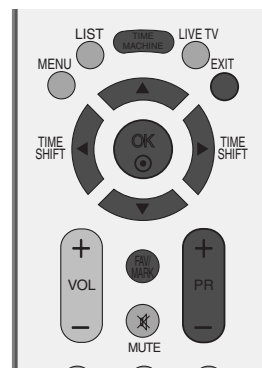

PHOTO(*.JPEG) supporting file

Baseline: width<=4800, height is no limit

- You can play JPEG files only.
- Only baseline scan is supported among JPEG.
- Non-supported files are displayed in the form of icon.

Screen Components

- Press the **TIME MACHINE** button and then use ▲ / ▼ button to select the **Photo List** menu.

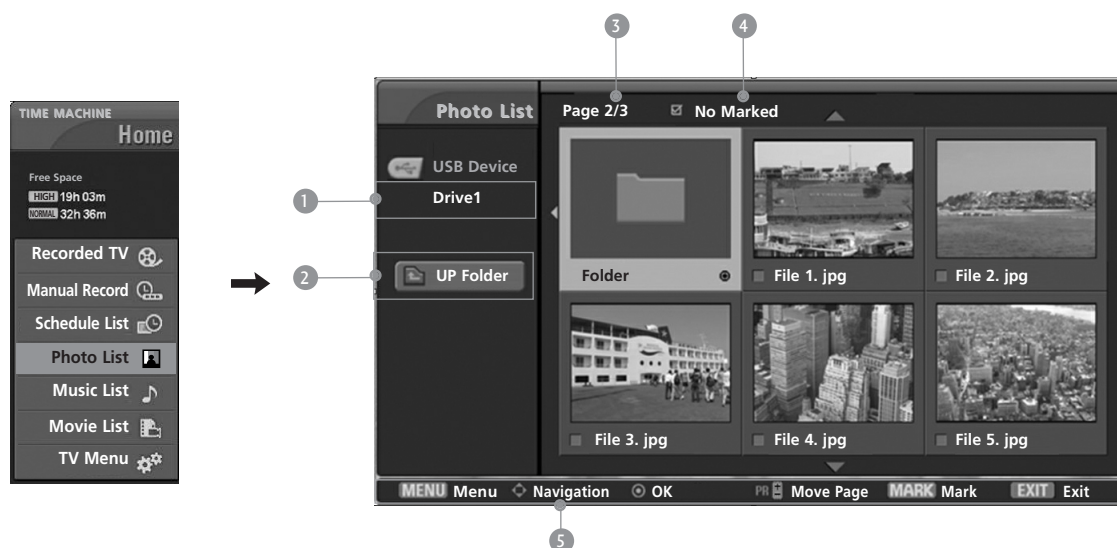

- ① Displays the selected drive
- ② Moves to upper level file
- ③ Current page/Total pages
- ④ Total number of marked thumbnail photos
- ⑤ Corresponding buttons on the remote control

Photo Selection and PopUp Menu

As shown, up to 6 thumbnail photos are listed per page.

- 1 Use ▲ / ▼ / ◀ / ▶ buttons to select the target folder or drive then press **OK**.
- 2 Use the **PR +/-** button to navigation in the thumbnail photo page.
- 3 Use the **MARK** button to mark or unmark a photo. When one or more photos are marked, you can view individual photos or a slide show of the marked photos. If no photos are marked, you can view all photos individually or all photos in the folder in a slide show.
- 4 Use ▲ / ▼ / ◀ / ▶ button to navigation the appropriate thumbnail photos, then press the **OK** button to show the PopUp menu.

- ▶ **View** : Display the selected item.
- ▶ **Mark All** : Mark all photos on the screen.
- ▶ **Unmark All** : Deselect all marked photos.
- ▶ **Cancel** : Close the pop-up menu.

- 5 Repeatedly, press the **EXIT** button to return to TV viewing or press the **TIME MACHINE** button to return to the **Home** menu.

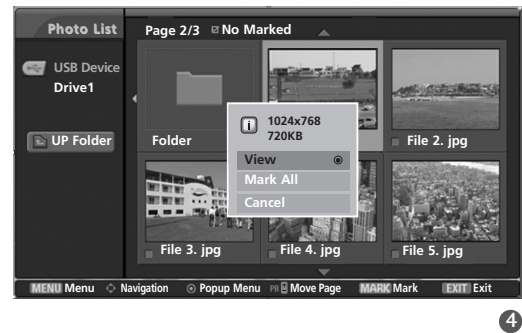

Set up the menu in Full-Sized Screen

You can change the settings to display photos stored on a USB device, on a full-sized screen.

Detailed operations are available on full-sized photo view screen.

- 1 Use ▲ / ▼ / ◀ / ▶ buttons to select the target folder or drive then press **OK**.
- 2 Use the **PR +/-** button to navigation the thumbnail photo page.
- 3 Use ▲ / ▼ / ◀ / ▶ button to navigation the appropriate thumbnail photos, then press the **OK** button to show the PopUp menu.
- 4 Use ▲ / ▼ button to Move to the **View** menu, then press the **OK** button.
- 5 The selected photo is displayed in full size.

- ▶ **Slide Show** : When no picture is selected, all photos in the current folder are displayed during slide show. When selected, the selected photos are displayed during slide show. To start slide show, press **OK** button on **Slideshow** .
 - Set the time interval of the slide show in **Option**.
- ▶ **BGM** : Listen to music while viewing photos in full size. To start BGM, press **OK** button on **BGM** .
 - Set the BGM device and album in **Option** .
- ▶ **⤴ (Rotate)** : Rotate photos.
 - Rotates the photo 90° clockwise upon **OK** button on **⤴ (Rotate)**.



1 2 3 4

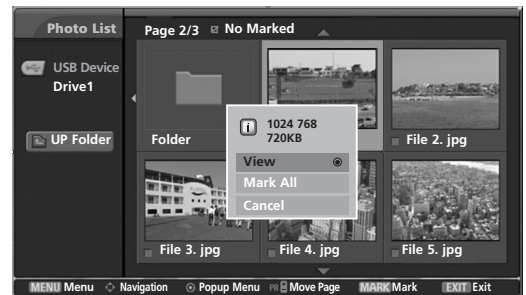

5

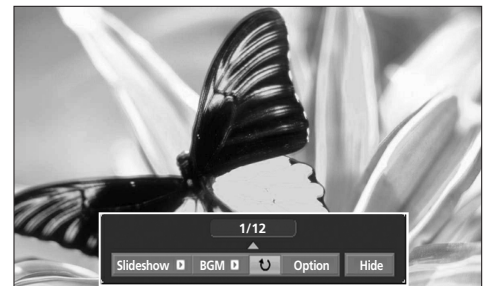

The aspect ratio of a photo may change the size of the photo displayed on the screen in full size.

5

- ▶ **Option** : Set values for **Slide Speed** and **Music folder**. Use ◀ / ▶ button to select **Option** and press **OK** button.
 - Use ◀ / ▶ button and **OK** button to set values. Then go to **OK** and press **OK** to save the settings.
 - You cannot change **Music Folder** while BGM is playing.
- ▶ **Hide** : Hide the menu on the full-sized screen. Use ◀ / ▶ button to select **Hide** and press **OK** button.
 - To see the menu again on the full-sized screen, press **OK** button to display.

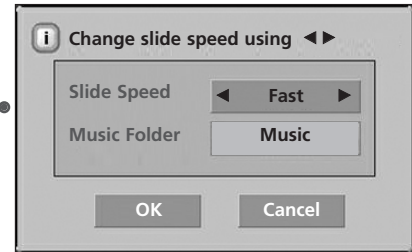

- 6 Use ▲ / ▼ / ◀ / ▶ button to select the previous or next photo.
Use ▲ / ▼ / ◀ / ▶ button to select and control the menu on the full-sized screen.
- 7 Use **EXIT** button to go back to the photo list from the full-sized screen.
- 8 Repeatedly, press the **EXIT** button to return to TV viewing or press the **TIME MACHINE** button to return to the **Home** menu.

! NOTE

- ▶ If it is Progressive JPEG format, some photos may be not decoded.

TIME MACHINE

MUSIC LIST

Purchased music files(*.MP3) may contain copyright restrictions. Playback of these files may not be supported by this model.
Music file on your USB device can be played by this unit.

The On Screen Display may be different from your TV. Images are an example to assist with the TV operation.

Supports up to four drives.

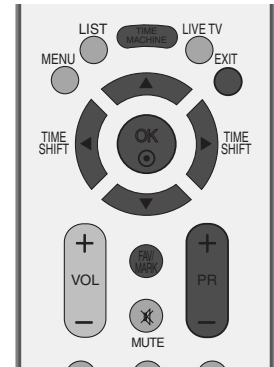

MUSIC(*.MP3) supporting file

Bitrate range 8Kbps ~ 320Kbps

•Sampling rate

MPEG1 : 32000, 44100, 48000Hz

MPEG2 : 16000, 24000, 22050Hz

MPEG2.5 : 8000, 11025, 12000Hz

Screen Components

- Press the **TIME MACHINE** button and then use **▲ / ▼** button to select the **Music List** menu.

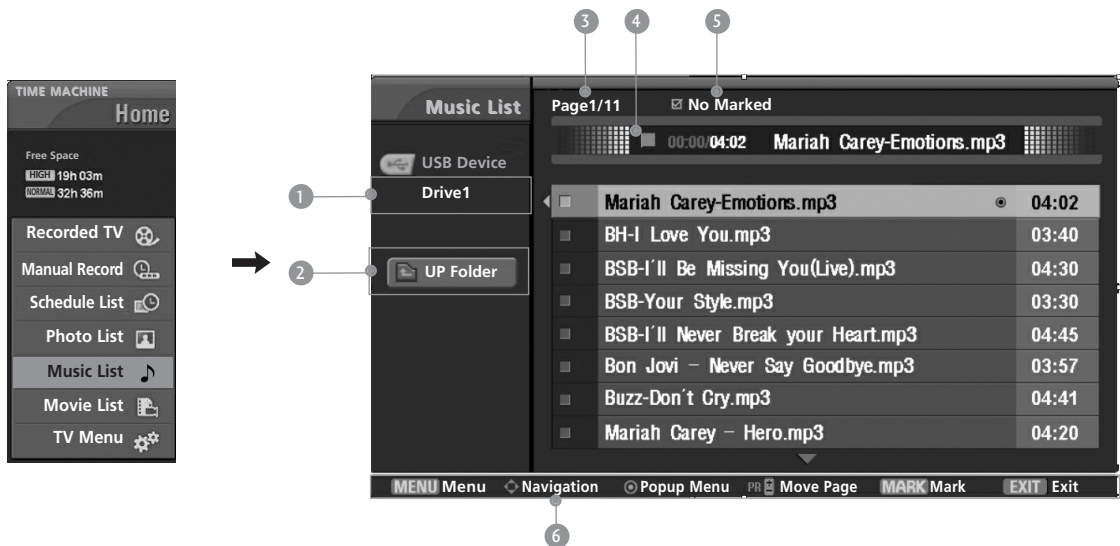

- ① Displays the selected drive
- ② Moves to upper level file
- ③ Current page/Total pages
- ④ Current playing time/Total playing time
- ⑤ Total number of marked musics
- ⑥ Corresponding buttons on the remote control

Music Selection and PopUp Menu

As shown , up to 8 music titles are listed per page.

- 1 Use ▲ / ▼ / ◀ / ▶ buttons to select the target folder or drive then press **OK** .
- 2 Use the **PR +/-** button to navigation in the music titles page.
- 3 Use **MARK** button to mark or unmark a music. When one or more music files are marked, the marked musics will be played in sequence. For example, if you want to listen to only one music repeatedly, just mark the music only and play it. If no music is marked, all the music in the folder will be played in sequence.
- 4 Use ▲ / ▼ button to navigation the appropriate musics, then press the **OK** button to show up the pop-up menu.

- ▶ **Play** (During stop) : Play the selected musics.
Once a music finishes playing, the next selected one will be played. When there are no selected musics to play, the next one in the current folder will be played. If you go to a different folder and press the **OK** button, the current music in playback will stop.
- ▶ **Play Marked** : Play the selected musics. Once a music finishes playing, the next selected one will be played automatically.
- ▶ **Stop Play** (During playback) : Stop the playing musics.
- ▶ **Play With Photo** : Start playing the selected musics and then move to the Photo List.
- ▶ **Mark All** : Mark all musics in the folder.
- ▶ **Unmark All** : Deselect all marked musics.
- ▶ **Cancel** : Close the pop-up menu.

- 5 Repeatedly, press the **EXIT** button to return to TV viewing or press the **TIME MACHINE** button to return to the **Home** menu.

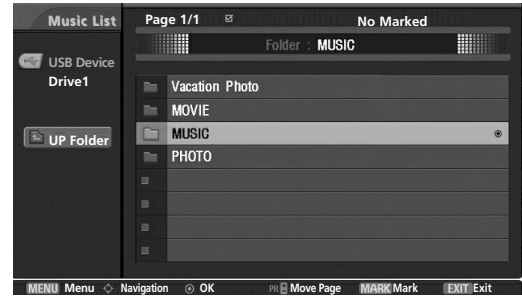

1 2

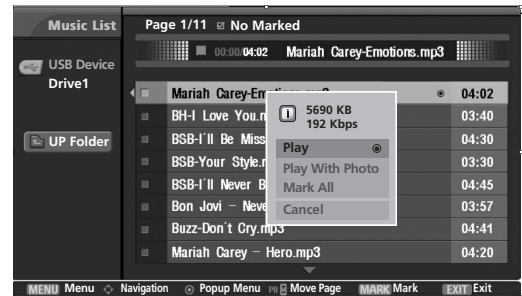



3 4

TIME MACHINE

- If you don't press any button for a while during the playing, the play information box (as shown in the below) will float as a screen saver.
- The 'Screen Saver'?
Screen saver is to prevent screen pixel damage due to an fixed image remaining on the screen for a extended period of time.



! NOTE

- ▶ When music is playing,  is displayed in front of the music title.
- ▶ A damaged or corrupted music does not play but displays 00:00 in playtime.
- ▶ A music downloaded from a paid service with copyright protection does not start but displays inappropriate information in playtime.
- ▶ If you press **OK**, , **EXIT** buttons, screen saver is stopped.
- ▶ The **PLAY(▶)**, **Pause(II)**, , **I◀◀**, **▶▶I** buttons on the remote control are also available in this mode.

MOVIE LIST

The movie list is activated once USB is detected. It is used when playing movie files on TV.

Displays the movies in the USB folder and supports Play.

Allows playback of all movies in the folder and user desired files.

Editing such as delete and add is not allowed.

It is a movie list that displays folder information and Divx file.

Supports up to four drives.

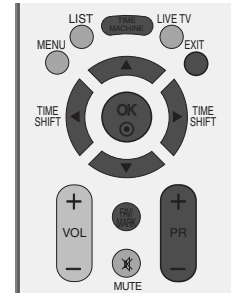

MOVIE(*.avi/*.Divx) supporting file

Video format : DivX3.xx, DivX4.xx, DivX5.xx , XVID1.1.1, XVID1.1.2, XVID1.1.3 , 3IV1, 3IV2, FVFW, DMK2, RMP4, DIV3, DIV4, DIV5, DIV6, MP43, COL1, AP41 , nAVI, DX50

Audio format : Mpeg, Mp3, PCM, Dolby D

Sampling frequency : within 8~48 khz(MP3)

Bit rate : within 8~320 kbps(MP3)

Subtitle format : *.smi/ *.srt/ *.sub(MicroDVD, SubViewer 2.0)/ *.ass/ *.ssa/*.txt(DVD Subtitle System)

- DivX may not be played depending on its types or recording methods.
- If the video and audio structure of recorded file is not interleaved, either video or audio is outputted.
- Max bitrate of playable DivX is 4 M.
- Maximum FPS (Frame Per Second) can be reached only at SD level. FPS is 25 FPS (720*576) or 30 FPS (720*480) depending on Resolution.
- Files of 25 FPS or 30 FPS of higher may not be played properly.
- If the file is recorded with GMC, the unit supports only 1 point of recorded level.
(GMC is the acronym for Global Motion Compensation, a technique used to compensate MPEG Video files.)

Screen Components

- Press the **TIME MACHINE** button and then use **▲ / ▼** button to select the **Movie List** menu.

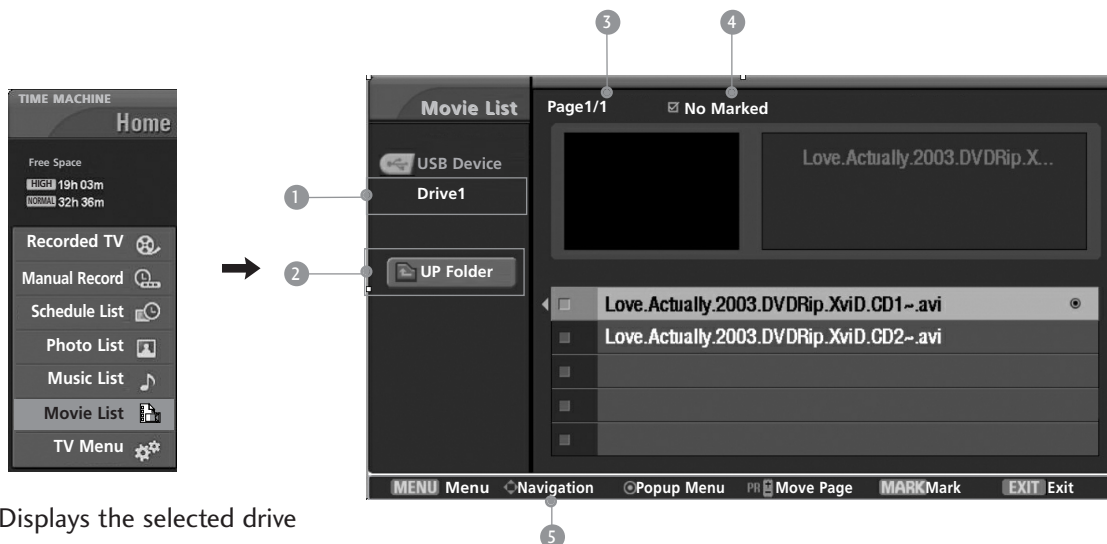

- 1 Displays the selected drive
- 2 Moves to upper level file
- 3 Current page/Total pages
- 4 Total number of marked movies
- 5 Corresponding buttons on the remote control

Movie Selection and PopUp Menu

- 1 Use ▲ / ▼ / ◀ / ▶ buttons to select the target folder or drive then press **OK**.

- 2 Use the **PR +/-** button to navigation in the movie titles page.

- 3 Use **MARK** button to mark or unmark a movie. When one or more movie files are marked, the marked movies will be played in sequence.

- 4 Use ▲ / ▼ button to navigation the appropriate movies, then press the **OK** button to show up the pop-up menu.

- ▶ **Preview**: Displays the preview video of the current file.
 - ▶ **Play**: Play the selected movie.
Divx Play is executed while screen changes.
 - ▶ **Mark All**: Mark all Movie in the folder.
 - ▶ **Unmark All**: Deselect all marked Movies.
 - ▶ **Cancel**: Close the pop-up menu.

- 5 Repeatedly, press the **EXIT** button to return to TV viewing or press the **TIME MACHINE** button to return to the **Home** menu.

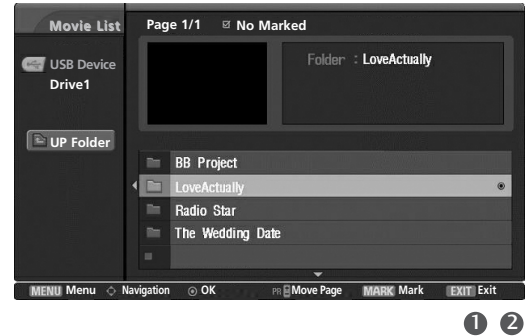

1 2

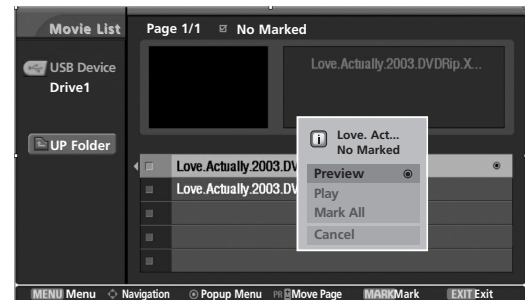

3 4

! NOTE

- ▶ In the case of files not supported, a message regarding non-supported file is displayed.

DivX Audio Language & Subtitle Language

- ▶ When DivX is playing, if you press the **DivX** button, this message is displayed.

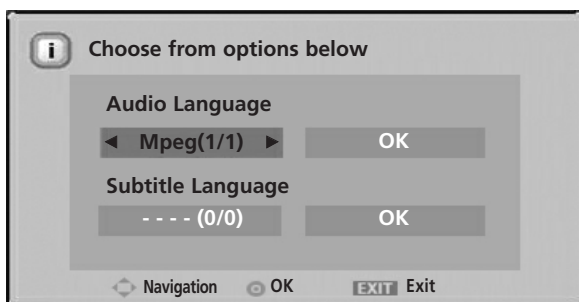

Press the ▲ / ▼ / ◀ / ▶ button to select the desired option.

Supports up to Mpeg, Mp3, PCM, Dolby D file.

SUBTITLE

Turns the subtitle control during movie play.

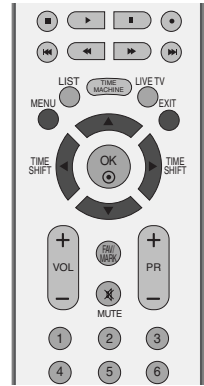

- 1 Press the **MENU** button and then use ▲ / ▼ button to select the **TIME MACHINE** menu.
- 2 Press the ► button and then use ▲ / ▼ button to select **Subtitle**.
- 3 Press the ► button to start **Subtitle**.
- 4 Press the ▲ / ▼ / ◀ / ▶ button to select the desired subtitle option.

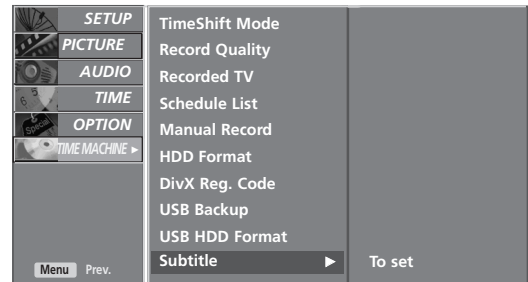

1 2 3

TIME MACHINE



- **Control** : Turns the position of the subtitle on and off during movie play.
- **Language** : Changes the Language Group of the subtitle during movie play.
- **Sync** : Adjusts the time synchronisation of the subtitle from -10 secs ~ +10 secs by steps of 1 secs during movie play.
- **Position** : Changes the position of the subtitle either up or down during movie play.

TIME MACHINE

DIVX REGISTRATION CODE

Confirm the DivX registration code number of the TV. Using the registration number, movies can be rented or purchased at www.divx.com/vod.

With a DivX registration code from other TV, playback of rented or purchased DivX file is not allowed. (Only DivX files matched with the registration code of the purchased TV are playable.)

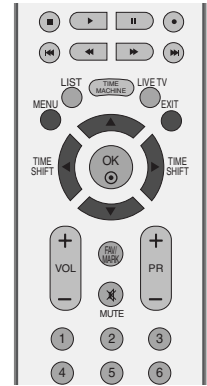

1 Press the **MENU** button and then use ▲ / ▼ button to select the **TIME MACHINE** menu.

2 Press the ► button and then use ▲ / ▼ button to select **DivX Reg. Code**.

3 Press the ► button to start **DivX Reg. Code**.

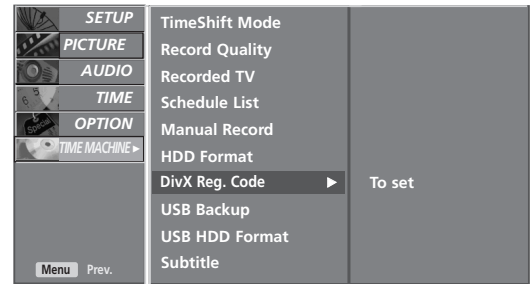
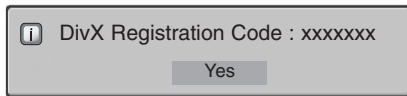

1 2 3

4 Press the **EXIT** button to return to normal TV viewing.

TIME MACHINE



- Official DivX® Certified Product
- Plays all version of DivX® video (including DivX® 6) with standard playback of DivX® media files
- “DivX, DivX Certified, and associated logos are trademarks of DivX, and are under license.”



Manufactured under license from Dolby Laboratories. “Dolby” and the double-D symbol are trademarks of Dolby Laboratories.

PICTURE CONTROL

WATCHING PIP(PICTURE-IN-PICTURE)

It's not available to use this function on recording programme.

PIP lets you view 2 different inputs (sources) on your TV screen at the same time. One source will be large, and the other source will show a smaller inset image.

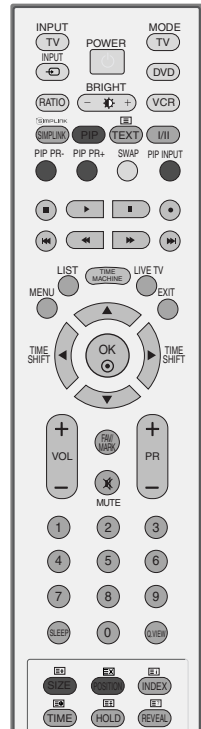

Watching PIP/Double Window

Press the **PIP** button to access the sub picture.
Each press of PIP changes the PIP options.

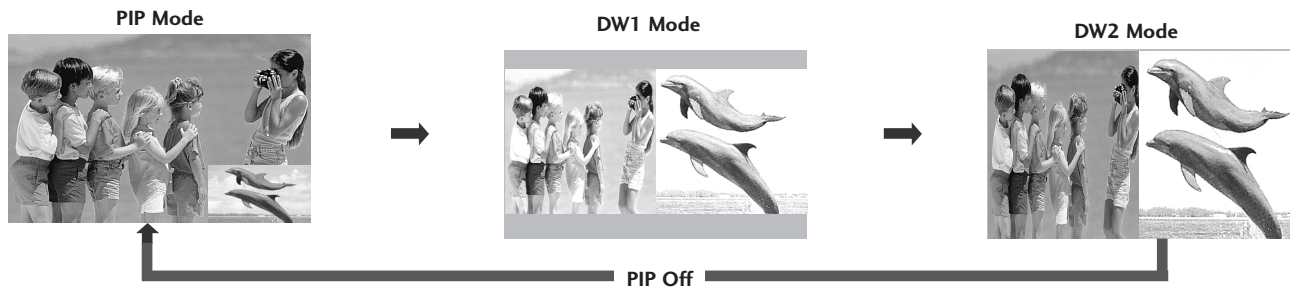

Programme Selection for Sub Picture

Press the **PIP PR +/-** button to select a programme for the sub picture.

The selected programme number is displayed just below the programme number of main picture.

PICTURE CONTROL

Input Source Selection for Sub Picture

Press the **PIP INPUT** button to select the input source for the sub picture.
Each press of **PIP INPUT** button is pressed, each input source for the sub picture is displayed.

Sub Picture Size Adjustment (PIP mode only)

Press the **SIZE** button to adjust the sub picture size.
With **SIZE** button in PIP mode, sub picture is adjusted.

Moving the Sub Picture (PIP mode only)

Press the **POSITION** button.
Repeatedly press the **POSITION** button then sub picture moves.

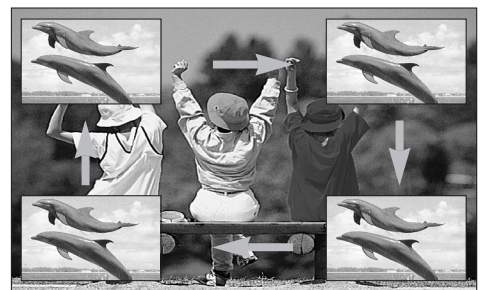

PICTURE SIZE (ASPECT RATIO)CONTROL

You can watch the screen in various picture formats; **16:9**, **Original**, **4:3**, **14:9**, **Zoom1/ 2** and **Just Scan**(47/52LB5R* only).

If a fixed image is displayed on the screen for a long time, that fixed image may become imprinted on the screen and remain visible.

You can adjust the enlarge proportion using ▲ / ▼ button.

This function works in the following signal.



- 1 Press the **RATIO** button repeatedly to select the desired picture format.
You can also adjust **Aspect Ratio** in the **PICTURE** menu.

• 16:9

The following selection will allow you to adjust the picture horizontally, in linear proportion, to fill the entire screen(useful for viewing 4:3 formatted DVDs).

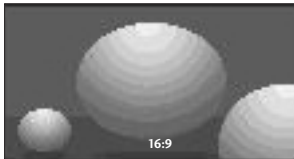

• Original

When your TV receives a wide screen signal it will automatically change to the picture format to be broadcast.

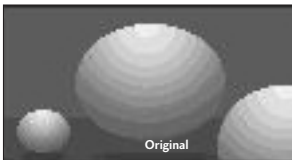

• 4:3

The following selection will allow you to view a picture with an original 4:3 aspect ration, grey bars will appear on both the left and right hand of the screen.

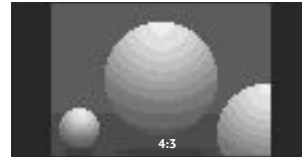

• 14:9

You can view a picture format of 14:9 or a general TV programme in the 14:9 mode. The screen 14:9 is viewed in the same way as in 4:3, but is magnified to the left and right hand side.

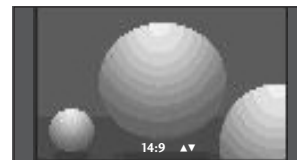

PICTURE CONTROL

- **Zoom1**

The following selection will allow you to view the picture without any alteration, while filling the entire screen. However, the top and bottom of the picture will be cropped.

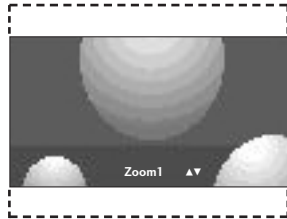

- **Zoom2**

Choose Zoom 2 when you wish the picture to be altered, both horizontally extended and vertically cropped. The picture adopting a compromise between alteration and screen coverage.

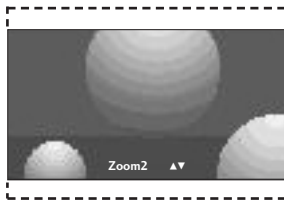

- **Just Scan(47/52LB5R* only)**

Following Selection will lead to you view the picture of best quality without loss of original picture in high resolution image.

! NOTE

- ▶ You can only select **16:9 (Wide)**, **4:3**, **Zoom 1/2** in Component, HDMI(DTV) mode.
- ▶ You can only select **16:9 (Wide)**, **4:3**, in RGB/HDMI(PC) mode only.
- ▶ You can select **4:3**, **16:9**, **Zoom1**, **Zoom2** in Recorded TV, Movie List, Play back mode only.
- ▶ In Timeshift Delay/Recording Delay function, TV displays the aspect ratio of previous input mode.
- ▶ It's available 16:9 when viewing a jpeg file in photo list.
- ▶ In HDMI(1080i, 1080p)mode, Just Scan is available.(47/52LB5R* only)

PRESET PICTURE SETTINGS

Picture Mode-Preset

Intelligent Eye Adjusts picture according to the surrounding conditions.(LCD TV models only)

Dynamic Select this option to display a sharp image.

Standard The most general and natural screen display status.

Mild Select this option to display a mild image.

User 1/2 Selection this option to use a user defined setting.

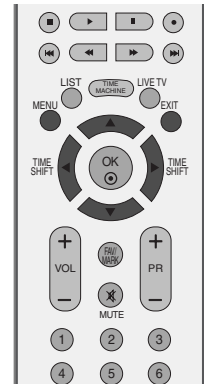

1 Press the **MENU** button and then **▲ / ▼** button to select the **PICTURE** menu.

2 Press the **▶** button and then **▲ / ▼** button to select **Picture Mode**.

3 Press the **▶** button and then **▲ / ▼** button to select **Intelligent Eye** (LCD TV models only), **Dynamic**, **Standard**, **Mild**, **User 1** or **User 2**.

4 Press the **EXIT** button to return to normal TV viewing.

- Picture Mode adjusts the TV for the best picture appearance. Select the preset value in the **Picture Mode** menu based on the programme category.
- Intelligent Eye (LCD TV models only), Dynamic, Standard and Mild are programmed for optimum picture reproduction at the factory and cannot be changed.
- When the Intelligent eye function is on, the most suitable picture is automatically adjusted according to the surrounding conditions. (LCD TV models only)

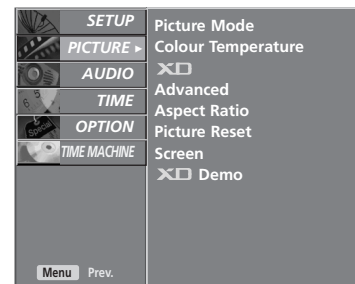

1

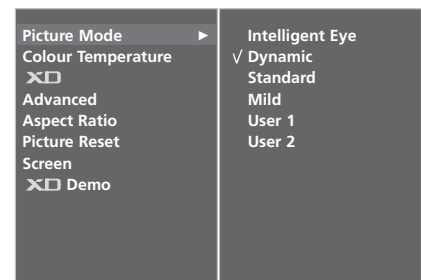

2 3

PICTURE CONTROL

Auto Colour Temperature Control(Warm/Medium/Cool)

To initialize values (reset to default settings), select the Cool option.

Choose one of three automatic colour adjustments. Set to warm to enhance hotter colours such as red, or set to cool to see less intense colours with more blue.

This menu is activated after selecting “User1” or “User2” in the Picture Mode.

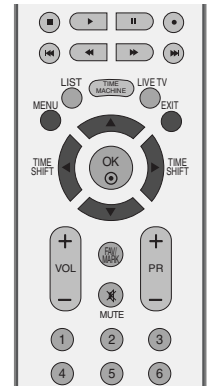

1 Press the **MENU** button and then ▲ / ▼ button to select the **PICTURE** menu.

2 Press the ► button and then ▲ / ▼ button to select **Colour Temperature**.

3 Press the ► button and then ▲ / ▼ button to select either **Cool**, **Medium**, **Warm** or **User**.

4 Press the **EXIT** button to return to normal TV viewing.

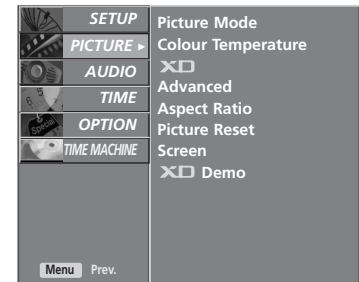

1

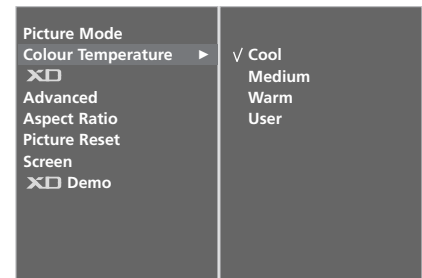

2 3

MANUAL PICTURE ADJUSTMENT

Picture Mode-User option

- Contrast** Adjusts the difference between light and dark levels in the picture.
- Brightness** Increases or decreases the amount of white in the picture.
- Colour** Adjusts intensity of all colours.
- Sharpness** Adjusts the level of crispness in the edges between the light and dark areas of the picture. The lower the level, the softer the image.
- Tint** Adjusts the balance between red and green levels.

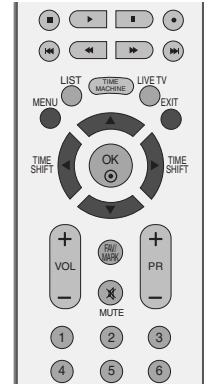

- 1 Press the **MENU** button and then **▲ / ▼** button to select the **PICTURE** menu.
- 2 Press the **▶** button and then **▲ / ▼** button to select **Picture Mode**.
- 3 Press the **▶** button and then **▲ / ▼** button to select **User 1** or **User 2**.
- 4 Press the **▶** button and then **▲ / ▼** button to select the desired picture option (**Contrast**, **Brightness**, **Colour**, **Sharpness** and **Tint**).
- 5 Press the **◀ / ▶** button to make appropriate adjustments.
- 6 Press the **EXIT** button to return to normal TV viewing.

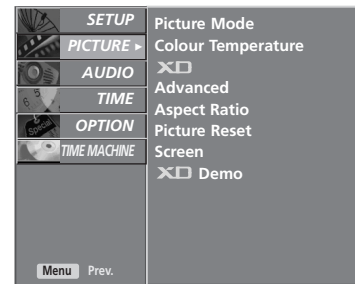

1

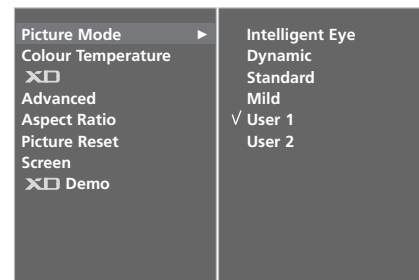

2 3



4 5

! NOTE

- ▶ You cannot adjust colour, sharpness and tint in the RGB-PC mode.

PICTURE CONTROL

Colour Temperature - User option

To adjust red, green, blue to any colour temperature you prefer.

It is possible to use this function in “User1” or “User2” of **Picture mode** only.



1 Press the **MENU** button and then **▲ / ▼** button to select the **PICTURE** menu.

2 Press the **▶** button and then **▲ / ▼** button to select **Colour Temperature**.

3 Press the **▶** button and then **▲ / ▼** button to select **User**.

4 Press the **▶** button and then **▲ / ▼** button to select **Red**, **Green** or **Blue**.

5 Press the **◀ / ▶** button to make appropriate adjustments.

6 Press the **EXIT** button to return to normal TV viewing.

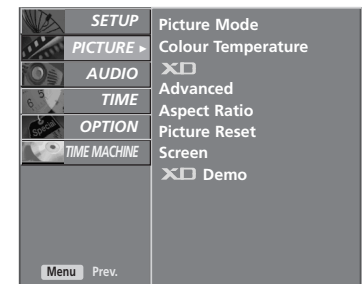

1

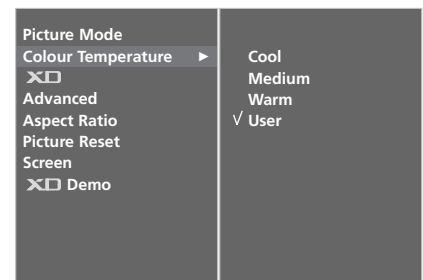

2 3

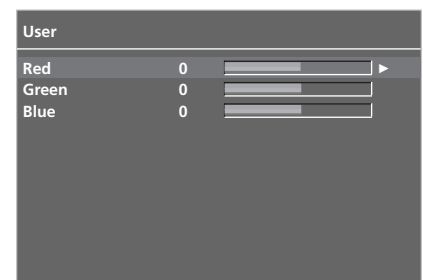

4 5

XD - PICTURE IMPROVEMENT TECHNOLOGY

XD is LG electronic's unique picture improving technology to display a real HD source through an advanced digital signal processing algorithm.

It is not possible to use this function in RGB/HDMI-PC mode.

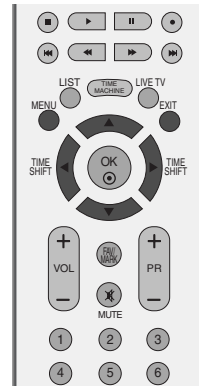

- 1 Press the MENU button and then ▲ / ▼ button to select the **PICTURE** menu.
- 2 Press the ► button and then ▲ / ▼ button to select **XD**.
- 3 Press the ► button and then ▲ / ▼ button to select **Auto** or **Manual**.
- 4 Press the EXIT button to return to TV viewing.

* Manual Selection

This menu is activated after selecting the **User1** or **User2** of **Picture Mode**.

- 1 Press the ► button and then ▲ / ▼ button to select **XD Contrast, XD Colour** or **XD NR**.
- 2 Press the ► button and then ▲ / ▼ button to select **On** or **Off**.
- 3 Press the EXIT button to return to normal TV viewing.

- **XD Contrast** : Optimises the contract automatically according to the brightness of the reflection.
- **XD Colour** : Adjusts the colour of the reflection automatically to reproduce as close as possible to natural colours.
- **XD NR** : Removes interference up to the point where it does not damage the original picture.

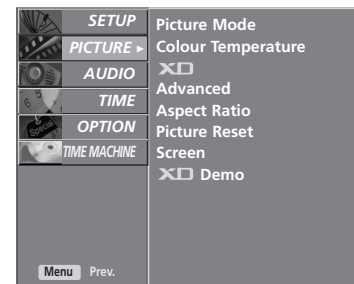

1

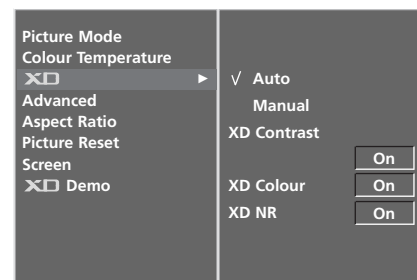

2 3

PICTURE CONTROL

XD DEMO

Use it to see the difference between XD Demo on and XD Demo off.

It is not possible to use this function in RGB/HDMI-PC mode.

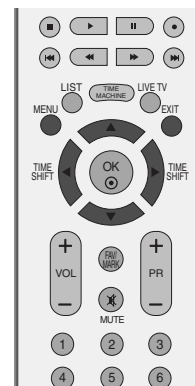

- 1 Press the MENU button and then ▲ / ▼ button to select the **PICTURE** menu.
- 2 Press the ► button and then ▲ / ▼ button to select **XD Demo**.
- 3 Press the ► button to begin **XD Demo**.
- 4 To stop **XD Demo**, press the MENU button.

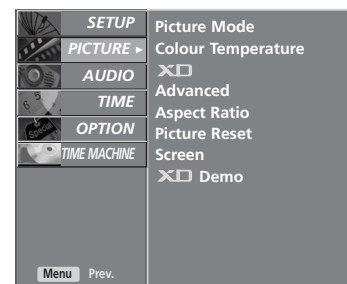

1

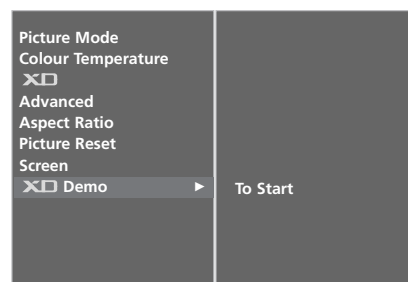

2 3

• XD Demo



ADVANCED - CINEMA

To set the TV up for the best picture quality for viewing films.

This feature operates only in Analog TV, AV and Component 480i/576i mode.

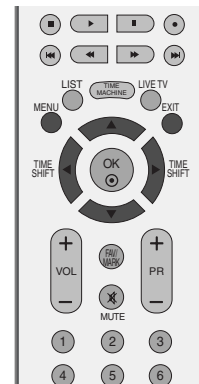

- 1 Press the **MENU** button and then **▲ / ▼** button to select the **PICTURE** menu.

- 2 Press the **▶** button and then **▲ / ▼** button to select **Advanced**.

- 3 Press the **▶** button and then **▲ / ▼** button to select **Cinema**.

- 4 Press the **▶** button and then **▲ / ▼** button to select **On** or **Off**.

- 5 Press the **EXIT** button to return to normal TV viewing.

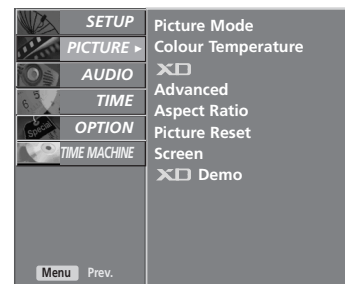

1

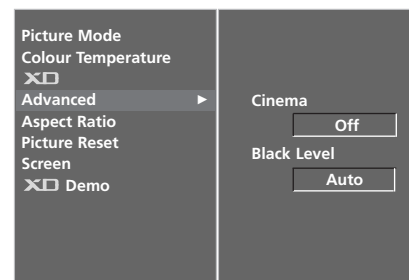

2 3

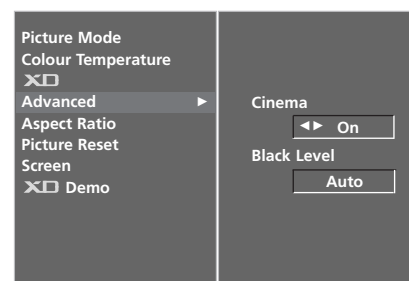

4

PICTURE CONTROL

ADVANCED - BLACK(DARKNESS) LEVEL

When you view a film this function adjust the TV to best picture quality.

This function works in the following mode: AV (NTSC-M) or HDMI.

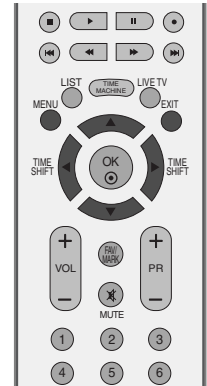

1 Press the **MENU** button and then **▲ / ▼** button to select the **PICTURE** menu.

2 Press the **▶** button and then **▲ / ▼** button to select **Advanced**.

3 Press the **▶** button and then **▲ / ▼** button to select **Black Level**.

4 Press the **▶** button and then **▲ / ▼** button to select **Low** or **High**.

- **Low** : The reflection of the screen gets darker.
- **High** : The reflection of the screen gets brighter.

5 Press the **EXIT** button to return to normal TV viewing.



1

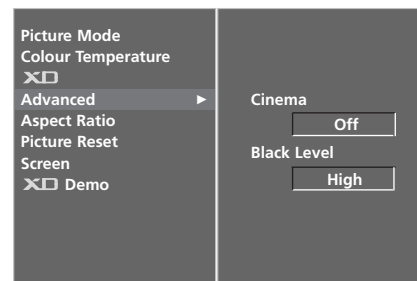

2 3

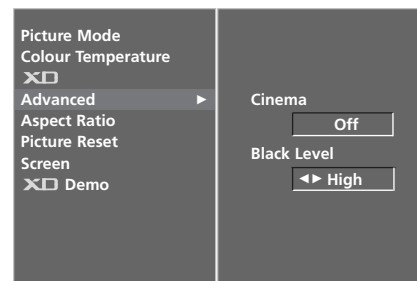

4

! NOTE

■ Auto

Realizing the black level of the screen and set it to High or Low automatically.

PICTURE RESET

Returns to the default factory setting for Picture Mode, Colour Temperature, XD, Advanced and Aspect Ratio.

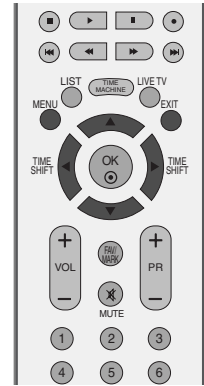

- 1 Press the **MENU** button and then **▲ / ▼** button to select the **PICTURE** menu.
- 2 Press the **▶** button and then **▲ / ▼** button to select **Picture Reset**.
- 3 Press the **▶** button to initialize the adjusted value.
- 4 Press the **EXIT** button to return to normal TV viewing.

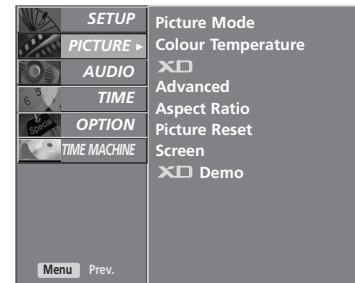

1



2 3

PICTURE CONTROL

IMAGE STICKING MINIMIZATION(ISM) METHOD

A frozen or still picture from a PC/Video game displayed on the screen for prolonged periods will result in a ghost image remaining even when you change the image. Avoid allowing a fixed image to remain on the screen for prolonged periods.

It is not possible to use this function in LCD models.

White wash

White wash removes permanent images from the screen.

Note: An excessive permanent image may be impossible to clear entirely with White Wash.

Orbiter

Orbiter may help prevent ghost images. However, it is best not to allow any fixed image to remain on the screen. To avoid a permanent image on the screen, the screen will move every 2 minutes.

Inversion

This function inverts the panel colour of the screen. The panel colour is automatically inverted every 30 minutes.

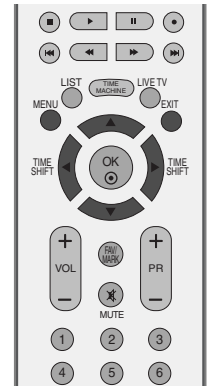

1

1 Press the **MENU** button and then **▲ / ▼** button to select the **OPTION** menu.

2 Press the **▶** button and then **▲ / ▼** button to select **ISM Method**.

3 Press the **▶** button and then **▲ / ▼** button to select either **Normal**, **White Wash**, **Orbiter** or **Inversion**. If you do not need this function, set **Normal**

4 Press the **EXIT** button to return to TV viewing.

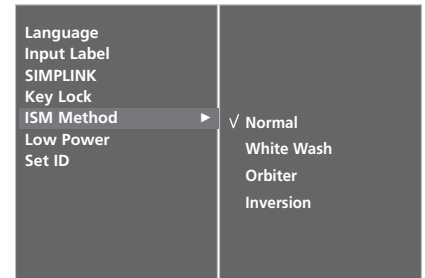

2 3

LOW-POWER PICTURE MODE

This function allows you to reduce the power consumption of the TV.

It is not possible to use this function in LCD models.

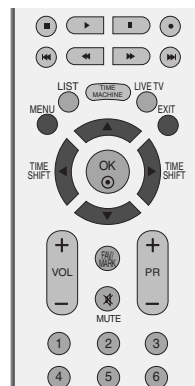

- 1 Press the **MENU** button and then ▲ / ▼ button to select the **OPTION** menu.
- 2 Press the ► button and then ▲ / ▼ button to select **Low Power**.
- 3 Press the ► button and then ▲ / ▼ button to select **On** or **Off**.
- 4 Press the **EXIT** button to return to TV viewing.



1

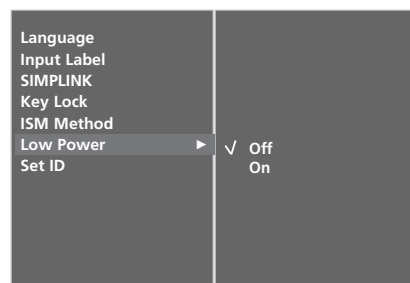

2 3

SOUND & LANGUAGE CONTROL

AUTO VOLUME LEVELER

Auto Volume automatically remains on the same level of volume if you change programmes.

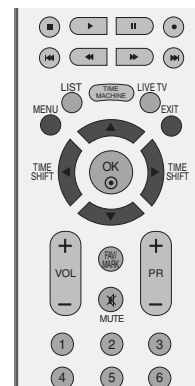

- 1 Press the **MENU** button and then ▲ / ▼ button to select the **AUDIO** menu.
- 2 Press the ► button and then ▲ / ▼ button to select **Auto Volume**.
- 3 Press the ► button and then ▲ / ▼ button to select **On** or **Off**.
- 4 Press the **EXIT** button to return to normal TV viewing.



1

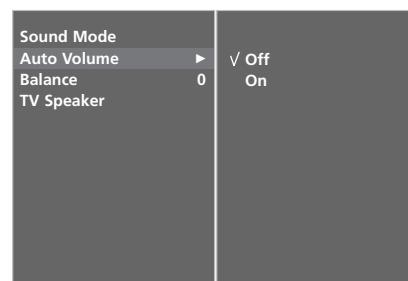

2 3

PRESET SOUND SETTINGS-SOUND MODE

You can select your preferred sound setting; SRS TSXT, Standard, Music, Movie or Sports and you can also adjust the frequency of the equalizer.

Sound Mode lets you enjoy the best sound without any Special adjustment as the TV sets the appropriate sound options based on the programme content.

SRS TSXT, Standard, Music, Movie, and Sports are preset for optimum sound quality at the factory and are not adjustable.

SRS TSXT Select this option for the most realistic sound.

Standard Commanding and natural audio.

Music Select this option to enjoy the original sound when listening to music.

Movie Select this option to enjoy sublime sound.

Sports Select this option when watching sports broadcasting.

User Select this option for user-defined audio settings.

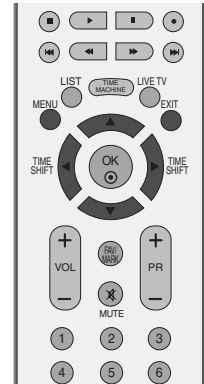

1

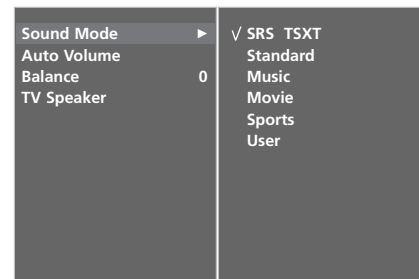

2 3

1 Press the **MENU** button and then **▲ / ▼** button to select the **AUDIO** menu.

2 Press the **▶** button and then **▲ / ▼** button to select **Sound Mode**.

3 Press the **▶** button and then **▲ / ▼** button to select **SRS TSXT, Standard, Music, Movie, Sports** or **User**.

4 Press the **EXIT** button to return to normal TV viewing.

▶ **SRS** is a trademark of SRS Labs, Inc.
 ▶ TruSurround XT technology is incorporated under license from SRS Labs, Inc.

SOUND & LANGUAGE CONTROL

SOUND SETTING ADJUSTMENT -USER MODE

Adjusting the audio equalizer.

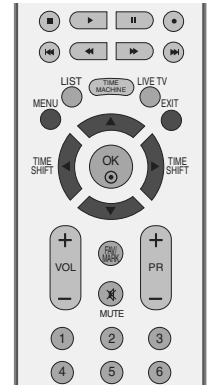

1 Press the **MENU** button and then ▲ / ▼ button to select the **AUDIO** menu.

2 Press the ► button and then ▲ / ▼ button to select **Sound Mode**.

3 Press the ► button and then ▲ / ▼ button to select **User**.

4 Press the ► button.

5 Select a frequency band by pressing the ◀ / ▶ button. Set the desired sound level with the ▲ / ▼ button.

6 Press the **EXIT** button to return to normal TV viewing.



1

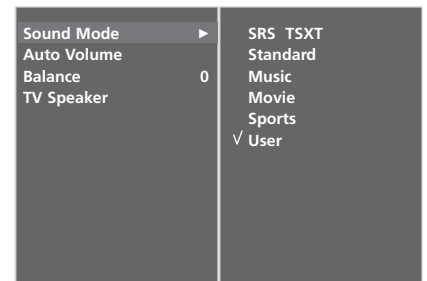

2 3 4

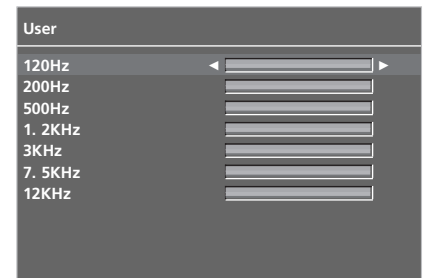

5

BALANCE

You can adjust the sound balance of the speakers to the preferred levels.

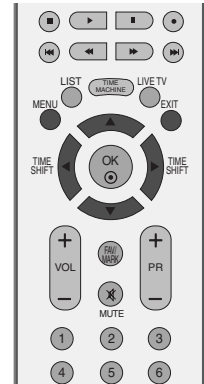

1 Press the **MENU** button and then **▲ / ▼** button to select the **AUDIO** menu.

2 Press the **▶** button and then **▲ / ▼** button to select **Balance**.

3 Press the **▶** button and then **◀ / ▶** button to make desired adjustment.

4 Press the **EXIT** button to return to normal TV viewing.

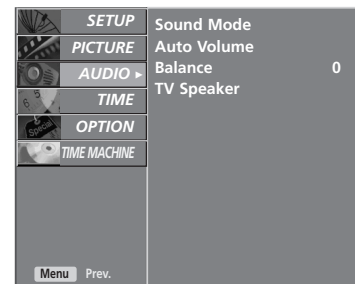

1

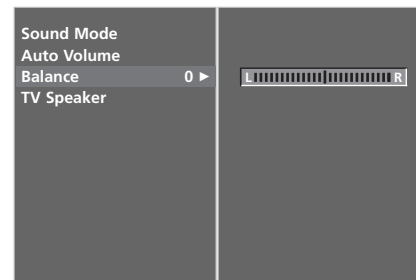

2 3

SOUND & LANGUAGE CONTROL

TV SPEAKER ON/OFF SETUP

You can adjust the internal speaker status.

In AV, COMPONENT, RGB and HDMI mode, internal speaker audio can be operational even when there is no video signal.

If you want to use your external hi-fi stereo system, turn off the internal speakers of the TV.



1 Press the **MENU** button and then ▲ / ▼ button to select the **AUDIO** menu.

2 Press the ► button and then ▲ / ▼ button to select **TV Speaker**.

3 Press the ► button and then ▲ / ▼ button to select **On** or **Off**.

4 Press the **EXIT** button to return to normal TV viewing.

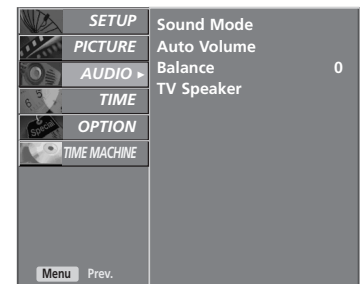

1

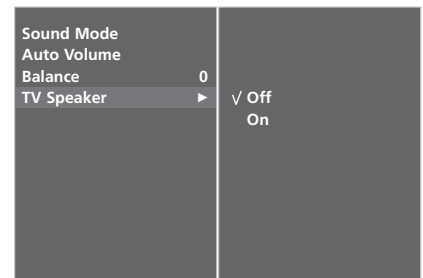

2 3

I/II

Stereo/Dual Reception

When a programme is selected, the sound information for the station appears after the programme number and station name disappear.

Broadcast	On Screen Display
Mono	MONO
Stereo	STEREO
Dual	DUAL I

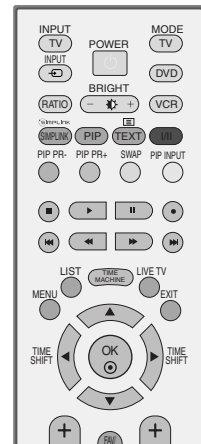

■ Mono sound selection

If the stereo signal is weak in stereo reception, you can switch to mono by pressing the I/II button twice. In mono reception, the clarity of sound is improved. To switch back to stereo, press the I/II button twice.

■ Language selection for dual language broadcast

If a programme can be received in two languages (dual language), you can switch to **DUAL I**, **DUAL II** or **DUAL I+II** by pressing the I/II button repeatedly.

- DUAL I** Sends the primary broadcast language to the loudspeakers.
- DUAL II** Sends the secondary broadcast language to the loudspeakers.
- DUAL I+II** Sends a separate language to each loudspeaker.

SOUND & LANGUAGE CONTROL

NICAM Reception

If the TV is equipped with a receiver for NICAM reception, high quality NICAM (Near Instantaneous Companding Audio Multiplex) digital sound can be received.

Sound output can be selected according to the type of broadcast received as by pressing the I/II button repeatedly.

-
- 1 When **NICAM mono** is received, you can select **NICAM MONO** or **FM MONO**.
 - 2 When **NICAM stereo** is received, you can select **NICAM STEREO** or **FM MONO**.
If the stereo signal is weak, switch to **FM MONO**.
 - 3 When **NICAM dual** is received, you can select **NICAM DUAL I**, **NICAM DUAL II** or **NICAM DUAL I+II** or **MONO**.
-

Speaker Sound Output Selection

In AV, Component, RGB and HDMI mode, you can select output sound for the left and right loudspeakers.

Repeatedly press the I/II button to select the sound output.

L+R: Audio signal from audio L input is sent to the left loudspeaker and audio signal from audio R input is sent to the right loudspeaker.

L+L: Audio signal from audio L input is sent to left and right loudspeakers.

R+R: Audio signal from audio R input is sent to left and right loudspeakers.

ON-SCREEN MENU LANGUAGE SELECTION

The menus can be shown on the screen in the selected language. First select your language.

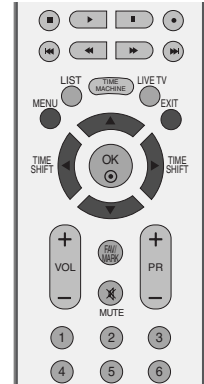

1 Press the **MENU** button and then use ▲ / ▼ button to select the **OPTION** menu.

2 Press the ► button and then use ▲ / ▼ button to select **Language**.

3 Press the ► button and then use ▲ / ▼ button to select your desired language.

4 Press the **OK** button.

5 Press the **EXIT** button to return to normal TV viewing.



TIME SETTING

CLOCK SETUP

You must set the time correctly before using on/off timer function.

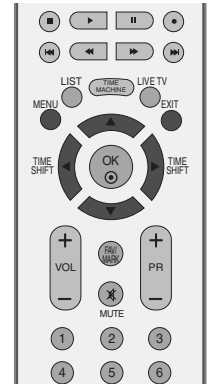

- 1 Press the **MENU** button and then ▲ / ▼ button to select the **TIME** menu.
- 2 Press the ► button and then ▲ / ▼ button to select **Clock**.
- 3 Press the ► button and then ◀ / ▶ button to select either the year, date, or time option.
- 4 Once selected, use the ▲ / ▼ button to set the year, date, and time options.
- 5 Press the **EXIT** button to return to normal TV viewing.

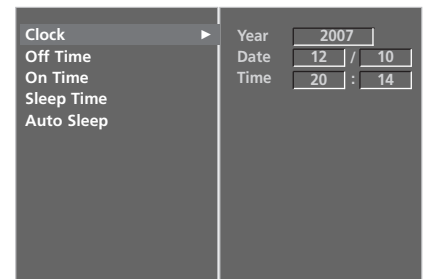

AUTO ON/OFF TIMER SETTING

The Off time function automatically switches the TV to standby at a preset time.

Two hours after the TV is switched on by the on time function it will automatically switch back to standby mode unless a button has been pressed.

Once the on time/off time is set, these functions operate daily at the preset time.

The Off time function overrides the On timer function if both are set to the same time.

The TV must be in standby mode for the On Timer to work.



1 Press the **MENU** button and then **▲ / ▼** button to select the **TIME** menu.

2 Press the **▶** button and then **▲ / ▼** button to select **On/Off Time**.

3 Press the **▶** button and then **▲ / ▼** button to select **On**.
 • To cancel **On/Off Time** function, select **Off**.

4 Press the **▶** button and then **▲ / ▼** button to set the hour.

5 Press the **▶** button and then **▲ / ▼** button to set the minutes.

6 **For On Time function only**
 • **Programme:** Press the **▶** button and then **▲ / ▼** button to select the programme.
 • **Volume:** Press the **▶** button and then **▲ / ▼** button to adjust volume level at switch-on.

7 Press the **EXIT** button to return to normal TV viewing.



1

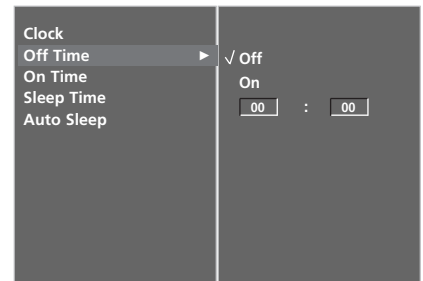

2 3

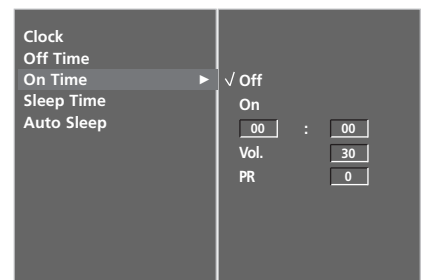

4 5 6

TIME SETTING

SLEEP TIMER SETTING

You do not have to remember to switch the TV off before you go to sleep. The sleep timer automatically switches the TV to standby after the preset time has elapsed.

- 1 Press the **SLEEP** button repeatedly to select the number of minutes. The display '  - - -Min ' will appear on the screen, followed by 10, 20, 30, 60, 90, 120, 180 and 240.
- 2 When the number of minutes required is displayed on the screen, the timer begins to count down from the number of minutes selected.

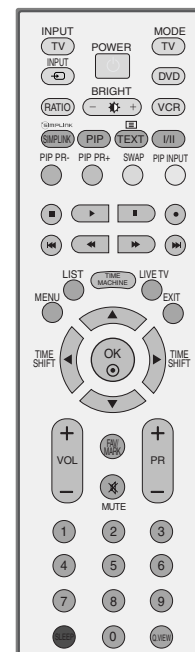

■ You can also set up the Sleep Time in the **TIME** menu.

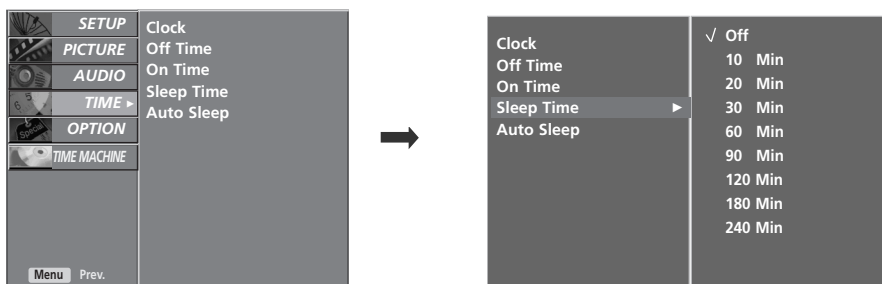

! NOTE

- ▶ To view the remaining sleep time, press the **SLEEP** button once.
- ▶ To cancel the sleep time, repeatedly press the **SLEEP** button until the display '  - - -Min ' appears.
- ▶ When you switch the TV off, the TV releases the preset sleep time.

AUTO SHUT-OFF SETTING

If the TV set is switched on and there is no input signal, it will switch off automatically after 10 minutes.

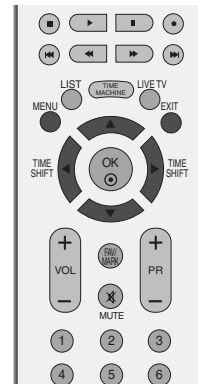

1 Press the **MENU** button and then ▲ / ▼ button to select the **TIME** menu.

2 Press the ► button and then ▲ / ▼ button to select **Auto Sleep**.

3 Press the ► button and then ▲ / ▼ button to select **On** or **Off**.

4 Press the **EXIT** button to return to normal TV viewing.



1



2 3

TELETEXT

This feature is not available in all countries.

Teletext is a free service broadcast by most TV stations which gives up-to-the-minute information on news, weather, television programmes, share prices and many other topics.

The teletext decoder of this TV can support the SIMPLE, TOP and FASTEXT systems. SIMPLE (standard teletext) consists of a number of pages which are selected by directly entering the corresponding page number. TOP and FASTEXT are more modern methods allowing quick and easy selection of teletext information.

SWITCH ON/OFF

Press the **TEXT** button to switch to teletext. The initial page or last page viewed appears on the screen.

Two page numbers, TV station name, date and time are displayed on the screen headline. The first page number indicates your selection, while the second shows the current page displayed.

Press the **TEXT** or **EXIT** button to switch off teletext. The previous mode reappears.

SIMPLE TEXT

■ Page selection

- 1 Enter the desired page number as a three digit number with the **NUMBER** buttons. If during selection you press a wrong number, you must complete the three digit number and then re-enter the correct page number.
- 2 The **PR +/-** button can be used to select the preceding or following page.

TOP TEXT

The user guide displays four fields-red, green, yellow and blue at the bottom of the screen. The yellow field denotes the next group and the blue field indicates the next block.

■ Block / group / page selection

- ① With the blue button you can progress from block to block.
- ② Use the yellow button to proceed to the next group with automatic overflow to the next block.
- ③ With the green button you can proceed to the next existing page with automatic overflow to the next group. Alternatively the **PR +** button can be used.
- ④ The red button return to the previous selection. Alternatively the **PR -** button can be used.

■ Direct page selection

As with SIMPLE teletext mode, you can select a page by entering it as a three digit number using the NUMBER buttons in TOP mode.

FASTEXT

The teletext pages are colour coded along the bottom of the screen and are selected by pressing the corresponding coloured button.

■ Page selection

- ① Press the  button to select the index page.
- ② You can select the pages which are colour coded along the bottom line with corresponding coloured buttons.
- ③ Corresponding to the SIMPLE teletext mode, you can select a page by entering its three digit page number with the NUMBER buttons in FASTEXT mode.
- ④ The **PR +/-** button can be used to select the preceding or following page.

SPECIAL TELETEXT FUNCTIONS



■ REVEAL

Press this button to display concealed information, such as solutions to riddles or puzzles.
Press this button again to remove the information from the display.



■ SIZE

Selects double height text.
Press this button to enlarge the top half of the page.
Press this button again to enlarge the bottom half of the page.
Press this button again to return to the normal display.



■ UPDATE

Displays the TV picture on the screen while waiting for a new teletext page. The display will appear at the top left hand corner of the screen. When the updated page is available then display will change to the page number. Press this button again to view the updated teletext page.



■ TIME

When viewing a TV programme, press this button to display the time at the top right hand corner of the screen. Press this button again to remove the display. In the teletext mode, press this button to select a sub page number. The sub page number is displayed at the bottom of the screen. To hold or change the sub page, press the RED/GREEN, **PR +/-** or **NUMBER** buttons.
Press again to exit this function.



■ HOLD

Stops the automatic page change which will occur if a teletext page consists of 2 or more sub pages. The number of sub pages and the sub page displayed is, usually, shown on the screen below the time. When this button is pressed the stop symbol is displayed at the top left-hand corner of the screen and the automatic page change is inhibited. To continue press this button again.

APPENDIX

TROUBLESHOOTING

The TV set does not operate properly	
The remote control does not work	<ul style="list-style-type: none">■ Check to see if there is any object between the product and the remote control causing obstruction.■ Are batteries installed with correct polarity (+ to +, - to -)?■ Correct remote operating mode set: TV, VCR etc.?■ Install new batteries.
Power is suddenly turned off	<ul style="list-style-type: none">■ Is the sleep timer set?■ Check the power control settings. Has the Power supply been interrupted.■ Is Auto sleep activated on this station.

The video function does not work.	
No picture & No sound	<ul style="list-style-type: none">■ Check whether the TV set is switched on.■ Try another channel. The problem may be with the broadcast.■ Is the power cord inserted correctly into the mains?■ Check your antenna direction and/or location.■ Test the mains outlet by plugging another product into the same outlet.
Picture appears slowly after switching on	<ul style="list-style-type: none">■ This is normal, the image is muted during the product startup process. Please contact your service center, if the picture has not appeared after five minutes.
No or poor colour or poor picture	<ul style="list-style-type: none">■ Adjust Colour in menu option.■ Allow a sufficient distance between the product and the VCR.■ Try another channel. The problem may be with the broadcast.■ Are the video cables installed properly?■ Activate any function to restore the brightness of the picture.
Horizontal/vertical bars or picture shaking	<ul style="list-style-type: none">■ Check for local interference such as an electrical appliance or power tool.
Poor reception on some channels	<ul style="list-style-type: none">■ Station or cable product experiencing problems, tune to another station.■ Station signal is weak, reposition the antenna to receive weaker stations.■ Check for sources of possible interference.
Lines or streaks in pictures	<ul style="list-style-type: none">■ Check antenna (Change the position of the antenna).

APPENDIX

The audio function does not work.

Picture OK & No sound	<ul style="list-style-type: none">■ Press the VOL(or Volume) button.■ Sound muted? Press MUTE button.■ Try another channel. The problem may be with the broadcast.■ Are the audio cables installed properly?
No output from one of the speakers	<ul style="list-style-type: none">■ Adjust Balance in menu option.
Unusual sound from inside the product	<ul style="list-style-type: none">■ A change in ambient humidity or temperature may result in an unusual noise when the product is switched on or off and does not indicate a fault with the product.

There is a problem in PC mode. (Only PC mode applied)

The signal is out of range.	<ul style="list-style-type: none">■ Adjust resolution, horizontal frequency, or vertical frequency.■ Check the input source.
Vertical bar or stripe on background & Horizontal Noise & Incorrect position	<ul style="list-style-type: none">■ Use Auto configure or adjust clock, phase, or H/V position.
Screen colour is unstable or single colour	<ul style="list-style-type: none">■ Check the signal cable.■ Reinstall the PC video card.

MAINTENANCE

Early malfunctions can be prevented. Careful and regular cleaning can prolong the life of your new TV.
Caution: Be sure to switch the power off and unplug the power cord before you begin any cleaning.

Cleaning the Screen

- 1 A good way to keep the dust off your screen for a while is to wet a soft cloth in a mixture of lukewarm water and a little fabric softener or dish washing detergent. Wring the cloth until it's almost dry, and then use it to wipe the screen.
- 2 Ensure there is no excess water on the screen. Allow any water or dampness to evaporate before switching on.

Cleaning the Cabinet

- To remove dirt or dust, wipe the cabinet with a soft, dry, lint-free cloth.
- Do not to use a wet cloth.

Extended Absence

CAUTION

- ▶ If you expect to leave your TV dormant for prolonged periods (such as a holiday), unplug the power cord to protect against possible damage from lightning or power surges.

APPENDIX

PRODUCT SPECIFICATIONS

MODELS		32LB5R*	37LB5R*	42LB5R*
		32LB5RT-TB	37LB5RT-TB	42LB5RT-TB
Dimensions (Width x Height x Depth)	with stand	806.6 x 607.5 x 249.0 mm 31.8 x 23.9 x 9.8 inches	927 x 693 x 281 mm 36.5 x 27.3 x 11.1 inches	1033.4 x 750.0 x 287.6 mm 40.7 x 29.5 x 11.3 inches
	without stand	806.6 x 552.3 x 97.2 mm 31.8 x 21.7 x 3.8 inches	927 x 630 x 88 mm 36.5 x 24.8 x 3.5 inches	1033.4 x 686.8 x 88.5 mm 40.7 x 27.0 x 3.5 inches
Weight	with stand	15.3 kg / 33.7 lbs	21 kg / 46.3 lbs	25.4 kg / 56.0 lbs
	without stand	12.5 kg / 27.6 lbs	17 kg / 37.5 lbs	20.9 kg / 46.1 lbs
Power requirement		AC100-240V~ 50/60Hz 1.5A	AC100-240V~ 50/60Hz 2.0A	AC100-240V~ 50/60Hz 2.5A
MODELS		47LB5R*	52LB5R*	
		47LB5RE-TB	52LB5RE-TB	
Dimensions (Width x Height x Depth)	with stand	1144.5 x 825.6 x 306.4 mm 45.1 x 32.5 x 12.1 inches	1284.6 x 901.8 x 356.9 mm 50.6 x 35.5 x 14.1 inches	
	without stand	1144.5 x 754.9 x 103 mm 31.8 x 29.7 x 4.1 inches	1284.6 x 831.6 x 111.5 mm 50.6 x 32.7 x 4.4 inches	
Weight	with stand	33.4 kg / 73.6 lbs	49.6 kg / 109.3 lbs	
	without stand	27.3 kg / 60.19 lbs	41.5 kg / 91.4 lbs	
Power requirement		AC100-240V~ 50/60Hz 3.2A	AC100-240V~ 50/60Hz 3.7A	
Television System		PAL/SECAM B/G/D/K, PAL I/II, NTSC-M		
Program Coverage		VHF: E2~E12, UHF: E21 ~ E69, CATV: S1 ~ S20, HYPER: S21 ~ S47		
External Antenna Impedance		75 Ω		
Environment condition	Operating Temperature	0 ~ 40°C / 32 ~ 104°F		
	Operating Humidity	Less than 80%		
	Storage Temperature	-20 ~ 60°C / -4 ~ 140°F		
	Storage Humidity	Less than 85%		

- The specifications shown above may be changed without prior notice for quality improvement.

MODELS		42PB4R*	50PB4R*
		42PB4RT-TB/42PB4RTH-TB	50PB4RT-TB/50PB4RTH-TB
Dimensions (Width x Height x Depth)	with stand	1130.0 x 768.1 x 310.4 mm 44.5 x 30.2 x 12.2 inches	1308.0 x 906.1 x 370.0mm 51.5 x 35.7 x 14.6 inches
	without stand	1130.0 x 715.0 x 85.0 mm 44.5 x 28.1 x 3.3 inches	1308.0x 845 x 89.5 mm 51.5 x 33.2 x 3.5 inches
Weight	with stand	31.05kg / 68.5 lbs	42.72kg / 94.2 lbs
	without stand	2705kg / 59.6lbs	38.02kg / 83.8lbs
Power requirement		AC100-240V~ 50/60Hz 3.5A	AC100-240V~ 50/60Hz 4.5A
Television System		PAL/SECAM B/G/D/K, PAL I/II, NTSC-M	
Program Coverage		VHF: E2~E12, UHF: E21 ~ E69, CATV: S1 ~ S20, HYPER: S21 ~ S47	
External Antenna Impedance		75 Ω	
Environment condition	Operating Temperature	0 ~ 40°C / 32 ~ 104°F	
	Operating Humidity	Less than 80%	
	Storage Temperature	-20 ~ 60°C / -4 ~ 140°F	
	Storage Humidity	Less than 85%	

■ The specifications shown above may be changed without prior notice for quality improvement.

PROGRAMMING THE REMOTE CONTROL

The remote control is a multi brand or universal remote. It can be programmed. to operate most remote controlled devices from other manufacturers.

Note that the remote control may not control all models from other brands.

Programming a code into a remote mode

- 1 Testing your remote control.
To find out whether your remote control can operate other components without programming, turn on a component such as a VCR and press the corresponding mode button (such as a **DVD** or **VCR**) on the remote control, while pointing at the component.
Test the **POWER** and **PR + / -** buttons to see if the component responds correctly.
If the component does not operate correctly, the remote control requires programming to operate the device.
- 2 Switch on the component to be programmed, then press the corresponding mode button (such as **DVD** or **VCR**) on the remote control.
The remote control button of the desired device is illuminated.
- 3 Press the **MENU** and **MUTE** buttons simultaneously, the remote control is ready to be programmed with the code.
- 4 Enter a code number using the number buttons on the remote control. Programming code numbers for the corresponding component can be found on the following pages. If the code is correct, the device will turn off.
- 5 Press the **MENU** button to store the code.
- 6 Test the remote control functions to see if the component responds correctly.
If not, repeat from step 2.

DVD

Brand	Codes	Brand	Codes	Brand	Codes
APEX DIGITAL	022	mitsubishi	002	RCA	005 006
DENON	020 014	NAD	023	SAMSUNG	011 015
GE	005 006	ONKYO	008 017	SONY	007
HARMAN KARDON	027	PANASONIC	003 009	THOMPSON	005 006
JVC	012	PHILIPS	013	TOSHIBA	019 008
LG	001 010 016 025	PIONEER	004 026	YAMAHA	009 018
MAGNAVOX	013	PROCEED	021	ZENITH	010 016 025
MARANTZ	024	PROSCAN	005 006		

VCR

Brand	Codes	Brand	Codes	Brand	Codes
AIWA	034	MAGNAVOX	031 033 034 041	SAMSUNG	032 040 102 104
AKAI	016 043 046 124 125 146		067 068		105 107 109 112
AMPRO	072	MARANTZ	012 031 033 067 069		113 115 120 122 125
ANAM	031 033 103	MARTA	101	SANSUI	022 043 048 135
AUDIO DYNAMICS	012 023 039 043	MATSUI	027 030	SANYO	003 007 010 014
BROKSONIC	035 037 129	MEI	031 033		102 134
CANON	028 031 033	MEMOREX	003 010 014 031 033 034 053 072 101 102 134 139	SCOTT	017 037 112 129 131
CAPEHART	108			SEARS	003 008 009 010 013 014 017 020 031 042 073 081 101
CRAIG	003 040 135	MGA	045 046 059	SHARP	031 054 149
CURTIS MATHES	031 033 041	MINOLTA	013 020	SHINTOM	024
DAEWOO	005 007 010 064 065 108 110 111 112 116 117 119	MITSUBISHI	013 020 045 046 049 051 059 061 151	SONY	003 009 031 052 056 057 058 076 077 078 149
DAYTRON	108	MTC	034 040	SOUNDESIGN	034
DBX	012 023 039 043	MULTITECH	024 034	STS	013
DYNATECH	034 053	NEC	012 023 039 043 048	SYLVANIA	031 033 034 059 067
ELECTROHOME	059	NORDMENDE	043	SYMPHONIC	034
EMERSON	006 017 025 027 029 031 034 035 036 037 046 101 129 131 138 153	OPTONICA	053 054	TANDY	010 034
FISHER	003 008 009 010	PANASONIC	066 070 074 083 133 140 145	TATUNG	039 043
FUNAI	034			TEAC	034 039 043
GE	031 033 063 072 107 109 144 147	PENTAX	013 020 031 033 063	TECHNICS	031 033 070
GO VIDEO	132 136	PHILCO	031 034 067	TEKNIKA	019 031 033 034 101
HARMAN KARDON	012 045	PHILIPS	031 033 034 054 067 071 101	THOMAS	034
HITACHI	004 018 026 034 043 063 137 150	PILOT	101	TMK	006
INSTANTREPLAY	031 033	PIONEER	013 021 048	TOSHIBA	008 013 042 047 059 082 112 131
JCL	031 033	PORTLAND	108	TOTEVISION	040 101
JCPENNY	012 013 015 033 040 066 101	PULSAR	072	UNITECH	040
JENSEN	043	QUARTZ	011 014	VECTOR RESEARCH	012
JVC	012 031 033 043 048 050 055 060 130 150 152	QUASAR	033 066 075 145	VICTOR	048
KENWOOD	014 034 039 043 047 048	RCA	013 020 033 034 040 041 062 063 107 109 140 144 145 147	VIDEO CONCEPTS	012 034 046
LG (GOLDSTAR)	001 012 013 020 101 106 114 123	REALISTIC	003 008 010 014 031 033 034 040 053 054 101	VIDEOSONIC	040
LLOYD	034			WARDS	003 013 017 024 031 033 034 040 053 054 131
LXI	003 009 013 014 017 034 101 106	RICO	058	YAMAHA	012 034 039 043
MAGIN	040	RUNCO	148	ZENITH	034 048 056 058 072 080 101
		SALORA	014		

IR CODES

1. How to Connect

- Connect your wired remote control to the Remote Control port on the TV.

2. Remote Control IR Codes

■ Output waveform

Single pulse, modulated with 37.917KHz signal at 455KHz

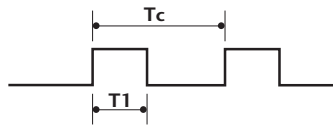

Carrier frequency
 $FCAR = 1/TC = fOSC/12$
 Duty ratio = $T1/TC = 1/3$

■ Configuration of frame

1st frame

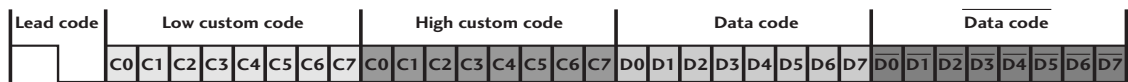

Repeat frame

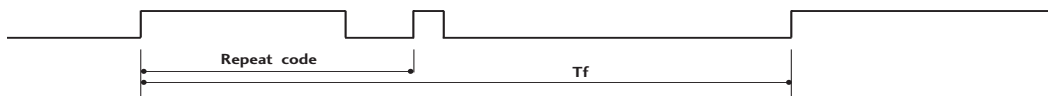

■ Lead code

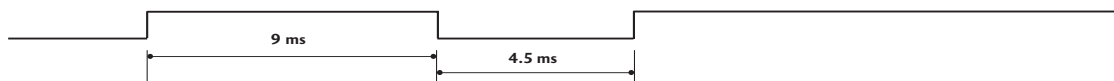

■ Repeat code

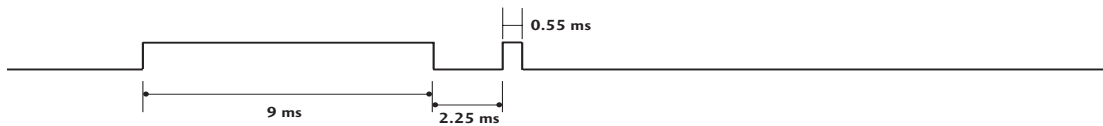

■ Bit description



■ Frame interval: Tf

The waveform is transmitted as long as a key is depressed.

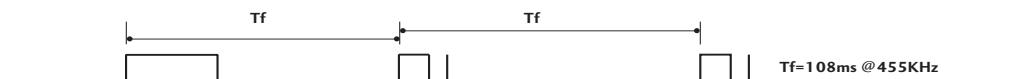

Code (Hexa)	Function	Note
0F	TV	R/C BUTTON
08	POWER	R/C BUTTON(POWER ON/OFF)
0B	INPUT	R/C BUTTON
79	RATIO	R/C BUTTON
E0	BRIGHTNESS +	R/C BUTTON
E1	BRIGHTNESS -	R/C BUTTON
7E	SIMPLINK	R/C BUTTON
60	PIP	R/C BUTTON
20	TEXT	R/C BUTTON
0A	I/II	R/C BUTTON
72	PIP PR-(RED)	R/C BUTTON
71	PIP PR+(GREEN)	R/C BUTTON
63	SWAP(YELLOW)	R/C BUTTON
61	PIP INPUT(CYAN)	R/C BUTTON
B1	TIME MACHINE STOP(■)	R/C BUTTON
B0	TIME MACHINE PLAY(▶)	R/C BUTTON
BA	TIME MACHINE PAUSE(II)	R/C BUTTON
BD	TIME MACHINE REC(●)	R/C BUTTON
B2	I◀◀	R/C BUTTON
8F	◀◀	R/C BUTTON
8E	▶▶	R/C BUTTON
B3	▶▶I	R/C BUTTON
43	MENU	R/C BUTTON
53	LIST	R/C BUTTON
C8	TIME MACHINE	R/C BUTTON
9E	LIVE TV	R/C BUTTON
5B	EXIT	R/C BUTTON
40	UP(▲)	R/C BUTTON
41	DOWN(▼)	R/C BUTTON
07	LEFT(◀)	R/C BUTTON
06	RIGHT(▶)	R/C BUTTON
44	OK(●)	R/C BUTTON
02	VOL +	R/C BUTTON
03	VOL -	R/C BUTTON
00	PR +	R/C BUTTON
01	PR -	R/C BUTTON
1E	FAV/MARK	R/C BUTTON
09	MUTE	R/C BUTTON
11	Number Key 1	R/C BUTTON
12	Number Key 2	R/C BUTTON
13	Number Key 3	R/C BUTTON
14	Number Key 4	R/C BUTTON
15	Number Key 5	R/C BUTTON
16	Number Key 6	R/C BUTTON
17	Number Key 7	R/C BUTTON
18	Number Key 8	R/C BUTTON
19	Number Key 9	R/C BUTTON
10	Number Key 0	R/C BUTTON
0E	SLEEP	R/C BUTTON
1A	Q.VIEW	R/C BUTTON
64	SIZE	R/C BUTTON
62	POSITION	R/C BUTTON
70	INDEX	R/C BUTTON
26	TIME	R/C BUTTON
65	HOLD	R/C BUTTON
2A	REVEAL	R/C BUTTON
91	DivX	R/C BUTTON

APPENDIX

EXTERNAL CONTROL DEVICE SETUP

It's not available to use this function in TIME MACHINE mode.

Connect the RS-232C input jack to an external control device (such as a computer or an A/V control system) and control the TV's functions externally.

Connect the serial port of the control device to the RS-232C jack on the TV back panel.

RS-232C connection cables are not supplied with the TV.

RS-232C Setup

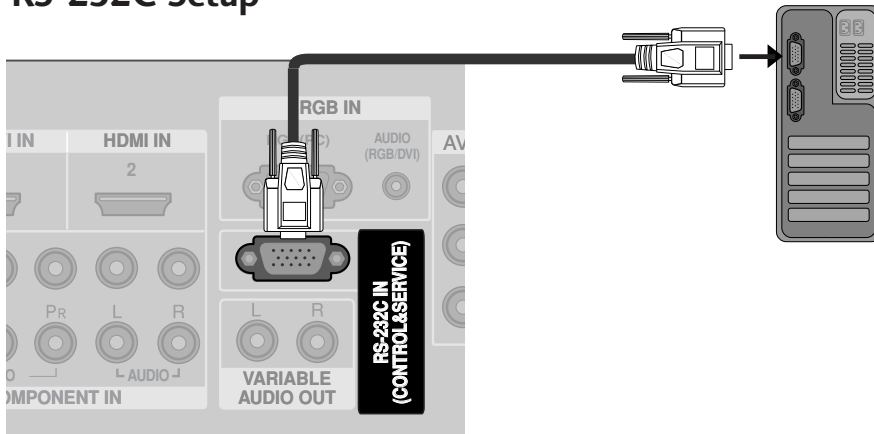

Type of Connector; D-Sub 9-Pin Male

No.	Pin Name
1	No connection
2	RXD (Receive data)
3	TXD (Transmit data)
4	DTR (DTE side ready)
5	GND
6	DSR (DCE side ready)
7	RTS (Ready to send)
8	CTS (Clear to send)
9	No Connection

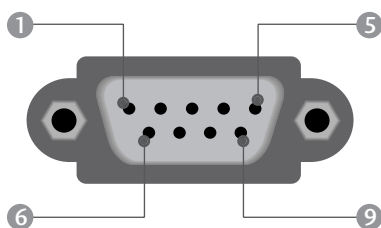

RS-232C Configurations

Please make sure the RS-232C configuration below.

If you use different kind of RS-232C cable, system error may occur.

3-Wire Configurations			
	PC	TV	
RXD	2	3	TXD
TXD	3	2	RXD
GND	5	5	GND
DTR	4	6	DTR
DSR	6	4	DSR
RTS	7	7	RTS
CTS	8	8	CTS
	D-Sub 9	D-Sub 9	

Set ID

Use this function to specify a set ID number.

Refer to 'Real Data Mapping' 1. See page p.121

1 Press the **MENU** button and then use ▲ / ▼ button to select the **OPTION** menu.

2 Press the ► button and then use ▲ / ▼ button to select **Set ID**.

3 Press the ► button and then use ◀ / ▶ button to adjust **Set ID** to choose the desired TV ID number.

- The adjustment range of SET ID is 1~99.

4 Press **EXIT** button to return to normal TV viewing.

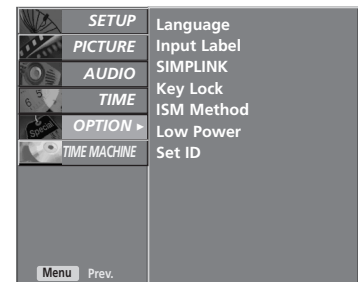

1

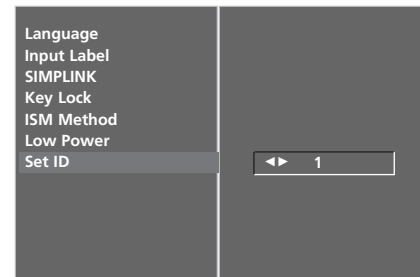

2 3

APPENDIX

Communication Parameters

- Baud rate : 9600 bps (UART)
- Data length : 8 bits
- Parity : None
- Stop bit : 1 bit
- Communication code : ASCII code
- Use a crossed (reverse) cable.

Command Reference List

	COMMAND 1	COMMAND 2	DATA (Hexadecimal)
01. Power	k	a	0 ~ 1
02. Aspect Ratio	k	c	*
03. Screen Mute	k	d	0 ~ 1
04. Volume Mute	k	e	0 ~ 1
05. Volume Control	k	f	0 ~ 64
06. Contrast	k	g	0 ~ 64
07. Brightness	k	h	0 ~ 64
08. Colour	k	i	0 ~ 64
09. Tint	k	j	0 ~ 64
10. Sharpness	k	k	0 ~ 64
11. OSD Select	k	l	0 ~ 01
12. Remote control lock mode	k	m	0 ~ 01
13. PIP/DW	k	n	*
14. PIP Position	k	q	0 ~ 03
15. Balance	k	t	0 ~ 64
16. Colour Temperature	k	u	0 ~ 3
17. Red Adjustment	k	v	0 ~ 3C (or 50)
18. Green Adjustment	k	w	0 ~ 3C (or 50)
19. Blue Adjustment	k	\$	0 ~ 3C (or 50)
20. Tune Command	m	a	Refer to p. 121
21. Abnormal Status	k	z	FF
22. ISM Method	j	p	0 ~ 3
23. Low Power	j	q	0 ~ 1
24. Auto Configure	j	u	1
25. Key	m	c	Key Code
26. Input select (Main)	x	b	*
27. Input select (PIP)	x	y	*

Transmission / Receiving Protocol

Transmission

[Command1][Command2][][Set ID][][Data][Cr]

- * [Command 1] : First command to control the TV.
(j, k, m or x)
- * [Command 2] : Second command to control the TV.
- * [Set ID] : You can adjust the set ID to choose desired monitor ID number in option menu.
Adjustment range is 1 ~ 99.
When selecting Set ID '0', every connected set is controlled.
Set ID is indicated as decimal (1~99) on menu and as Hexa decimal (0x0~0x63) on transmission/receiving protocol.
- * [DATA] : To transmit command data.
Transmit 'FF' data to read status of command.
- * [Cr] : Carriage Return
ASCII code '0x0D'
- * [] : ASCII code 'space (0x20)'

OK Acknowledgement

[Command2][][Set ID][][OK][Data][x]

- * The TV transmits ACK (acknowledgement) based on this format when receiving normal data. At this time, if the data is data read mode, it indicates present status data. If the data is data write mode, it returns the data of the PC computer.

Error Acknowledgement

[Command2][][Set ID][][NG][Data][x]

- * The TV transmits ACK (acknowledgement) based on this format when receiving abnormal data from non-viable functions or communication errors.

- Data 1: Illegal Code
2: not support function
3: Wait more time

APPENDIX

10. Sharpness (Command 2 : k)

- ▶ To adjust the screen sharpness.
You can also adjust sharpness in the PICTURE menu.

Transmission

[k][k][][Set ID][][Data][Cr]

Data Min : 0 ~ Max : 64
* Refer to 'Real data mapping 1'. See page 121.

Ack

[k][][Set ID][][OK][Data][x]

11. OSD Select (Command 2 : l)

- ▶ To select OSD (On Screen Display) on/off when controlling remotely.

Transmission

[k][l][][Set ID][][Data][Cr]

Data 0 : OSD off 1 : OSD on

Ack

[l][][Set ID][][OK][Data][x]

12. Remote control lock mode (Command 2 : m)

- ▶ To lock the front panel controls on the monitor and remote control.

Transmission

[k][m][][Set ID][][Data][Cr]

Data 0 : Lock off 1 : Lock on

Ack

[m][][Set ID][][OK][Data][x]

- * If you are not using the remote control, use this mode.
When main power is on/off, external control lock is released.

13. PIP / DW (Command2:n)

- ▶ To control the PIP (Picture In picture)/DW.
You can also control the PIP/DW using the PIP button on the remote control or in the PIP/DW menu.

Transmission

[k][n][][Set ID][][Data][Cr]

Data 0 : PIP/DW off 2: DW1
1 : PIP 3: DW2

Ack

[n][][Set ID][][OK][Data][x]

14. PIP Position (Command2:q)

- ▶ To select sub picture position for PIP.
You can also adjust the sub picture position using POSITION button on the remote control or in the PIP/DW menu.

Transmission

[k][q][][Set ID][][Data][Cr]

Data 0: Right down on screen
Data 1: Left down on screen
Data 2: Left up on screen
Data 3: Right up on screen

Ack

[q][][Set ID][][OK][Data][x]

15. Balance (Command 2 : t)

- ▶ To adjust balance.
You can also adjust balance in the AUDIO menu.

Transmission

[k][t][][Set ID][][Data][Cr]

Data Min : 0 ~ Max : 64
* Refer to 'Real data mapping 1'. See page 121.

Ack

[t][][Set ID][][OK][Data][x]

16. Colour Temperature (Command 2 : u)

- ▶ To adjust colour temperature. You can also adjust Colour Temperature in the PICTURE menu.

Transmission

[k][u][][Set ID][][Data][Cr]

Data 0: Cool 1: Medium 2: Warm 3: User

Ack

[u][][Set ID][][OK][Data][x]

17. Red Adjustment (Command 2 : v)

- ▶ To adjust red in colour temperature.

Transmission

[k][v][][Set ID][][Data][Cr]

Data Min : 0 ~ Max : 50
* Refer to 'Real data mapping 2'. See page 121.

Ack

[v][][Set ID][][OK][Data][x]

18. Green Adjustment (Command 2 : w)

- ▶ To adjust green in colour temperature.

Transmission

[k][w][][Set ID][][Data][Cr]

Data Min : 0 ~ Max : 50
* Refer to 'Real data mapping 2'. See page 121.

Ack

[w][][Set ID][][OK][Data][x]

19. Blue Adjustment (Command 2 : \$)

- ▶ To adjust blue in colour temperature.

Transmission

[k][\$][][Set ID][][Data][Cr]

Data Min : 0 ~ Max : 50

* Refer to 'Real data mapping 2'. See page 121.

Ack

[\$][][Set ID][][OK][Data][x]

20. Tune Command/Channel Tuning (Command 1:m, Command 2:a)

- ▶ To select a programme for the main picture.

Transmission

[m][a][][Set ID][][Data0][][Data1][][Data2][Cr]

Data 0: Min: 0 ~ Max: 63 (0~C7, 200 Pr is on)

Refer to 'Real data mapping 1'.

1: Do not care

2: 0 : Main

1 : Sub

Ack

[\$][][Set ID][][OK][Data][x]

21. Abnormal State (Command 2 : z)

- ▶ To recognize an abnormal state.
This feature is not available for all models.

Transmission

[k][z][][Set ID][][FF][][Cr]

Data FF : Read

Ack

[z][][Set ID][][OK][Data][x]

Data 0: Normal (Power on and signal exist)

1: No signal (Power on)

2: Turn the TV off by remote control

3: Turn the TV off by sleep time function

4: Turn the TV off by RS-232C function

5: 5V down

6: AC down

7: Turn the TV off by Fan Alarm function

8: Turn the TV off by Off time function

9: Turn the TV off by Auto sleep function

a: Turn the TV off by AV board detect

* This function is "read only".

22. ISM Method (Command 1 : j, Command 2 : p)

- ▶ To control the ISM method. You can also adjust ISM Method in OPTION menu.
It is not possible to sue this function with LCD TV models.

Transmission

[j][p][][Set ID][][Data][Cr]

Data 0: Normal

1: White wash

2: Orbiter

3: Inversion

Ack

[p][][Set ID][][OK/NG][Data][x]

23. Low Power (Command 1 : j, Command 2 : q)

- ▶ To reduce the power consumption of the TV. You can also adjust Low Power in OPTION menu.
It is not possible to sue this function with LCD TV models..

Transmission

[j][q][][Set ID][][Data][][Cr]

Data 0 : Off

1 : On

Ack

[q][][Set ID][][OK/NG][Data][x]

24. Auto Configure (Command 1 : j, Command 2 : u)

- ▶ To adjust picture position and minimize image shaking automatically. It works only in RGB (PC) mode.

Transmission

[j][u][][Set ID][][Data][Cr]

Data 1: To set

Ack

[u][][Set ID][][OK/NG][Data][x]

* Real data mapping 1

0 : Step 0
⋮
A : Step 10 (Set ID 10)
⋮
F : Step 15 (Set ID 15)
10 : Step 16 (Set ID 16)
⋮
64 : Step 100
⋮
6E : Step 110
⋮
73 : Step 115
74 : Step 116
⋮
C7 : Step 199
⋮
FE : Step 254
FF : Step 255

* Real data mapping 2

0 : -40
1 : -39
2 : -38
⋮
28 : 0
⋮
4E : +38
4F : +39
50 : +40

APPENDIX

25. Key (Command1:m, Command2:c)

► To send IR remote key code.

Transmission

[m][c][][Set ID][][Data][Cr]

Data Key code - Refer to page 115.

Ack

[c][][Set ID][][OK][Data][x]

26. Input select (Command1:x, Command2:b) (Main Picture Input)

► To select input source for TV.

Transmission

[x][b][][Set ID][][Data][Cr]

Data Structure

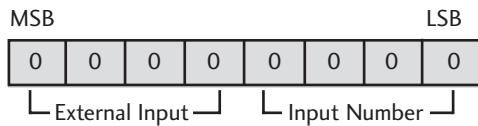

External Input				Data
0	0	0	1	Analog
0	0	1	0	AV
0	1	0	0	Component
0	1	1	0	RGB-PC
1	0	0	1	HDMI

Input Number				Data
0	0	0	0	Input1
0	0	0	1	Input2
0	0	1	0	Input3
0	0	1	1	Input4

Ack

[b][][Set ID][][OK][Data][x]

27. PIP Input select (Command1:x, Command2:y)

► To adjust input source for sub picture in PIP mode

Transmission

[x][y][][Set ID][][Data][Cr]

Data Structure

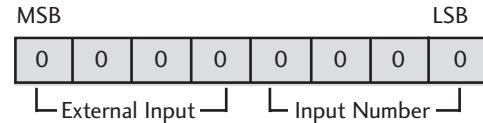

External Input				Data
0	0	0	1	Analog
0	0	1	0	AV
0	1	0	0	Component
0	1	1	0	RGB-PC
1	0	0	1	HDMI

Input Number				Data
0	0	0	0	Input1
0	0	0	1	Input2
0	0	1	0	Input3
0	0	1	1	Input4

Ack

[y][][Set ID][][OK][Data][x]

LG Electronics Inc.